

# Renesas e<sup>2</sup> studio 2022-07 or higher

## User's Manual: Quick Start Guide

Renesas MCU  
RA Family

All information contained in these materials, including products and product specifications, represents information on the product at the time of publication and is subject to change by Renesas Electronics Corp. without notice. Please review the latest information published by Renesas Electronics Corp. through various means, including the Renesas Electronics Corp. website (<http://www.renesas.com>).

## Notice

1. Descriptions of circuits, software and other related information in this document are provided only to illustrate the operation of semiconductor products and application examples. You are fully responsible for the incorporation or any other use of the circuits, software, and information in the design of your product or system. Renesas Electronics disclaims any and all liability for any losses and damages incurred by you or third parties arising from the use of these circuits, software, or information.
2. Renesas Electronics hereby expressly disclaims any warranties against and liability for infringement or any other claims involving patents, copyrights, or other intellectual property rights of third parties, by or arising from the use of Renesas Electronics products or technical information described in this document, including but not limited to, the product data, drawings, charts, programs, algorithms, and application examples.
3. No license, express, implied or otherwise, is granted hereby under any patents, copyrights or other intellectual property rights of Renesas Electronics or others.
4. You shall be responsible for determining what licenses are required from any third parties, and obtaining such licenses for the lawful import, export, manufacture, sales, utilization, distribution or other disposal of any products incorporating Renesas Electronics products, if required.
5. You shall not alter, modify, copy, or reverse engineer any Renesas Electronics product, whether in whole or in part. Renesas Electronics disclaims any and all liability for any losses or damages incurred by you or third parties arising from such alteration, modification, copying or reverse engineering.
6. Renesas Electronics products are classified according to the following two quality grades: "Standard" and "High Quality". The intended applications for each Renesas Electronics product depends on the product's quality grade, as indicated below.  
"Standard": Computers; office equipment; communications equipment; test and measurement equipment; audio and visual equipment; home electronic appliances; machine tools; personal electronic equipment; industrial robots; etc.  
"High Quality": Transportation equipment (automobiles, trains, ships, etc.); traffic control (traffic lights); large-scale communication equipment; key financial terminal systems; safety control equipment; etc.  
Unless expressly designated as a high reliability product or a product for harsh environments in a Renesas Electronics data sheet or other Renesas Electronics document, Renesas Electronics products are not intended or authorized for use in products or systems that may pose a direct threat to human life or bodily injury (artificial life support devices or systems; surgical implantations; etc.), or may cause serious property damage (space system; undersea repeaters; nuclear power control systems; aircraft control systems; key plant systems; military equipment; etc.). Renesas Electronics disclaims any and all liability for any damages or losses incurred by you or any third parties arising from the use of any Renesas Electronics product that is inconsistent with any Renesas Electronics data sheet, user's manual or other Renesas Electronics document.
7. No semiconductor product is absolutely secure. Notwithstanding any security measures or features that may be implemented in Renesas Electronics hardware or software products, Renesas Electronics shall have absolutely no liability arising out of any vulnerability or security breach, including but not limited to any unauthorized access to or use of a Renesas Electronics product or a system that uses a Renesas Electronics product. RENESAS ELECTRONICS DOES NOT WARRANT OR GUARANTEE THAT RENESAS ELECTRONICS PRODUCTS, OR ANY SYSTEMS CREATED USING RENESAS ELECTRONICS PRODUCTS WILL BE INVULNERABLE OR FREE FROM CORRUPTION, ATTACK, VIRUSES, INTERFERENCE, HACKING, DATA LOSS OR THEFT, OR OTHER SECURITY INTRUSION ("Vulnerability Issues"). RENESAS ELECTRONICS DISCLAIMS ANY AND ALL RESPONSIBILITY OR LIABILITY ARISING FROM OR RELATED TO ANY VULNERABILITY ISSUES. FURTHERMORE, TO THE EXTENT PERMITTED BY APPLICABLE LAW, RENESAS ELECTRONICS DISCLAIMS ANY AND ALL WARRANTIES, EXPRESS OR IMPLIED, WITH RESPECT TO THIS DOCUMENT AND ANY RELATED OR ACCOMPANYING SOFTWARE OR HARDWARE, INCLUDING BUT NOT LIMITED TO THE IMPLIED WARRANTIES OF MERCHANTABILITY, OR FITNESS FOR A PARTICULAR PURPOSE.
8. When using Renesas Electronics products, refer to the latest product information (data sheets, user's manuals, application notes, "General Notes for Handling and Using Semiconductor Devices" in the reliability handbook, etc.), and ensure that usage conditions are within the ranges specified by Renesas Electronics with respect to maximum ratings, operating power supply voltage range, heat dissipation characteristics, installation, etc. Renesas Electronics disclaims any and all liability for any malfunctions, failure or accident arising out of the use of Renesas Electronics products outside of such specified ranges.
9. Although Renesas Electronics endeavors to improve the quality and reliability of Renesas Electronics products, semiconductor products have specific characteristics, such as the occurrence of failure at a certain rate and malfunctions under certain use conditions. Unless designated as a high reliability product or a product for harsh environments in a Renesas Electronics data sheet or other Renesas Electronics document, Renesas Electronics products are not subject to radiation resistance design. You are responsible for implementing safety measures to guard against the possibility of bodily injury, injury or damage caused by fire, and/or danger to the public in the event of a failure or malfunction of Renesas Electronics products, such as safety design for hardware and software, including but not limited to redundancy, fire control and malfunction prevention, appropriate treatment for aging degradation or any other appropriate measures. Because the evaluation of microcomputer software alone is very difficult and impractical, you are responsible for evaluating the safety of the final products or systems manufactured by you.
10. Please contact a Renesas Electronics sales office for details as to environmental matters such as the environmental compatibility of each Renesas Electronics product. You are responsible for carefully and sufficiently investigating applicable laws and regulations that regulate the inclusion or use of controlled substances, including without limitation, the EU RoHS Directive, and using Renesas Electronics products in compliance with all these applicable laws and regulations. Renesas Electronics disclaims any and all liability for damages or losses occurring as a result of your noncompliance with applicable laws and regulations.
11. Renesas Electronics products and technologies shall not be used for or incorporated into any products or systems whose manufacture, use, or sale is prohibited under any applicable domestic or foreign laws or regulations. You shall comply with any applicable export control laws and regulations promulgated and administered by the governments of any countries asserting jurisdiction over the parties or transactions.
12. It is the responsibility of the buyer or distributor of Renesas Electronics products, or any other party who distributes, disposes of, or otherwise sells or transfers the product to a third party, to notify such third party in advance of the contents and conditions set forth in this document.
13. This document shall not be reprinted, reproduced or duplicated in any form, in whole or in part, without prior written consent of Renesas Electronics.
14. Please contact a Renesas Electronics sales office if you have any questions regarding the information contained in this document or Renesas Electronics products.

(Note1) "Renesas Electronics" as used in this document means Renesas Electronics Corporation and also includes its directly or indirectly controlled subsidiaries.

(Note2) "Renesas Electronics product(s)" means any product developed or manufactured by or for Renesas Electronics.

(Rev.5.0-1 October 2020)

## Corporate Headquarters

TOYOSU FORESIA, 3-2-24 Toyosu,  
Koto-ku, Tokyo 135-0061, Japan  
[www.renesas.com](http://www.renesas.com)

## Contact information

For further information on a product, technology, the most up-to-date version of a document, or your nearest sales office, please visit:  
[www.renesas.com/contact/](http://www.renesas.com/contact/).

## Trademarks

Renesas and the Renesas logo are trademarks of Renesas Electronics Corporation. All trademarks and registered trademarks are the property of their respective owners.

## General Precautions in the Handling of Microprocessing Unit and Microcontroller Unit Products

The following usage notes are applicable to all Microprocessing unit and Microcontroller unit products from Renesas. For detailed usage notes on the products covered by this document, refer to the relevant sections of the document as well as any technical updates that have been issued for the products.

- 1. Precaution against Electrostatic Discharge (ESD)**

A strong electrical field, when exposed to a CMOS device, can cause destruction of the gate oxide and ultimately degrade the device operation. Steps must be taken to stop the generation of static electricity as much as possible, and quickly dissipate it when it occurs. Environmental control must be adequate. When it is dry, a humidifier should be used. This is recommended to avoid using insulators that can easily build up static electricity. Semiconductor devices must be stored and transported in an anti-static container, static shielding bag or conductive material. All test and measurement tools including work benches and floors must be grounded. The operator must also be grounded using a wrist strap. Semiconductor devices must not be touched with bare hands. Similar precautions must be taken for printed circuit boards with mounted semiconductor devices.
- 2. Processing at power-on**

The state of the product is undefined at the time when power is supplied. The states of internal circuits in the LSI are indeterminate and the states of register settings and pins are undefined at the time when power is supplied. In a finished product where the reset signal is applied to the external reset pin, the states of pins are not guaranteed from the time when power is supplied until the reset process is completed. In a similar way, the states of pins in a product that is reset by an on-chip power-on reset function are not guaranteed from the time when power is supplied until the power reaches the level at which resetting is specified.
- 3. Input of signal during power-off state**

Do not input signals or an I/O pull-up power supply while the device is powered off. The current injection that results from input of such a signal or I/O pull-up power supply may cause malfunction and the abnormal current that passes in the device at this time may cause degradation of internal elements. Follow the guideline for input signal during power-off state as described in your product documentation.
- 4. Handling of unused pins**

Handle unused pins in accordance with the directions given under handling of unused pins in the manual. The input pins of CMOS products are generally in the high-impedance state. In operation with an unused pin in the open-circuit state, extra electromagnetic noise is induced in the vicinity of the LSI, an associated shoot-through current flows internally, and malfunctions occur due to the false recognition of the pin state as an input signal become possible.
- 5. Clock signals**

After applying a reset, only release the reset line after the operating clock signal becomes stable. When switching the clock signal during program execution, wait until the target clock signal is stabilized. When the clock signal is generated with an external resonator or from an external oscillator during a reset, ensure that the reset line is only released after full stabilization of the clock signal. Additionally, when switching to a clock signal produced with an external resonator or by an external oscillator while program execution is in progress, wait until the target clock signal is stable.
- 6. Voltage application waveform at input pin**

Waveform distortion due to input noise or a reflected wave may cause malfunction. If the input of the CMOS device stays in the area between VIL (Max.) and VIH (Min.) due to noise, for example, the device may malfunction. Take care to prevent chattering noise from entering the device when the input level is fixed, and also in the transition period when the input level passes through the area between VIL (Max.) and VIH (Min.).
- 7. Prohibition of access to reserved addresses**

Access to reserved addresses is prohibited. The reserved addresses are provided for possible future expansion of functions. Do not access these addresses as the correct operation of the LSI is not guaranteed.
- 8. Differences between products**

Before changing from one product to another, for example to a product with a different part number, confirm that the change will not lead to problems. The characteristics of a microprocessing unit or microcontroller unit products in the same group but having a different part number might differ in terms of internal memory capacity, layout pattern, and other factors, which can affect the ranges of electrical characteristics, such as characteristic values, operating margins, immunity to noise, and amount of radiated noise. When changing to a product with a different part number, implement a system- evaluation test for the given product.

# Table of Contents

1.	Overview.....	1
1.1	System Configuration.....	2
1.2	System Requirements.....	3
1.2.1	Hardware Environment: .....	3
1.2.2	Operating Environment: .....	3
1.3	Supported Toolchains .....	3
1.4	Supported Emulator Devices .....	3
1.5	Outline of RA Project Development .....	3
1.6	Supported FSP Version .....	3
2.	Installation.....	3
2.1	Installing the FSP with e <sup>2</sup> studio Installer .....	4
2.2	Installing e <sup>2</sup> studio and FSP Independently .....	9
2.2.1	Installing e <sup>2</sup> studio .....	9
2.2.2	Setting Up the GNU Arm Embedded Toolchain.....	13
2.2.3	Installing the Renesas RA Flexible Software Package (FSP) .....	13
2.3	Uninstalling e <sup>2</sup> studio.....	15
2.4	Updating e <sup>2</sup> studio .....	15
2.5	Updating FSP.....	15
2.6	Installing RASC for Keil MDK and IAR EWARM .....	15
3.	Project Generation.....	18
3.1	Generating a New RA Project for a Non-TrustZone device.....	18
3.2	Generating a New RA Project for a TrustZone device .....	22
3.2.1	Flat (Non-TrustZone) Project .....	22
3.3	Importing an Existing RA Project.....	26
3.4	Generating and Using a RA Static Library.....	27
3.4.1	Creating the Static Library Project .....	28
3.4.2	Using Static Library in Executable Project.....	32
3.5	RA Project Configuration Editor.....	36
3.5.1	Summary Page .....	36
3.5.2	BSP Page.....	37
3.5.3	Clocks Configuration Page.....	38
3.5.4	Pin Configuration Page .....	40
3.5.5	Stacks Configuration Page.....	43
3.5.6	Components Configuration Page.....	49
3.5.7	Interrupt Configuration Page .....	50
3.5.8	Event Links Configuration Page.....	52
3.6	Editor hover.....	54
4.	Building.....	56
4.1	Build Configurations.....	56
4.2	Building a Sample Project.....	57
4.3	Saving the Build Settings Report .....	57
5.	Debugging .....	58
5.1	Changing an Existing Debug Configuration.....	59
5.2	Creating a New Debug Configuration .....	61
5.3	Basic Debugging Features.....	62
5.3.1	Debug View .....	63
5.3.2	Breakpoints View .....	64
5.3.3	Expressions View.....	65
5.3.4	Registers View .....	66

5.3.5	Memory View.....	66
5.3.6	Memory Usage View .....	68
5.3.7	Disassembly View .....	71
5.3.8	Variables View .....	71
5.3.9	IO Registers View .....	72
5.3.10	Eventpoints View.....	73
5.3.11	Trace View .....	76
5.3.12	Fault Status View .....	78
5.3.13	Run Break Timer .....	79
6.	Setting up a FreeRTOS Application.....	81
6.1	General Purpose Timer Example in FreeRTOS .....	81
6.2	Creating the Sample Project.....	81
7.	Setting up an Azure RTOS Application.....	86
7.1	General Purpose Timer Example in Azure RTOS .....	86
7.2	Creating the Sample Project.....	87
8.	Help .....	92
	Revision History.....	94

## 1. Overview

Renesas e<sup>2</sup> studio is the Integrated Development Environment for Renesas embedded microcontrollers. e<sup>2</sup> studio is based on the industry-standard open-source Eclipse IDE framework and the C/C++ Development Tooling (CDT) project, covering build (editor, compiler, and linker control) and debug phases with an extended GNU Debug (GDB) interface support.

The e<sup>2</sup> studio IDE provides support for the Renesas Flexible Software Package (FSP), which is an optimized software package designed to provide easy to use, scalable, high-quality software for embedded system design. The primary goal of the FSP is to provide lightweight, efficient drivers that meet common use cases in embedded systems.

The e<sup>2</sup> studio IDE includes multiple Graphical User Interface (GUI) wizards for auto-generating code, including and configuring existing drivers, configuring build and debug options, and running the applications you create. Driver documentation is integrated in the form of tooltips, which are available in the code editor view.

Renesas FSP support is included in e<sup>2</sup> studio releases 2022-07 (64-bit) and higher. Multiple views and editors are available to support Renesas RA microcontrollers and the open-source GNU Arm Embedded Toolchain.

The e<sup>2</sup> studio IDE also supports Arm® TrustZone® technology. Arm® TrustZone® technology divides the system and the application into Secure and Non-Secure partitions. e<sup>2</sup> studio helps users to set up new TrustZone enabled projects and provides debugging features for both secure and non-secure applications on Renesas devices with Arm® TrustZone® technology. Refer to this link for more information about RA Arm® TrustZone® tools, <https://www.renesas.com/sg/en/document/apn/ra-arm-trustzone-tooling-primer>.

This user manual targets Non-TrustZone devices and Flat (Non-TrustZone) Projects in TrustZone devices.

When using a 3rd-party IDE and toolchain, you can use the Renesas RA Smart Configurator to configure the software system (BSP, drivers, RTOS, and middleware) for a Renesas RA microcontroller.

Note: The contents displayed on the screen may differ slightly depending on the e<sup>2</sup> studio version, the device used, and the FSP version.

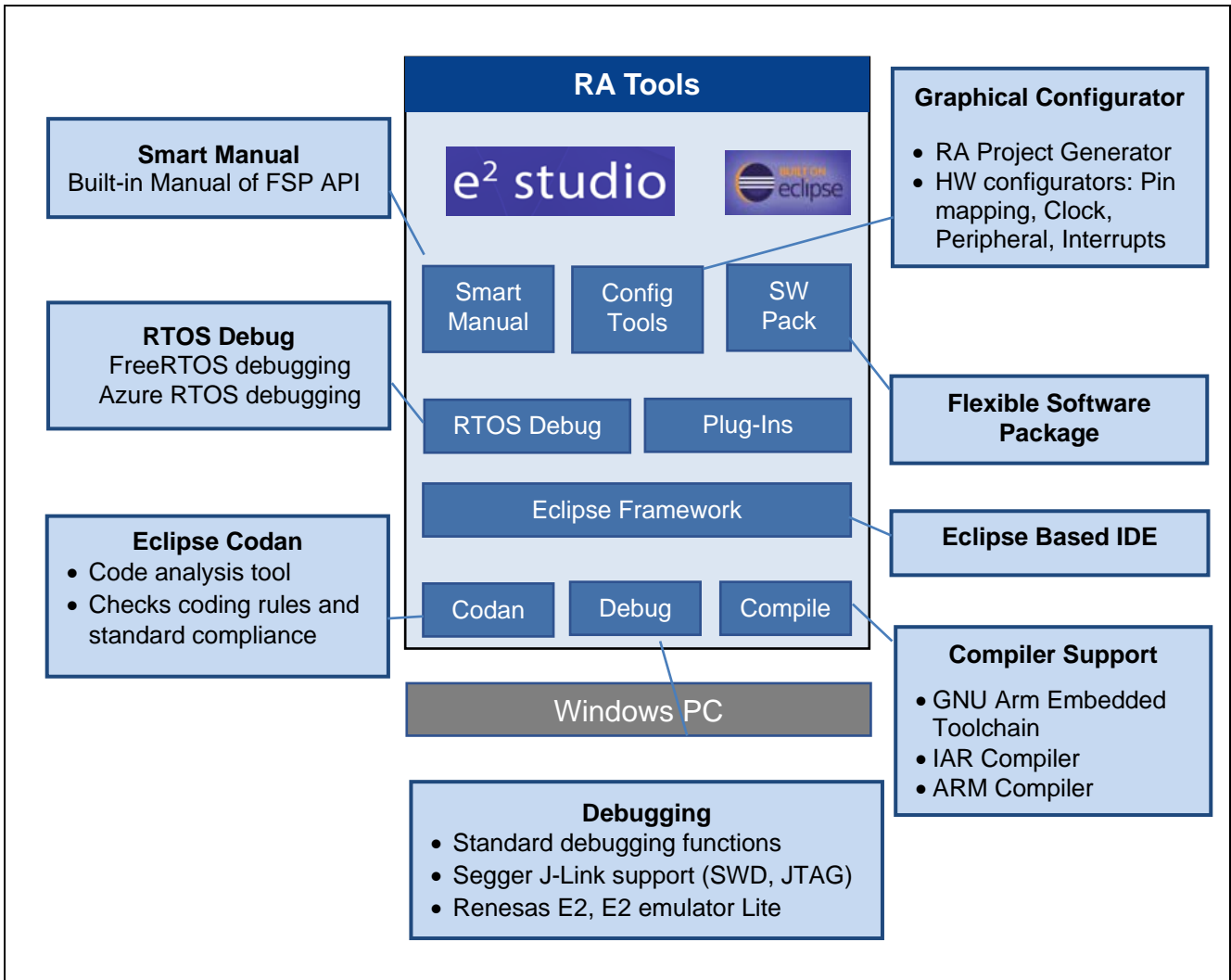

Figure 1-1. Renesas RA in e<sup>2</sup> Studio

### 1.1 System Configuration

A typical system configuration includes a host machine and a target board as shown below.

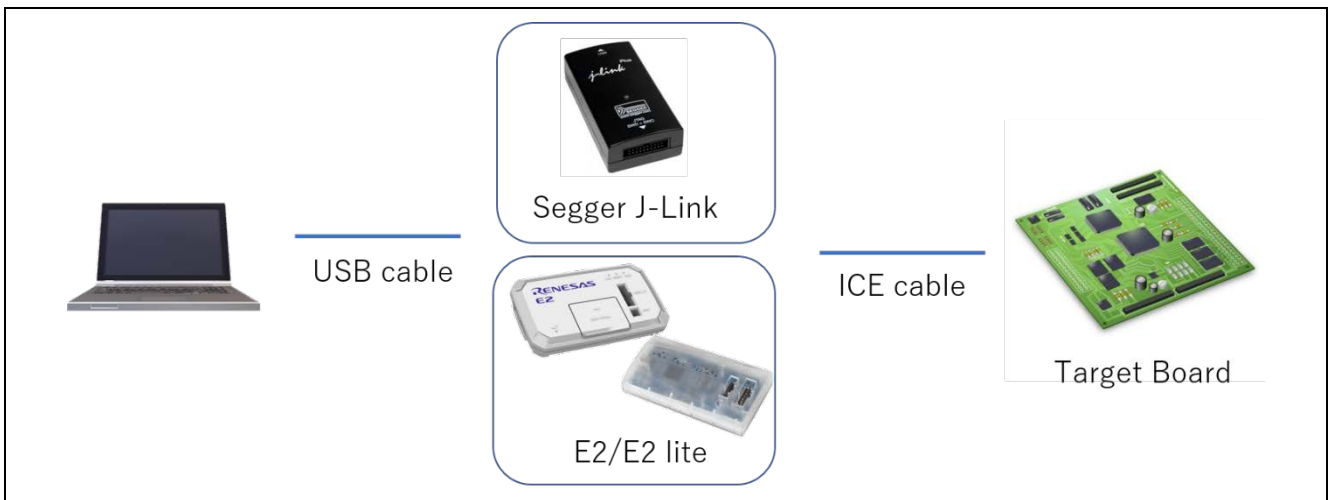

Figure 1-2. System Configuration

## 1.2 System Requirements

### 1.2.1 Hardware Environment:

- Processor: At least 1GHz (support hyper-threading/multi-core CPU)
- Main memory: At least 2GB of free memory space
- Hard disk capacity: At least 2GB of free space
- Display: Resolution at least 1,024 x 768; at least 65,536 colors
- Interface: USB 2.0 (High-speed/Full-speed). High-speed is recommended.

### 1.2.2 Operating Environment:

Architecture	Windows	e <sup>2</sup> studio
64-bit version	Windows 11 Windows 10 Windows 8.1	2022-07

Note: 64-bit OS is required for e<sup>2</sup> studio 2022-07 and higher.

## 1.3 Supported Toolchains

- GNU Arm Embedded Toolchain (version: 10.3-2021.10)
- IAR Compiler 9.20.2 or later
- Arm Compiler (version: 6.18 or later)

## 1.4 Supported Emulator Devices

- Segger J-Link, E2, E2 emulator Lite

## 1.5 Outline of RA Project Development

This document provides detailed instructions on how to start developing with Renesas RA. The main steps are:

- Generating a RA project
- Configuring the RA project to fit hardware specifications such as clock, ICU, and pin functions
- Configuring the FreeRTOS
- Configuring the Azure RTOS
- Configuring the BSP (selecting HAL driver models)
- Adding user code
- Building the project
- Configuring the debugger and launching debugging

Details for performing the above main steps are provided Chapters 3, 4, and 5.

## 1.6 Supported FSP Version

FSP v4.0.0 or higher.

# 2. Installation

The development tools can be installed using either the "FSP with e<sup>2</sup> studio Installer" or the standard e<sup>2</sup> studio Installer.



## 2.1 Installing the FSP with e<sup>2</sup> studio Installer

The FSP with e<sup>2</sup> studio Installer includes the e<sup>2</sup> studio tool, FSP packs, GCC toolchain, and other tools required to use this software. To download and install the FSP with e<sup>2</sup> studio Installer, follow the steps below:

1. Visit the GitHub page of Flexible Software Package (FSP) for Renesas RA MCU Family:  
<https://github.com/renesas/fsp/releases>
2. Select FSP with e<sup>2</sup> studio Installer (for example, `setup_fsp<version>_e2s_<version>.exe`) and click the link to download directly.

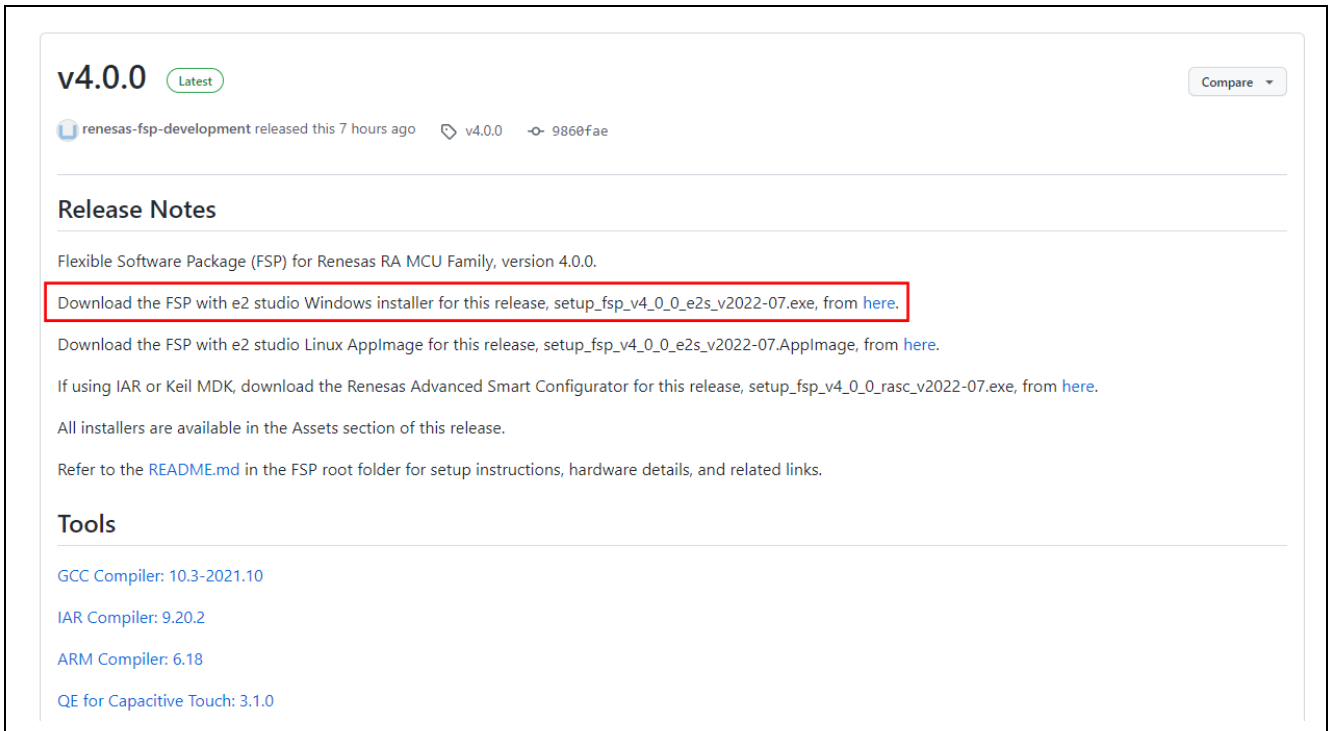

Figure 2-1. Installation – Download the FSP Package

3. Run the installation file.
4. In the **Select Install Type** page, if you would like to customize the components to be installed, choose **Custom Install** then click **Next**.

Note: New users are recommended to select the **Quick Install** option to minimize the configuration steps. This option installs e<sup>2</sup> studio, FSP, and GCC ARM Embedded by default. If you select **Quick Install**, the last step will not be shown.

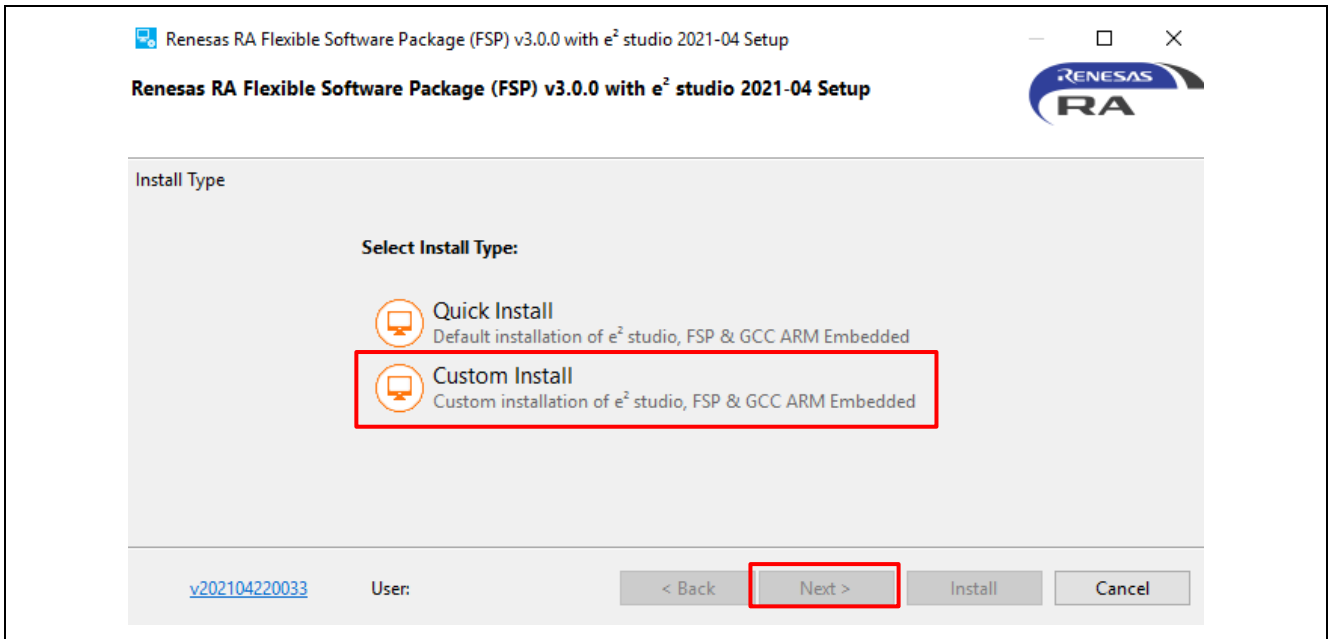

Figure 2-2. Installation – Select Install Type

5. In the **Welcome** page, you may use the default folder or change it by clicking [**Change...**]. Click **Next** to continue.

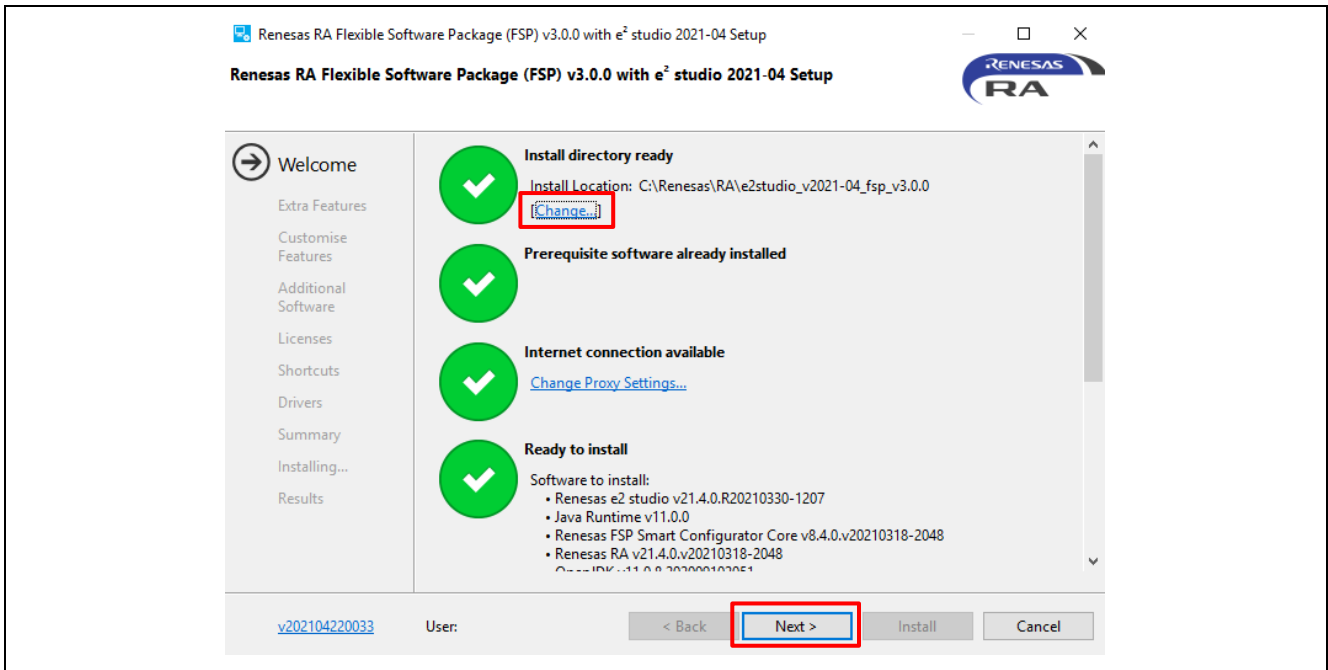

Figure 2-3. Installation – Welcome Page

6. In the **Extra Features** page, click **Select All**, then click **Next**.

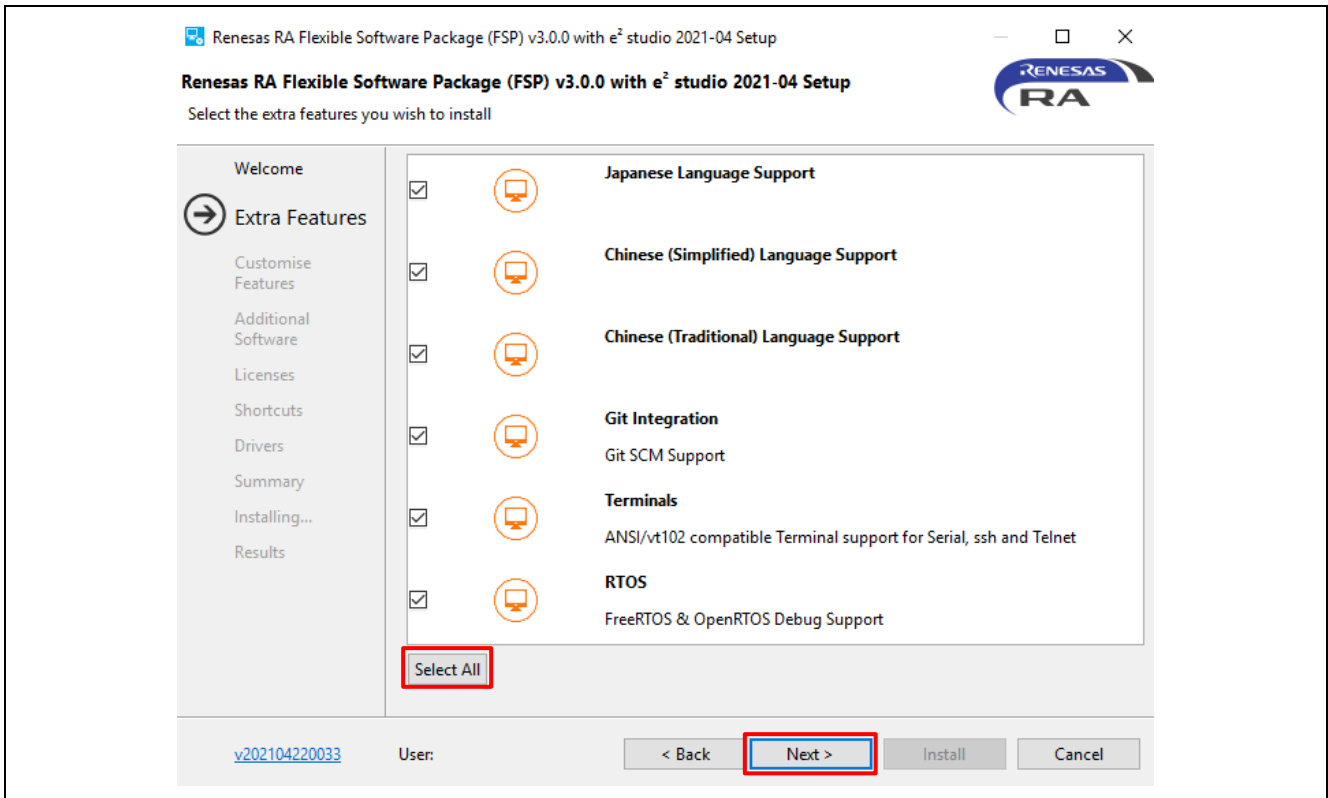

Figure 2-4. Installation – Extra Features

7. In the **Customise Features** page, select the components you want to install and click the **Next** button to continue.

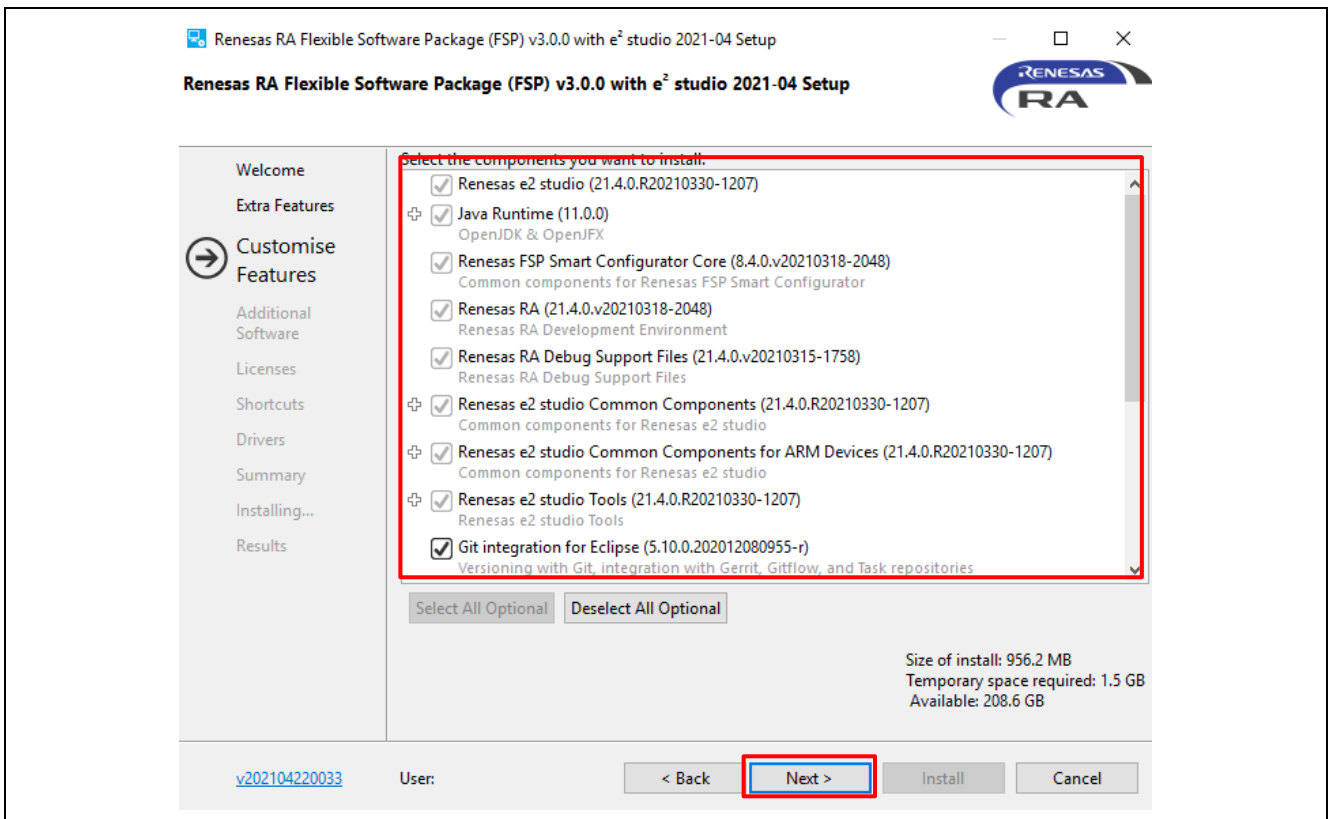

Figure 2-5. Installation – Customise Features

- In the **Additional Software** page, select the **GNU ARM Embedded 10.3-2021.10** to be installed, then click **Next**. This page is not shown if you selected **Quick Install**.

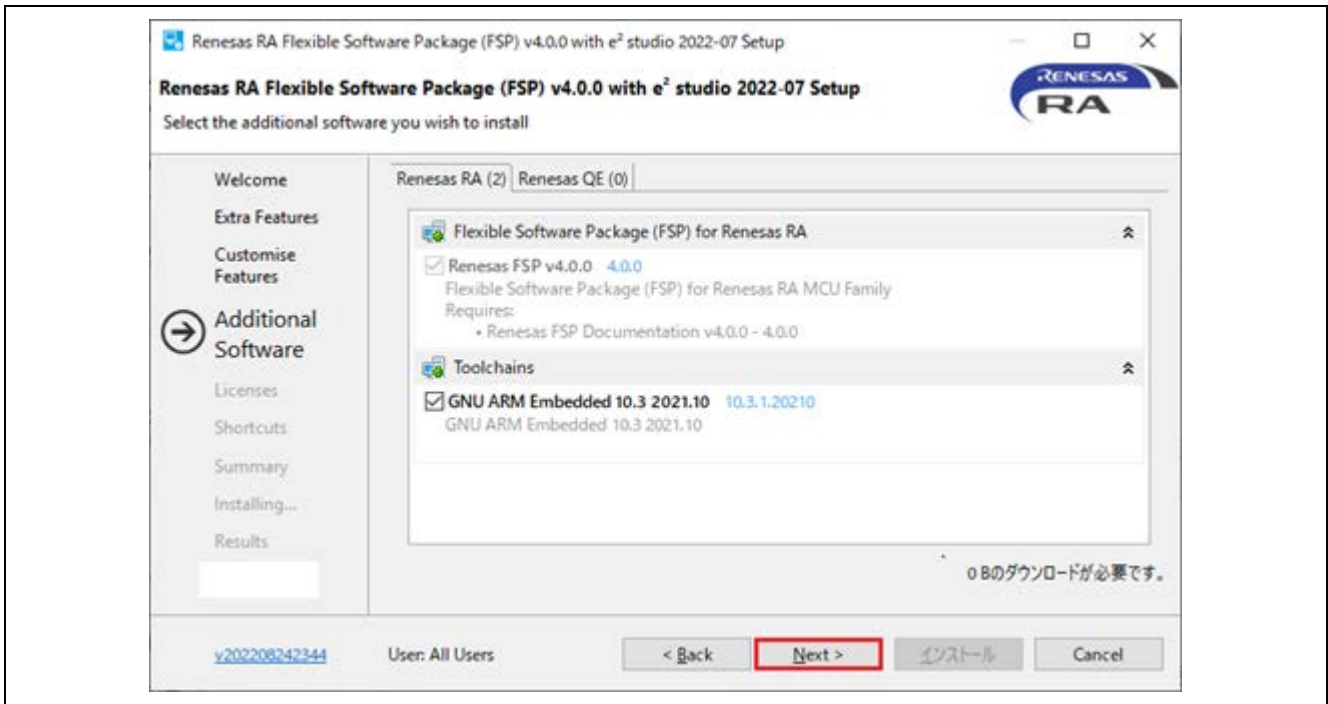

Figure 2-6. Installation – Select Additional Software

- Tick the checkbox to accept the license agreement, then click **Next** to continue.

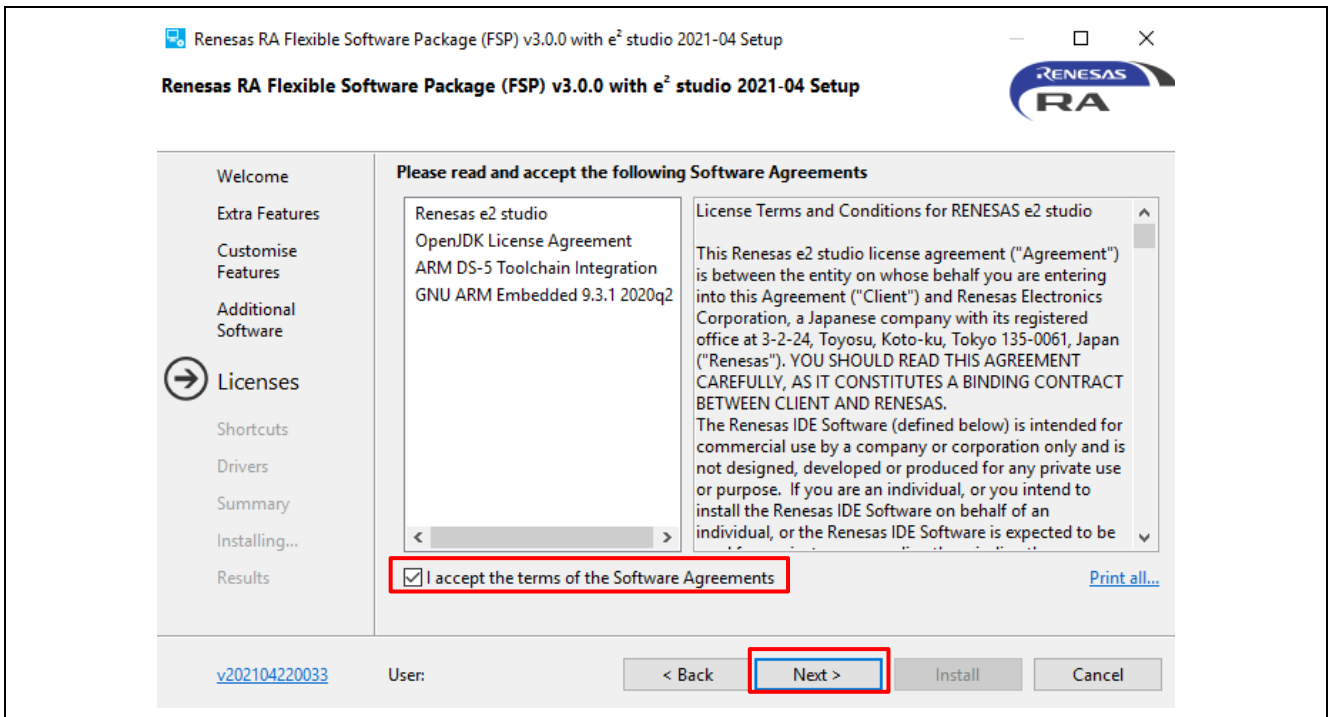

Figure 2-7. Installation – Software Agreements

- In the **Shortcuts** page, select the shortcut name for the start menu and click **Next** button to continue.  
 Note: If you already have installed e² studio in another location, renaming this installation is recommended to distinguish it from the other e² studio(s).

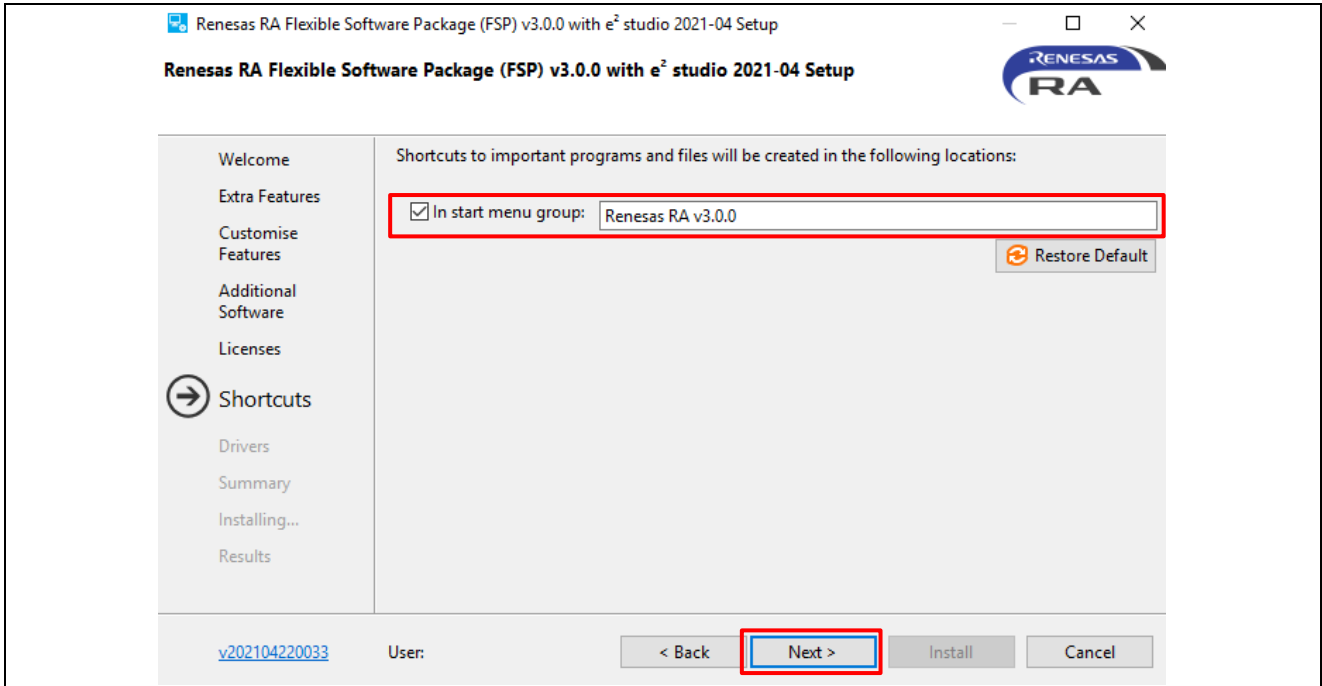

Figure 2-8. Installation – Shortcuts

11. Check the **Summary** and click **Install** to continue.

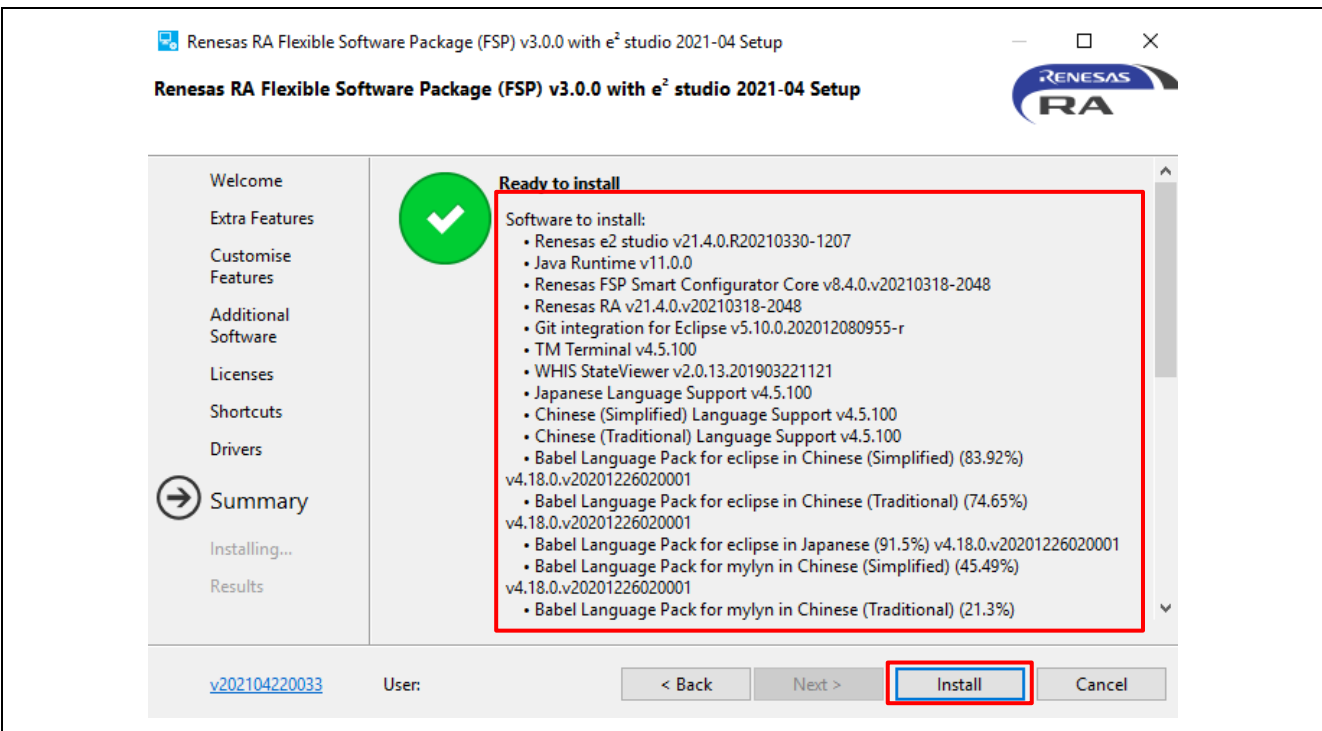

Figure 2-9. Installation – Summary

12. Click **OK** to finish the installation.

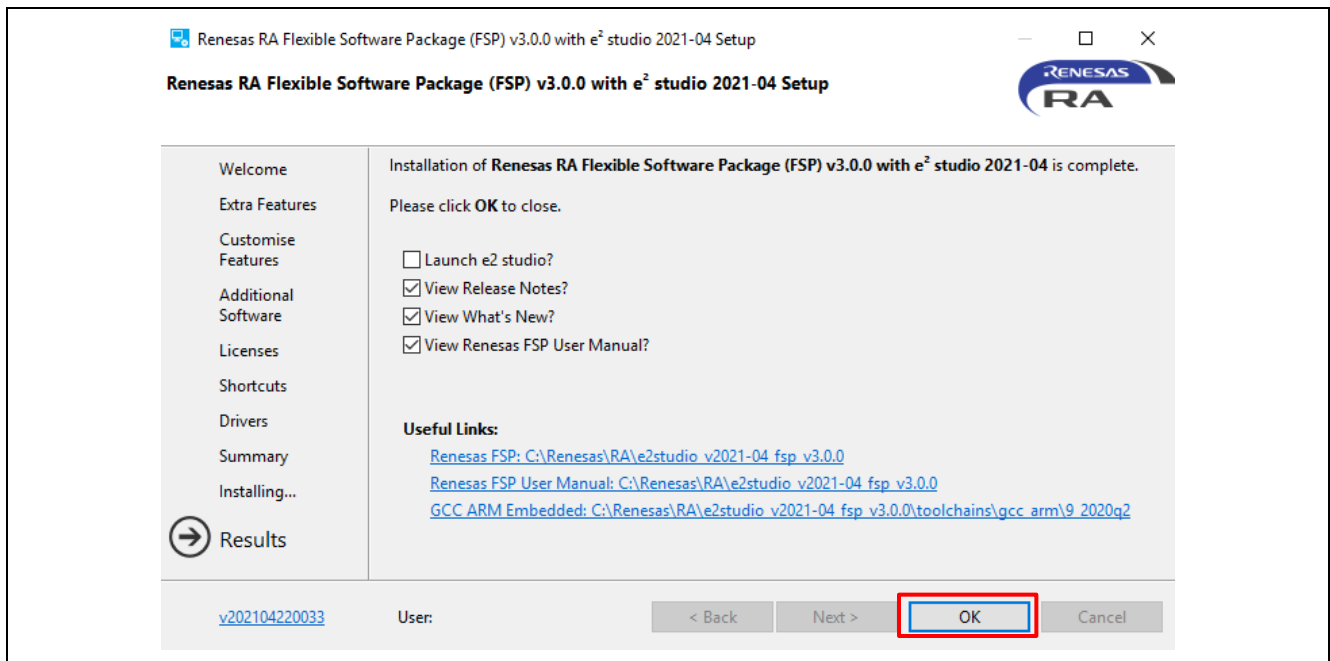

Figure 2-10. Installation – Complete Installation

## 2.2 Installing e<sup>2</sup> studio and FSP Independently

This section describes installation of the following components independently:

- e<sup>2</sup> studio IDE
- GCC ARM Embedded Compiler
- Renesas Flexible Software Package (FSP)

### 2.2.1 Installing e<sup>2</sup> studio

To install e<sup>2</sup> studio for RA, follow these steps:

1. Download e<sup>2</sup> studio 2022-07 (64-bit version) offline installer from <https://www.renesas.com/e2studio>.
2. Unzip the download file and run the e<sup>2</sup> studio installer to invoke the e<sup>2</sup> studio installation wizard page.
3. If e<sup>2</sup> studio was installed in your PC, the options to modify, remove the existing version, and install e<sup>2</sup> studio to a different location are shown. It is possible to install multiple versions of e<sup>2</sup> studio by selecting **Install to a different location**. Click the **Next** button to continue.

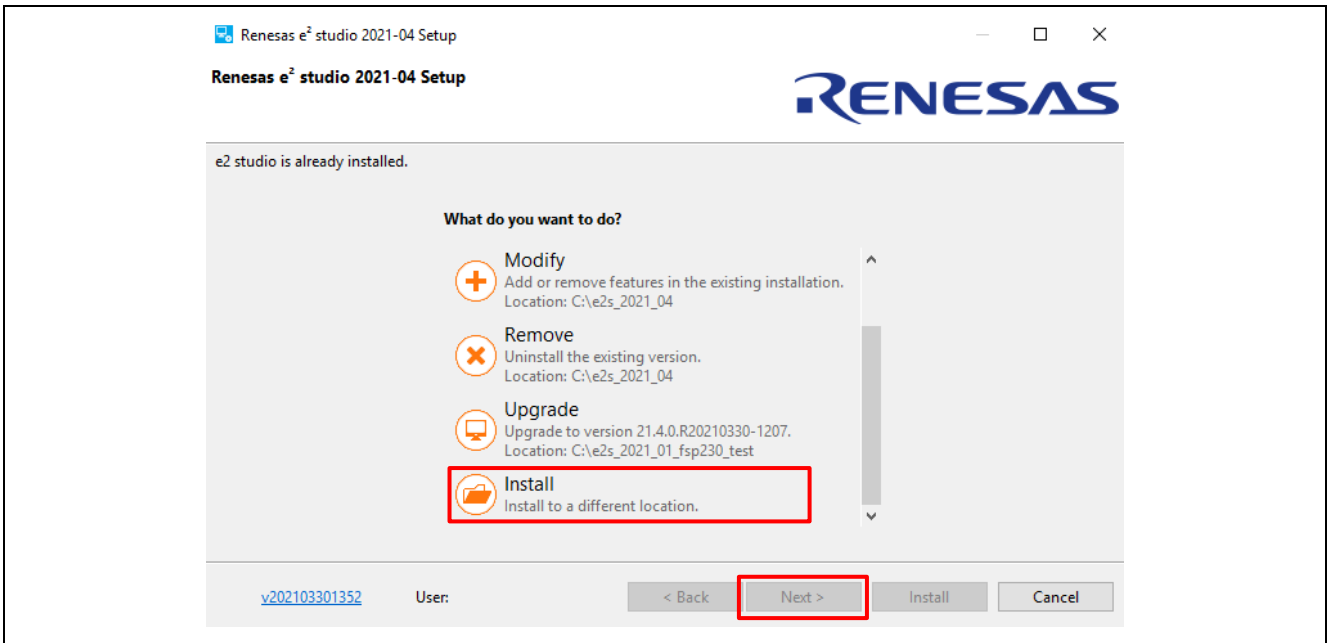

Figure 2-11. Install Multiple Versions of e2 Studio

4. In the **Welcome** page, the default installation location is set to: C:\Renesas\e2\_studio. You can click **[Change...]** to modify it. Click the **Next** button to continue.

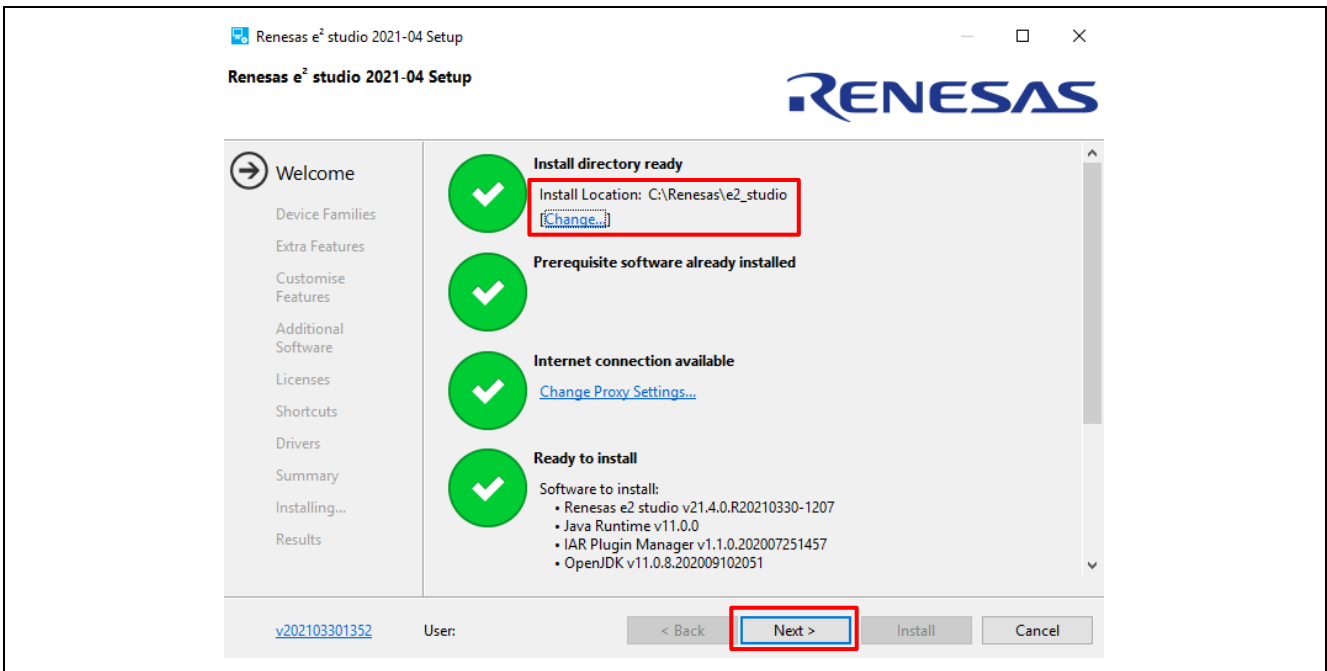

Figure 2-12. Installation – Welcome Page

5. In the **Device Families** page:
  - a. Check the checkbox for **RA**. Checkboxes of other device families are optional.
  - b. Click the **Next** button to continue.

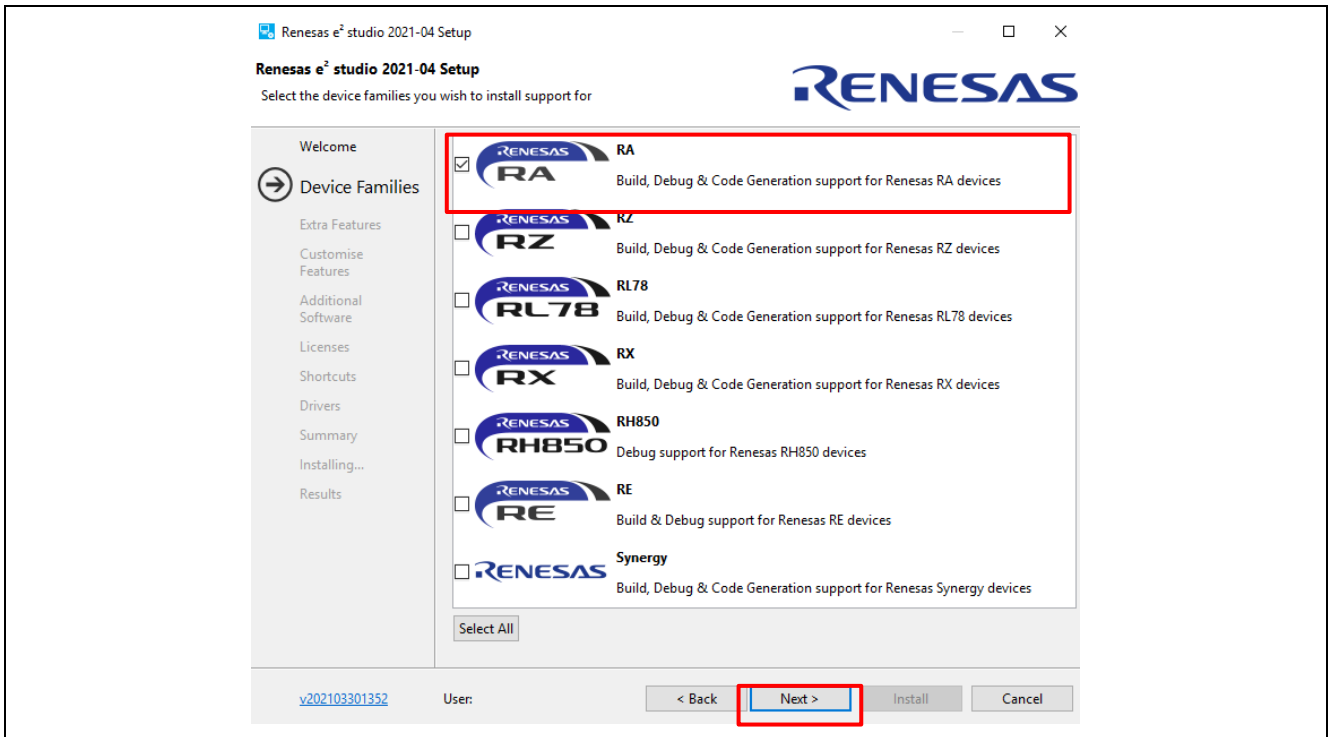

Figure 2-13. Installation – Device Families Page

- 6. In the **Extra Features** page:
  - a. Select **Extra Features** (that is, Language support, Git Integration, RTOS support, and so on) to install.
  - b. For non-English language users, select the language to support at this step.
  - c. Click the **Next** button to continue.

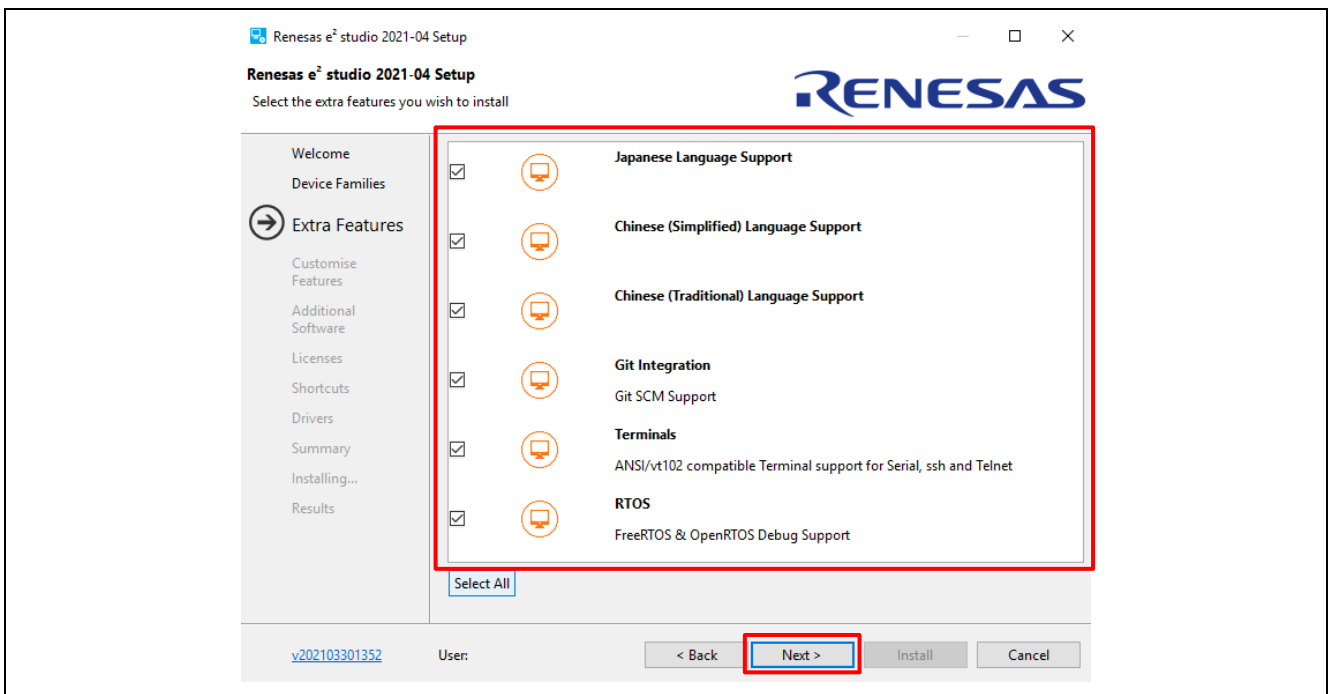
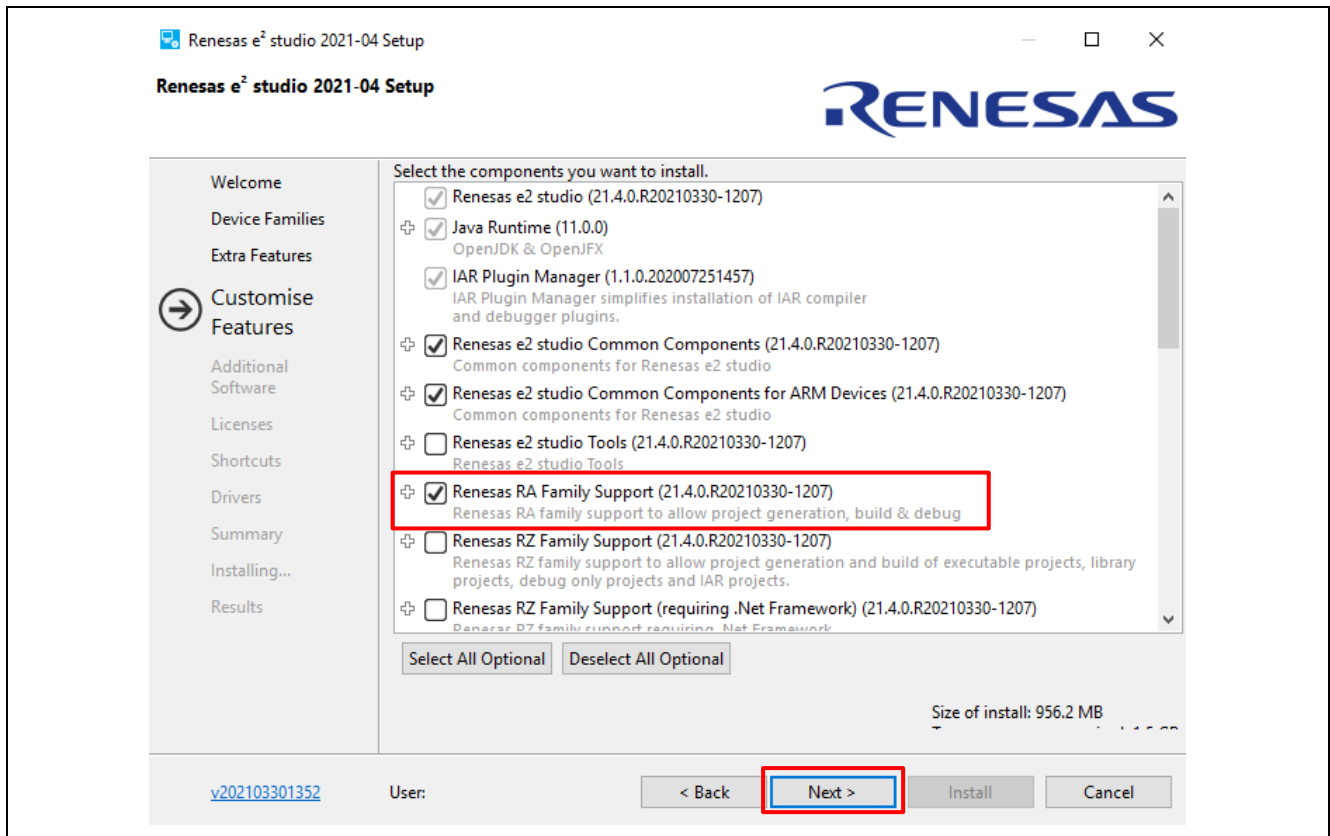

Figure 2-14. Installation – Extra Features Page

- 7. In the **Customise Features** page:
  - a. Ensure that **Renesas RA Family Support** is checked.



- b. Click the **Next** button to continue.



**Figure 2-15. Installation – Customise Features Page**

8. In the **Additional Software** page:
- Select the **GCC Toolchains & Utilities** tab and check the **GNU Arm Embedded 10.3-2021.10** check box to install the GNU Arm Embedded toolchain.
  - Click the **Next** button to continue.

Note: If no internet access is available, you can skip additional software installation because software catalog cannot be downloaded, and continue with the e2 studio installation. To install the GNU Arm Embedded toolchain later, see section 2.2.2.

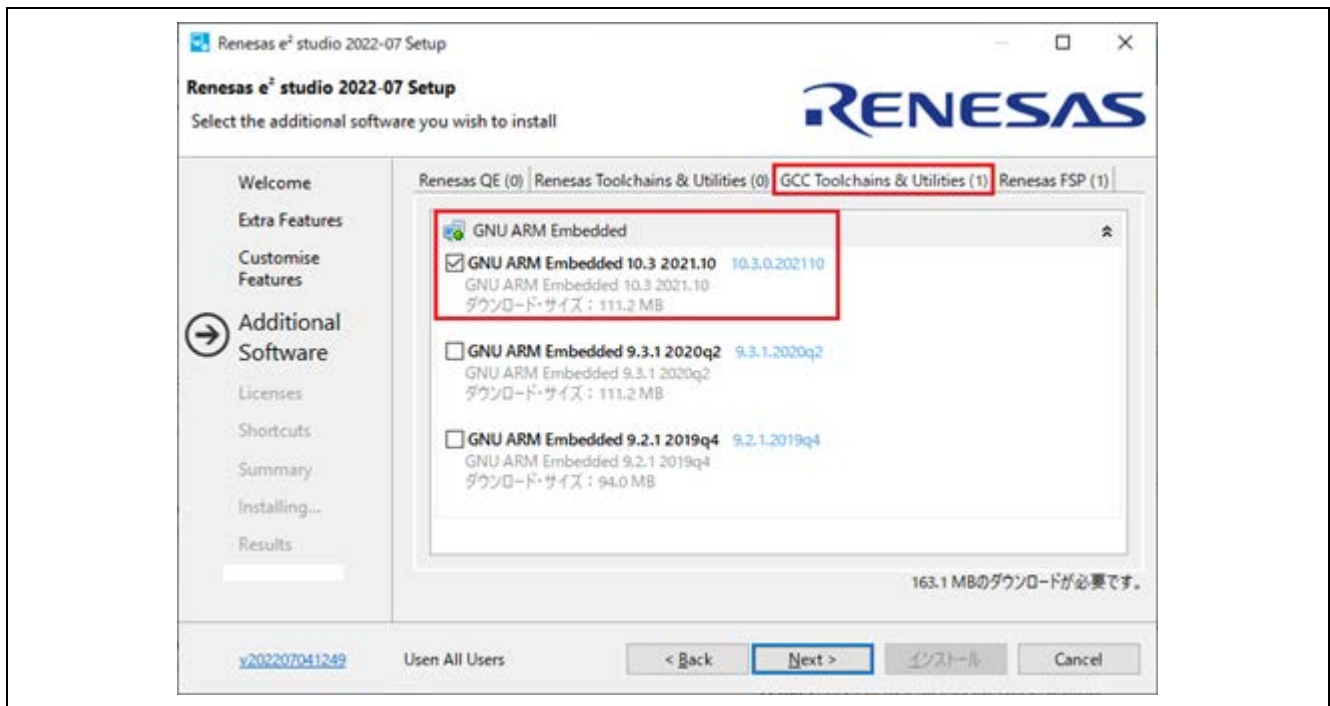

Figure 2-16. Installation – Additional Software Page

9. In the **Licenses** page:  
Read and accept the software license agreement to proceed with the **Next** button.  
You must accept the license agreement, or installation cannot proceed.
10. In the **Shortcuts** page:  
Select the shortcut name for the start menu and click **Next** button to continue.
11. In the **Summary** page:  
Click the **Install** button to install Renesas e<sup>2</sup> studio.
12. **Installing...**  
The installation starts. Depending on the items selected in the “Addition Software” dialog, new dialogs may open to proceed with the installation of these software packages.

### 2.2.2 Setting Up the GNU Arm Embedded Toolchain

The GNU Arm Embedded Toolchain can be installed during e<sup>2</sup> studio installation. Alternatively, after e<sup>2</sup> studio has been installed, the GNU Arm Embedded Toolchain can be installed separately.

To install GNU Arm Embedded Toolchain, follow these steps:

1. Download version 10.3-2021.10 of the GNU Arm Embedded Toolchain supported by Renesas RA (`gcc-arm-none-eabi-10.3-2021.10-win32.exe`) from <https://developer.arm.com/tools-and-software/open-source-software/developer-tools/gnu-toolchain/gnu-rm/downloads>.
2. Run the installer to install the GNU Arm Embedded Toolchain on the host machine.
3. Select the installation language. Click **[Yes]** in the installation confirmation dialog.
4. Keep all default settings in the installation wizard.
5. When the **Install wizard Complete** dialog appears, check the box **Add path to environment variable**, click **[Finish]** to complete the installation.

### 2.2.3 Installing the Renesas RA Flexible Software Package (FSP)

The Renesas RA Flexible Software Package (FSP) can be installed during e<sup>2</sup> studio installation. Alternatively, after e<sup>2</sup> studio has been installed, the FSP can be installed separately.

To install the FSP, follow these steps:

1. Visit the GitHub page of Flexible Software Package (FSP) for Renesas RA MCU Family: <https://github.com/renesas/fsp/releases>
2. Find and download the latest FSP packs installer (for example, FSP\_Packs\_<version>.exe). The FSP Package Installer includes the driver library, HTML User's Manual, and a readme file.

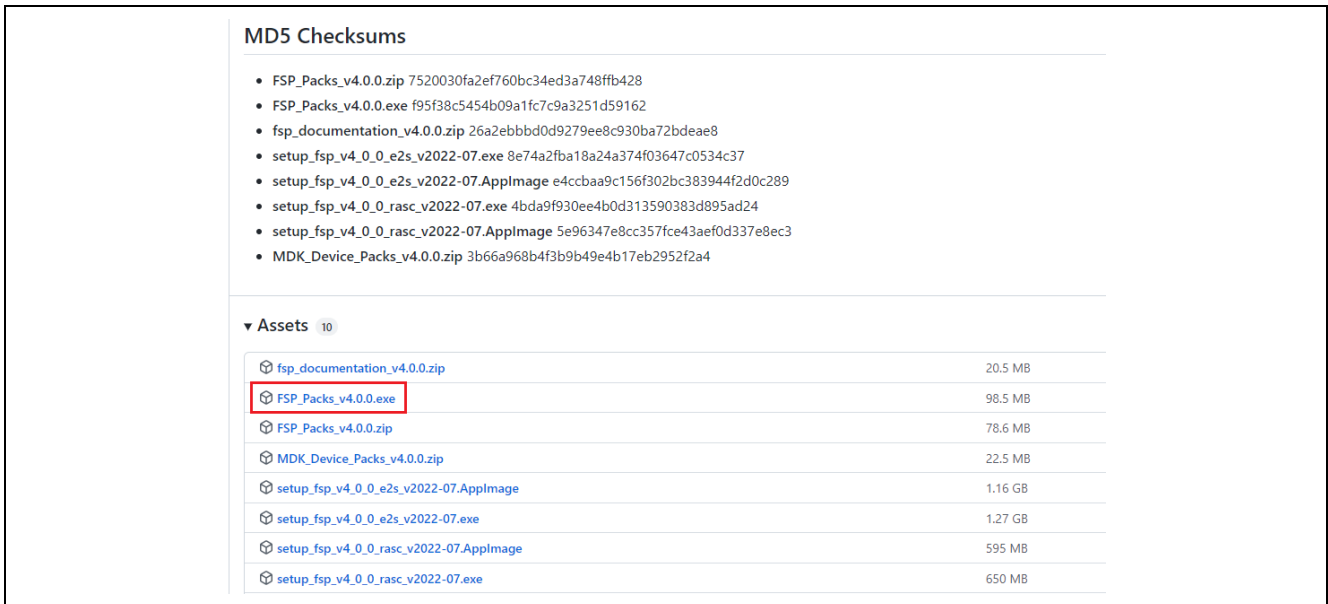

Figure 2-17. Installation – Download the FSP Packs

3. Make sure that a compatible e<sup>2</sup> studio was installed and closed during this installation.
4. Run the FSP packs installer and click **Next** to continue.
5. Click **I Agree** to accept the agreement.
6. Browse to the folder where e<sup>2</sup> studio is installed (for example, C:\Renesas\e2\_studio) and click **Install**.

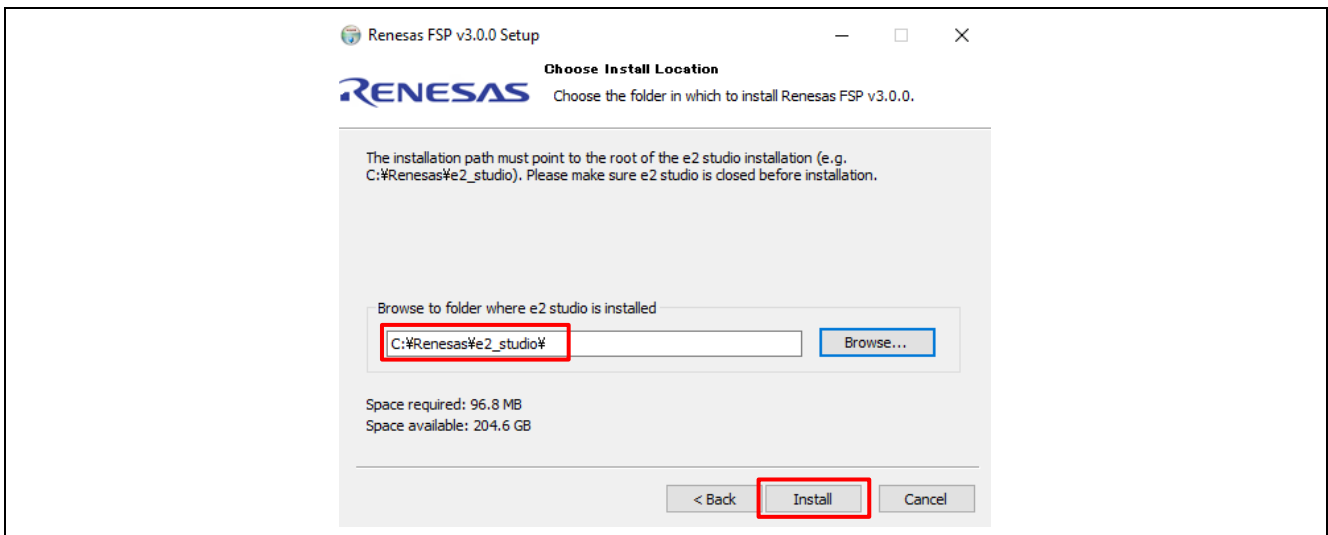

Figure 2-18. Choose Install Location

7. Click **Finish** to finish the installation.

## 2.3 Uninstalling e<sup>2</sup> studio

You can uninstall e<sup>2</sup> studio by following typical steps to uninstall a program in the Windows OS:

1. Click on **Start** → **Control Panel** → **Programs and Features**
2. From the currently installed programs list, choose “e<sup>2</sup> studio” and click the **Uninstall** button.
3. Click **Uninstall** to confirm the deletion in the **Uninstall** dialog.

At the end of the un-installation, e<sup>2</sup> studio is deleted from the installed location and the shortcut in Windows menu is removed.

**Note:** If you have installed e<sup>2</sup> studio at multiple locations, you may not be able to find the uninstaller in **Apps & features** of the **Control Panel**. In such cases, launch the e<sup>2</sup> studio uninstaller located at: {e2 studio installed folder}/uninstall/uninstall.exe.

## 2.4 Updating e<sup>2</sup> studio

To update e<sup>2</sup> studio, run the new version of e<sup>2</sup> studio installer (either **FSP with e<sup>2</sup> studio installer** or standard e<sup>2</sup> studio installer). Download the installer according to section 2.2.1.

Do not overwrite an existing installation. Before upgrading, uninstall the old version of e<sup>2</sup> studio. To keep both old and new e<sup>2</sup> studio versions, you can create a new folder as installation destination for the new e<sup>2</sup> studio version.

## 2.5 Updating FSP

To update the FSP, run the new version of FSP installer. Download the installer according to section 2.2.3.

## 2.6 Installing RASC for Keil MDK and IAR EWARM

The RA Smart Configurator (RASC) is a desktop application designed to configure device hardware, such as clock setup and pin assignment, as well as initialization of FSP software components for a Renesas RA microcontroller project when using a 3rd-party IDE (Keil MDK and IAR EWARM) and toolchain.

To download and install the RASC, follow the steps below:

1. Visit the GitHub page of Flexible Software Package (FSP) for Renesas RA MCU Family:  
<https://github.com/renesas/fsp/releases>
2. Search for the RASC installer and download it (for example, setup\_fsp<version>\_rasc\_<version>.exe).

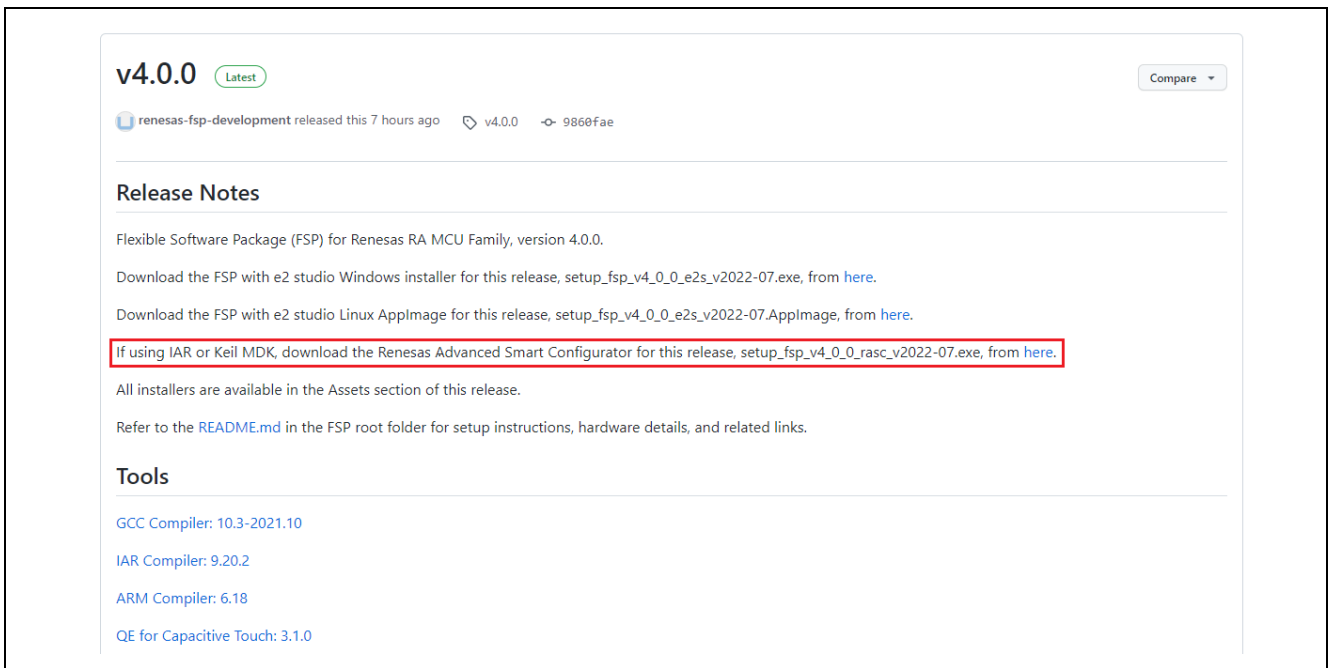

**Figure 2-19. Installation – Download the RASC Package**

3. Run the installation file.
4. In the welcome page, you may use the default folder or change it by clicking [**Change...**]. Click **Next** to continue.

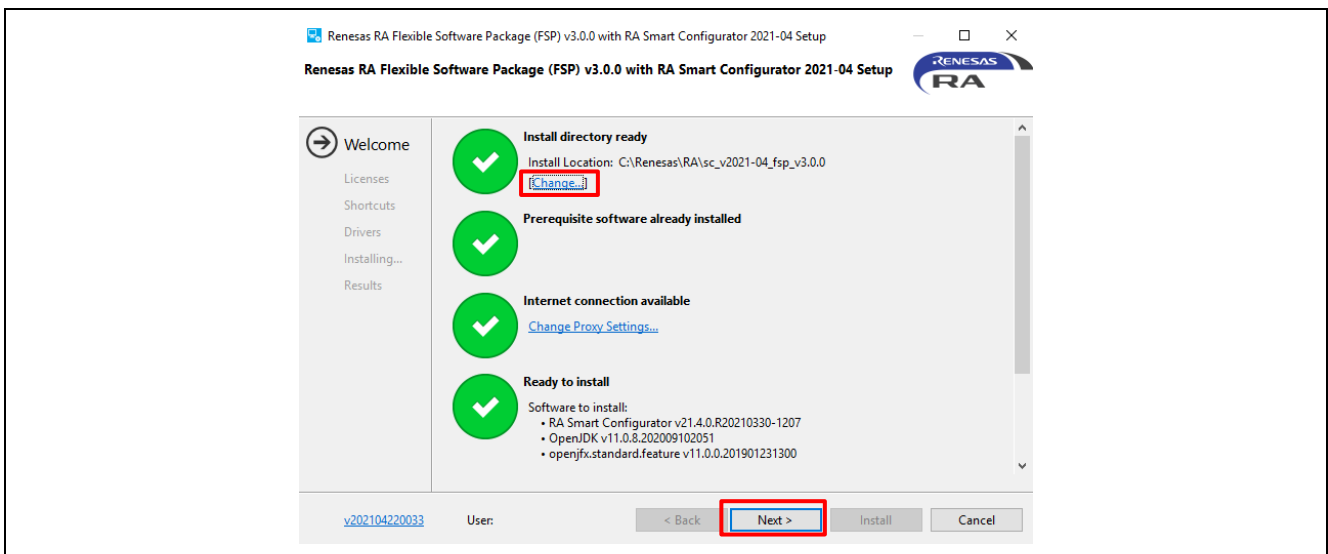

**Figure 2-20. Installation – Welcome Page**

5. Tick the checkbox to accept the license agreement, then click **Next** to continue.

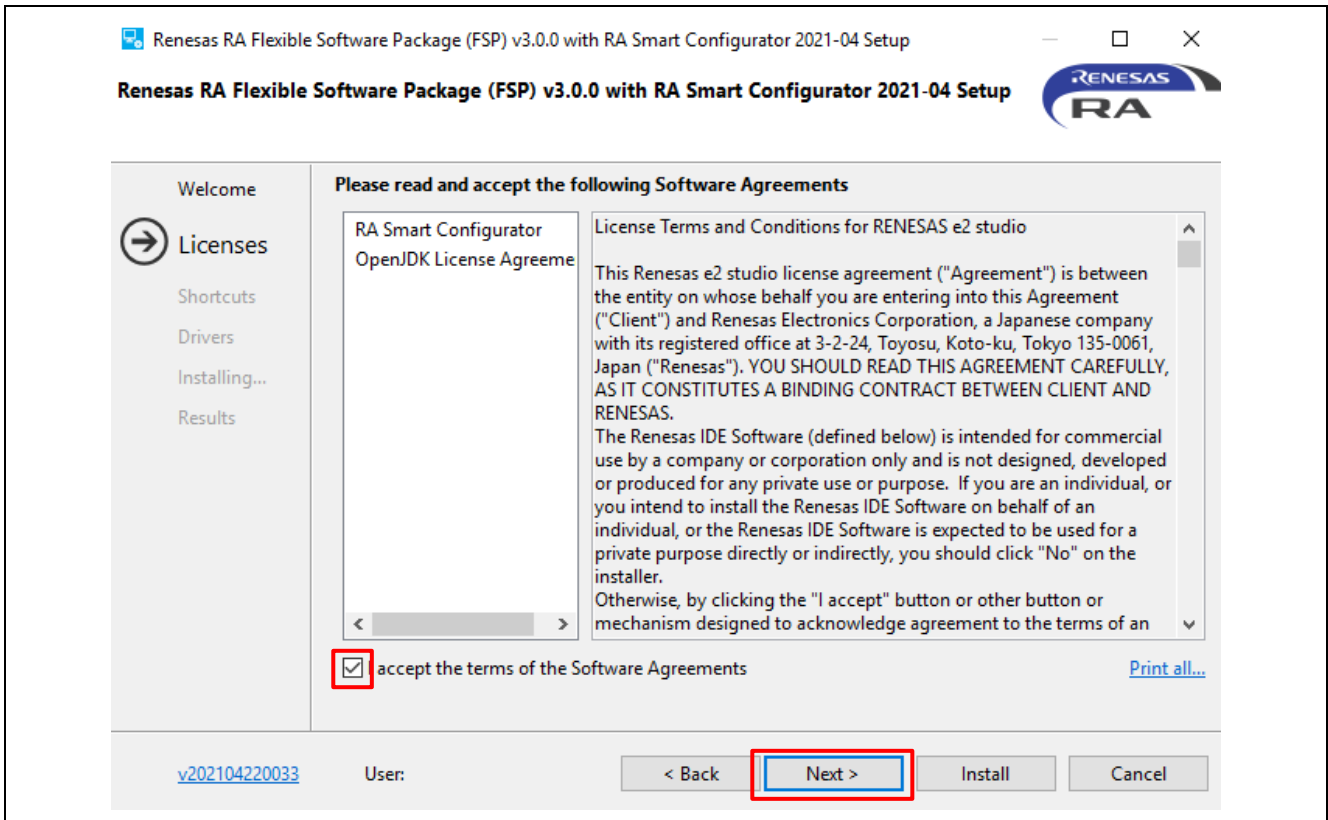

Figure 2-21. Installation – Software Agreements

6. Check the Shortcuts and click **Install** to continue.

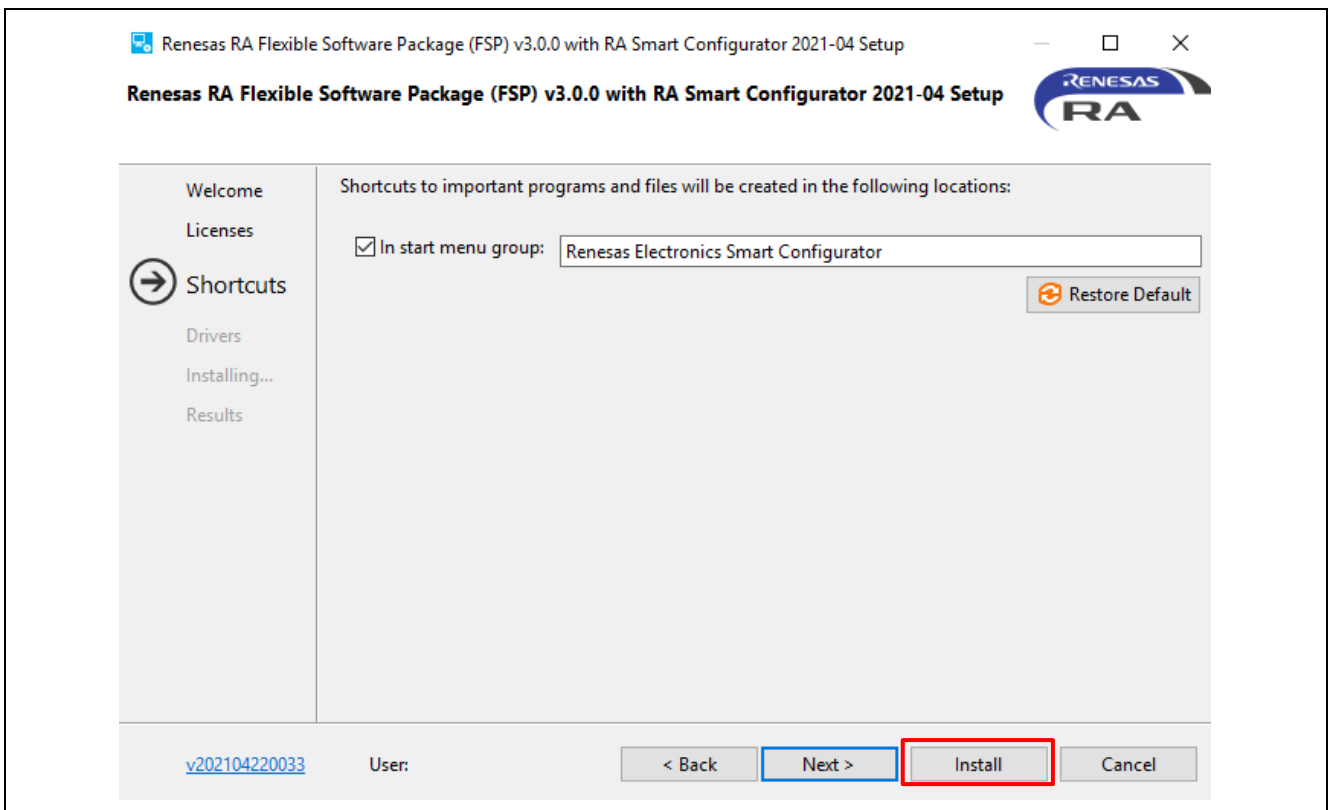

Figure 2-22. Installation – Shortcut

7. Click **OK** to finish the installation.

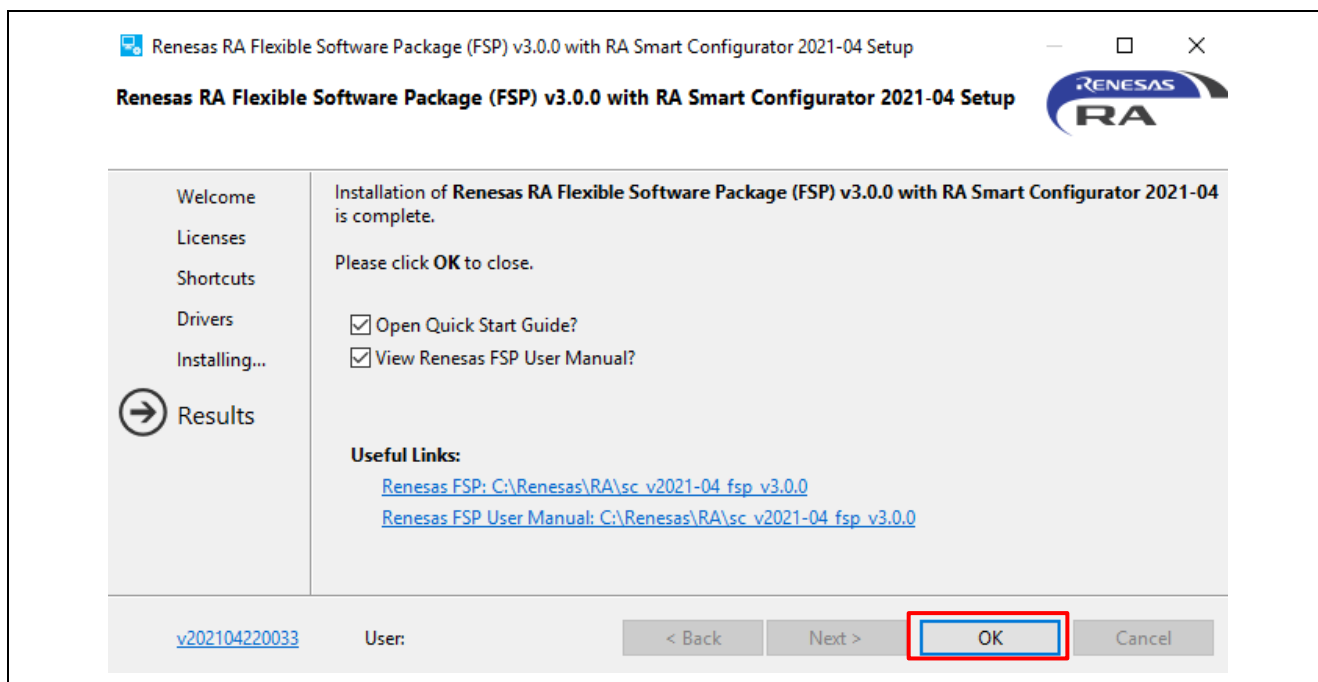

Figure 2-23. Installation – Complete Installation

Note: For more information on how to use RASC with Keil MDK and IAR EWARM, refer to *RASC User Guide for MDK and IAR* in the FSP document:

[https://renesas.github.io/fsp/start\\_de\\_v.html#RASC-MDK-IAR-user-guide](https://renesas.github.io/fsp/start_de_v.html#RASC-MDK-IAR-user-guide)

### 3. Project Generation

This chapter describes the creation of a new RA project. The e<sup>2</sup> studio IDE includes a wizard to help create a new RA project quickly. The wizard matches the project to a particular RA device and board.

The project generator can set up the pin configurations, interrupts, clock configurations, and the necessary driver software.

As a prerequisite, the FSP and the toolchain must be installed on the host machine as described in chapter 2.

#### 3.1 Generating a New RA Project for a Non-TrustZone device

This section describes how to generate a RA project for a non-TrustZone device. To generate a project for a TrustZone device, refer to section 3.2.

A simple project generation wizard is available in e<sup>2</sup> studio to generate a new RA project with a project name and the associated device and board, including board-level drivers.

Start the e<sup>2</sup> studio application and choose a workspace folder in the Workspace Launcher. To configure a new RA project, follow these steps:

1. Select **File** → **New** → **Renesas C/C++ Project** → **Renesas RA**.

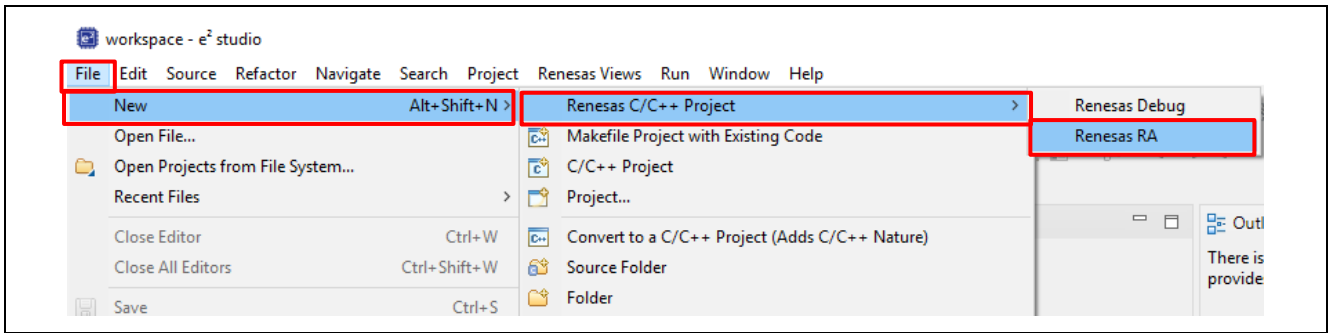

Figure 3-1. Project Generation – New Project Creation

2. Select **Renesas RA C/C++ Project** template. Click **Next** to continue.

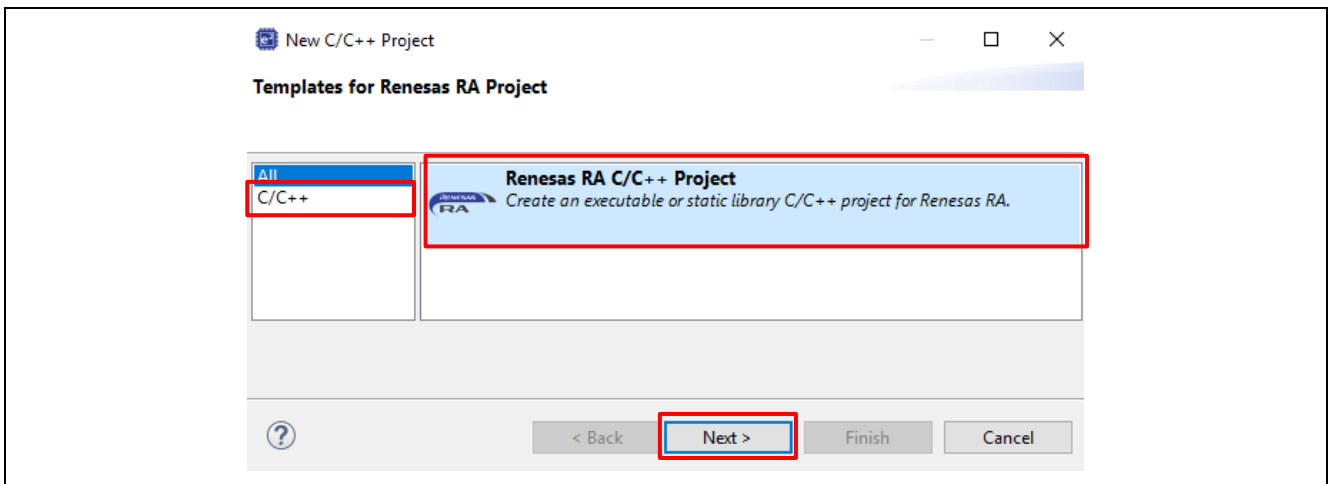

Figure 3-2. Project Generation – Select RA Project

3. In the project generation wizard, enter the following project information:

- **Project name:** Enter a name (for example, **RA\_Tutorial**).
- **Use default location:** Checked. If you want to create a project in a different location, uncheck this checkbox and enter a new location.
- Click **Next** to continue.

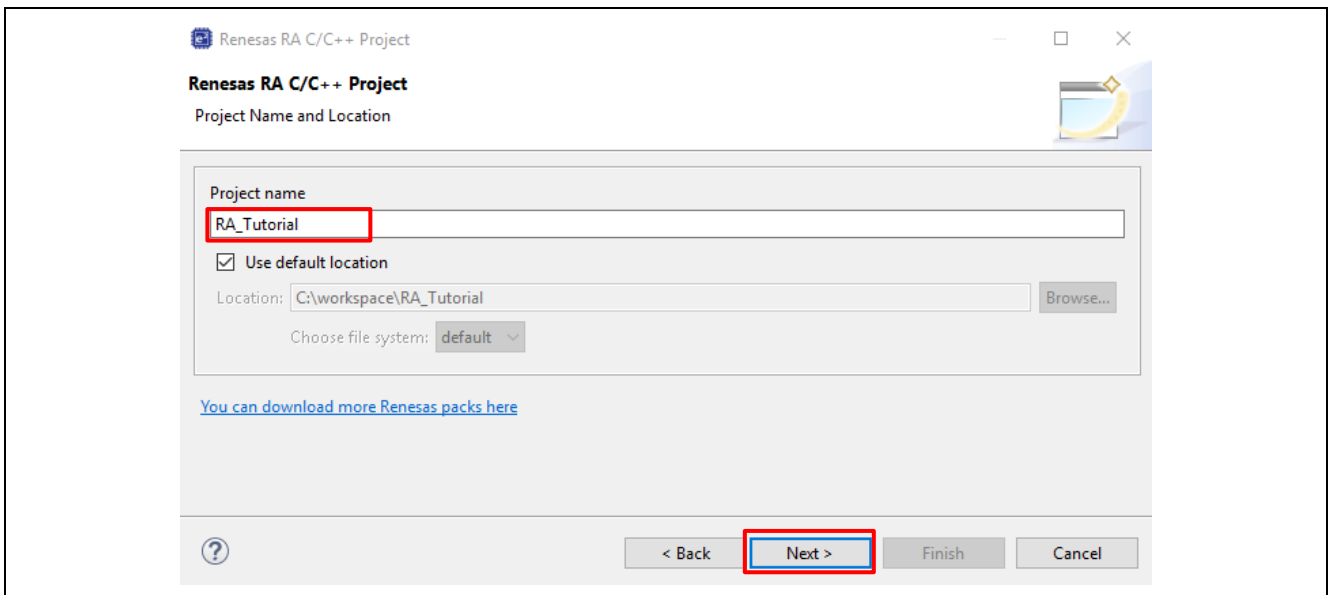

Figure 3-3. Project Generation – New RA Project Generation Wizard



- 4. In the Device and Tools Selection dialog, enter device and tool information:
  - **Board:** EK-RA6M3
  - **Toolchains:** Latest GNU Arm Embedded Toolchain approved for use with Renesas RA (for example, GCC ARM Embedded 10.3.1.20210824)
  - **Debugger:** J-Link (ARM)
  - Keep all other fields as default.
  - Click **Next** to continue.

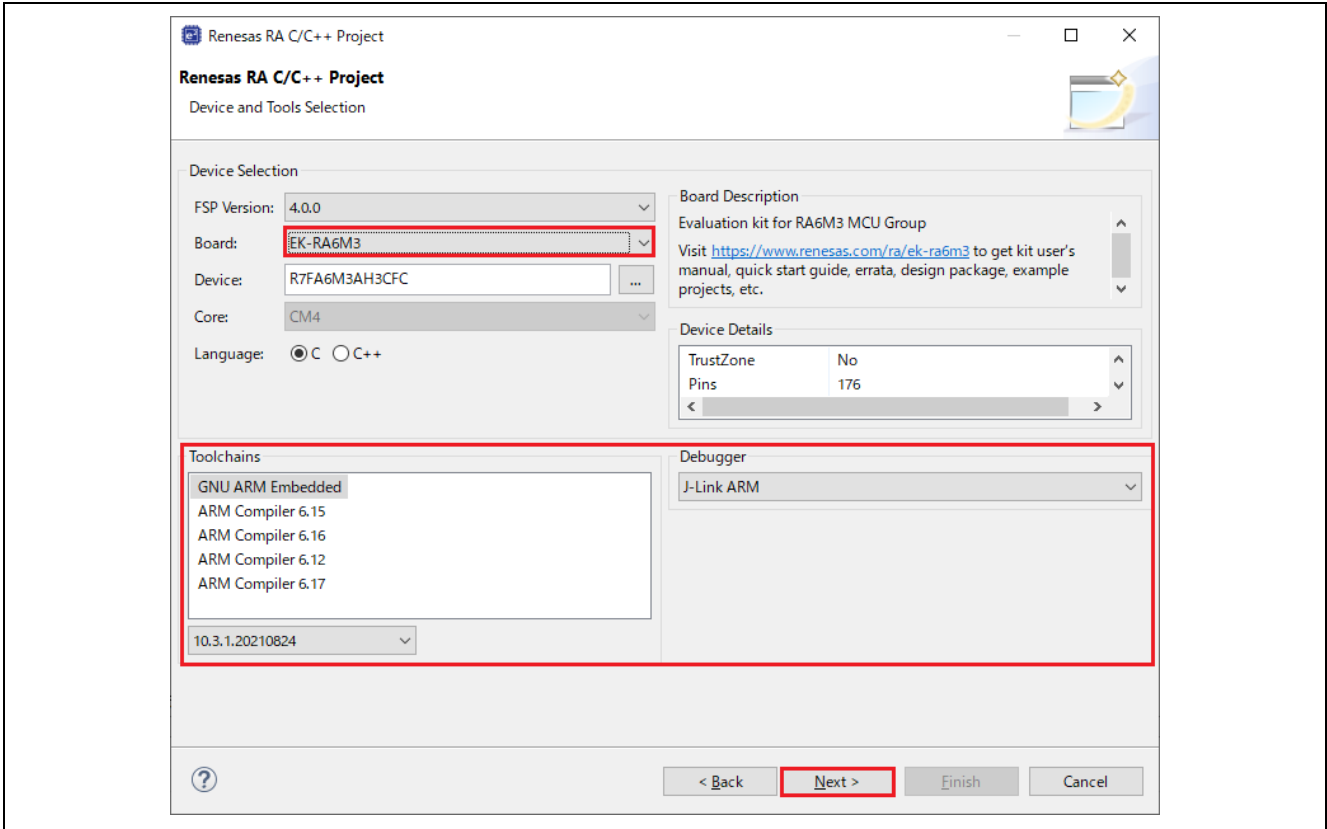

Figure 3-4. Project Generation – Device Selection

- 5. In the Build Artifact and RTOS Selection dialog, select:
  - **Build Artifact Selection:** Executable
  - **RTOS Selection:** No RTOS

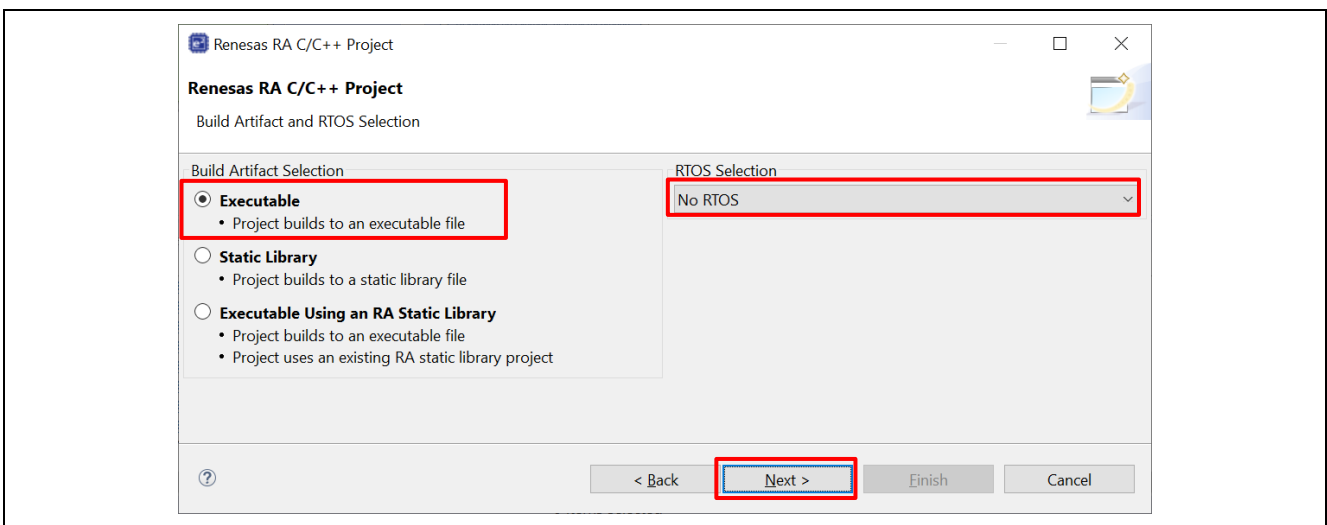
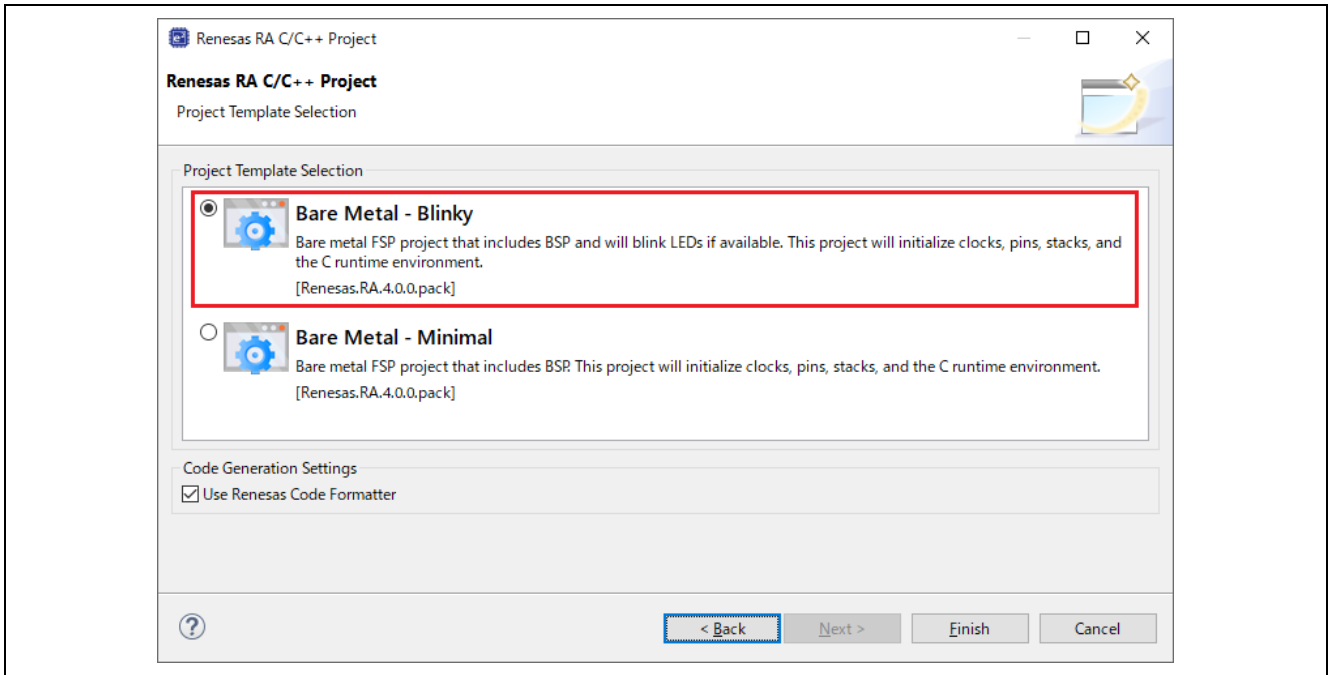

Figure 3-5. Artifact And RTOS Selection

6. In the Project Template Selection dialog, select a project template (for example, **Blinky**).



**Figure 3-6. Project Generation – Project Template**

7. Click the **Finish** button to create a new project.  
You may be prompted to open the **FSP Configuration** perspective. Click **Yes** to open the perspective. (In Eclipse, a 'perspective' is a predetermined arrangement of panes and views.)  
e<sup>2</sup> studio creates a new project with various views. Among them are the Project Explorer View, the RA Project Configuration Editor, and the Visualization View.

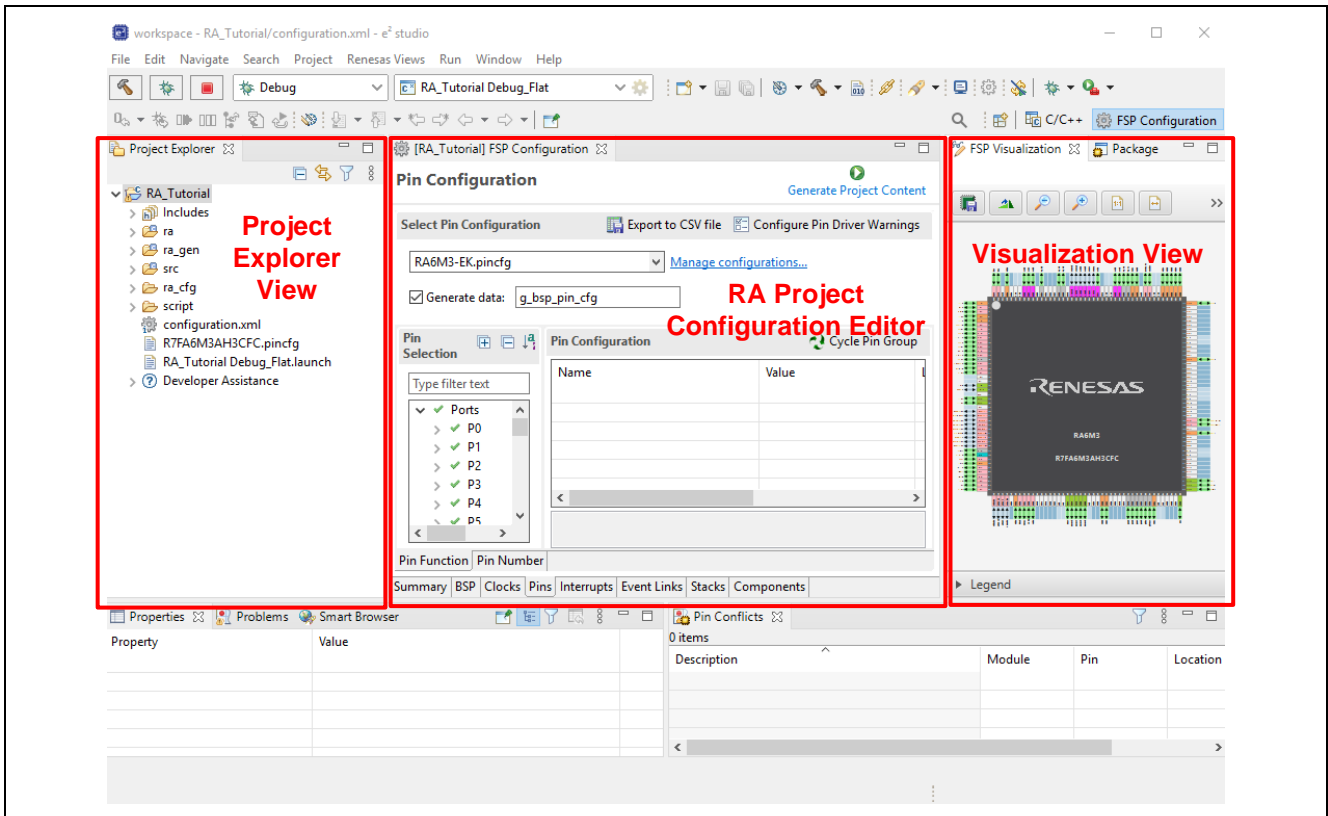

Figure 3-7. Project Generation – New Project Creation View

### 3.2 Generating a New RA Project for a TrustZone device

This section guides a user to generate an RA project for a TrustZone device. To generate a project for a non-TrustZone device, refer to section 3.1.

#### 3.2.1 Flat (Non-TrustZone) Project

To create a new Flat (Non-TrustZone) project, follow these steps:

1. From the menu, select **File** → **New** → **Renesas C/C++ Project** → **Renesas RA**.
2. Select **Renesas RA C/C++ Project** template. Click **Next** to continue.
3. In the project generation wizard, enter the following project information:
  - **Project name:** Enter a name (for example, **RA\_Flat**).
  - **Use default location:** Checked. If you want to create a project in a different location, uncheck this checkbox and enter a new location.
  - Click the **Next** button to continue.

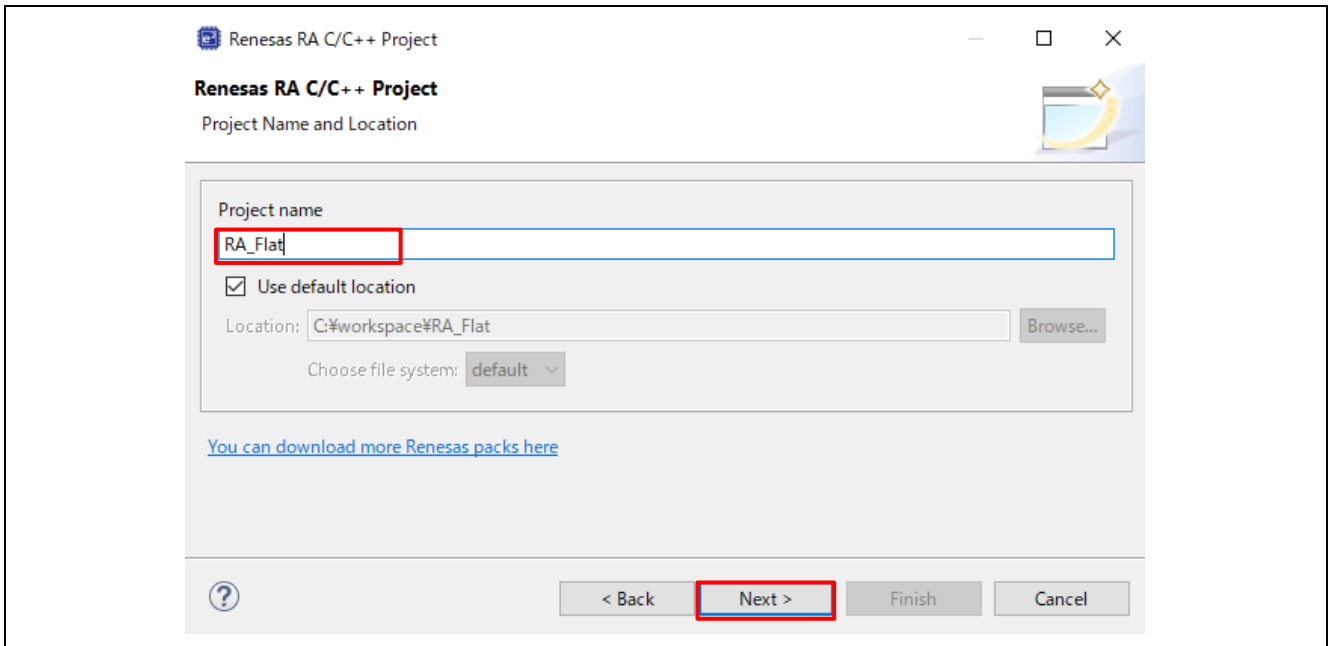

Figure 3-8. Project Generation – New RA Project Generation Wizard

4. In the device selection dialog, enter device and tool information:
  - **Board:** EK-RA6M4
  - **Toolchains:** Latest GNU Arm Embedded Toolchain approved for use with Renesas RA (for example, GCC ARM Embedded 10.3.1.20210824)
  - **Debugger:** J-Link (ARM)
  - Keep all other fields as default.
  - Click **Next** to continue.

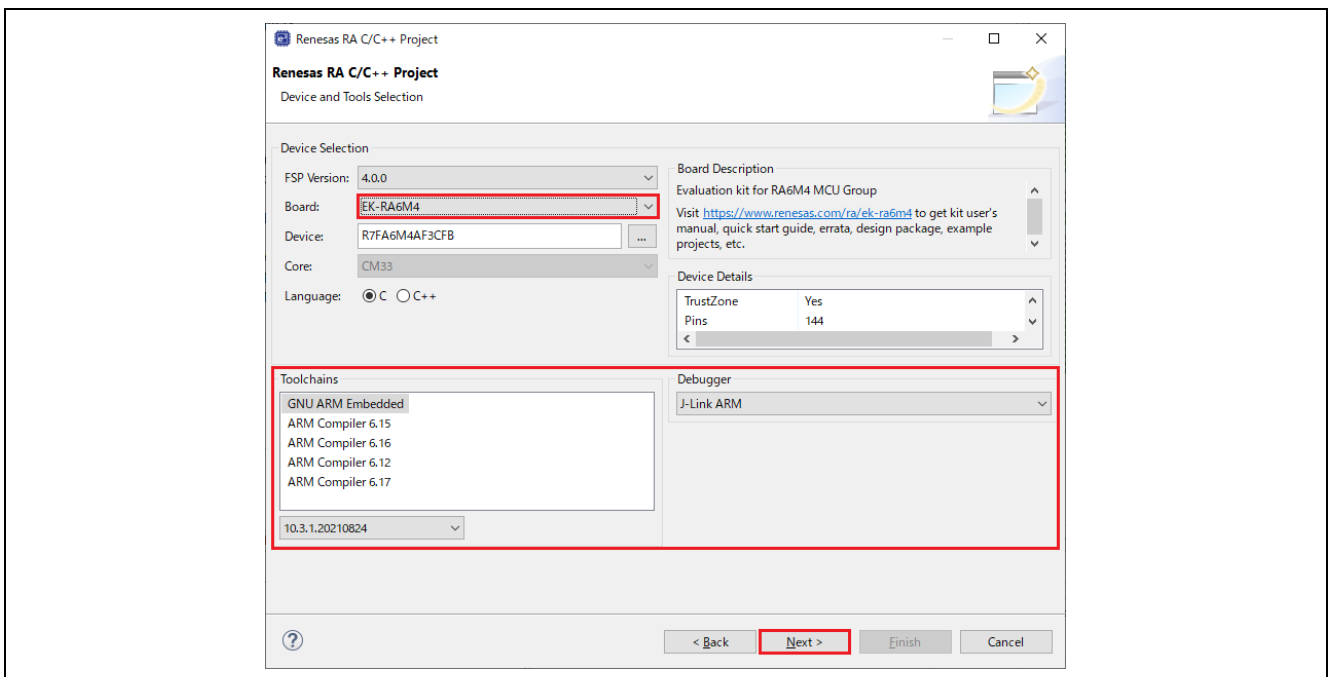

Figure 3-9. Project Generation – Device Selection

5. **Project Type Selection:** Flat (Non-TrustZone) Project

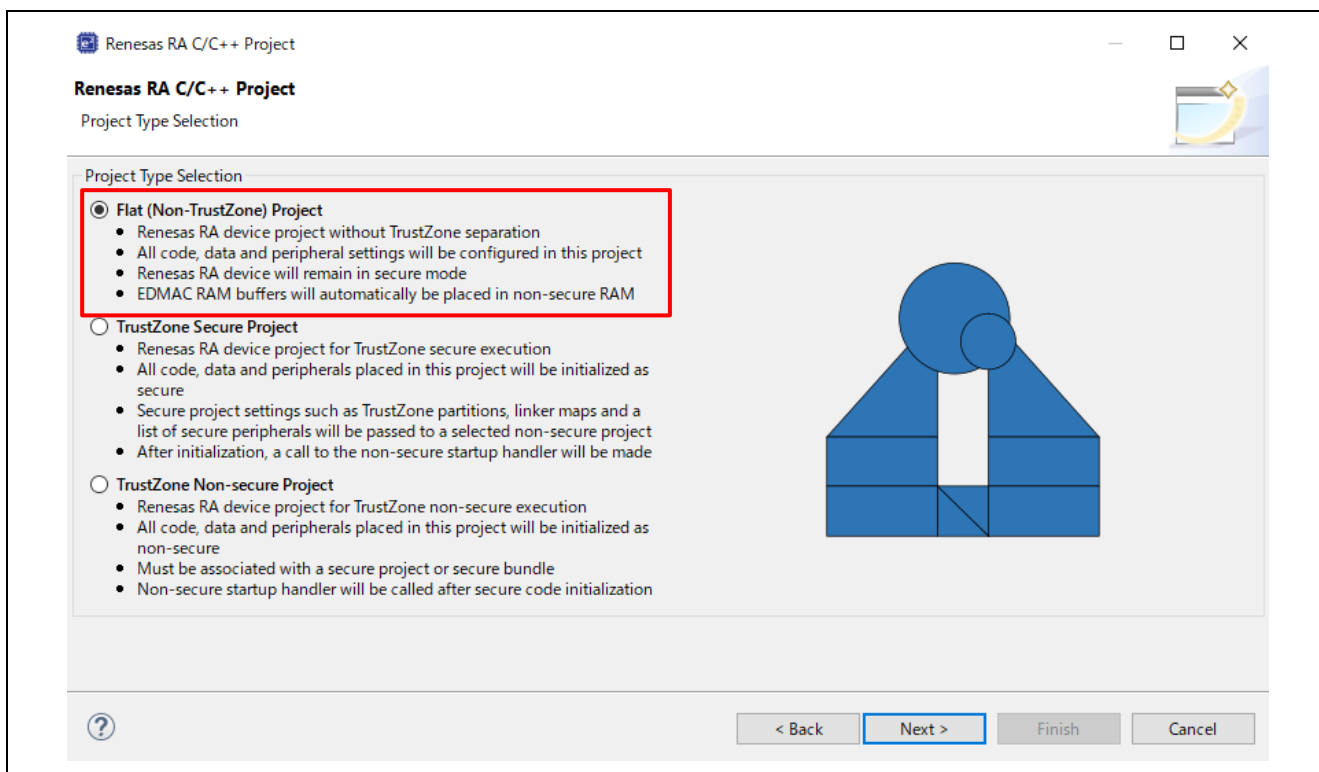

Figure 3-10. Project Type Selection

- In the Build Artifact and RTOS Selection dialog, select:
  - **Build Artifact Selection:** Executable
  - **RTOS Selection:** No RTOS

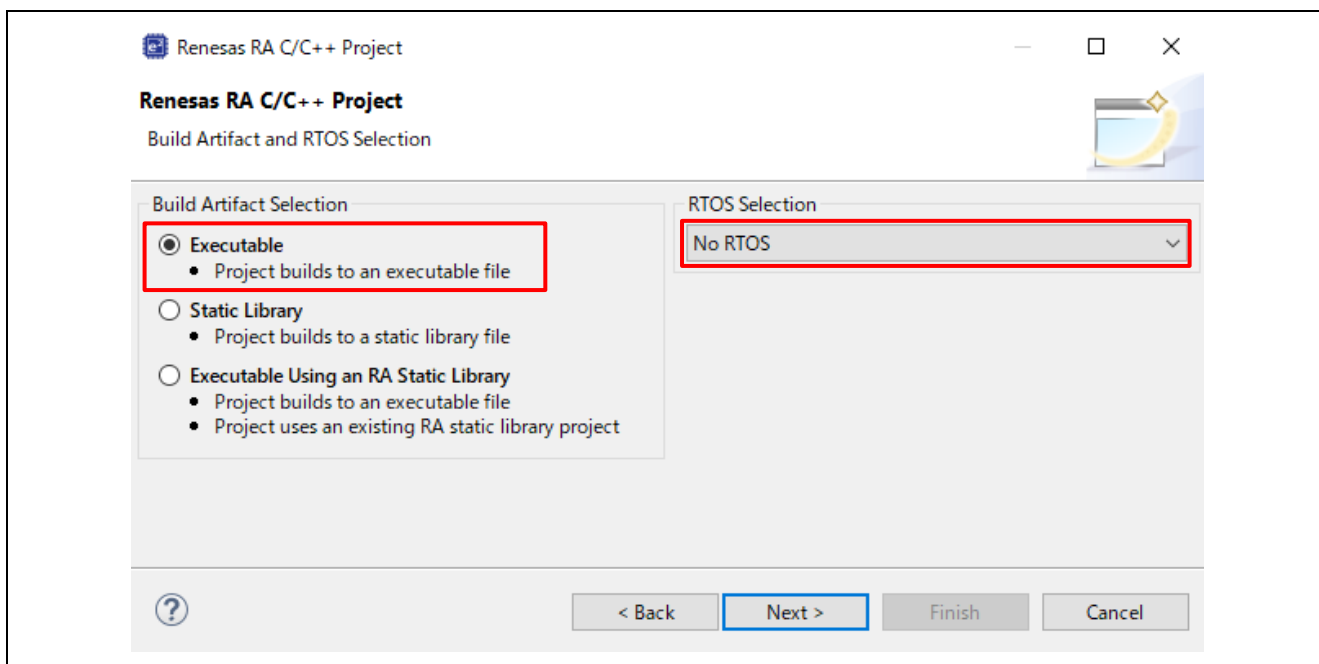

Figure 3-11. Artifact and RTOS Selection

- In the Project Template Selection dialog, select a project template (for example, **Blinky**).

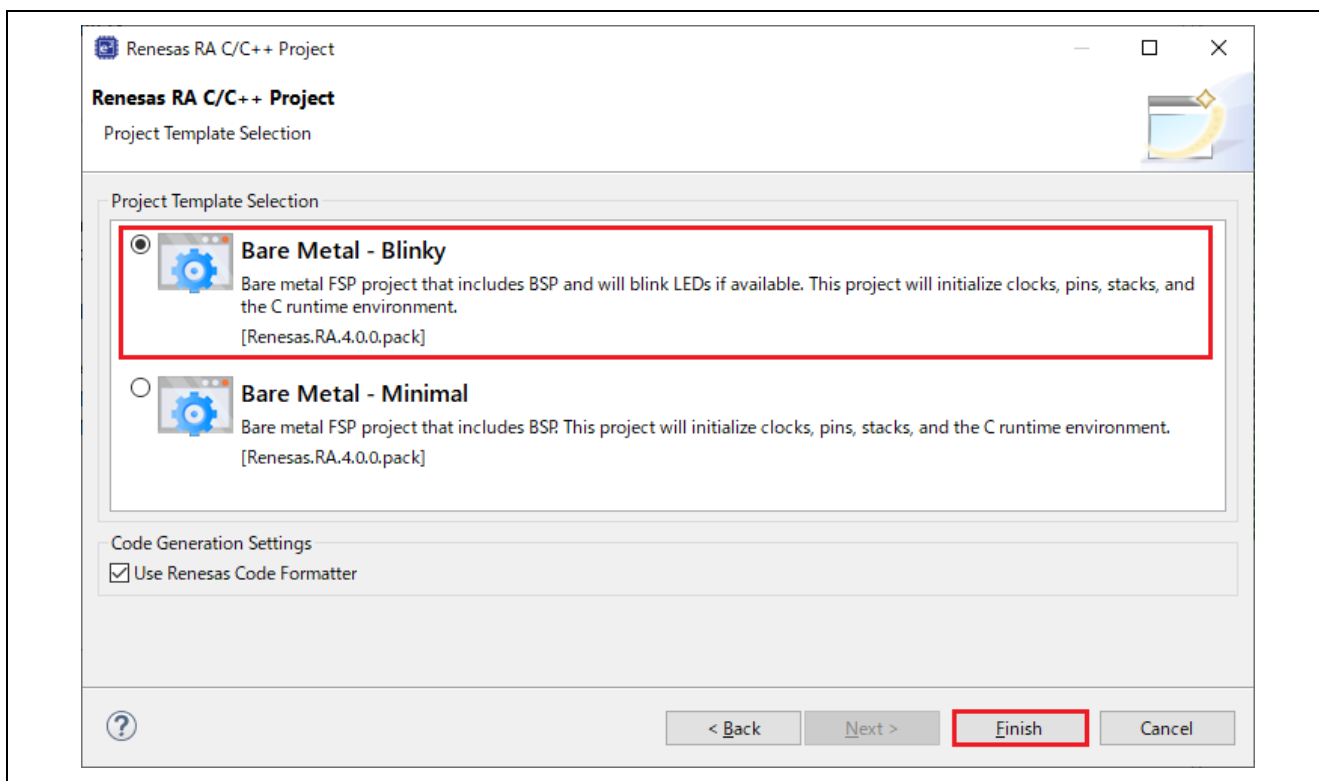

Figure 3-12. Project Generation – Project Template

8. Right-click on project name and select **Build Project**. Project is built without error.

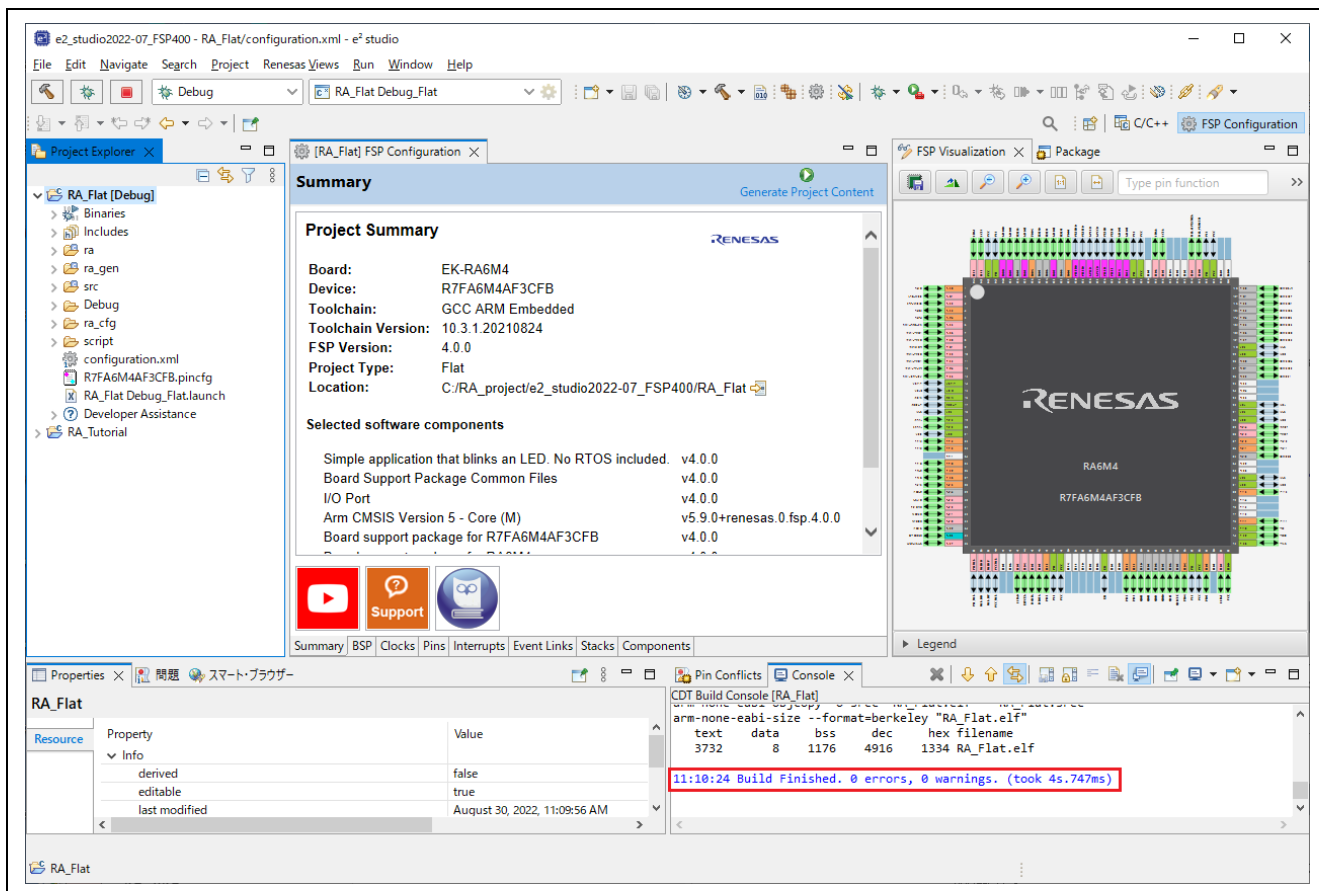
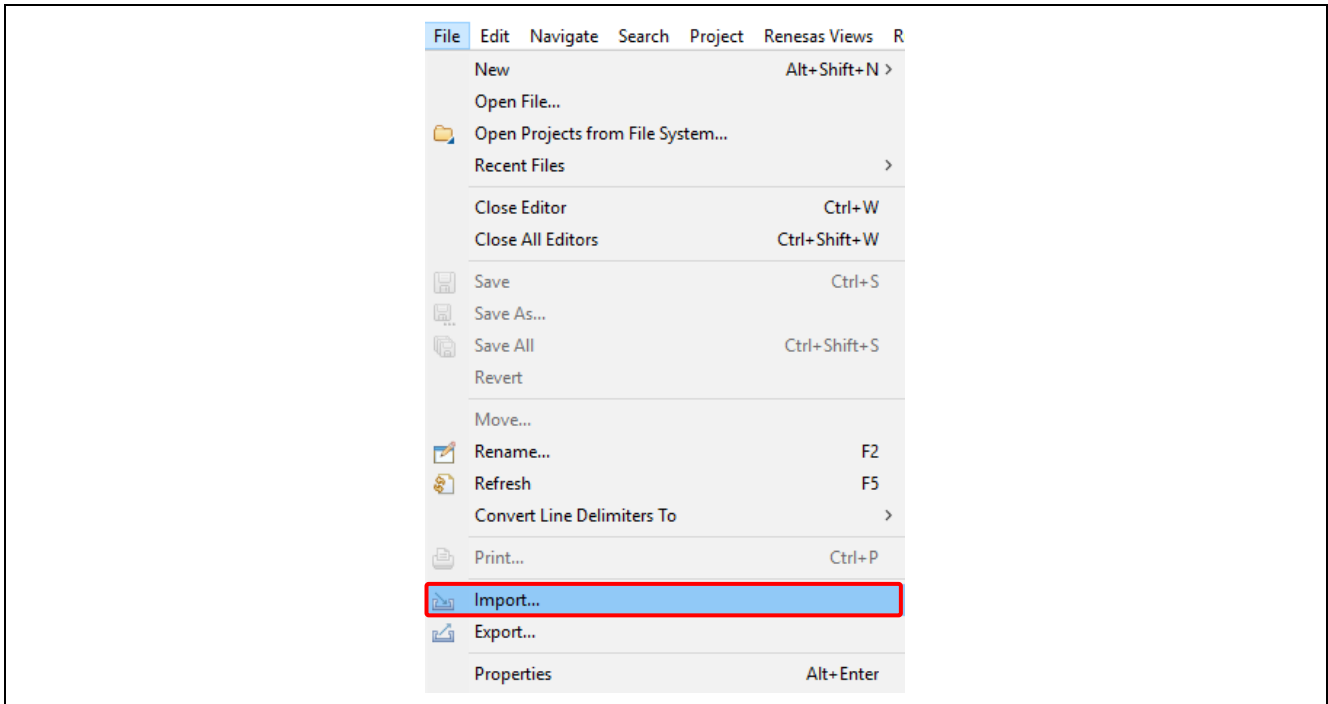

Figure 3-13. Project is Built Successfully

### 3.3 Importing an Existing RA Project

To import an existing RA Project, follow these steps:

1. Click **File** → **Import**.



**Figure 3-14. Import Project**

2. In the Import dialog, select **General** → **Existing Projects into Workspace**. Click **Next**.

Note: To rename the project to be imported, select **General** → **Rename & Import Existing Projects into Workspace** instead.

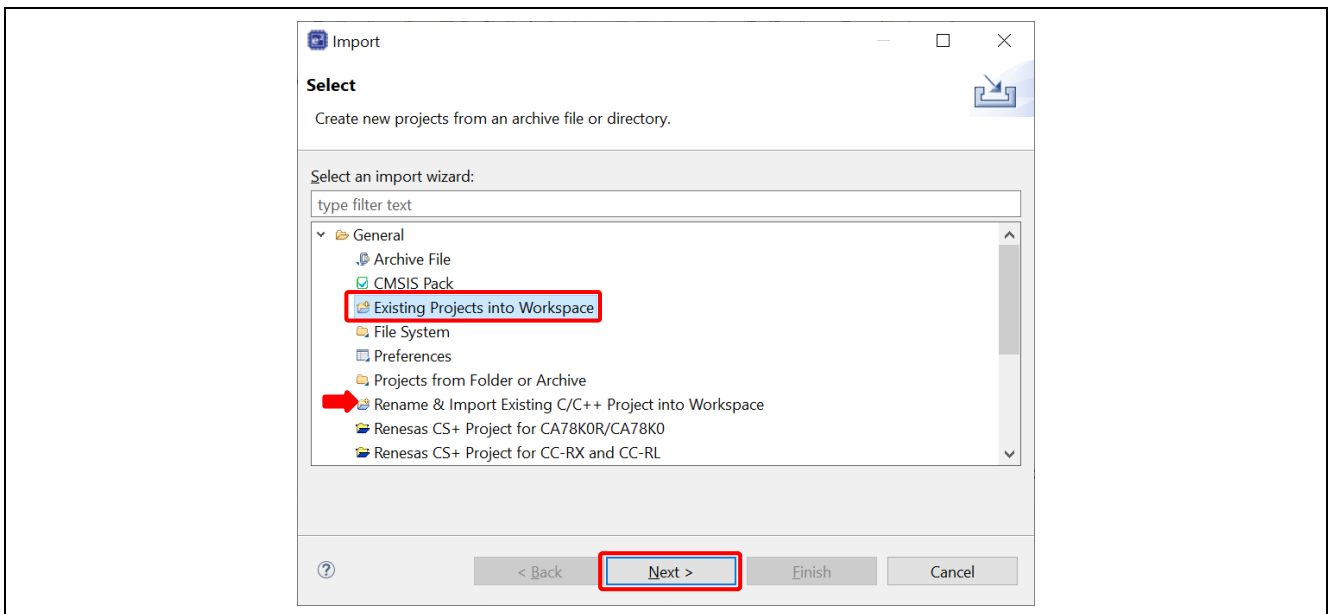

**Figure 3-15. Select Type Of Import**

3. In the **Import Projects** dialog, select **Select archive file:** then **Browse...** to browse to the compressed file (.zip) containing the project.

If the existing project is stored in a folder, use **Select root directory:** and browse to the folder containing the project.

4. Select the project to import and click **Finish**.

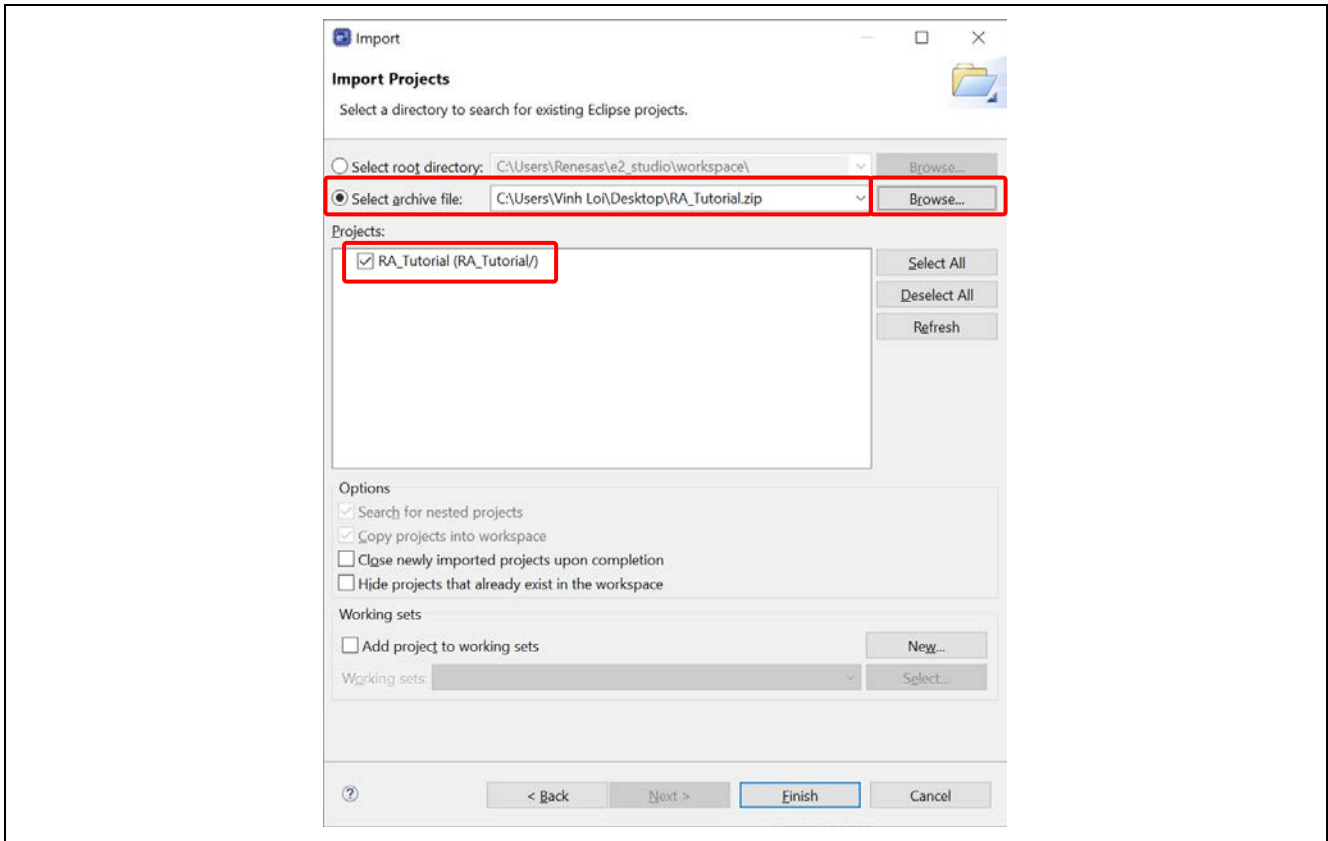

Figure 3-16. Select the Project in the Compressed File

5. The project is imported to e<sup>2</sup> studio.

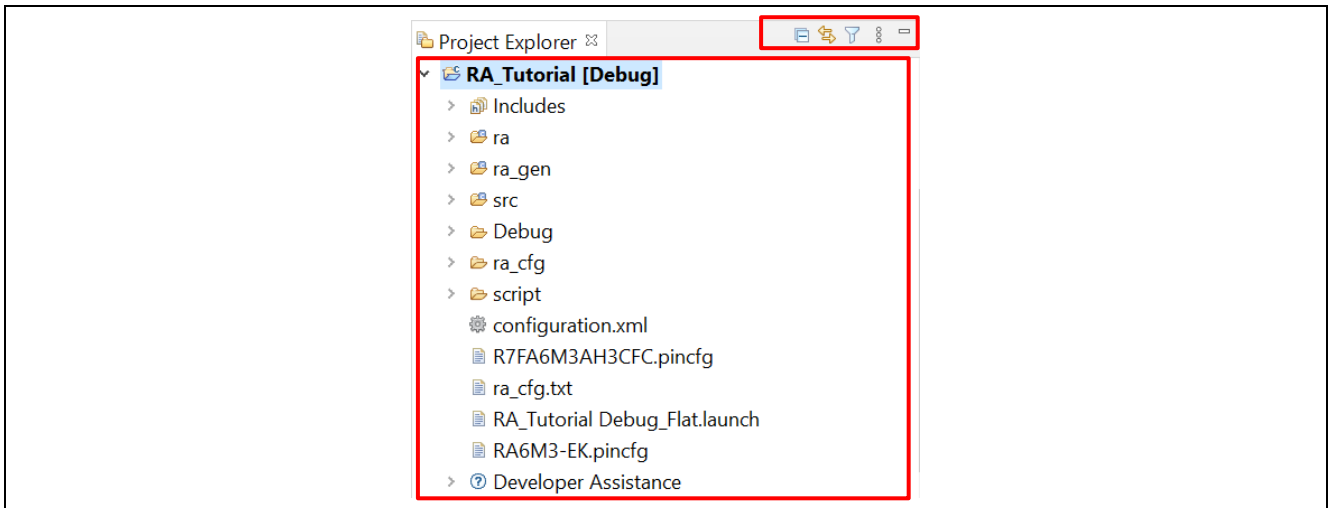

Figure 3-17. The Imported Project

### 3.4 Generating and Using a RA Static Library

This section describes how to generate a RA static library project and an executable project that references to the library project.



### 3.4.1 Creating the Static Library Project

The following steps show an example of how to create an RA static library project:

1. Select **File** → **New** → **Renesas C/C++ Project** → **Renesas RA**.
2. Select **Renesas RA C/C++ Project** template. Click **Next** to continue.

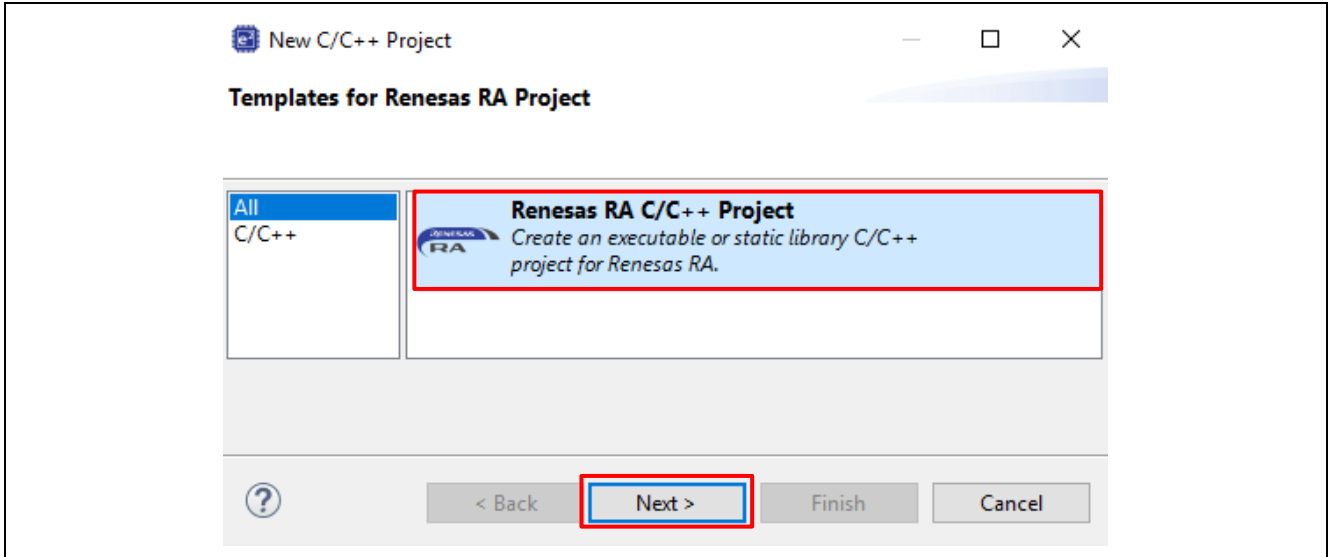

Figure 3-18. Project Generation – Select Library Project Template

3. In the Project Name and Location dialog, enter a name for the static library project (for example, **RA\_Lib**) and click **Next**.

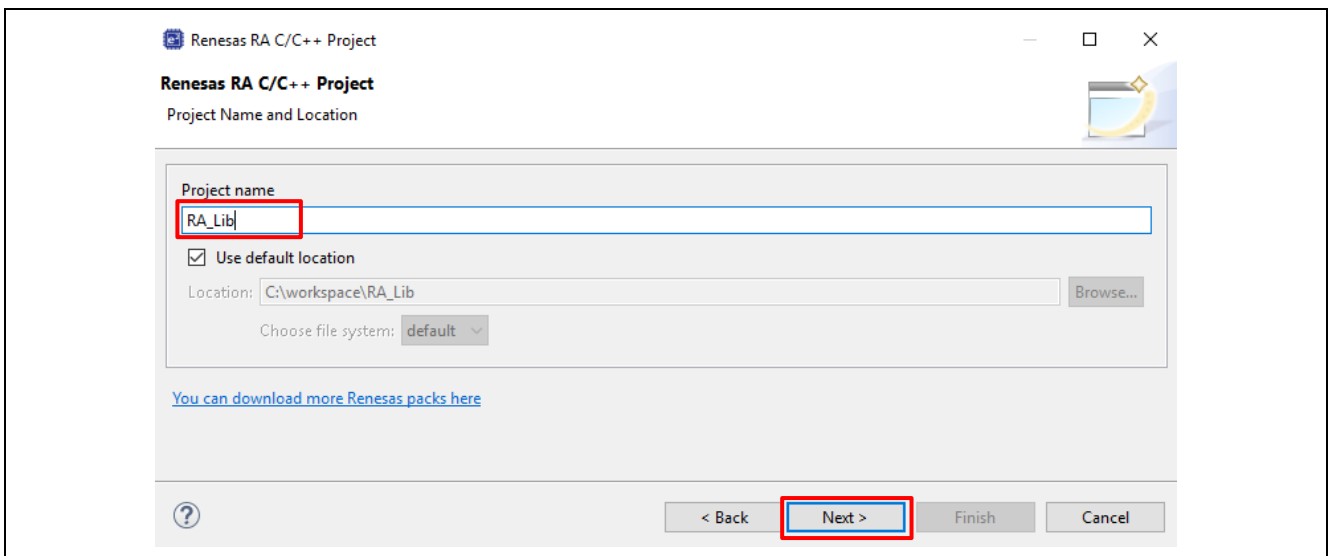

Figure 3-19. Library Project Configuration

4. In the Device and Tool Selection dialog, select a board (here we will use EK-RA6M3). Keep everything else as default and click **Next**.

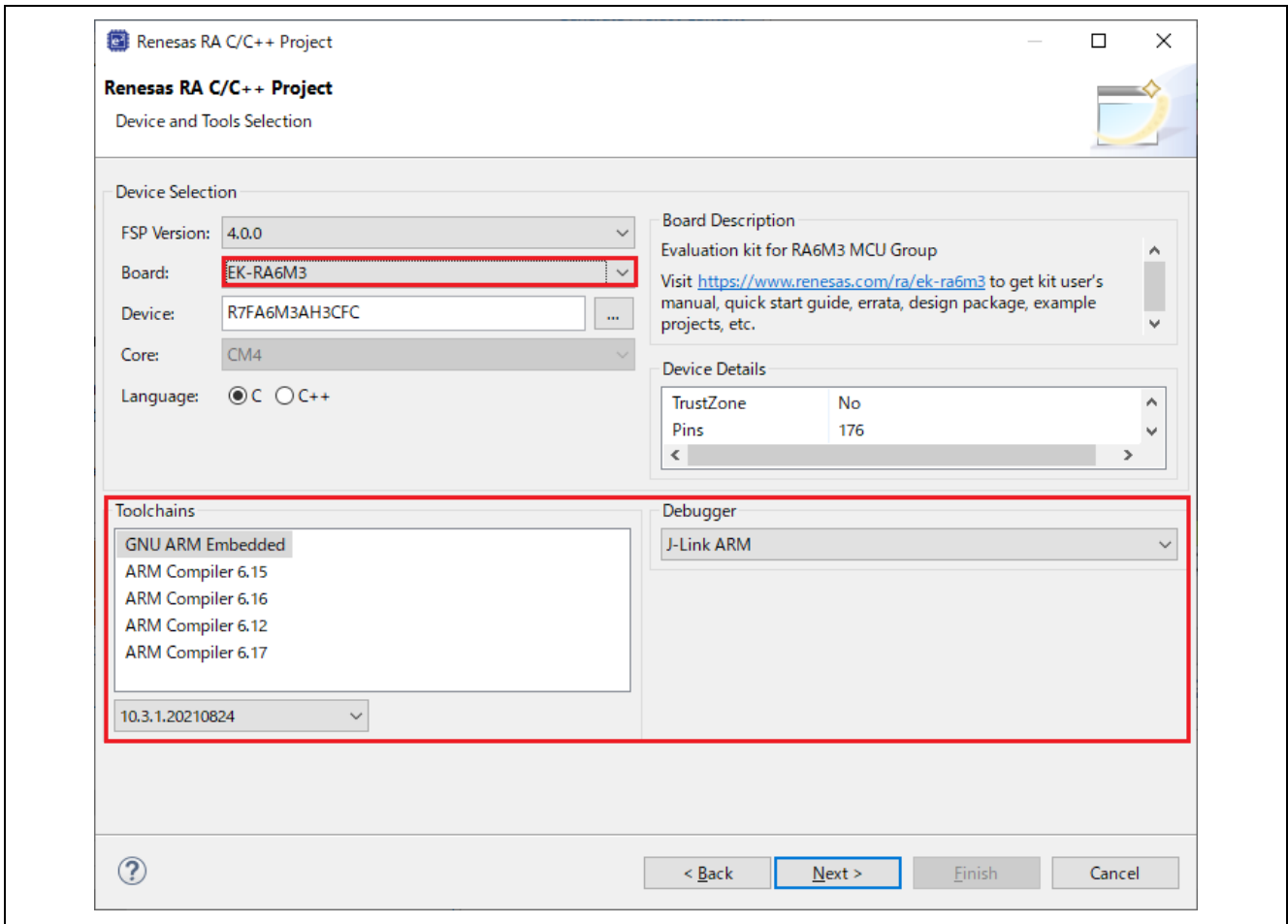

Figure 3-20. Select Device and Toolchain

- In the Build Artifact and RTOS Selection dialog, select:
  - Build Artifact and RTOS Selection:** Static Library
  - RTOS Selection:** No RTOS

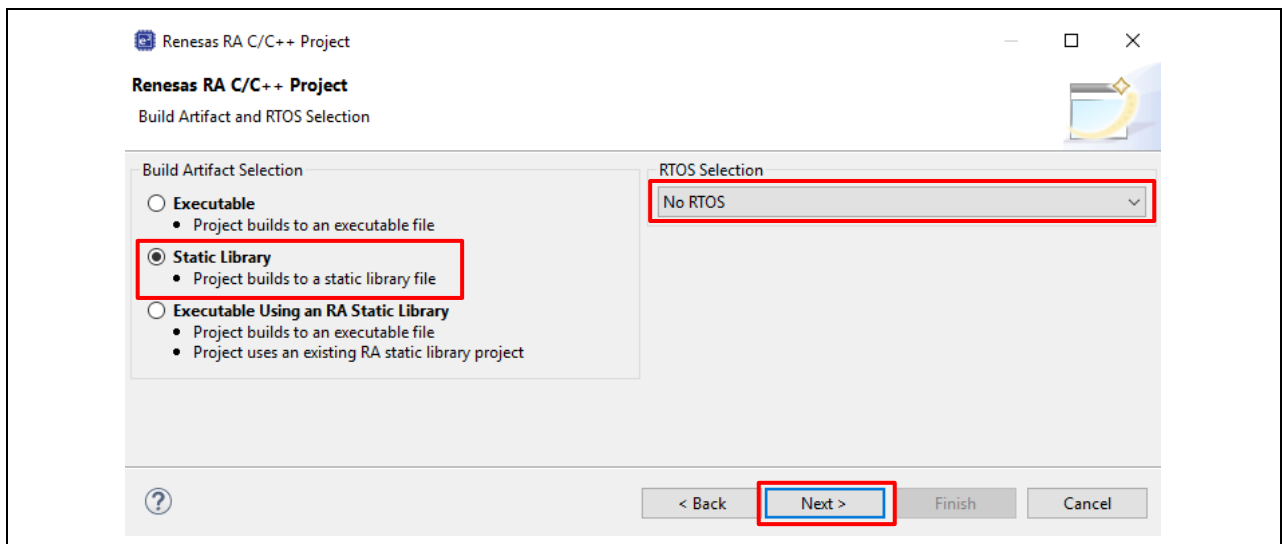

Figure 3-21. Artifact and RTOS Selection

- In the Project Template Selection dialog, select **Bare Metal - Blinky**, then click **Finish** to create the project.

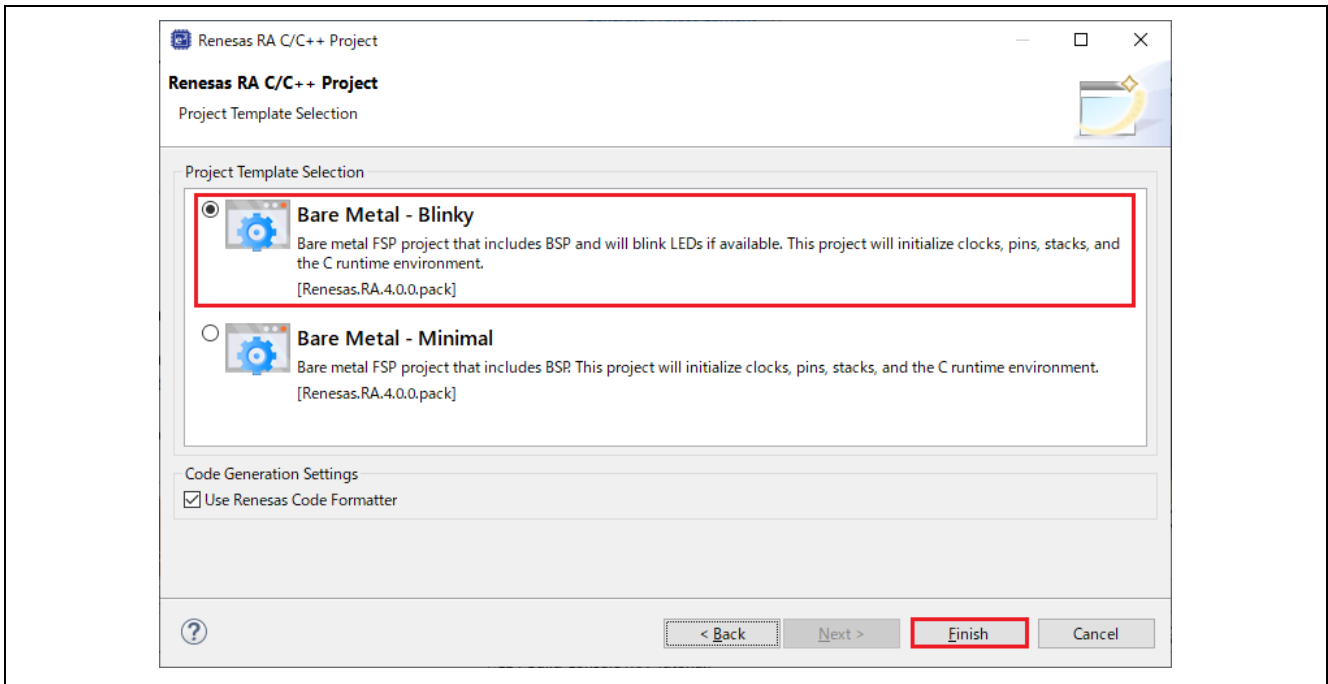

Figure 3-22. Select Project Template For Library

7. The e<sup>2</sup> studio IDE may prompt you to switch to FSP Configuration perspective. Click **Open Perspective** to open it.
8. Click **Generate Project Content**.

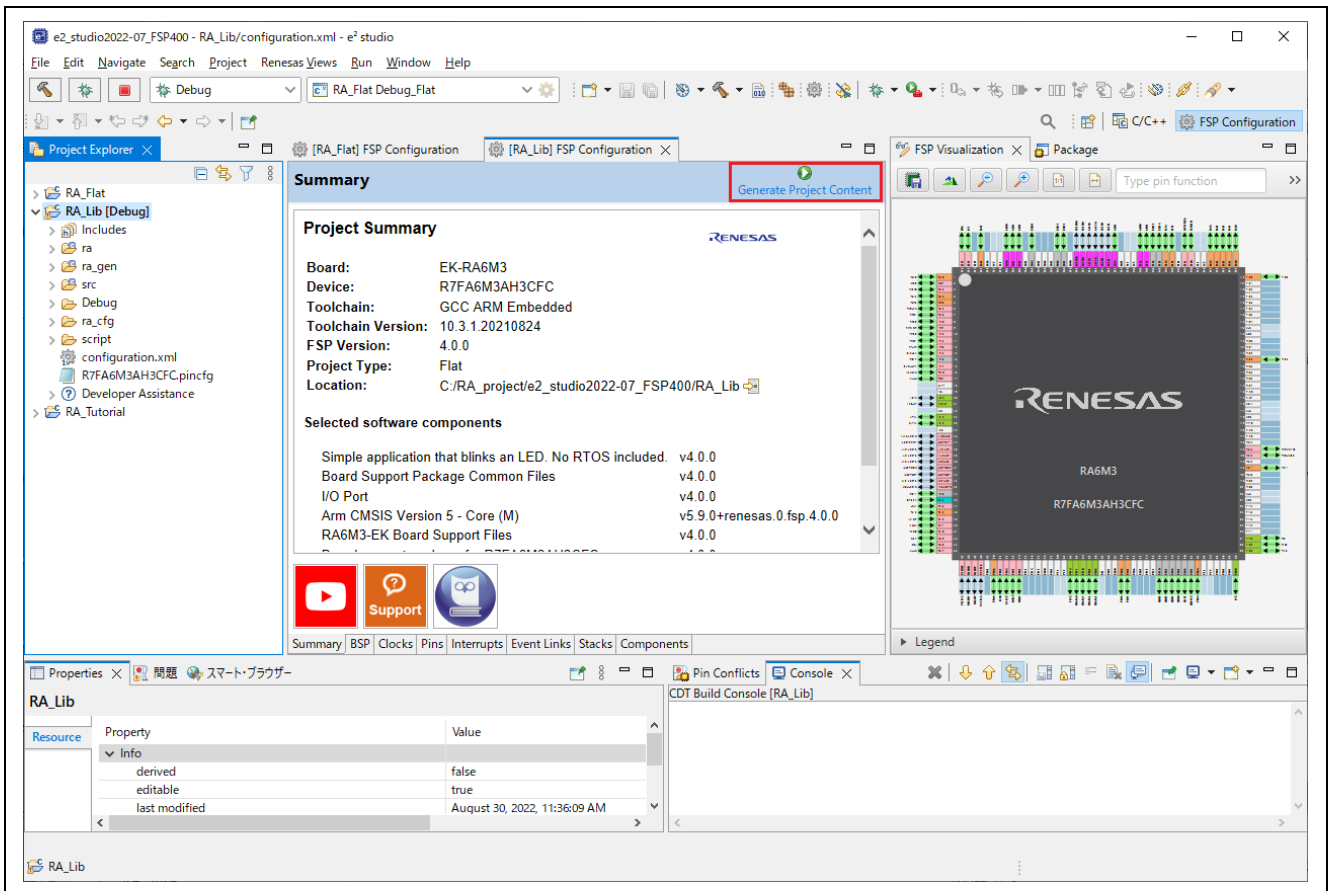

Figure 3-23. Generate Library Project Content

9. From the **Project Explorer** window, open `hal_entry.c` under `RA_Lib\src\`.

```

hal_entry.c
2      * Copyright [2020] Renesas Electronics Corporation and/or its affiliates. All rights reserved.
20
21      #include "hal_data.h"
22
23      void R_BSP_WarmStart(bsp_warm_start_event_t event);
24
25      extern bsp_leds_t g_bsp_leds;
26
27      /** @brief Blinky example application */
28
29      void hal_entry (void)
30      {
31      #if BSP_TZ_SECURE_BUILD
32          /* Enter non-secure code */
33          R_BSP_NonSecureEnter();
34      #endif
35
36          /* Define the units to be used with the software delay function */
37          const bsp_delay_units_t bsp_delay_units = BSP_DELAY_UNITS_MILLISECONDS;
38
39          /* Set the blink frequency (must be <= bsp_delay_units */
40          const uint32_t freq_in_hz = 2;
41
42          /* Calculate the delay in terms of bsp_delay_units */
43          const uint32_t delay = bsp_delay_units / freq_in_hz;
44
45
46
47
48

```

Figure 3-24. Old hal\_entry.c

10. Rename the function hal\_entry() to hal\_entry\_lib(), and add a declaration for hal\_entry\_lib().

```

hal_entry.c
2      * Copyright [2020] Renesas Electronics Corporation and/or its affiliates. All rights reserved.
20
21      #include "hal_data.h"
22
23      void R_BSP_WarmStart(bsp_warm_start_event_t event);
24      void hal_entry_lib();
25      extern bsp_leds_t g_bsp_leds;
26
27      /** @brief Blinky example application */
28
29      void hal_entry_lib (void)
30      {
31      #if BSP_TZ_SECURE_BUILD
32          /* Enter non-secure code */
33          R_BSP_NonSecureEnter();
34      #endif
35
36          /* Define the units to be used with the software delay function */
37          const bsp_delay_units_t bsp_delay_units = BSP_DELAY_UNITS_MILLISECONDS;
38
39          /* Set the blink frequency (must be <= bsp_delay_units */
40          const uint32_t freq_in_hz = 2;
41
42          /* Calculate the delay in terms of bsp_delay_units */
43          const uint32_t delay = bsp_delay_units / freq_in_hz;
44
45
46
47
48

```

Figure 3-25. New hal\_entry.c

11. Build the Library Project. The build outputs a static library file libRA\_Lib.a.

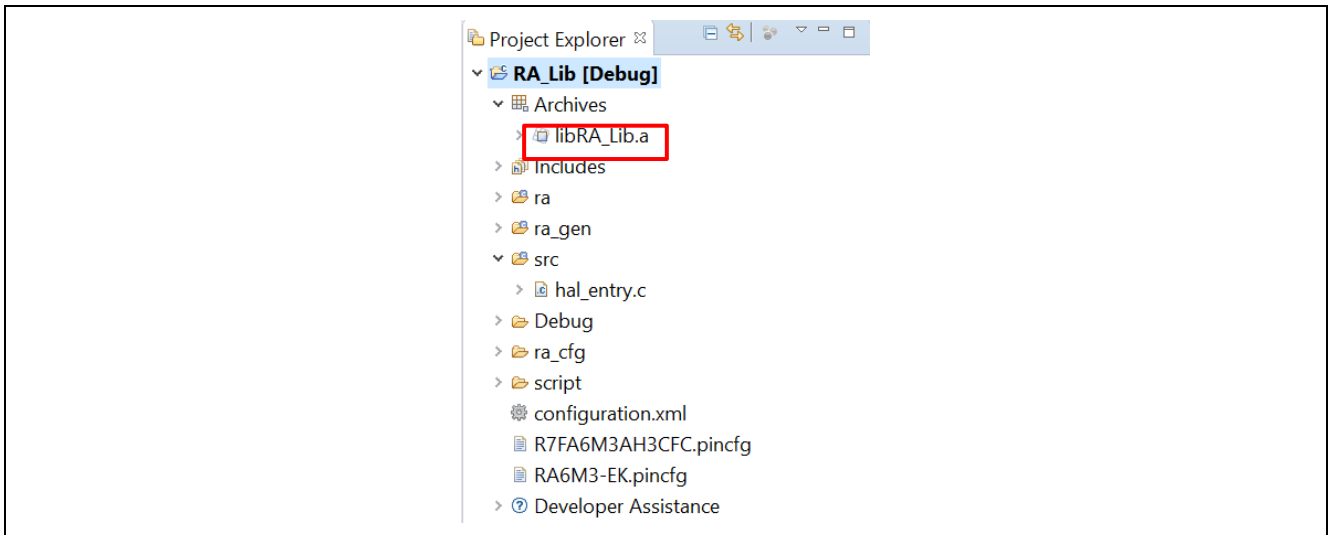

Figure 3-26. The Built Static Library

### 3.4.2 Using Static Library in Executable Project

This section shows how to use the static library created in the previous section (3.4.1) in an RA executable project by performing the following steps:

- Create an RA C executable project.
- Modify the source code to call a function “hal\_entry\_lib()” declared in the static library project.
- Build and run the RA C executable project.

Perform the following steps:

1. Select **File** → **New** → **Renesas C/C++ Project** → **Renesas RA**.
2. Select **Renesas RA C/C++ Project** template. Click **Next** to continue.
3. Enter project name: **RA\_App** and click **Next** to continue.
4. In the Device and Tool Selection dialog, select a board (here we'll use EK-RA6M3). Keep everything else as default and click **Next**.
5. On the Build Artifact and RTOS Selection page, select **Executable**. In RTOS selection, select **No RTOS**. Click **Next**.

Note: On the Build Artifact and RTOS Selection page, **Executable Using an RA Static Library** is unavailable.

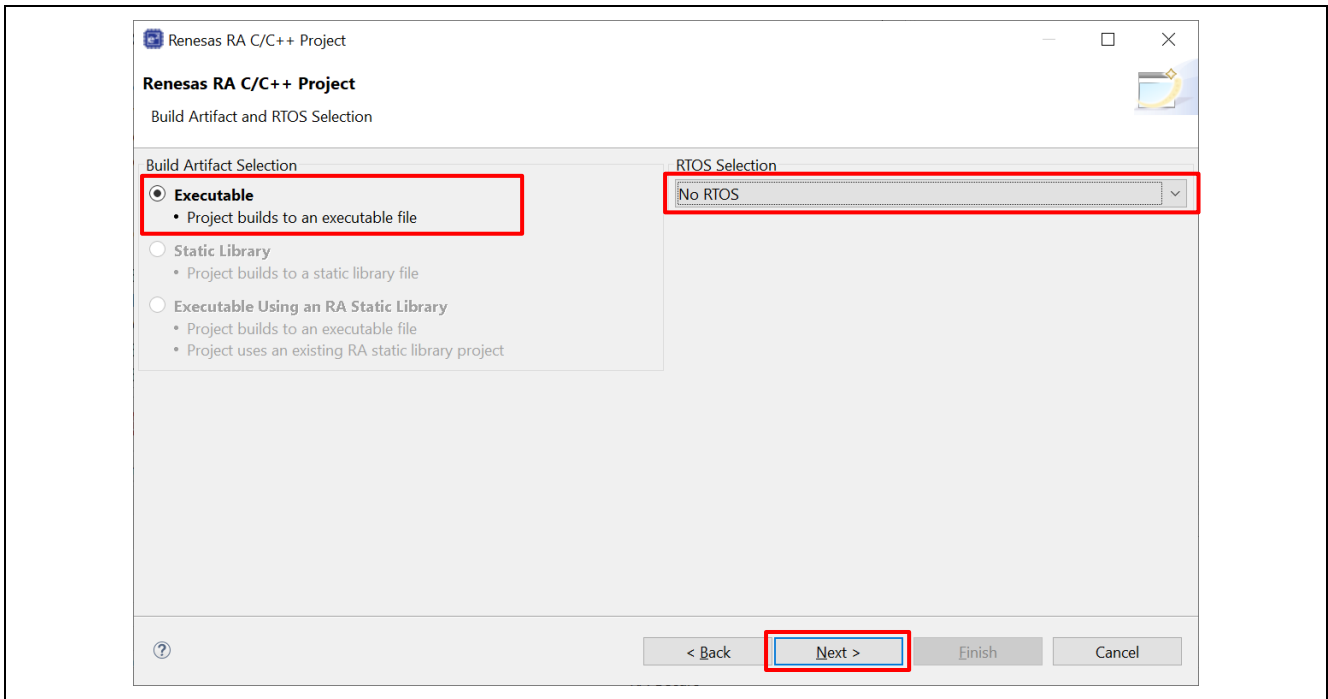

Figure 3-27. Artifact and RTOS Selection

6. In the Project Template Selection dialog, select **Bare Metal - Minimal**. Click the **Finish** button to create project.

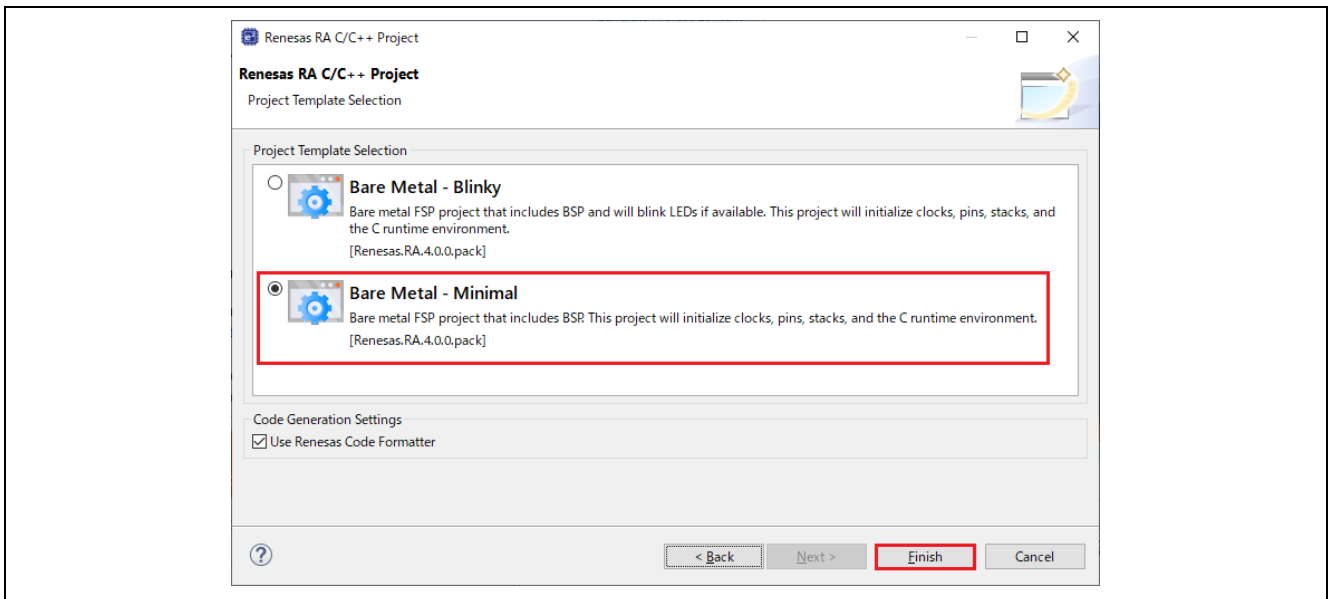

Figure 3-28. Project Generation – Project Template

7. Add the Existing RA Library.  
Settings the Project Properties.

- Select and add **Settings** → **Libraries** → **Libraries (-I)**  → **RA\_Lib**
- Select and add **Settings** → **Libraries** → **Libraries search path (-L)**  → **"\${workspace\_loc}/RA\_Lib/Debug"**
- Select **Apply and Close**.

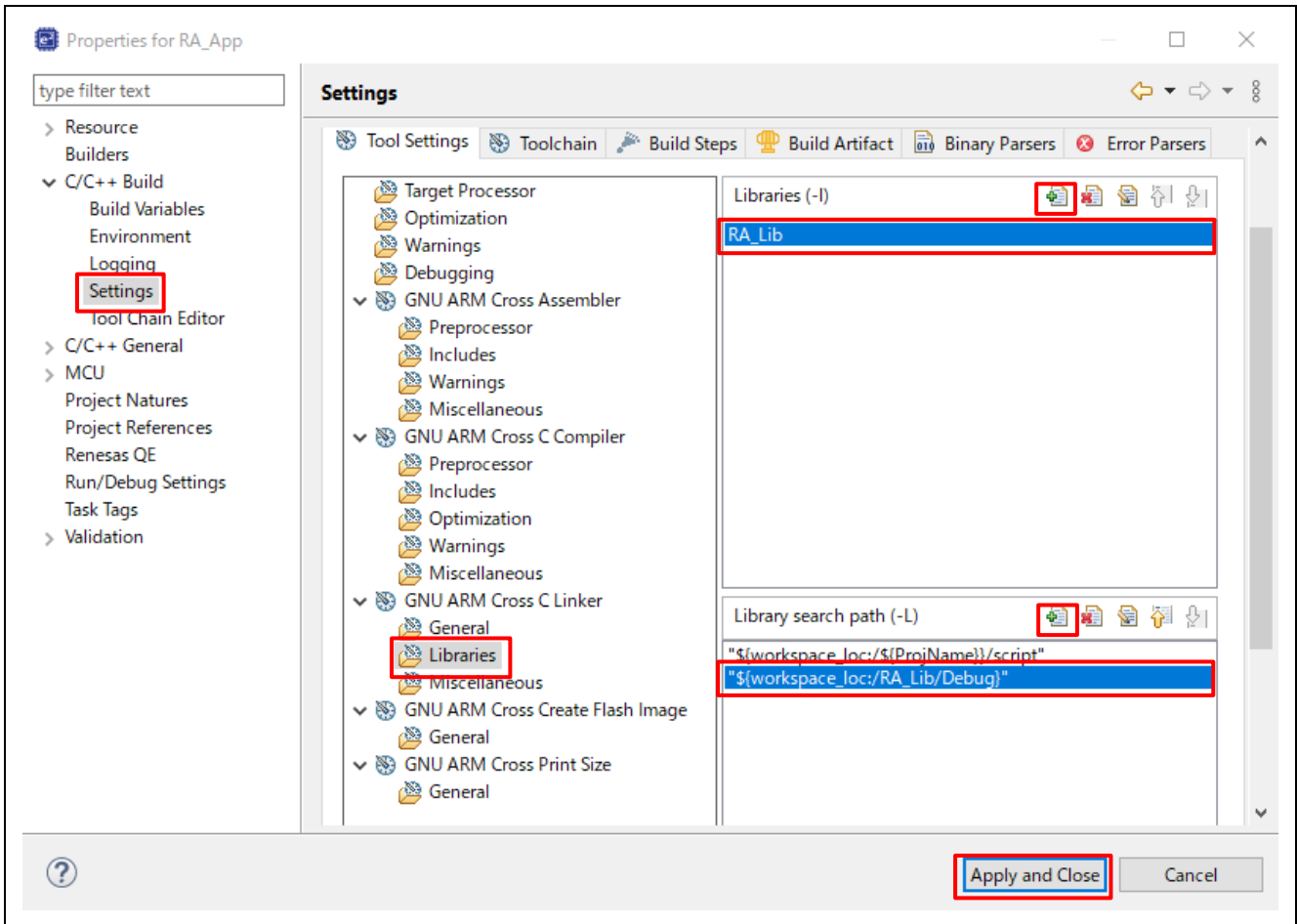

Figure 3-29. Settings the Project Properties

8. From the **Project Explorer** window, open `hal_entry.c` under `RA_App\src\`.

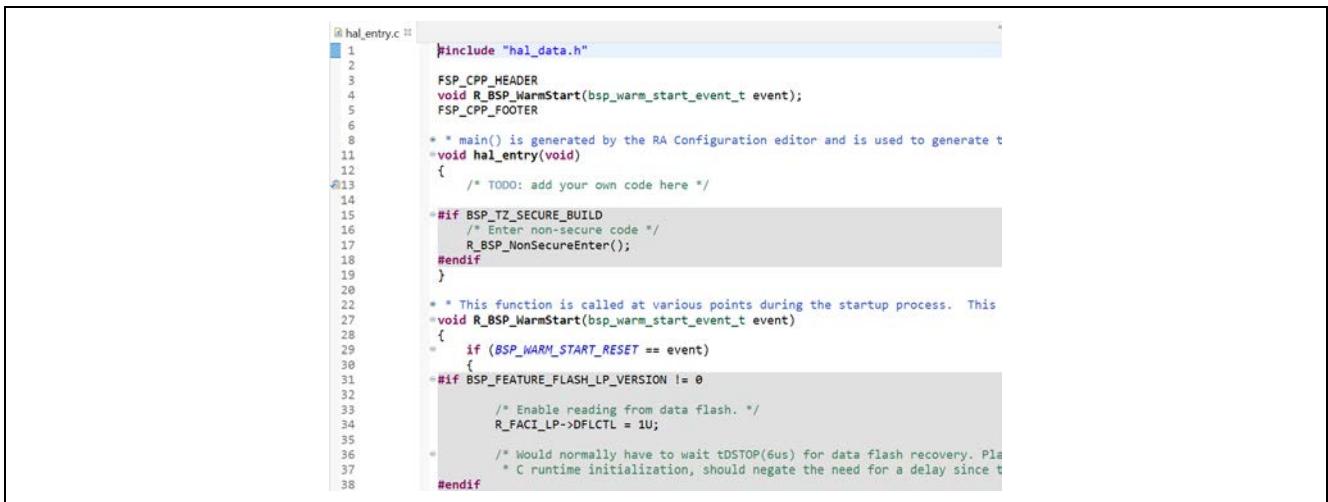

Figure 3-30. Old hal\_entry.c

9. Remove function “R\_BSP\_WarmStart()” and its declaration.
10. Add codes to call the LED blinking library function “hal\_entry\_lib()” in the “hal\_entry()” function and add a declaration for the library function.

```

hal_entry.c
1  #include "hal_data.h"
2
3  FSP_CPP_HEADER
4  extern void hal_entry_lib();
5  FSP_CPP_FOOTER
6
7
8  /* * main() is generated by the RA Configuration editor and is used to generate t
11 void hal_entry(void)
12 {
13     /* TODO: add your own code here */
14     hal_entry_lib();
15     #if BSP_TZ_SECURE_BUILD
16     /* Enter non-secure code */
17     R_BSP_NonSecureEnter();
18     #endif
19 }
20
21
22 #if BSP_TZ_SECURE_BUILD
23
24 BSP_CMSE_NONSECURE_ENTRY void template_nonsecure_callable ();
25
26 /* Trustzone Secure Projects require at least one nonsecure callable function
27 BSP_CMSE_NONSECURE_ENTRY void template_nonsecure_callable ()
28 {
29 }
30 #endif
31
32
    
```

Figure 3-31. New hal\_entry.c

11. Build the application project.
12. Set a breakpoint where the library function “hal\_entry\_lib()” is called. Run the RA\_App project. When the program stops at the breakpoint, resume it. Confirm that the library function which blinks the LEDs (for example, “hal\_entry\_lib()”) is executed.

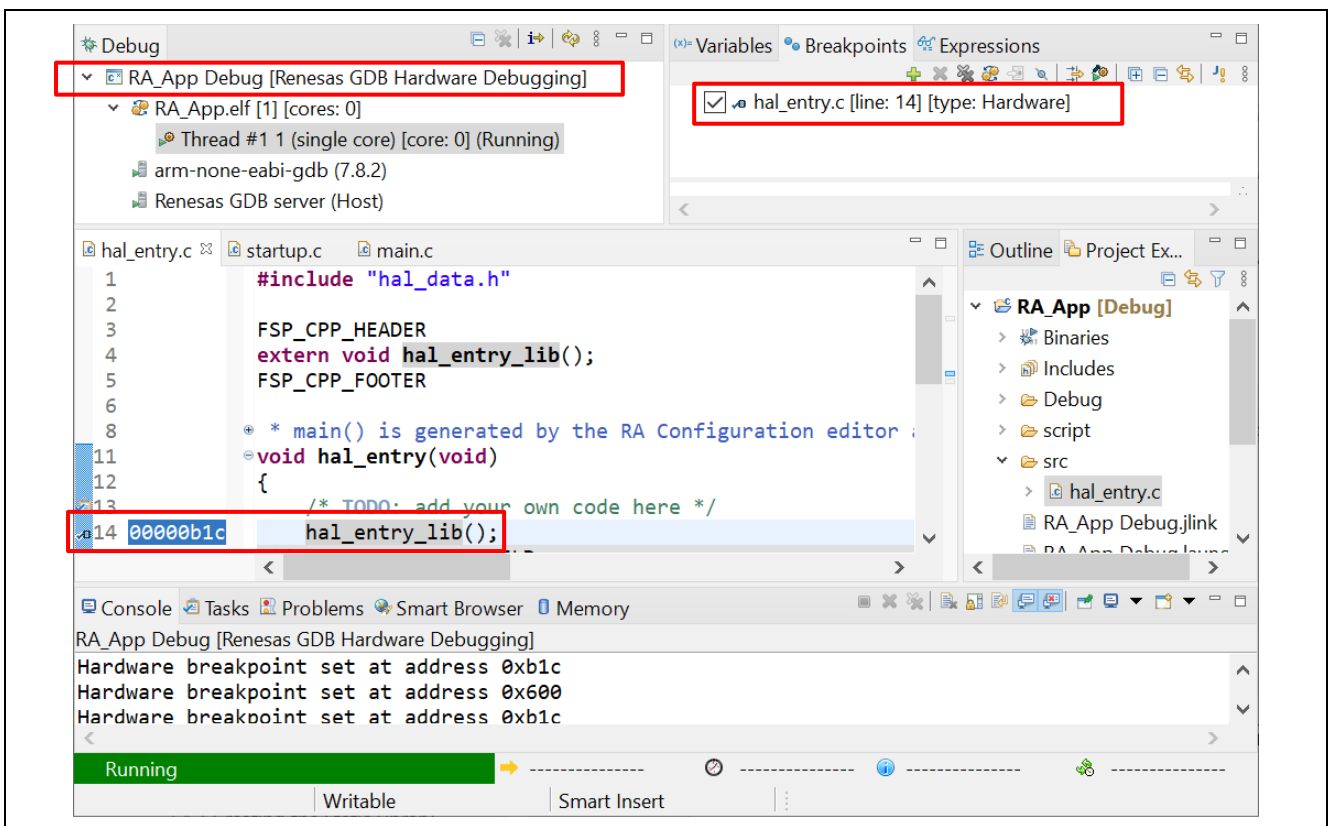

Figure 3-32. Application Project Executing Library Function



### 3.5 RA Project Configuration Editor

The RA Project Configuration editor view displays the current project configuration settings. The settings are saved in the file “configuration.xml”. The project configuration settings are grouped into multiple pages that allow you to set several configurable aspects of the project such as how pins and clocks are set up and which drivers are included. Drivers can range from simple hardware-level drivers to RTOS-aware applications. Multi-thread specific components like mutexes, semaphores, and events can be configured.

To edit the project configuration, make sure that the FSP Configuration perspective is selected in the upper right-hand corner of the e<sup>2</sup> studio window or click **Window** → **[Perspective]** → **[Open Perspective]** → **Other...** → **[FSP Configuration]** and the “configuration.xml” file is opened.

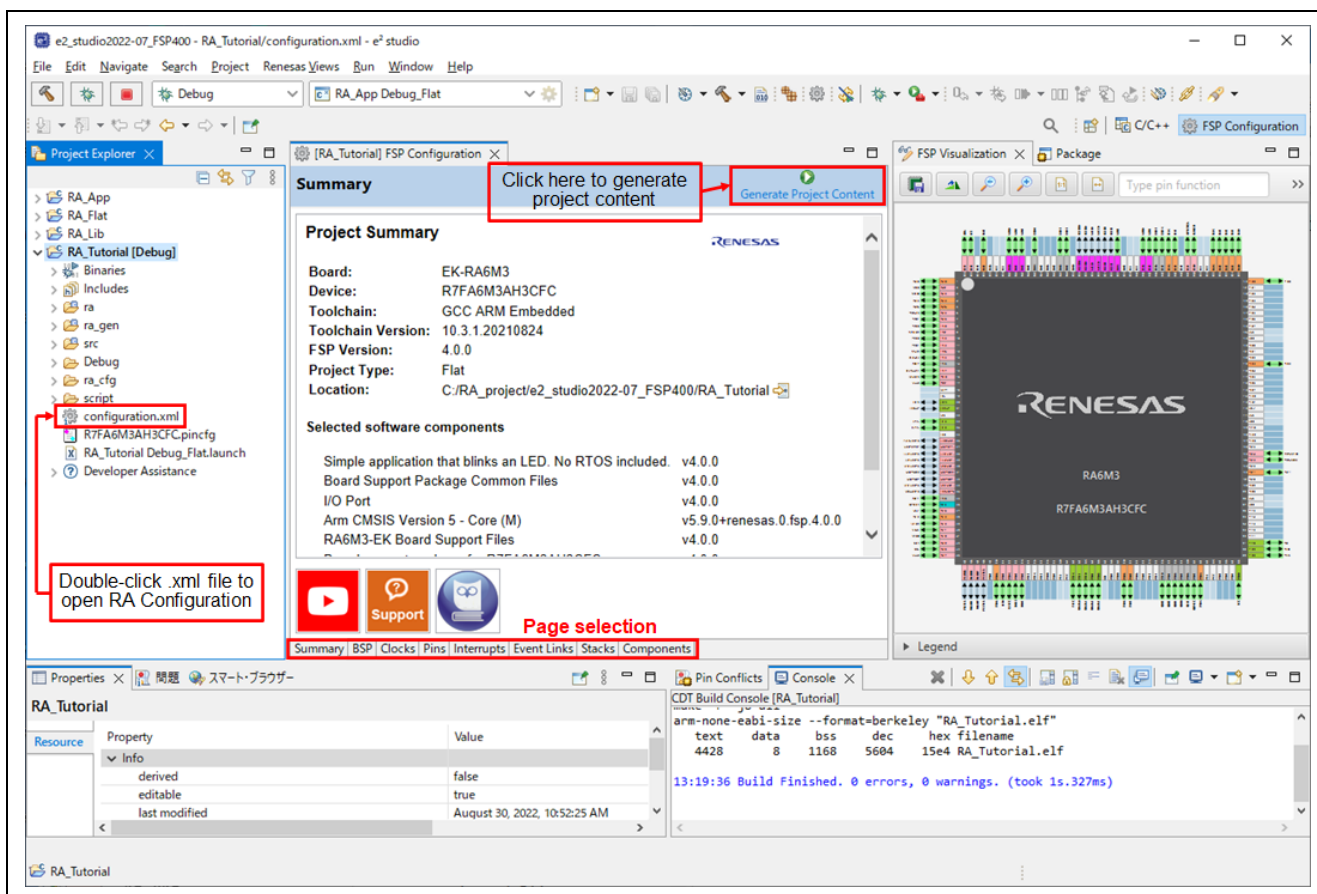

Figure 3-33. RA Project Configuration – RA Project Configuration View

There are 8 pages (or tabs) in RA Project Configuration editor.

The **Summary** page contains a project-specific summary information.

The **BSP** page allows you to select the FSP version, the type of RA board, and the device.

The configuration steps and options for the **Clocks**, **Pins**, **Interrupts**, **Event Links**, **Stacks**, and **Components** pages are discussed in the following sections.

#### 3.5.1 Summary Page

The **Summary** page contains a project-specific summary which includes details of the currently selected device, board, and RA software components. There are also useful links to the ‘Renesas Presents’ YouTube channel and the FSP user manual.

If you add new threads and modules/objects to a thread, this information will be also shown in the **Summary** page.

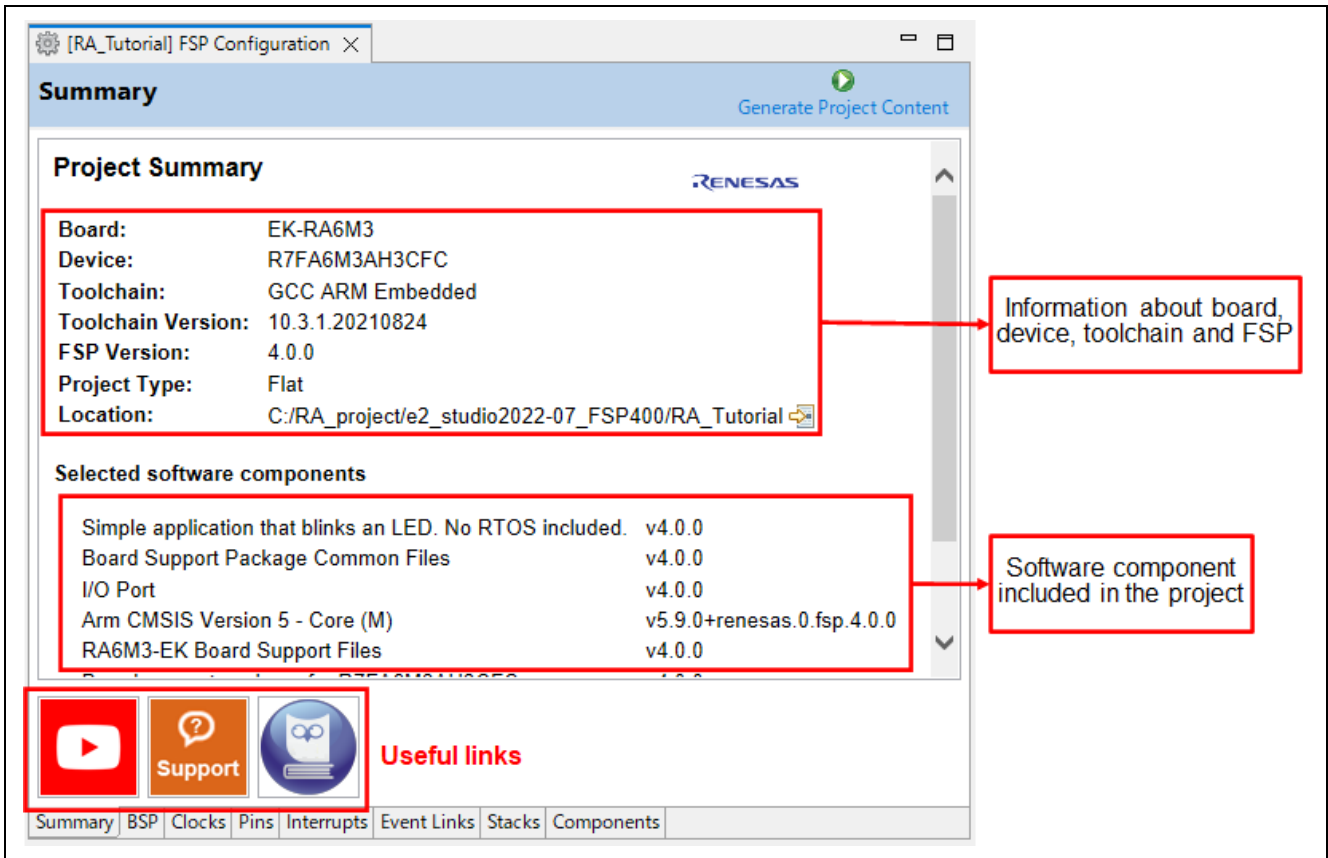

Figure 3-34. Summary Page

### 3.5.2 BSP Page

The **BSP** Page allows you to select the FSP version, board, and device. You can also import the CMSIS board information from this page.

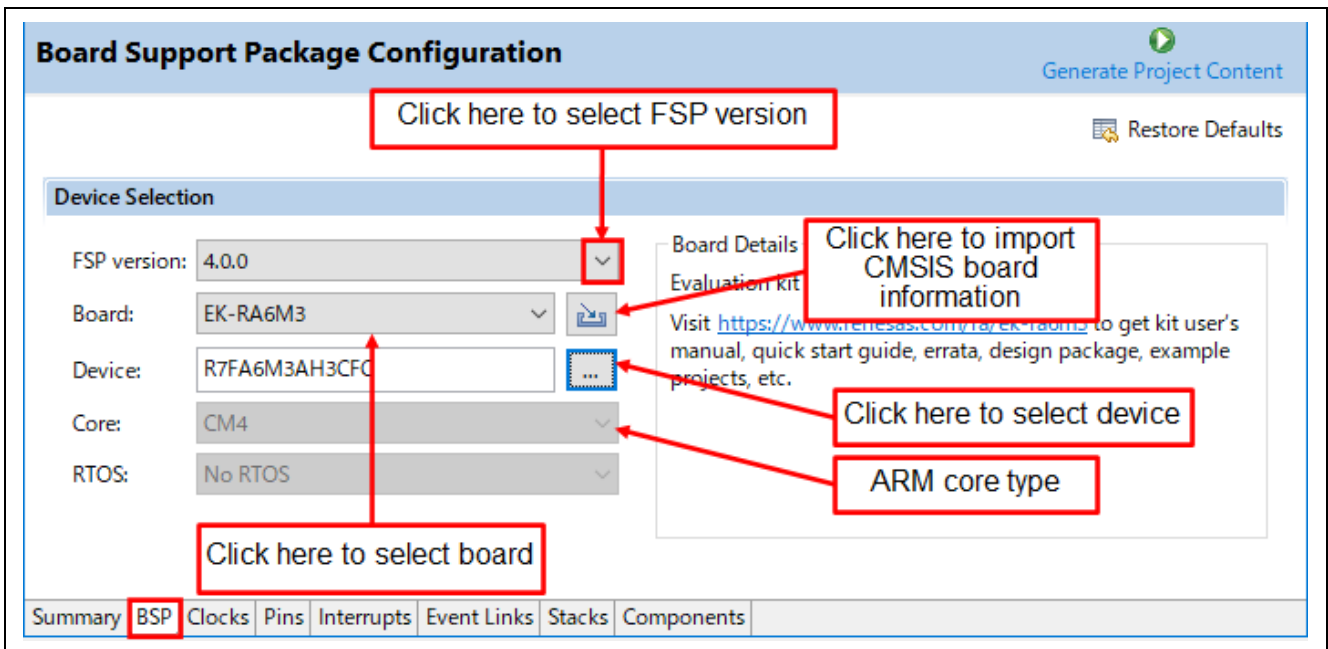

Figure 3-35. RA Project Configuration – BSP Page

When the **BSP** page is selected, the e<sup>2</sup> studio **Properties** view displays the available properties for the selected board. These properties may be modified in the **Properties** view as necessary according to the requirements of the project.

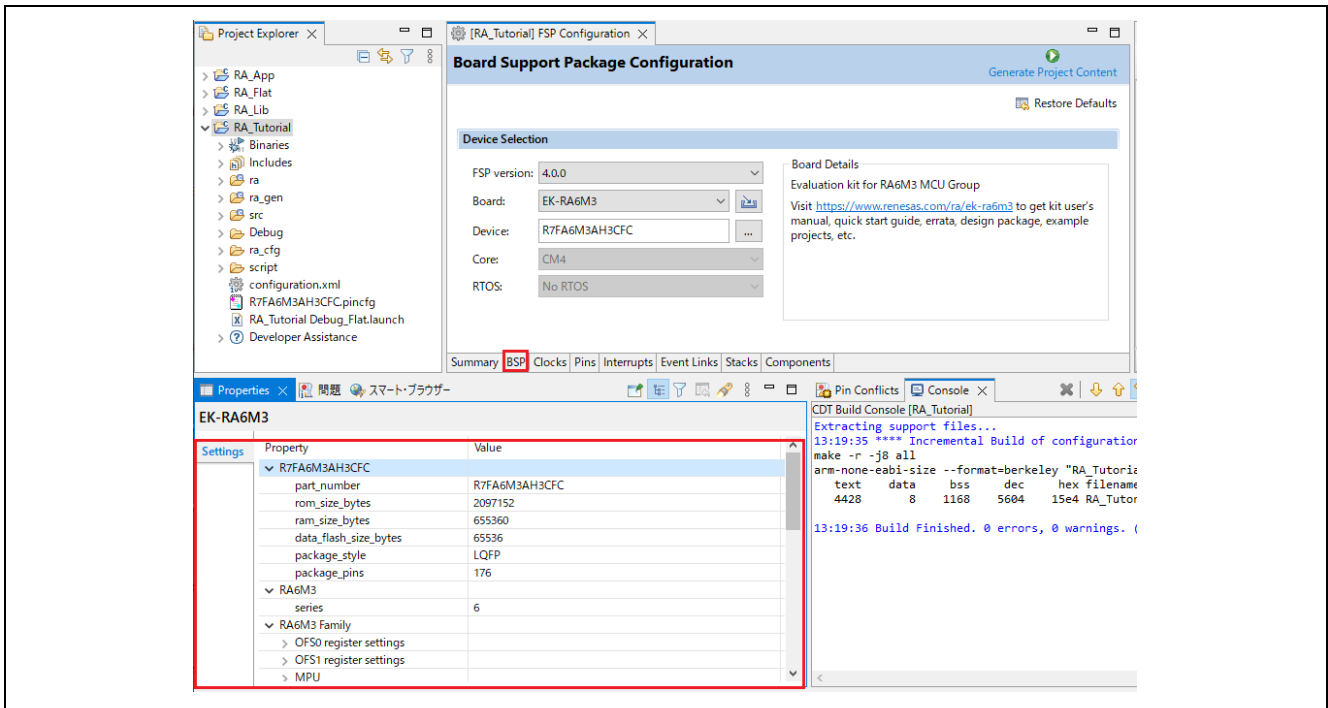

Figure 3-36. Board Properties

### 3.5.3 Clocks Configuration Page

The **Clocks Configuration** page sets up the initial clocking for the application. Clock sources, PLL settings, and clock divider settings can be selected for each of the output clocks.

For details on the Clock Generation Circuit (CGC), see the RA hardware user’s manual. To update the project, follow these steps:

1. Select a value in the drop-down list for the clock setting on GUI.  
**Note:** If the value goes out of range, it will turn red and the "!" mark will be displayed.

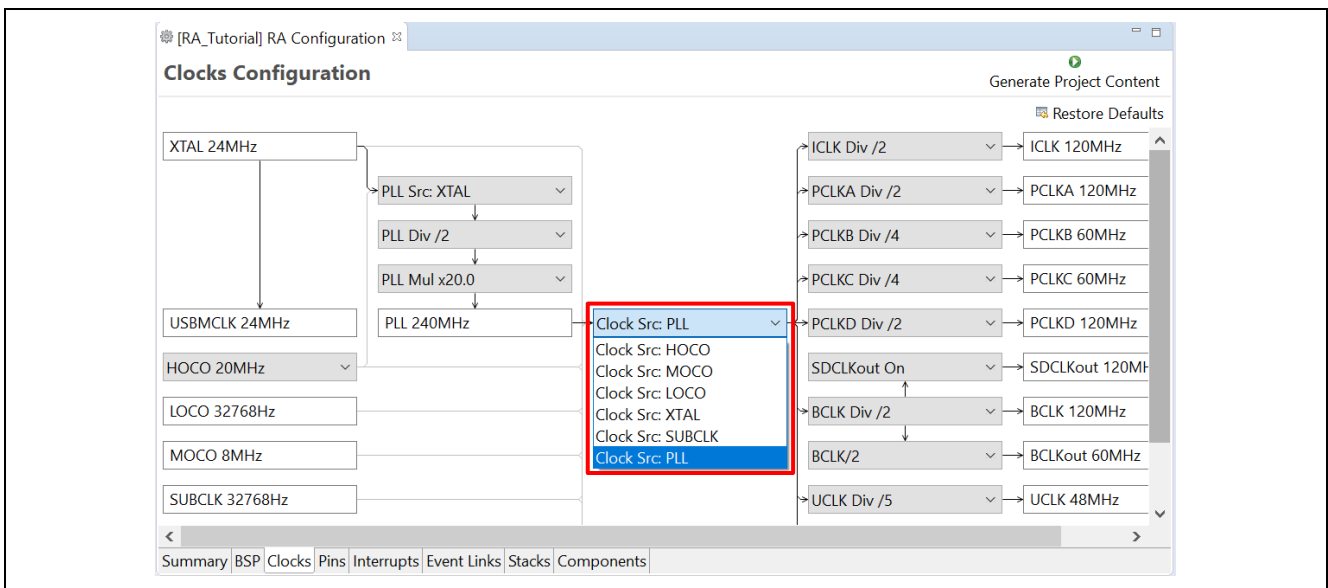
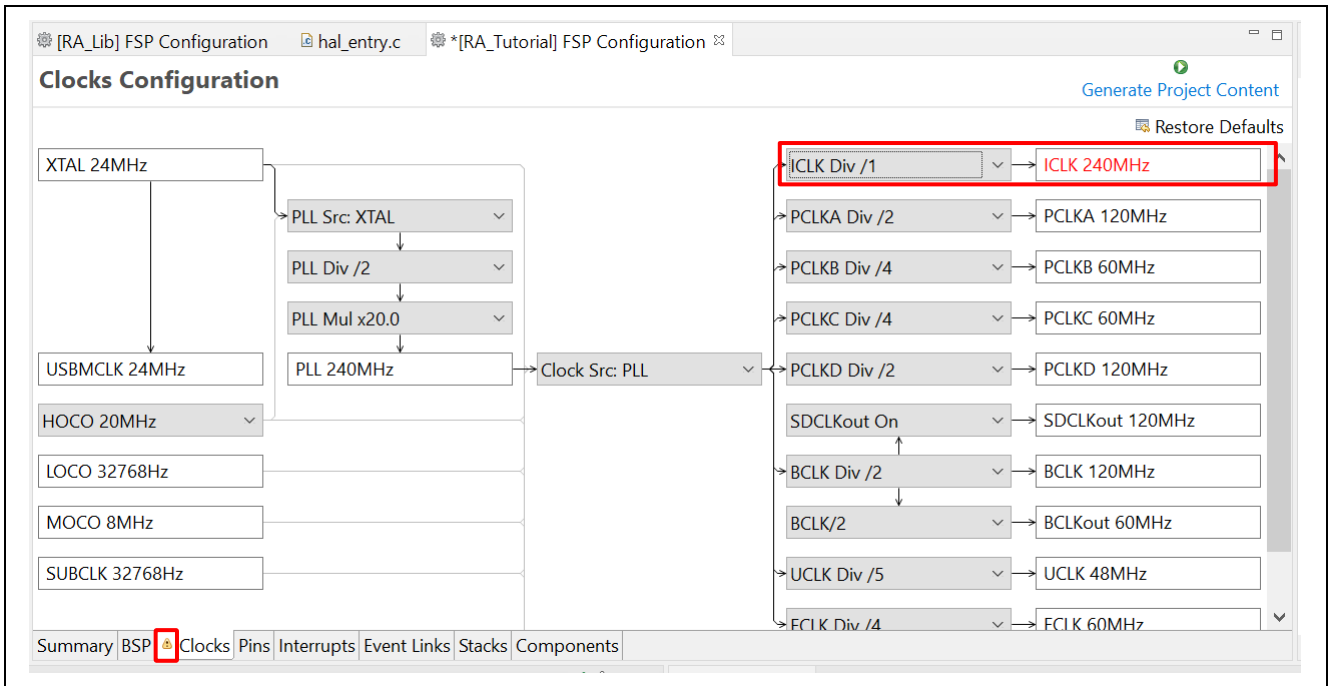
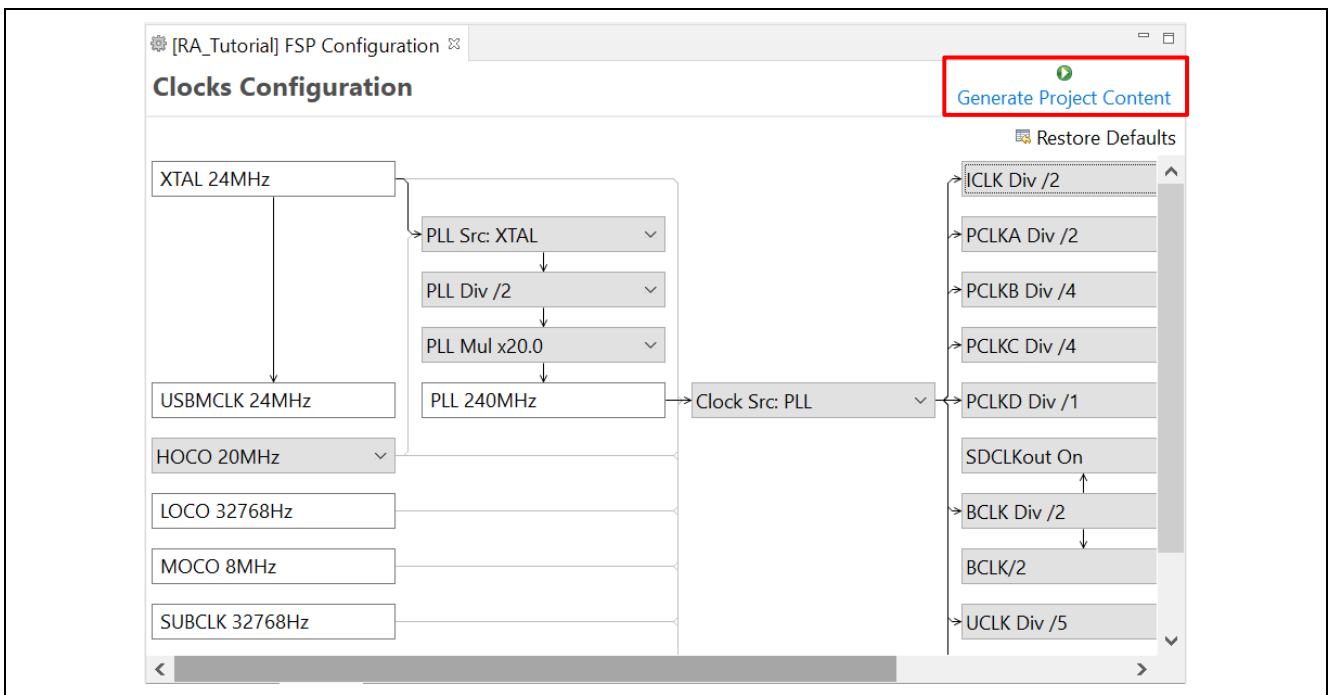

Figure 3-37. RA Project Configuration – Clocks Configuration



**Figure 3-38. Value Goes Out of Range**

2. Save the Project Configuration Settings, for example by using the **Ctrl-S** shortcut.
3. Click the **Generate Project Content** button.



**Figure 3-39. Generate Project Content**

4. The file "bsp\_clock\_cfg.h" is updated with the selected clock configuration.

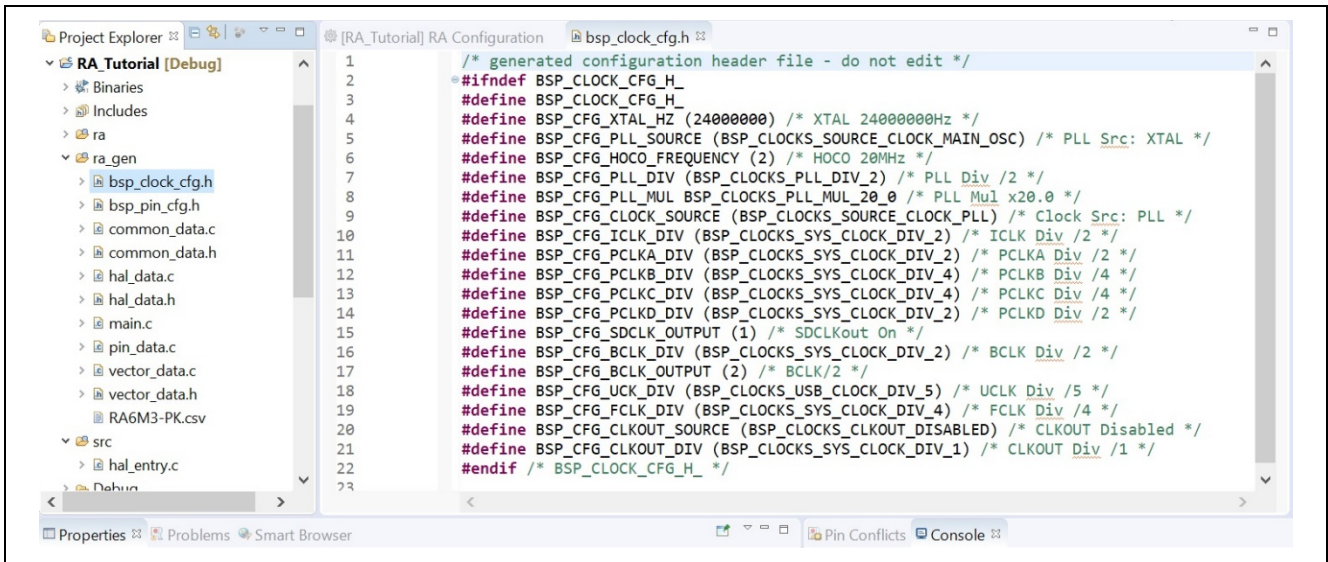

Figure 3-40. bsp\_clock\_cfg.h is Updated

### 3.5.4 Pin Configuration Page

The **Pin Configuration** page provides a graphical user interface for generating the pin configuration settings for the project.

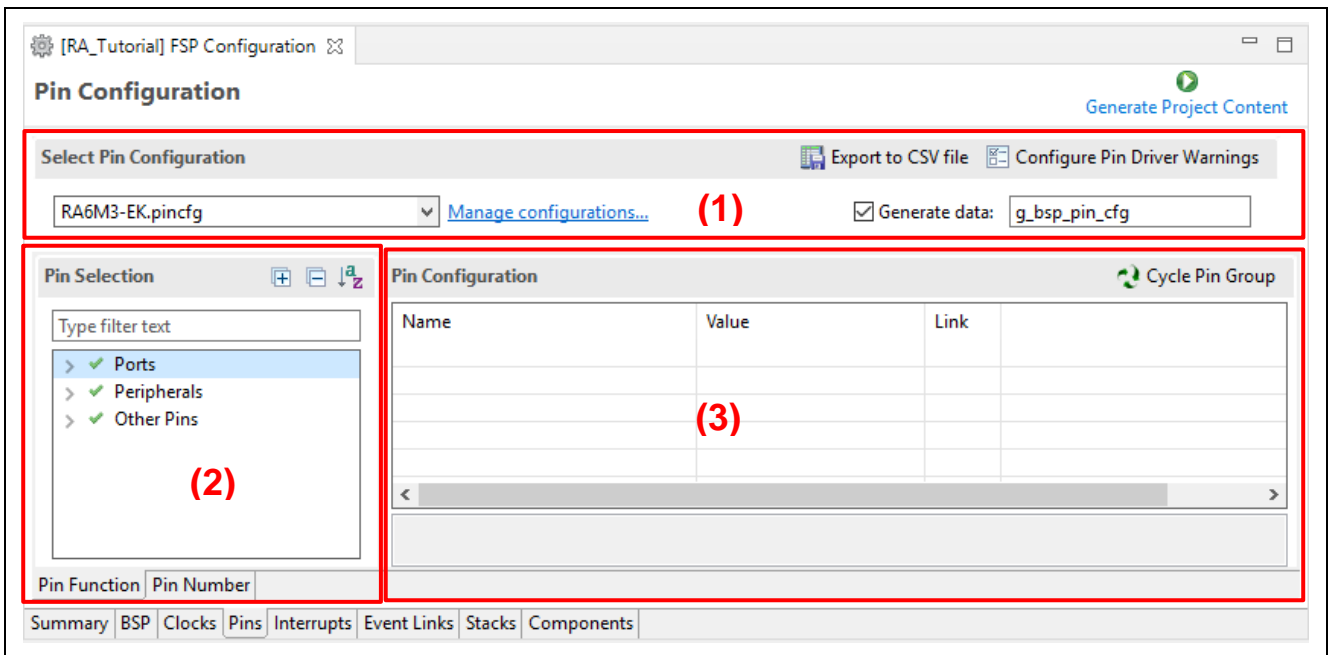

Figure 3-41. RA Project Configuration – Pin Configuration GUI

The **Pin Configuration** window consists of 3 parts:

1. **Select pin configuration:** Selects the pin configuration file and specifies the name for the associated data structure. Multiple pin configurations can be set as follows:
  - a. Create a new “.pincfg” file (for example, “NewName.pincfg”) in Project Explorer by copying an existing one.
  - b. Select the new “.pincfg” file (for example, “NewName.pincfg”) in the **Select pin configuration** dialog box.
  - c. Check the **Generate data** check-box and give the new pin configuration a unique data structure name in the text field.
  - d. The multiple pin configurations are created in different data structures.
2. **Pin Selection:** Selects pin or peripheral that will be set up.
3. **Pin Configuration:** Set up for function/property of the selected pin / peripheral.

The best way to configure pins is to configure the peripherals to be used in the project using the steps below:

1. Select a peripheral in the **Pin Selection** pane, for example, **Connectivity:SCI** → **SCI4**. The configuration for this peripheral is shown in the **Pin Configuration** pane.
2. Select an Operation Mode for the peripheral, for example, **Simple SPI**.
3. Select the pins you would like to use for the input/output functions of the selected peripheral in the selected mode.

**Note:** You can jump to the port setting by clicking the arrow on the right side of the pin.

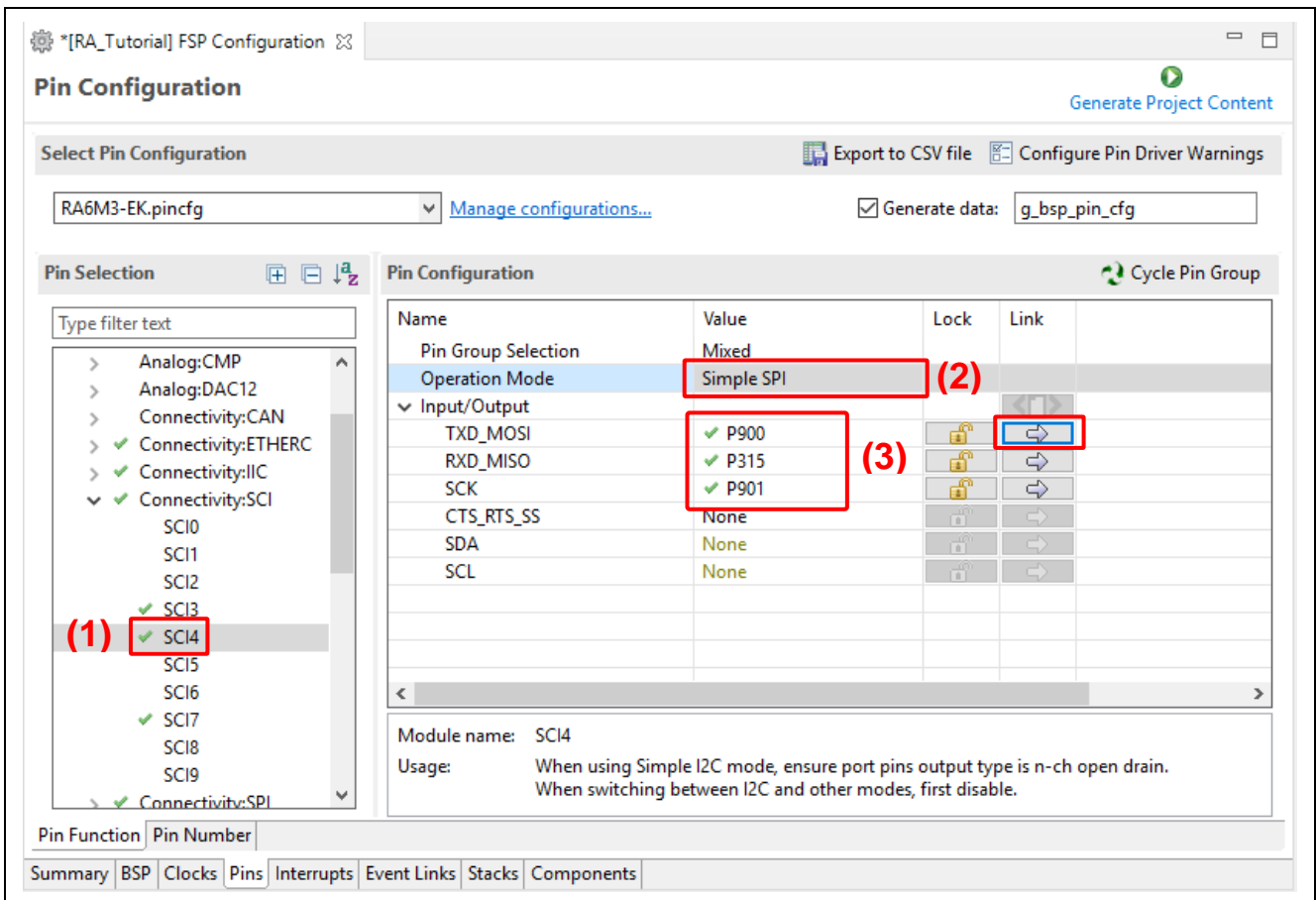

**Figure 3-42. RA Project Configuration – Pin Configuration Setting (By Peripheral)**

A single pin can also be set up by following the steps below:

1. Select a pin in the **Pin Selection** pane, for example, **Ports** → **P0** → **P003**. The configuration for this pin will be shown in the **Pin Configuration** pane.



2. Enter properties for this pin, for example:

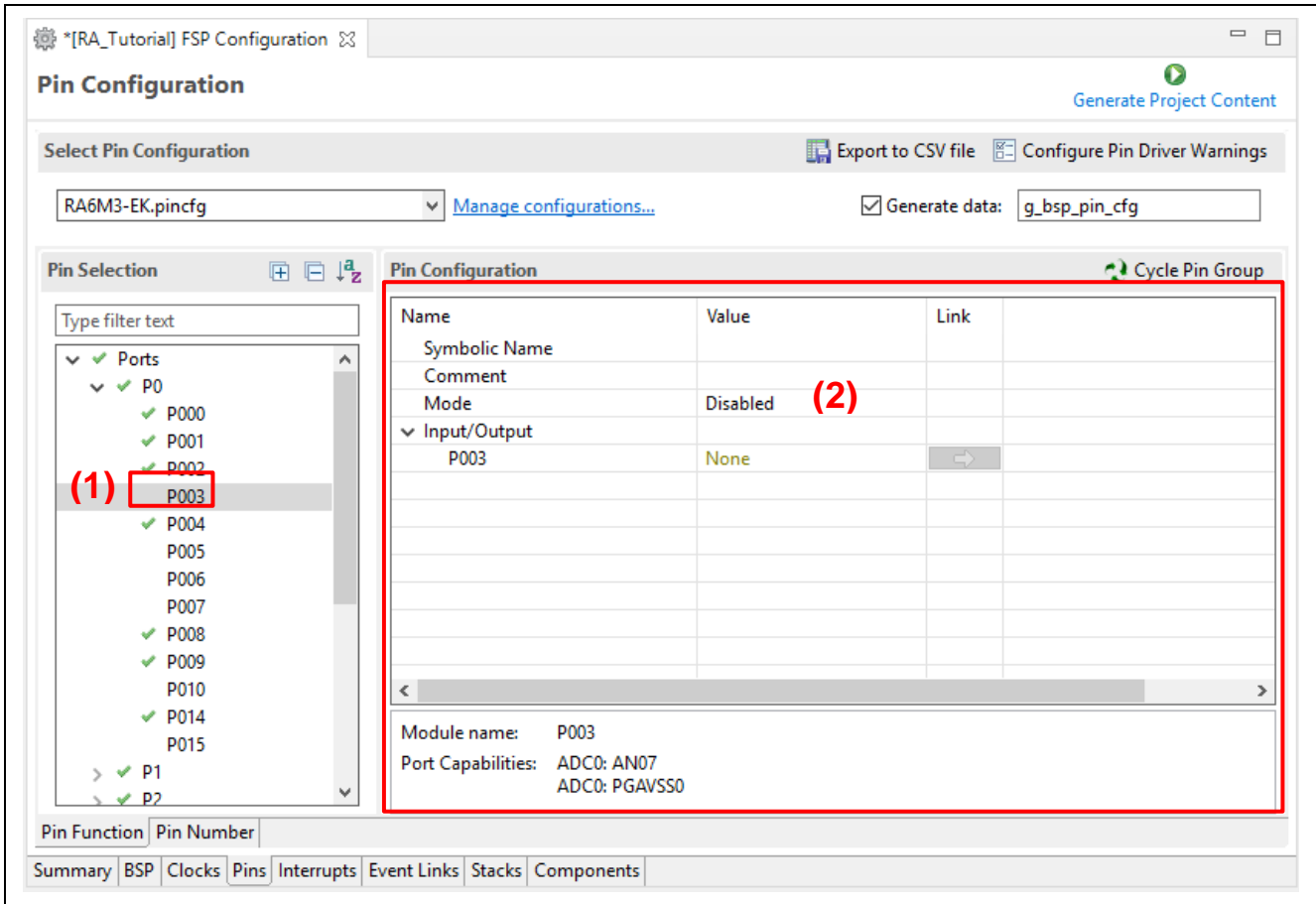

Figure 3-43. RA Project Configuration – Pin Configuration Setting (By Single Pin)

3. The Visualization view shows this pin change.

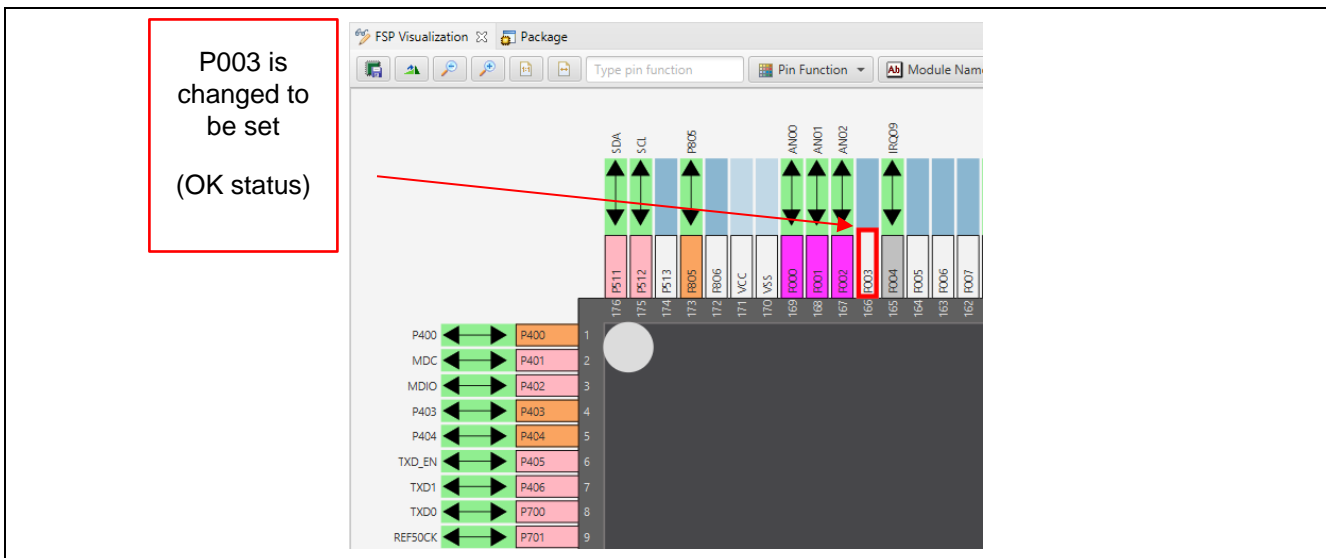
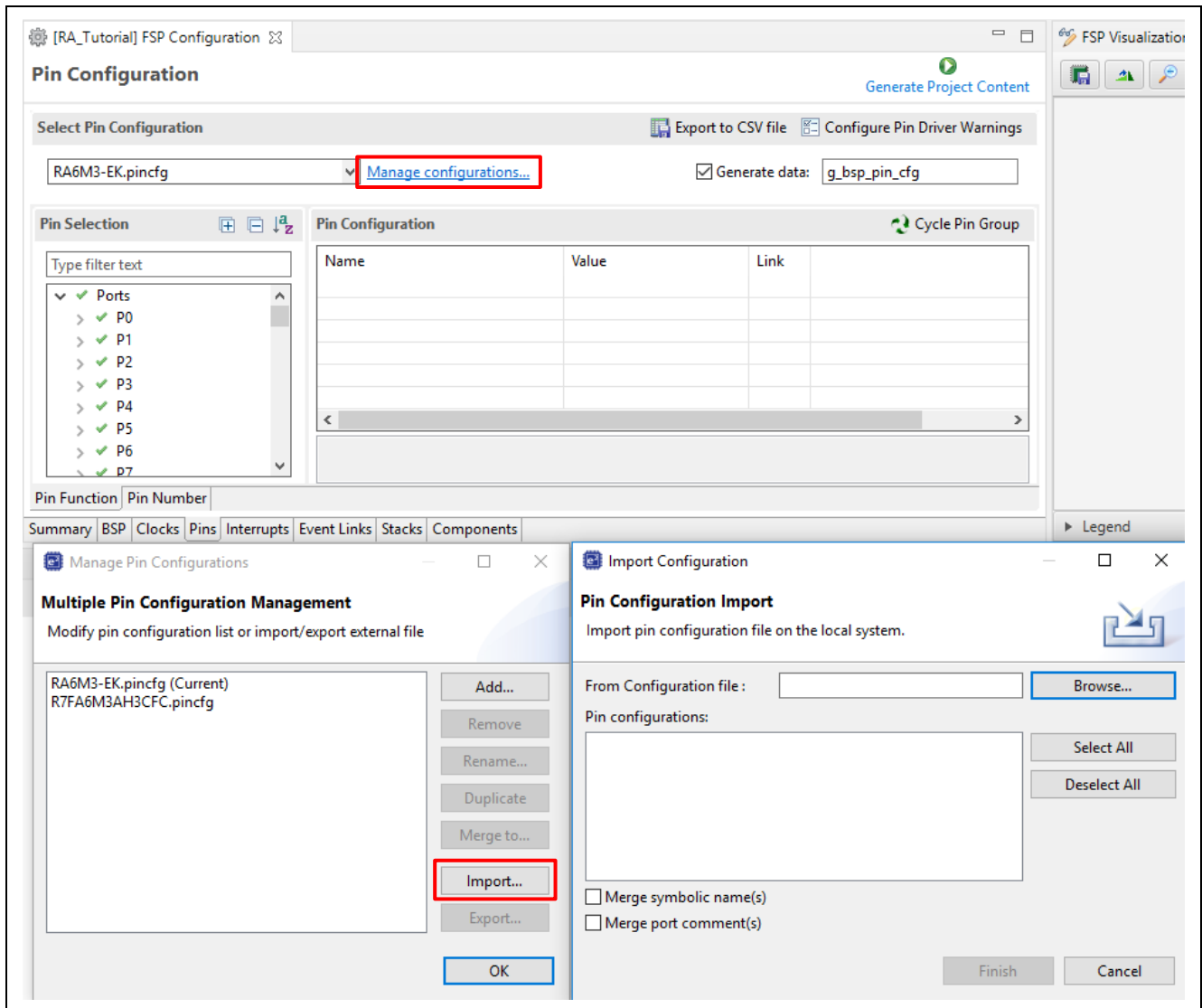

Figure 3-44. RA Project Configuration – Package View (Connection Status)

It is possible to migrate a pin configuration from one device to another device on this page. Use the **Import a pin configuration** button on the toolbar to perform this migration. This function allows migration of the pin configuration to the new device while retaining user setup.

To import an existing pin configuration to the current project, click **Manage configurations...** → **Import** and select the pin configuration file to import.



**Figure 3-45. Import An Existing Pin Configuration To The Current Project**

The import function might prompt you about conflicts and provide the following options:

- Cancel the import operation.
- Ignore the conflicts and import the conflicting settings anyway.
- Continue the import operation without importing the conflicting settings.

### 3.5.5 Stacks Configuration Page

The **Stack Configuration** page allows you to:

- Configure threads within a RA project.
- Add RA modules and objects to a thread.
- Modify module and object properties in the Properties View.



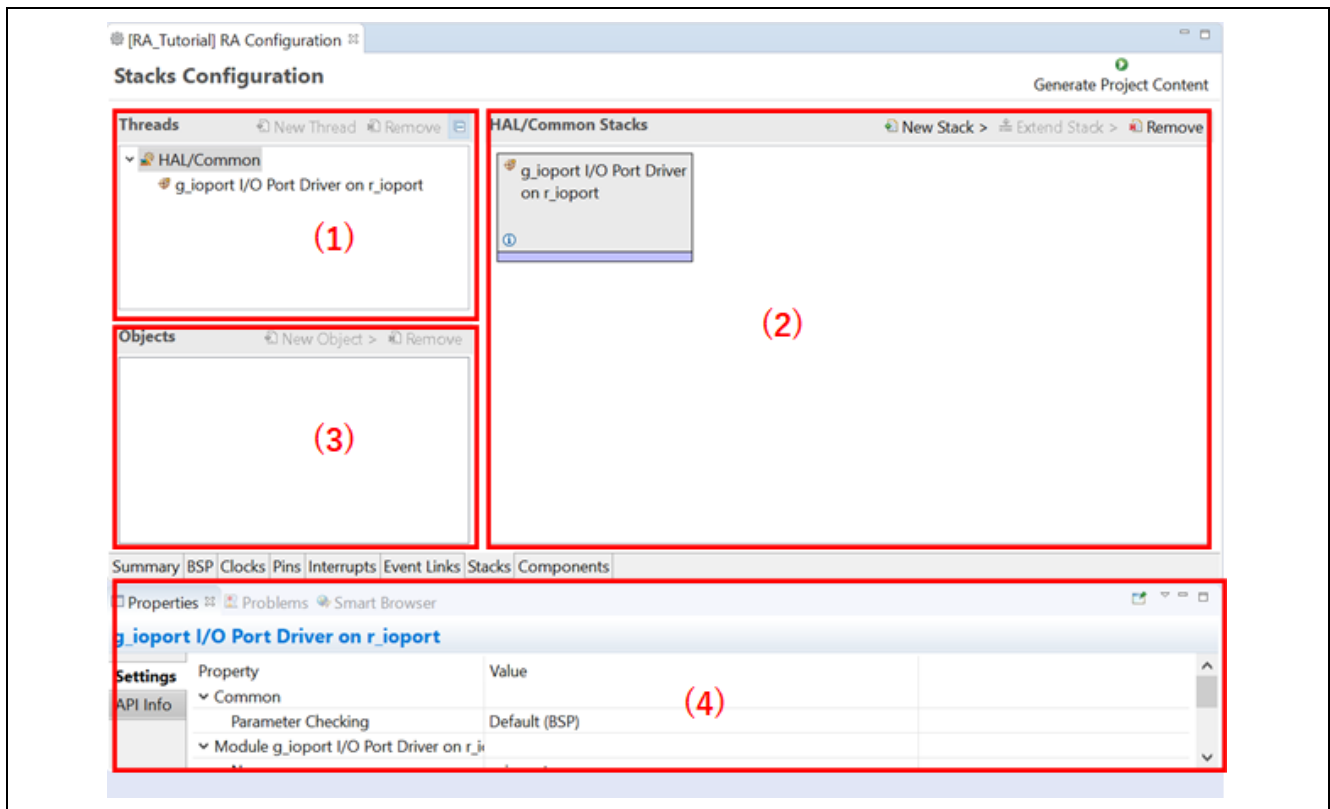



Figure 3-46. RA Project Configuration – Stacks Configuration GUI

The **Stacks Configuration** page consists of 3 panes:

1. **Threads** pane: Add/remove threads. Details are explained in Chapter 6.
2. **Stacks** pane: Add/remove FSP module instances, such as IO port, SCI, and UART.
3. **Objects** pane: Add/remove kernel objects. Details are explained in Chapter 6.

In addition, the **Properties** view supports the **Threads Configuration** and is used to modify module/object properties.

A module can be added to the existing project by following the steps below:

1. Select a thread, such as **HAL/Common**. The modules and objects in this thread are shown.
2. In the **Stacks** pane, click  **New Stack** to add a module to the thread (for example, **New Stack** → **Monitoring** → **Clock Accuracy Circuit (r\_cac)**).
3. Click the **Generate Project Content**  button to generate the source code content.
4. The **Properties** view shows the properties of the selected module. Users can change them according to their requirements.

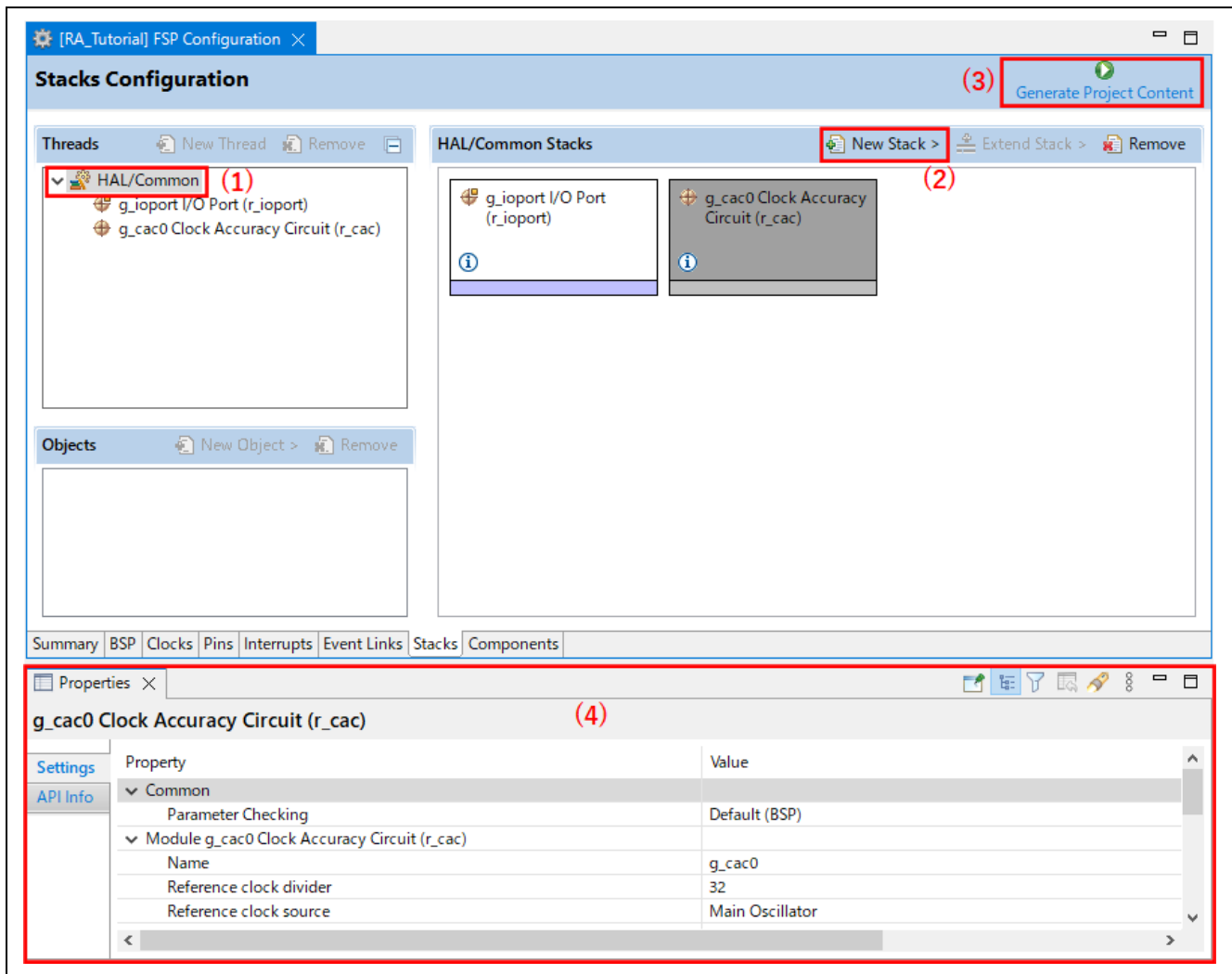

**Figure 3-47. RA Project Configuration – Add New Module To Thread**

Note: For another example, refer to section 6.1, which describes the procedure to add General Purpose Timer (GPT) module to the Blinky Thread.

An added module may require dependent modules or configuration settings. Necessary dependent modules are added automatically. Optional dependent modules are suggested to be added manually by the user. In this case, users should click on the suggested modules to add and to configure their properties (for example, **Add New Stack** → **Connectivity** → **USB PCDC (r\_usb\_pcdc)**).

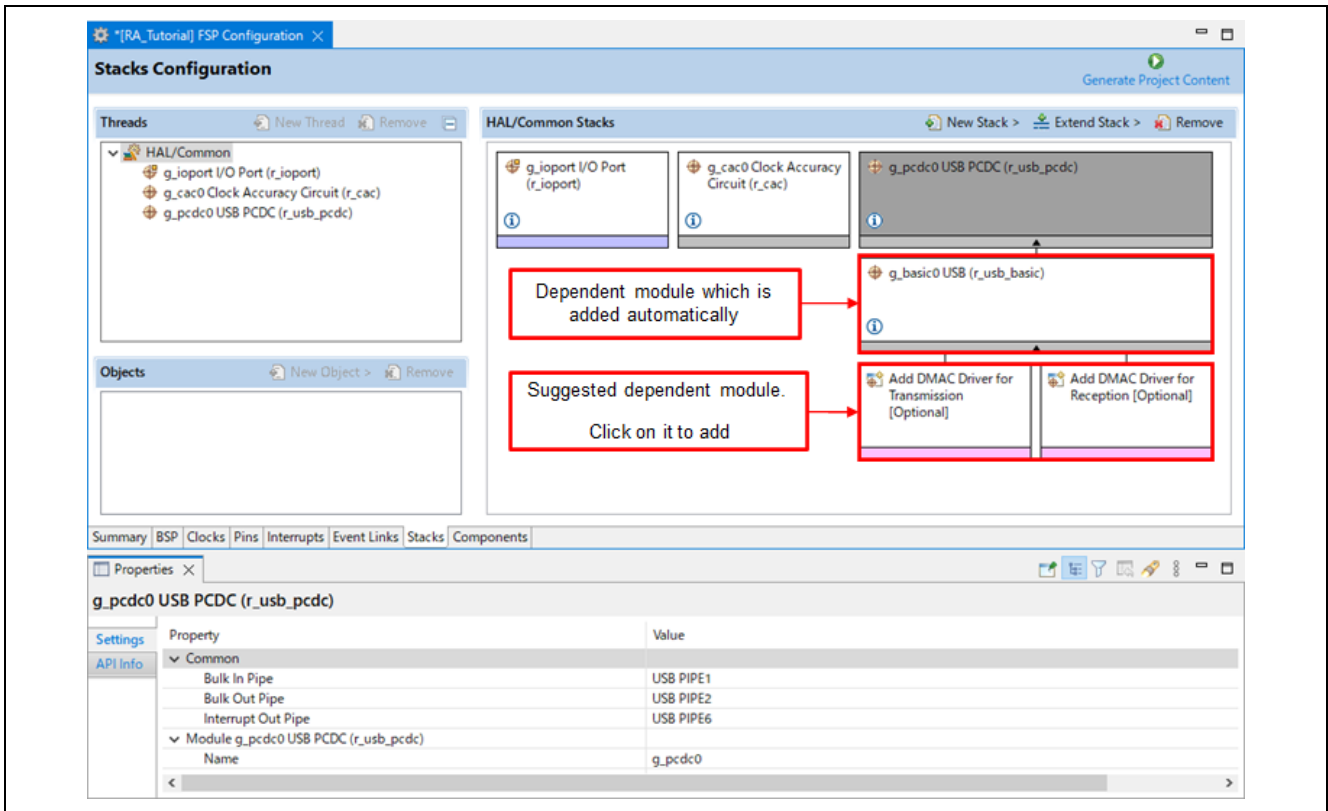

**Figure 3-48. RA Project Configuration – Dependent Module**

A module or a module stack can also be added by performing a copy-and-paste operation in the **Threads Configuration** page. Right-click on a module and select **Copy** to copy it. Right-click in the stack pane of the same or a different thread in the same project and select **Paste**.

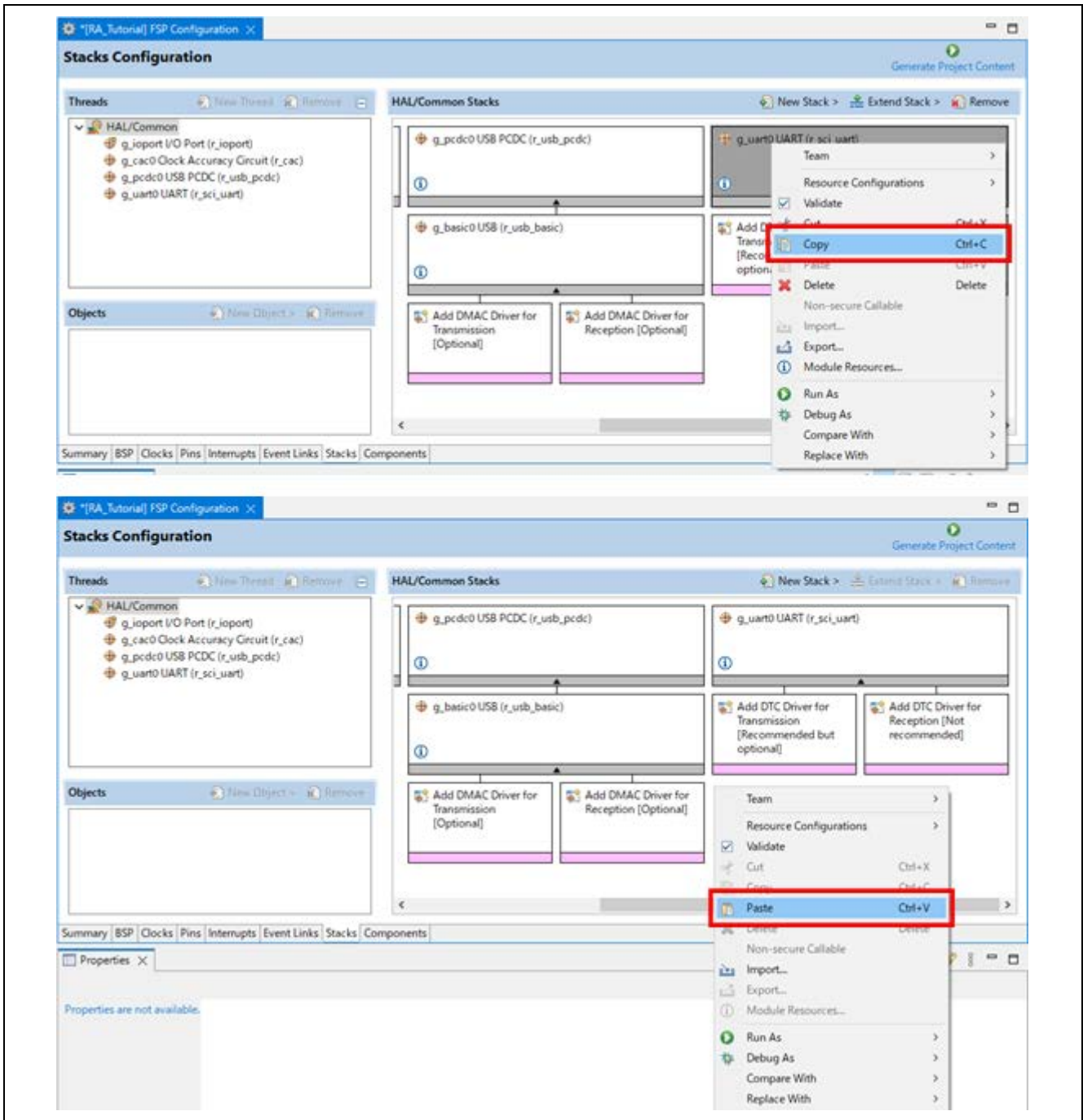

Figure 3-49. Copy and Paste Operation

There will be a name conflict between the old module instance and the new one. Renaming one of the module instances solves the problem.

Note that only the copy-and-paste of g\_ioport will have no name conflict.

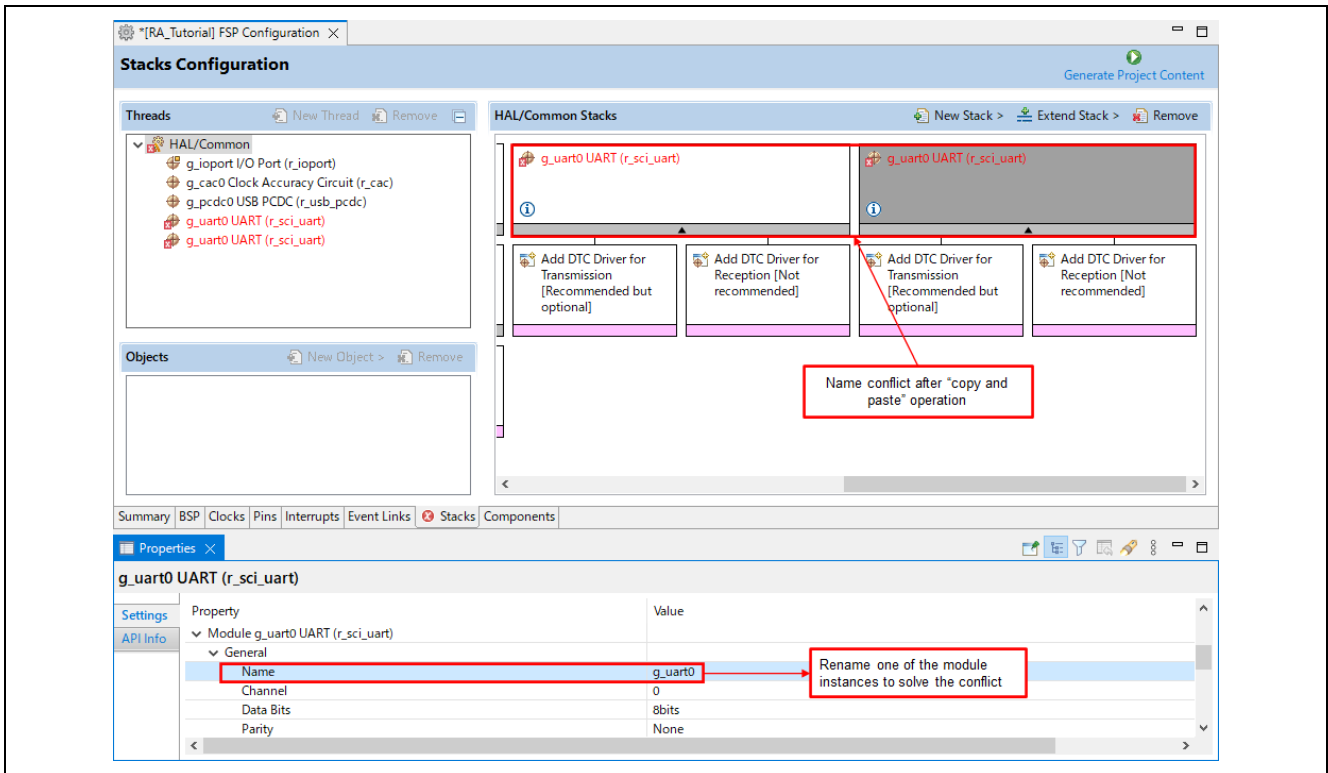

Figure 3-50. Module Instance Name Conflict

A module or a module stack can also be added by performing the export and import operation in the **Stacks Configuration** page. Right-click on a module and select **Export...** to export the configuration of the module to an XML file. Right-click in the stack pane of the same or a different thread in the same project and select **Import...** to import the configuration from the exported XML file. The name conflict can be solved by renaming one of the module instances.

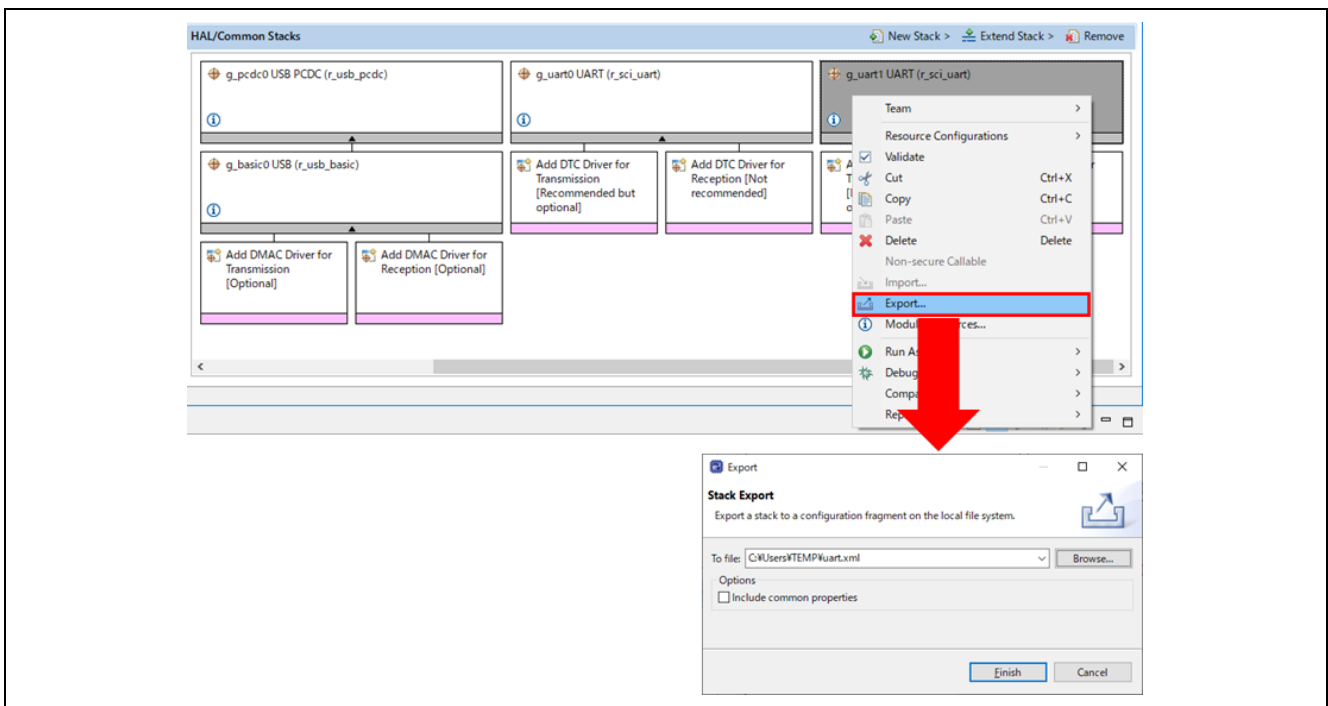

Figure 3-51. Export the RA Stack

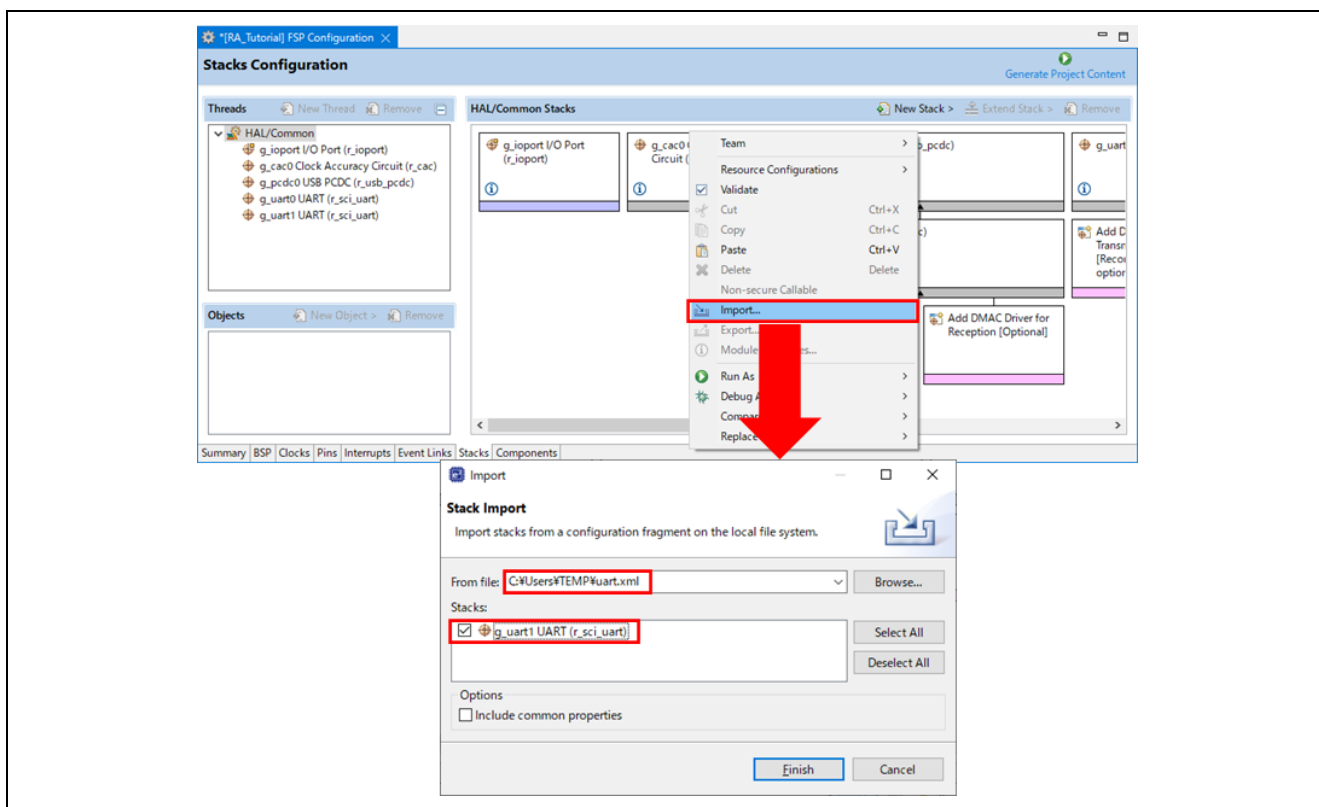

Figure 3-52. Import the RA Stack

### 3.5.6 Components Configuration Page

The **Components Configuration** page enables the individual modules required by the application to be included or excluded.

Modules common to all RA projects are preselected (for example **HAL Drivers** → **all** → **r\_cac**).

All modules that are necessary for the drivers selected in the **Stacks** page are included automatically. You can include or exclude additional modules by checking the box next to the required component.

Note: The primary way of adding modules to an application is by using the **Stacks** page. The **Components** page is primarily used as a list of components available in the installed FSP.

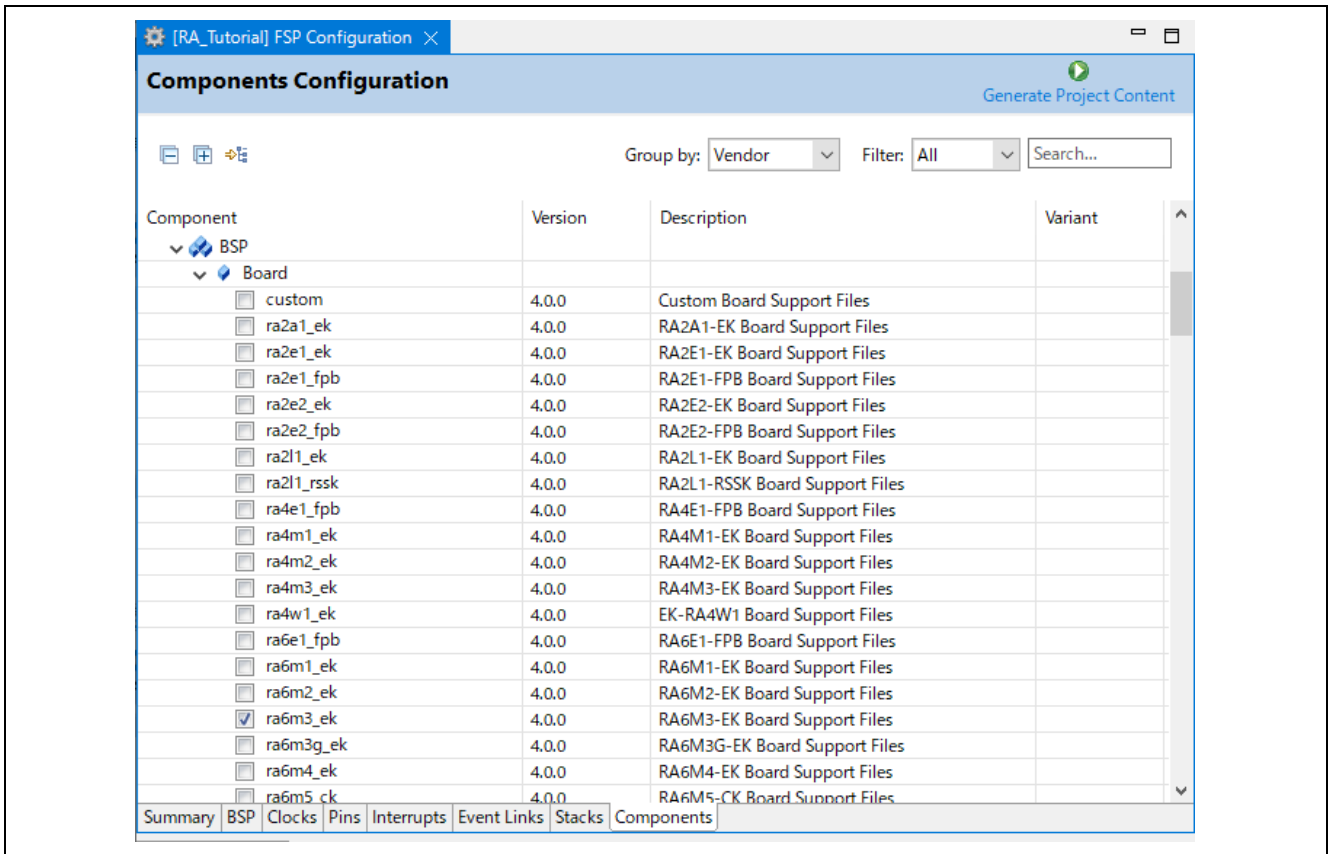

Figure 3-53. RA Project Configuration – Components Configuration

### 3.5.7 Interrupt Configuration Page

The **Interrupt** page allows the management of Events (interrupts) and ISRs (Interrupt Service Routines) for use with the RA interrupt framework.

The **Interrupt** page consists of 2 panes:

1. The **User Events** pane shows a list of events that have been created manually by user.
2. The **Allocations** pane shows a list of events that have been provided by instantiated RA modules in section 3.5.5.

In each pane, the **Event** column contains event names. The **ISR** column contains subscriber for the corresponding event in **Event** column.



Figure 3-54. RA Project Configuration – Interrupt Page

A user event and its ISR can be created manually by clicking on the button **New User Event**, then selecting an event to create.

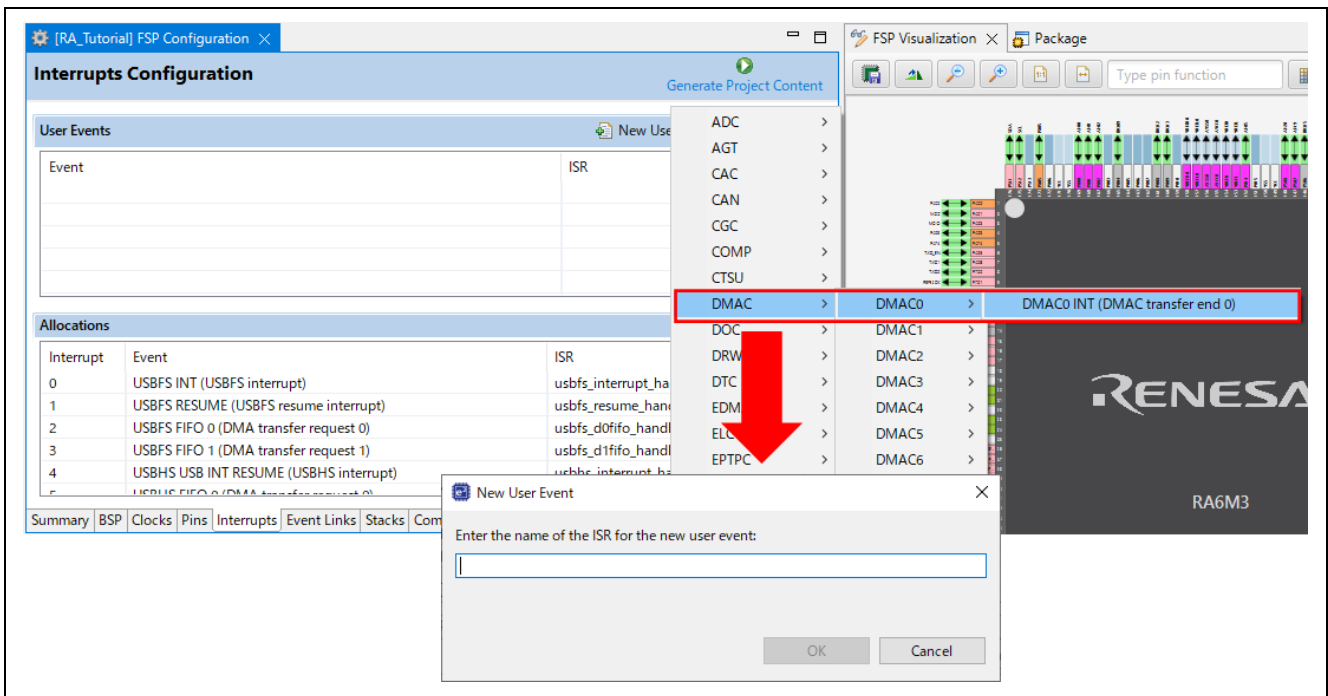

**Figure 3-55. Interrupt Page – Adding A New User Event**

The newly created event is displayed in the **User Events** pane.

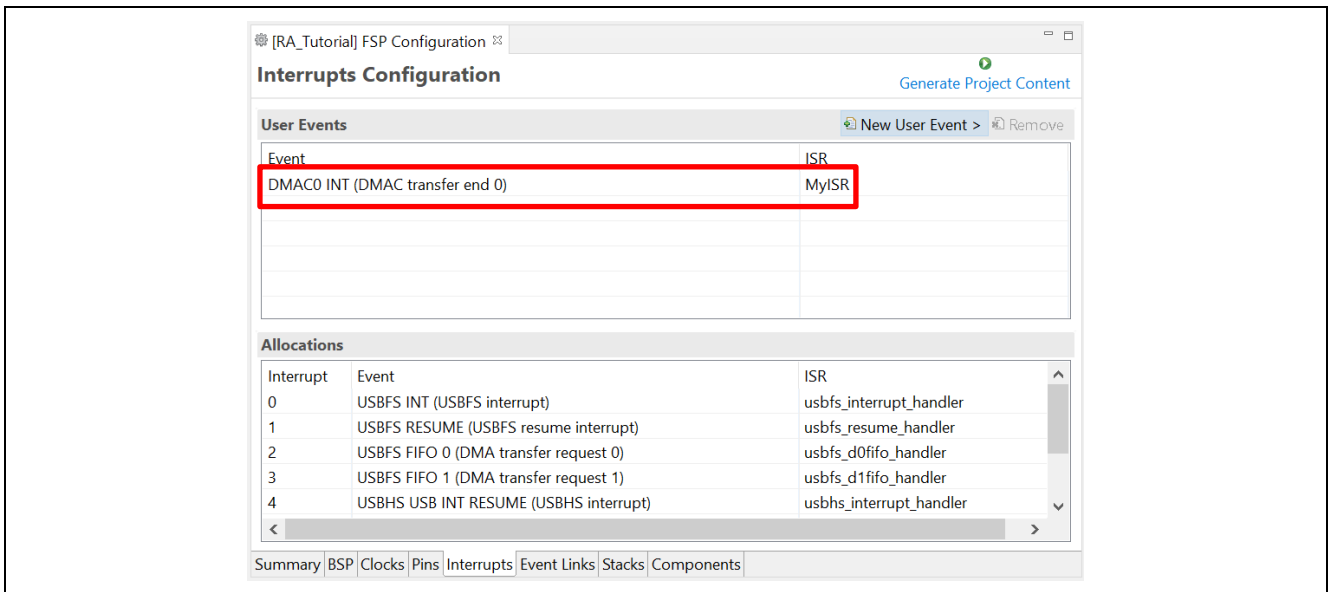

**Figure 3-56. Interrupt Page – Generate Source Code**

To remove a user event, select the event and click  button in the **User Events** pane (events added by instantiated RA modules in the **Allocations** pane cannot be removed).



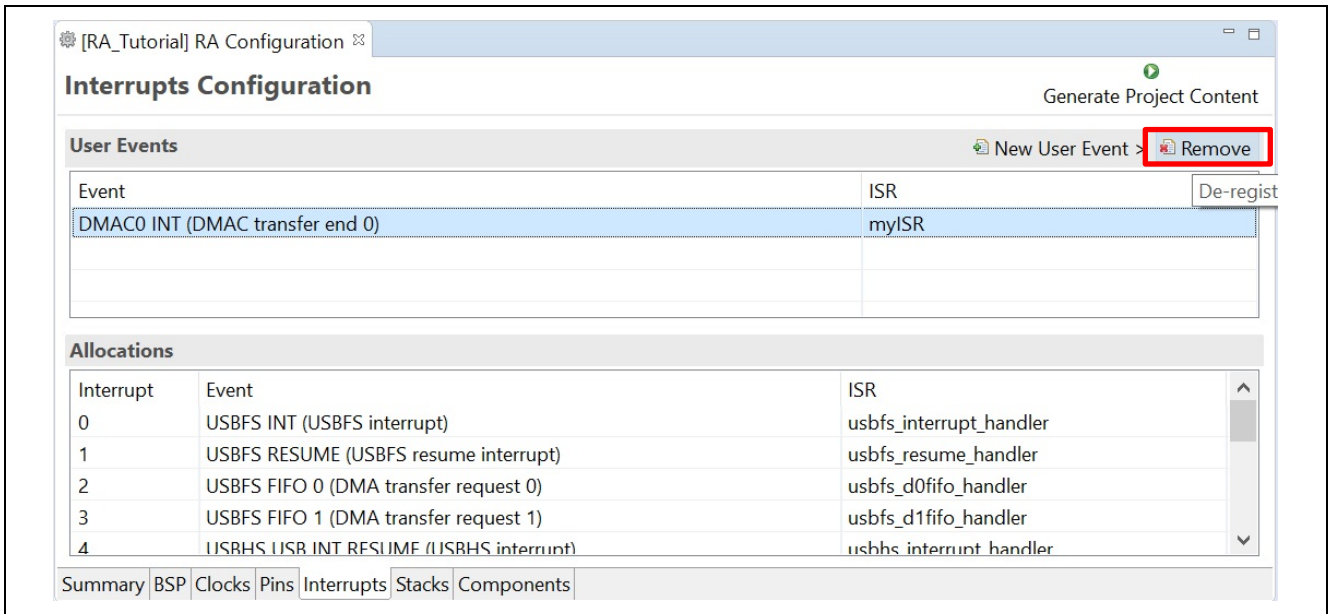

Figure 3-57. Remove User Events

### 3.5.8 Event Links Configuration Page

The **Event Links** page allows the user to specify how non-FSP drivers within an RA project make use of the Event Link Controller (ELC). The UI allows the user to declare that such a driver might produce a set of ELC events or consume a set of ELC events through a set of peripheral functions.

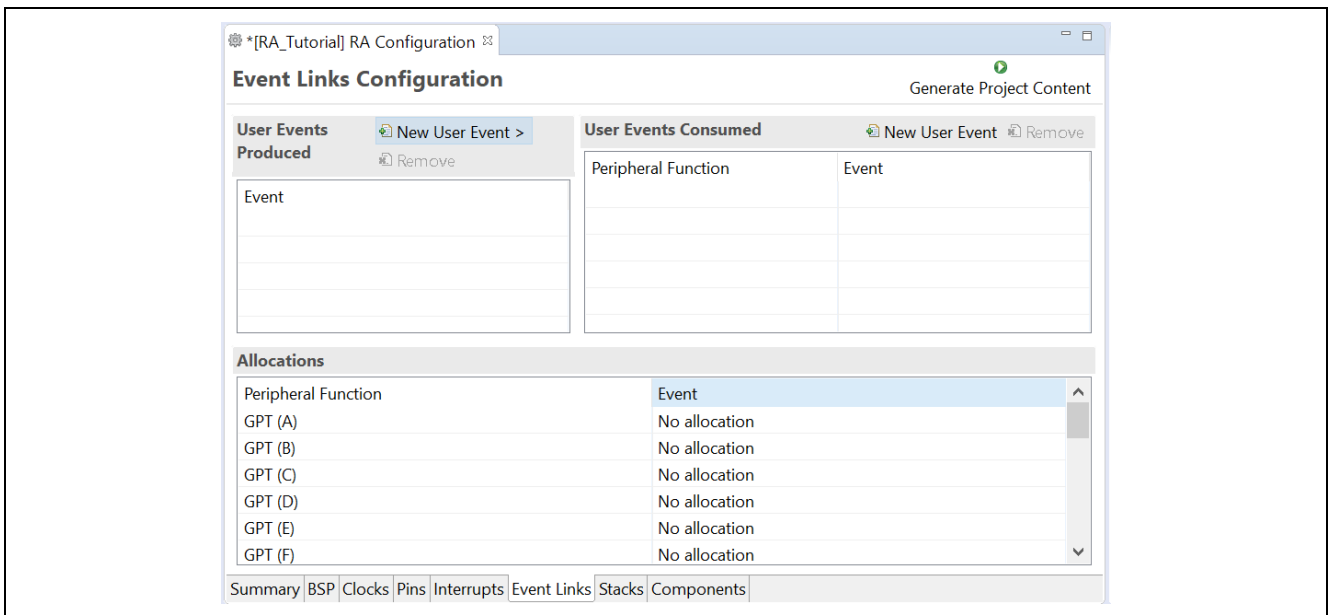

Figure 3-58. Event Links Page

To declare a user-produced event:

1. Select the **New User Event** button on the **User Events Produced** table.
2. A cascading menu appears containing all the ELC events supported by the selected RA device.
3. The **User Events Produced** list will be updated with the event selected from the menu.

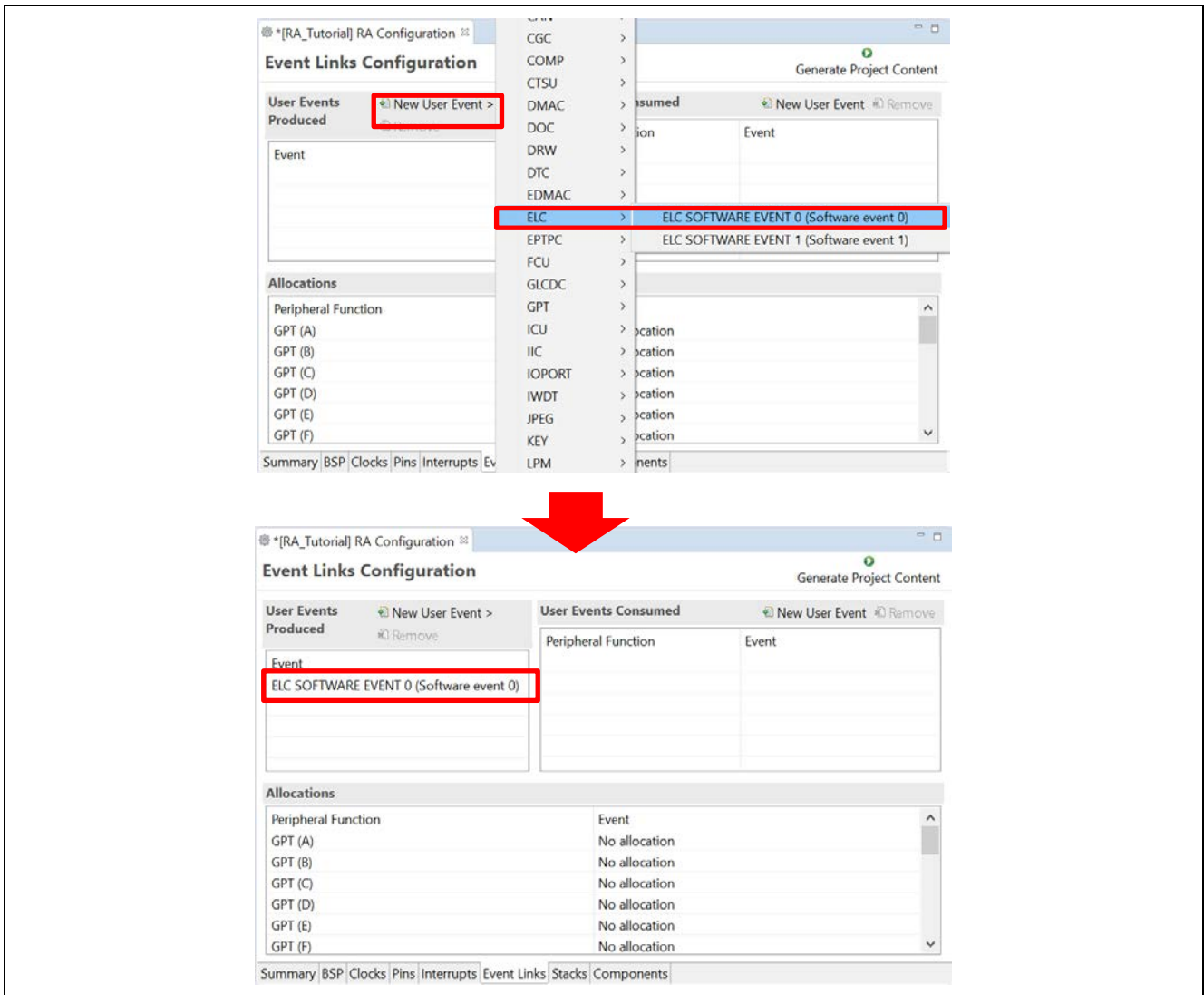

Figure 3-59. Declare User-Produced Event

To declare a user-consumed event:

1. Select the **New User Event** button on the **User Events Consumed** table.
2. A **New User Event** dialog should open with a combo box containing the available peripheral functions and available ELC events. Select a **Peripheral Function** and **Event**, then click **OK**.
3. The selected event will be allocated to the selected peripheral function within the RA configuration and should be visible within the **User Events Consumed** list and the **Allocations** list on the **Event Links** page.

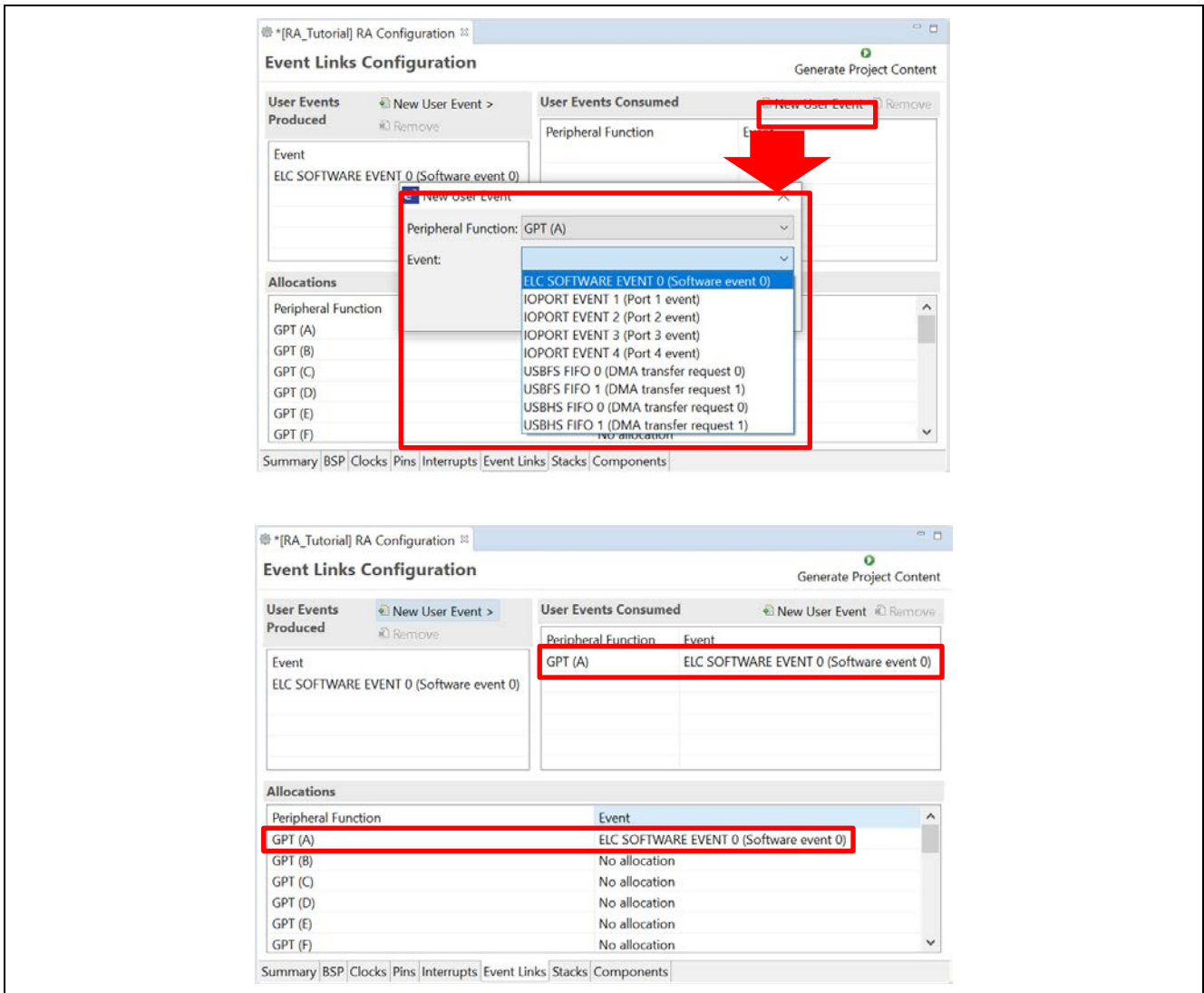

Figure 3-60. Declare A User-Consumed Event

### 3.6 Editor hover

e<sup>2</sup> studio supports hovers in textual editor. This function can be enabled/disabled by selecting **Window** → **Preferences** → **C/C++** → **Editor** → **Hovers**.

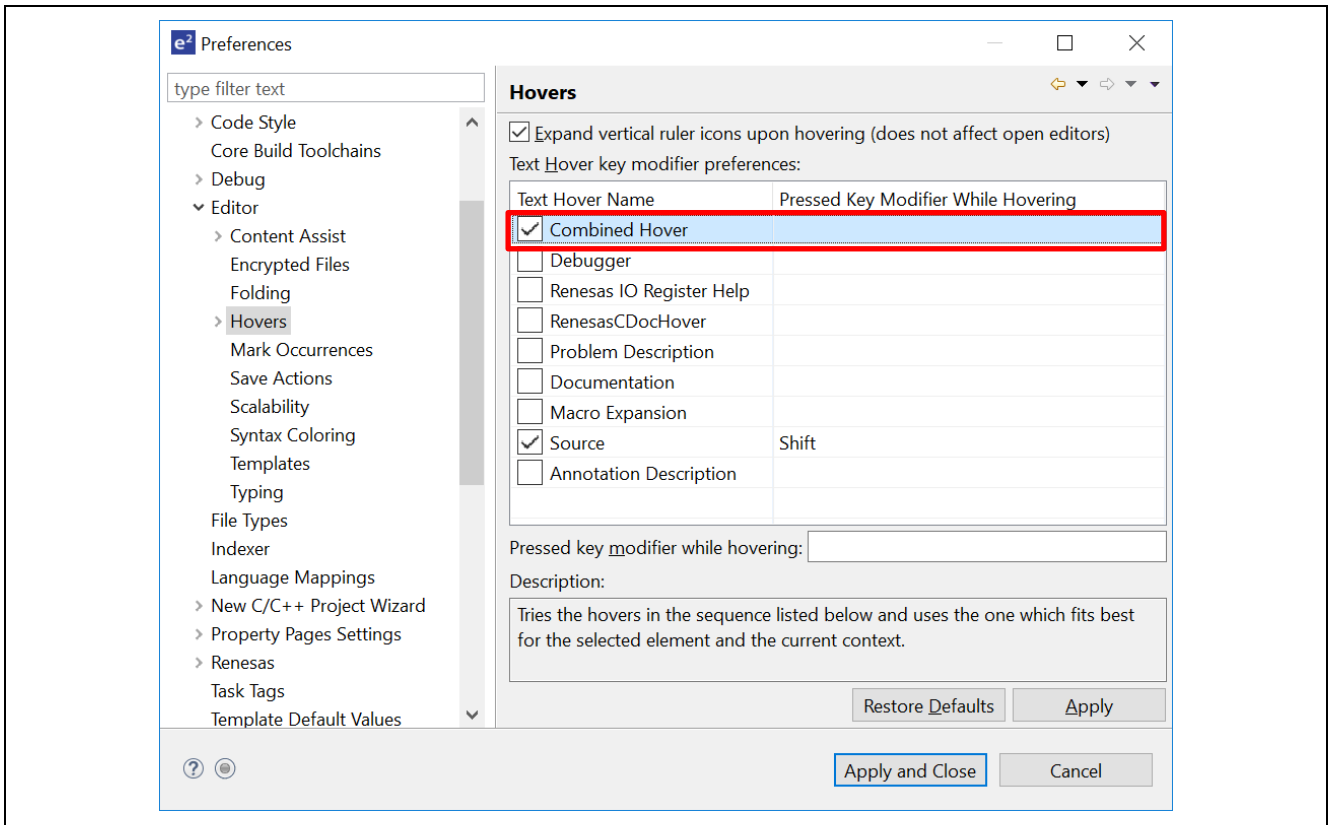

Figure 3-61. Hover Settings

To enable hover, check **Combined Hover**. To disable hover, uncheck it. This function is enabled by default.

The hover function allows users to view detailed information about any identifiers in the source code: hover the mouse over an identifier and check the pop-up.

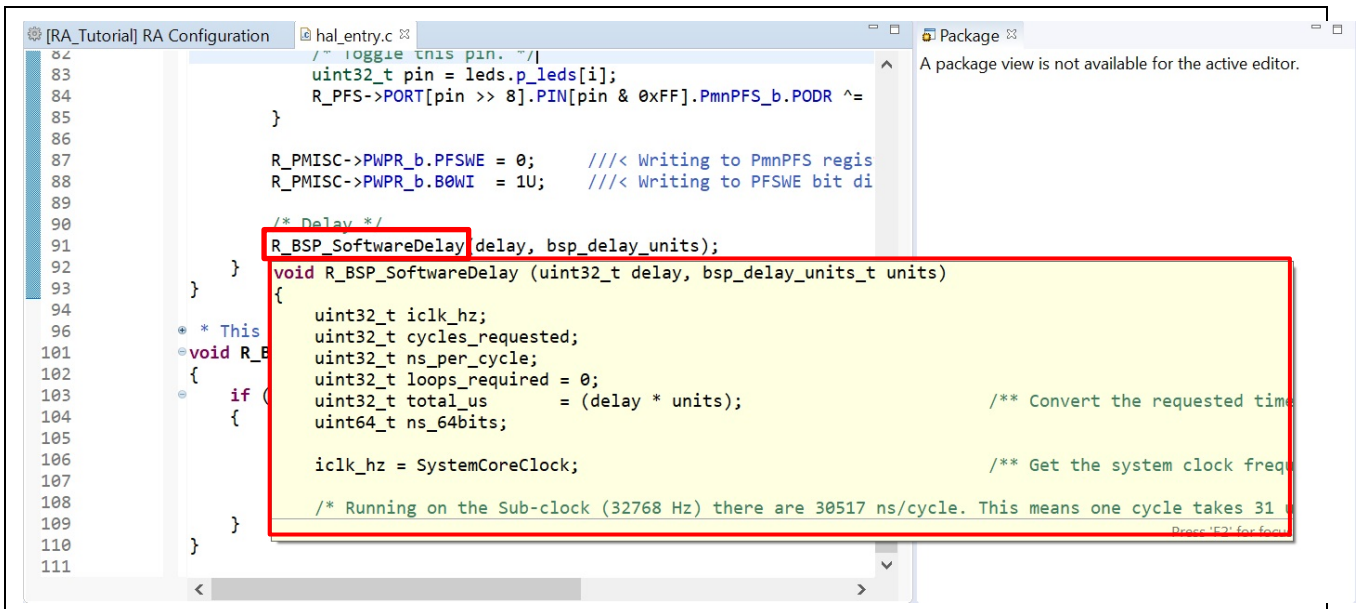

Figure 3-62. Information from Hover Function

## 4. Building

This chapter describes the build configurations and key build features in e<sup>2</sup> studio.

### 4.1 Build Configurations

The default build option is generated when a project is created. It can usually be used to build the project.

However, if changing build options is necessary (for example, toolchain version or optimization options), perform the following steps before building the project.

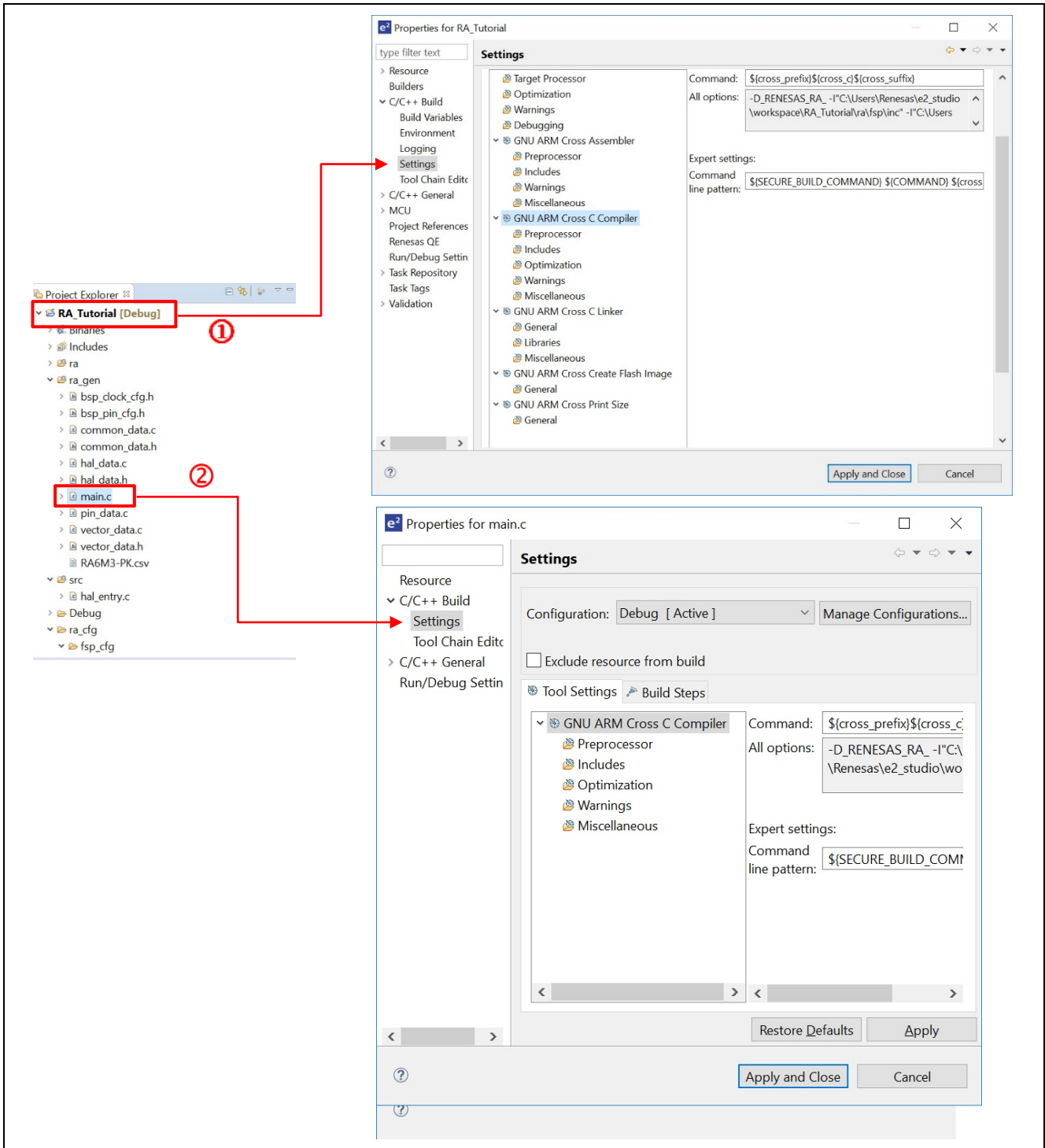

Figure 4-1. Build – Properties for RA Project and main.c Source File

Build options can be accessed in the properties window of a project or a source file:

1. ① Set the focus at the project name or ② set the focus at the source file name.
2. Right-click to select **Properties** or use shortcut keys **[Alt] + [Enter]** to open the properties dialog.
3. Click **C/C++ Build → Settings** option to view or edit the configuration settings.

The **Properties** window is supported at project and source level. The **Properties** window for projects supports more configurations that apply across all the files within the same project.

## 4.2 Building a Sample Project

Follow the steps below to build the project:

1. In **Project Explorer**, click the RA project to bring it into focus.
2. Click **Project → Build Project** or the  icon to build this project.
3. Confirm that there are no errors after build is finished.

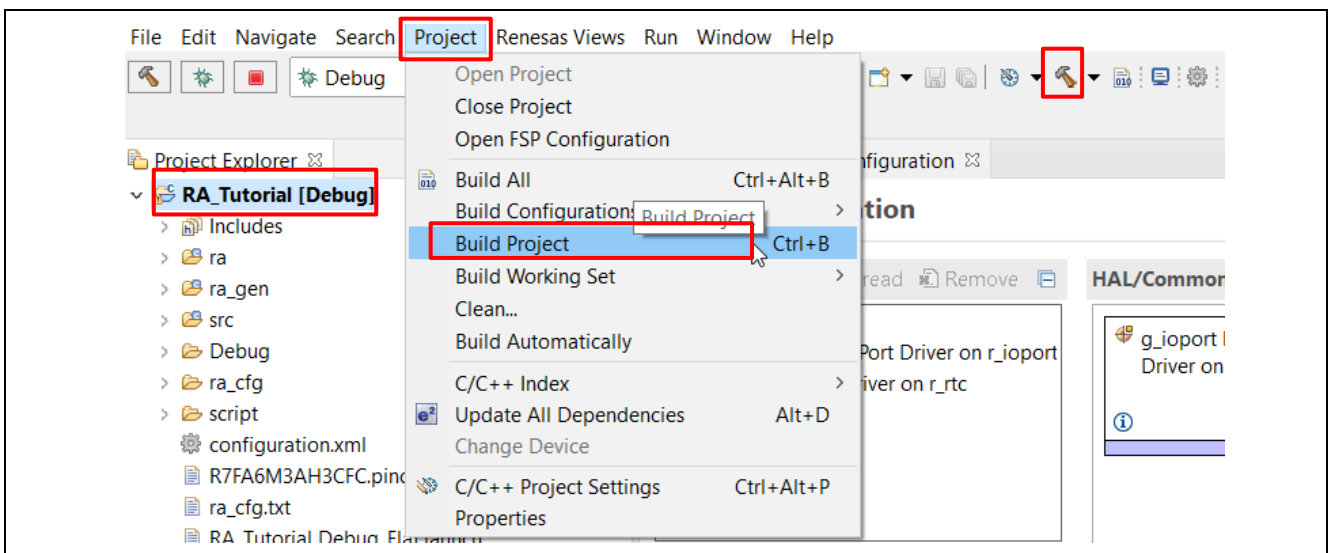

Figure 4-2. Build – Building A Sample Project

## 4.3 Saving the Build Settings Report

Project build settings in the e<sup>2</sup> studio IDE can be saved to a file using the **Project Reporter** feature.

1. Right-click in the **Project Explorer** view to open the context menu.
2. Select **Save build settings report** to save the build settings report.

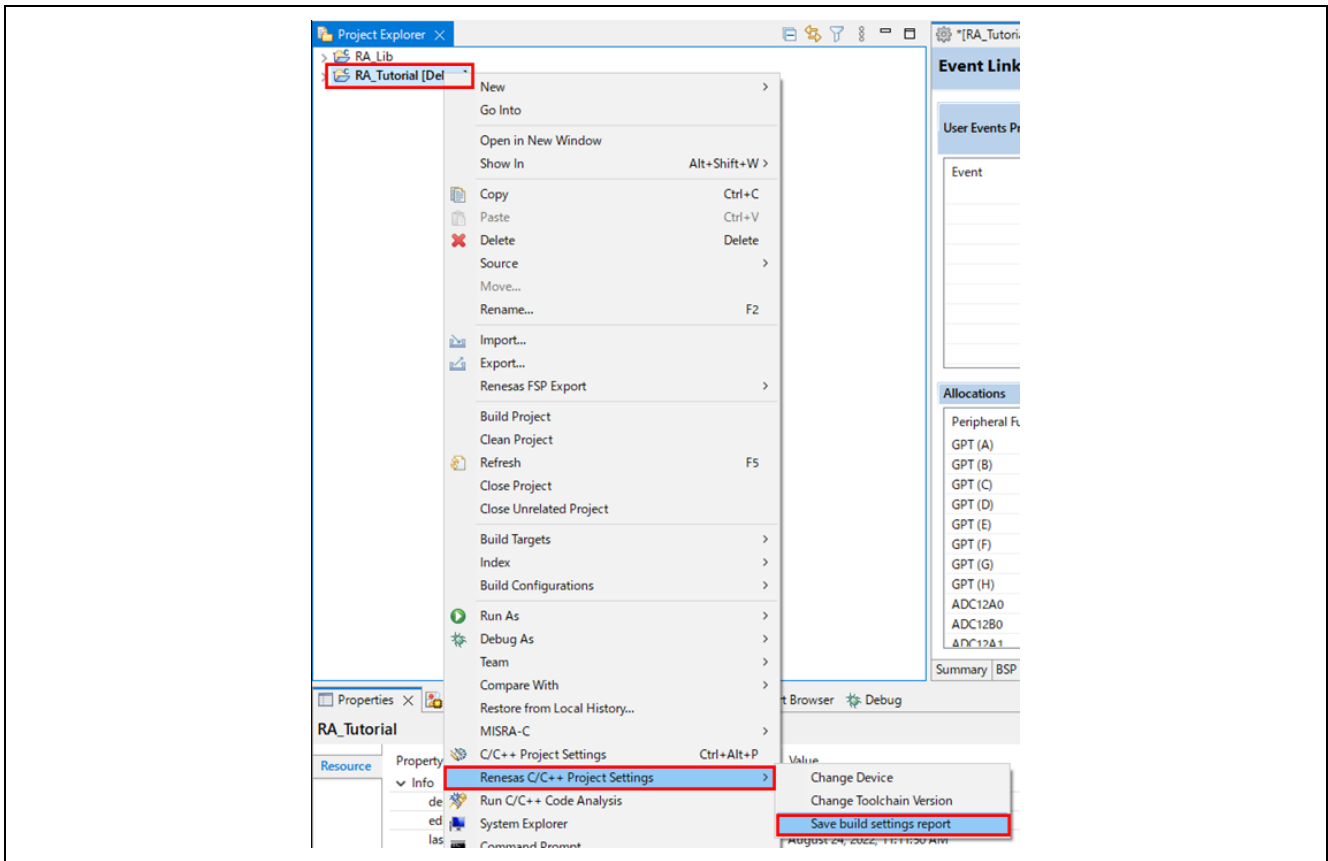

Figure 4-3. Build – Saving the Build Settings Report

## 5. Debugging

This chapter describes how to use debug configuration and key debugging features for e<sup>2</sup> studio. The following illustration refers to the RA project built in Chapter 4.2 Building a Sample Project and based on the following hardware configuration: J-link ARM emulator and RA6M3 EK board.

Right-click on any perspective icon, select **Show Text** to show the name of each icon.

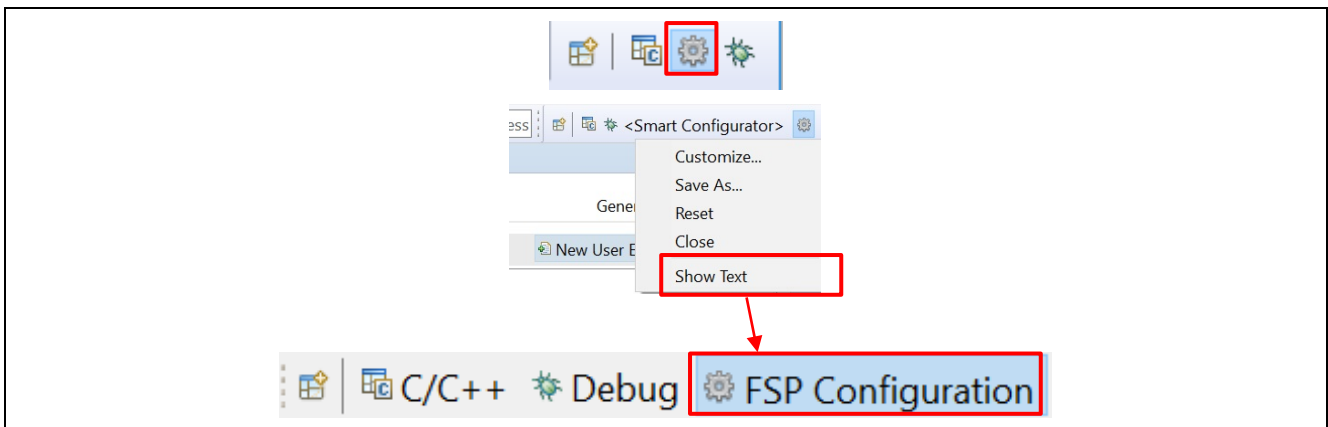

Figure 5-1. Debug – Switch To Debug Perspective

Open the RA project in e<sup>2</sup> studio and click **Debug** to switch to the **Debug** perspective.



As discussed earlier, a **Perspective** in Eclipse defines the layout of panes and views in the **Workbench** window. Each perspective consists of a combination of views, menus and toolbars that enable the user to perform a specific task. For example:

- The **Debug** perspective has views that enable the user to debug the program.
- The **RA Configuration** perspective together with `configuration.xml` in the editor window opens the RA configuration, as well as the **Package** and **Properties** views for project configuration settings.
- The **C/C++** perspective has views that help the user to develop C/C++ programs.

If a user attempts to connect the debugger when not in the **Debug** perspective, e<sup>2</sup> studio prompts the user to switch to the **Debug** perspective.

One or more perspectives can exist in a single Workbench setup. Users can customize them or add new perspectives.

## 5.1 Changing an Existing Debug Configuration

A default debug configuration is automatically created the first time a specific RA project is built. An existing debug configuration can be changed as follows:

1. Click the project name in the **Project Explorer** view to set focus.
2. Click **Run** → **Debug Configurations...** or the  icon (**downward arrow**) → **Debug Configurations...** to open the **Debug Configurations** window.

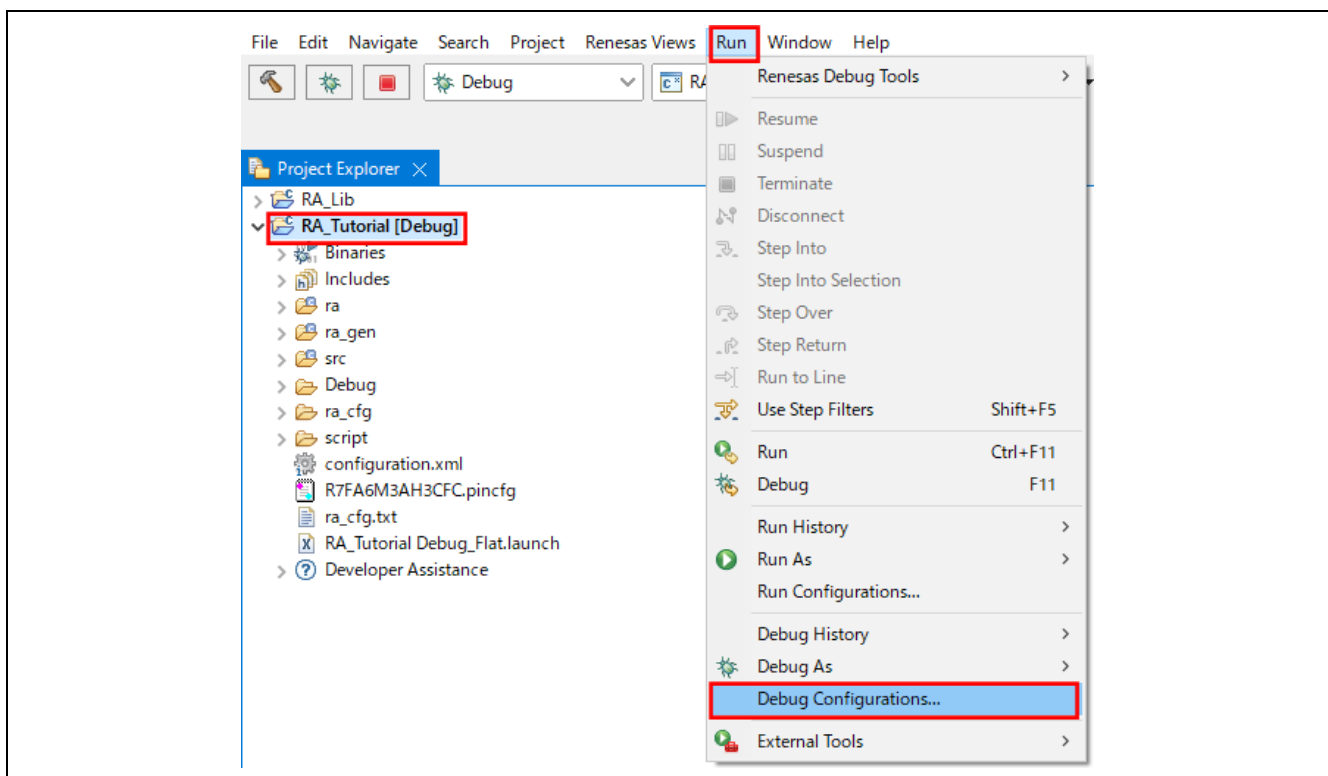

Figure 5-2. Debug – Opening the Debug Configurations Window

3. In the **Debug Configurations** windows, expand the **Renesas GDB Hardware Debugging** debug configuration and click on the existing debug configuration (for example, **RA\_Tutorial Debug\_Flat**).
4. Go to the **Main** tab and browse to add the load module (that is, **RA\_Tutorial.elf**) located in the project build folder.



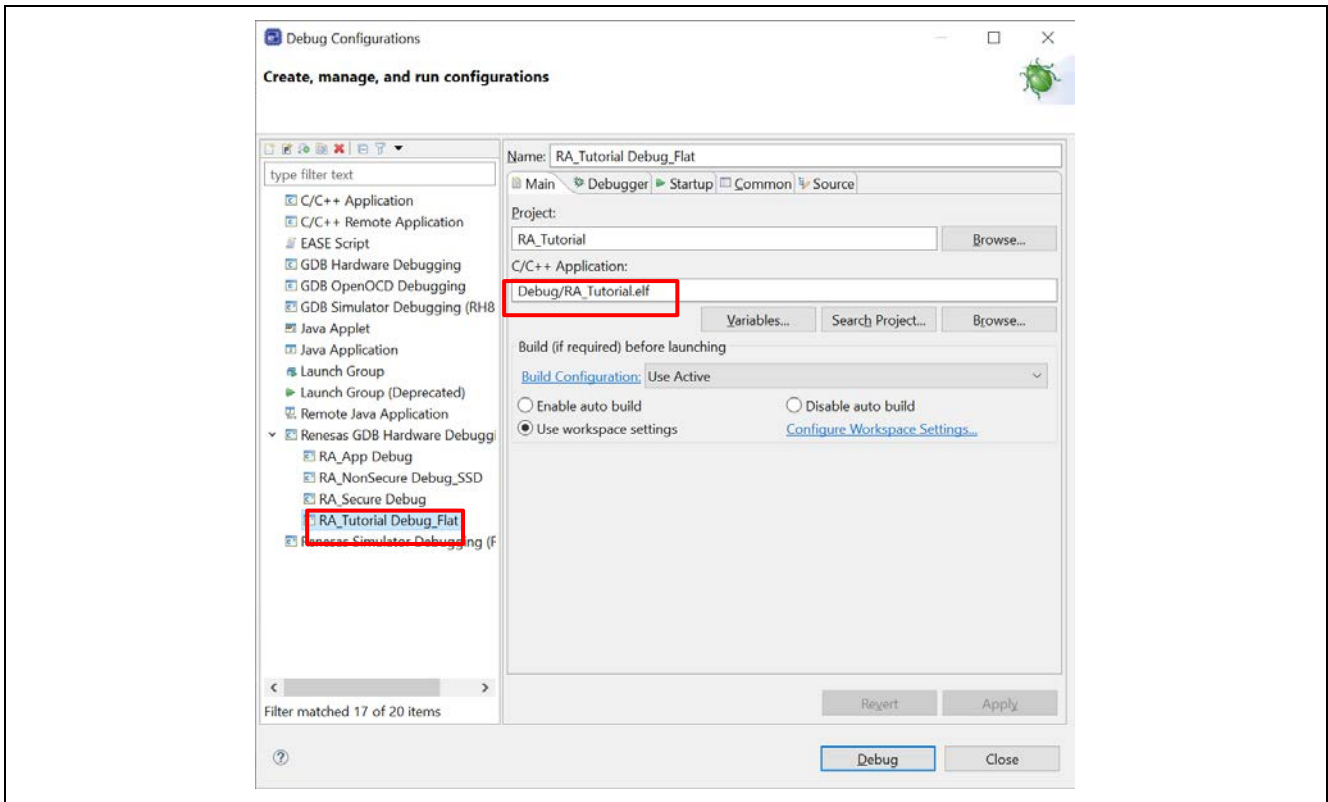

Figure 5-3. Debug – Selecting the Load Module

5. Switch to the **Debugger** tab, set J-Link ARM and R7FA6M3AH as the target device:
  - **Debug Hardware:** J-link ARM
  - **Target Device:** R7FA6M3AH
6. Click the **Apply** button to confirm the settings.
7. Click the **Debug** button to execute the debug launch configuration to connect to the J-Link and the RA board.

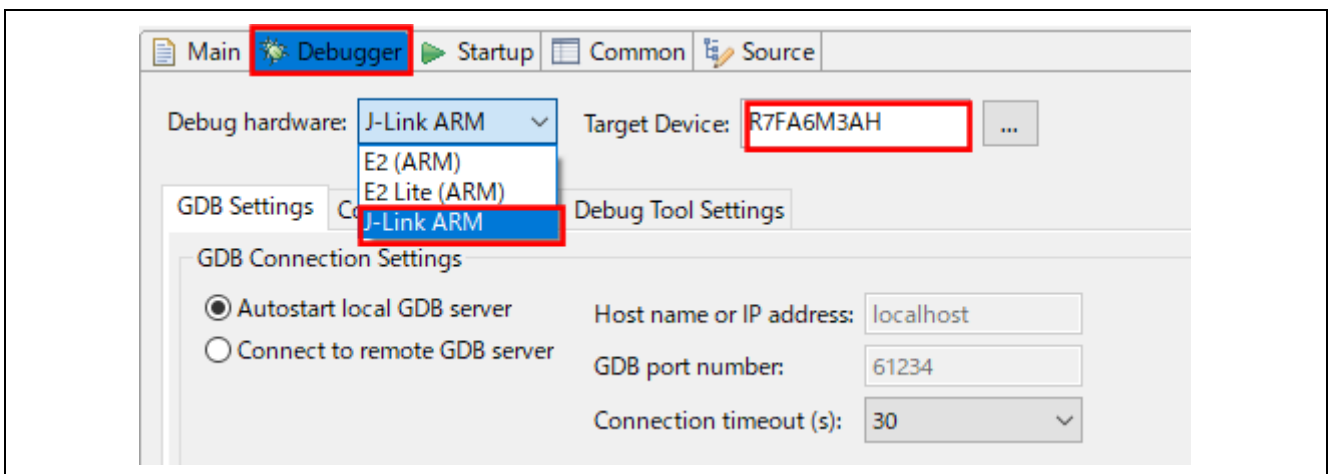

Figure 5-4. Debug – Changing the Connection Settings

8. For a successful connection, the **Debug** view shows the target debugging information in a tree hierarchy. The program entry point is set at `Reset_Handler()` in `startup.c`.

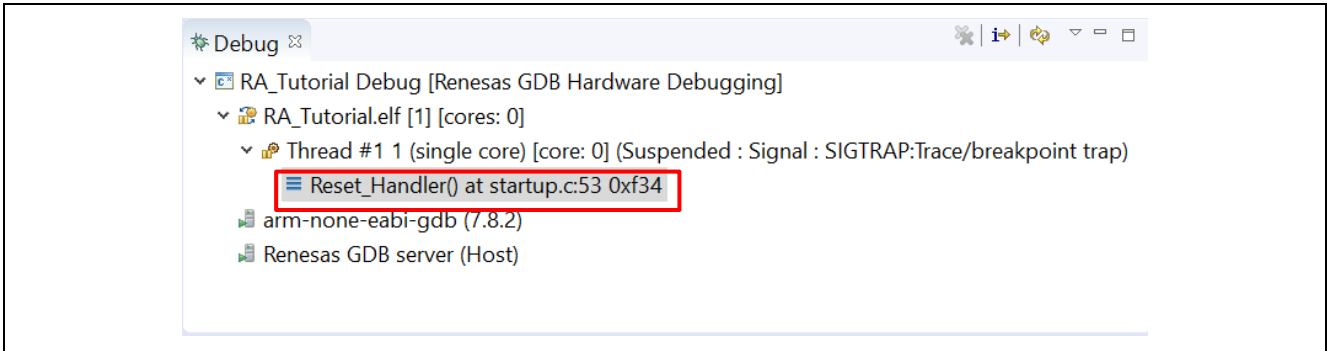



Figure 5-5. Debug – User Target Connection in the Debug View

### 5.2 Creating a New Debug Configuration

The simplest way to create a new debug configuration is by duplicating an existing one. It can be done by the following the steps below:

1. Open the **Debug Configuration** window (refer to Figure 5-2. Debug – Opening the Debug Configurations Window).
2. In the **Debug Configurations** window, select a debug configuration (for example, **RA\_Tutorial Debug**) and click the  icon (which duplicates the currently selected launch configuration). A new debug launch configuration (for example, **RA\_Tutorial Debug (1)**) is created.
3. The new debug configuration can be configured as described in section 5.1.

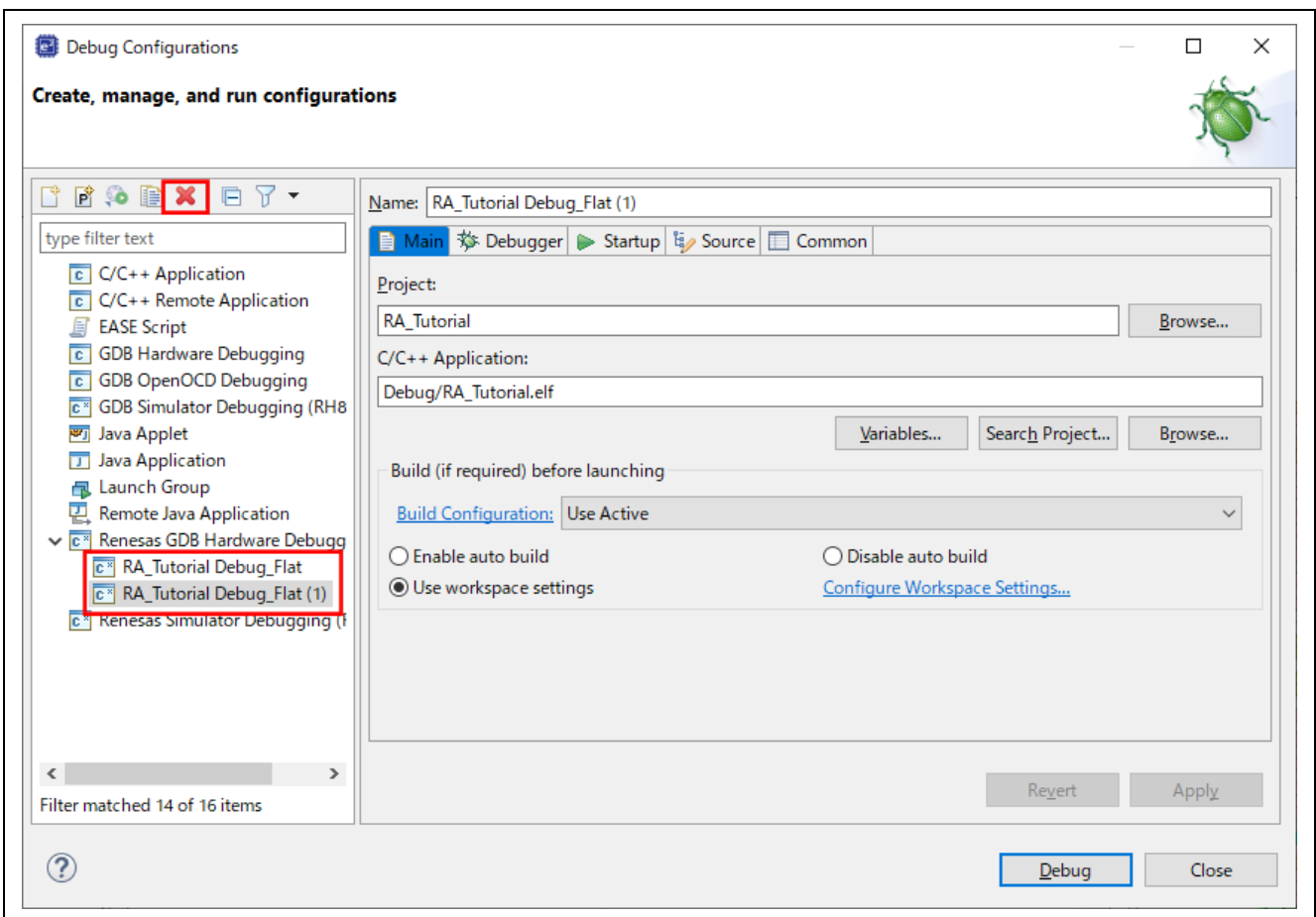

Figure 5-6. Debug – Duplicating a Selected Debug Launch Configuration

### 5.3 Basic Debugging Features

This section explains the typical Debug views supported in e<sup>2</sup> studio:

- Standard GDB Debug (supported by Eclipse IDE framework): Breakpoints, Expressions, Registers, Memory, Disassembly, and Variables (MMU view is not supported in RA).
- Renesas Extension to Standard GDB Debug: IO Registers, Eventpoints, Trace, and Fault Status.

Figure 5-7 shows some useful toolbars in the **Debug** view:

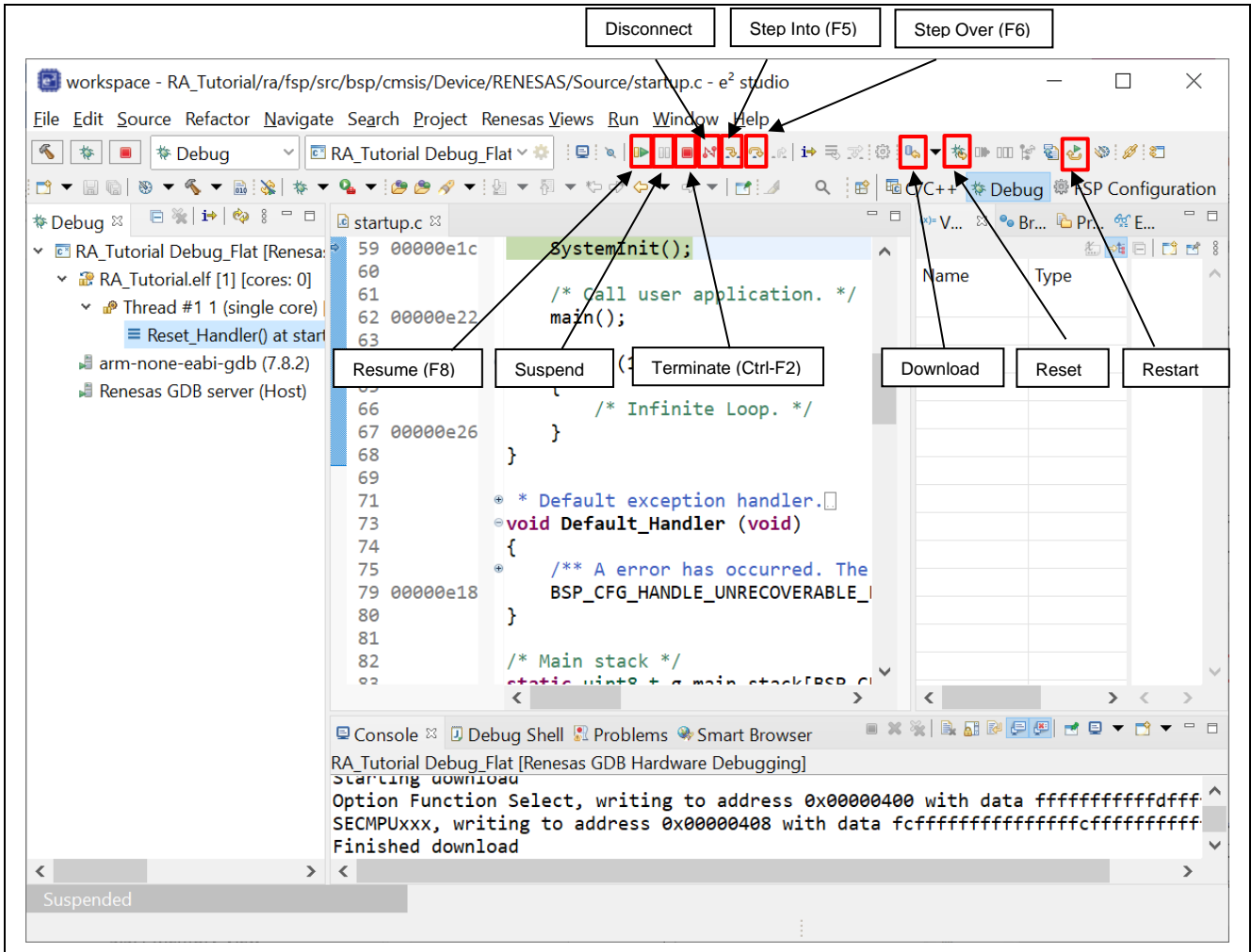

**Figure 5-7. Debug – Useful Toolbars in Debug Views**



Run the program by clicking the button or pressing **F8**.

The program execution can be suspended by breakpoint or by clicking the button. When the program execution is suspended, you can perform the following operations:

- button or **F5** can be used for stepping into the next method call at the currently executing line of code.
- button or **F6** can be used for stepping over the next method call (executing but without entering it) at the currently executing line of code.
- button can be clicked again to resume program execution.

To stop the debugging process, the button can be clicked to end the selected debug session and/or process or the button can be clicked to disconnect the debugger from the selected process.

The other operations are as follows:

- The  button can be clicked to reset and run the program. It may stop at `main()` if the breakpoint is configured in the Debug configuration.
- The  button can be clicked to reset the program to its entry point at the PowerOn Reset.
- The  button is used for re-downloading the binary file to the target system.

### 5.3.1 Debug View

The Debug View shows executed functions per thread.

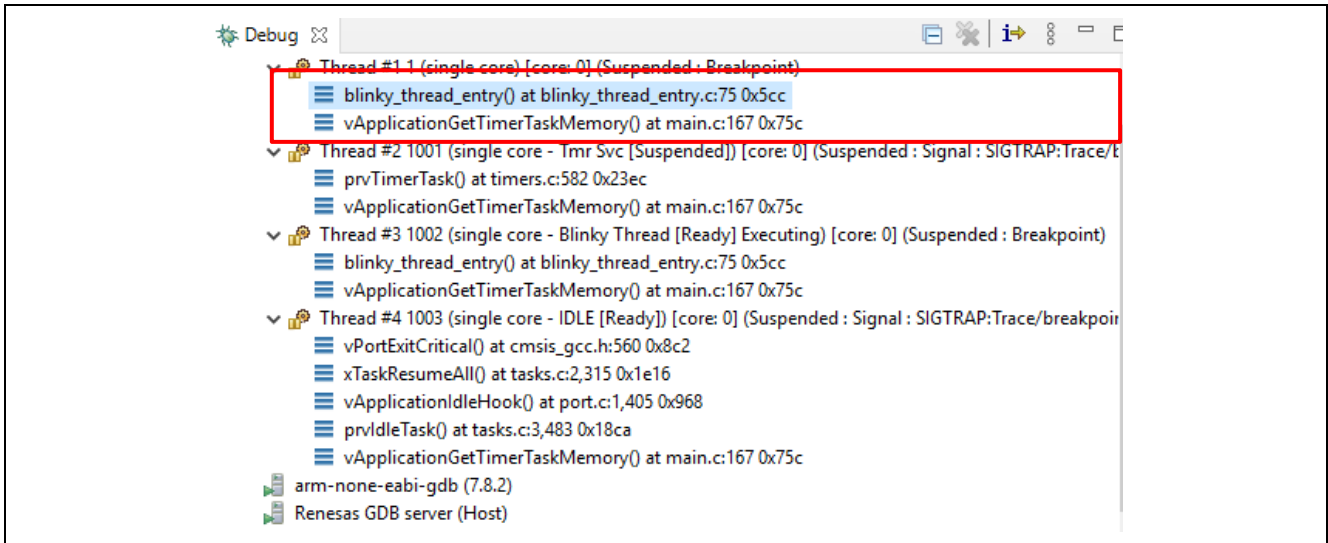

Figure 5-8. Debug – [Debug] View

Enabling the Display of Executed Functions in the Debug View feature is done in the Debug Configurations dialog box:

1. Select the **Run > Debug Configurations** menu and open the **Debug Configurations** dialog box.
2. Select the **Debugger** tab and the **Debug Tool Settings** tab.
3. Set **RTOS Integration in Debug View** to **Yes**. If you select No, this feature is not available. This selection Yes by default.

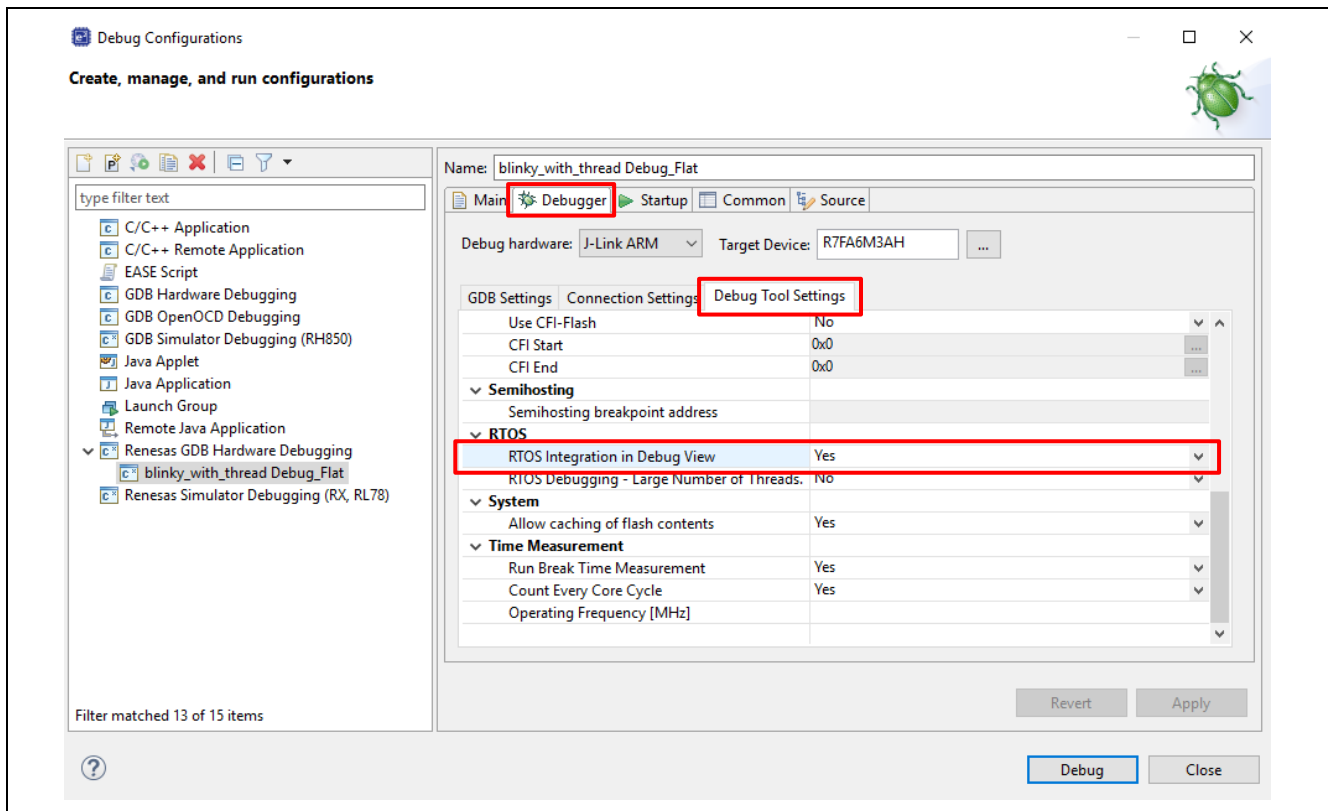

Figure 5-9. Setting – [Debug] View





### 5.3.2 Breakpoints View

The **Breakpoints** view stores the breakpoints that were set on executable lines of a program. If a breakpoint is enabled during debugging, the execution suspends before that line of code executes. e<sup>2</sup> studio allows software and hardware breakpoints to be set explicitly in the IDE. Any breakpoints added by double-clicking on the marker bar are by default hardware breakpoints. If the hardware resources are not present, the breakpoint setting fails. If a hardware breakpoint setting fails, an error message prompts the user to switch to a software breakpoint.





To select a Hardware or Software breakpoint:

1. Right-click on the marker bar to open the context menu.
2. For a hardware breakpoint, select **Breakpoint Types** → **e<sup>2</sup> studio Breakpoint**. For a software breakpoint, select **Breakpoint Types** → **C/C++ Breakpoints**.

To set a breakpoint:

1. As an example, in `startup.c` at line 62, double-click on the marker bar located in the left margin of the **C/C++ Editor** pane to set a breakpoint. A dot  (Hardware breakpoint) or  (Software breakpoint) is displayed in the marker bar depending on the **Breakpoint Type** selected. **Breakpoint Type** is hardware breakpoint by default.
2. Alternatively, right-click at the marker bar to choose **Toggle Hardware Breakpoint** or **Toggle Software Breakpoint** to set a hardware breakpoint  or a software breakpoint .
3. Click **Windows** → **Show View** → **Breakpoints** or icon  (or use shortcut key **ALT+Shift+Q, B**) to open the **Breakpoints** view to view the breakpoints that have been set. Breakpoints can be enabled and disabled in the **Breakpoints** view.

To disable breakpoints, users can choose to disable specific breakpoints or to skip all breakpoints:

1. To disable a specific breakpoint, right-click on the Software breakpoint  or Hardware breakpoint  located in the left margin of the C/C++ Editor pane and select **Disable Breakpoint**, or uncheck the related line in the Breakpoints view. A disabled breakpoint is displayed as a white dot (  or  ).
2. To skip all breakpoints, click on the  icon in the **Breakpoints** view. A blue dot with a backslash appears in the editor pane as well as in the **Breakpoints** view.

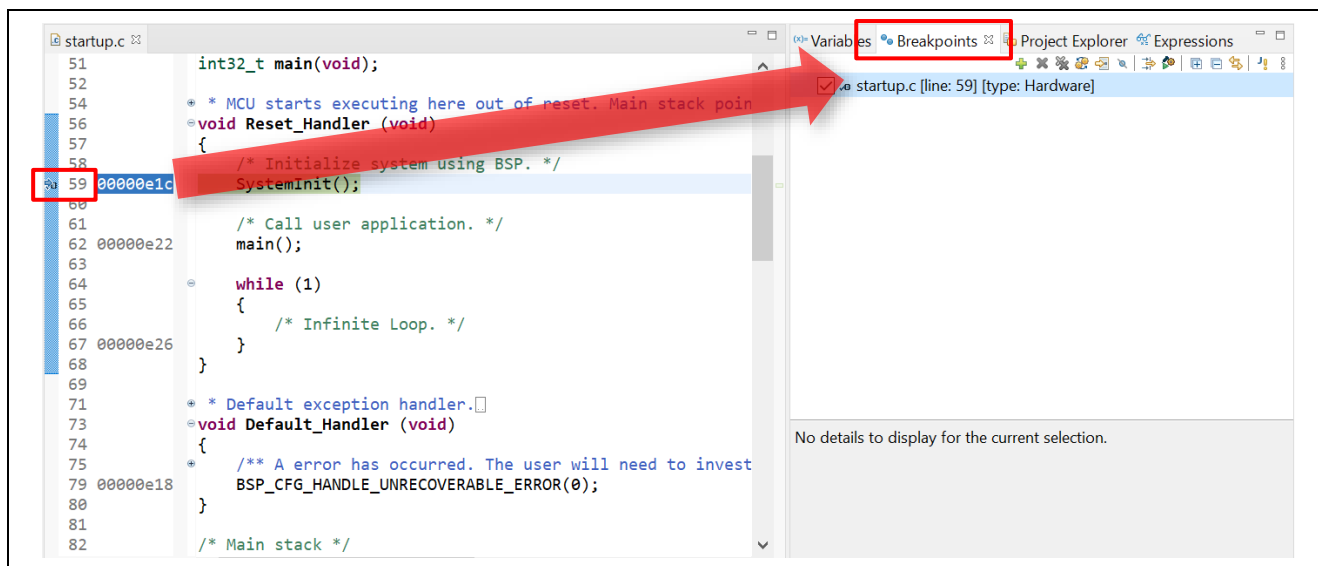

Figure 5-10. Debug – [Breakpoints] View

**Note:** If the following error occurs when setting a software breakpoint in the internal code flash area, "Cannot Insert breakpoint xx in function name at source file name: number of lines: Remote failure reply: FFFFFFFF add software breakpoint"

Refer to the following document to enable flash breakpoints: [E2 Emulator, E2 Emulator Lite Additional Document for User's Manual \(Notes on Connection of RA Devices\) \(renesas.com\)](#), section 3.3.2.

Notes on a Debugging Operation that Involves Reprogramming of Flash Memory”-(7) Conditions for using software breaks in flash memory” and enable flash breakpoints.

### 5.3.3 Expressions View

The Expressions view monitors the value of global variables, static variables, or local variables during debugging.

Follow the steps below to watch a variable:

1. Click **Windows** → **Show View** → **Expressions** or icon  to open the **Expressions** view.
2. Drag and drop a variable (for example, `g_fsp_version` in `bsp_common.c`) to the **Expressions** view.
3. Alternatively, right-click the variable to select the **Add Watch Expression...** menu item to add it to the **Expressions** view.

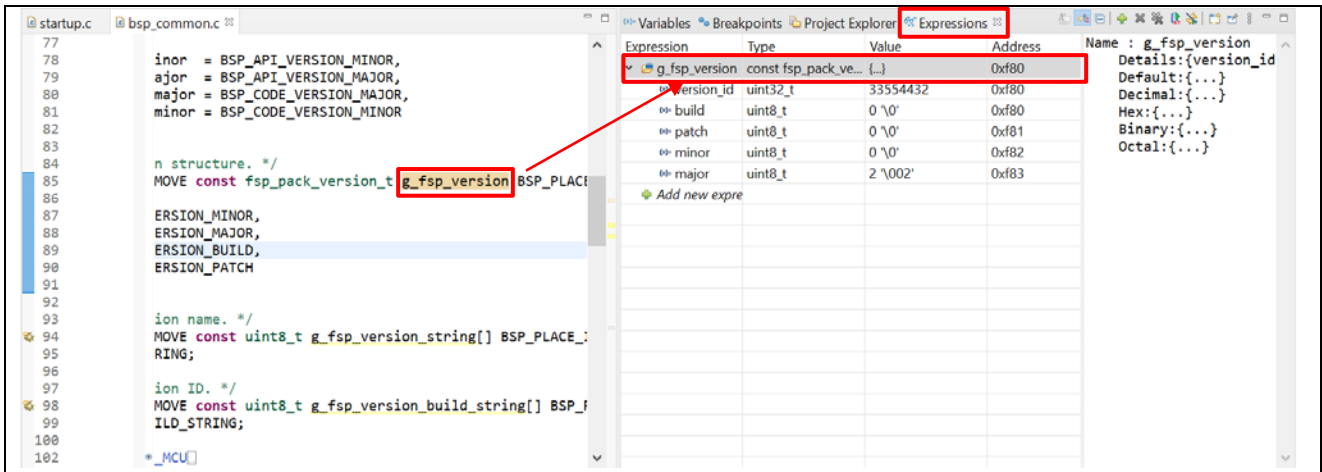



Figure 5-11. Debug - [Expressions] View

### 5.3.4 Registers View

The **Registers** view lists the information about the general registers in RA. Changed values are highlighted when the program stops.

1. Click **Windows** → **Show View** → **Registers** or icon  to open the **Registers** view.
2. Click a register to view the values in different radix format.

Values that have been changed are highlighted (for example, in yellow) in the **Registers** view when the program stops.

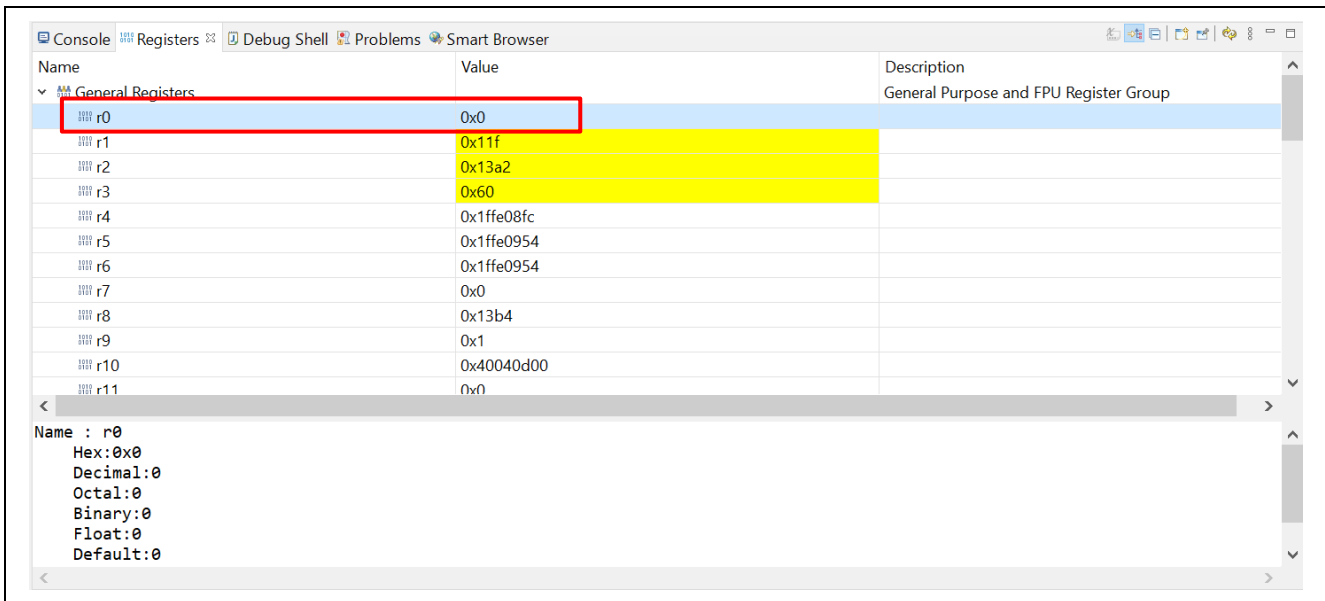



Figure 5-12. Debug – [Registers] View

### 5.3.5 Memory View

The **Memory** view allows users to view and edit the memory presented in “memory monitors”. Each monitor represents a section of memory specified by its location called “base address”. The memory data in each memory monitor can be presented in different “memory renderings”, which are the predefined data formats (for example, Hex integer, signed integer, unsigned integer, or ASCII, image).



To view the memory of a variable (for example, `g_fsp_version_build_string`):

1. Click **Windows** → **Show View** → **Memory** to open the **Memory** view.
2. Click the icon  to open the Monitor Memory dialog box. Enter the address of the variable `&g_fsp_version_build_string`.

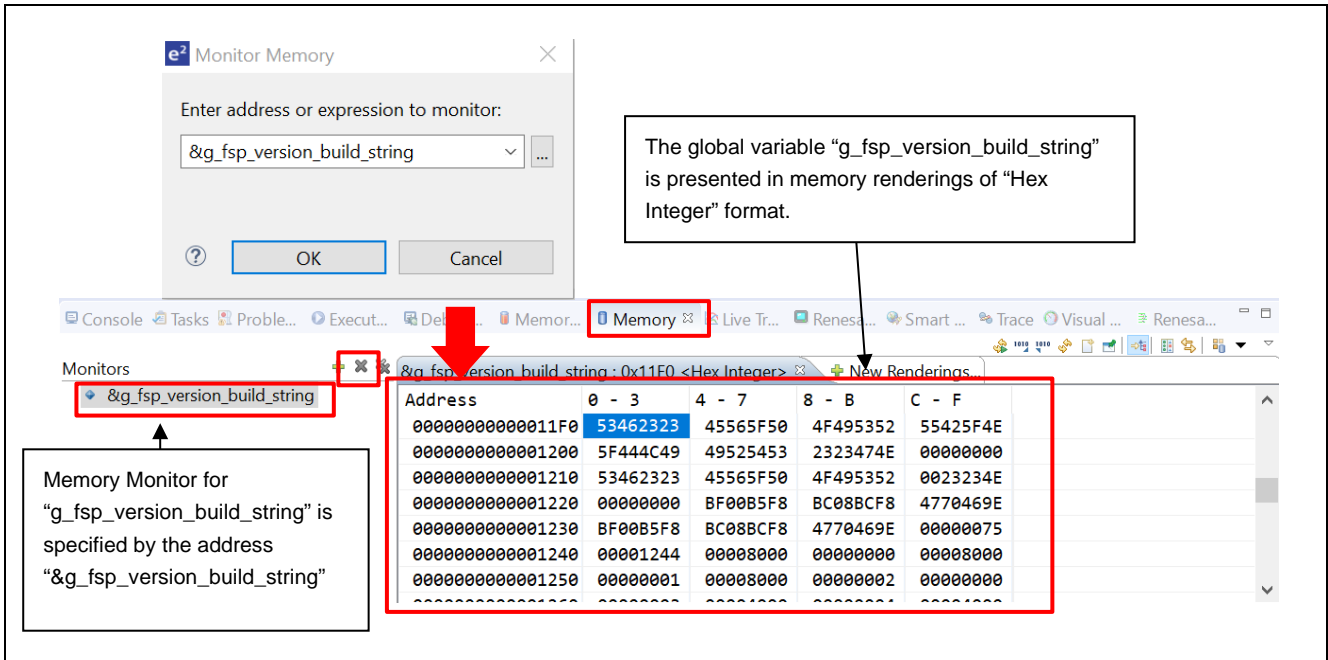



Figure 5-13. Debug – Memory View

To add a new rendering format (for example, ASCII) for the variable `g_fsp_version_build_string`, click the tab  **New Renderings...** to select **ASCII** to add the rendering. This creates a new tab named `&g_fsp_version_build_string <ASCII>` next to the tab `&g_fsp_version_build_string <Hex Integer>`.



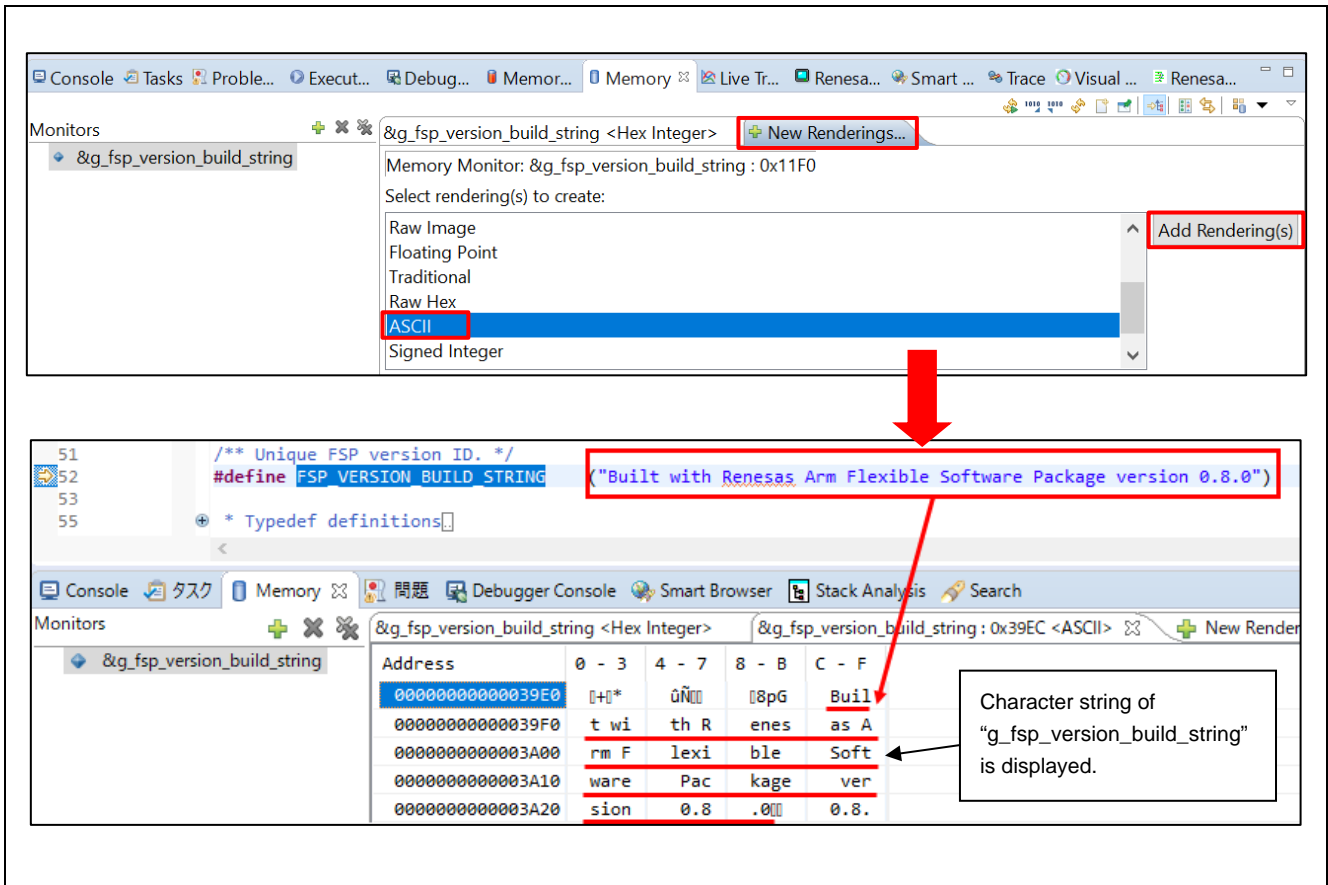

Figure 5-14. Debug – New Rendering in Memory View

### 5.3.6 Memory Usage View

**Memory Usage** will be used to get the information of (\* .map) file or library list file (,) from a project. This will list out the total memory size, usage of ROM and RAM ratio, and detailed information of sections, objects, symbols, module, vector, and cross reference used in project.

From version 7.3, e<sup>2</sup> studio supports the graphical view to show usage in the ROM and RAM memory areas.

To show the **Memory Usage** view, click menu **Window** → **Show View** → **Other...** → **C/C++**. In the **Show View** dialog, select **Memory Usage** and click **Open**.

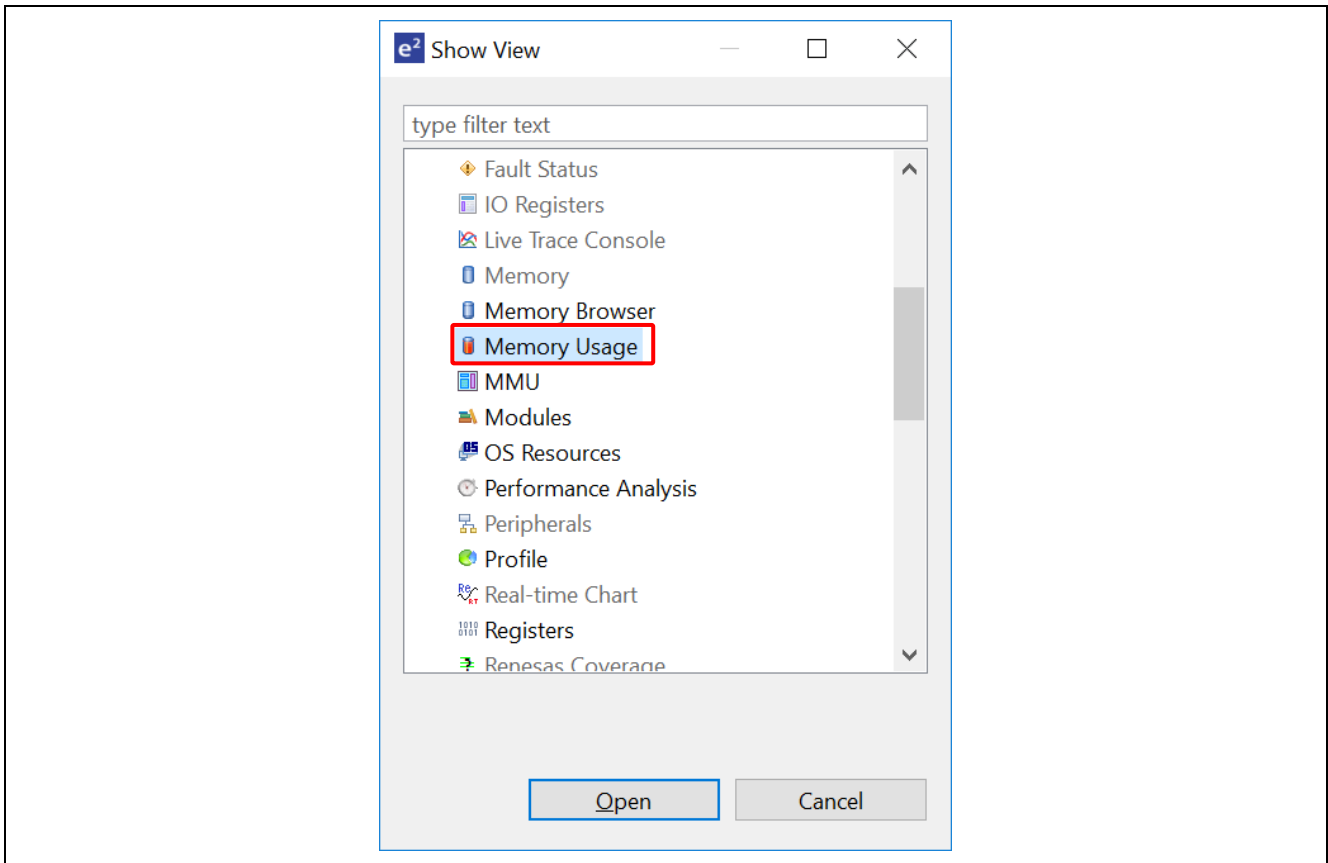

Figure 5-15. Show Memory Usage View

The **Memory Usage** view has three regions: (1) Group Size region, (2) Memory Region Usage region (Device Memory Usage region is not supported yet), and (3) Detail table region.

Note: When the selected project does not contain the linker script file or there is no region defined in the linker script file, the **Memory Region Usage** region displays a warning message: “Linker script file is invalid”.

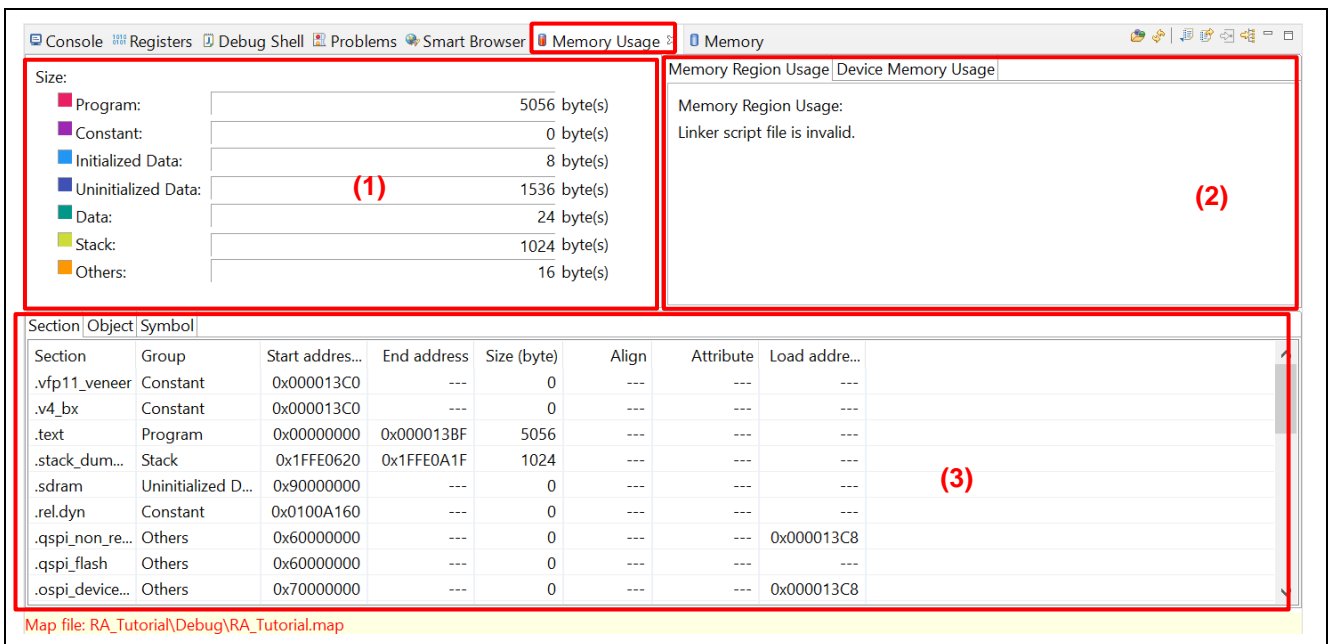







Figure 5-16. Regions of Memory Usage Views

The following operations are supported in the **Memory Usage** view:

- : Choose a map or library list file for **Memory Usage** display.
- : Refresh all information of **Memory Usage** view.
- : Export data for all tabs in the **Detail** table region
- : Open \*.map or \*.lbp file in Editor (there is no library list file in the RA library project).
- : Open the Map file output page of selected project.
- : Open the Section page of selected project.

### 5.3.7 Disassembly View

The **Disassembly** view shows the loaded program as assembler instructions mixed with the source code for comparison. The currently executing line is highlighted by an arrow marker in the view. In the **Disassembly** view, users can set breakpoints at assembler instructions, enable or disable these breakpoints, step through the disassembly instructions, and even jump to a specific instruction in the program.

To view both C and assembly codes in a mixed mode:

1. Click **Windows** → **Show View** → **Disassembly** to open the **Disassembly** view.
2. Click icon  to enable the synchronization between assembly source and the C source (active debug context).
3. In **Disassembly** view, right-click at the address column to select **Show Opcodes** and **Show Function Offsets**.

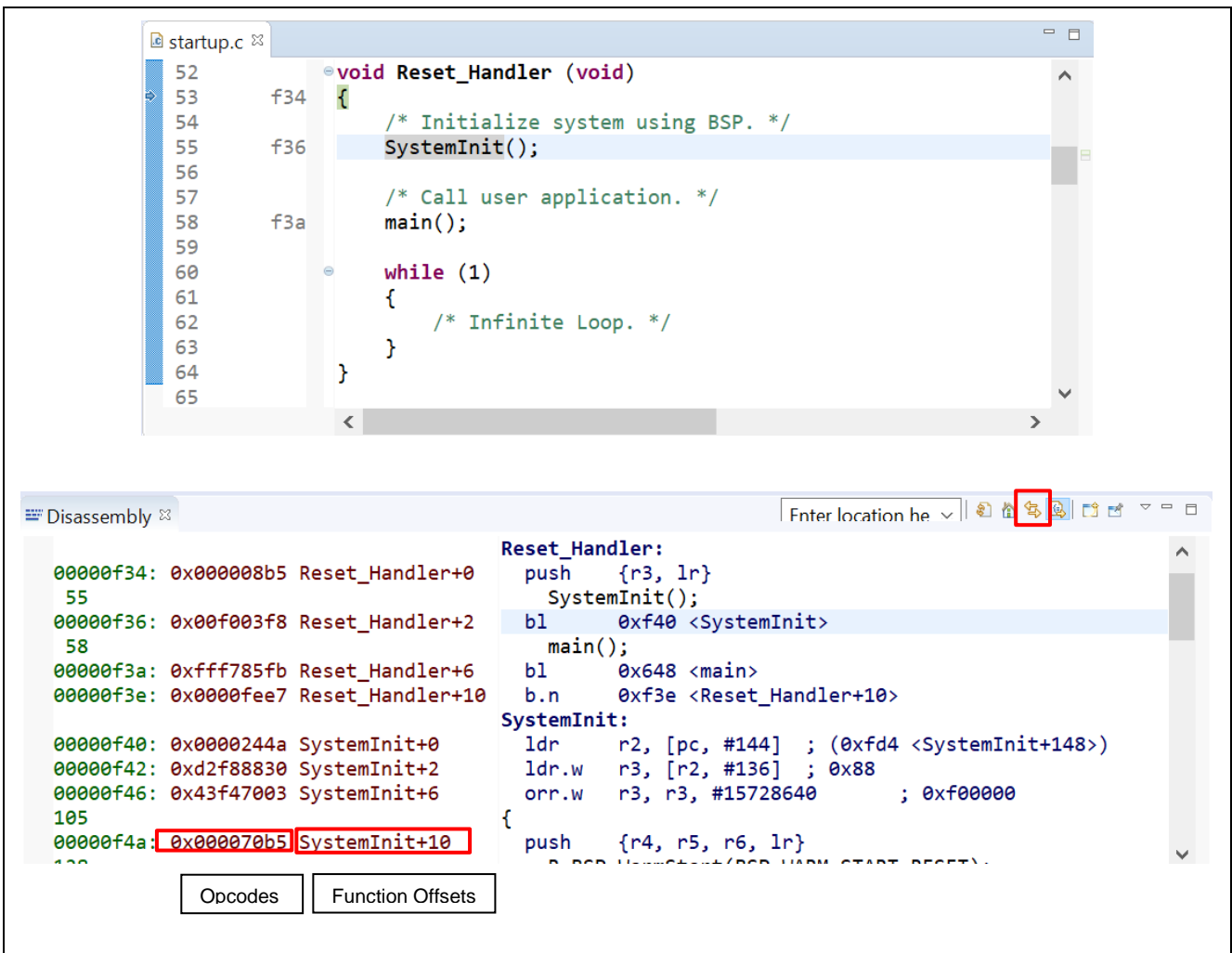

Figure 5-17. Debug – Disassembly View

### 5.3.8 Variables View

The **Variables** view displays all the valid local variables in the current program scope.

To observe a local variable (for example, leds for function hal\_entry ( )):

1. Click **Windows** → **Show View** → **Variables** to open the **Variables** view.
2. Step into the function hal\_entry ( ) to view the local variable **timeout** value.

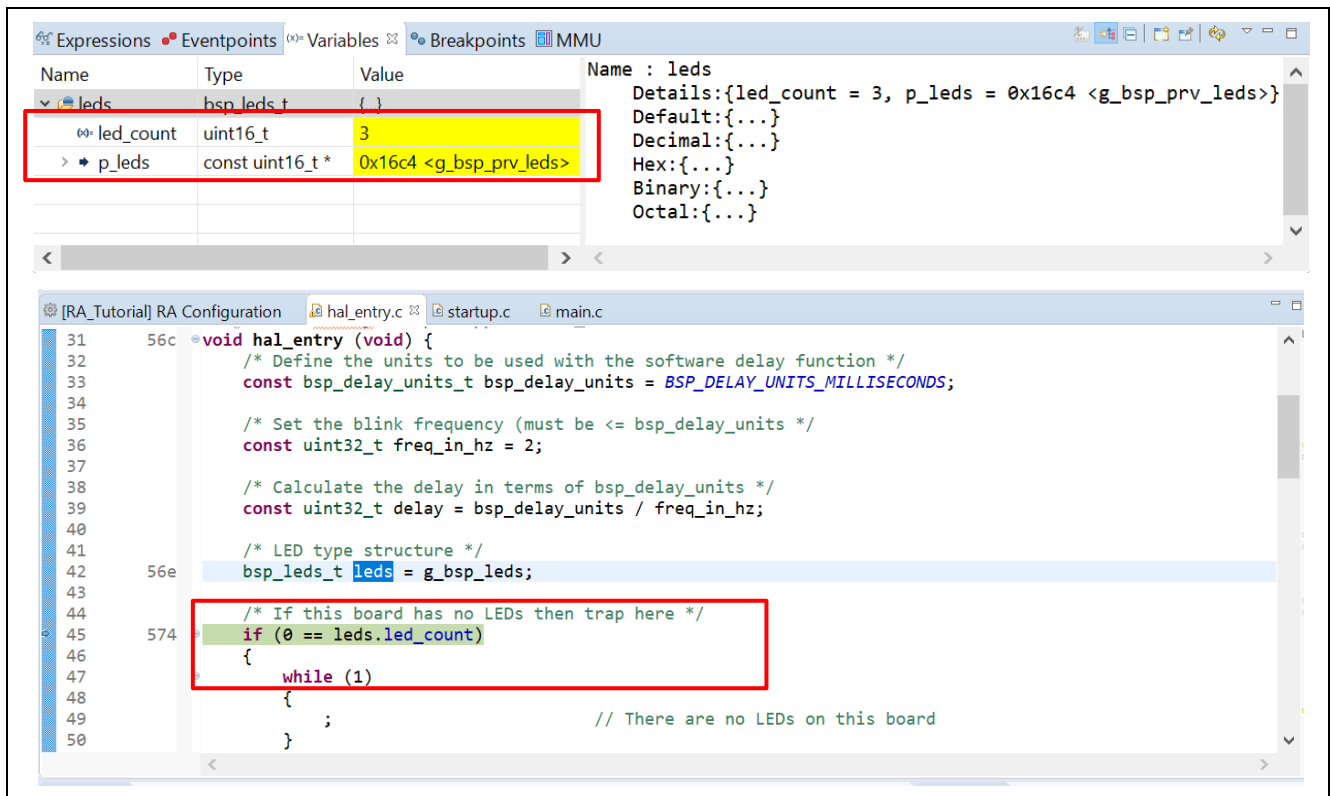

Figure 5-18. Debug – Variables View

### 5.3.9 IO Registers View

The IO Registers are also known as the Special Function Registers (SFRs). The **IO Registers** view displays all the registers defined in a target-specific IO file. Users can further customize the **IO Registers** view by adding specific IO registers to the **Selected Registers** pane.

To view selected IO registers:

1. Click **Renesas Views** → **Debug** → **IO Registers** to open the **IO Registers** view.
2. Under the **All Registers** tab, locate a module (for example, CAC) in the **IO Registers** view. Expand its IO register list.
3. Drag and drop its registers (the CAICR and CASTR) to the **Selected Registers** pane. A green dot next to the IO register indicates the status of being a selected register.
4. Switch to the **Selected Registers** tab to view the selected IO Registers.

The expanded IO register list may take more time to load in the **All Registers** pane. Hence, it is advisable to customize and view multiple selected IO registers from the **Selected Registers** pane.

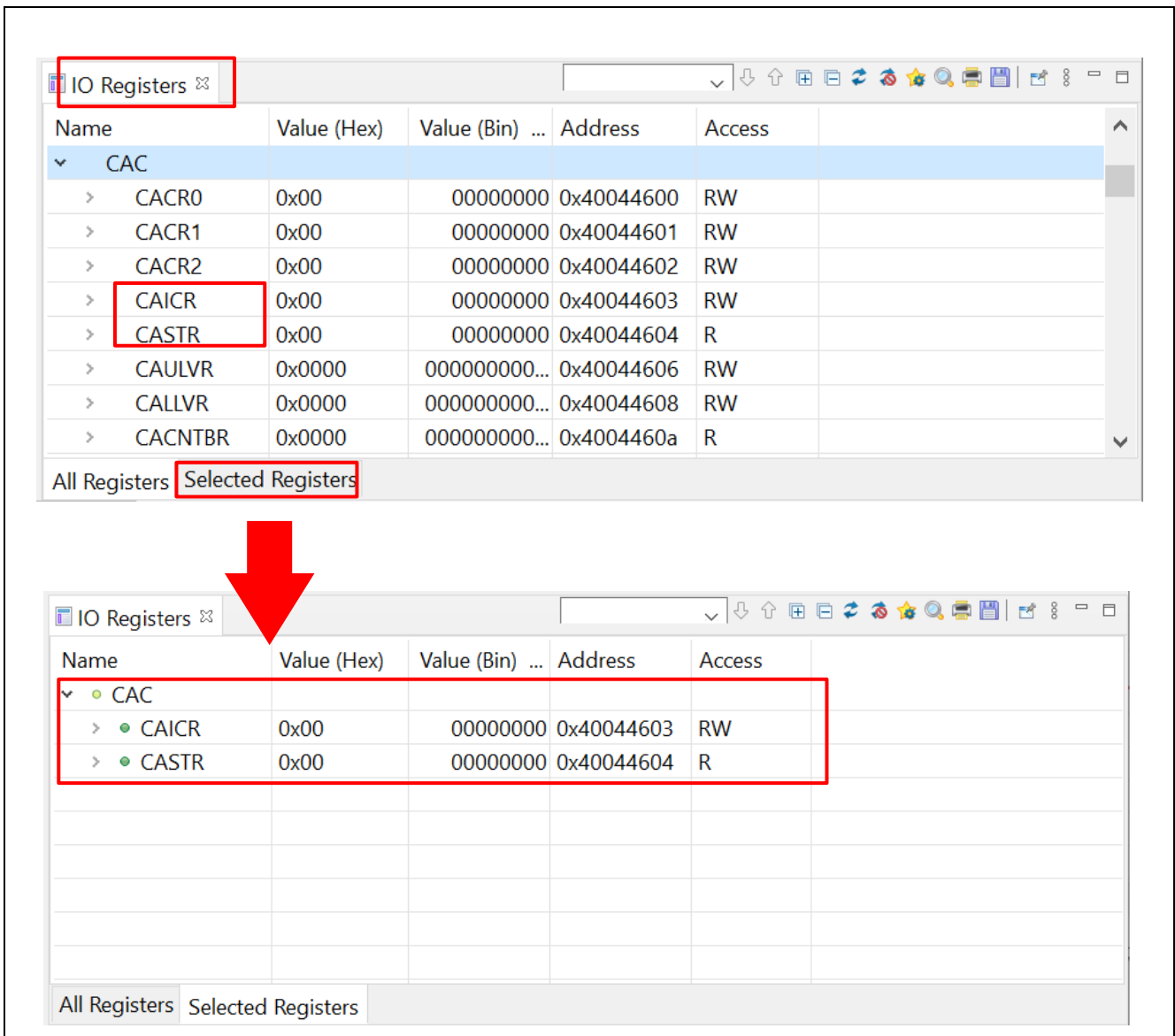

Figure 5-19. Debug – IO Registers View

### 5.3.10 Eventpoints View

An 'event' refers to a combination of conditions set for executing break or trace features during program execution. The **Eventpoints** view enables users to set up or view defined events of different categories, for example, trace start, trace stop, or event break.

Data access event break is supported for RA projects. The emulator detects access under a specified condition to a specified address or a specified address range. This allows complex address and data matching criteria to be set up.

Event combination (OR, AND (cumulative) and Sequential) can be applied to two or more events.

**Table 5-1. Event combination**

Event combination	Explanation
OR	The condition is met when any one of the specified events occurs.
AND (cumulative)	The condition is met when all of the specified events occur regardless of the timing.
Sequential	The condition is met when the specified events occur in a specified order.

To set an event break for a global variable when address/data is matched (for example, when `g_bsp_leds` is accessed):

1. Click Renesas Views → Debug → Eventpoints to open the Eventpoints view.
2. Double-click the **Event Break** option to open the **Edit Event Break** dialog box.
3. Click the **Add...** button to continue.

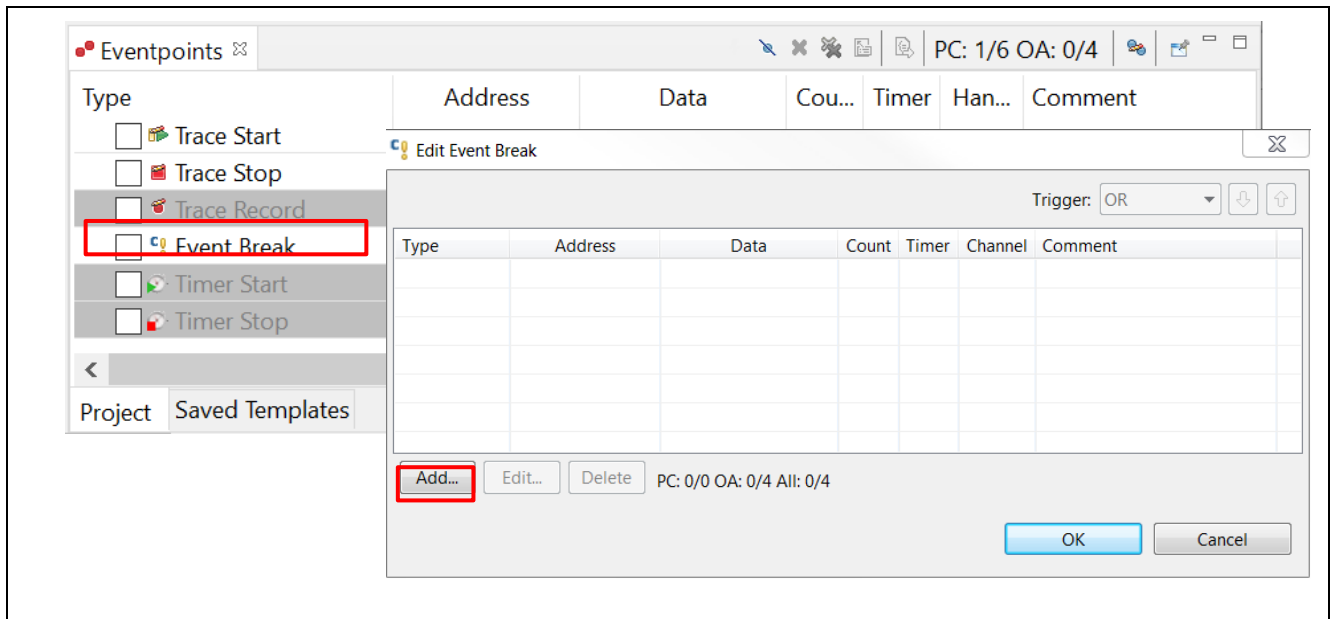

**Figure 5-20 Debug – [Eventpoints] View (1/2)**

4. Select the **Data Access** eventpoint type.
5. Go to the **Address Settings** tab and click the [...] icon to browse for the symbol `g_bsp_leds`. (The address of this global variable is `&g_bsp_leds`.)
6. Next, switch to the **Data Access Settings** tab and set the **Read/Write** selection to **Read**.
7. Click **OK** to proceed.

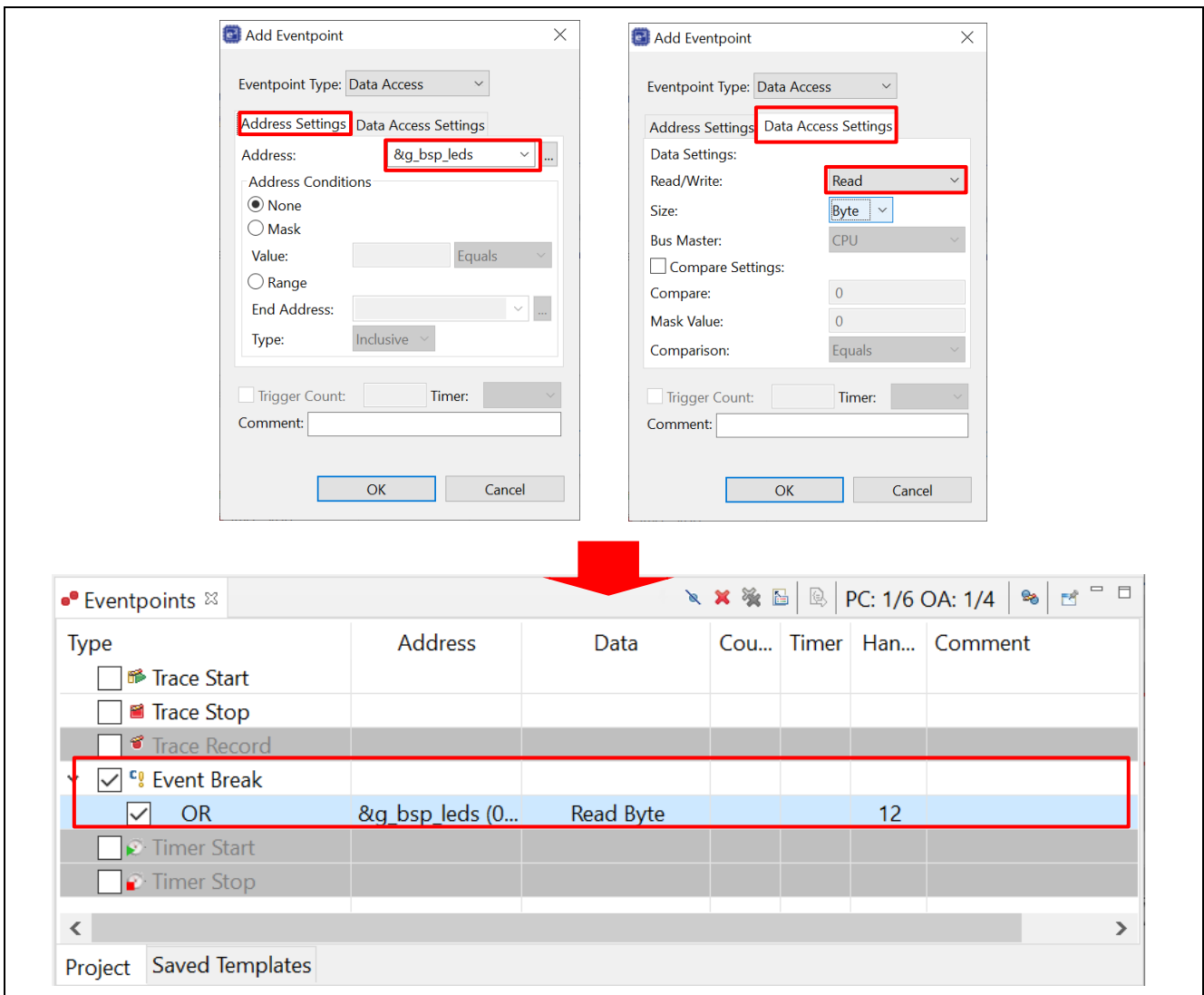

Figure 5-21 Debug – Eventpoints View (2/2)

8. Perform a reset to execute the program from the start.

Figure 5-22 shows that when the variable `g_bsp_leds` is accessed (read), the program stops.

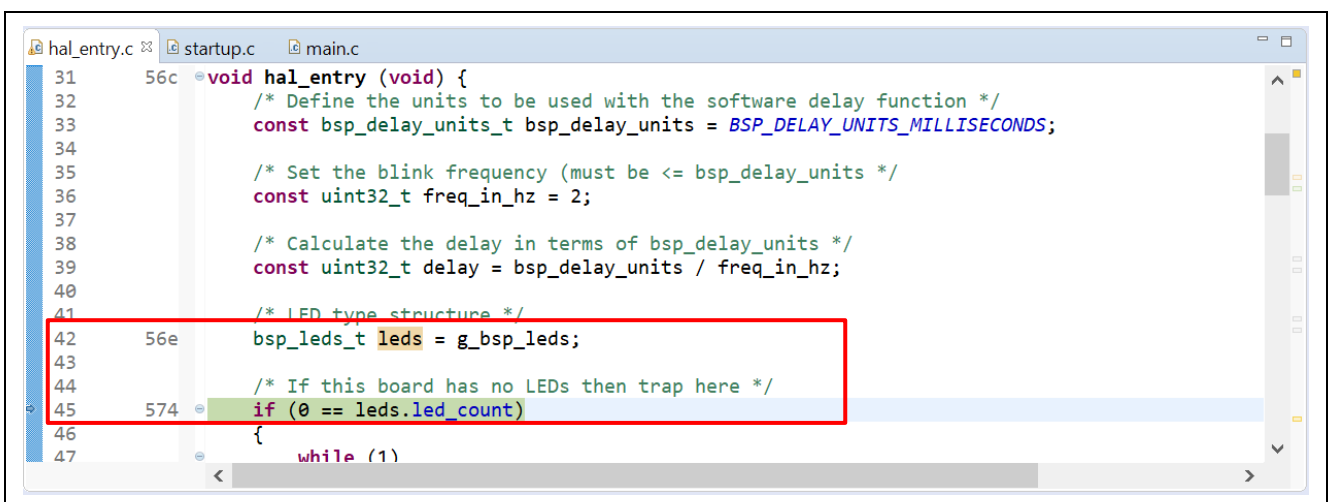

Figure 5-22. Debug – Execution of Event Break



### 5.3.11 Trace View

Tracing means the acquisition of bus information per cycle from the trace memory during user program execution. The acquired trace information is displayed in the **Trace** view. It helps users to track the program execution flow to search for and examine the points where problems arise.

The trace buffer is limited, therefore older trace data is overwritten with new data after the buffer becomes full.

To set a trace until the program is suspended:

1. Click **Renesas Views** → **Debug** → **Trace** to open the **Trace** view.
2. Turn on the **Trace** view by selecting the  icon.

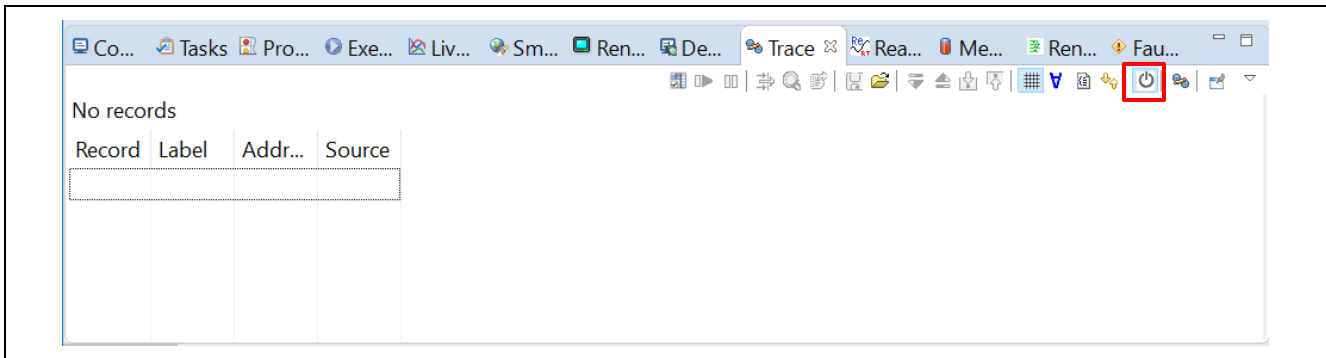

Figure 5-23. Debug – Turn on Trace View

3. Execute the program and stop program execution by using a breakpoint or by pressing the **Suspend** button on the **Debug** toolbar. The content stored in trace memory at that point in time is displayed as trace result.
4. Select the display mode by clicking on the corresponding button. Figure 5-24 shows the trace result before the `main()` function is executed.

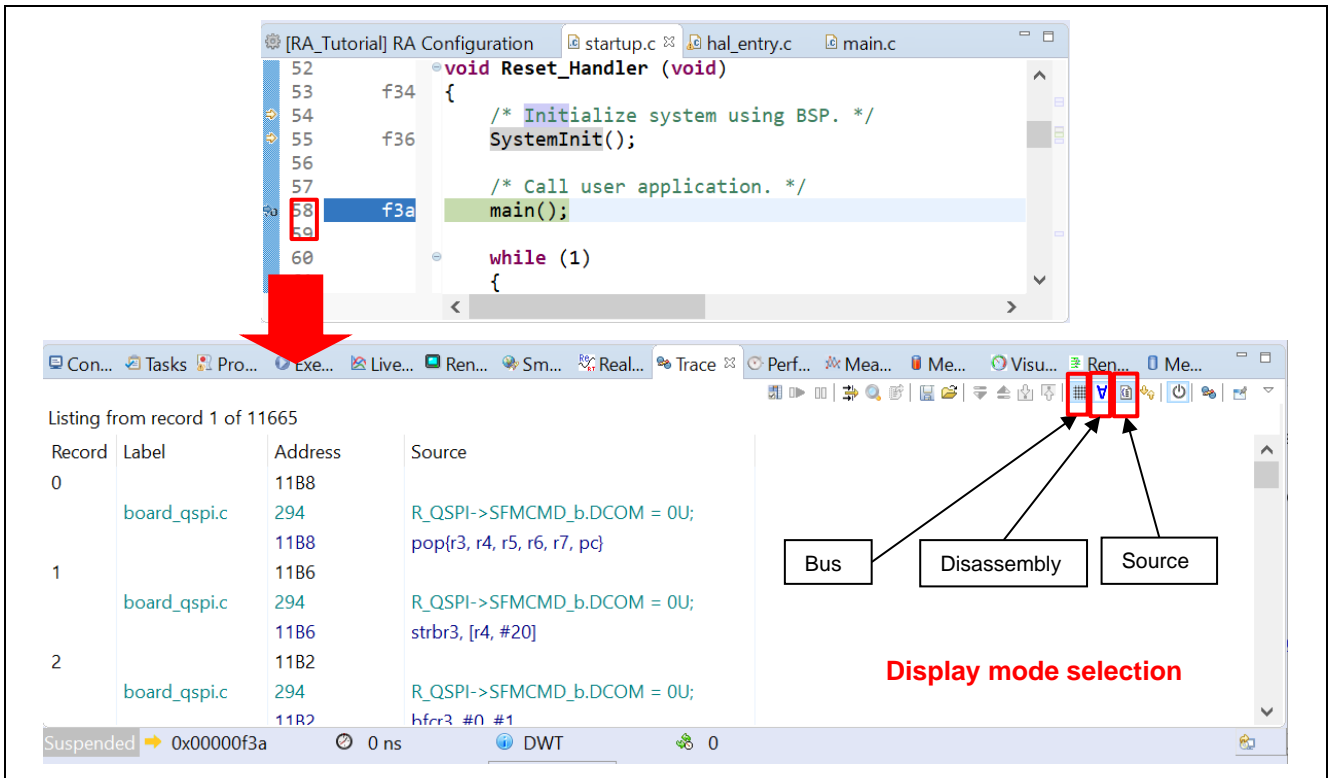

Figure 5-24. Debug – Select Display Mode in Trace View

The trace records are displayed from oldest data to latest data by default. The display order can be changed by clicking the button.

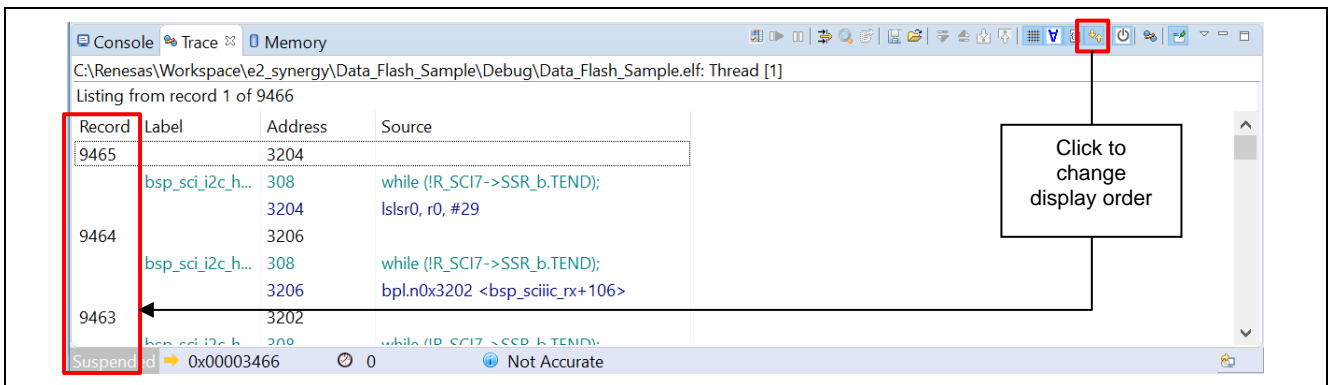

Figure 5-25. Changing the Display Order

The trace result can be filtered by clicking on button. You can select filtering by **Record** and/or **Address**.

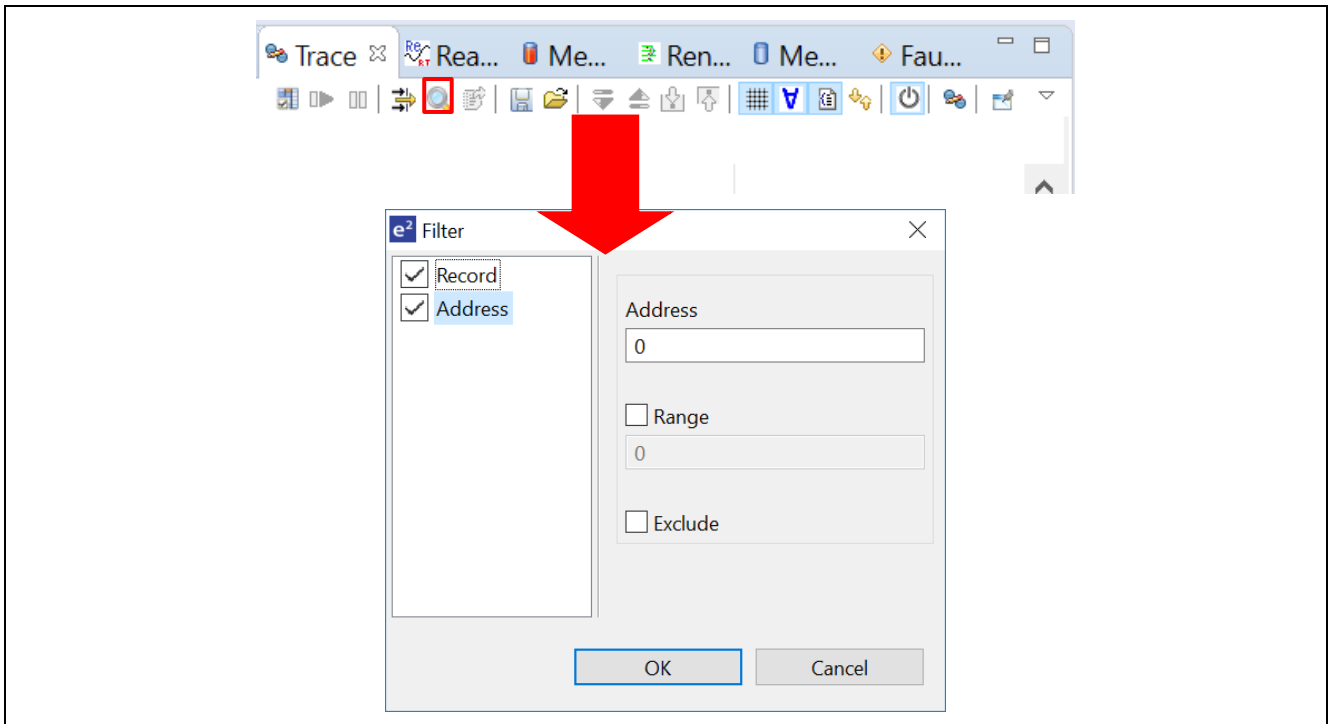

Figure 5-26. Debug – Filter Trace Result

The trace result can be saved to a .csv file (with the inclusion of bus, assembly, and source information). **Trace** view also allows loading trace results from a .csv file.

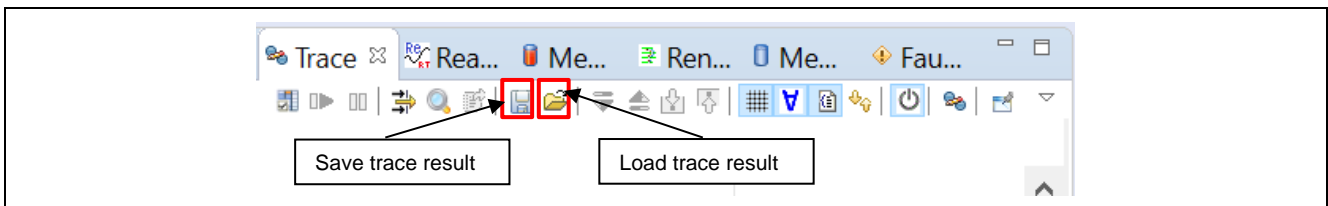

Figure 5-27. Debug – Save and Load Trace Result

### 5.3.12 Fault Status View

The **Fault Status** view shows the bit status of several fault status registers and the value of the key register to the user when a hardware fault crash occurs. When a hardware fault occurs, the bits of the register related to the cause of the fault are checked and the r0, r1, r2, r3, r12, lr, pc, and psr register values are displayed. This is shown in Figure 5-28. This function is available in e<sup>2</sup> studio v5.2 and above.

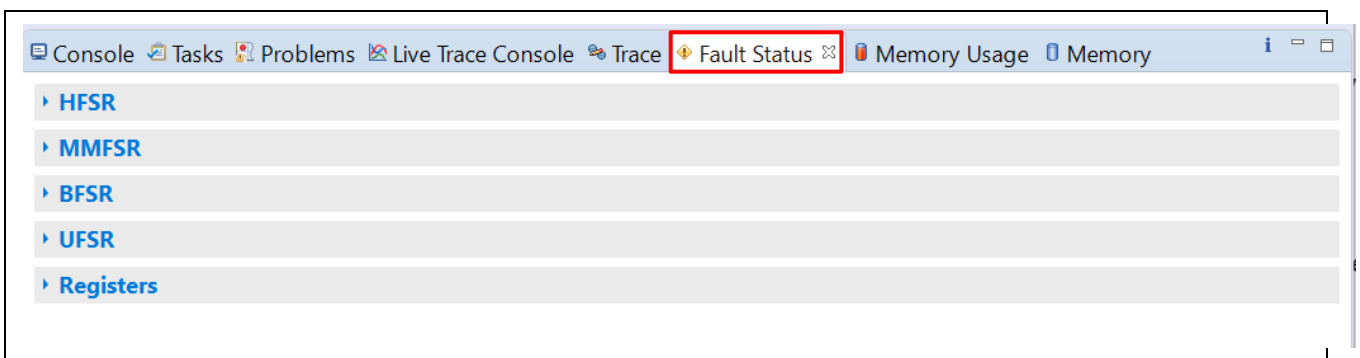

Figure 5-28. [Fault Status] No Hardware Fault

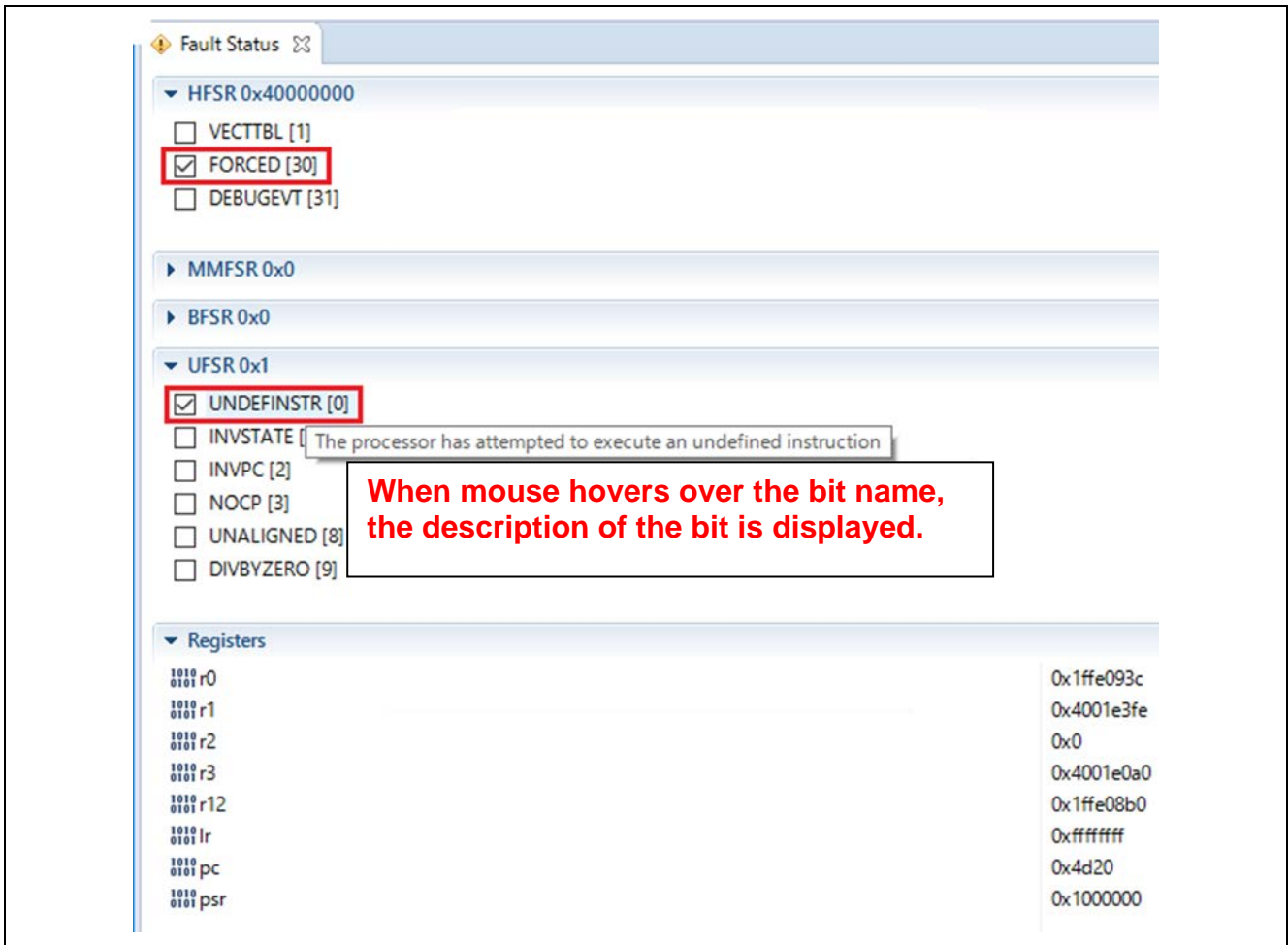

Figure 5-29. Fault Status Hardware Fault Occurred

### 5.3.13 Run Break Timer

The **Run Break Timer** feature allows the user to see the last execution performance on the status bar. When the program is suspended, the user can check the current program counter (PC), the last execution timing either in time or CPU cycles, and the accuracy or measurement method used.



## 6. Setting up a FreeRTOS Application

This example shows how to generate and build an RA project to include FreeRTOS objects and General Purpose Timer (GPT) module using the project template **FreeRTOS – Blinky – Static Allocation**.

### 6.1 General Purpose Timer Example in FreeRTOS

In the **FreeRTOS – Blinky – Static Allocation** RA project from **Project Template Selection**, LEDs are blinked by putting the task to delay for a while before toggling the LEDs state.

In this example, instead of a delay, the Blinky Thread waits for a semaphore and a timer interrupt (generated by GPT) which puts this semaphore every 1 second so that thread can resume.

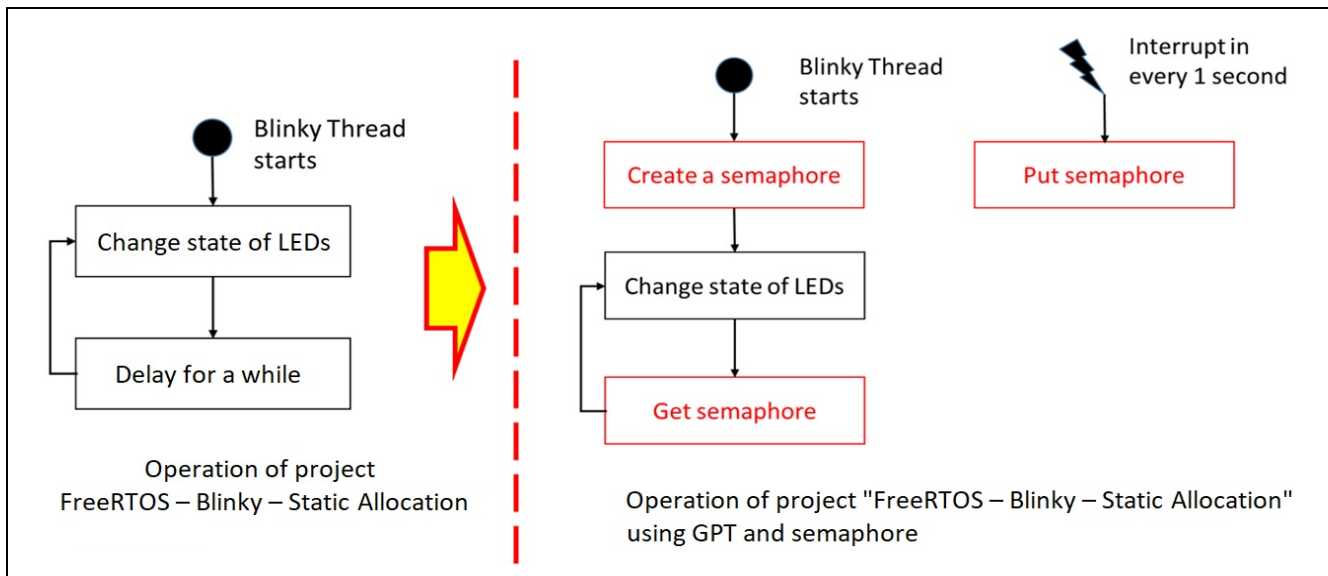
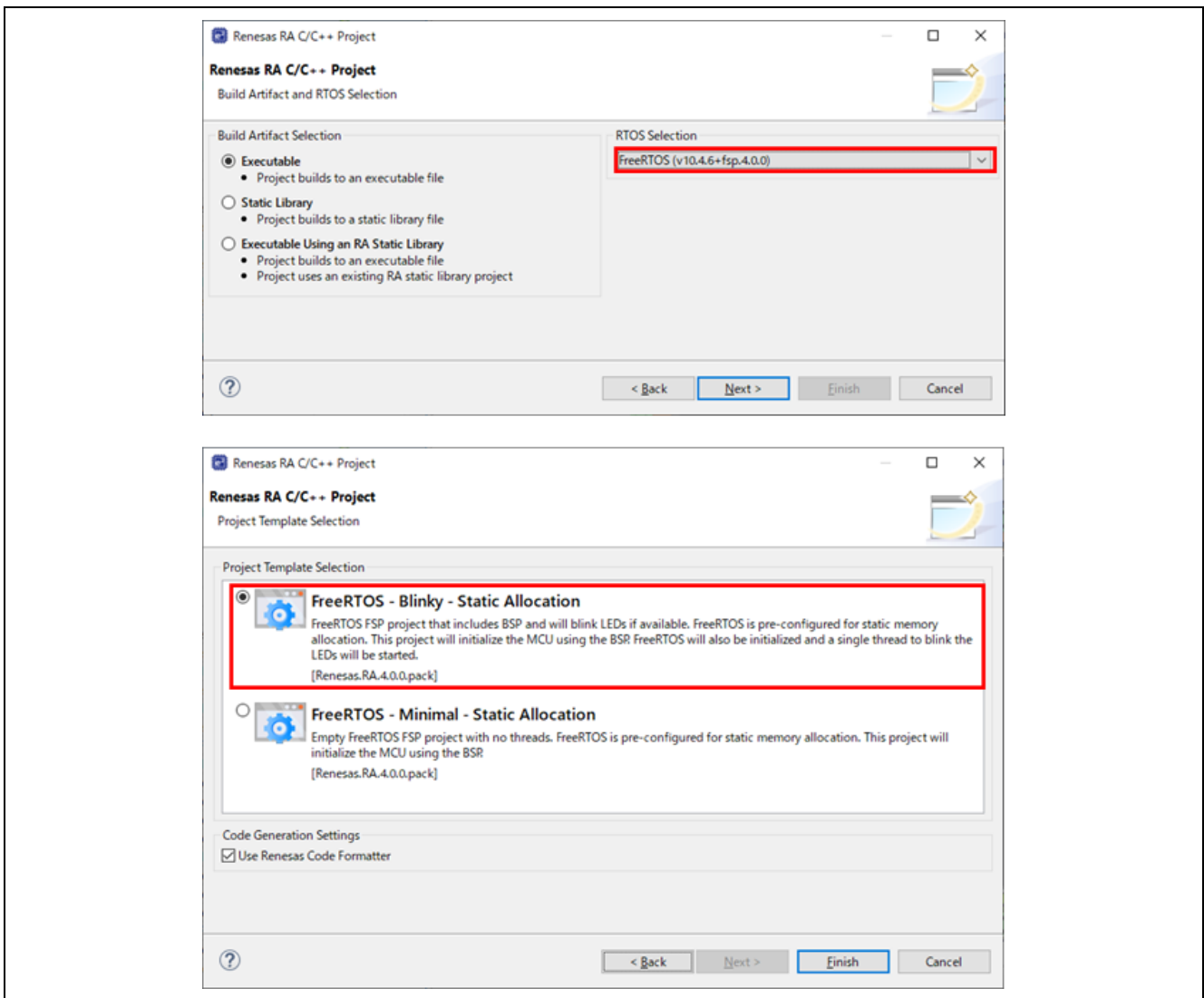

Figure 6-1. Setting up a FreeRTOS Application – Introduction

### 6.2 Creating the Sample Project

To create a sample FreeRTOS project with GPT and semaphore, configure the RA project as follows:

1. Invoke the **New Project** editor and follow the steps in Chapter 3.1 (Generating a New RA Project) to generate a new project. However, in the **Build Artifact and RTOS Selection** dialog, select **FreeRTOS** and in the **Project Template** dialog, select **FreeRTOS – Blinky – Static Allocation**.



**Figure 6-2. Setting up a FreeRTOS Application - Create New Project**

2. Open the **Stacks** page in the **RA Project Configuration**. Refer to section 3.5.5: Stacks Configuration Page.
3. Add the GPT module to the Blinky Thread by selecting **Blinky Thread** in the **Threads** panel and selecting **New Stack** → **Timers** → **Timer, General PWM(r\_gpt)** in the **Stacks** panel.

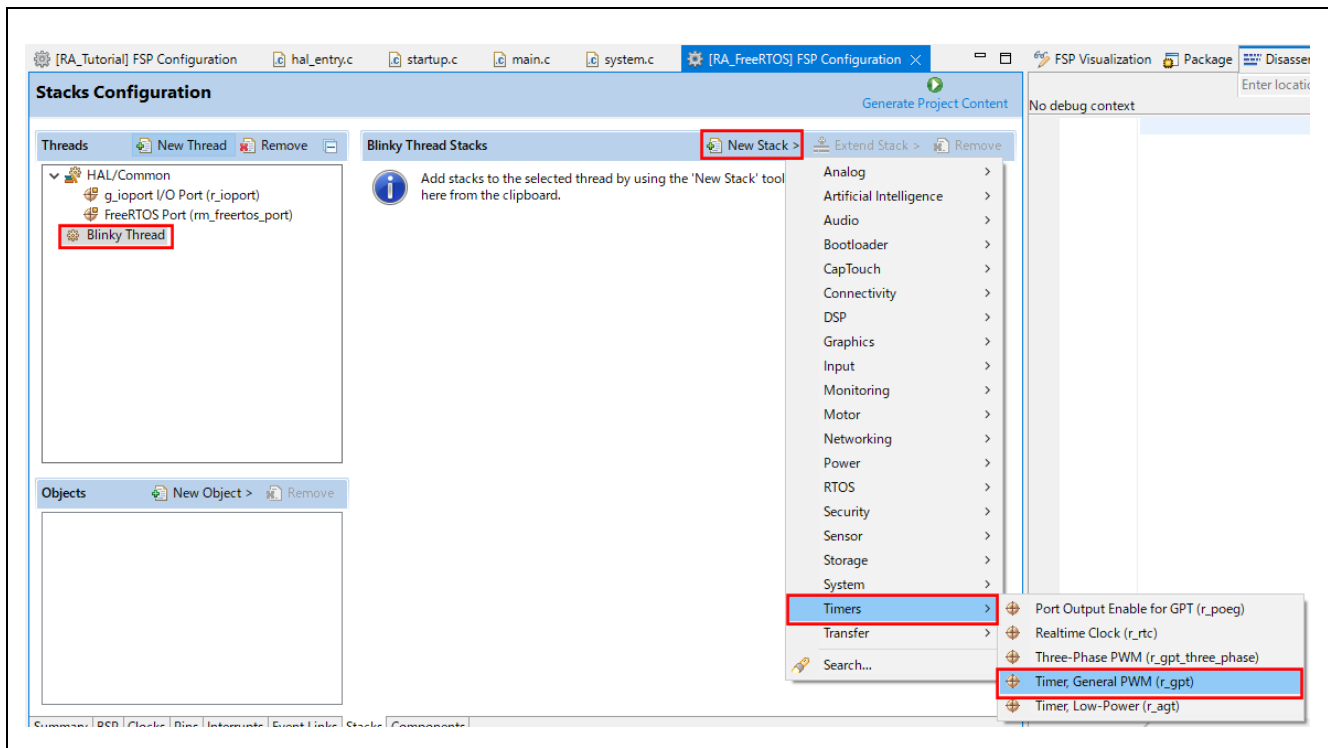

**Figure 6-3. Setting up a FreeRTOS Application – Adding The GPT Module**

4. Configure the GPT module as follows.
  - Name: g\_timer
  - Mode: Periodic
  - Period: 1
  - Period Unit: Seconds
  - Callback: gpt\_callback
  - Overflow/Crest Interrupt priority: Priority 2



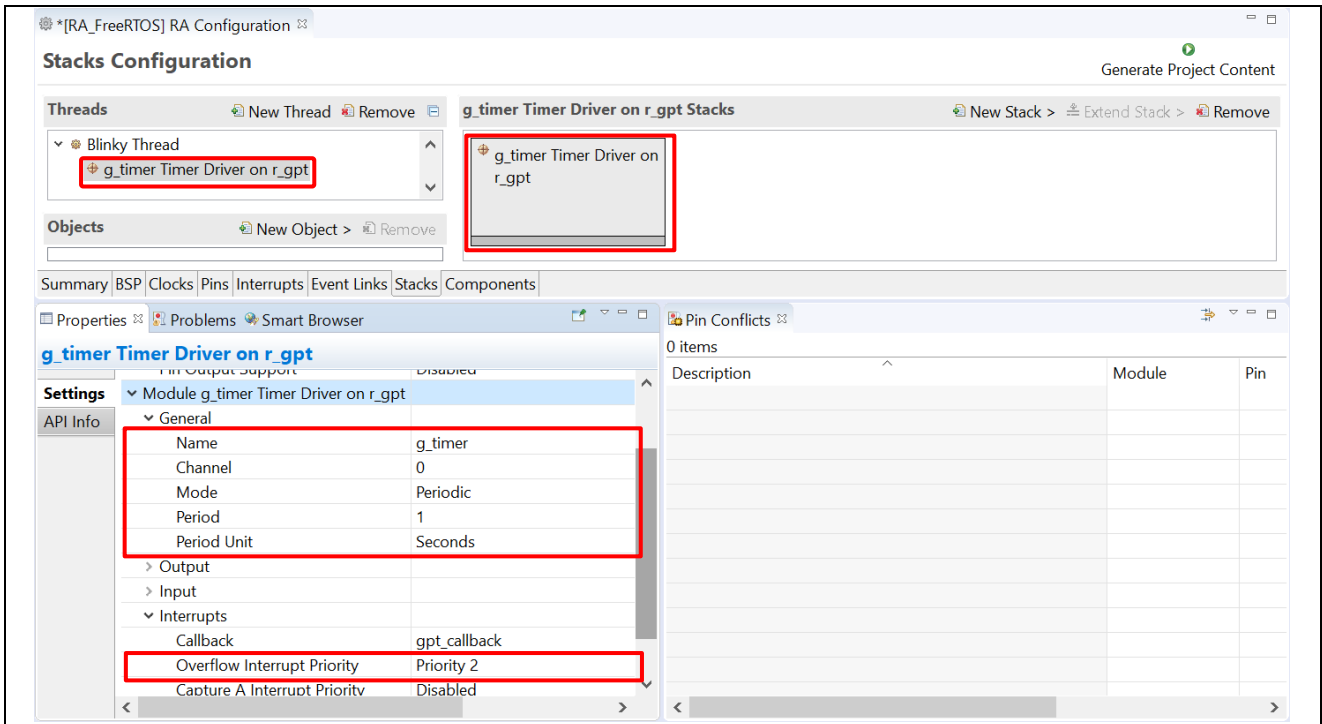

Figure 6-4. Setting up a FreeRTOS Application – GPT Module Configuration

5. Add a semaphore object to the **Blinky Thread** by selecting the **Blinky Thread** in the **Threads** panel and select **New Object** → **Binary Semaphore** in the **Objects** panel.

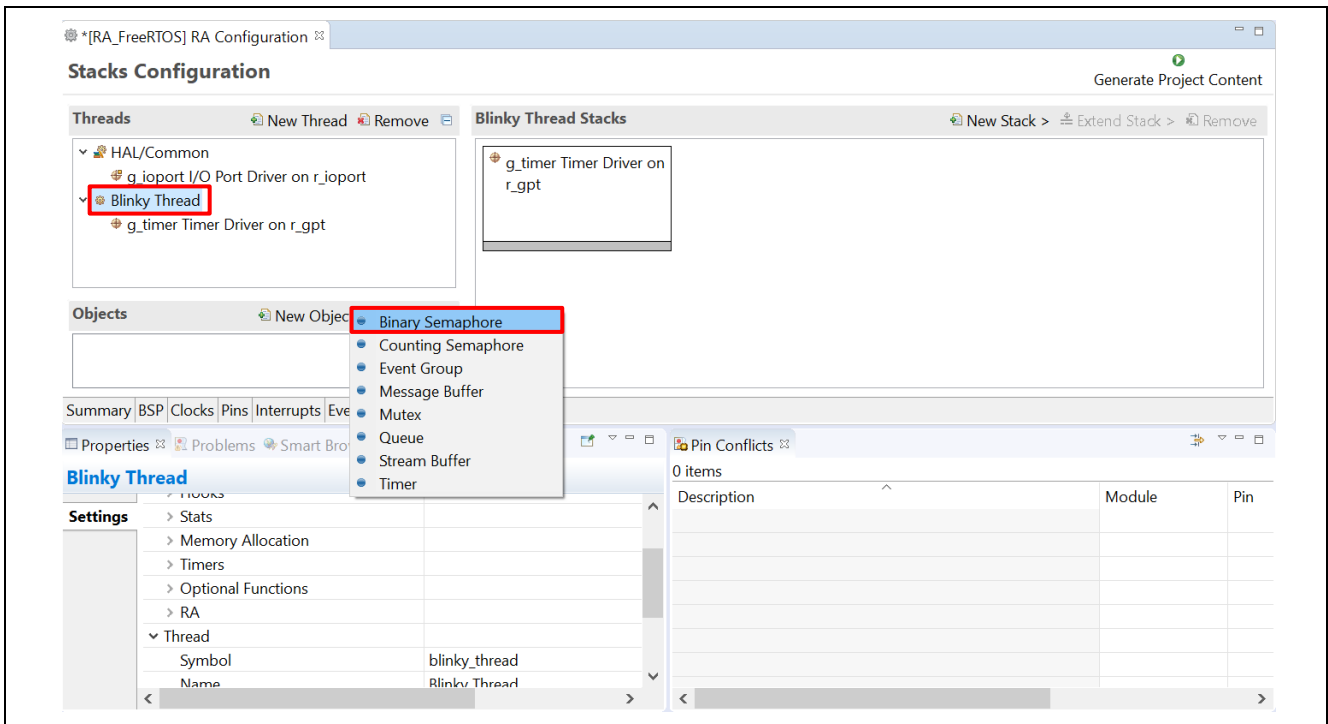
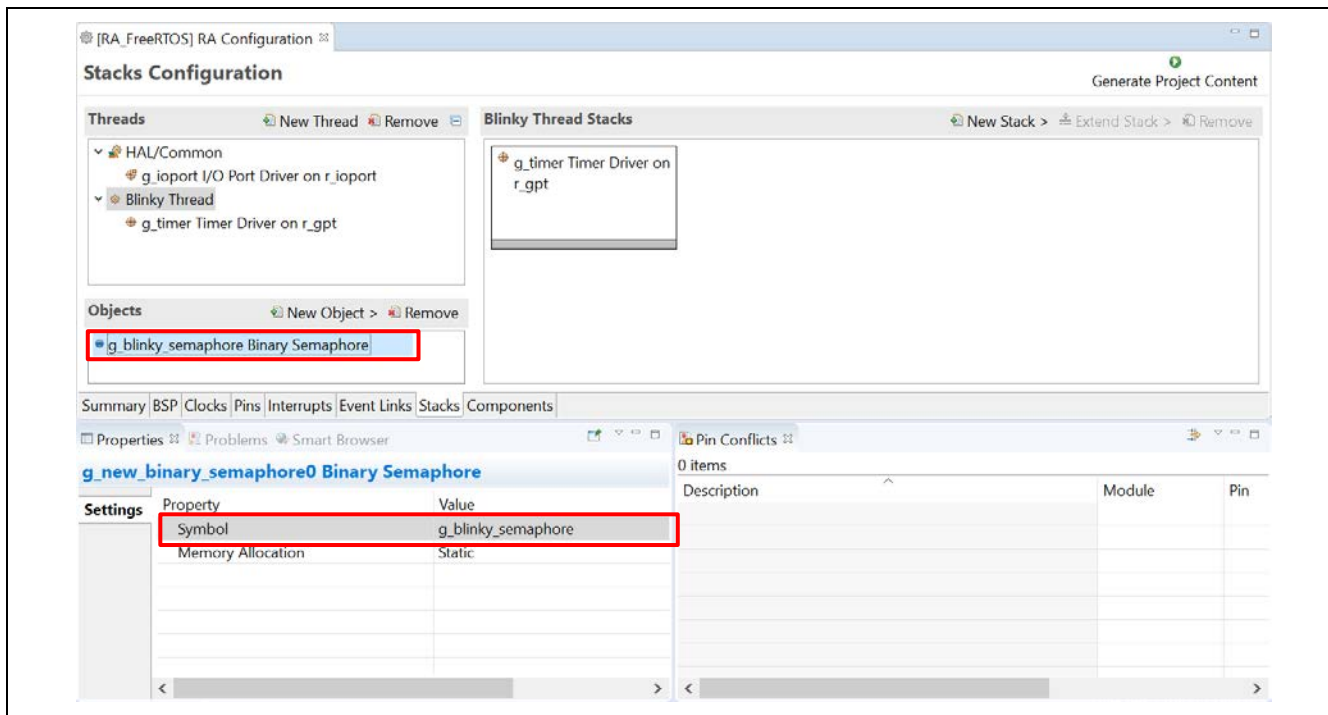
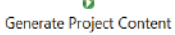

Figure 6-5. Setting up a FreeRTOS Application – Adding a Semaphore Object

6. Configure this newly created semaphore as follows:  
 Name: Blinky Semaphore  
 Symbol: g\_blinky\_semaphore



**Figure 6-6. Setting up a FreeRTOS Application – Semaphore Object Configuration**

7. Press **Ctrl + S** to save the setting and click the **Generate Project Content**  button to generate source code content.
8. Open `src\blinky_thread_entry.c` and implement the following contents:
  - Add source code to initialize the GPT module before the “while(1)” loop in `blinky_thread_entry()`.
 

```
g_timer.p_api->open(g_timer.p_ctrl, g_timer.p_cfg);
g_timer.p_api->start(g_timer.p_ctrl);
```
  - Delete the task delay instruction and add code to wait for the semaphore in `blinky_thread_entry()`.
 

```
xSemaphoreTake(g_blinky_semaphore, portMAX_DELAY);
```
  - Implement the `gpt_callback()` function to signal the semaphore for the Blinky thread.
 

```
void gpt_callback(timer_callback_args_t *p_args) {
    (void)p_args;
    static signed portBASE_TYPE xHigherPriorityTaskWoken;
    xSemaphoreGiveFromISR(g_blinky_semaphore, &xHigherPriorityTaskWoken);
}
```

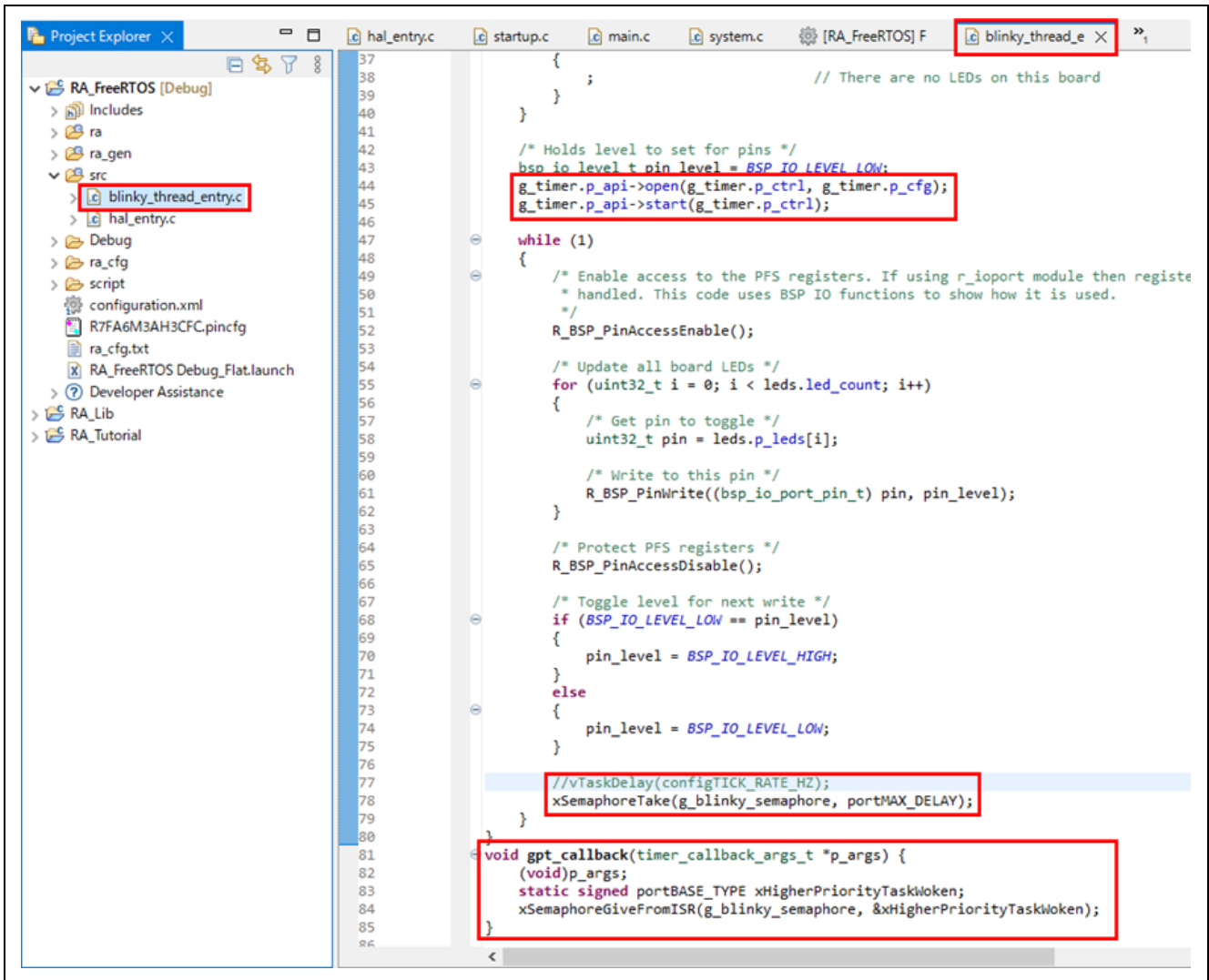

Figure 6-7. Setting up a FreeRTOS Application – Adding User Source Code

- Build and run the project on the EK-RA6M3 board. Confirm that the LEDs are turned ON/OFF every 1 second.

## 7. Setting up an Azure RTOS Application

This example shows how to generate and build an RA project to include Azure RTOS objects and “General Purpose Timer” (GPT) module using the project template **Azure RTOS ThreadX – Blinky**.

### 7.1 General Purpose Timer Example in Azure RTOS

In the **Azure RTOS ThreadX – Blinky** RA project from **Project Template Selection**, LEDs are blinked by putting the task to delay for a while before toggling the LEDs state.

In this example, instead of a delay, the Blinky Thread waits for a semaphore and a timer interrupt (generated by GPT) which puts this semaphore every 1 second so that thread can resume.

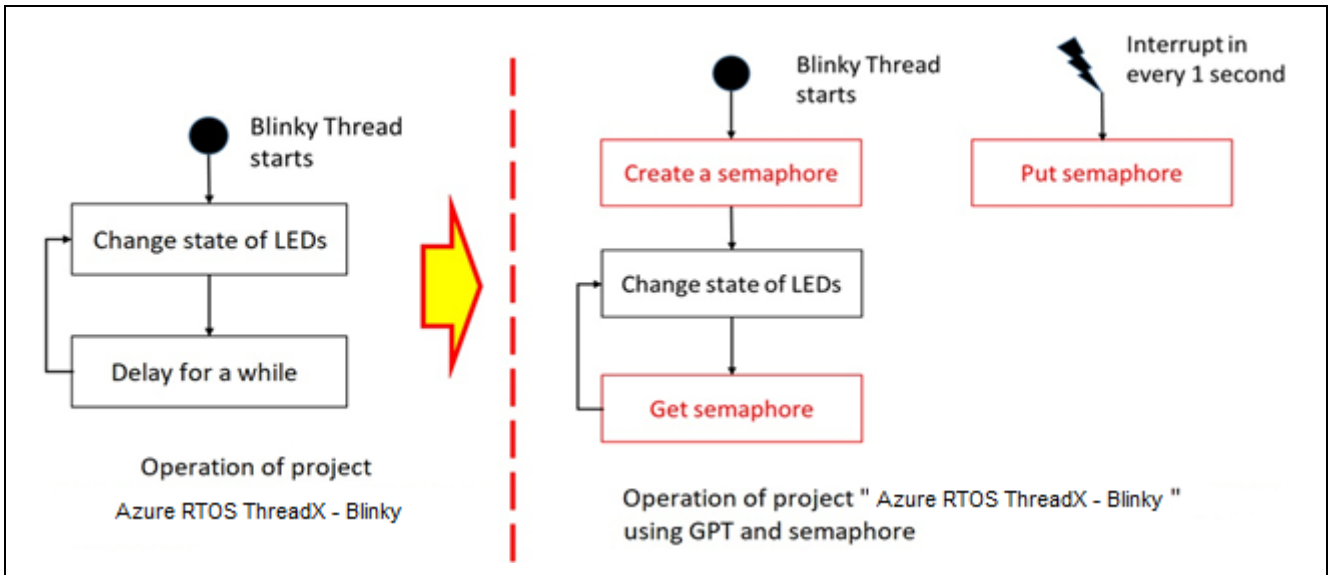
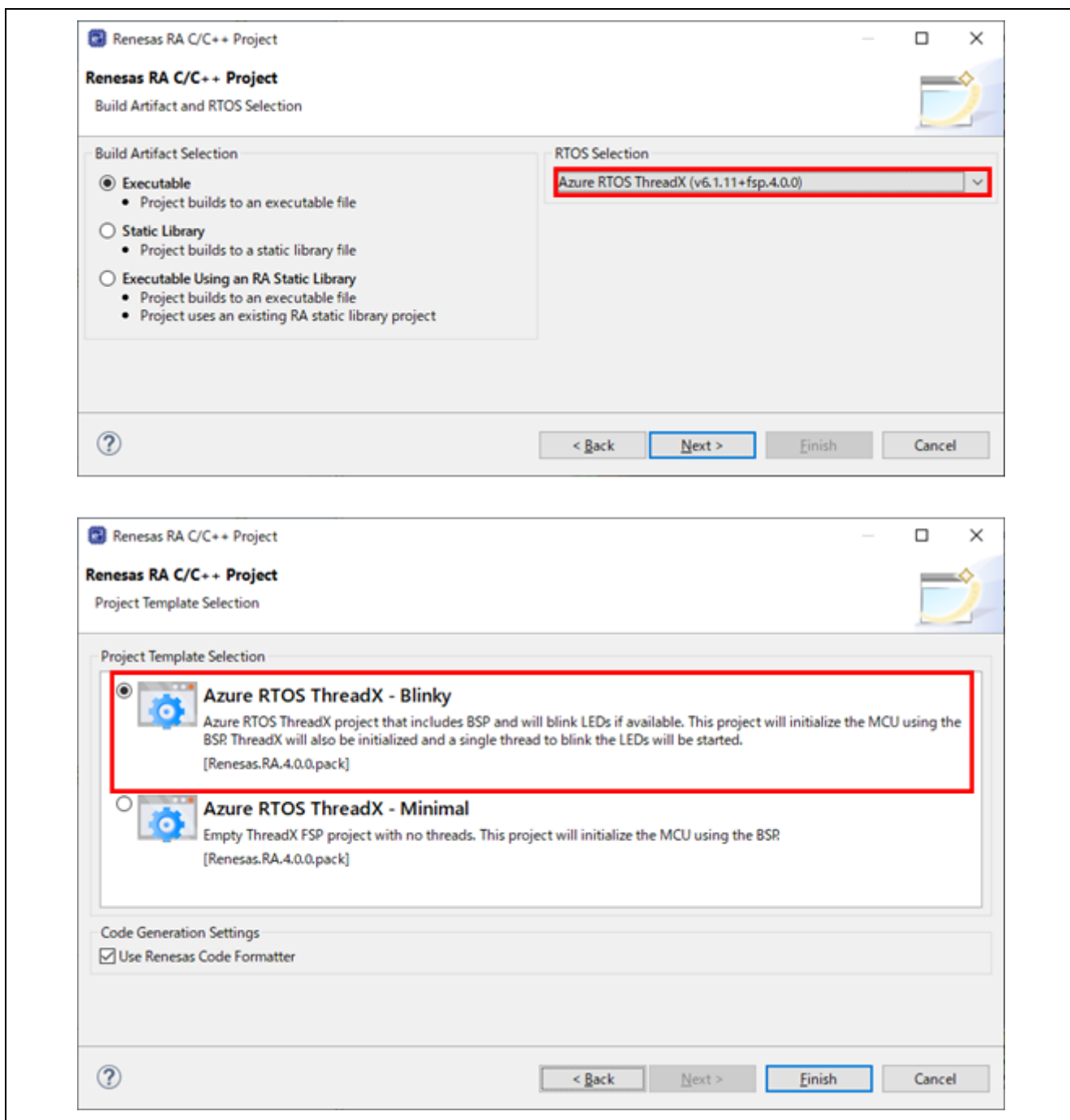

Figure 7-1. Setting up an Azure RTOS Application – Introduction

## 7.2 Creating the Sample Project

To create a sample Azure RTOS project with GPT and semaphore, configure the RA project as follows:

1. Invoke the **New Project** editor and follow the steps in section 3.1 (Generating a New RA Project) to generate a new project. However, in the **Build Artifact and RTOS Selection** dialog, select **Azure RTOS ThreadX** and in the **Project Template** dialog, select **Azure RTOS ThreadX – Blinky**.



**Figure 7-2. Setting up an Azure RTOS Application - Create New Project**

2. Open the **Stacks** page in the **RA Project Configuration**. Refer to chapter 3.5.5: Stacks Configuration Page.
3. Add the GPT module to the Blinky Thread by selecting **Blinky Thread** in the **Threads** panel and selecting **New Stack** → **Timers** → **Timer, General PWM(r\_gpt)** in the **Stacks** panel.

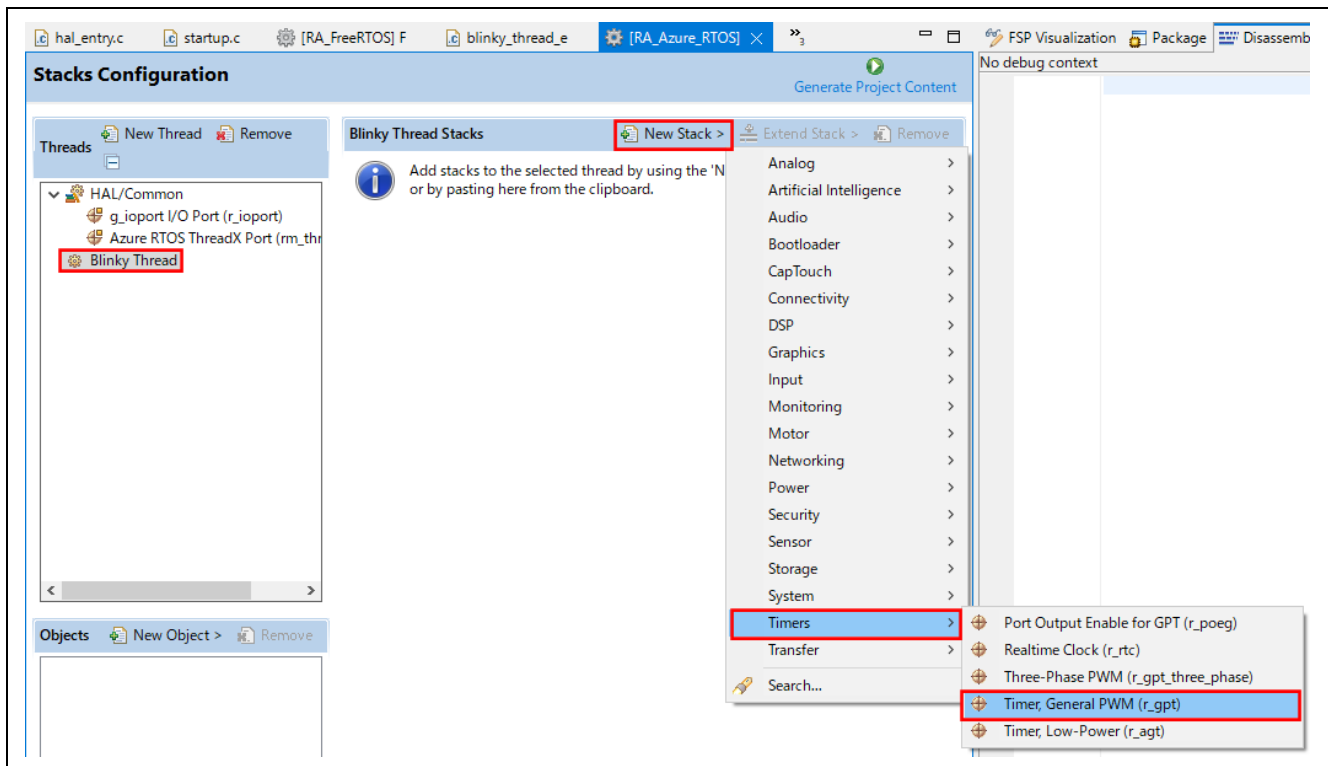

**Figure 7-3. Setting up an Azure RTOS Application – Adding the GPT Module**

4. Configure the GPT module as follows:
  - Name: g\_timer
  - Mode: Periodic
  - Period: 1
  - Period Unit: Seconds
  - Callback: gpt\_callback
  - Overflow/Crest Interrupt priority: Priority 2

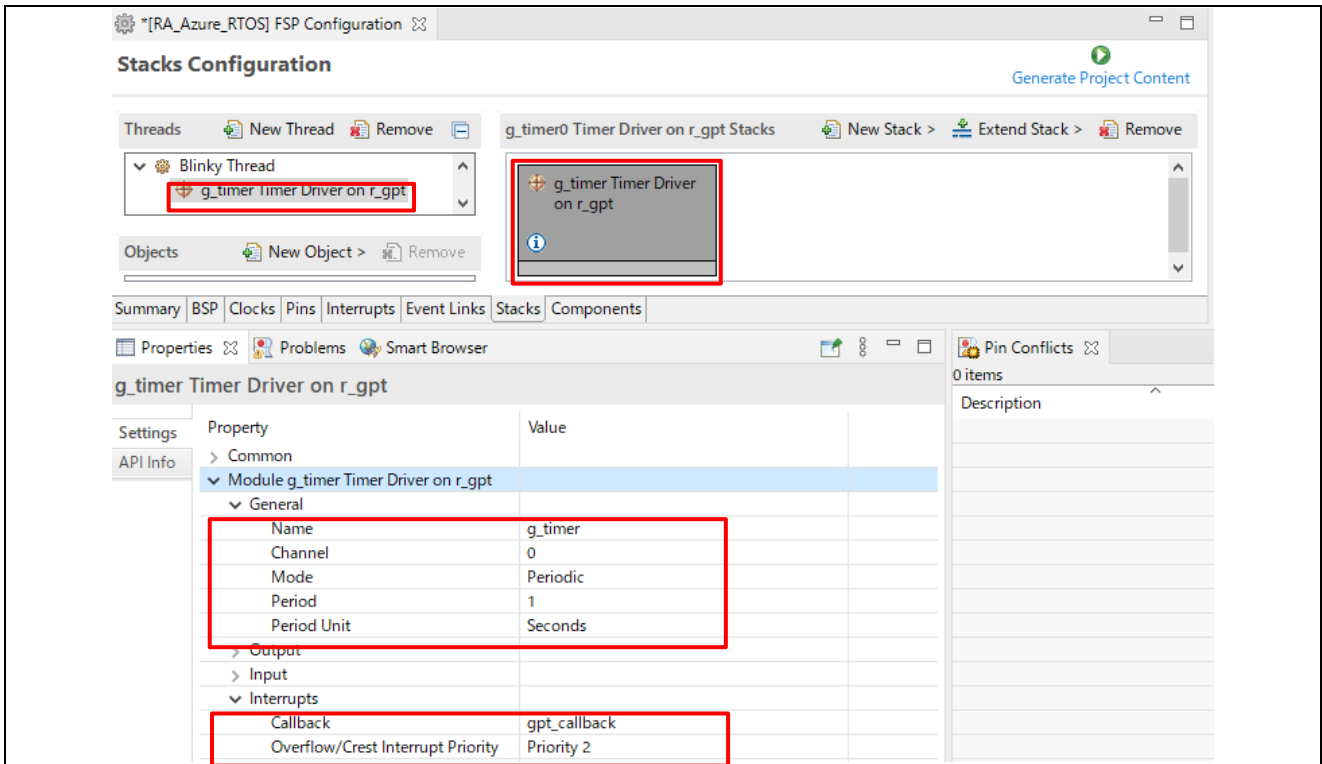

Figure 7-4. Setting up an Azure RTOS Application – GPT Module Configuration

5. Add a semaphore object to the **Blinky Thread** by selecting the **Blinky Thread** in the **Threads** panel and select **New Object** → **Semaphore** in the **Objects** panel.

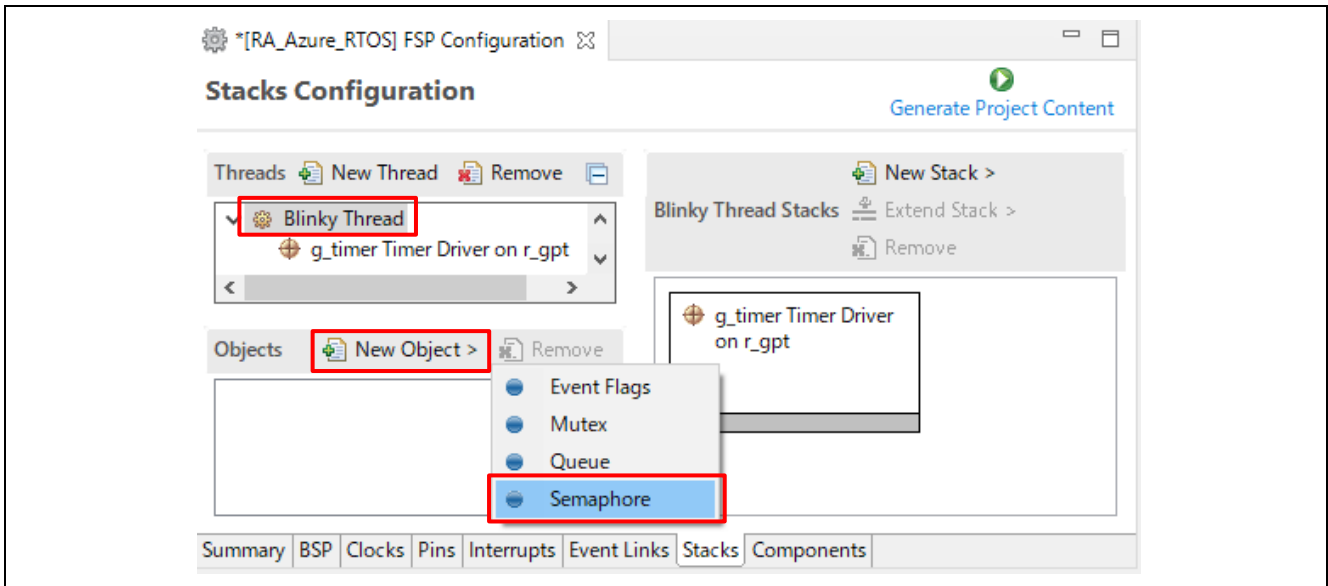
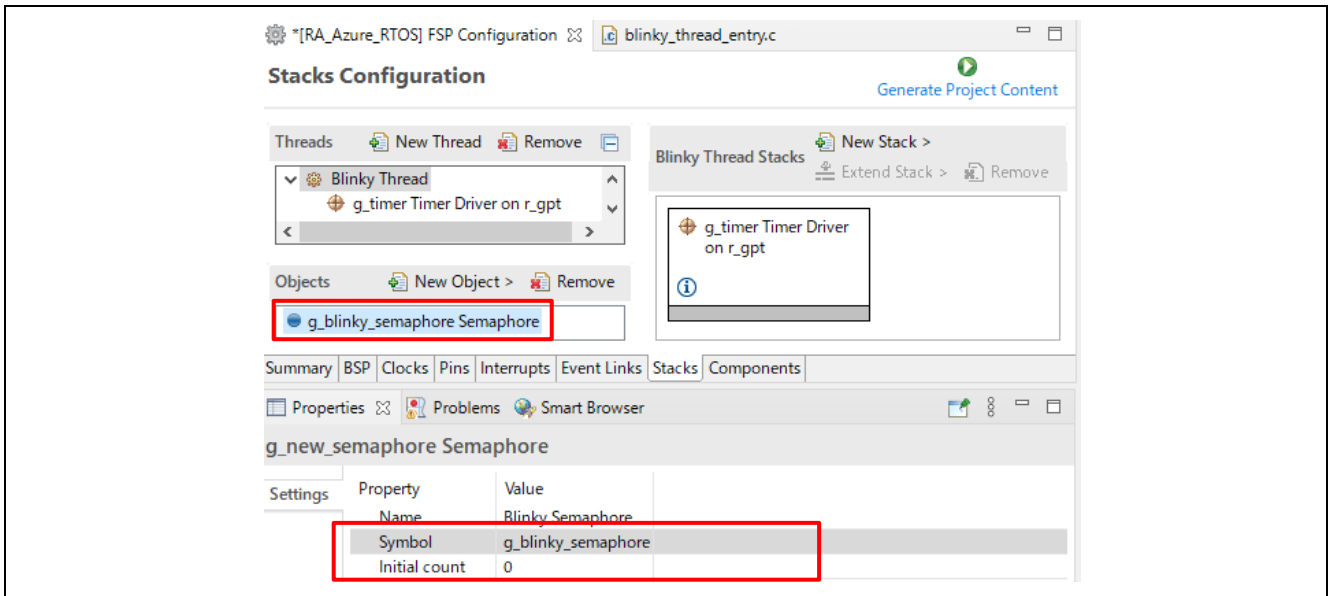

Figure 7-5. Setting up an Azure RTOS Application – Adding A Semaphore Object

6. Configure this newly created semaphore as follows:
  - Name: Blinky Semaphore
  - Symbol: g\_blinky\_semaphore



**Figure 7-6. Setting up an Azure RTOS Application – Semaphore Object Configuration**

7. Press **Ctrl + S** to save the setting and click the **Generate Project Content** Generate Project Content button to generate source code content.
8. Open “src\blinky\_thread\_entry.c” and implement the following contents:
  - Add source code to initialize the GPT module before the “while(1)” loop in blinky\_thread\_entry().
 

```
g_timer.p_api->open(g_timer.p_ctrl, g_timer.p_cfg);
g_timer.p_api->start(g_timer.p_ctrl);
```
  - Delete the task delay instruction and add code to wait for the semaphore in blinky\_thread\_entry().
 

```
tx_semaphore_get(&g_blinky_semaphore, TX_WAIT_FOREVER);
```
  - Implement the gpt\_callback() function to signal the semaphore for the Blinky thread.
 

```
void gpt_callback(timer_callback_args_t *p_args) {
    (void)p_args;
    tx_semaphore_put(&g_blinky_semaphore);
}
```



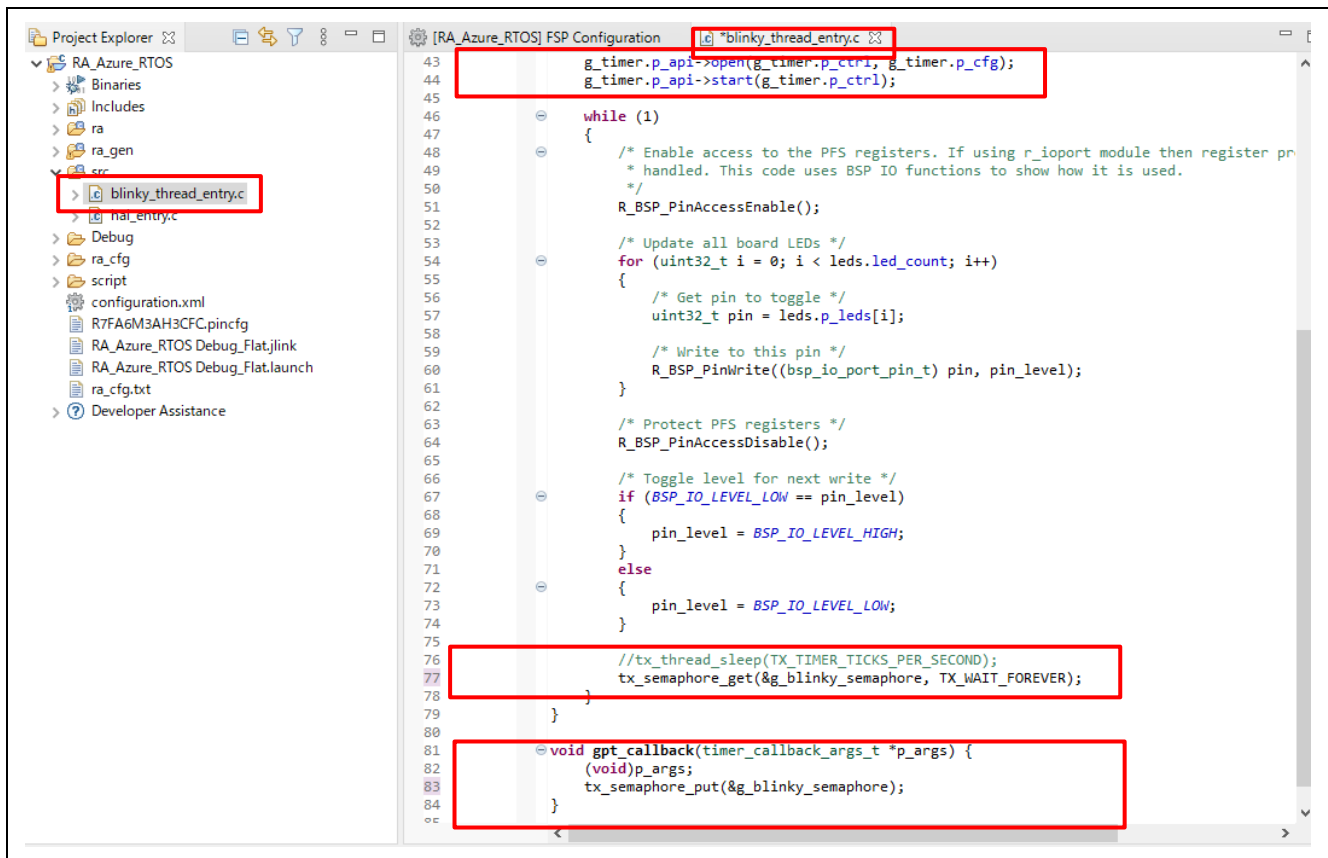

**Figure 7-7. Setting up an Azure RTOS Application – Adding User Source Code**

- Build and run the project on the EK-RA6M3 board. Confirm that the LEDs are turned ON/OFF every 1 second.

## 8. Help

The help system allows users to browse, search, bookmark and print help documentation from a separate **Help** window or **Help** view within the workbench. Users can also access an online forum dedicated to the e<sup>2</sup> studio from here.

Click on **Help** tab to open the **Help** menu.

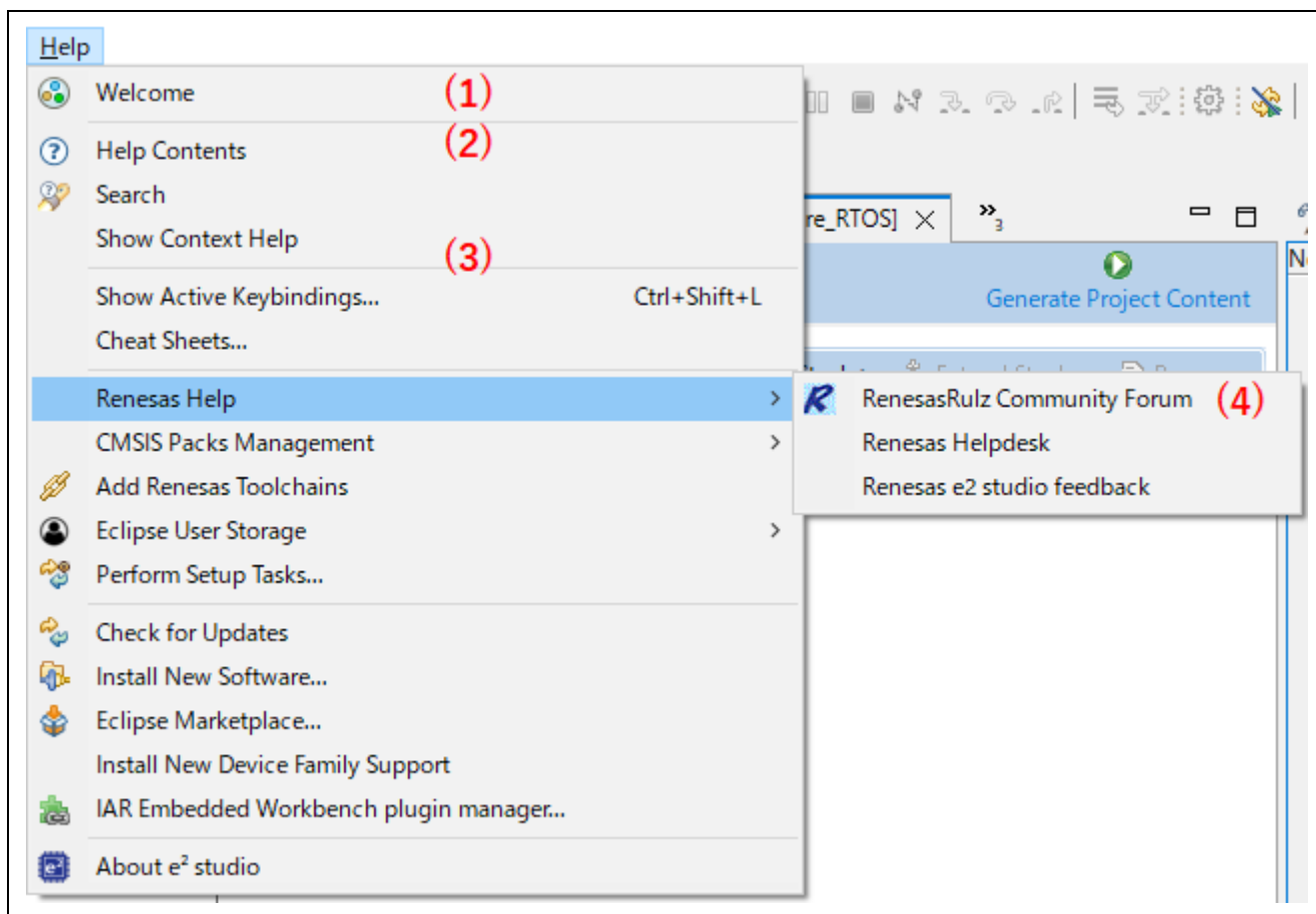

Figure 8-1. Help – Help Menu

#### Quick Help Tips:

1. Click **Welcome** for an overview of the e<sup>2</sup> studio and to view Release Notes.
2. Click **Help Contents** to open a separate Help window with a search function.
3. Click **Show Context Help** to open the Help view within the workbench.
4. Click **RenesasRulz Community Forum** to go an online forum that is dedicated to topics and discussions related to the e<sup>2</sup> studio (Internet connection is required).

Under the Help Contents window, there are many useful topics such as:

The **Debugging Projects** topic which provides useful information such as debug configuration and supported number of breakpoints. It can be launched by clicking on the **Help** menu → **Help Contents** → **e<sup>2</sup> studio User Guide** → **Debugging Projects**.

The **RA Contents** topic which provides information about RA project creation, using the RA Configuration Editor and FAQs. It can be launched by clicking on the **Help** menu → **Help Contents** → **RA Contents**.

## Revision History

Rev.	Date	Description	
		Page	Summary
1.00	Sep.22.2022	—	First release document (Updated from "Renesas e2 studio 2021-04 or higher User's Manual: Quick Start Guide")

---

Renesas e<sup>2</sup> studio 2022-07 or higher  
User's Manual: Quick Start Guide

Publication Date: Sep.22.22

Published by: Renesas Electronics Corporation

---

Renesas e<sup>2</sup> studio 2022-07 or higher  
Quick Start Guide