

General Description

Renesas SLG7NT128V is a low power and small form device. The SoC is housed in a 2mm x 2mm TDFN package which is optimal for using with small devices.

Features

- Low Power Consumption
- 3.3V Supply
- Pb-Free / RoHS Compliant
- Halogen-Free
- TDFN-8 Package

Pin Configuration

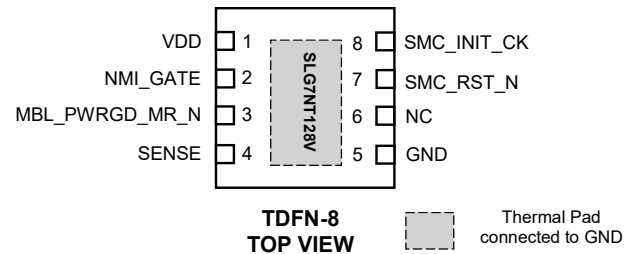

Output Summary

- 2 Outputs – Open Drain

Pin Configuration

Pin #	Pin Name	Type	Pin Description
1	VDD	Power	3.3V Supply Voltage
2	NMI_GATE	Input	Digital Input
3	MBL_PWRGD_MR_N	Input	Digital Input
4	SENSE	Input	Analog input
5	GND	GND	Ground
6	NC	--	Connect to GND or keep floating
7	SMC_RST_N	Output	Open Drain
8	SMC_INIT_CK	Output	Open Drain
Exposed Bottom Pad	GND	GND	Ground

Ordering Options & Configuration

Part Number	Package Type
SLG7NT128V	V = TDFN-8
SLG7NT128VTR	VTR = TDFN-8 – Tape and Reel (3k units)

Absolute Maximum Ratings

Parameter	Min.	Max.	Unit
V _{DD} to GND	-0.3	4.6	V
Voltage at input pins	-0.3	4.6	V
Current at input pin	-1.0	1.0	mA
Storage temperature range	-65	150	°C
Junction temperature	--	150	°C

Electrical Characteristics

Symbol	Parameter	Condition / Note	Min	Typ	Max	Unit
V _{DD}	Supply Voltage		3.0	3.3	3.6	V
I _Q	Quiescent Current	Static Inputs and Outputs	--	30	--	μA
T _A	Operating temperature		-40	25	85	°C
V _{AIR}	Analog Input Voltage Range		0	--	2.2	V
V _{IH}	HIGH-Level Input Voltage	Logic Input	1.8	--	3.3	V
I _{IH}	HIGH-Level Input Leakage Current	Logic Input Pins; VIN=3.3V	-100	--	100	nA
I _{IL}	LOW-Level Input Leakage Current	Logic Input Pins; VIN=0V	-100	--	100	nA
V _{IL}	LOW-Level Input Voltage	Logic Input	-0.3	--	0.8	V
V _{OL}	LOW-Level Output Voltage	Open Drain Logic Level Outputs	0	--	0.4	V
I _{OH}	Low-Level Output Current	Open Drain	--	20	--	mA
V _{REF}	Reference voltage	Analog Comparator 0	--	400	--	mV
V _{HYST}	Analog Comparator hysteresis	Analog Comparator 0	--	50	--	mV
R _{PULL_UP}	Internal Pull Up Resistance	Pull up on PIN7 and PIN8	80	100	120	kΩ
T _{StUp}	Start Up Time		--	7	--	ms

Description

This is a special oscillator with supervisor system. Three inputs are used to control the oscillator. PIN4 controls the voltage supply of the chip. If supply voltage decreases to 2.8V, the chip disables the oscillator and sets SMC_INICK to LOW. When voltage > 2.8V is detected on the SENSE pin, SMC_RST_N is set to HIGH with 20 ms delay and enables the oscillator. MBL_PWRGD_MR_N is used for manual reset of SMC_RST_N. Use NMI_GATE to disable the oscillator.

Typical Application Circuit

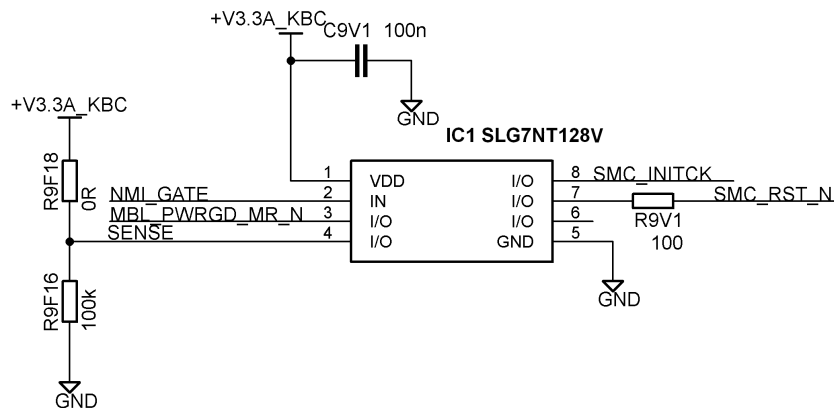

Timing Diagrams

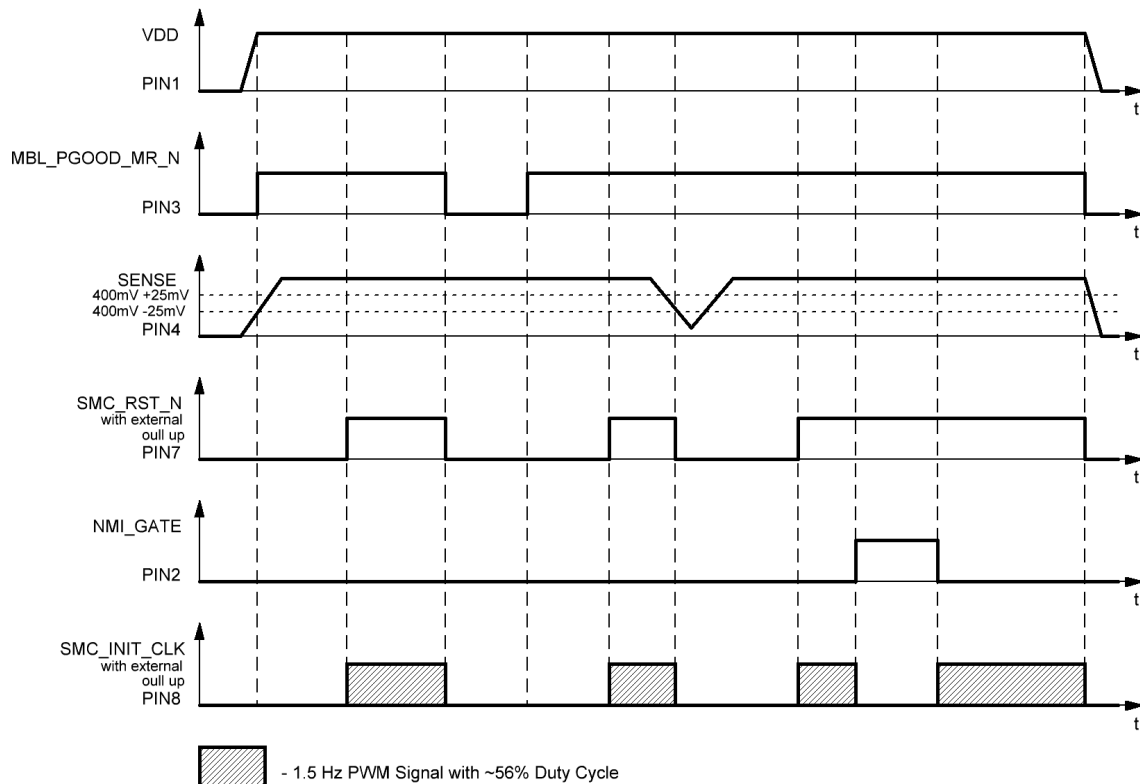

SLG7NT128V Functionality Waveforms

Channel 1 (yellow/top line) – Pin# 8 (SMC_INIT_CLK)

Channel 2 (light blue/2nd line) – Pin# 7 (SMC_RST_N)

Channel 3 (magenta /3rd line) – Pin# 3 (MBL_PGOOD_MR)

Channel 4 (green /bottom line) – Pin# 2 (NMI_GATE)

1. OSC enable

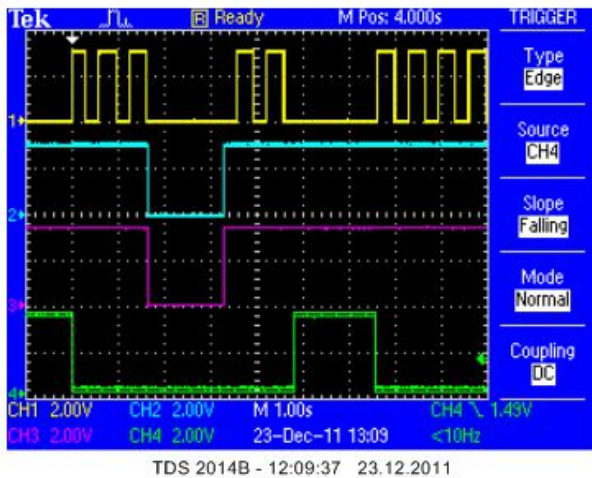

2. 20ms delay supervisor

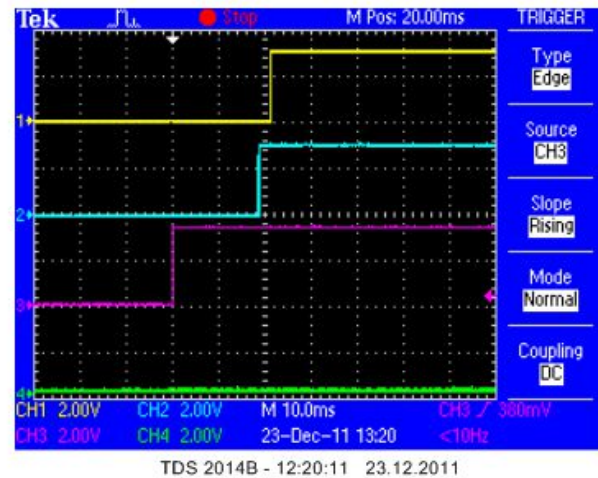

Channel 1 (yellow/top line) – pin# 8 (SMC_INIT_CLK)

Channel 2 (light blue/2nd line) – pin# 7 (SMC_RST_N)

Channel 3 (magenta /3rd line) – pin# 4 (SENSE)

Channel 4 (green /bottom line) – pin# 2 (NMI_GATE)

3. Power voltage detect

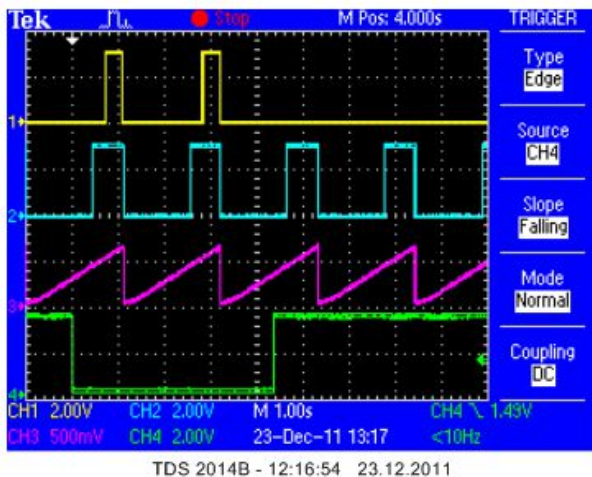

Package Top Marking

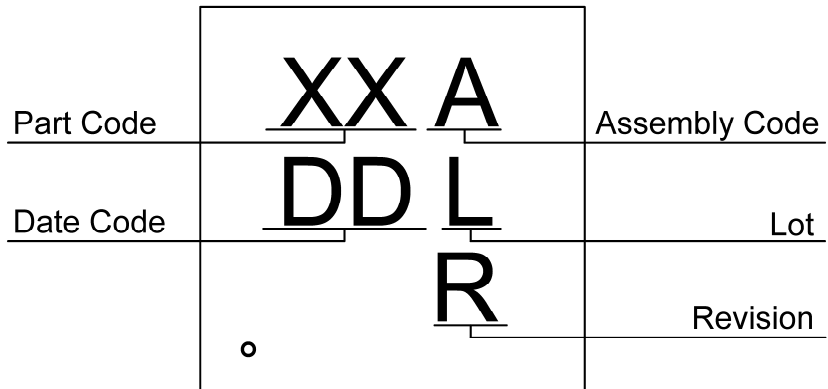

- XX – Part Code Field: identifies the specific device configuration
- A – Assembly Code Field: Assembly Location of the device.
- DD – Date Code Field: Coded date of manufacture
- L – Lot Code: Designates Lot #
- R – Revision Code: Device Revision

Datasheet Revision	Programming Code Number	Part Code	Revision	Date
1.01	01	KN	A	02/25/2022

Package Drawing and Dimensions

TDFN-8 Package

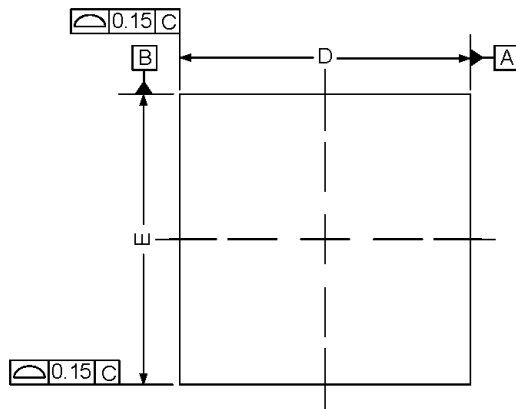

Symbol	Min (mm)	NOM (mm)	Max (mm)
A	0.70	0.75	0.80
A1	0.00	--	0.05
A2	--	0.55	--
A3	--	0.20	--
b	0.20	0.25	0.30
D	1.90	2.00	2.10
D2	1.50	1.60	1.70
E	1.90	2.00	2.10
E2	0.80	0.90	1.00
e	0.50 BSC		
L	0.20	0.30	0.40

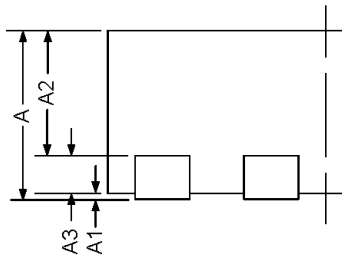
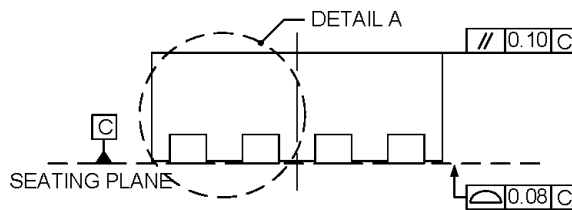

DETAIL A

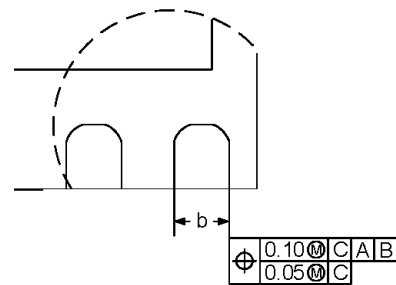
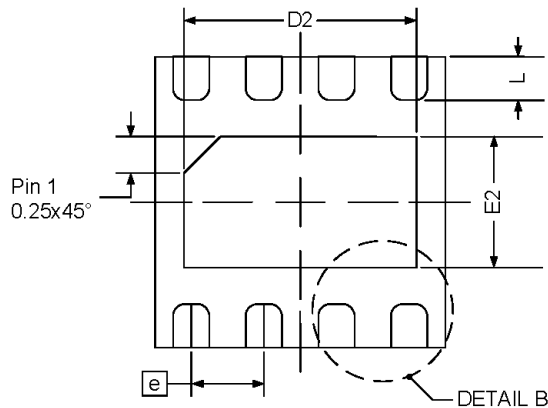

DETAIL B

Tape and Reel Specification

Package Type	# of Pins	Nominal Package Size (mm)	Max Units		Reel & Hub Size (mm)	Trailer A		Leader B		Pocket (mm)	
			per reel	per box		Pockets	Length (mm)	Pockets	Length (mm)	Width	Pitch
TDFN 8L 2x2mm Green	8	2x2x0.75	3000	3000	178/60	42	168	42	168	8	4

Carrier Tape Drawing and Dimensions

Package Type	Pocket BTM Length (mm)	Pocket BTM Width (mm)	Pocket Depth (mm)	Index Hole Pitch (mm)	Pocket Pitch (mm)	Index Hole Diameter (mm)	Index Hole to Tape Edge (mm)	Index Hole to Pocket Center (mm)	Tape Width (mm)
	A0	B0	K0	P0	P1	D0	E	F	W
TDFN 8L 2x2mm Green	2.3	2.3	1.05	4	4	1.55	1.75	3.5	8

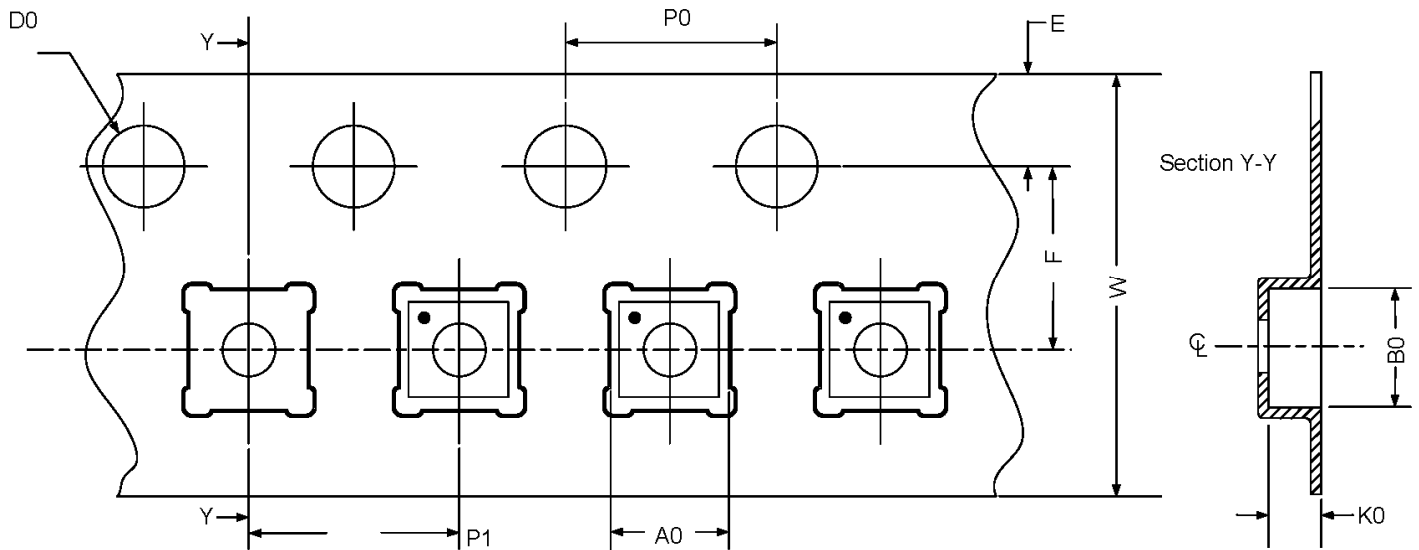

Recommended Reflow Soldering Profile

Please see IPC/JEDEC J-STD-020: latest revision for reflow profile based on package volume of 4.6875 mm³ (nominal). More information can be found at www.jedec.org.

Datasheet Revision History

Date	Version	Change
02/08/2012	0.1	New Design
06/05/2012	0.11	Changed name of design to "1Hz Interrupt Generator"
03/08/2013	0.12	Updated Device Revision Table
03/18/2013	0.13	Corrected Timing Diagrams
03/25/2013	0.14	Updated Device Revision Table
03/29/2013	1.0	Production Release
02/25/2022	1.01	Updated Company name and logo

IMPORTANT NOTICE AND DISCLAIMER

RENESAS ELECTRONICS CORPORATION AND ITS SUBSIDIARIES (“RENESAS”) PROVIDES TECHNICAL SPECIFICATIONS AND RELIABILITY DATA (INCLUDING DATASHEETS), DESIGN RESOURCES (INCLUDING REFERENCE DESIGNS), APPLICATION OR OTHER DESIGN ADVICE, WEB TOOLS, SAFETY INFORMATION, AND OTHER RESOURCES “AS IS” AND WITH ALL FAULTS, AND DISCLAIMS ALL WARRANTIES, EXPRESS OR IMPLIED, INCLUDING, WITHOUT LIMITATION, ANY IMPLIED WARRANTIES OF MERCHANTABILITY, FITNESS FOR A PARTICULAR PURPOSE, OR NON-INFRINGEMENT OF THIRD-PARTY INTELLECTUAL PROPERTY RIGHTS.

These resources are intended for developers who are designing with Renesas products. You are solely responsible for (1) selecting the appropriate products for your application, (2) designing, validating, and testing your application, and (3) ensuring your application meets applicable standards, and any other safety, security, or other requirements. These resources are subject to change without notice. Renesas grants you permission to use these resources only to develop an application that uses Renesas products. Other reproduction or use of these resources is strictly prohibited. No license is granted to any other Renesas intellectual property or to any third-party intellectual property. Renesas disclaims responsibility for, and you will fully indemnify Renesas and its representatives against, any claims, damages, costs, losses, or liabilities arising from your use of these resources. Renesas' products are provided only subject to Renesas' Terms and Conditions of Sale or other applicable terms agreed to in writing. No use of any Renesas resources expands or otherwise alters any applicable warranties or warranty disclaimers for these products.

(Disclaimer Rev.1.01 Jan 2024)

Corporate Headquarters

TOYOSU FORESIA, 3-2-24 Toyosu,
Koto-ku, Tokyo 135-0061, Japan
www.renesas.com

Trademarks

Renesas and the Renesas logo are trademarks of Renesas Electronics Corporation. All trademarks and registered trademarks are the property of their respective owners.

Contact Information

For further information on a product, technology, the most up-to-date version of a document, or your nearest sales office, please visit www.renesas.com/contact-us/.