

# RAA214220

150mA 20V Wide Input Voltage Range LDO Linear Regulator

The RAA214220 is a low-dropout linear voltage regulator that operates with a wide input voltage range from 2.5V to 20V, and the device provides up to 150mA of output current.

Featuring a wide input voltage range with excellent line and load regulation, the device also has an integrated fault protection including over-temperature shutdown (OTSD) and short-circuit current limit. As well, the RAA214220 is suited for battery powered and USB devices.

The output voltage of the device is adjustable with an external resistor network between the output pin and ground, and the device does well with regulating both the over-temperature and the operating range of the input voltage and load. It is also stable with an MLCC output capacitor as low as 1µF.

The RAA214220 is available in the 5-pin TSOT23 package.

## Features

- Wide input voltage range 2.5V to 20V
- Output current up to 150mA
- Low ground current
- Adjustable and accurate output voltage from 1.2266V to 18V
- Low dropout voltage: 225mV typical at 150mA load
- Excellent line and load regulation
- Stable with 1µF - 200µF MLCC output capacitor
- Integrated fault protections including thermal shutdown and current limit
- Available in the compact and cost effective TSOT23 package

## Applications

- Battery-powered equipment
- MCU power supply
- Electric meters
- USB devices
- Laptop computers and tablets
- Portable modules and appliances

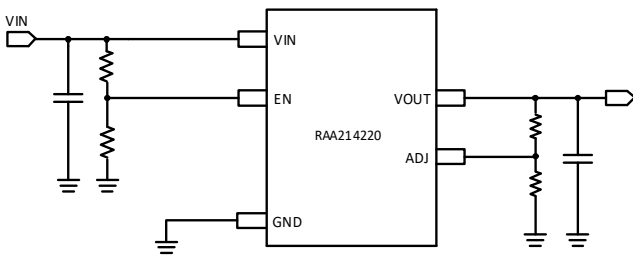

Figure 1. RAA214220 Typical Application (1)

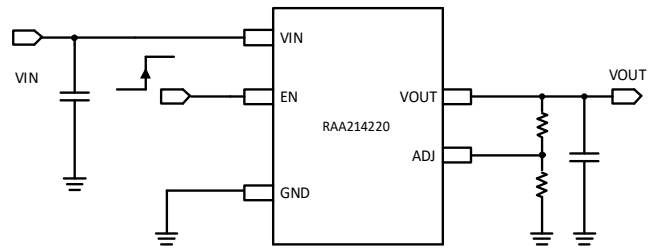

Figure 2. RAA214220 Typical Application (2)

## Contents

<b>1. Overview</b>	<b>3</b>
1.1 Block Diagram	3
<b>2. Pin Information</b>	<b>3</b>
2.1 Pin Assignments	3
2.2 Pin Descriptions	3
<b>3. Specifications</b>	<b>4</b>
3.1 Absolute Maximum Ratings	4
3.2 Thermal Information	4
3.3 Recommended Operation Conditions	5
3.4 Electrical Specifications	5
<b>4. Typical Performance Curves</b>	<b>6</b>
<b>5. Function Description</b>	<b>9</b>
5.1 Function Overview	9
5.2 Enable Control	9
5.3 Current Limit Protection	9
5.4 Over-Temperature Shutdown (OTSD)	9
<b>6. Application Information</b>	<b>9</b>
6.1 Setting the Output Voltage	9
6.2 Input and Output Capacitors	10
6.3 Power Dissipation	10
6.4 PCB Layout Recommendations	11
<b>7. Package Outline Drawing</b>	<b>12</b>
<b>8. Ordering Information</b>	<b>13</b>
<b>9. Revision History</b>	<b>13</b>

# 1. Overview

## 1.1 Block Diagram

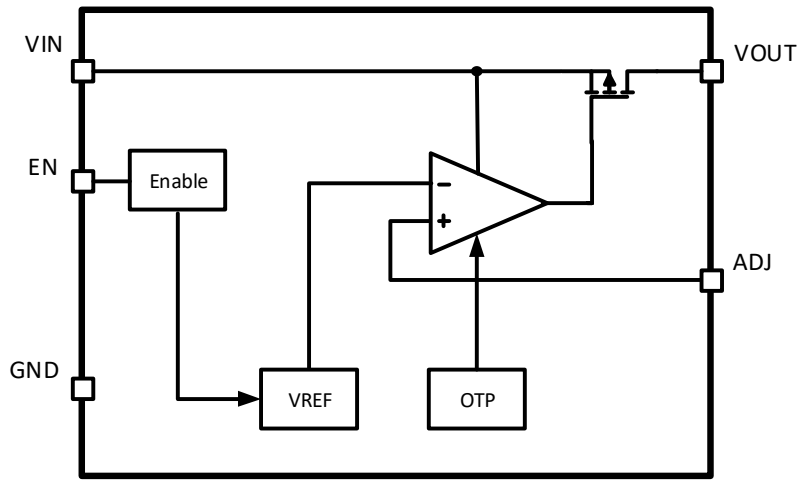
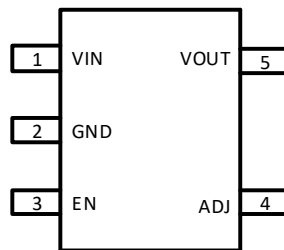

Figure 3. Block Diagram

# 2. Pin Information

## 2.1 Pin Assignments



Top View

## 2.2 Pin Descriptions

Pin Number	Pin Name	Description
VIN	1	Analog input supply voltage and positive supply for the linear regulator. Decouple this pin to ground with 0.1μF or larger high frequency ceramic capacitor to GND.
GND	2	Ground reference
EN	3	Enable input. Drive EN high to turn on the linear regulator, low to turn it off. This pin can be connected to VIN for automatic turn on.
ADJ	4	Adjustable pin regulated at 1.2266V (internal band gap voltage). Connect it to an external resistor divider between VOUT and GND to set the output voltage. When the pin is shorted to VOUT, the output voltage is set to the minimum 1.2266V.
VOUT	5	Regulated output voltage pin. An minimum 1μF X5R/X7R output capacitor is required between this pin and GND. Place the capacitor as close to the output of the regulator as possible.

### 3. Specifications

#### 3.1 Absolute Maximum Ratings

**CAUTION:** Do not operate at or near the maximum ratings listed for extended periods of time. Exposure to such conditions can adversely impact product reliability and result in failures not covered by warranty.

Parameter <sup>[1]</sup>	Minimum	Maximum	Unit
Supply Voltage, VIN	-0.3	+22	V
Enable Input Voltage, EN	-0.3	+22	V
Output Voltage, VOUT	-0.3	+22	V
Adjustable Pin Voltage, ADJ	-0.3	+5.5	V
Output Current, IOUT		150	mA
ESD Rating	Value		Unit
Human Body Model (Tested per JS-001-2017)	2		kV
Charged Device Model (Tested per JS-002-2014)	750		V
Latch-Up (Tested per JESD78E; Class 2, Level A)	100		mA

1. All voltages referenced to VSS unless otherwise specified.

#### 3.2 Thermal Information

Thermal Resistance (Typical)	$\theta_{JA}$ (°C/W) <sup>[1]</sup>	$\theta_{JC}$ (°C/W) <sup>[2]</sup>	$\Psi_{JT}$ (°C/W)
TSOT23	215	140	12

- $\theta_{JA}$  is measured in free air with the component mounted on a high-effective thermal conductivity test board with direct attach features. See [TB379](#).
- For  $\theta_{JC}$ , the case temperature location is on the top side of the package.

Parameter	Minimum	Maximum	Unit
Maximum Junction Temperature	-40	+150	°C
Maximum Storage Temperature Range	-65	+150	°C
Pb-Free Reflow Profile	see <a href="#">TB493</a>		

### 3.3 Recommended Operation Conditions

Parameter	Minimum	Maximum	Unit
Supply Voltage, $V_{IN}$	+2.5	+20	V
Enable Input Voltage, EN	0	+20	V
Output Voltage, $V_{OUT}$	0	+18	V
Adjustable Pin Voltage, ADJ	0	+5	V
Output Current, $I_{OUT}$	0	150	mA
Output Capacitor, $C_{OUT}$	1	200	$\mu$ F
Junction Temperature	-40	+125	$^{\circ}$ C

### 3.4 Electrical Specifications

At ambient temperature  $-40^{\circ}$ C to  $+125^{\circ}$ C,  $I_{OUT} = 1$ mA,  $C_{IN} = 1\mu$ F,  $C_{OUT} = 2.2\mu$ F,  $V_{IN} = 2.5$ V,  $V_{OUT} = V_{ADJ}$ , EN = 5V, unless otherwise specified. Typical values are at  $T_A = 25^{\circ}$ C.

Parameters	Symbol	Test Conditions	Min <sup>[1]</sup>	Typ	Max <sup>[1]</sup>	Unit
Output Voltage	$V_{OUT}$		1.2		18	V
Input Voltage	$V_{IN}$		2.5		20	V
Reference Voltage Accuracy	$V_{REF}$	$V_{IN} = 2.5$ V to 20V, $25^{\circ}$ C	-1.5		+1.5	%
		$-40^{\circ}$ C to $125^{\circ}$ C	-2		+2	%
Reference Voltage	$V_{REF}$			1.2266		V
Line Regulation	$\Delta V_{OUT}\% / \Delta V_{IN}$	$V_{IN} = V_{OUT} + 1$ V to 20V		0.02	0.05	%/V
Load Regulation	$\Delta V_{OUT}\% / \Delta I_{OUT}$	$I_{OUT} = 100\mu$ A to 150mA $V_{IN} = 5$ V		0.0033		%/mA
Dropout Voltage <sup>[2]</sup>	$V_{DO}$	$I_{OUT} = 10$ mA, $V_{OUT} = 3.3$ V		15		mV
		$I_{OUT} = 100$ mA, $V_{OUT} = 3.3$ V		145		
		$I_{OUT} = 150$ mA, $V_{OUT} = 3.3$ V		225	450	
Shutdown Current	$I_{SHDN}$	EN = 0, $V_{IN} = 2.5$ V		2		$\mu$ A
		EN = 0, $V_{IN} = 20$ V		6	10	
Ground Current	$I_{GND}$	$I_{OUT} = 0$		38		$\mu$ A
		$I_{OUT} = 10$ mA		80		
		$I_{OUT} = 150$ mA		120	180	
Power Supply Ripple Rejection	PSRR	$f = 100$ Hz, $I_{OUT} = 10$ mA, $V_{IN} = 6$ V, $V_{OUT} = 5$ V		92		dB
		$f = 10$ kHz, $I_{OUT} = 10$ mA, $V_{IN} = 6$ V, $V_{OUT} = 5$ V		63		dB
		$f = 100$ kHz, $I_{OUT} = 10$ mA, $V_{IN} = 6$ V, $V_{OUT} = 5$ V		37		dB
Output Voltage Noise		BW = 10Hz to 100kHz $I_{OUT} = 10$ mA, $V_{ADJ} = V_{OUT}$ , $C_{OUT} = 10\mu$ F	-	150	-	$\mu$ V <sub>RMS</sub>

At ambient temperature -40°C to +125°C,  $I_{OUT} = 1\text{mA}$ ,  $C_{IN} = 1\mu\text{F}$ ,  $C_{OUT} = 2.2\mu\text{F}$ ,  $V_{IN} = 2.5\text{V}$ ,  $V_{OUT} = V_{ADJ}$ ,  $EN = 5\text{V}$ , unless otherwise specified. Typical values are at  $T_A = 25^\circ\text{C}$ .

Parameters	Symbol	Test Conditions	Min <sup>[1]</sup>	Typ	Max <sup>[1]</sup>	Unit
EN Rising Threshold			1.35	1.5	1.65	V
EN Falling Threshold				1.3		V
EN Leakage Current		$EN = 20\text{V}$		2		$\mu\text{A}$
Short-Circuit Current Limit		$V_{IN} = 5\text{V}$	180	220	275	mA
Thermal Shutdown				159		$^\circ\text{C}$
Hysteresis				23		$^\circ\text{C}$

- Parameters with MIN and/or MAX limits are 100% tested at +25°C, unless otherwise specified. Temperature limits established by characterization and are not production tested.
- Dropout voltage is the input-to-output voltage difference at which the output voltage is 100mV below its normal value.

### 4. Typical Performance Curves

$C_{IN} = 1\mu\text{F}$ ,  $C_{OUT} = 2.2\mu\text{F}$ ,  $V_{IN} = 2.5\text{V}$ ,  $EN = 5\text{V}$ ,  $T_A = +25^\circ\text{C}$ , unless otherwise stated.

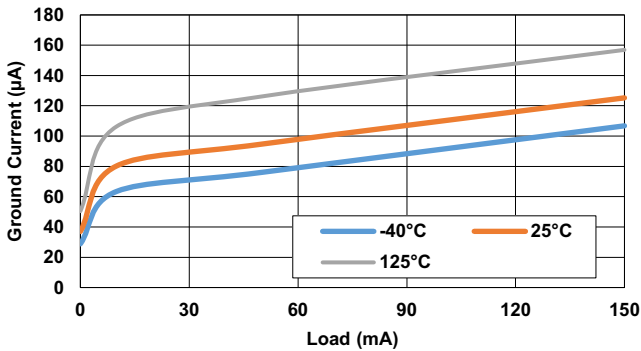

Figure 4. Ground Current vs Load Current

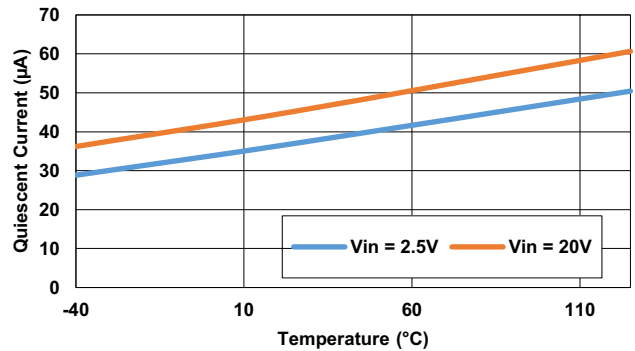

Figure 5. Quiescent Current (No Load) vs Temperature

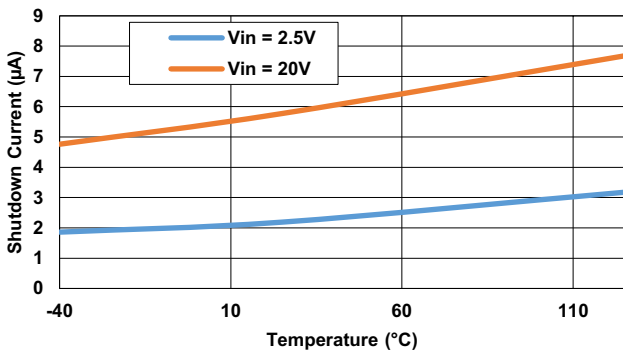

Figure 6. Shutdown Current (EN = 0) vs Temperature

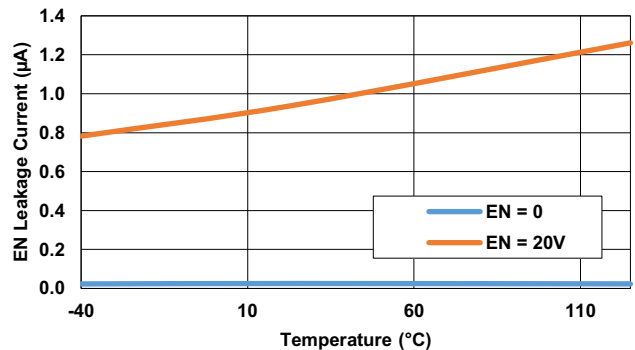

Figure 7. Current to Enable Pin vs Temperature

$C_{IN} = 1\mu F$ ,  $C_{OUT} = 2.2\mu F$ ,  $V_{IN} = 2.5V$ ,  $EN = 5V$ ,  $T_A = +25^\circ C$ , unless otherwise stated. (Cont.)

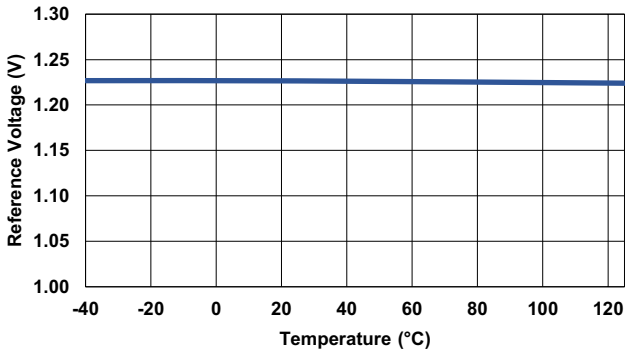

Figure 8. Reference Voltage vs Temperature

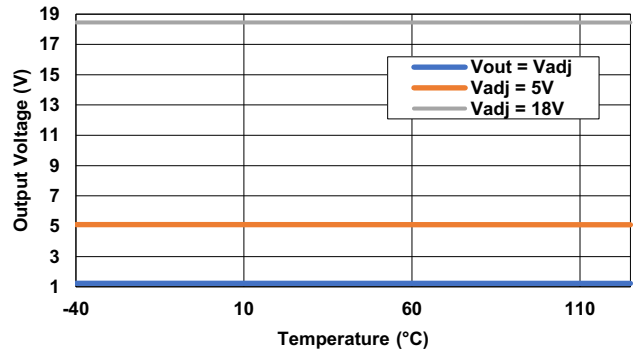

Figure 9. Output Voltage vs Temperature ( $I_{OUT} = 50mA$ )

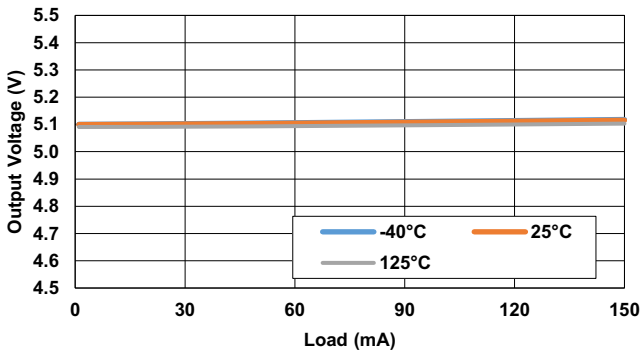

Figure 10. Output Voltage (set to 5.1V) vs Temperature vs Load

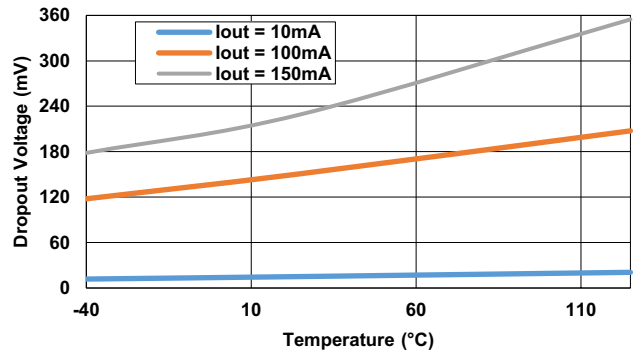

Figure 11. Dropout Voltage ( $V_{OUT} = 3.3V$ ) vs Load

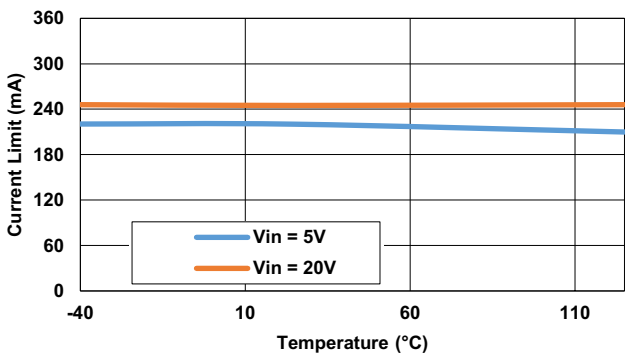

Figure 12. Current Limit vs Temperature

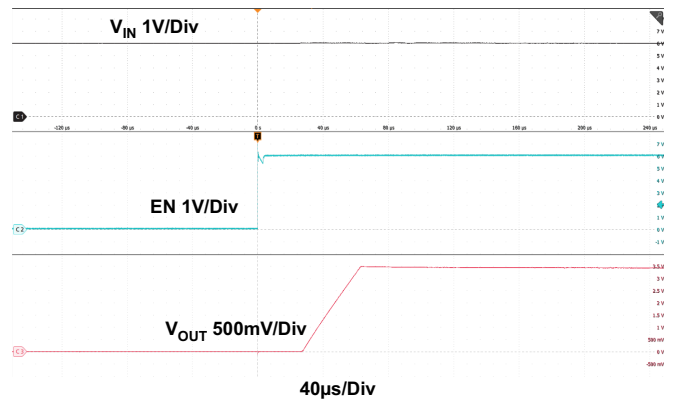

Figure 13. Startup Waveform (by 6V Enable Signal,  $V_{IN} = 6V$ ,  $V_{OUT} = 3.3V$ )

$C_{IN} = 1\mu F$ ,  $C_{OUT} = 2.2\mu F$ ,  $V_{IN} = 2.5V$ ,  $EN = 5V$ ,  $T_A = +25^\circ C$ , unless otherwise stated. (Cont.)

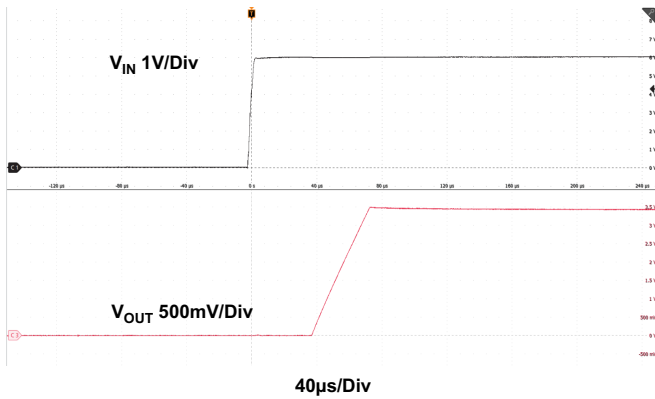

Figure 14. Startup Waveform (Enable Tied to VIN,  $V_{IN} = 6V$ ,  $V_{OUT} = 3.3V$ )

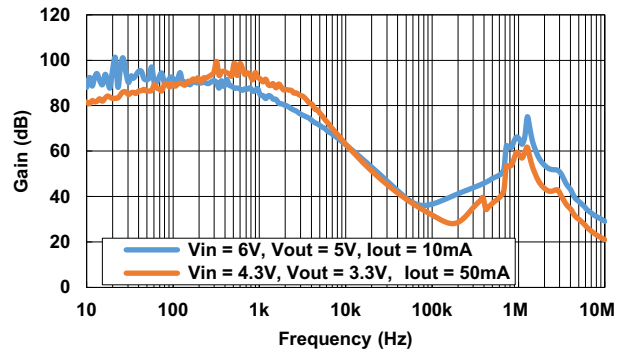

Figure 15. PSRR vs Frequency ( $C_{OUT} = 2.2\mu F$ )

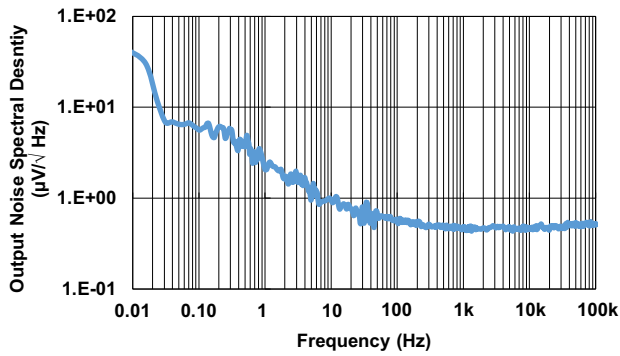

Figure 16. Output Noise Spectral Density ( $V_{IN} = 3V$ ,  $V_{OUT} = V_{ADJ}$ ,  $C_{OUT} = 2.2\mu F$ )

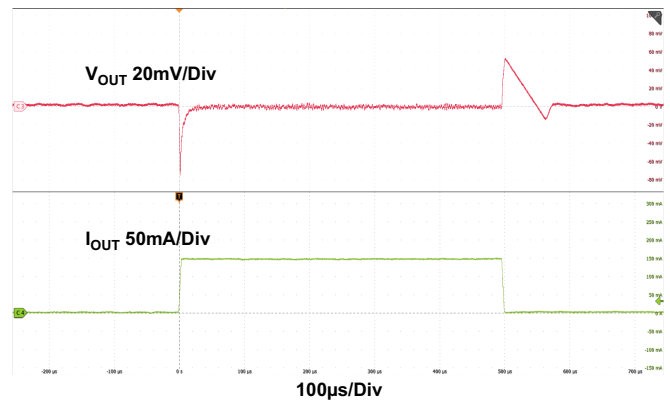

Figure 17. Load Transient (1mA to 150mA,  $V_{IN} = 6V$ ,  $V_{OUT} = 3.3V$ )

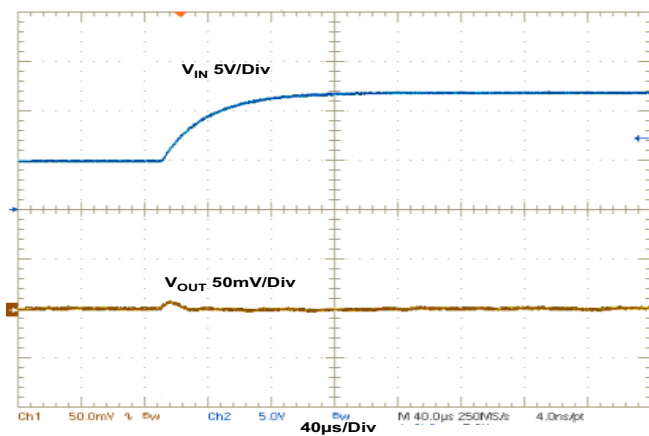

Figure 18. Line Transient (5V to 12V,  $V_{OUT} = 3.3V$ ,  $I_{OUT} = 1mA$ )

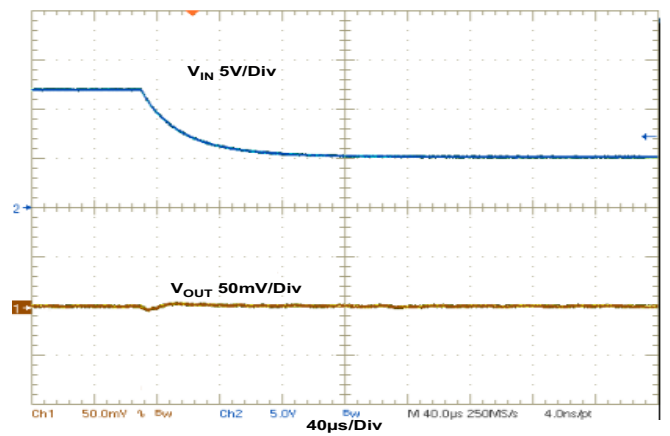

Figure 19. Line Transient (12V to 5V,  $V_{OUT} = 3.3V$ ,  $I_{OUT} = 1mA$ )



## 5. Function Description

### 5.1 Function Overview

The RAA214220 is a high performance low-dropout linear voltage regulator with 150mA sourcing capability. It operates at an input voltage range of 2.5V to 20V and has a programmable output (the reference voltage) from ~1.2266V to 18V.

### 5.2 Enable Control

The RAA214220 has an enable pin that turns the device on when pulled high. When EN is low, the IC goes into shutdown mode and draws 2µA of current. To prevent shutdown and keep the device operating, tie the EN pin directly to VIN. The RAA214220 has an accurate and stable Enable threshold that allows you to program the Enable voltage through a resistor divider.

### 5.3 Current Limit Protection

The RAA214220 has internal current limiting functionality to protect the regulator during fault conditions. During current limit, the output sources a fixed amount of current largely independent of the output voltage. If the short or overload is removed from VOUT, the output returns to normal voltage regulation mode.

### 5.4 Over-Temperature Shutdown (OTSD)

If the die temperature exceeds the over-temperature threshold of the device, the output of the LDO shuts down until the die temperature cools down to a temperature determined by the hysteresis of the OTSD. The level of power that dissipates, combined with the ambient temperature and the thermal impedance of the package, determines if the junction temperature exceeds the OTSD temperature.

## 6. Application Information

### 6.1 Setting the Output Voltage

The RAA214220 output voltage can be programmed using an external resistor divider as shown in [Figure 20](#). The output voltage is calculated using [Equation 1](#), where 1.2266V is the reference voltage.

$$(EQ. 1) \quad V_{OUT} = \left(1 + \frac{R1}{R2}\right) \times 1.2266V$$

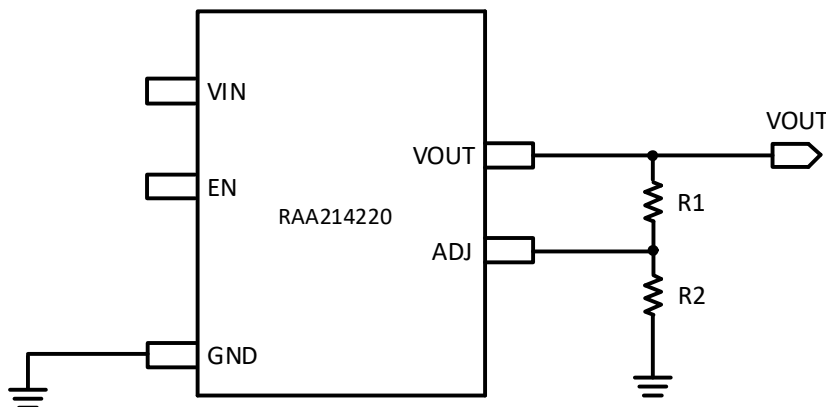

Figure 20. Setting the Output Voltage

## 6.2 Input and Output Capacitors

Renesas recommends connecting a 1μF ceramic capacitor between VIN and GND at the input to reduce circuit sensitivity to the PCB layout. As a minimum, place a 0.1μF ceramic capacitor at the input for proper operation. Higher capacitance improves the line transient response.

The device is stable with an output ceramic capacitor in the range of 1μF to 200μF. A ceramic capacitor as small as 10nF in parallel with R1 can also be used to improve the line transient response and reduce noise; although, it is not required.

For both the input and output capacitors, the X7R type is recommended because it has a low capacitance variation over-temperature.

## 6.3 Power Dissipation

The junction temperature must not exceed the range specified in [Recommended Operation Conditions](#). The power dissipation is calculated using [Equation 2](#).

$$(EQ. 2) \quad P_D = (V_{IN} - V_{OUT}) \times I_{OUT} + V_{IN} \times I_{GND}$$

To calculate the maximum ambient operating temperature, use the junction-to-ambient thermal resistance ( $\theta_{JA}$ ) as shown in [Equation 3](#), where  $T_{J(MAX)}$  is the maximum allowable junction temperature, and  $T_A$  is the ambient temperature.

$$(EQ. 3) \quad T_{J(MAX)} = P_{D(MAX)} \times \theta_{JA} + T_A$$

For any target junction temperature and output voltage, the maximum load that the IC allows decreases as the supply voltage increases. Given the thermal resistance  $\theta_{JA}$ , [Equation 2](#) and [Equation 3](#) can also be used to estimate the maximum load the IC supports up to its maximum junction temperature. The lower  $\theta_{JA}$  is, the more load the device can handle. To lower  $\theta_{JA}$ , large trace metal area and ground plane should be applied on the PCB. For example, the  $\theta_{JA}$  for this device measured on a PCB with 0.1 inch<sup>2</sup> ground trace area using 2oz copper is around 82°C/W. If the target maximum junction temperature is 125°C, [Figure 21](#) shows the maximum load allowed across the range of input and output voltage differential at the ambient temperature of 25°C, 55°C, and 85°C.

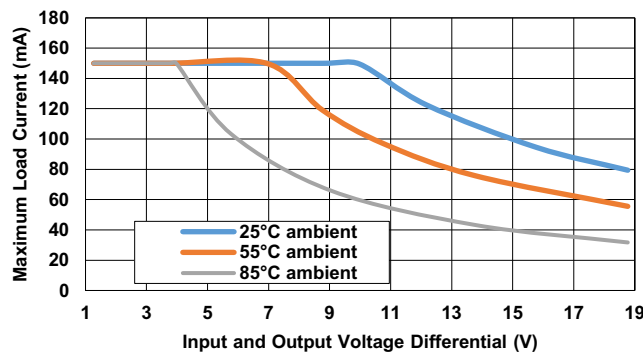

Figure 21. Example of Maximum Allowable Load vs Input and Output Voltage Differential

## 6.4 PCB Layout Recommendations

When placing components and routing the trace, minimize the ground impedance and keep the parasitic inductance low. Place the input and output capacitors as close to the IC as possible. The feedback trace in the adjustable version should be short, direct, and away from other noisy traces. Place the feedback resistors as close to the IC as possible. VIN, VOUT, and GND traces should be reasonably wide to improve the thermal performance of the IC and to reduce the chance of noise pickup.

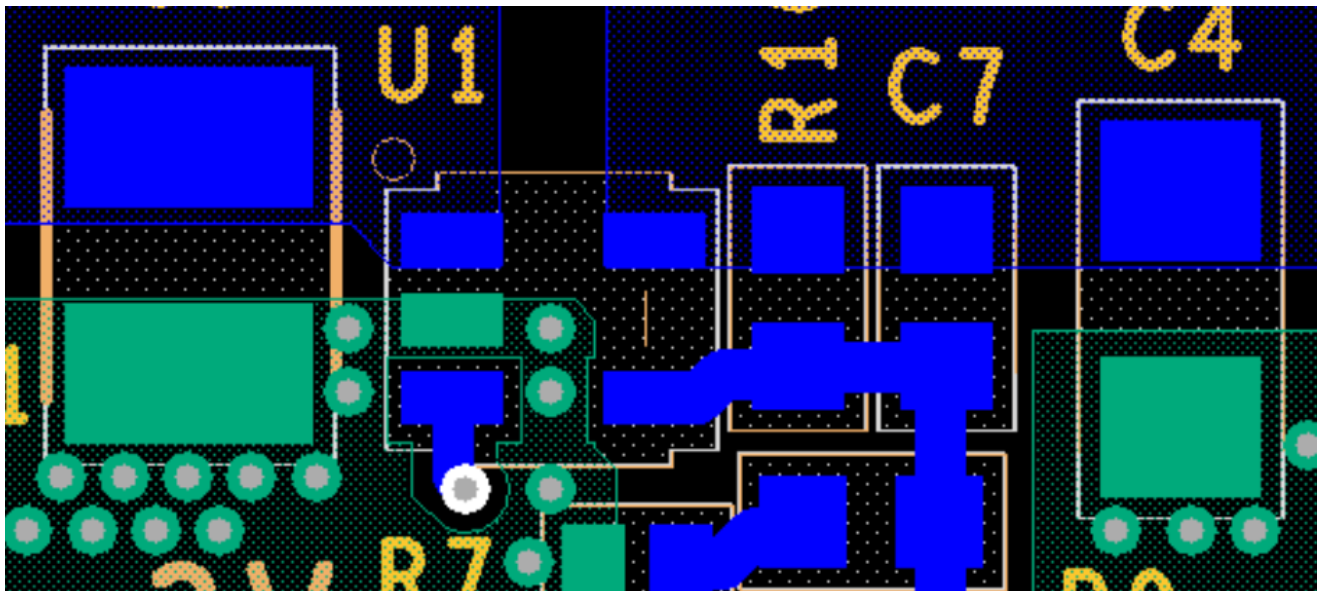
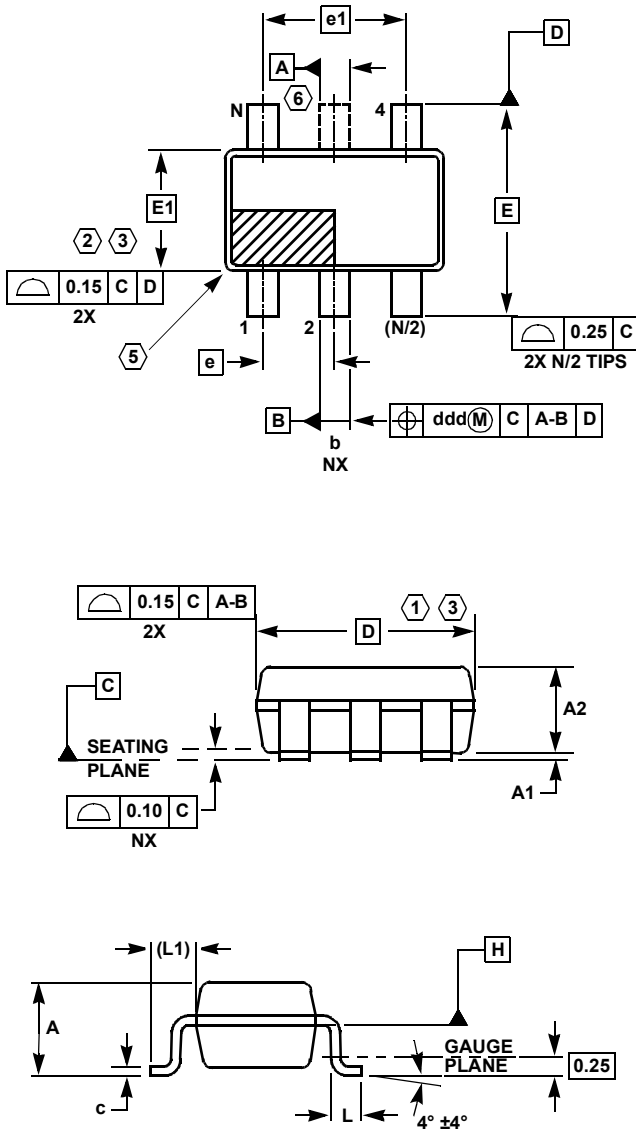

Figure 22. Recommended Component Placement

## 7. Package Outline Drawing

For the most recent package outline drawing, see [MDP0049](#)

TSOT Package Family



**MDP0049**  
TSOT PACKAGE FAMILY

SYMBOL	MILLIMETERS			TOLERANCE
	TSOT5	TSOT6	TSOT8	
A	1.00	1.00	1.00	Max
A1	0.05	0.05	0.05	$\pm 0.05$
A2	0.87	0.87	0.87	$\pm 0.03$
b	0.38	0.38	0.29	$\pm 0.07$
c	0.127	0.127	0.127	+0.07/-0.007
D	2.90	2.90	2.90	Basic
E	2.80	2.80	2.80	Basic
E1	1.60	1.60	1.60	Basic
e	0.95	0.95	0.65	Basic
$e_1$	1.90	1.90	1.95	Basic
L	0.40	0.40	0.40	$\pm 0.10$
L1	0.60	0.60	0.60	Reference
ddd	0.20	0.20	0.13	-
N	5	6	8	Reference

Rev. B 2/07

**NOTES:**

1. Plastic or metal protrusions of 0.15mm maximum per side are not included.
2. Plastic interlead protrusions of 0.15mm maximum per side are not included.
3. This dimension is measured at Datum Plane "H".
4. Dimensioning and tolerancing per ASME Y14.5M-1994.
5. Index area - Pin #1 I.D. will be located within the indicated zone (TSOT6 AND TSOT8 only).
6. TSOT5 version has no center lead (shown as a dashed line).

## 8. Ordering Information

Part Number <sup>[1][2]</sup>	Part Marking <sup>[3]</sup>	Package Description (RoHS Compliant)	Pkg. Dwg. #	Carrier Type <sup>[4]</sup>	Temp Range
RAA2142204GP3#JA0	220	SOT23	MDP0049	Reel, 3k	-40°C to 125°C

1. These Pb-free plastic packaged products employ special Pb-free material sets, molding compounds/die attach materials, and 100% matte tin plate plus anneal (e3 termination finish, which is RoHS compliant and compatible with both SnPb and Pb-free soldering operations). Pb-free products are MSL classified at Pb-free peak reflow temperatures that meet or exceed the Pb-free requirements of IPC/JEDEC J STD-020.
2. For Moisture Sensitivity Level (MSL), see the [RAA214220](#) product page. For more information about MSL, see [TB363](#).
3. The part marking is located on the bottom of the part.
4. See [TB347](#) for details about reel specifications.

## 9. Revision History

Revision	Date	Description
1.04	Jan 8, 2024	Updated Thermal Information, added $\Psi_{JT}$ .
1.03	Nov 19, 2021	Updated test conditions for the typical performance curves.
1.02	Oct 21, 2021	Updated Ordering Information table.
1.01	Sep 17, 2021	Updated Ordering Information table.
1.00	Feb 12, 2021	Initial release

## IMPORTANT NOTICE AND DISCLAIMER

RENESAS ELECTRONICS CORPORATION AND ITS SUBSIDIARIES (“RENESAS”) PROVIDES TECHNICAL SPECIFICATIONS AND RELIABILITY DATA (INCLUDING DATASHEETS), DESIGN RESOURCES (INCLUDING REFERENCE DESIGNS), APPLICATION OR OTHER DESIGN ADVICE, WEB TOOLS, SAFETY INFORMATION, AND OTHER RESOURCES “AS IS” AND WITH ALL FAULTS, AND DISCLAIMS ALL WARRANTIES, EXPRESS OR IMPLIED, INCLUDING, WITHOUT LIMITATION, ANY IMPLIED WARRANTIES OF MERCHANTABILITY, FITNESS FOR A PARTICULAR PURPOSE, OR NON-INFRINGEMENT OF THIRD-PARTY INTELLECTUAL PROPERTY RIGHTS.

These resources are intended for developers who are designing with Renesas products. You are solely responsible for (1) selecting the appropriate products for your application, (2) designing, validating, and testing your application, and (3) ensuring your application meets applicable standards, and any other safety, security, or other requirements. These resources are subject to change without notice. Renesas grants you permission to use these resources only to develop an application that uses Renesas products. Other reproduction or use of these resources is strictly prohibited. No license is granted to any other Renesas intellectual property or to any third-party intellectual property. Renesas disclaims responsibility for, and you will fully indemnify Renesas and its representatives against, any claims, damages, costs, losses, or liabilities arising from your use of these resources. Renesas' products are provided only subject to Renesas' Terms and Conditions of Sale or other applicable terms agreed to in writing. No use of any Renesas resources expands or otherwise alters any applicable warranties or warranty disclaimers for these products.

(Disclaimer Rev.1.01 Jan 2024)

### Corporate Headquarters

TOYOSU FORESIA, 3-2-24 Toyosu,  
Koto-ku, Tokyo 135-0061, Japan  
[www.renesas.com](http://www.renesas.com)

### Trademarks

Renesas and the Renesas logo are trademarks of Renesas Electronics Corporation. All trademarks and registered trademarks are the property of their respective owners.

### Contact Information

For further information on a product, technology, the most up-to-date version of a document, or your nearest sales office, please visit [www.renesas.com/contact-us/](http://www.renesas.com/contact-us/).