

**Description**

This document will explain how to use Intersil's Quad Programmable Down Converter, HSP50216, for CDMA2000 applications. It will provide details on how to combine channels in order to increase the output rate and achieve better filter performance.

**Configuration 1**

Input Rate: 61.44MSPS (50x)

Output Rate: 2.4576MSPS (2x)

Blocker rejection: > 48dB from 750kHz to 900kHz, > 85dB from 900kHz on

This configuration implements a 1.2288MSPS receiver in the HSP50216 using only one of the four available channels, providing up to four receivers per device. The block diagram of the implementation is shown in Figure 1. It consists of a 5th order CIC decimating by 10 followed by the filter compute engine (FCE) running both a two phase polyphase decimator and a 28-tap FIR.

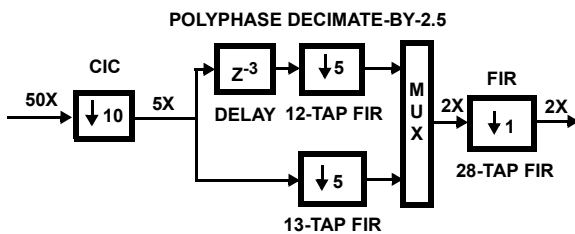

FIGURE 1. FILTER CONFIGURATION BLOCK DIAGRAM

In general, it is best to perform as much of the decimation as possible in the CIC since this avoids having to use clock cycles to write data to the FCE RAM, but this is limited by the tolerable alias level. The chosen decimation of 10 yields a first alias level of -96.135dB (see HSP50216 data sheet, Table 45 with  $f_s/R = 0.5 / 5 = 0.10$ ). For comparison, a CIC decimation of 25 would give an unacceptable first alias level of -52.269dB (for  $f_s/R = 0.5 / 2 = 0.25$ ).

The flexibility of the HSP50216's FCE is seen in the polyphase and FIR structures of Figure 1. A five-step filter sequence is used to implement it. Step 0 is a wait instruction, which waits for 5 new samples to be transferred from the CIC to the FCE's RAM. When these new samples are available steps 1 and 2 (the 12 and 13-tap FIRs, respectively) are run. The 12-tap FIR is preceded by a 3 sample delay (a read pointer offset) giving its output a total group delay of  $3 + (12-1)/2 = 8.5$  samples. The 13-tap FIR's group delay,  $(13-1)/2 = 6$ , differs by 2.5 samples. Together, these polyphase FIRs generate two equally-spaced output samples for each five new input samples. When multiplexed

together, the result is a decimation of 2.5. These outputs are sent to filter sequence step number 3, a 28-tap FIR. Step 4, the final step, is a loop back to step 0's wait for five new input samples. This FCE program, along with the filter coefficient data, is provided in the import filter file.

Frequency responses of the polyphase decimator and 28-tap FIR are provided in Figures 2 and 3. From Figure 2, the first alias level for decimation by 5 is about -94dB. The loss at high frequencies in the polyphase is compensated for by the gain in the 28-tap FIR (Figure 3).

Figures 4, 5, and 6 provide show a complete frequency response of the configuration by doing an actual sweep of the part. The plots used a frequency step of 1kHz and are normalized to a 0dB maximum.

The overall decimation of  $50X / 2X = 25$  allows 24 bit I and Q data to be available at the serial outputs.

Analysis of computation clock usage:

Available clocks per output =  $50 / 2 = 25$ .

TABLE 1.

CLOCKS	FUNCTION
2	Overhead (Wait, Loop).
5	Input Writes from CIC to FCE.
6	12-Tap FIR Computation.
7	13-Tap FIR Computation.
2	2 Input Writes to 28-tap FIR.
28	2 Runs of 28-Tap FIR (One for Each Polyphase Output) X 14 Clocks Per Run.
50	Total Clocks to Compute 2 Outputs

All available clocks are used to implement this configuration.

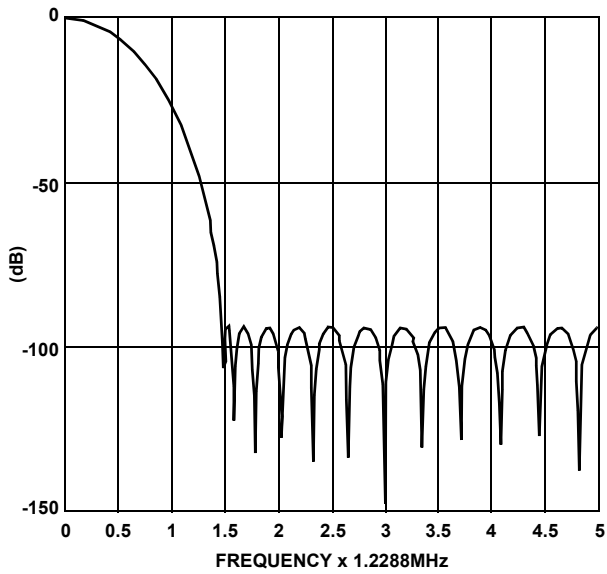

FIGURE 2. POLYPHASE DECIMATOR FREQUENCY RESPONSE, 25-TAP IMPULSE

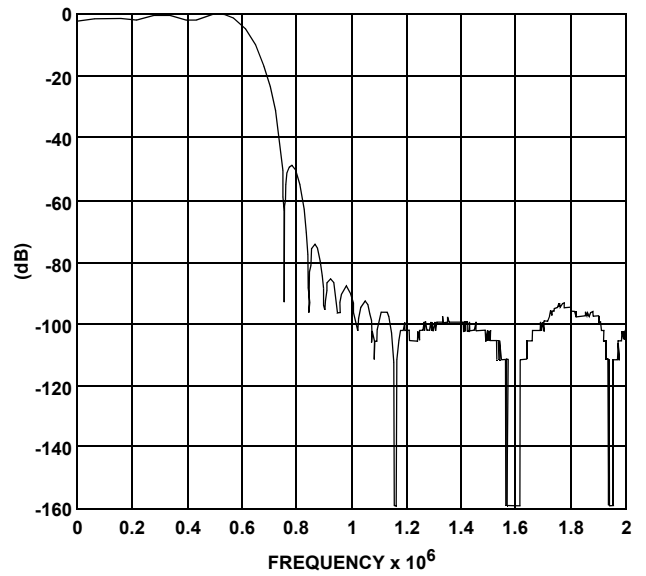

FIGURE 4. FREQUENCY SWEEP OF THE FILTER AS IMPLEMENTED ON THE HSP50216

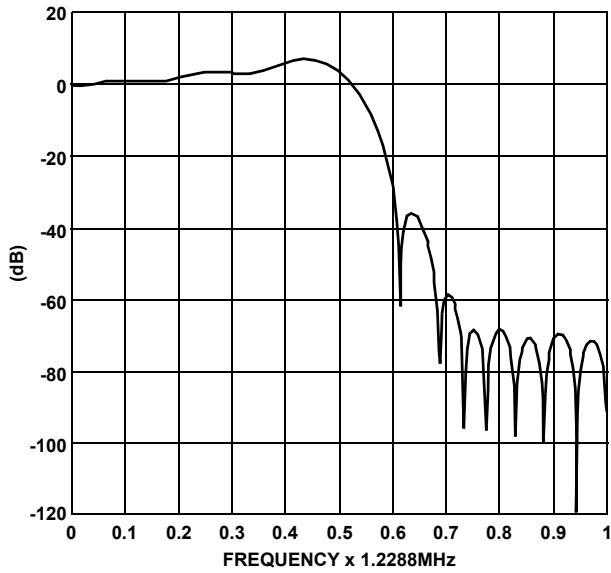

FIGURE 3. 28-TAP FIR FREQUENCY RESPONSE

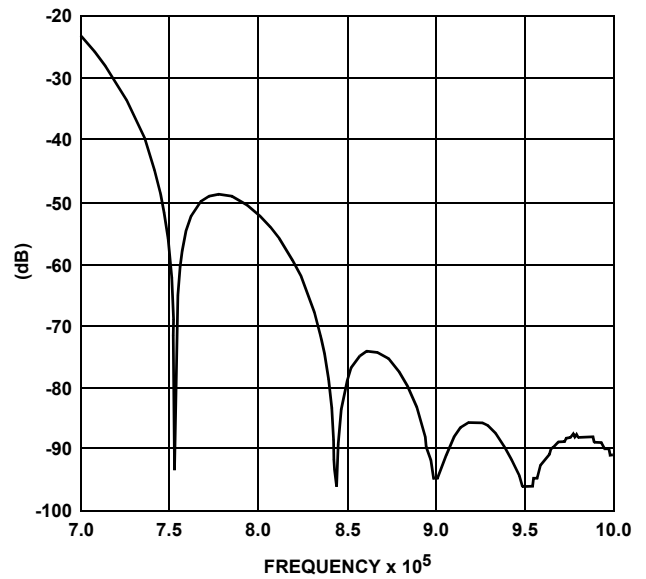

FIGURE 5. FREQUENCY SWEEP ZOOMED IN AROUND 750kHz AND 900kHz BLOCKER FREQUENCIES

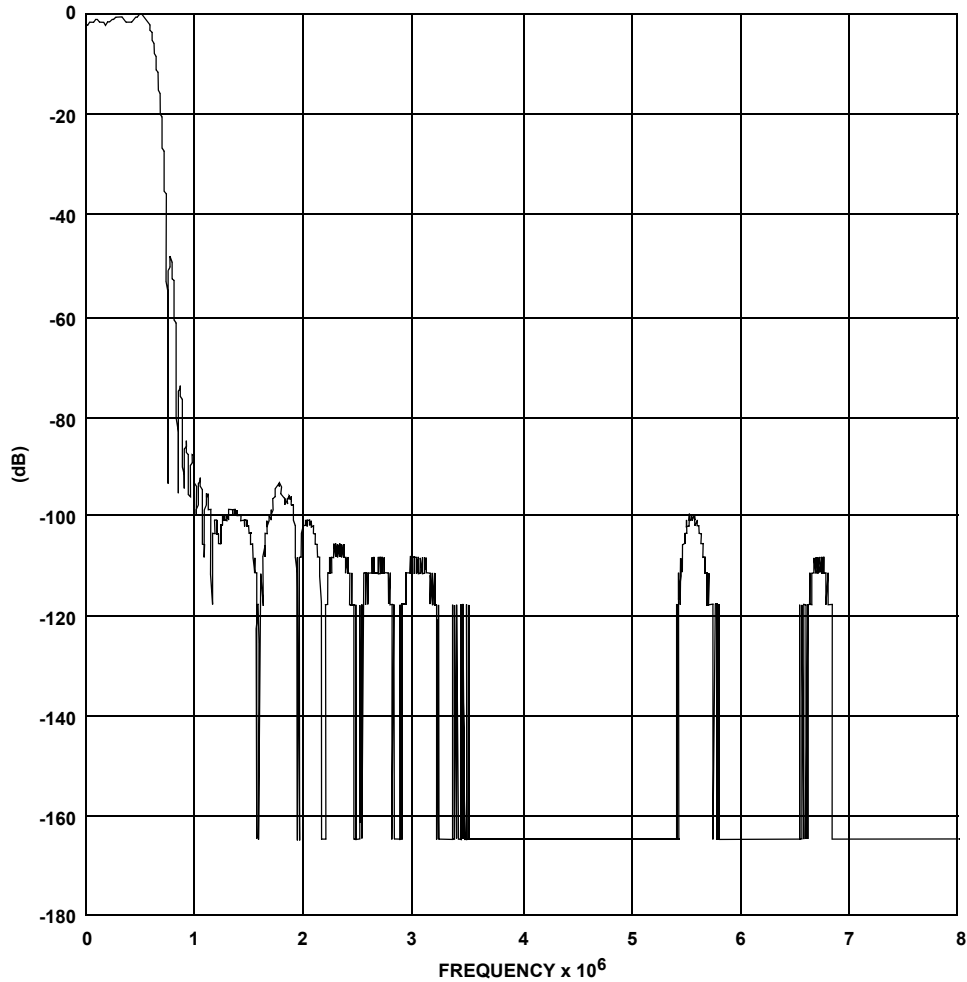

FIGURE 6. FREQUENCY SWEEP FROM DC TO 8MHz

## Configuration 2

Input Rate: 61.44MSPS (50x)

Output Rate: 2.4576MSPS (2x)

Blocker Rejection: > 65dB from 750kHz to 900kHz, > 103dB  
from 900kHz On

This configuration implements a 1.2288MSPS receiver in the HSP50216 using two of the four available channels, providing up to two receivers per device. The block diagram of the implementation of two receivers is shown in Figure 7 below. It consists of, in the first channel, a 5th order CIC decimating by 10 followed by the filter compute engine (FCE) running a two-phase polyphase decimator and, in the second channel, a 44-tap FIR.

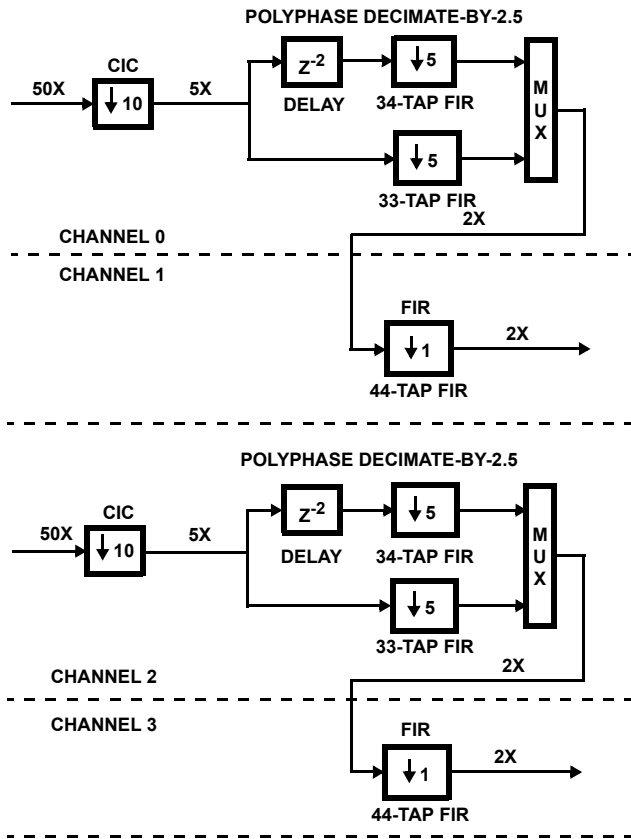

FIGURE 7. FILTER CONFIGURATION BLOCK DIAGRAM FOR TWO RECEIVERS

As shown in the first configuration, the chosen decimation of 10 in this configuration with a 50X input yields a first alias level of -96.135dB.

The decimate-by-2.5 filter is implemented in the FCE as a 4-step sequence. Step 0 is a wait instruction, which waits for 5 new samples to be transferred from the CIC to the FCE's RAM. When these new samples are available steps 1 and 2 (the 34 and 33-tap FIRs, respectively) are run. The 34-tap FIR is preceded by a 2 sample delay (a read pointer offset) giving its output a total group delay of  $2 + (34-1)/2 = 18.5$  samples. The 33-tap FIR's group delay,  $(33-1)/2 = 16$ , differs by 2.5 samples. Together, these polyphase FIRs generate two equally-spaced output samples for each five new input samples. When multiplexed together, the result is a decimation of 2.5. These outputs are sent to the FCE of the next channel, which runs a 44-tap FIR. Step 3, the final step of the polyphase sequence, is a loop back to step 0's wait for five new input samples. This FCE program, along with the polyphase filter coefficient data, is provided in the import filter file.

Frequency responses of the polyphase decimator and 44-tap FIR are provided in Figures 8 and 9. From Figure 8, the first alias level in the signal bandwidth for decimation by 5 is about -120dB.

Figures 10, 11, and 12 provide show a complete frequency response of the configuration by doing an actual sweep of the part. The plots used a frequency step of 1kHz and are normalized to a 0dB maximum.

The overall decimation of  $50X / 2X = 25$  allows 24 bit I and Q data to be available at the serial outputs.

### Analysis of Computation Clock Usage

#### Channel 0

Available clocks per output =  $50 / 2 = 25$

CLOCKS	FUNCTION
2	Overhead (Wait, Loop)
5	Input Writes from CIC to FCE
17	34-Tap FIR Computation
17	33-Tap FIR Computation
41	Total Clocks to Compute 2 Outputs

Channel 0 has 50 clocks available to produce 2 outputs (25 clocks per output), but its configuration uses only 41. These available 9 clock cycles permit up to an additional 18 taps to be added to channel 0's filtering if desired.

#### Channel 1

Available clocks per output = 25 (same as channel 0)

CLOCKS	FUNCTION
2	Overhead (Wait, Loop)
2	Input Writes from Channel 0's FCE to Channel 1's FCE
44	2 Runs of the 44-Tap Filter x 22 Clocks Per Run
48	Total Clocks to Compute 2 Outputs

Channel 1's configuration uses 48 of its available 50 clocks in computing two output samples. An additional 4 taps could be added to this filter if desired.

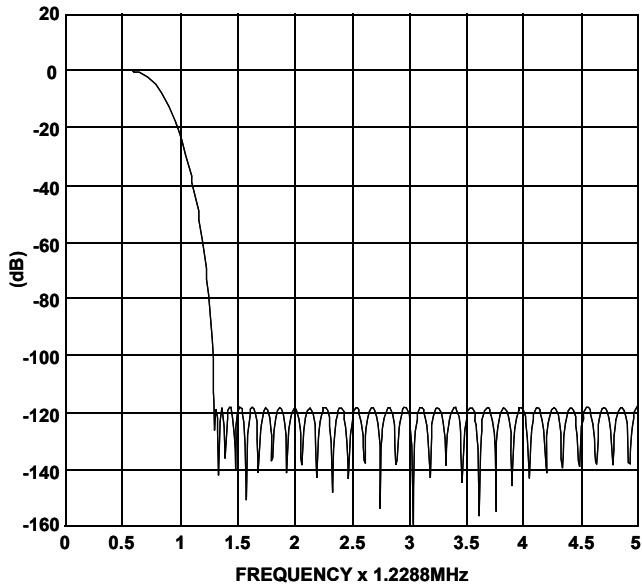

FIGURE 8. POLYPHASE DECIMATOR FREQUENCY RESPONSE, 67-TAP IMPULSE

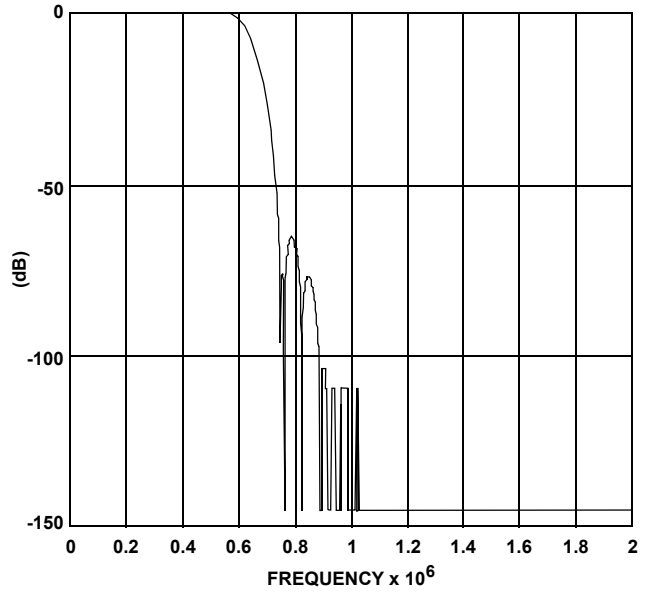

FIGURE 10. FREQUENCY SWEEP OF THE FILTER AS IMPLEMENTED ON THE HSP50216

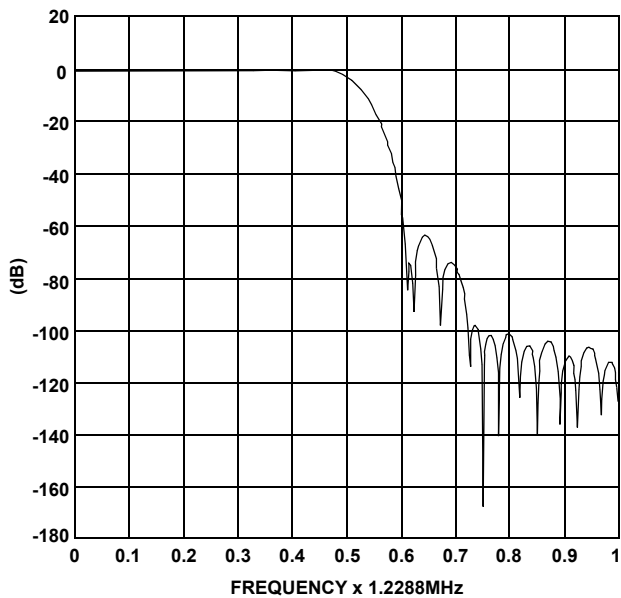

FIGURE 9. 44-TAP FIR FREQUENCY RESPONSE

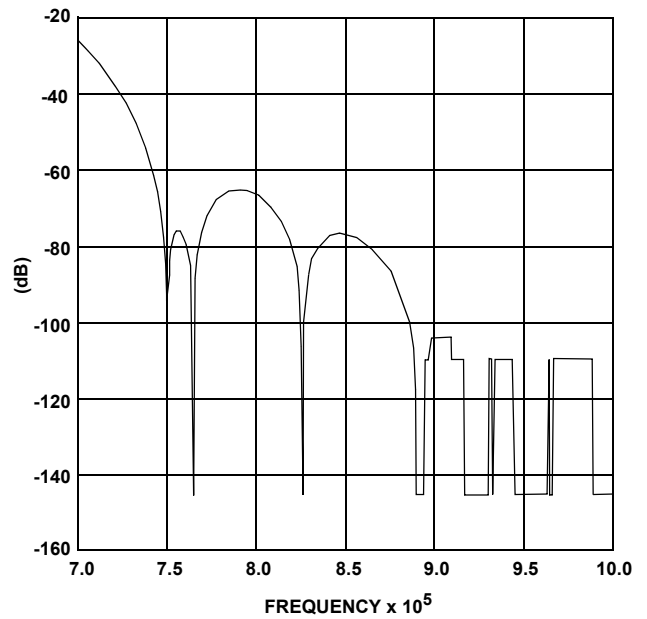

FIGURE 11. FREQUENCY SWEEP ZOOMED IN AROUND 750kHz AND 900kHz BLOCKER FREQUENCIES

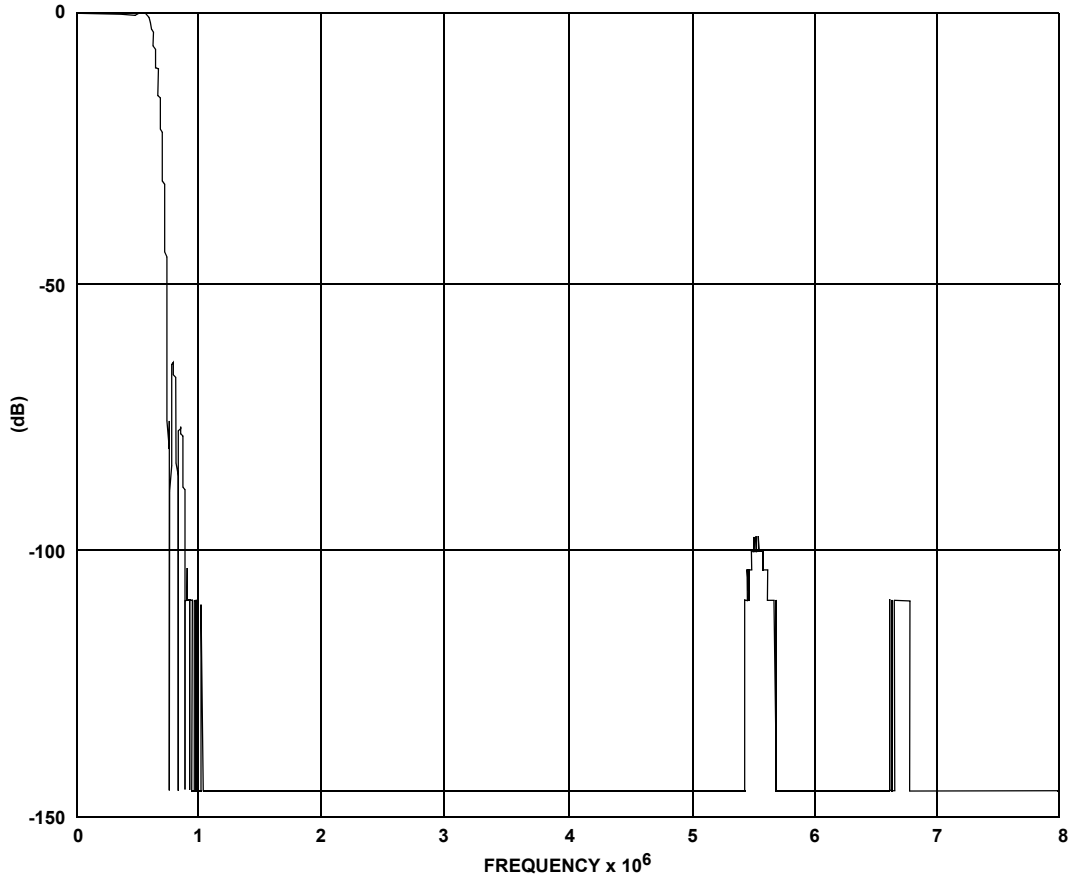

FIGURE 12. FREQUENCY SWEEP TO 8MHz

### Use of HSP50216 EVAL Software for this Application

The eval board software is the perfect tool to evaluate performance of the part, configure registers, verify filter designs, and display the I/Q constellation and spectrum of the output. Connectivity to the eval board is supported only by Windows 95 and 98, however Windows NT and 2000 may be used for generating the register value files which may be downloaded to the chip with the user's own hardware.

NOTE: The software can configure the register value files even if the HSP50216/ ISL5216 Evaluation Board is not connected.

The configuration file is loaded by selecting option 8 in the main menu of the software. Enter only the root name of the configuration, where the root name is the file name preceding the .0, .1, .2, .3 and .top file extensions.

Figure 14 shows the channel 0 data path settings for Configuration 1 (in the configuration files for this example, channels 1, 2 and 3 are configured the same as channel 0). It shows the 61.44MSPS input rate, 5th order CIC decimation of 10, and an NCO center frequency as well as the source input bus. The imported filter program specified in options 13, 27 and 28 contains both the FCE program and 12, 13 and 28-tap

FIR coefficients (see Figure 1). Imported filters are hand-coded filter programs which bypass the software's automatic register value generation.

When loading of the configuration is completed (main menu option 8), initialize the eval board using option 17, compute the register value files using option 10, and download the register values to the '216 using option 12. Finally, select run and display (option 13) to see the '216 output in real time.

As noted previously, if only register values are needed, option 10 in the Main Menu will compute register values for each of the channels, and store them in the files file\_name.r0, file\_name.r1, file\_name.r2, file\_name.r3 and file\_name.rtp where file\_name is name entered into the load or save configuration options (8 and 9) from the main menu. These files are human readable text files containing register numbers and values in hex.

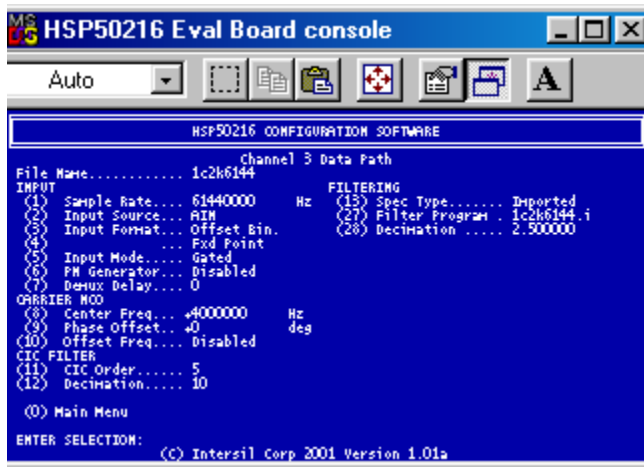

FIGURE 13. EVAL BOARD SOFTWARE MAIN MENU

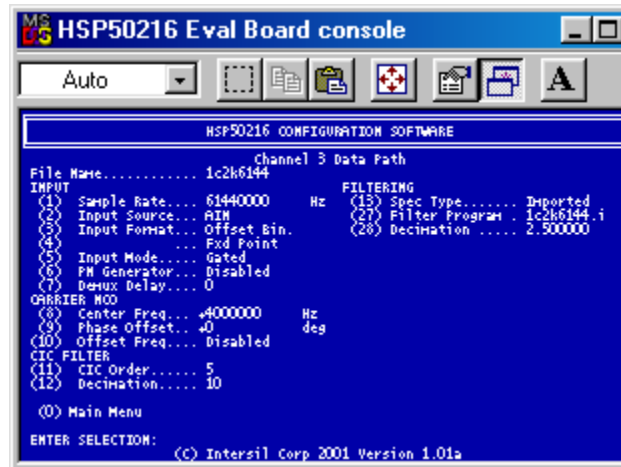

FIGURE 14. EVAL BOARD SOFTWARE DATA PATH MENU

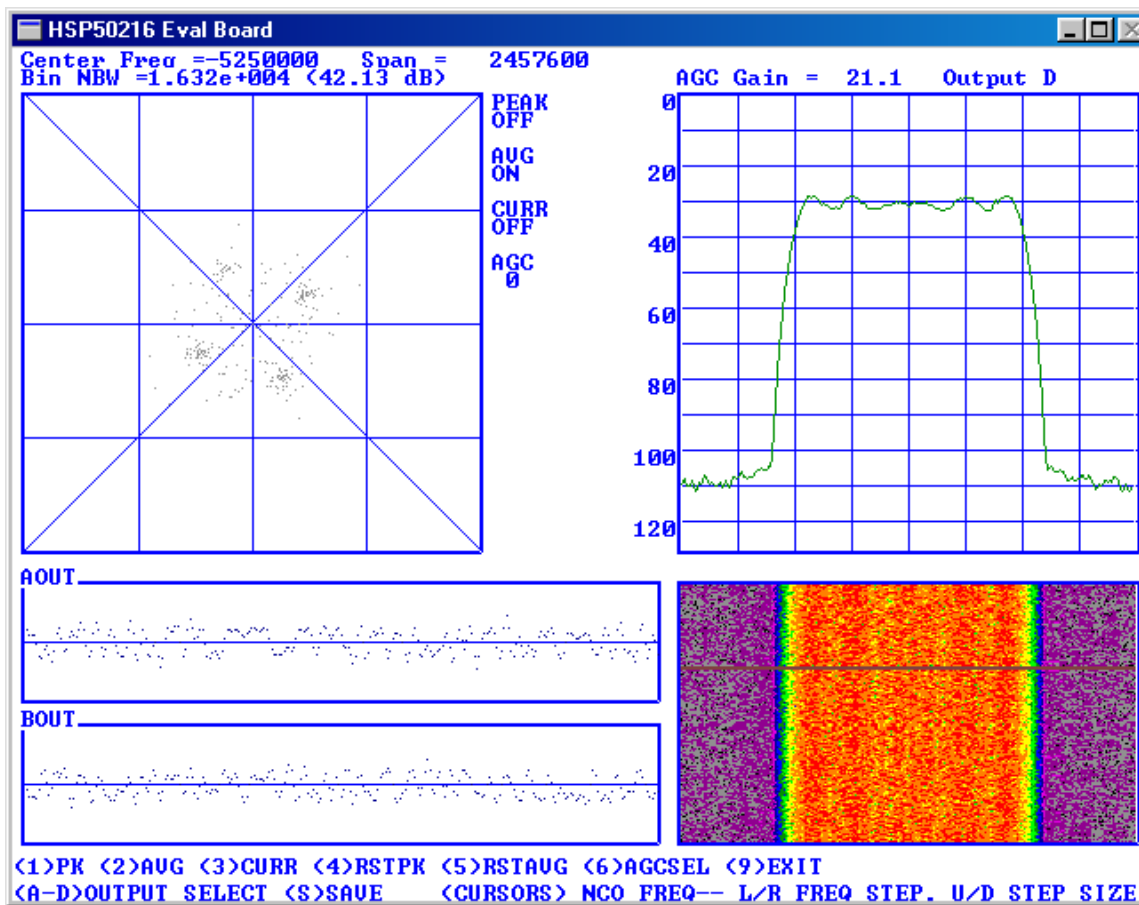

FIGURE 15. SCREEN SHOT FROM HSP50216 EVALUATION BOARD SOFTWARE

## Notice

1. Descriptions of circuits, software and other related information in this document are provided only to illustrate the operation of semiconductor products and application examples. You are fully responsible for the incorporation or any other use of the circuits, software, and information in the design of your product or system. Renesas Electronics disclaims any and all liability for any losses and damages incurred by you or third parties arising from the use of these circuits, software, or information.
2. Renesas Electronics hereby expressly disclaims any warranties against and liability for infringement or any other claims involving patents, copyrights, or other intellectual property rights of third parties, by or arising from the use of Renesas Electronics products or technical information described in this document, including but not limited to, the product data, drawings, charts, programs, algorithms, and application examples.
3. No license, express, implied or otherwise, is granted hereby under any patents, copyrights or other intellectual property rights of Renesas Electronics or others.
4. You shall not alter, modify, copy, or reverse engineer any Renesas Electronics product, whether in whole or in part. Renesas Electronics disclaims any and all liability for any losses or damages incurred by you or third parties arising from such alteration, modification, copying or reverse engineering.
5. Renesas Electronics products are classified according to the following two quality grades: "Standard" and "High Quality". The intended applications for each Renesas Electronics product depends on the product's quality grade, as indicated below.  
"Standard": Computers; office equipment; communications equipment; test and measurement equipment; audio and visual equipment; home electronic appliances; machine tools; personal electronic equipment; industrial robots; etc.  
"High Quality": Transportation equipment (automobiles, trains, ships, etc.); traffic control (traffic lights); large-scale communication equipment; key financial terminal systems; safety control equipment; etc.  
Unless expressly designated as a high reliability product or a product for harsh environments in a Renesas Electronics data sheet or other Renesas Electronics document, Renesas Electronics products are not intended or authorized for use in products or systems that may pose a direct threat to human life or bodily injury (artificial life support devices or systems; surgical implantations; etc.), or may cause serious property damage (space system; undersea repeaters; nuclear power control systems; aircraft control systems; key plant systems; military equipment; etc.). Renesas Electronics disclaims any and all liability for any damages or losses incurred by you or any third parties arising from the use of any Renesas Electronics product that is inconsistent with any Renesas Electronics data sheet, user's manual or other Renesas Electronics document.
6. When using Renesas Electronics products, refer to the latest product information (data sheets, user's manuals, application notes, "General Notes for Handling and Using Semiconductor Devices" in the reliability handbook, etc.), and ensure that usage conditions are within the ranges specified by Renesas Electronics with respect to maximum ratings, operating power supply voltage range, heat dissipation characteristics, installation, etc. Renesas Electronics disclaims any and all liability for any malfunctions, failure or accident arising out of the use of Renesas Electronics products outside of such specified ranges.
7. Although Renesas Electronics endeavors to improve the quality and reliability of Renesas Electronics products, semiconductor products have specific characteristics, such as the occurrence of failure at a certain rate and malfunctions under certain use conditions. Unless designated as a high reliability product or a product for harsh environments in a Renesas Electronics data sheet or other Renesas Electronics document, Renesas Electronics products are not subject to radiation resistance design. You are responsible for implementing safety measures to guard against the possibility of bodily injury, injury or damage caused by fire, and/or danger to the public in the event of a failure or malfunction of Renesas Electronics products, such as safety design for hardware and software, including but not limited to redundancy, fire control and malfunction prevention, appropriate treatment for aging degradation or any other appropriate measures. Because the evaluation of microcomputer software alone is very difficult and impractical, you are responsible for evaluating the safety of the final products or systems manufactured by you.
8. Please contact a Renesas Electronics sales office for details as to environmental matters such as the environmental compatibility of each Renesas Electronics product. You are responsible for carefully and sufficiently investigating applicable laws and regulations that regulate the inclusion or use of controlled substances, including without limitation, the EU RoHS Directive, and using Renesas Electronics products in compliance with all these applicable laws and regulations. Renesas Electronics disclaims any and all liability for damages or losses occurring as a result of your noncompliance with applicable laws and regulations.
9. Renesas Electronics products and technologies shall not be used for or incorporated into any products or systems whose manufacture, use, or sale is prohibited under any applicable domestic or foreign laws or regulations. You shall comply with any applicable export control laws and regulations promulgated and administered by the governments of any countries asserting jurisdiction over the parties or transactions.
10. It is the responsibility of the buyer or distributor of Renesas Electronics products, or any other party who distributes, disposes of, or otherwise sells or transfers the product to a third party, to notify such third party in advance of the contents and conditions set forth in this document.
11. This document shall not be reprinted, reproduced or duplicated in any form, in whole or in part, without prior written consent of Renesas Electronics.
12. Please contact a Renesas Electronics sales office if you have any questions regarding the information contained in this document or Renesas Electronics products.  
(Note 1) "Renesas Electronics" as used in this document means Renesas Electronics Corporation and also includes its directly or indirectly controlled subsidiaries.  
(Note 2) "Renesas Electronics product(s)" means any product developed or manufactured by or for Renesas Electronics.

(Rev.4.0-1 November 2017)



### SALES OFFICES

Renesas Electronics Corporation

<http://www.renesas.com>

Refer to "<http://www.renesas.com/>" for the latest and detailed information.

**Renesas Electronics America Inc.**  
1001 Murphy Ranch Road, Milpitas, CA 95035, U.S.A.  
Tel: +1-408-432-8888, Fax: +1-408-434-5351

**Renesas Electronics Canada Limited**  
9251 Yonge Street, Suite 8309 Richmond Hill, Ontario Canada L4C 9T3  
Tel: +1-905-237-2004

**Renesas Electronics Europe Limited**  
Dukes Meadow, Millboard Road, Bourne End, Buckinghamshire, SL8 5FH, U.K  
Tel: +44-1628-651-700, Fax: +44-1628-651-804

**Renesas Electronics Europe GmbH**  
Arcadiastrasse 10, 40472 Düsseldorf, Germany  
Tel: +49-211-6503-0, Fax: +49-211-6503-1327

**Renesas Electronics (China) Co., Ltd.**  
Room 1709 Quantum Plaza, No.27 ZhichunLu, Haidian District, Beijing, 100191 P. R. China  
Tel: +86-10-8235-1155, Fax: +86-10-8235-7679

**Renesas Electronics (Shanghai) Co., Ltd.**  
Unit 301, Tower A, Central Towers, 555 Langao Road, Putuo District, Shanghai, 200333 P. R. China  
Tel: +86-21-2226-0888, Fax: +86-21-2226-0999

**Renesas Electronics Hong Kong Limited**  
Unit 1601-1611, 16/F., Tower 2, Grand Century Place, 193 Prince Edward Road West, Mongkok, Kowloon, Hong Kong  
Tel: +852-2265-6688, Fax: +852-2886-9022

**Renesas Electronics Taiwan Co., Ltd.**  
13F, No. 363, Fu Shing North Road, Taipei 10543, Taiwan  
Tel: +886-2-8175-9600, Fax: +886-2-8175-9670

**Renesas Electronics Singapore Pte. Ltd.**  
80 Bendemeer Road, Unit #06-02 Hyflux Innovation Centre, Singapore 339949  
Tel: +65-6213-0200, Fax: +65-6213-0300

**Renesas Electronics Malaysia Sdn.Bhd.**  
Unit 1207, Block B, Menara Amcorp, Amcorp Trade Centre, No. 18, Jln Persiaran Barat, 46050 Petaling Jaya, Selangor Darul Ehsan, Malaysia  
Tel: +60-3-7955-9390, Fax: +60-3-7955-9510

**Renesas Electronics India Pvt. Ltd.**  
No.777C, 100 Feet Road, HAL 2nd Stage, Indiranagar, Bangalore 560 038, India  
Tel: +91-80-67208700, Fax: +91-80-67208777

**Renesas Electronics Korea Co., Ltd.**  
17F, KAMCO Yangjae Tower, 262, Gangnam-daero, Gangnam-gu, Seoul, 06265 Korea  
Tel: +82-2-558-3737, Fax: +82-2-558-5338