

F1162 Gain versus Temperature

- May 23, 2014
- AT0090

Michael J Virostko
Principal Product Application Engineer



The Analog and Digital Company™



Agenda

- Customer Concerns
- Testing
- Conclusion



Customer Concerns

- Customer is using the F1162 Dual Downconverting Mixer and is observing lower gain at $-40\text{ }^{\circ}\text{C}$ than at $+25\text{ }^{\circ}\text{C}$ which is not typical and not seen in our datasheet.
- The customer is using the mixer in a system.
- We will perform a gain versus temperature test.

Test Measurements

- Testing will be done over temperature from -40 to +95 °C.
- The RF will be swept from 2.00 to 2.75 GHz.
- The IF will be swept from 50 MHz to 250 MHz.
- Both the high and low side LO injection will be used.
- Only the gain will be measured for Channel A.



Test Setup

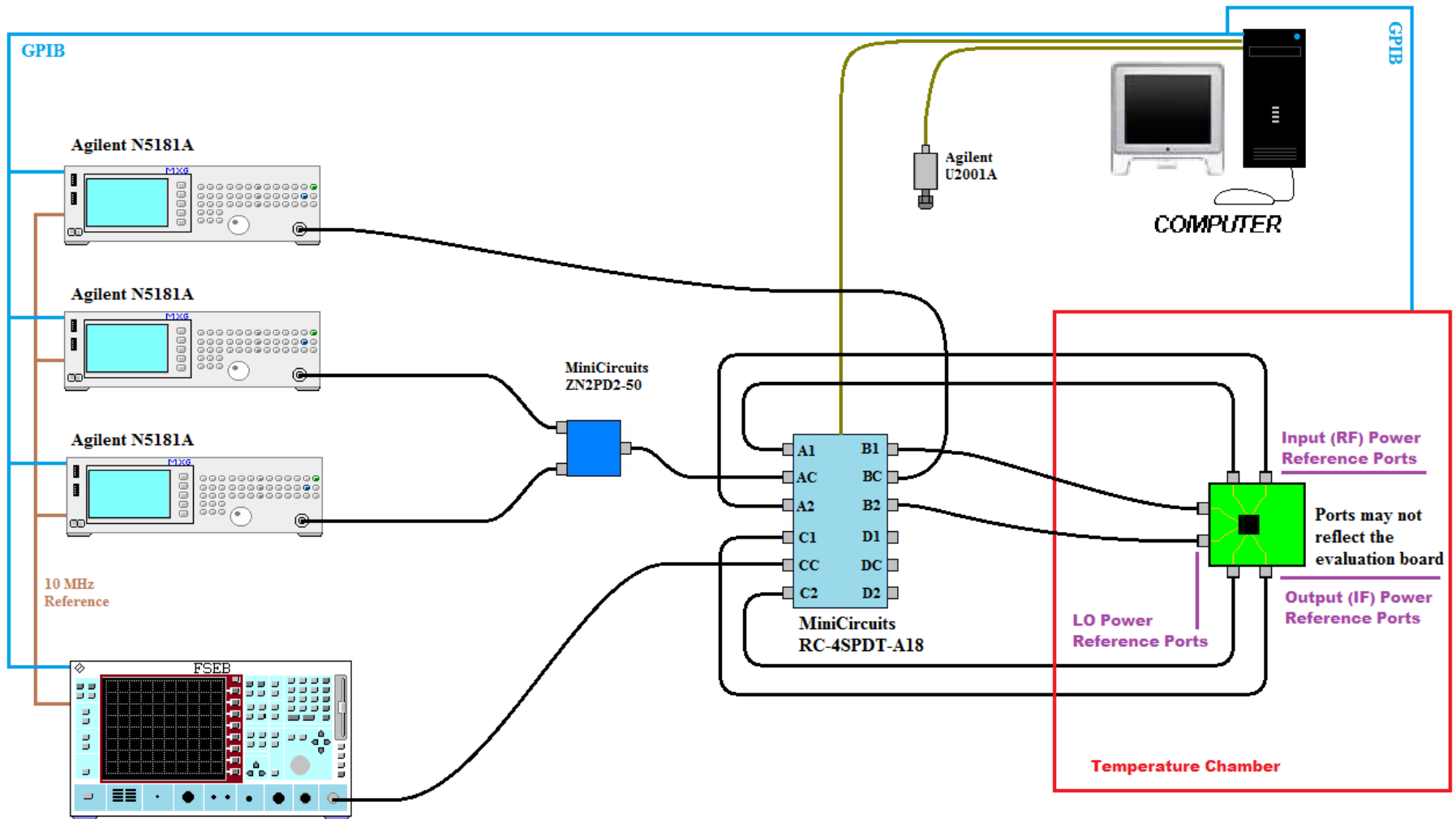

Conversion Gain- Low Side LO, IF = 50 MHz

F1162 Standard Mode Gain
Low Side LO Injection (LO < RF), IF = RF - LO = 50 MHz

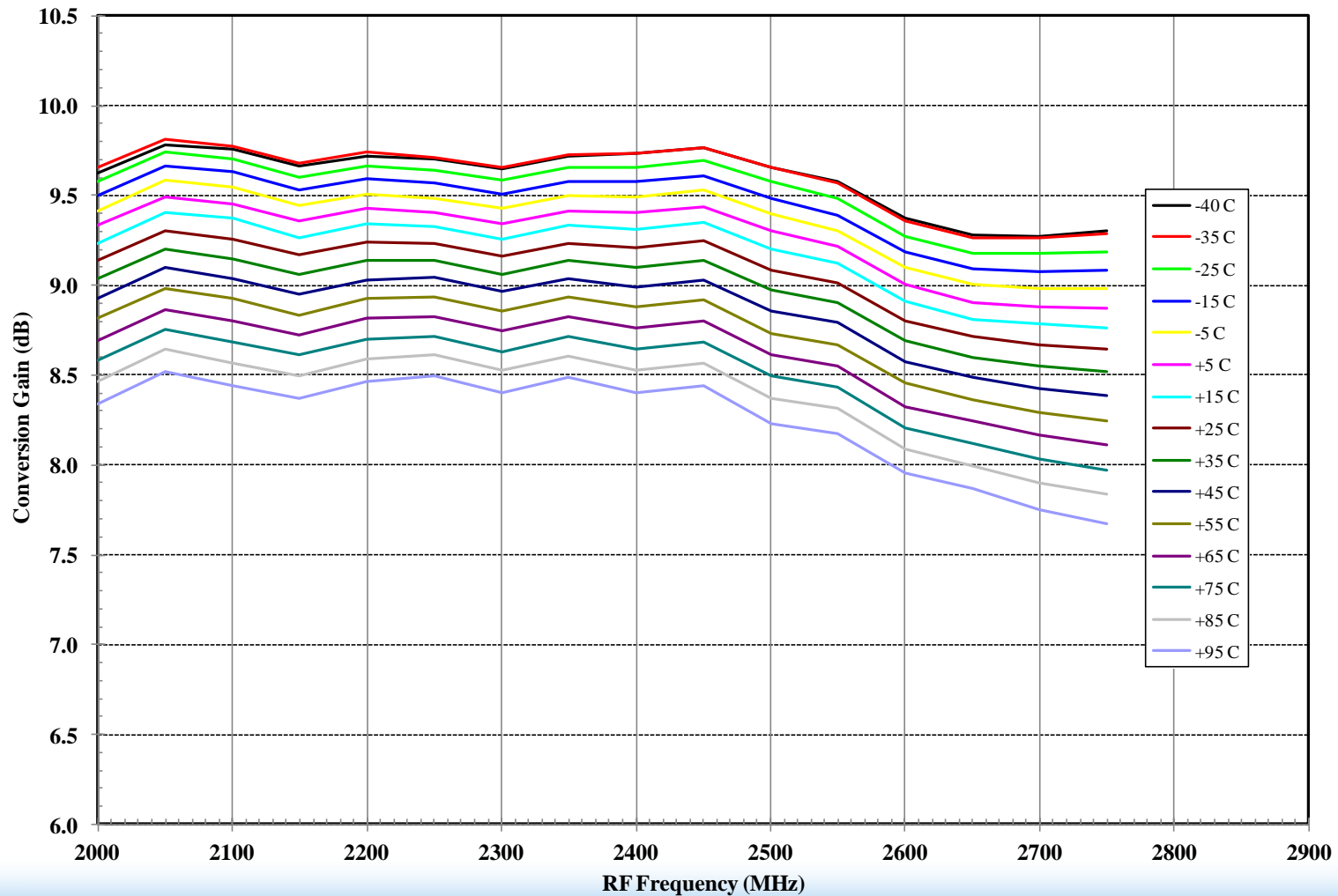

Conversion Gain- Low Side LO, IF = 100 MHz

F1162 Standard Mode Gain
Low Side LO Injection (LO < RF), IF = RF - LO = 100 MHz

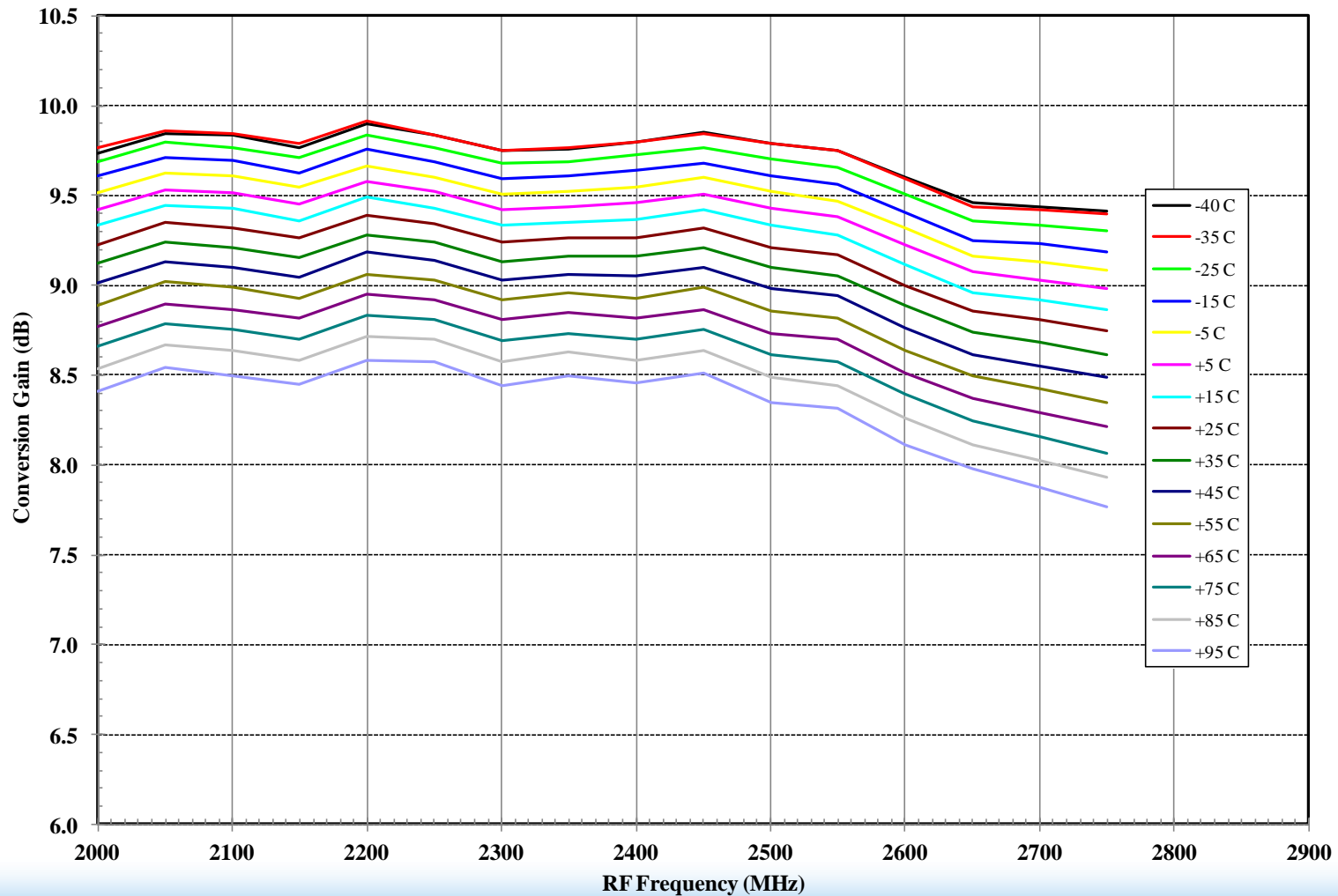

Conversion Gain- Low Side LO, IF = 150 MHz

F1162 Standard Mode Gain
Low Side LO Injection (LO < RF), IF = RF - LO = 150 MHz

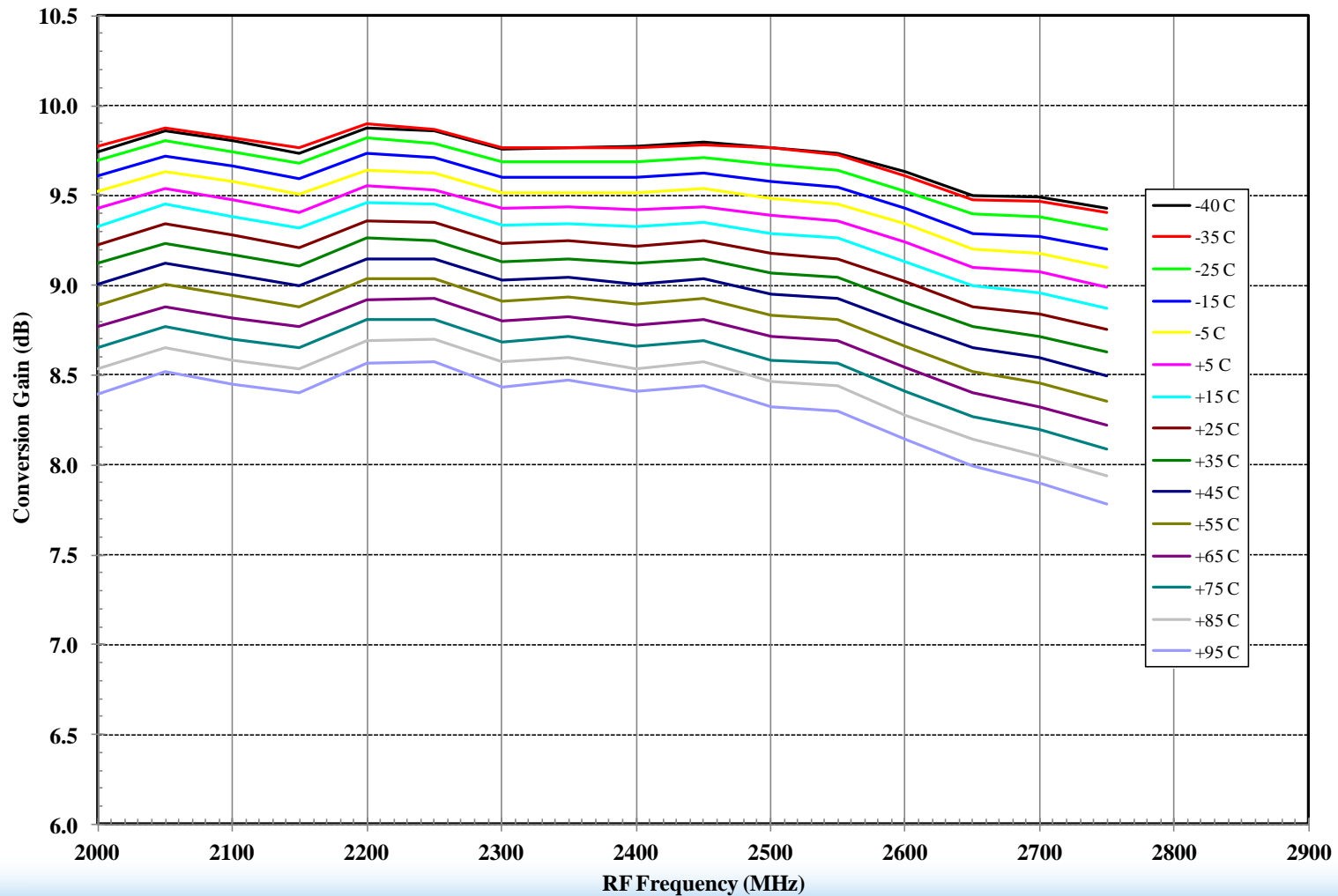

Conversion Gain- Low Side LO, IF = 200 MHz

F1162 Standard Mode Gain
Low Side LO Injection (LO < RF), IF = RF - LO = 200 MHz

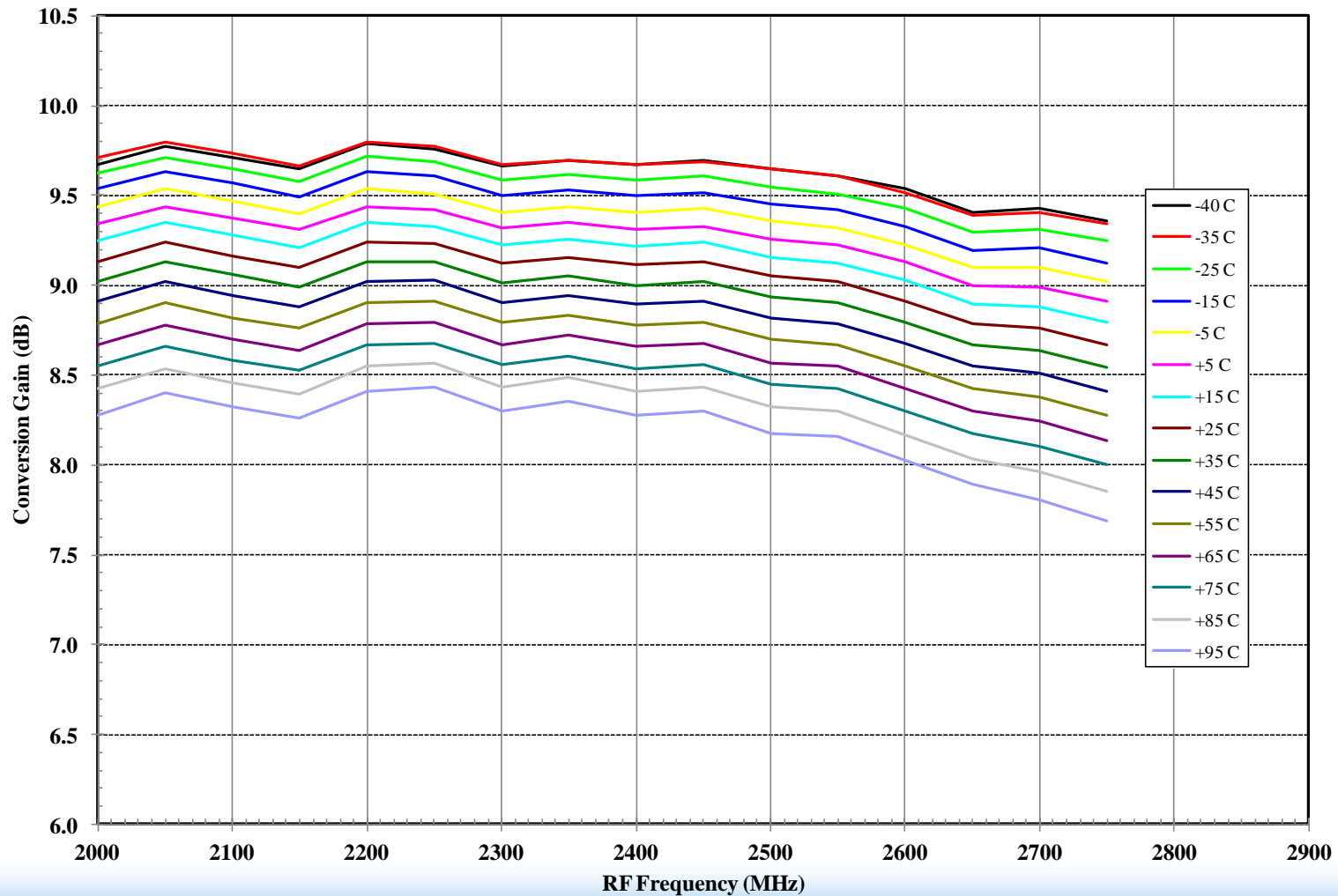

Conversion Gain- Low Side LO, IF = 250 MHz

F1162 Standard Mode Gain
Low Side LO Injection (LO < RF), IF = RF - LO = 250 MHz

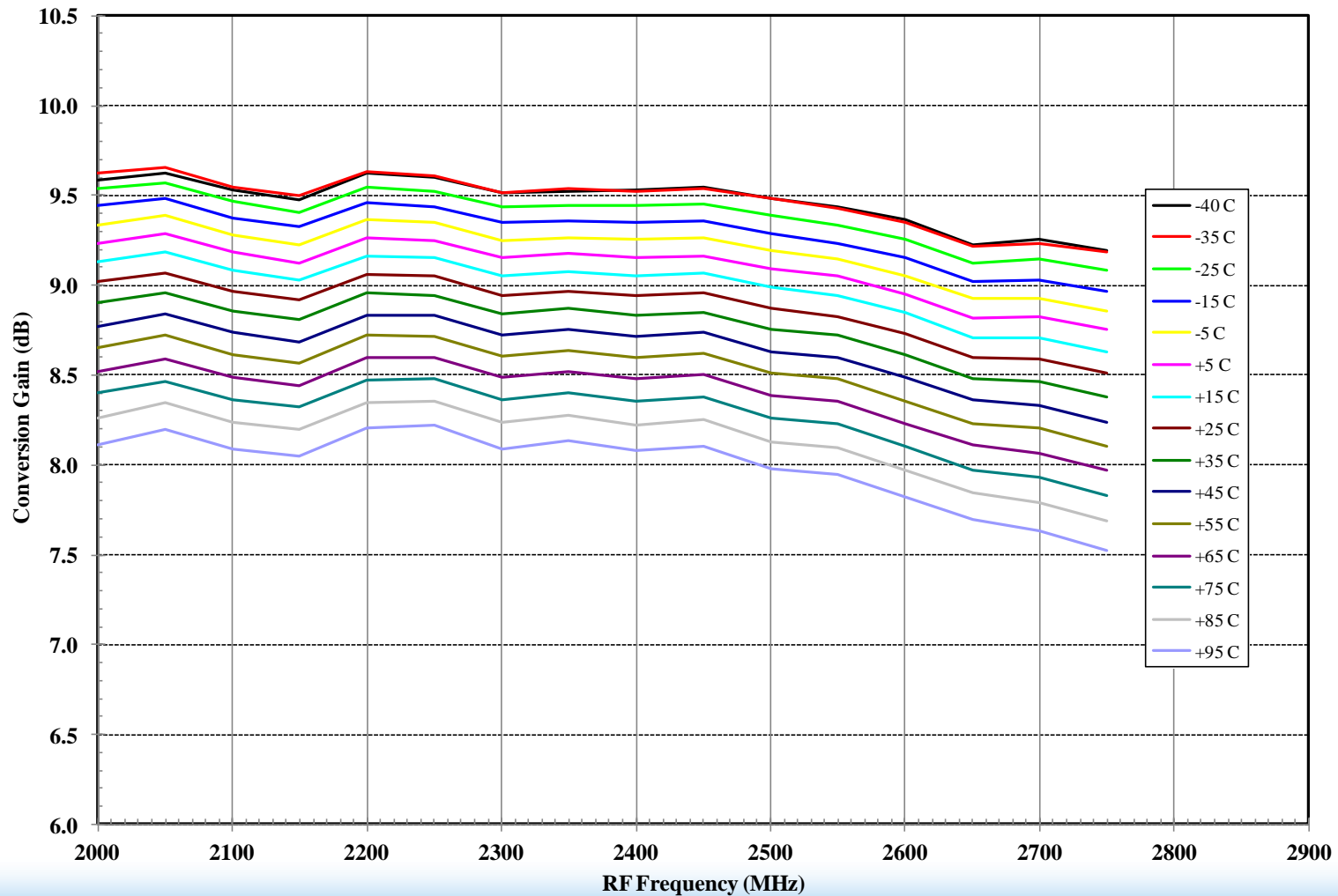

Conversion Gain- High Side LO, IF = 50 MHz

F1162 Standard Mode Gain
High Side LO Injection (LO > RF), IF = LO - RF = 50 MHz

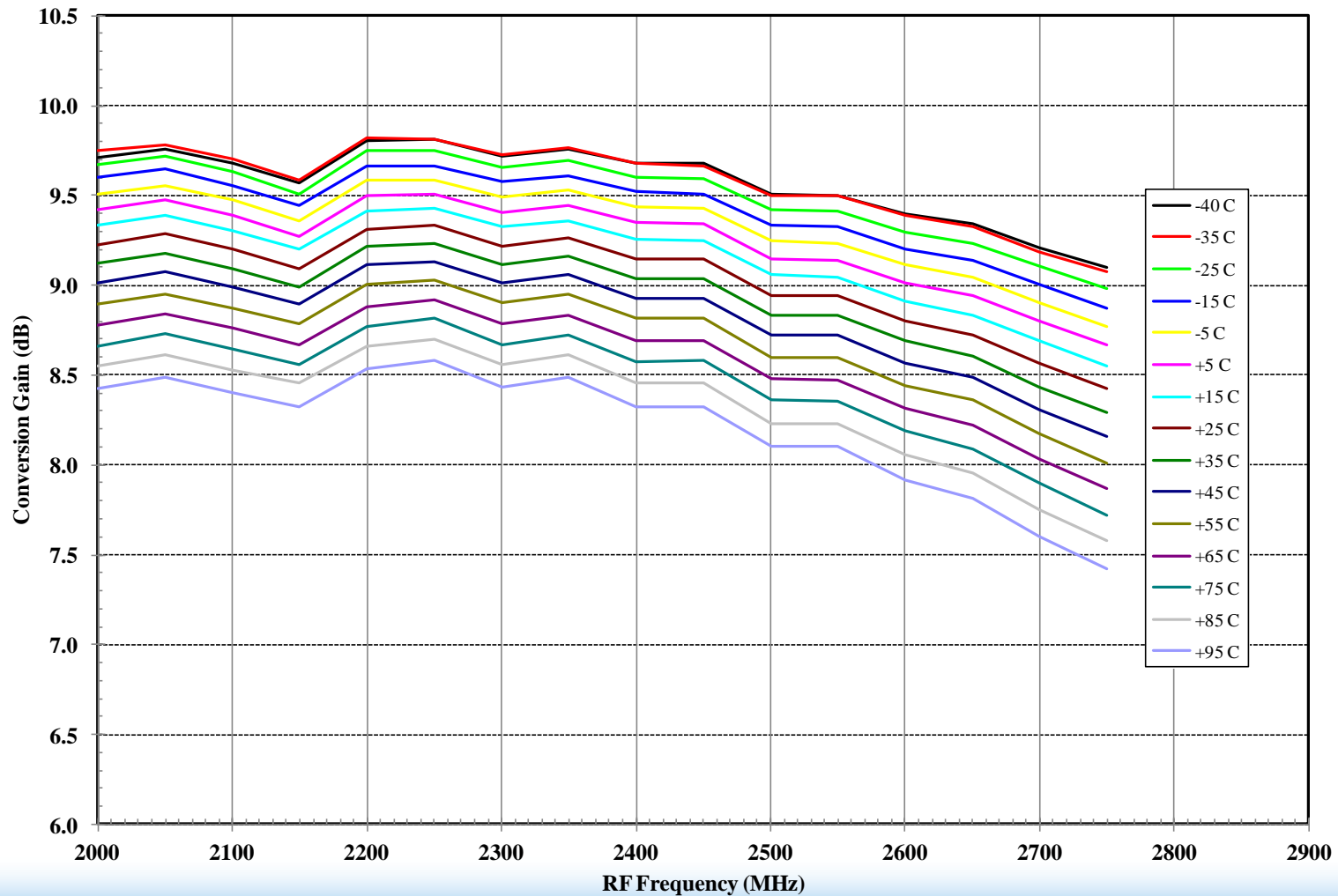

Conversion Gain- High Side LO, IF = 100 MHz

F1162 Standard Mode Gain
High Side LO Injection (LO > RF), IF = LO - RF = 100 MHz

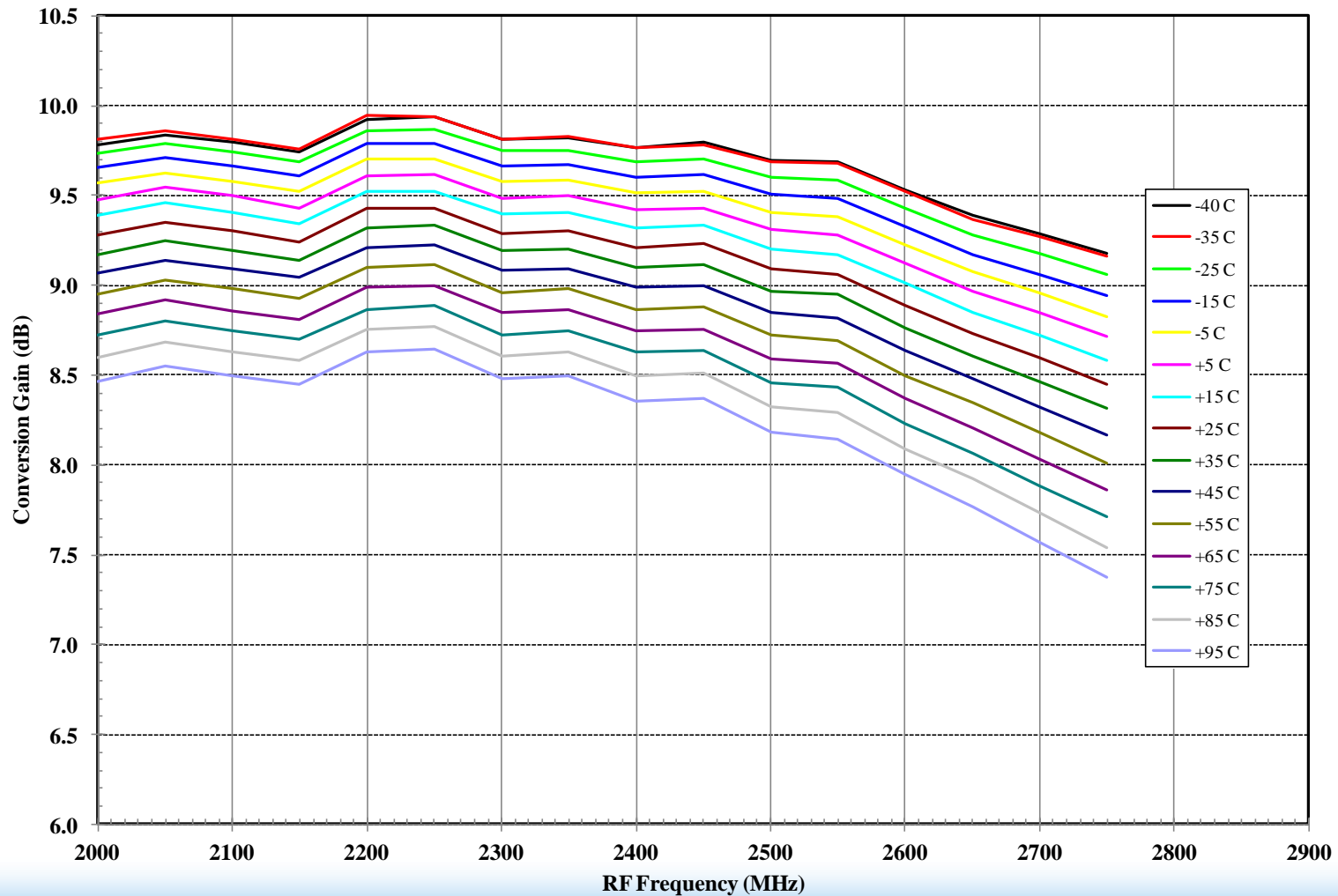

Conversion Gain- High Side LO, IF = 150 MHz

F1162 Standard Mode Gain
High Side LO Injection (LO > RF), IF = LO - RF = 150 MHz

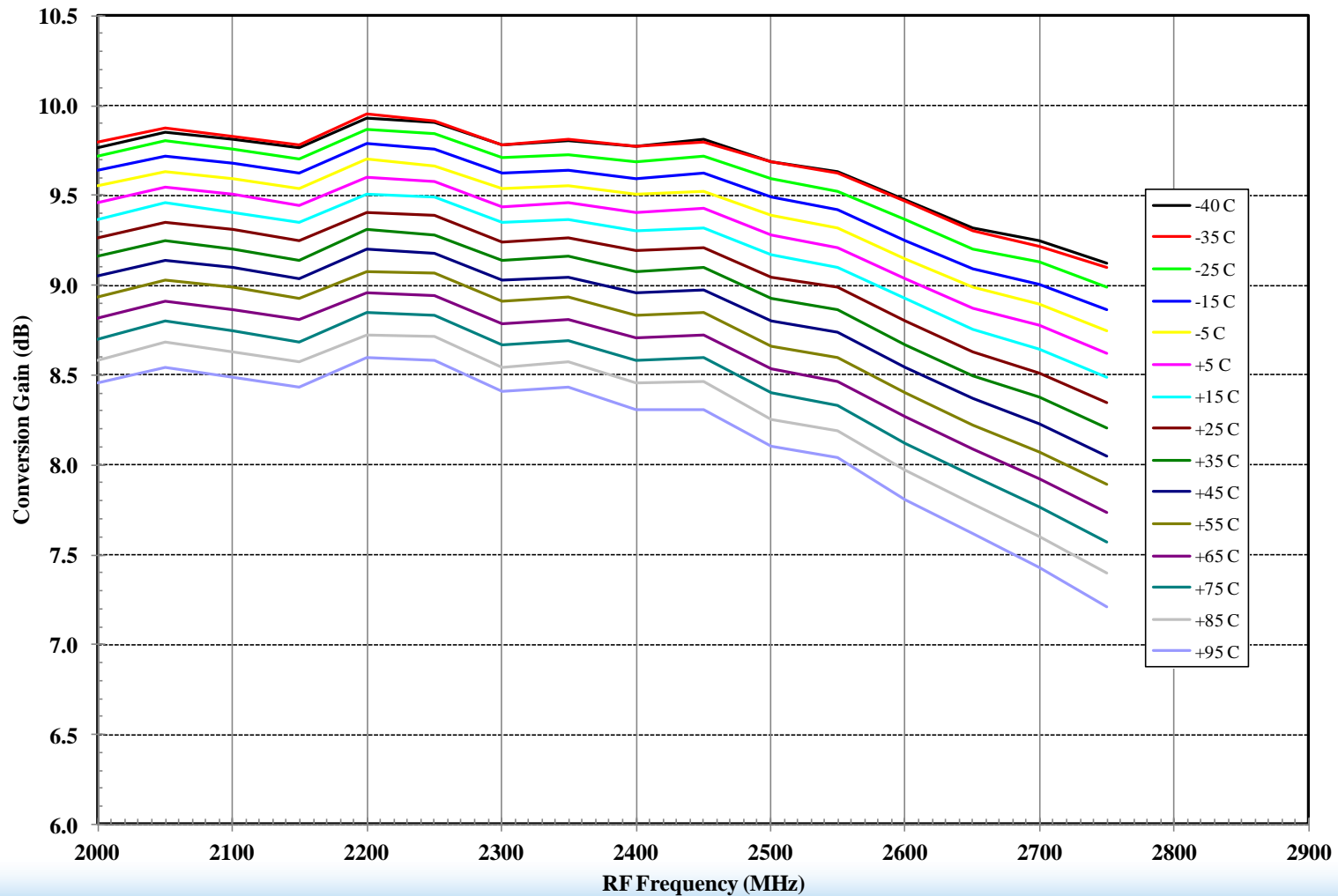

Conversion Gain- High Side LO, IF = 200 MHz

F1162 Standard Mode Gain
High Side LO Injection (LO > RF), IF = LO - RF = 200 MHz

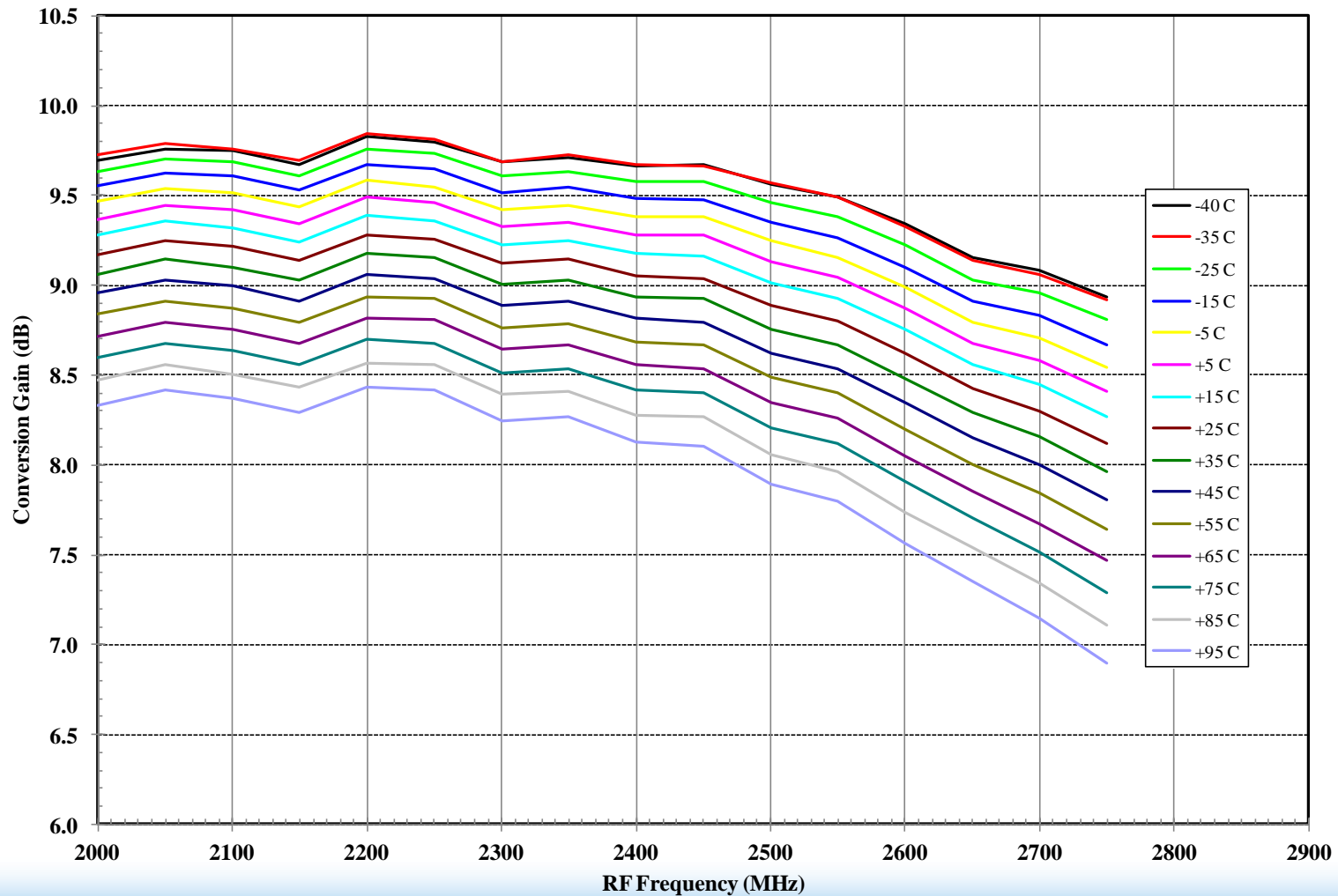

Conversion Gain- High Side LO, IF = 250 MHz

F1162 Standard Mode Gain
High Side LO Injection (LO > RF), IF = LO - RF = 250 MHz

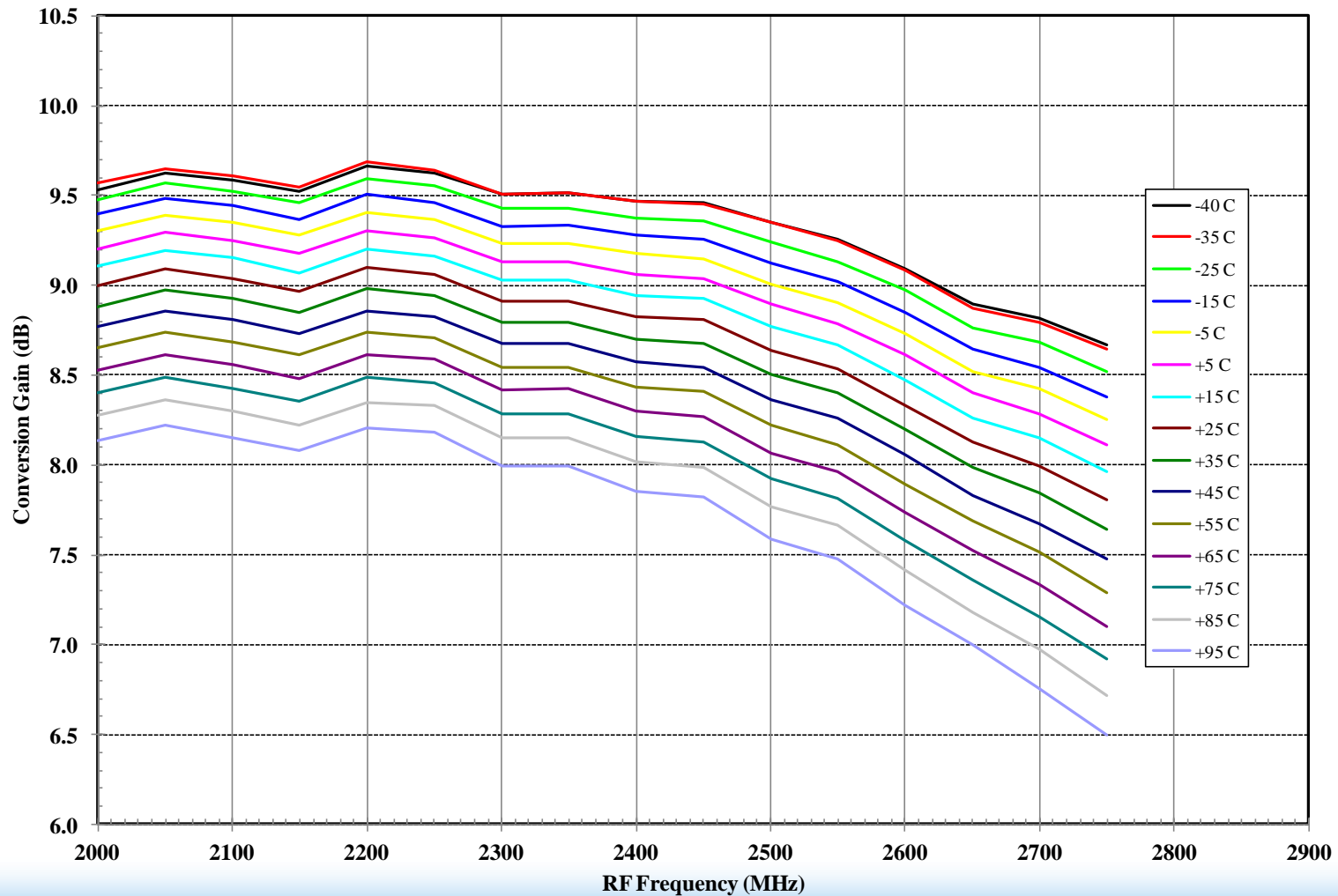

Conclusion

- Gain Testing of the F1162 dual downconverting mixer over the entire RF and IF frequency bands show that the gain is monotonic over temperature.
- For this test the gain below $-35\text{ }^{\circ}\text{C}$ looks seems to flatten out.
- Data is consistent with the datasheet.
- ***No evidence of lower gain at cold temperature.***