

Application Note

Selecting Input and Output Capacitors with GreenFET Load Switches

AN-CM-251

Abstract

This application note is devoted to the topic of selecting proper capacitors to use with GreenFET Load Switches. Important considerations include desired electrical performance, system transient requirements, load parameters, and voltage deviation specifications.

Selecting Input and Output Capacitors with GreenFET Load Switches

Contents

Abstract	1
Contents	2
Figures.....	2
1 Terms and Definitions.....	3
2 References	3
3 Introduction.....	4
4 Capacitor Parasitic Effects.....	4
5 How to Select Capacitors	5
6 Conclusions	13

Figures

Figure 1. Capacitor Equivalent Circuit.....	4
Figure 2. A Typical Power Up Behavior of a SLG59M1714V.....	5
Figure 3. Powering Up a Load Switch with Fast V_{DD} and V_{IN} Rise Times.....	6
Figure 4. Powering Up a Load Switch when V_{DD} and V_{IN} are Applied Simultaneously.....	6
Figure 5. Powering Up a Load Switch when V_{IN} is Applied Before V_{DD}	7
Figure 6. A Load Switch Powering Up a 1 μ F Load Capacitor with Fast V_{DD} and V_{IN} rise Times.....	7
Figure 7. The GreenFET Load Switch Powering Up a 1 μ F Load Capacitor when V_{DD} and V_{IN} are Applied Simultaneously.	8
Figure 8. The GreenFET Load Switch Powering Up a 1 μ F Load Capacitor when V_{IN} is Applied Before V_{DD}	8
Figure 9. A Fast, Nanopower Load Switch Powering Up a 10 μ F Load Capacitor.	9
Figure 10. A Fast, Nanopower Load Switch Powering Up a 10 μ F Load Capacitor with a 1000 μ F Aluminum Electrolytic Capacitor at V_{IN} (C_{IN}).	10
Figure 11. A Fast, Nanopower Load Switch Powering up a 10 μ F Load Capacitor with a 270 μ F Low ESR/ESL Aluminum Polymer Input Capacitor at V_{IN} (C_{IN}).	10
Figure 12. The Parasitic Inductance of 1.2-m Length AWG13 Wires from Power Supply Causes Voltage Spikes at V_{IN} during Active Current Limit Operation.	11
Figure 13. Shorter, 0.2-m Length of AWG13 Wires from Power Supply Do Not Cause Voltage Spikes at V_{IN} during Active Current Limit Operation.....	12
Figure 14. Adding 470 μ F Low ESR/ESL Aluminum Polymer Capacitor at V_{IN} Eliminates Voltage Spikes Caused by the Parasitic Inductance of the 1.2-m Length AWG13 Wires from Power Supply during Active Current Limit Operation.	12

Selecting Input and Output Capacitors with GreenFET Load Switches

1 Terms and Definitions

ACL	Active Current Limit
ESL	Equivalent Series Inductance
ESR	Equivalent Series Resistance
SCL	Short-circuit Current Limit

2 References

- [1] SLG59M1714V, Datasheet, Renesas Electronics
- [2] AN-1207, Load Switch Considerations for Inductive Loads, Renesas Electronics
- [3] AN-1068, GreenFET and High Voltage GreenFET Load Switch Basics, Renesas Electronics
- [4] AN-CM-246 Using [GreenFET](#) Load Switches in Super Capacitor Applications

Author: Andrii Hrypa and Petro Zeykan

Selecting Input and Output Capacitors with GreenFET Load Switches

3 Introduction

Capacitors are used in almost all electronic products in a variety of ways. Capacitors provide a number of essential functions in circuit design, such as providing flexible filter options, noise reduction, power storage, and sensing capabilities. To effectively use capacitors in load switch designs, some key details need to be taken into account. Desired electrical performance, system transient requirements, load parameters, and voltage deviation are very important to consider when selecting proper input and output capacitors in a given application.

Renesas Electronics offers a wide range of GreenFET Load Switches for a variety of applications. For more information, please visit <https://www.dialog-semiconductor.com/products/load-switches>.

4 Capacitor Parasitic Effects

While an ideal capacitor is capable of transferring all its stored energy to a load instantaneously, a real capacitor has parasitic components that prevent this behavior. An equivalent circuit model of a real capacitor is illustrated in Figure 1. As shown, the capacitor equivalent circuit comprises four elements: capacitance, an equivalent series inductance (ESL), a high-resistance DC path (R_p) in parallel with the capacitance, and an equivalent series resistance (ESR).

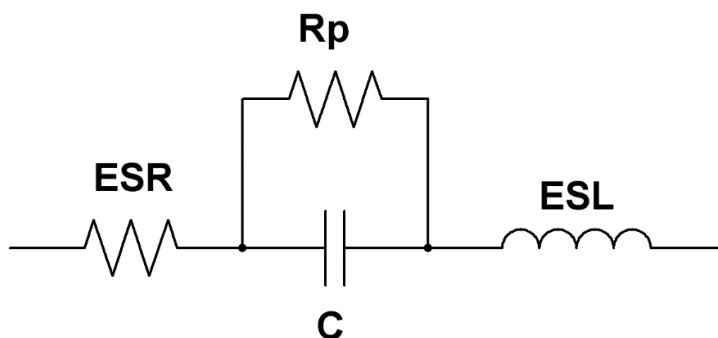

Figure 1. Capacitor Equivalent Circuit

The electrodes and the leads of a capacitor contribute the resistive and inductive components while its dielectric material and its construction contribute to the insulation resistance.

High ESR degrades performance due to I^2R losses, noise, and larger voltage drop. On the other hand, ESL causes a magnetic field to buildup in capacitor. The buildup of magnetic field interferes with how current peaks and recovers. Both ESR and ESL depend on the type of capacitor and its construction.

Wet aluminum electrolytic capacitors are used primarily for bulk decoupling applications. However, their relatively high ESR and ESL slow response times and reduce performance.

Aluminum polymer capacitors have better performance characteristics, and they are increasingly replacing wet aluminum capacitors in bulk decoupling applications. Aluminum polymer capacitors exhibit much lower parasitic ESR and ESL.

Tantalum capacitors are a subclass of electrolytic capacitors. They are made of tantalum metal which acts as an anode, covered by a layer of oxide which acts as the dielectric, then surrounded by a conductive cathode. Tantalum capacitors have an equivalent series resistance (ESR) ten times smaller than the ESR of aluminum electrolytic capacitors, which allows for larger currents to pass through with less heat generated and, in addition, smaller, parasitic IR voltage drops. Tantalum

Selecting Input and Output Capacitors with GreenFET Load Switches

capacitors are very stable over time and their capacitance doesn't change with age significantly, especially when compared to aluminum electrolytic capacitors.

Ceramic capacitors are most commonly used in electronic circuits for decoupling applications. They have relatively low equivalent series resistance, but their ESL is greatly determined by the distance between terminations (its construction).

If PCB space is not an issue, capacitors can be connected in parallel to reduce both ESR and ESL while beneficially increasing the effective capacitance.

5 How to Select Capacitors

In a general sense, GreenFET load switches don't require any input or output capacitors. The use of input and output capacitors is determined by the usage scenario (application). Typically, to turn on a Renesas load switch, V_{DD} , V_{IN} , and ON signals are applied. Every GreenFET load switch datasheet contains an information on the proper sequencing of these three signals. In short V_{DD} should be applied first, then V_{IN} , and finally the ON signal can be toggled low-to-high (for asserted-HIGH ON signals or high-to-low for asserted-LOW ON signals) to close the switch. Also, it is recommended that V_{DD} and V_{IN} rise times should be longer than 2 ms. As an example a typical power up operation of SLG59M1714V [1] is illustrated in Figure 2.

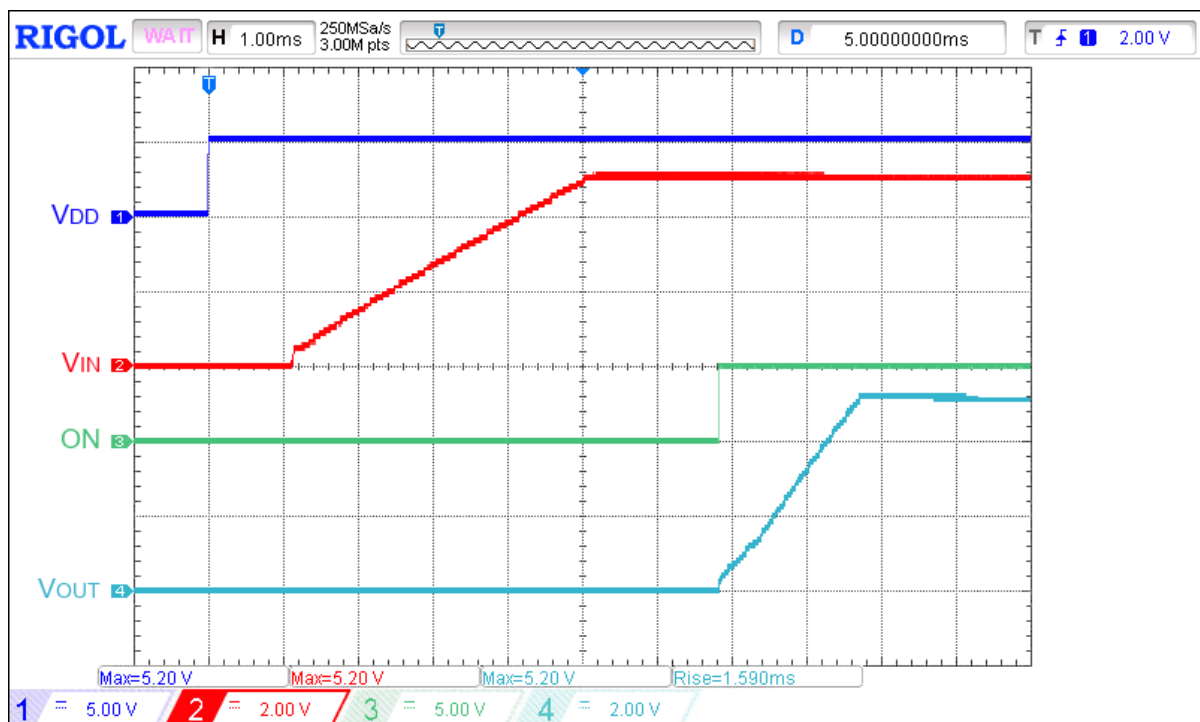

Figure 2. A Typical Power Up Behavior of a SLG59M1714V.

However, there are some applications when V_{DD} and V_{IN} have fast rise times (Figure 3), or when V_{DD} and V_{IN} are applied simultaneously (Figure 4), or when V_{IN} is applied before V_{DD} (Figure 5). In each of these cases, a voltage glitch may appear at the output even when ON = GND (for asserted-HIGH ON signals).

Selecting Input and Output Capacitors with GreenFET Load Switches

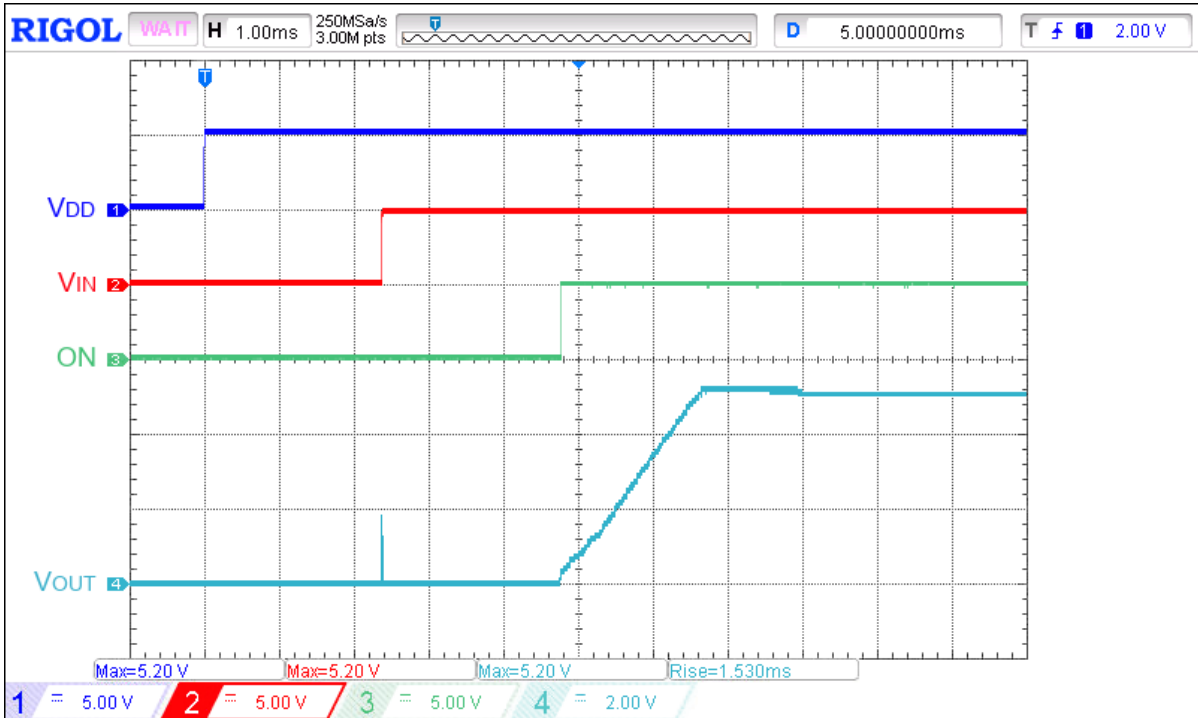

Figure 3. Powering Up a Load Switch with Fast V_{DD} and V_{IN} Rise Times.

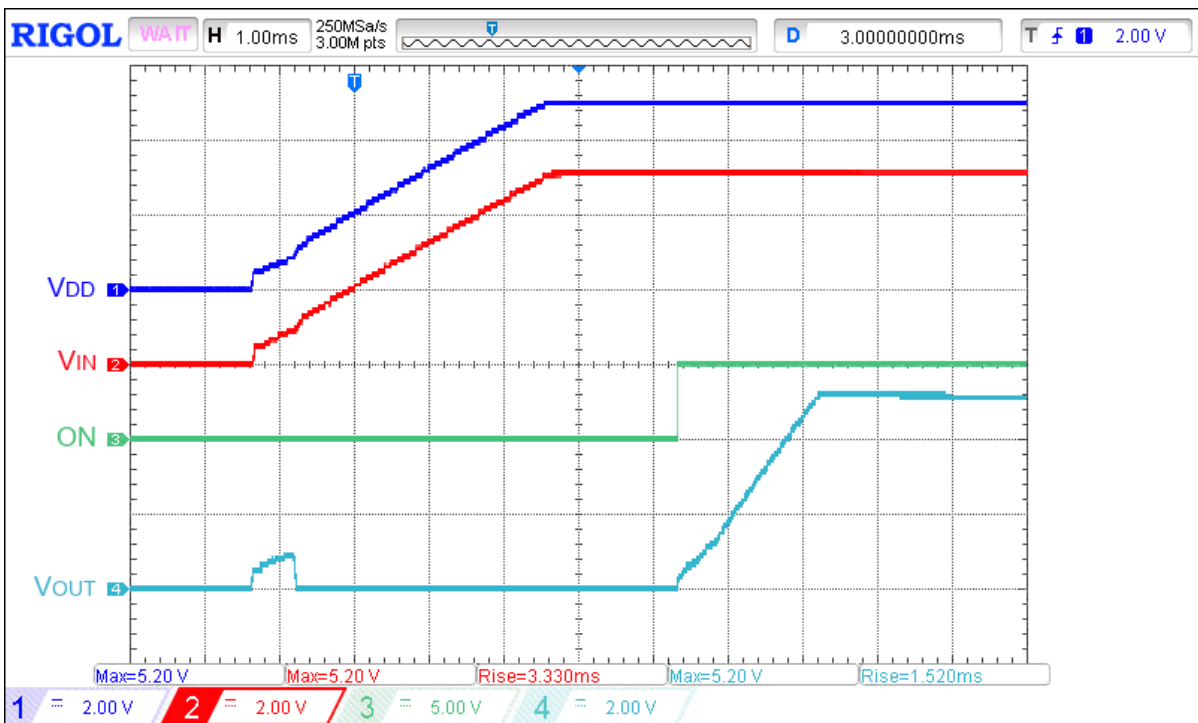

Figure 4. Powering Up a Load Switch when V_{DD} and V_{IN} are Applied Simultaneously.

Selecting Input and Output Capacitors with GreenFET Load Switches

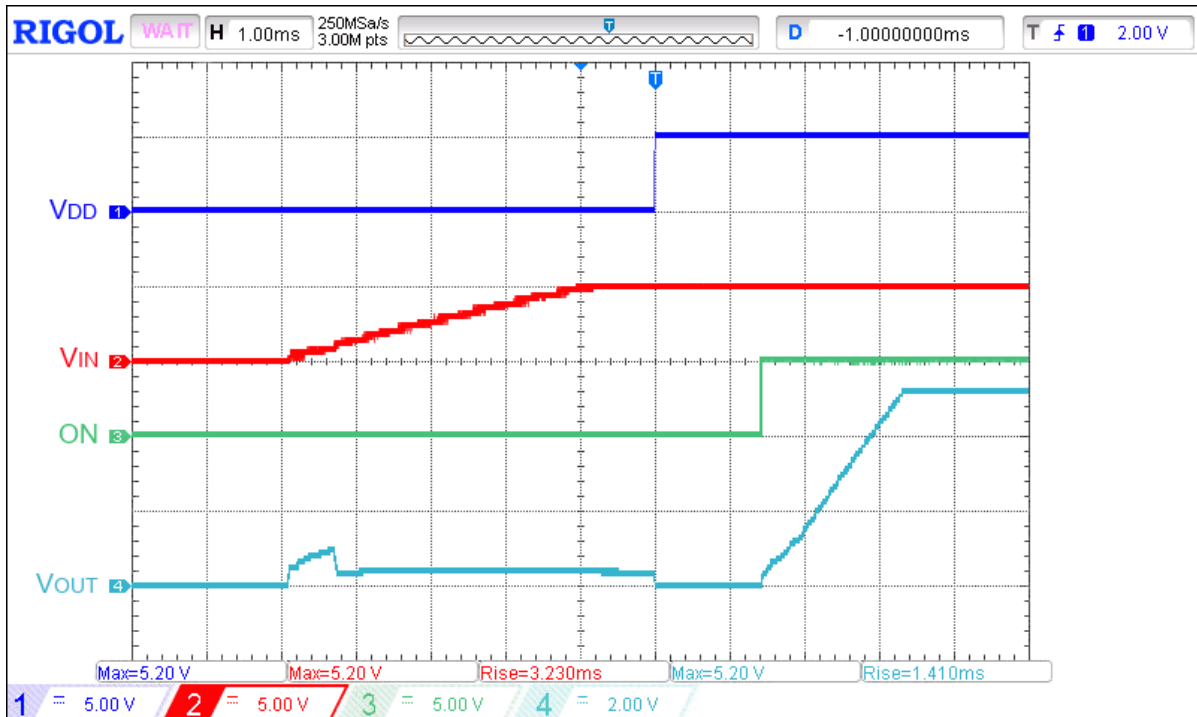

Figure 5. Powering Up a Load Switch when V_{IN} is Applied Before V_{DD} .

To avoid such glitches, an output capacitor (C_{LOAD}) or a resistor (R_{LOAD}) should be added at the downstream side of the GreenFET load switch. In this particular case, a $1\mu F$ ceramic capacitor at VOUT helps to get rid of that glitch (Please see Figure 6, Figure 7, and Figure 8, inclusive).

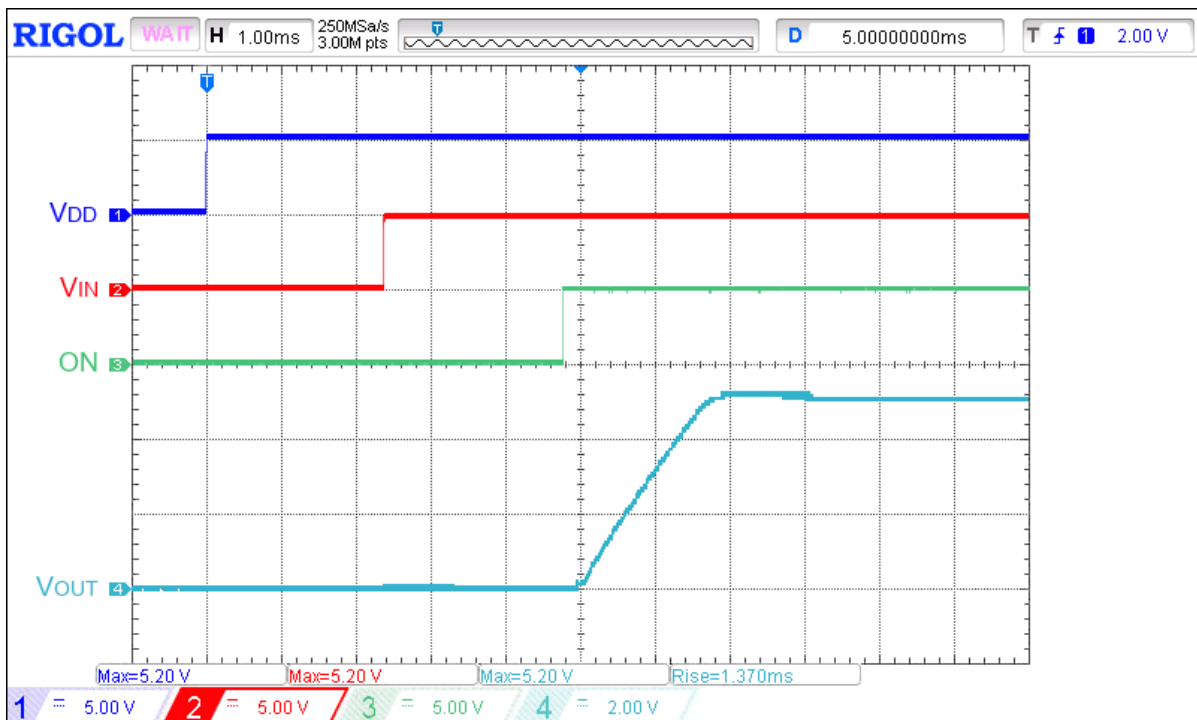

Figure 6. A Load Switch Powering Up a $1\mu F$ Load Capacitor with Fast V_{DD} and V_{IN} rise Times.

Selecting Input and Output Capacitors with GreenFET Load Switches

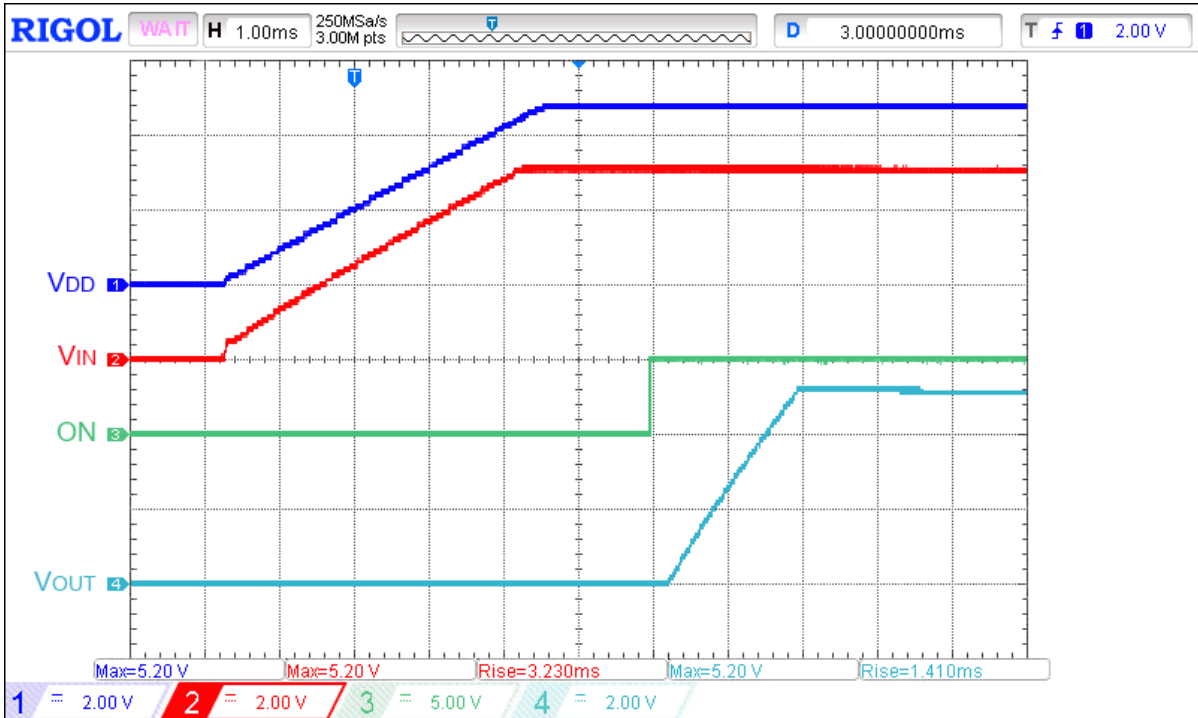

Figure 7. The GreenFET Load Switch Powering Up a 1 μ F Load Capacitor when V_{DD} and V_{IN} are Applied Simultaneously.

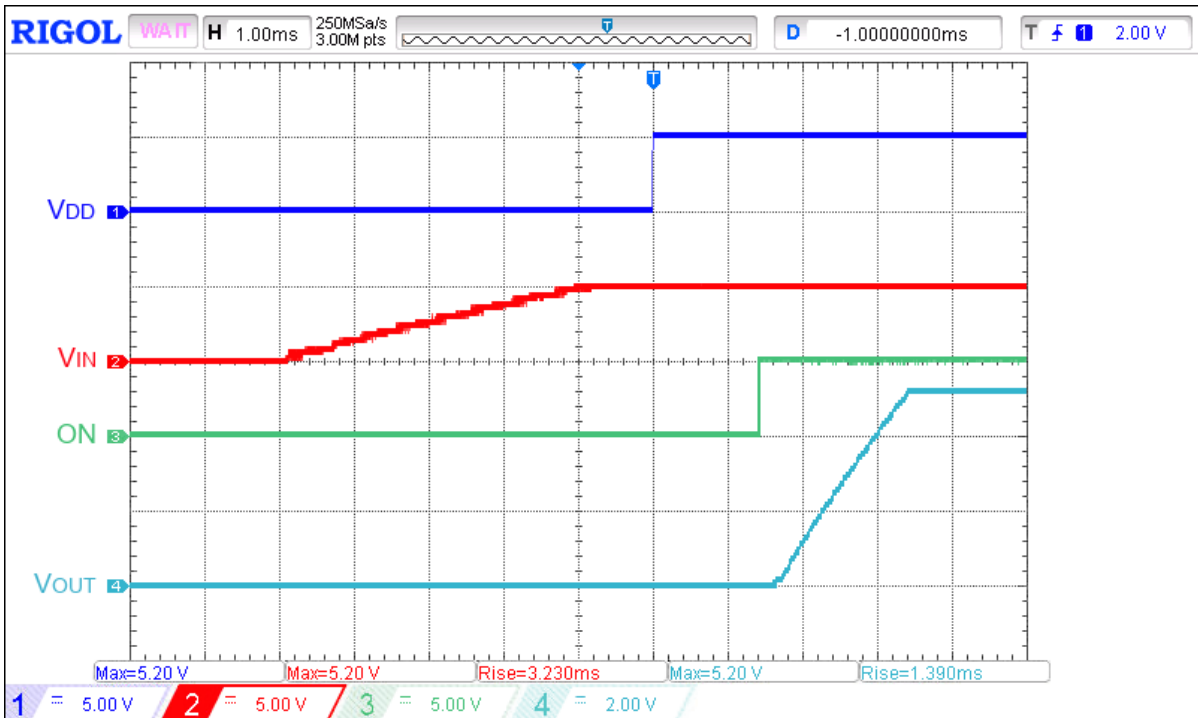

Figure 8. The GreenFET Load Switch Powering Up a 1 μ F Load Capacitor when V_{IN} is Applied Before V_{DD} .

Selecting Input and Output Capacitors with GreenFET Load Switches

In fast turn-on applications into a capacitive load, some unwanted effects may be observed. One such effect is illustrated in Figure 9, where a Nanopower GreenFET load switch powers up a 10 μF load capacitor.

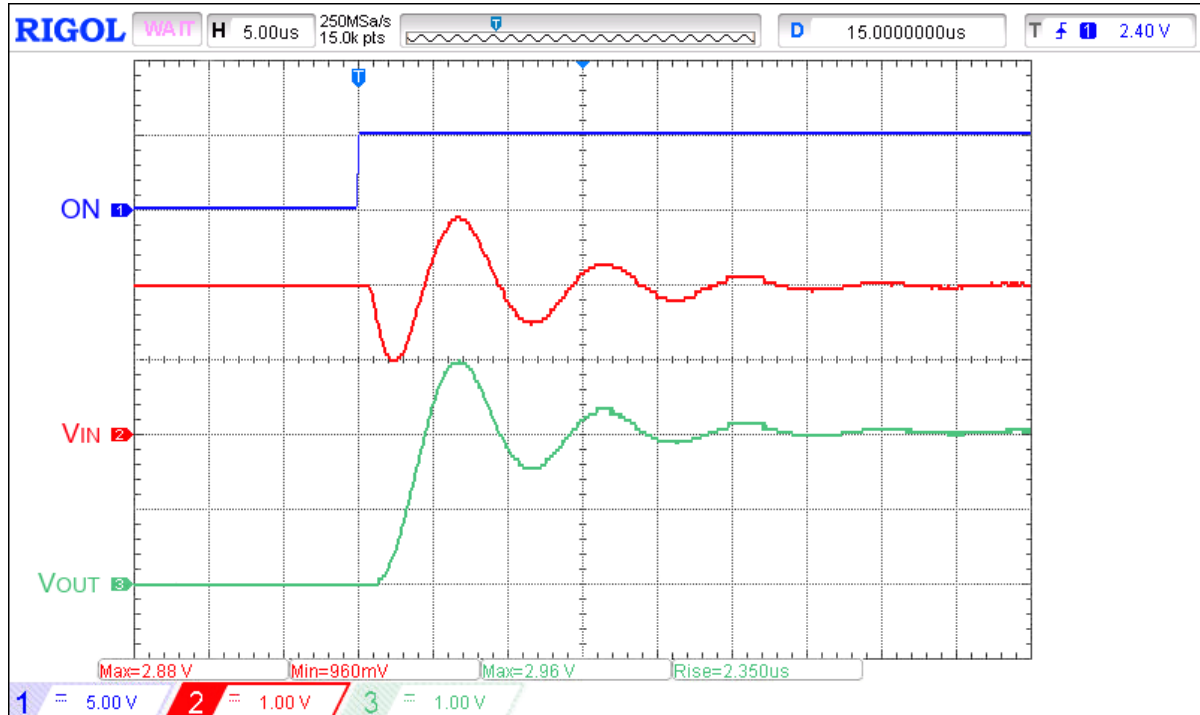

Figure 9. A Fast, Nanopower Load Switch Powering Up a 10 μF Load Capacitor.

This behavior is related to a big inrush current [2], caused by applying a voltage through a load switch across a discharged (or an uncharged) capacitor. The resulting inrush current can be calculated by equation below:

$$\text{Inrush Current, } I = C \frac{dV}{dt},$$

where

C - is the total load capacitance;

$\frac{dV}{dt}$ - the GreenFET load switch's V_{OUT} slew rate during voltage ramp up.

This inrush current leads to the voltage drop at V_{IN} during a load switch power up. Also, this current builds a magnetic field in the parasitic inductance caused by wires from the power supply. When the voltage drop occurs, the magnetic field changes in strength and collapses. This leads to voltage spikes that appear at V_{IN} and, respectively, at V_{OUT} . These voltage spikes can be much larger than the initial V_{IN} voltage level and can greatly shorten the load switch's long-term reliability [2] or even damage it and any other circuit downstream of it.

One way to minimize this effect is to reduce inrush current for a given load capacitance by decreasing (or slowing down) the GreenFET load switch's V_{OUT} slew rate. This can be achieved by using load switches with controlled slew rate [3], [3]. However, this method also leads to increasing total circuit turn-on time.

Another way is to add an input capacitor at V_{IN} to minimize the voltage drop during fast power-up events. Figure 10 shows a turn-on operation for a 10 μF load capacitor with a 1000 μF aluminum electrolytic capacitor at V_{IN} . As shown, the voltage drop is much smaller, but it is still present due to ESR and ESL parasitic elements in capacitors described earlier. In the case of using a capacitor with

Selecting Input and Output Capacitors with GreenFET Load Switches

smaller ESR and ESL, it is possible to get the same or even better results with smaller capacitance value. For example, in Figure 11, a low ESR/ESL aluminum polymer capacitor was used to power up a 10 μ F load capacitor.

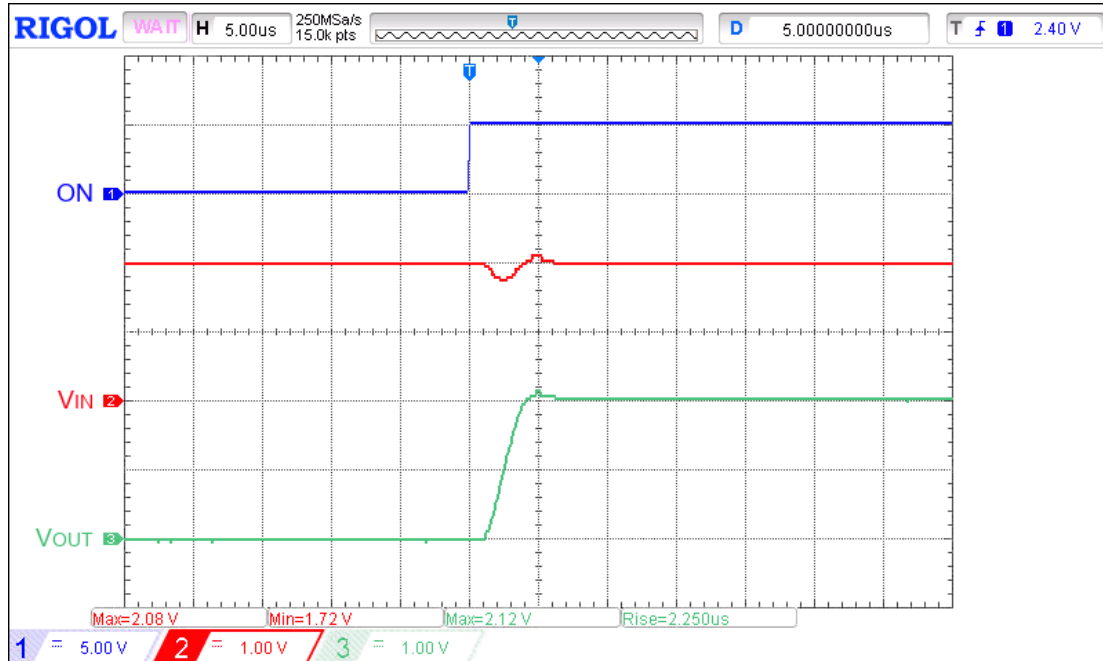

Figure 10. A Fast, Nanopower Load Switch Powering Up a 10 μ F Load Capacitor with a 1000 μ F Aluminum Electrolytic Capacitor at VIN (C_{IN}).

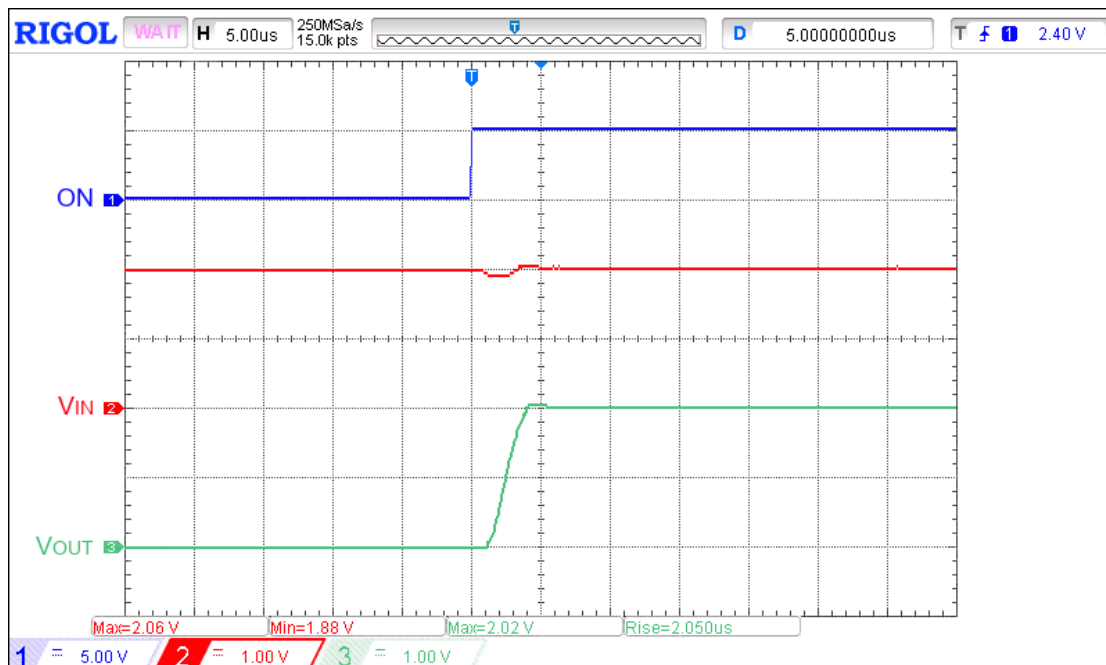

Figure 11. A Fast, Nanopower Load Switch Powering up a 10 μ F Load Capacitor with a 270 μ F Low ESR/ESL Aluminum Polymer Input Capacitor at VIN (C_{IN}).

Selecting Input and Output Capacitors with GreenFET Load Switches

Yet another situation which requires input and output capacitors is when a load switch's active current limit (ACL) or short-circuit protection (SCL) is triggered. During these events, current through the load switch may change in large steps (eg. suddenly shut off) which if long wires (inductance) are present can cause large voltage spikes (Figure 12) that could damage the load switch and even other components powered from the same power rail. To eliminate these voltage spikes, it is necessary to a) use shorter connections from power supply to the device (Figure 13) and/or b) add or increase the corresponding capacitance (Figure 14). Since long wires tend to be more prevalent on the power supply (V_{IN}) side, the examples below show how the voltage spikes in this situation are mitigated.

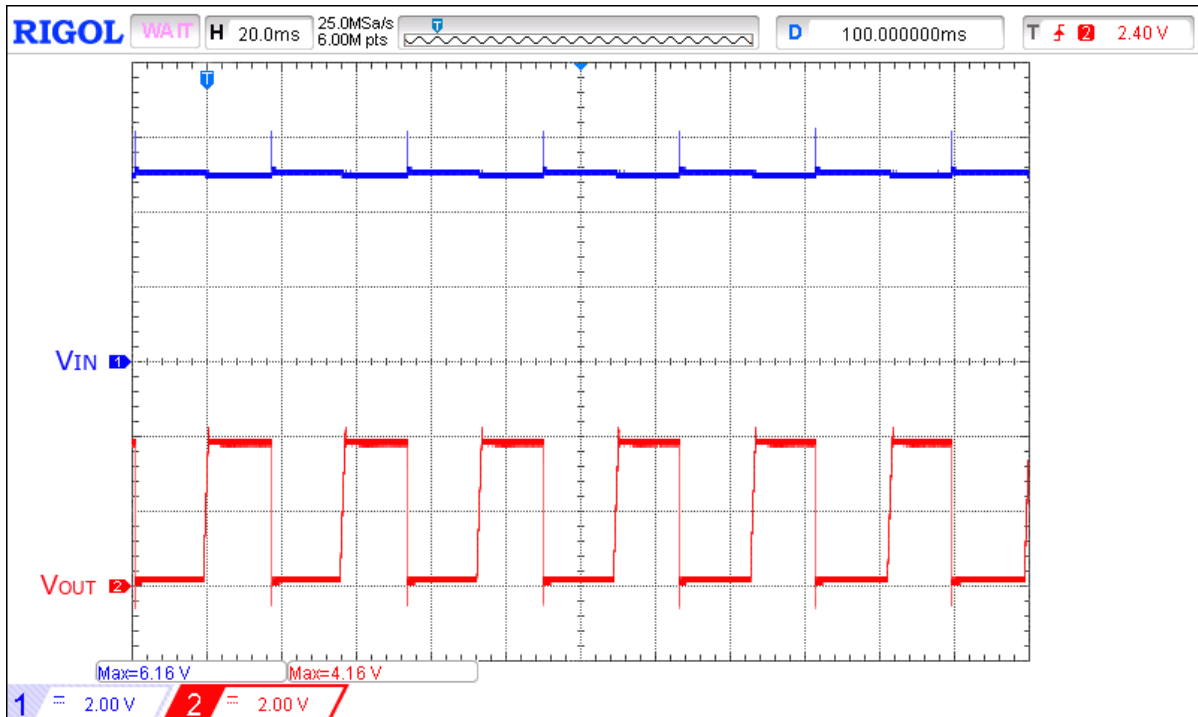

Figure 12. The Parasitic Inductance of 1.2-m Length AWG13 Wires from Power Supply Causes Voltage Spikes at V_{IN} during Active Current Limit Operation.

Selecting Input and Output Capacitors with GreenFET Load Switches

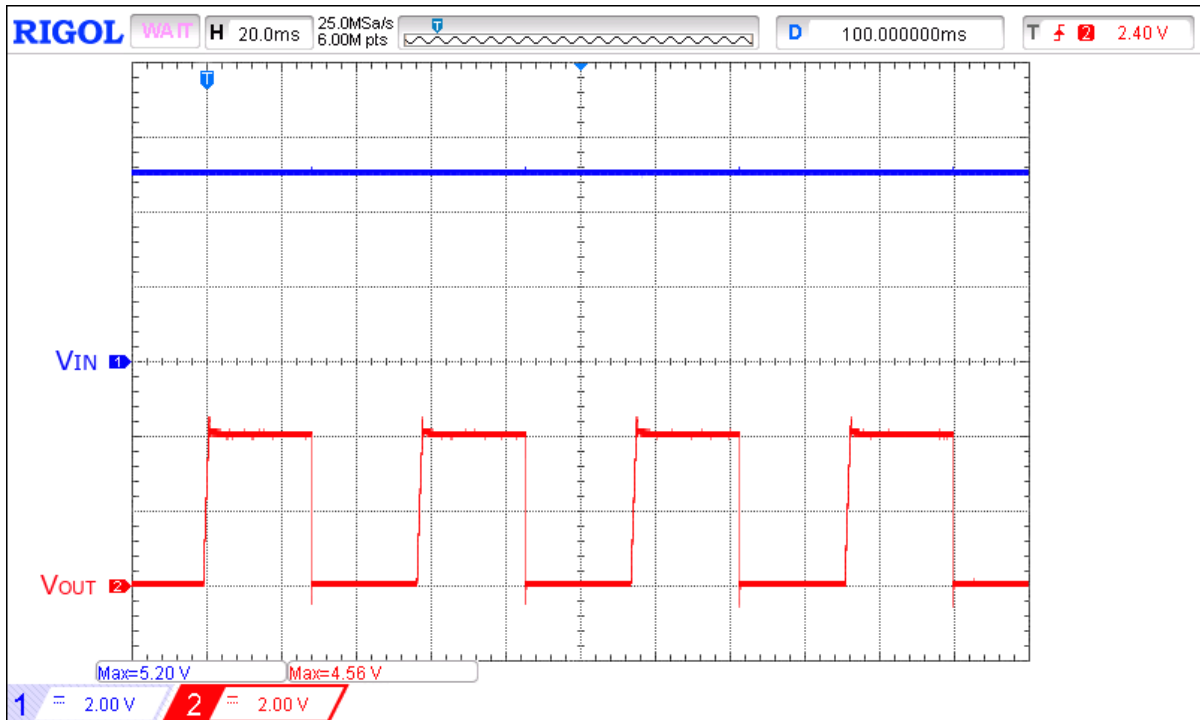

Figure 13. Shorter, 0.2-m Length of AWG13 Wires from Power Supply Do Not Cause Voltage Spikes at V_{IN} during Active Current Limit Operation.

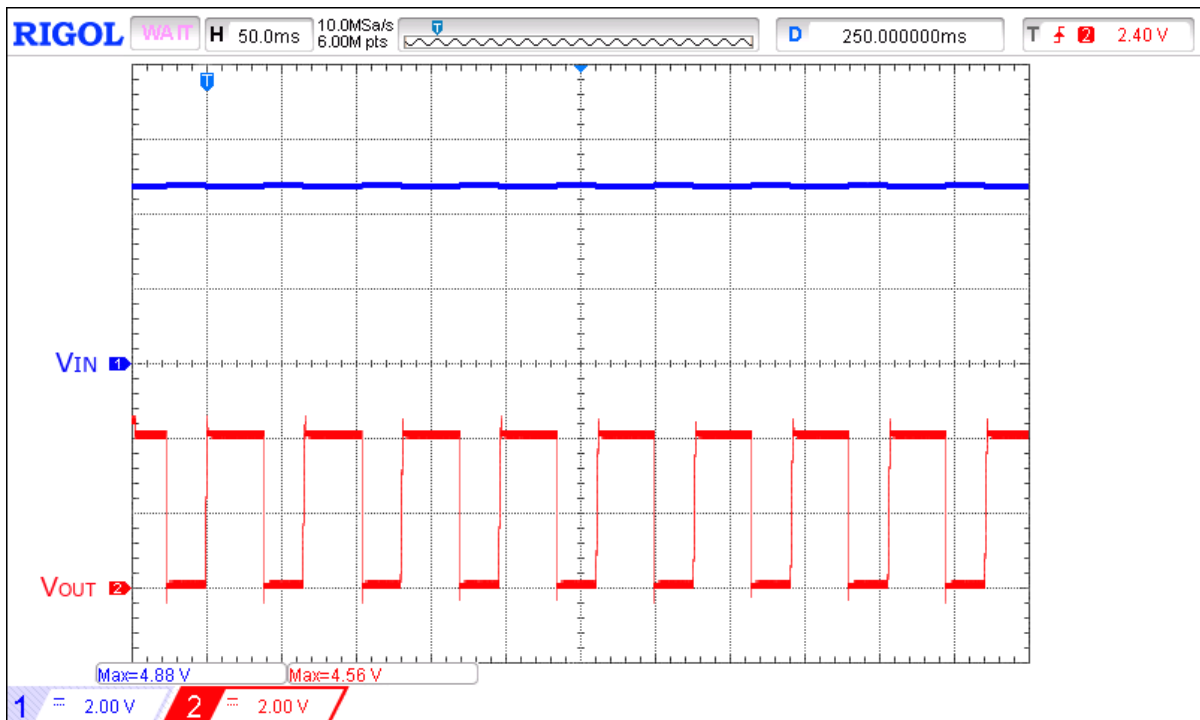

Figure 14. Adding 470 μF Low ESR/ESL Aluminum Polymer Capacitor at V_{IN} Eliminates Voltage Spikes Caused by the Parasitic Inductance of the 1.2-m Length AWG13 Wires from Power Supply during Active Current Limit Operation.

Selecting Input and Output Capacitors with GreenFET Load Switches

6 Conclusions

Capacitors are fundamental components in most digital and analog circuits. GreenFET load switches don't inherently require input and output capacitors. However, application requirements may dictate the use of input and output capacitors. In load switch applications where input and output capacitors are needed, ceramic and/or tantalum capacitors are recommended.

IMPORTANT NOTICE AND DISCLAIMER

RENESAS ELECTRONICS CORPORATION AND ITS SUBSIDIARIES (“RENESAS”) PROVIDES TECHNICAL SPECIFICATIONS AND RELIABILITY DATA (INCLUDING DATASHEETS), DESIGN RESOURCES (INCLUDING REFERENCE DESIGNS), APPLICATION OR OTHER DESIGN ADVICE, WEB TOOLS, SAFETY INFORMATION, AND OTHER RESOURCES “AS IS” AND WITH ALL FAULTS, AND DISCLAIMS ALL WARRANTIES, EXPRESS OR IMPLIED, INCLUDING, WITHOUT LIMITATION, ANY IMPLIED WARRANTIES OF MERCHANTABILITY, FITNESS FOR A PARTICULAR PURPOSE, OR NON-INFRINGEMENT OF THIRD-PARTY INTELLECTUAL PROPERTY RIGHTS.

These resources are intended for developers who are designing with Renesas products. You are solely responsible for (1) selecting the appropriate products for your application, (2) designing, validating, and testing your application, and (3) ensuring your application meets applicable standards, and any other safety, security, or other requirements. These resources are subject to change without notice. Renesas grants you permission to use these resources only to develop an application that uses Renesas products. Other reproduction or use of these resources is strictly prohibited. No license is granted to any other Renesas intellectual property or to any third-party intellectual property. Renesas disclaims responsibility for, and you will fully indemnify Renesas and its representatives against, any claims, damages, costs, losses, or liabilities arising from your use of these resources. Renesas' products are provided only subject to Renesas' Terms and Conditions of Sale or other applicable terms agreed to in writing. No use of any Renesas resources expands or otherwise alters any applicable warranties or warranty disclaimers for these products.

(Disclaimer Rev.1.01 Jan 2024)

Corporate Headquarters

TOYOSU FORESIA, 3-2-24 Toyosu,
Koto-ku, Tokyo 135-0061, Japan
www.renesas.com

Trademarks

Renesas and the Renesas logo are trademarks of Renesas Electronics Corporation. All trademarks and registered trademarks are the property of their respective owners.

Contact Information

For further information on a product, technology, the most up-to-date version of a document, or your nearest sales office, please visit www.renesas.com/contact-us/.