

---

## F2914 Low Frequency Performance

---

This application note provides an overview of the performance of the F2914 at low frequencies from 100kHz up to 10MHz. This document is a guideline for the estimated performance of the F2914 at low frequencies.

### Contents

1. Introduction.....	2
2. Pin Information .....	2
2.1 Pin Assignments.....	2
2.2 Pin Descriptions.....	3
3. Typical Performance Graphs.....	3
4. Summary .....	6
5. Revision History .....	6

# 1. Introduction

The F2914 is a high reliability, low insertion loss, 50Ω SP4T absorptive RF switch designed for a multitude of RF applications including wireless communications. This device covers a broad frequency range from 50MHz to 8000MHz. In addition to providing low insertion loss, the F2914 also delivers excellent linearity and isolation performance while providing a 50Ω termination to the unused RF input ports. The F2914 also includes a patent pending constant impedance (Kz) feature. Kz improves system hot switching ruggedness, minimizes LO pulling in VCOs, and reduces phase and amplitude variations in distribution networks. For more information, see the [F2914 Datasheet](#).

The F2914 was tested from 100kHz to 10MHz in order to evaluate its low frequency performance. The small signal parameters as well as the input compression levels were identified as critical parameters and were studied. The device functionality down to 100kHz is shown in this document which falls outside the primary operating range of the device and therefore some performance degradation is to be expected.

# 2. Pin Information

## 2.1 Pin Assignments

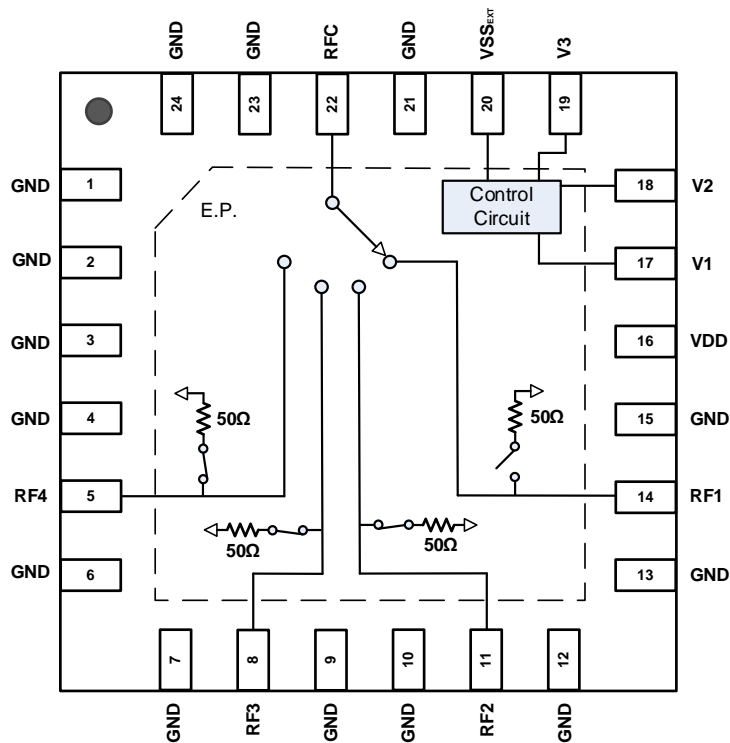

Figure 1. Pin Assignments – Top View

## 2.2 Pin Descriptions

Table 1. Pin Descriptions

Pin	Name	Function
1, 3, 4, 6, 7, 9, 10, 12, 13, 15, 21, 23, 24	GND	Ground these pins as close to the device as possible.
2	GND	This pin is internally connected to the exposed paddle. This pin can be left open or grounded. Note: The EVKIT layout has a floating RF trace connected to this pin to make the board compatible with the F2915.
5	RF4	RF4 Port. Matched to 50Ω. If this pin is not 0V DC, then an external coupling capacitor must be used.
8	RF3	RF3 Port. Matched to 50Ω. If this pin is not 0V DC, then an external coupling capacitor must be used.
11	RF2	RF2 Port. Matched to 50Ω. If this pin is not 0V DC, then an external coupling capacitor must be used.
14	RF1	RF1 Port. Matched to 50Ω. If this pin is not 0V DC, then an external coupling capacitor must be used.
16	VDD	Power Supply. Bypass to GND with capacitors shown in the Typical Application Circuit as close as possible to pin.
17	V1	Control pin to set switch state.
18	V2	Control pin to set switch state.
19	V3	Control pin to set switch state.
20	VSS <sub>EXT</sub>	External VSS negative voltage control. Connect to ground to enable on chip negative voltage generator. To bypass and disable on chip generator connect this pin to an external VSS.
22	RFC	RF Common Port. Matched to 50Ω when one of the 4 RF ports is selected. If this pin is not 0V DC, then an external coupling capacitor must be used.
25	EP	Exposed Pad. Internally connected to GND. Solder this exposed pad to a PCB pad that uses multiple ground vias to provide heat transfer out of the device into the PCB ground planes. These multiple ground vias are also required to achieve the specified RF performance.

## 3. Typical Performance Graphs

The figures shown below highlight the small signal performance as well as the compression points of the F2914 when operated at low frequencies from 100kHz up to 10MHz.

Unless otherwise noted for the TOC graphs on the following pages, the following conditions apply.

- $V_{DD} = 3.3V$
- $T_{CASE} = +25^{\circ}C$  ( $T_{CASE}$  = Temperature of exposed paddle)
- Pin = 5dBm for all small signal tests
- $Z_S = Z_L = 50\Omega$
- All unused RF ports terminated into 50Ω
- For Insertion Loss and Isolation plots, RF trace and connector losses are de-embedded
- Plots for Isolation and Insertion Loss over temperature and voltage are for a typical path

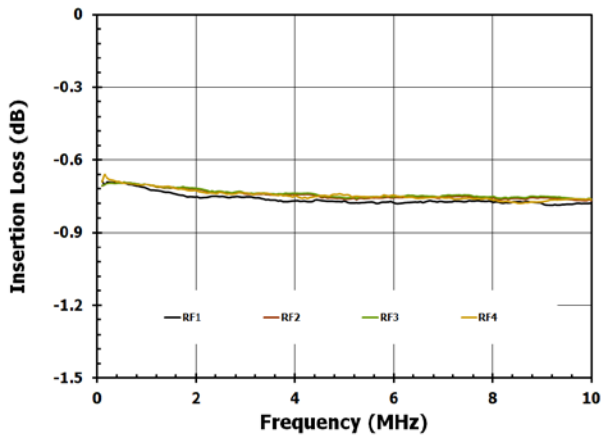

Figure 2. RFX – RFC Insertion Loss

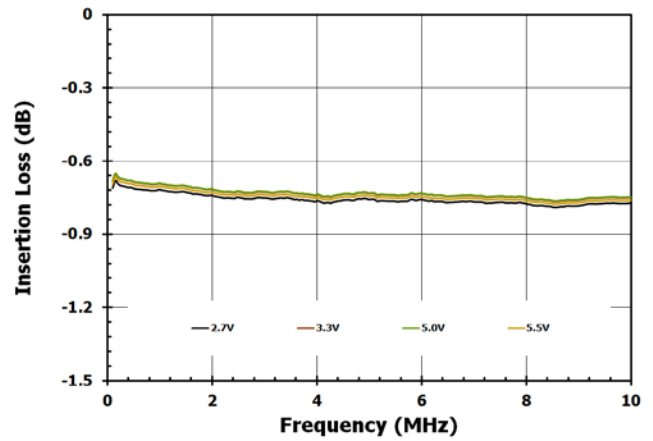

Figure 3. RFX – RFC Insertion Loss Vs. Voltage

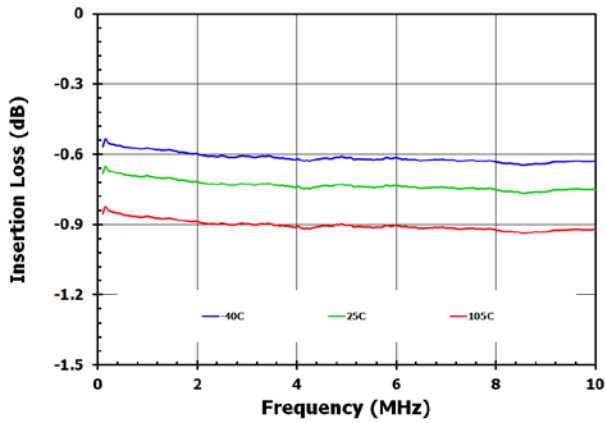

Figure 4. RFX – RFC Insertion Loss Vs. Temperature

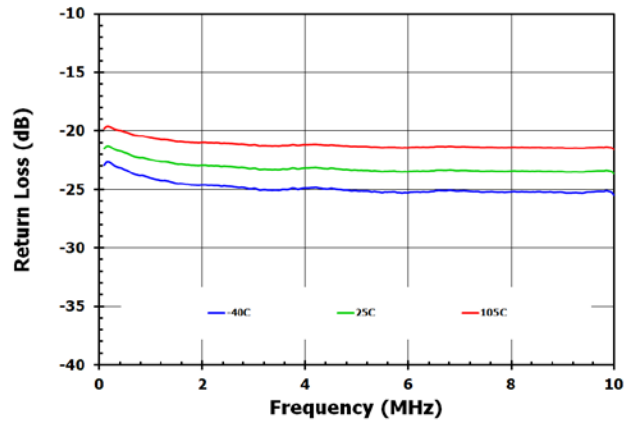

Figure 5. RFX – RFC Return Loss Vs. Temperature

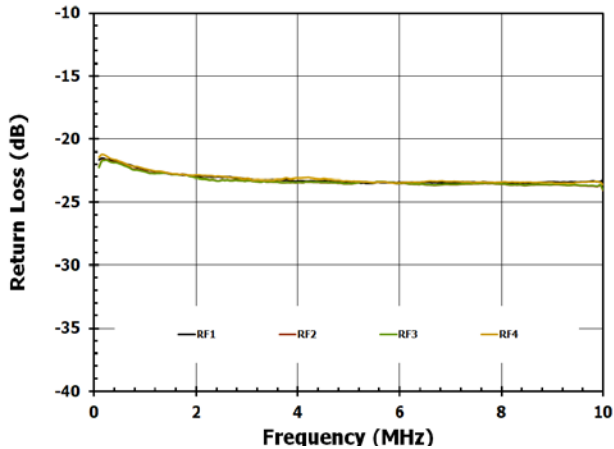

Figure 6. RFX – RFC Return Loss

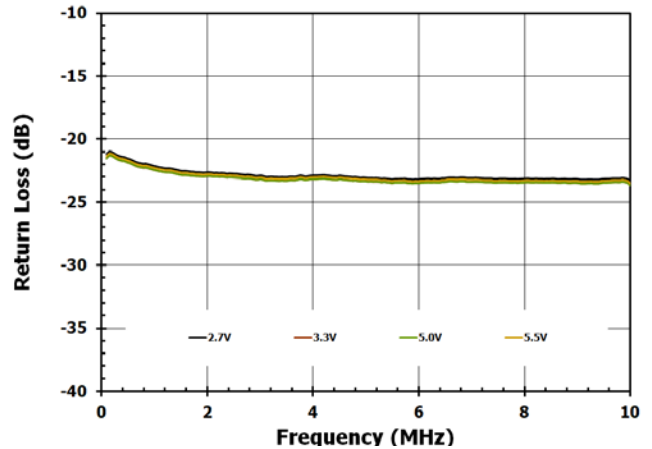

Figure 7. RFX – RFC Return Loss Vs. Voltage

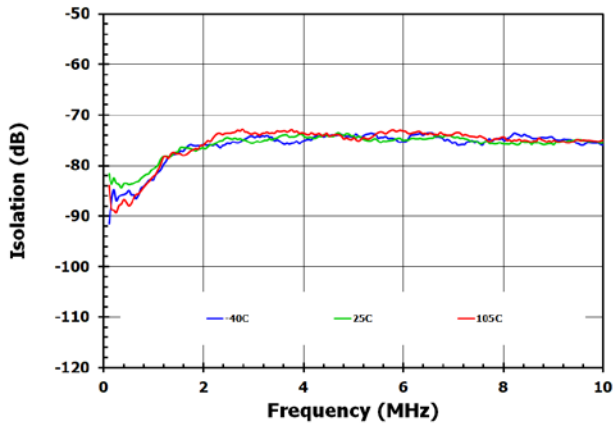

Figure 8. RFX – RFC Isolation Vs. Temperature

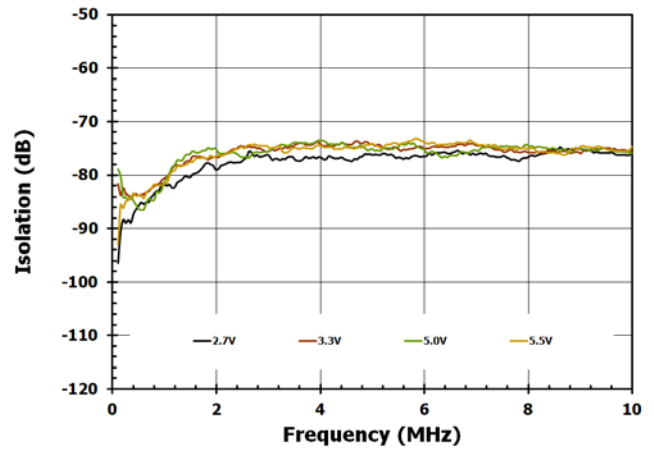

Figure 9. RFX – RFC Isolation Vs. Voltage

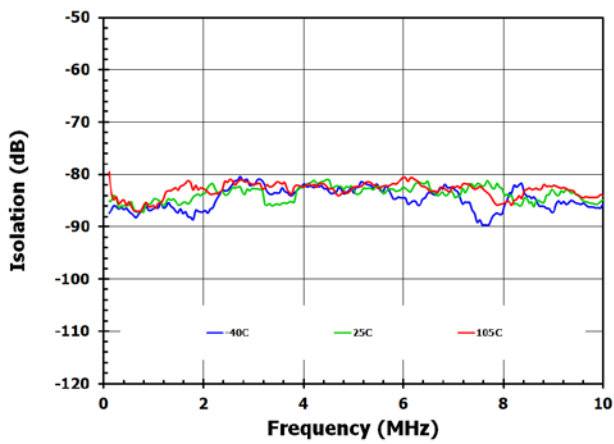

Figure 10. RFX – RFX Isolation Vs. Temperature

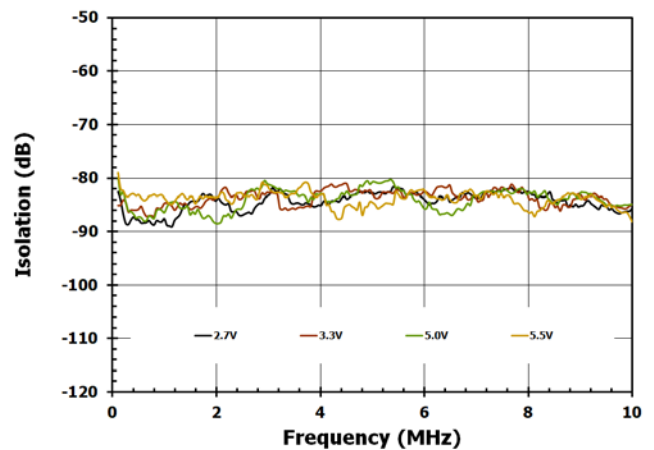

Figure 11. RFX – RFX Isolation Vs. Voltage

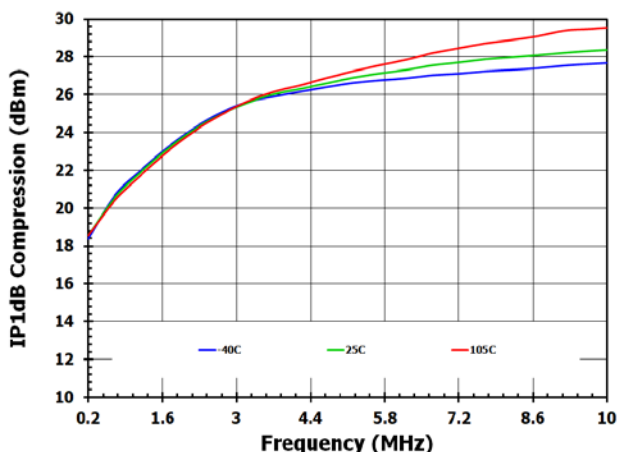

Figure 12. Input 1dB Compression Vs. Temperature

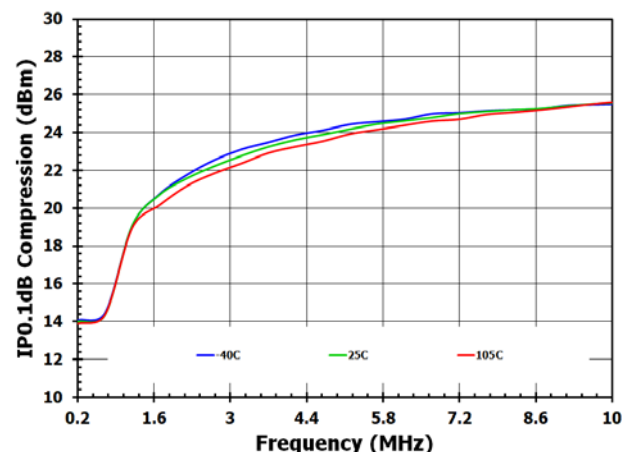

Figure 13. Input 0.1dB Compression Vs. Temperature

## 4. Summary

The F2914 is operable at lower frequencies from 100kHz up to 10MHz with some performance degradation. Input power must be limited to a level below the compression point shown above. Please refer to Figure 1 on the datasheet, which represents the Maximum operating RF input power versus frequency for a better understanding of the recommended input power levels while operating the device at low frequencies.

## 5. Revision History

Revision	Date	Description
1.0	Jun 18, 2021	Initial release.

## IMPORTANT NOTICE AND DISCLAIMER

RENESAS ELECTRONICS CORPORATION AND ITS SUBSIDIARIES (“RENESAS”) PROVIDES TECHNICAL SPECIFICATIONS AND RELIABILITY DATA (INCLUDING DATASHEETS), DESIGN RESOURCES (INCLUDING REFERENCE DESIGNS), APPLICATION OR OTHER DESIGN ADVICE, WEB TOOLS, SAFETY INFORMATION, AND OTHER RESOURCES “AS IS” AND WITH ALL FAULTS, AND DISCLAIMS ALL WARRANTIES, EXPRESS OR IMPLIED, INCLUDING, WITHOUT LIMITATION, ANY IMPLIED WARRANTIES OF MERCHANTABILITY, FITNESS FOR A PARTICULAR PURPOSE, OR NON-INFRINGEMENT OF THIRD-PARTY INTELLECTUAL PROPERTY RIGHTS.

These resources are intended for developers who are designing with Renesas products. You are solely responsible for (1) selecting the appropriate products for your application, (2) designing, validating, and testing your application, and (3) ensuring your application meets applicable standards, and any other safety, security, or other requirements. These resources are subject to change without notice. Renesas grants you permission to use these resources only to develop an application that uses Renesas products. Other reproduction or use of these resources is strictly prohibited. No license is granted to any other Renesas intellectual property or to any third-party intellectual property. Renesas disclaims responsibility for, and you will fully indemnify Renesas and its representatives against, any claims, damages, costs, losses, or liabilities arising from your use of these resources. Renesas' products are provided only subject to Renesas' Terms and Conditions of Sale or other applicable terms agreed to in writing. No use of any Renesas resources expands or otherwise alters any applicable warranties or warranty disclaimers for these products.

(Disclaimer Rev.1.01 Jan 2024)

### Corporate Headquarters

TOYOSU FORESIA, 3-2-24 Toyosu,  
Koto-ku, Tokyo 135-0061, Japan  
[www.renesas.com](http://www.renesas.com)

### Trademarks

Renesas and the Renesas logo are trademarks of Renesas Electronics Corporation. All trademarks and registered trademarks are the property of their respective owners.

### Contact Information

For further information on a product, technology, the most up-to-date version of a document, or your nearest sales office, please visit [www.renesas.com/contact-us/](http://www.renesas.com/contact-us/).