

RZ/G series

FSP Example Project Usage Guide

Introduction

This Flexible Software Package (FSP) Example Project Usage Guide provides steps and guidelines for operating example projects which use the RZ/G FSP.

Target Device

- RZ/G2L
- RZ/G2LC
- RZ/G2UL
- RZ/G3S

Supported Kit

- RZ/G2L Evaluation Board Kit.
- RZ/G2LC Evaluation Board Kit.
- RZ/G2UL Evaluation Board Kit.
- RZ/G3S Evaluation Board Kit.

Contents

1. Prerequisites.....	4
2. Hardware and Software Requirements	4
3. Tool Installation	4
3.1 FSP and tools installation.....	4
3.2 J-Link RTT Viewer installation.....	4
4. Importing and Running the Project.....	5
4.1 Downloading the Project	5
4.2 Running the project	5
4.2.1 Importing the project into e2studio	5
4.2.2 Connecting with J-Link RTT Viewer.....	6
4.2.3 Running the project.....	11
5. How to change the Evaluation Board Kit Settings on the Project.....	12
5.1 Change to RZ/G2LC Evaluation Board Kit.....	12
5.2 Change to RZ/G2UL Evaluation Board Kit.....	15
6. About Examples	17
6.1 CANFD	17
6.1.1 Project Overview	17
6.1.2 Hardware Requirements	17
6.1.3 Hardware Settings.....	17
6.1.4 Operation.....	19
6.2 RIIC Master	20
6.2.1 Project Overview	20
6.2.2 Hardware Requirements	20
6.2.3 Hardware Settings.....	20
6.2.4 Operation.....	22
6.2.5 Channel to be used	23
6.3 RSPI	24
6.3.1 Project Overview	24
6.3.2 Hardware Requirements	24
6.3.3 Hardware Settings.....	24
6.3.4 Operation.....	26
6.3.5 Channel to be used	28
6.4 SCIF	29
6.4.1 Project Overview	29
6.4.2 Hardware Requirements	29
6.4.3 Hardware Settings.....	29
6.4.4 Operation.....	31

6.4.5	Channel to be used	32
6.5	GPT (Input Capture).....	33
6.5.1	Project Overview	33
6.5.2	Hardware Requirements	33
6.5.3	Hardware Settings.....	33
6.5.4	Operation.....	35
6.6	GPT (PWM).....	36
6.6.1	Project Overview	36
6.6.2	Hardware Requirements	36
6.6.3	Hardware Settings.....	36
6.6.4	Operation.....	37
6.7	GTM.....	39
6.7.1	Project Overview	39
6.7.2	Hardware Requirements	39
6.7.3	Hardware Settings.....	39
6.7.4	Operation.....	40
6.8	FreeRTOS	41
6.8.1	Project Overview	41
6.8.2	Hardware Requirements	41
6.8.3	Hardware Settings.....	41
6.8.4	Operation.....	42
6.9	INTC_IRQ.....	43
6.9.1	Project Overview	43
6.9.2	Hardware Requirements	43
6.9.3	Hardware Settings.....	43
6.9.4	Operation.....	44
6.9.5	Channel to be used	45
6.10	WDT	46
6.10.1	Project Overview	46
6.10.2	Hardware Requirements	46
6.10.3	Hardware Settings.....	46
6.10.4	Preparation.....	47
6.10.5	Operation.....	48
7.	References	49
	Revision History	50

1. Prerequisites

1. Tool experience: It is assumed that the user has prior experience working with integrated development environments, such as e2 studio, SEGGER J-Link RTT Viewer and terminal emulation programs, such as Tera Term.
2. Subject knowledge: It is assumed that the user has basic knowledge about microcontrollers, embedded systems, and FSP to modify the example projects. First time users are recommended to refer to FSP User Manual for Tutorial on [Getting Started with Flexible Software Package](#), paying special attention to sections as follow.
 - Set up a SMARC EVK
 - Tutorial: Your First RZ MPU Project – Blinky
 - Importing an Existing Project into e2 studio
3. The screen shots provided throughout this document are for reference. The actual screen content may differ depending on the version of software and development tools used.

2. Hardware and Software Requirements

RZ/G FSP Example projects are designed to operate using Evaluation Board Kit for RZ/G2L, RZ/G2LC, RZ/G2UL and RZ/G3S MPU officially supported by Renesas.

Refer to the readme.txt file in the specific module folder of */example_projects* folder for additional hardware and software requirements for running the projects.

Note:

Some projects may require external hardware as mentioned in the respective readme.txt files.

Software Requirements

- Windows® 10 operating system
- RZ/G FSP v2.0.0
- e² studio 2024-01
- SEGGER J-Link RTT Viewer v7.94

3. Tool Installation

3.1 FSP and tools installation

Download and install the latest version of FSP and tools from FSP GitHub repository.

1. Open FSP GitHub repository: <https://github.com/renesas/rzg-fsp>
2. Go to the **Releases** section of Git and navigate to latest FSP section.
3. Follow the instructions on installing and using FSP and e² studio.

3.2 J-Link RTT Viewer installation

Download and install SEGGER J-Link Software for Windows from

<https://www.segger.com/downloads/jlink#J-LinkSoftwareAndDocumentationPack>.

Default install path is C:\Program Files\SEGGER\JLink.

Note: Select version 7.94 from the drop-down menu in Version tab.

4. Importing and Running the Project

4.1 Downloading the Project

Download the example project which is "RZ/G FSP Example Projects" from [RZ/G Multi-OS Package | Renesas](#).

4.2 Running the project

4.2.1 Importing the project into e2studio

1. Import an existing project.
Refer to the section *Importing an Existing Project into e2 studio* of [Getting Started with Flexible Software Package](#).
2. Generate project content.
Double clicks to open **configuration.xml** and then click **Generate Project Content**.

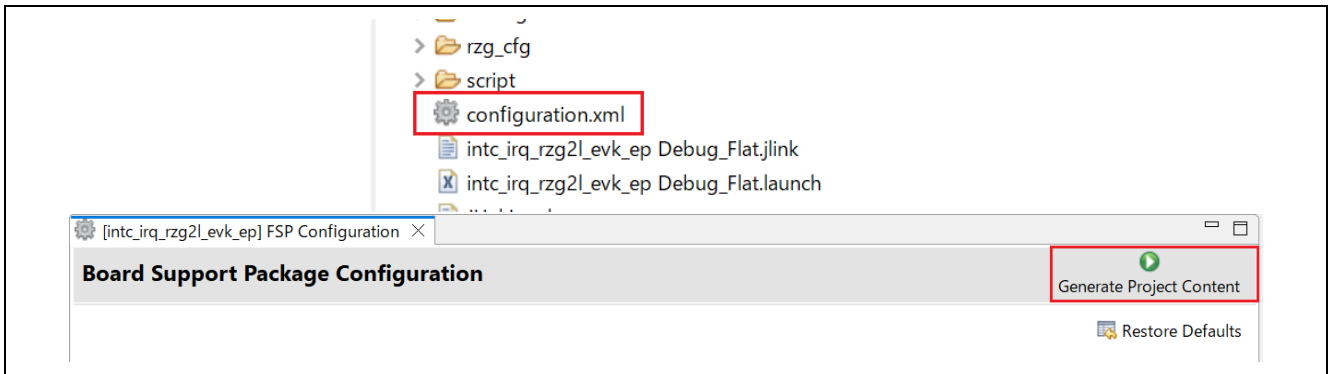

3. Build the project.
There are three ways to build a project:

a. Click on **Project** in the menu bar and select **Build Project**.

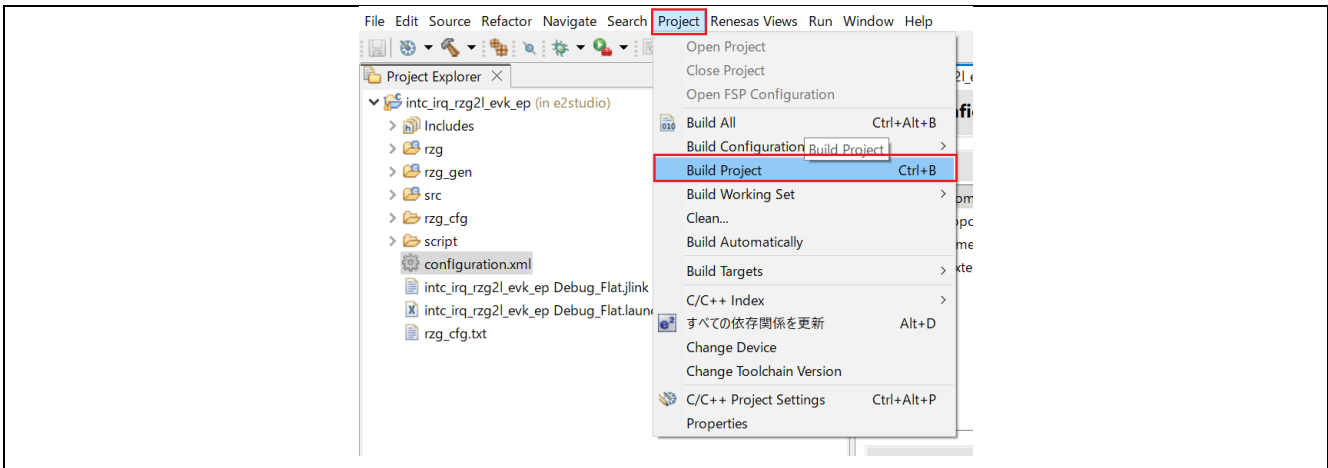

b. Click on the hammer icon.

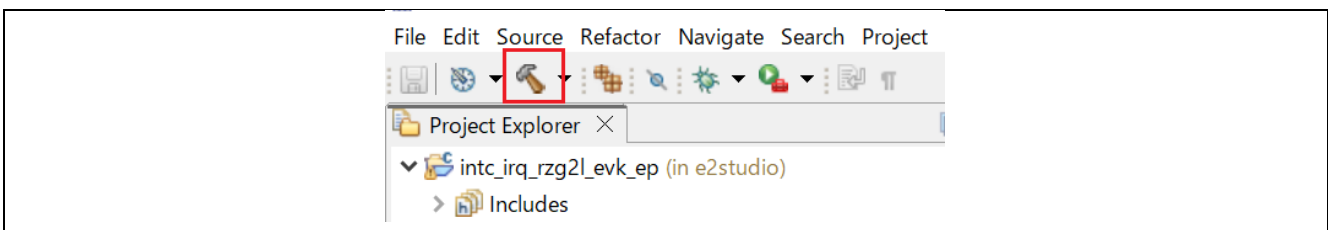

c. Right-click on the project and select **Build Project**.

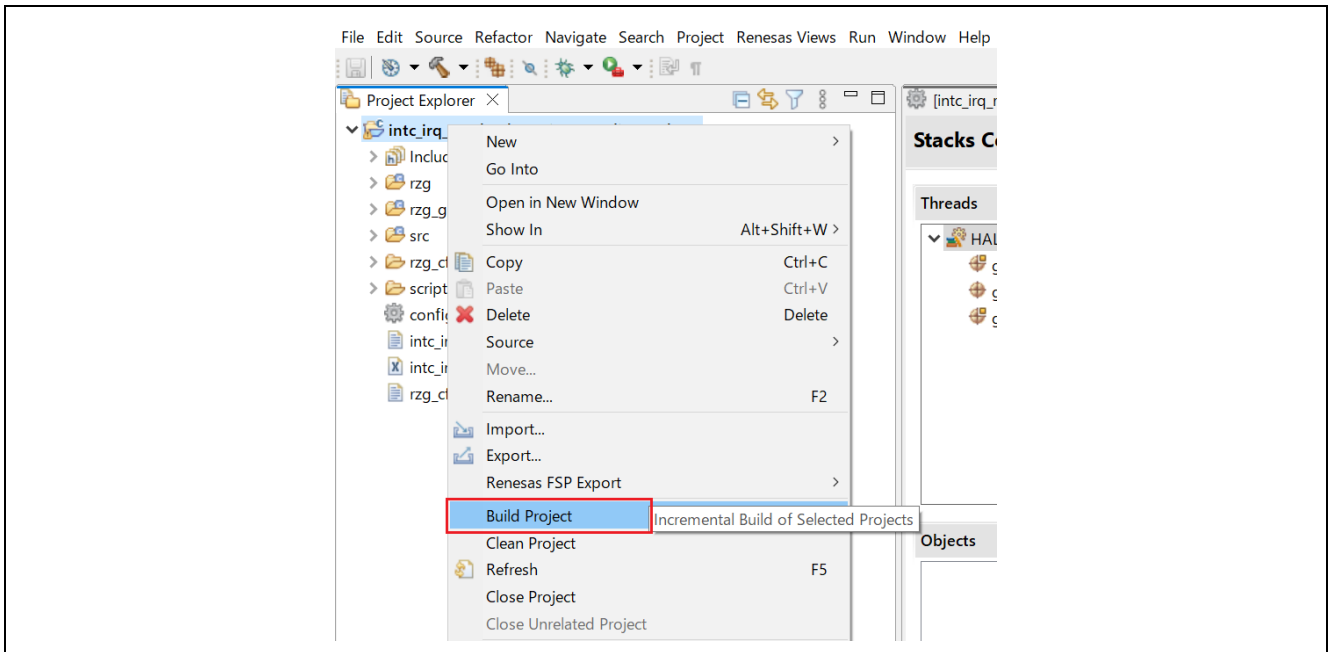

4. Downloading the project image to the board.
Click **Debug** to begin debugging the application.

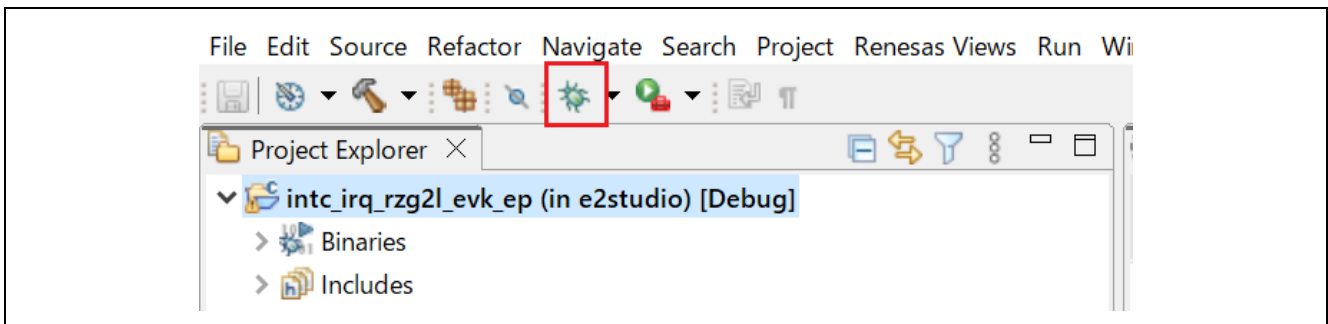

4.2.2 Connecting with J-Link RTT Viewer

1. Open RTT Viewer by double clicking **JLinkRTTViewer.exe** in the installed /SEGGER/Jlink folder.

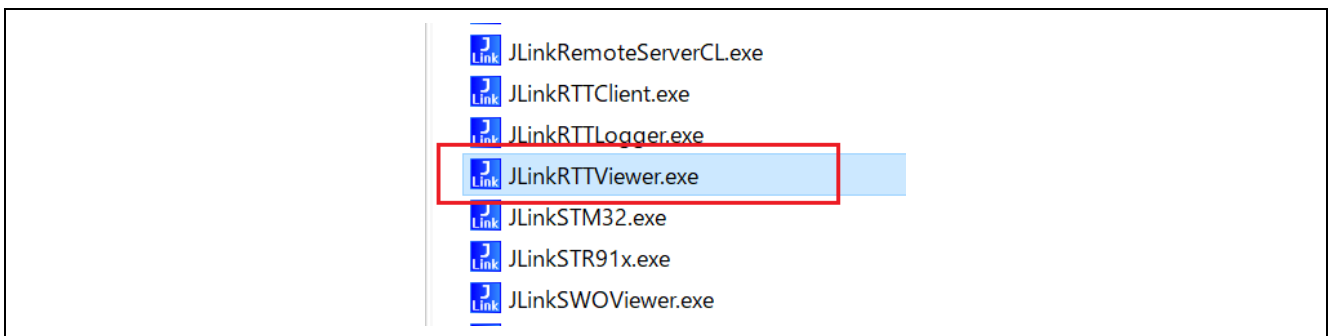

- On opening, the field **Specify Target Device** shows up as **unspecified**. Click on the “...” tab to select the Cortex-M33 device (Cortex-M33 Core) as follows.

The screenshot shows the 'J-Link Target Device Settings' dialog box. The 'Specify Target Device' dropdown menu is set to 'Cortex-M33'. Below this, a table lists the available devices. The row for 'Cortex-M33' is highlighted with a red box.

Manufacturer	Device	Core	NumCores	Flash Size
Unspecified	Cortex-M33	Cortex-M33	1	-

- (This setting is optional.) If multiple kits are connected to the PC, make sure to choose the corresponding serial number. The default is 0.

The screenshot shows the 'J-Link Target Device Settings' dialog box. The 'Serial No' checkbox is checked, and the value '0' is entered in the adjacent text field. The 'Specify Target Device' dropdown is set to 'Cortex-M33'.

4. Select Target Interface & Speed.

With respect to the RZ/G2LC, RZ/G2LC, RZ/G2UL examples and RZ/G3S WDT example, please configure as below.

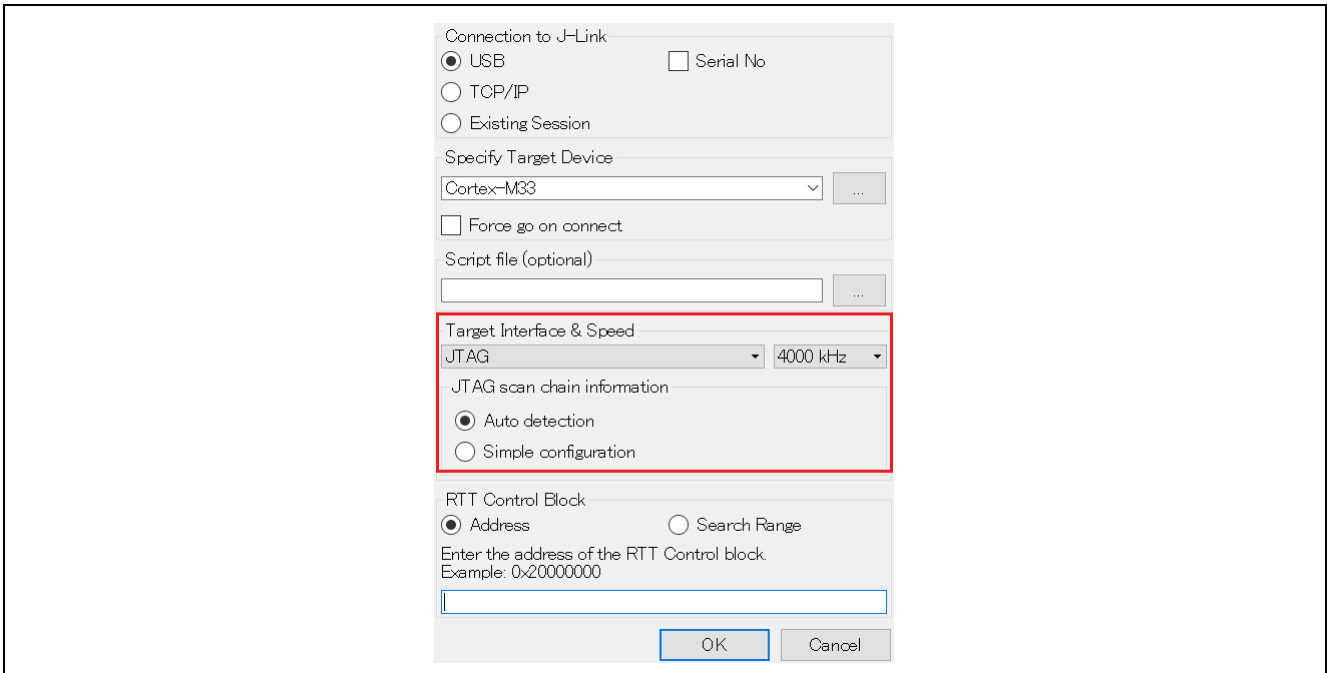

With respect to the other RZ/G3S examples, please configure as below.

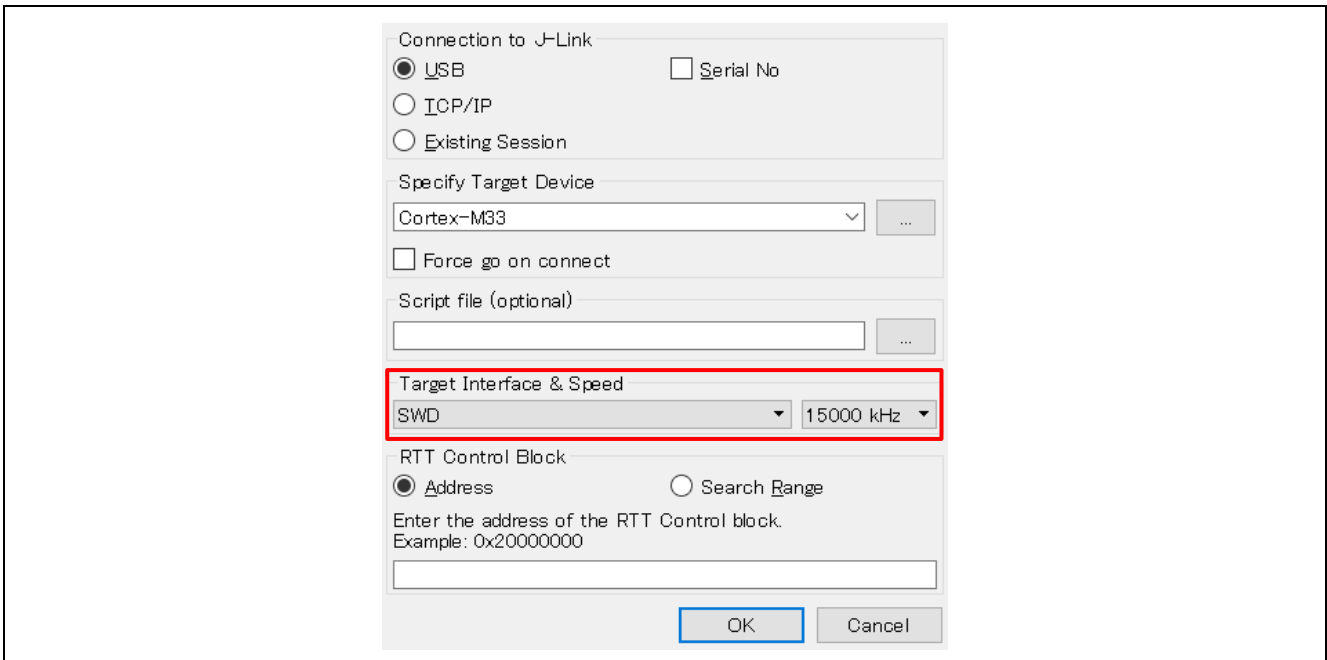

5. Configure RTT Contril Block..

1. Segger RTT block address is required to connect J-Link RTT Viewer. Search **_SEGGER_RTT** variable in the map file, generated upon successfully building a configuration of an example project, which is by default located in the address space for SDRAM.

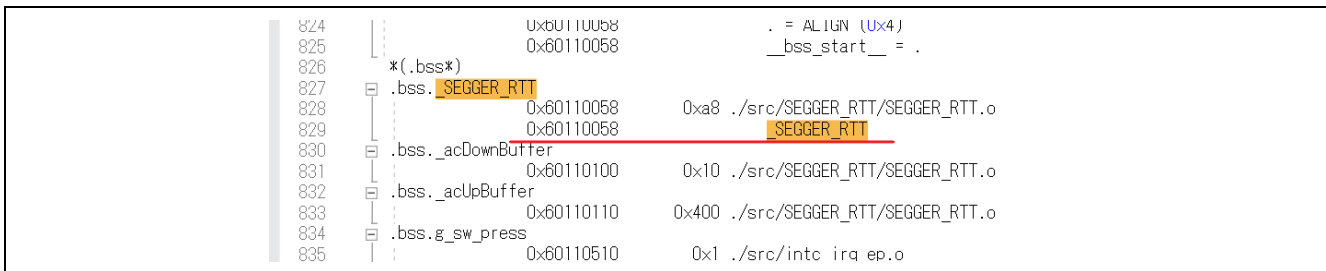
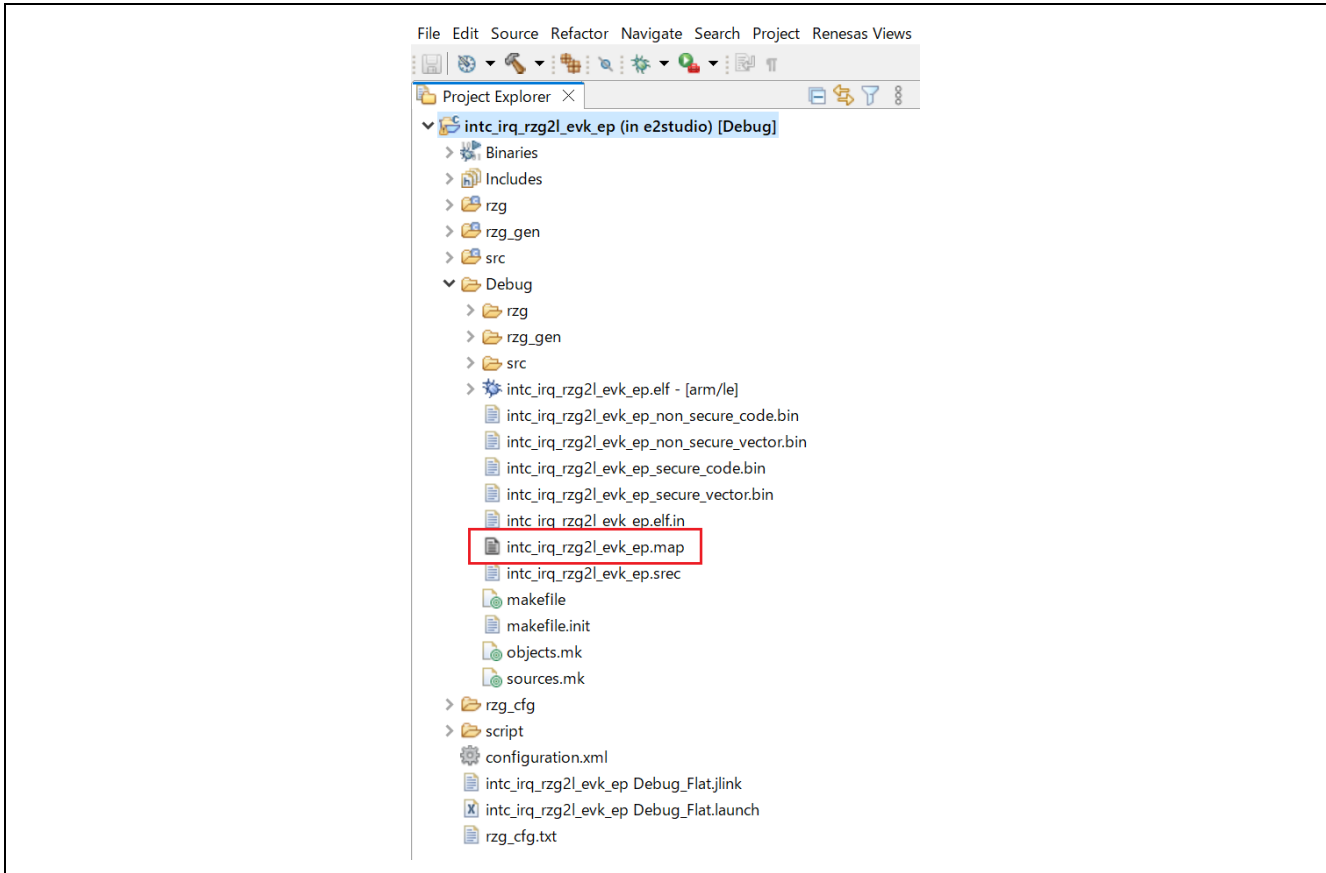

2. Select the Address and enter the address of RTT Control Block into textbox.

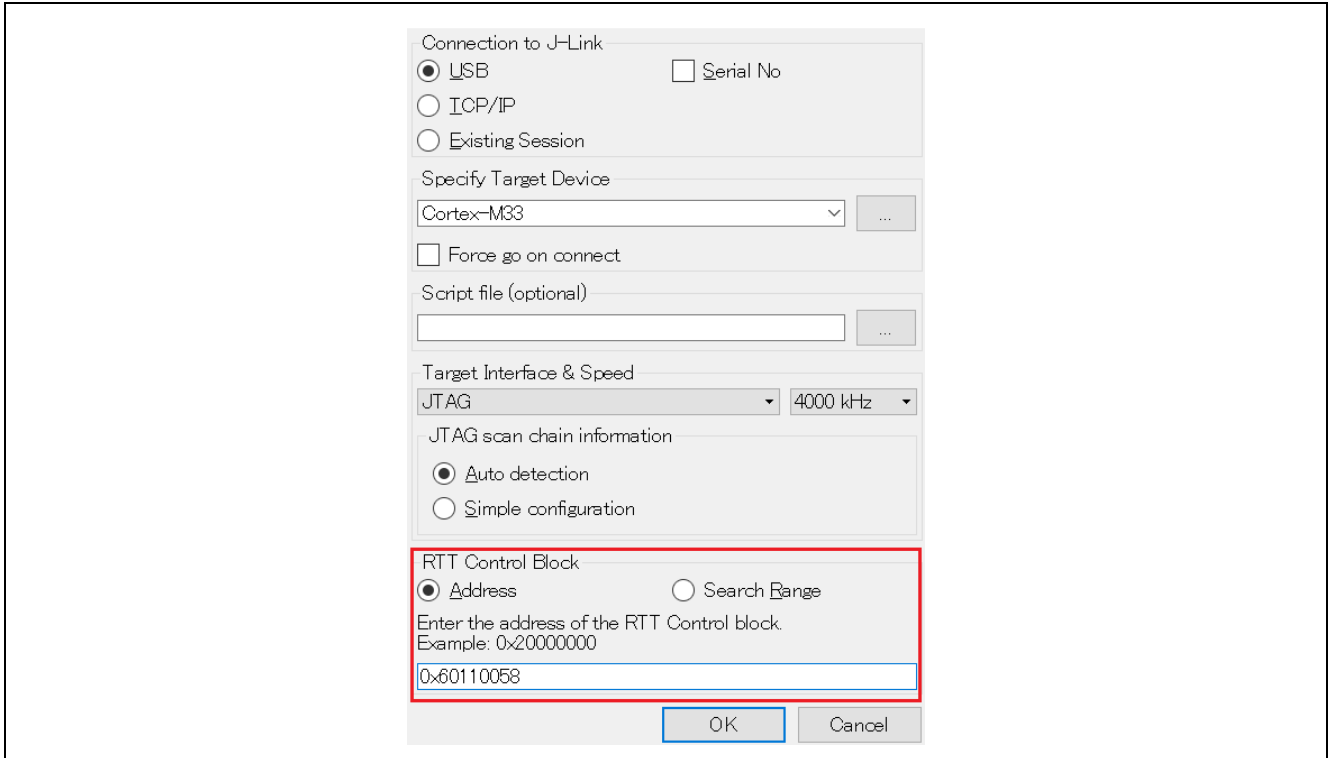

3. Click OK.
4. Click on the Input tab and change Sending option to Send on Enter. Every time input is entered, you must either press the Enter or Enter tab on the RTT viewer.

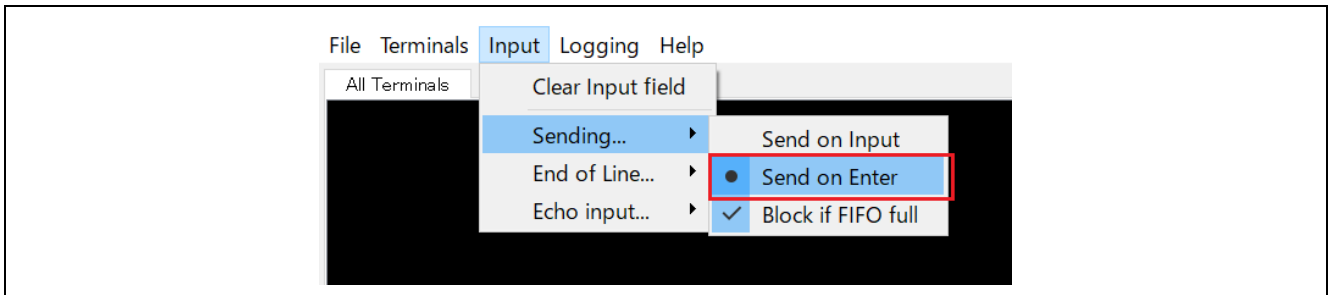

4.2.3 Running the project

1. In Debug mode, click **Run > Resume** or click on the **Play icon**  twice.

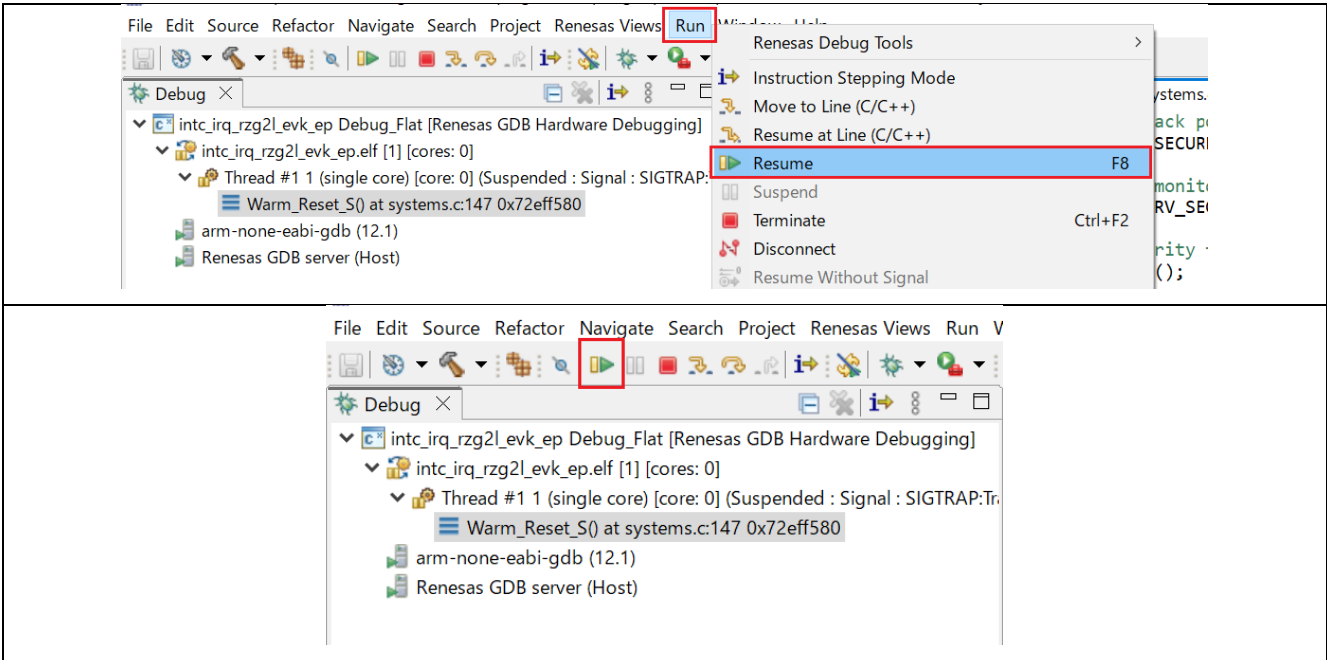

2. Follow the instructions displayed on the RTT Viewer as shown below. Also refer to `readme.txt` file in the project folder to run the project.

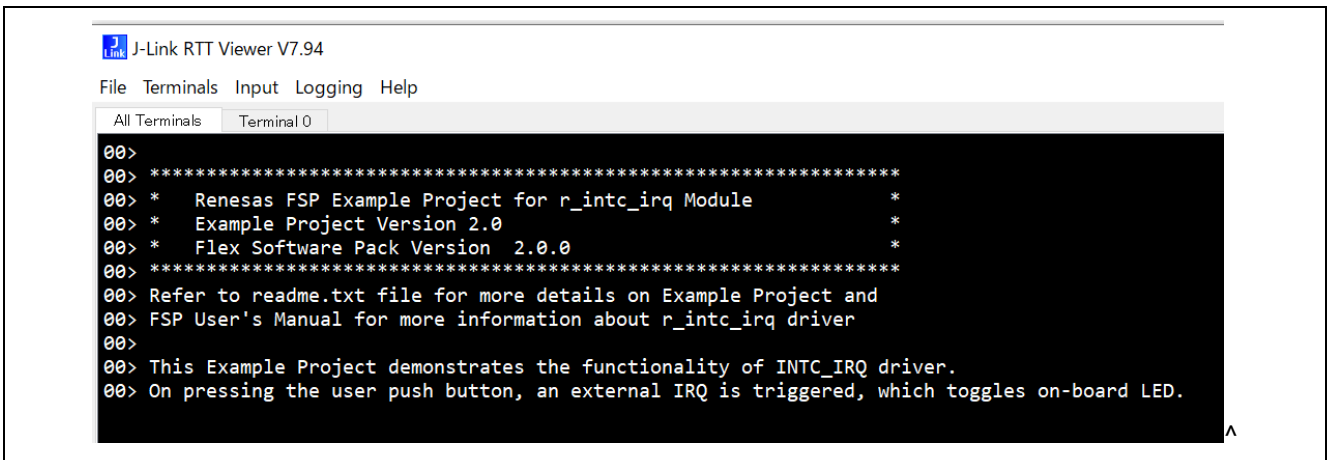

Note:

1. Example Projects do not support floating point or special characters or any non-numeric characters.
2. Example projects do not handle cases where the user input is greater than the expected input array size.

5. How to change the Evaluation Board Kit Settings on the Project

This example project sets RZ/G2L Evaluation Board Kit as default. If you want to use the project for other board kit, follow the below procedure.

5.1 Change to RZ/G2LC Evaluation Board Kit

1. Change **Device Selection** to **RZ/G2LC Evaluation Kit (SMARC)** in FSP Configuration > BSP tab > Board.

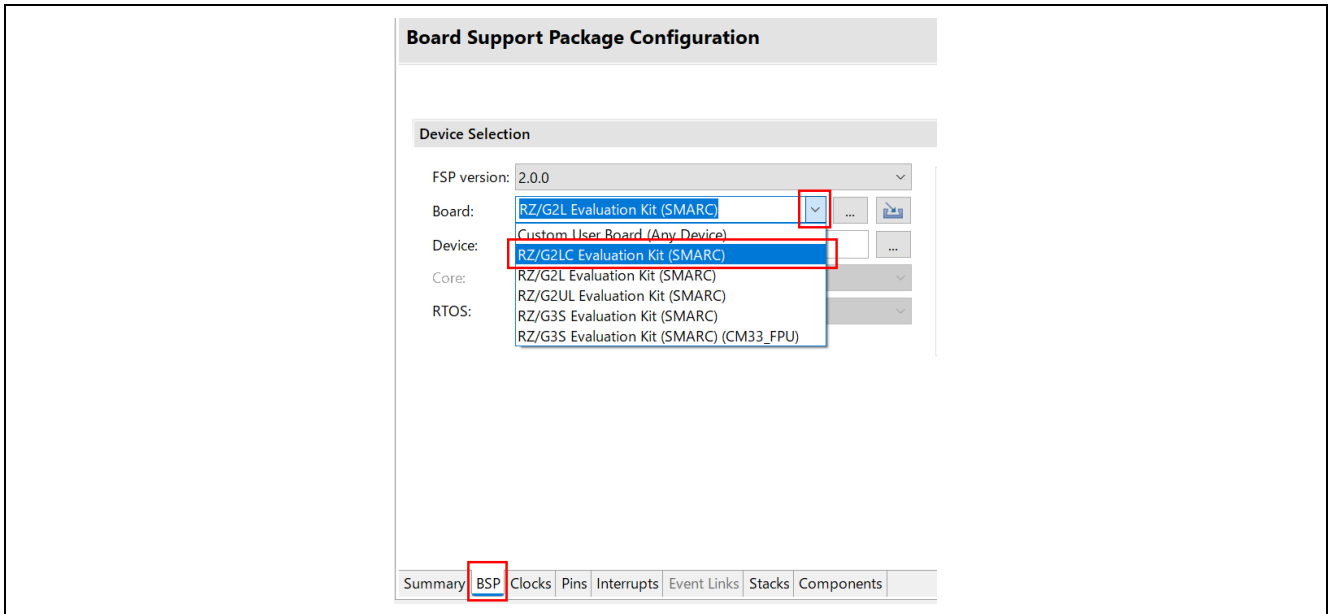

2. When changing the Device Selection, the following Warning may occur. However, the linker script will be set correctly by next step. Therefore, there is nothing to worry about this Warning.

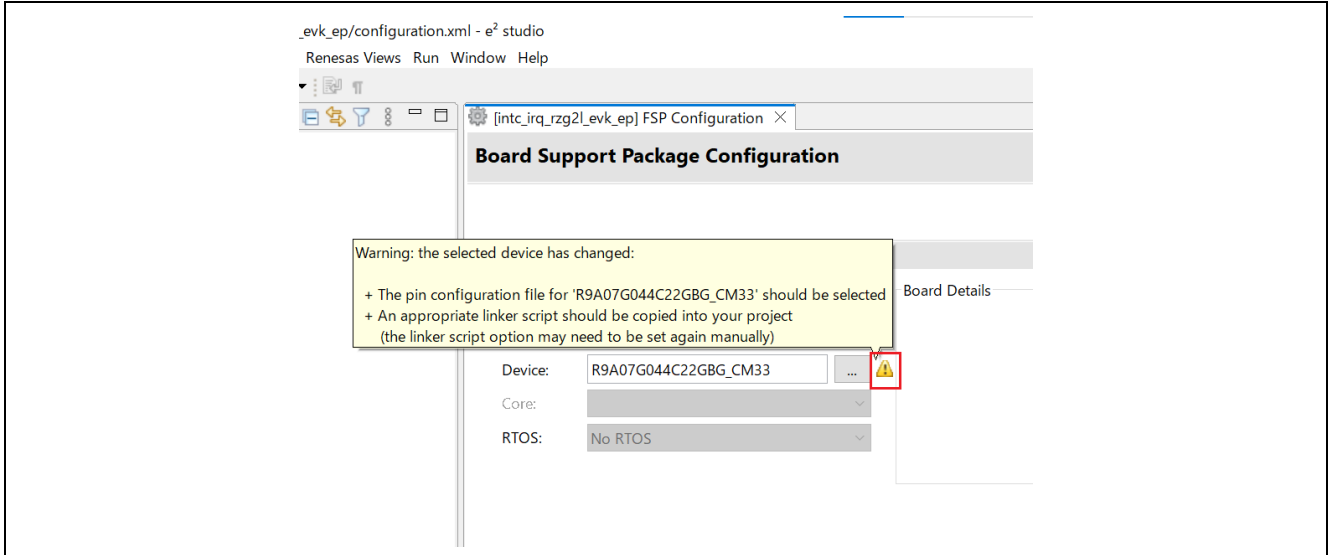

3. Uncheck the box of Generate data for RZG2L-SMARC.pincfg at Pin Configuration which is located in Pins tab.

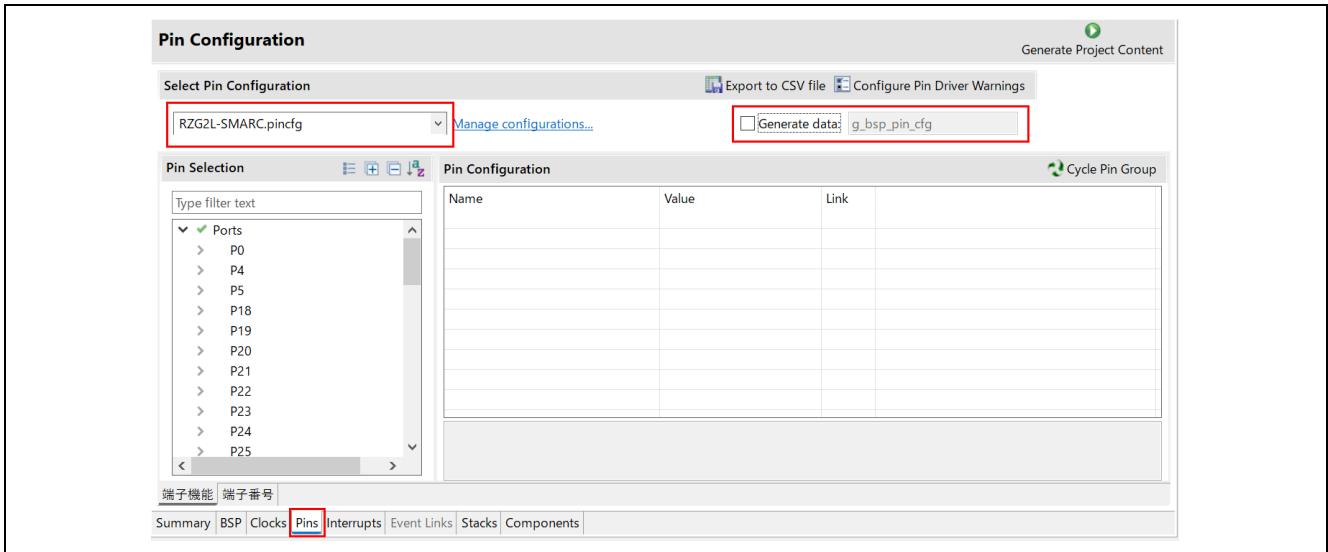

4. Select Pin Configuration to RZG2LC-SMARC.pincfg from drop-down list.

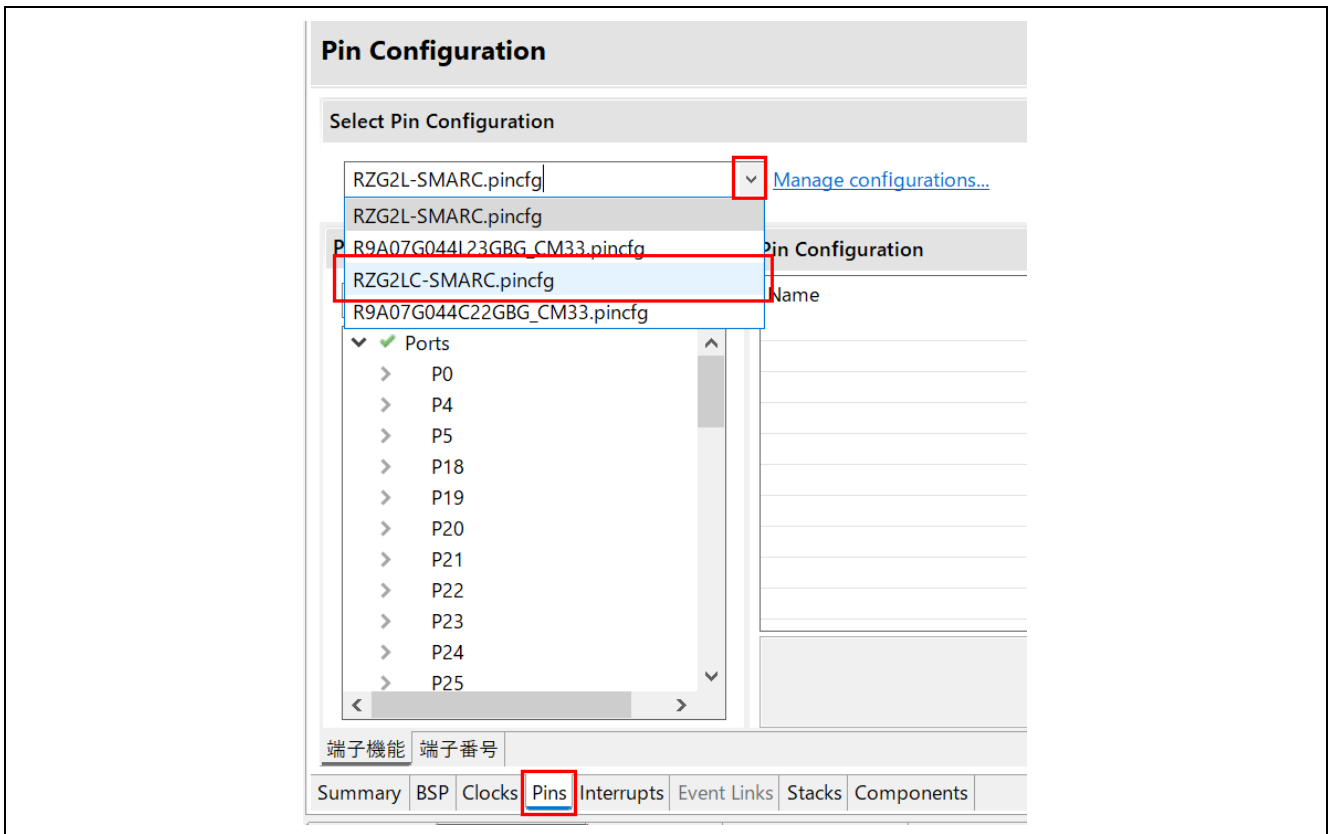

- 5. Check the box of Generate data and input “g_bsp_pin_cfg” into textbox for RZG2LC-SMARC.pincfg at Pin Configuration which is located in Pins tab.

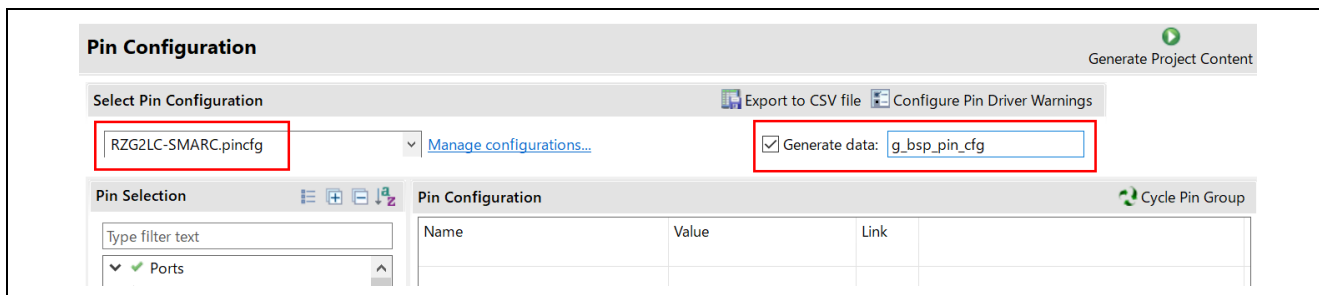

- 6. Click **Generate Project Content**.



- 7. Build the project.

5.2 Change to RZ/G2UL Evaluation Board Kit

1. Change **Device Selection** to **RZ/G2UL Evaluation Kit (SMARC)** in FSP Configuration > BSP tab > Board.

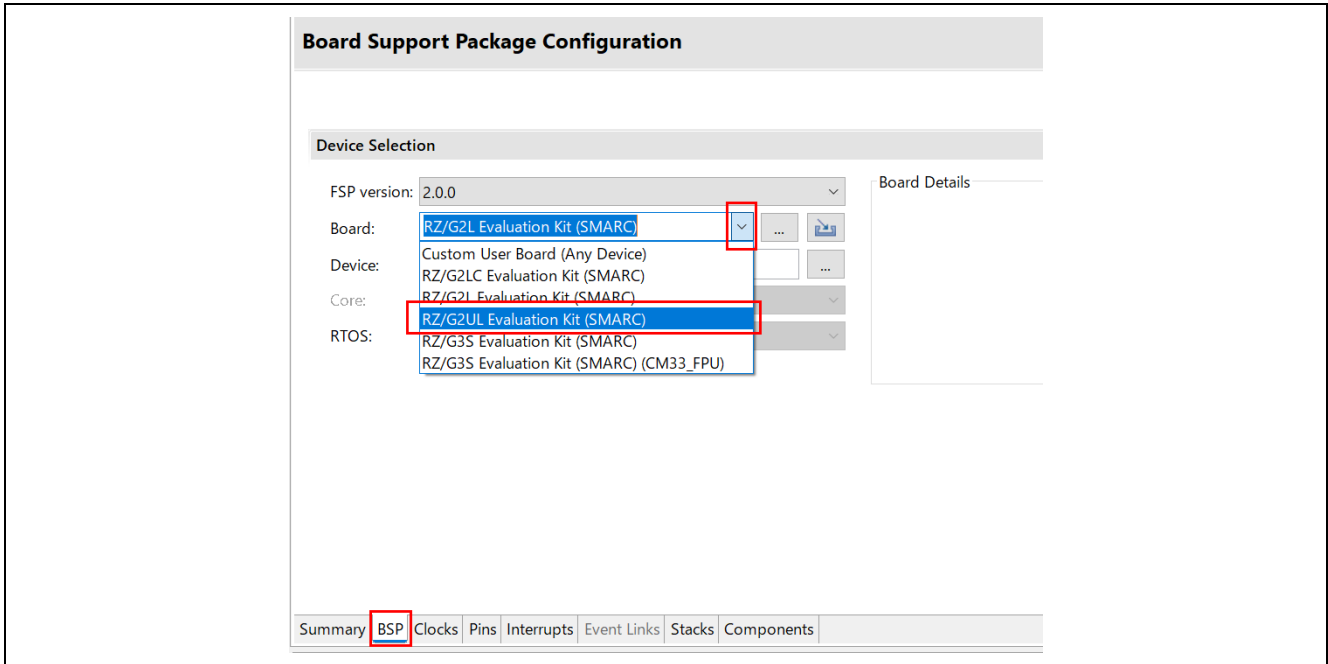

2. When changing the Device Selection, the following Warning may occur. However, the linker script will be set correctly by next step. Therefore, there is nothing to worry about this Warning.

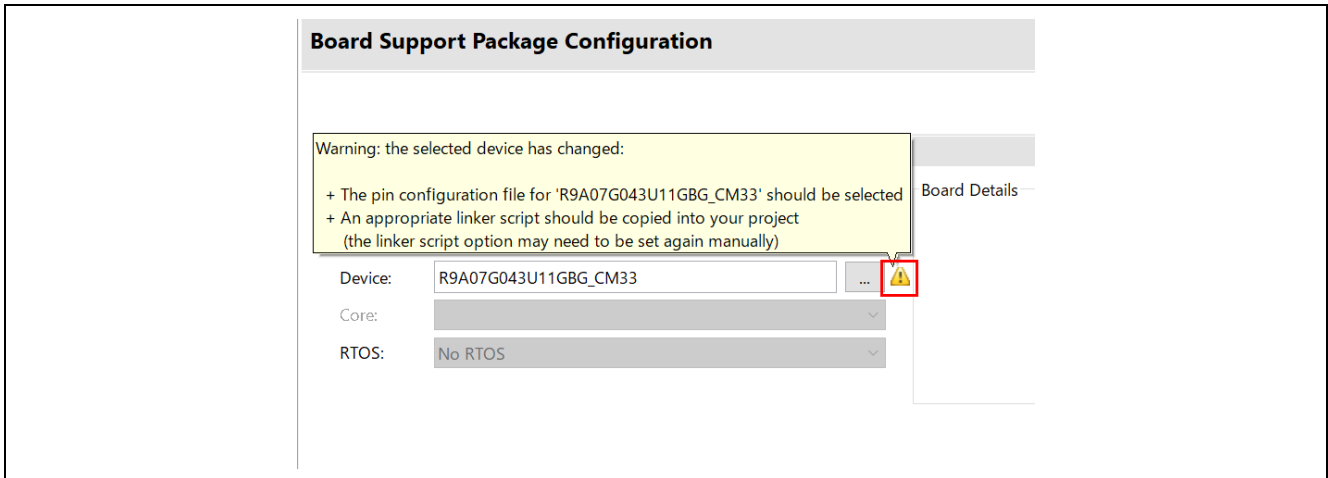

- Uncheck the box of Generate data for RZG2L-SMARC.pincfg at Pin Configuration which is located in Pins tab.

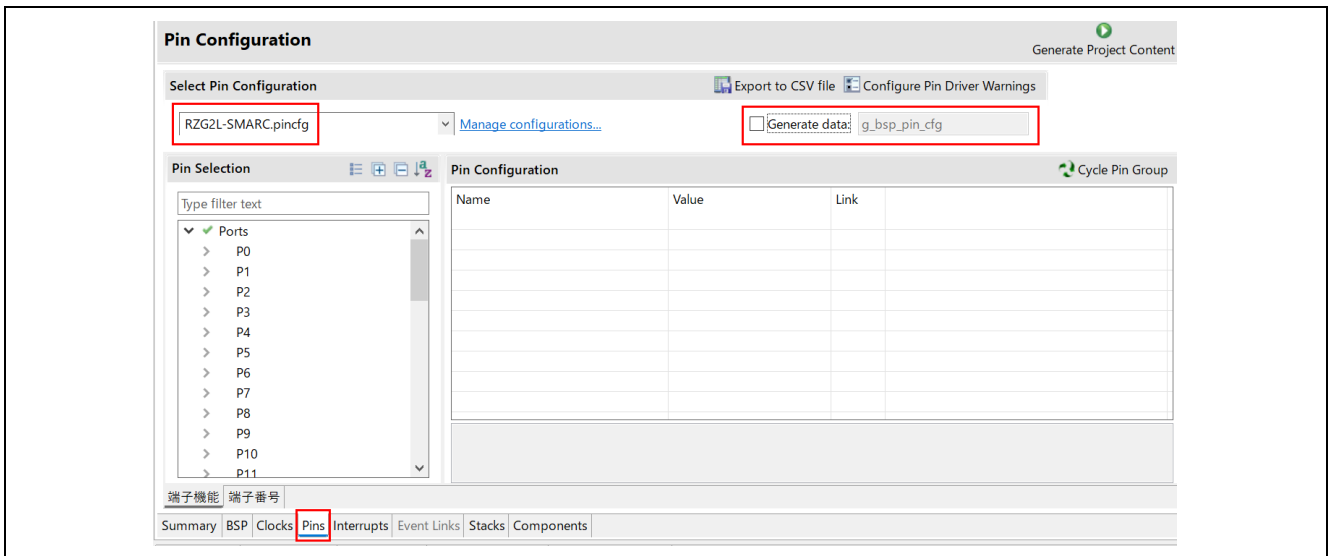

- Select Pin Configuration to RZG2UL-SMARC.pincfg from drop-down list.

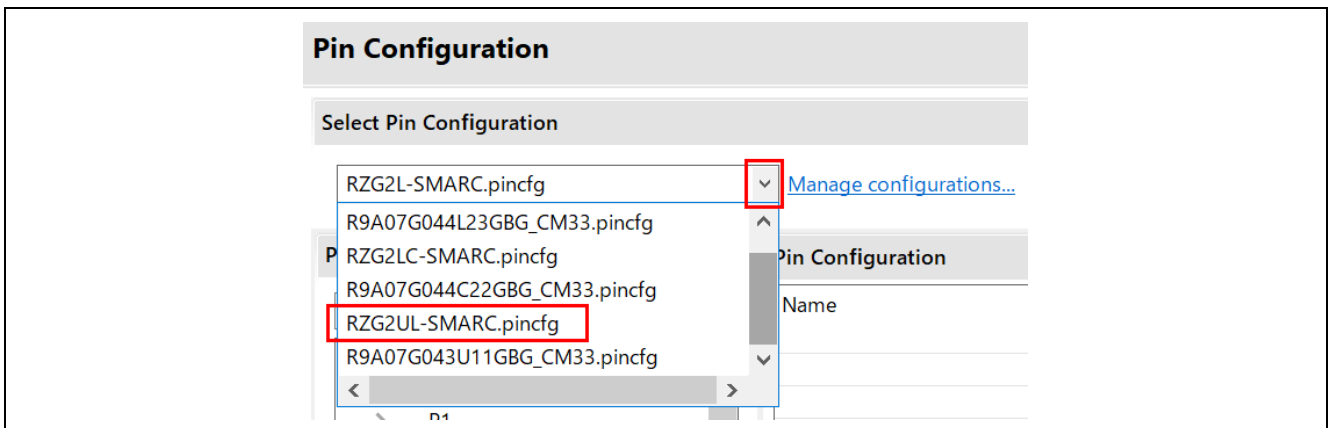

- Check the box of Generate data and input "g_bsp_pin_cfg" into textbox for RZG2UL-SMARC.pincfg at Pin Configuration which is located in Pins tab.

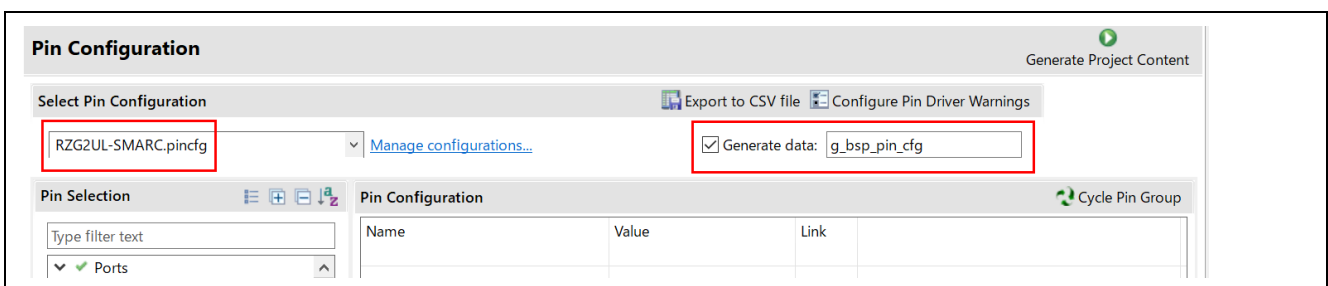

- Click **Generate Project Content**.

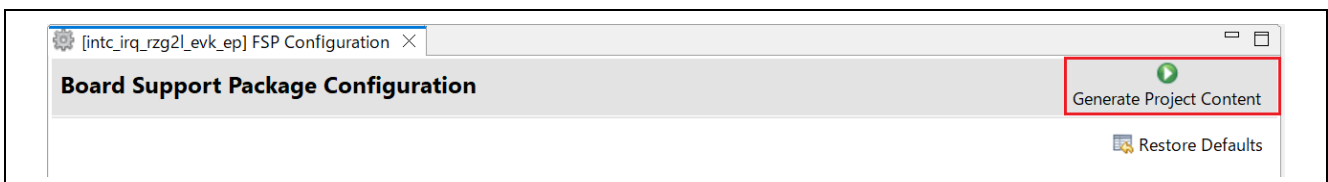

- Build the project.

6. About Examples

6.1 CANFD

6.1.1 Project Overview

The example project shows the operation of CAN-FD running on Renesas RZ MPUs using channel 0 and channel 1 on board. On pressing any key on the Terminal Emulator, data is transmitted from one channel to another.

On the 1st transmission, Channel 0 transmits data to Channel 1. Channel 1 displays the received data.

On the 2nd transmission, Channel 1 transmits updated data to Channel 0 as ACK. Channel 0 displays the received data. Then, Channel 0 changes CAN frame to CANFD frame and updates data.

On the 3rd transmission, Channel 0 transmits updated data to Channel 1. Channel 1 displays the received data. Then, Channel 1 changes CAN frame to CANFD frame and updates data to transmits back to Channel 0 as ACK.

On 4th transmission, Channel 1 transmits updated data to Channel 0 as ACK. Channel 0 displays the received data.

6.1.2 Hardware Requirements

External hardware: Pmod LED

Also, The Evaluation Board Kit must have IC15 (to support CAN port)is on the carrier board.

6.1.3 Hardware Settings

Please connect each hardware as below.

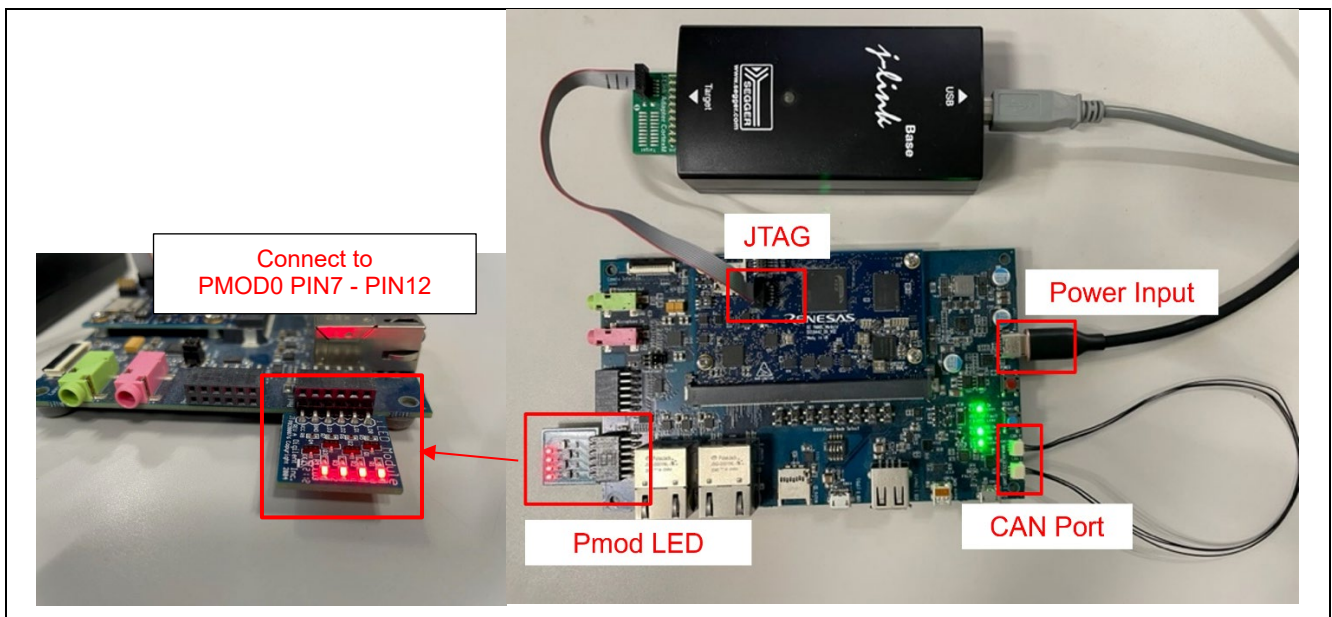

Board Setting (RZ/G2L, RZ/G2UL)

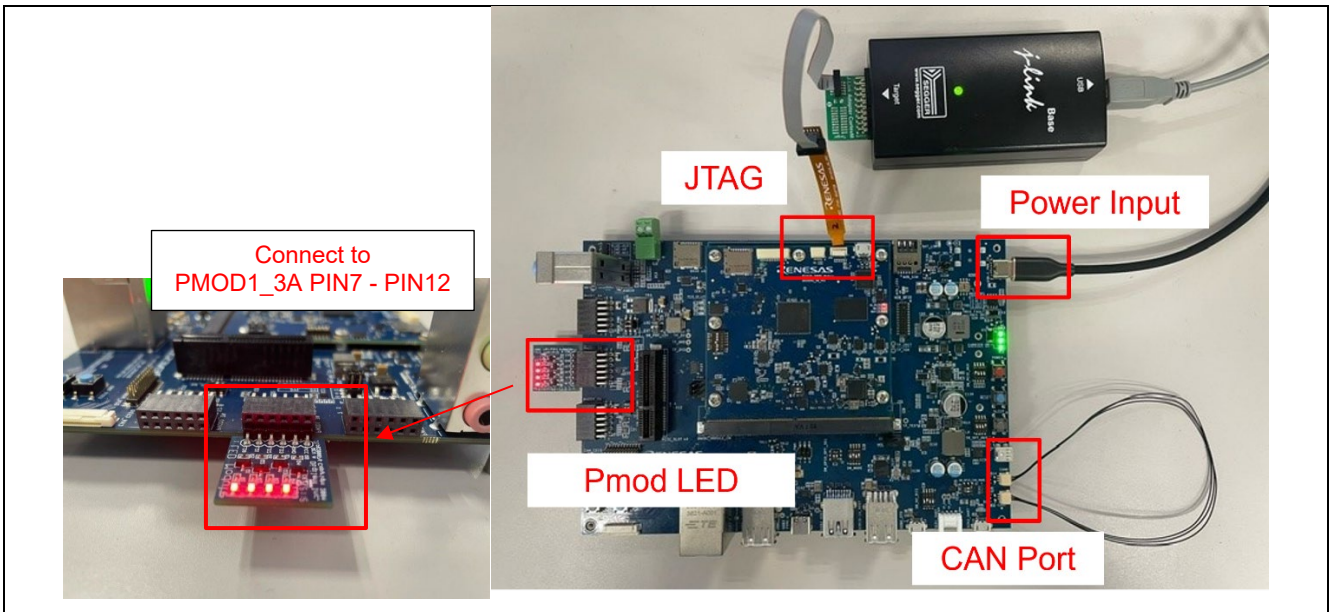

Board Setting (RZ/G3S)

Please set each DIP switch and jumpers as below.

Board	RZ/G2L EVK	RZ/G2UL EVK	RZ/G3S EVK
Module board	SW1-1: OFF SW1-2: Don't care.	SW1-1: OFF SW1-2: Don't care. SW1-3: OFF	SW_CONFIG_1: OFF SW_CONFIG_2: OFF SW_CONFIG_3: ON SW_CONFIG_4: OFF SW_CONFIG_5: OFF SW_CONFIG_6: OFF
Carrier board	SW1: Don't care. SW2: Don't care. SW3: Don't care. SW4: Don't care. SW5: Don't care. SW6: Don't care. SW7: 1-2 SW8: 1-2 SW11-1: OFF SW11-2: OFF SW11-3: OFF SW11-4: ON CN4: Jumper connects 1-3 Jumper connects 2-4		SW_MODE_1: OFF SW_MODE_2: ON SW_MODE_3: OFF SW_MODE_4: ON SW_M2_DIS_4: ON PMOD_PWR_SEL: Jumper 2-4 SW_GPIO_CAN_PMOD: SW1: 2-3 SW2: 5-6

6.1.4 Operation

After running the example, the message below is displayed on console. After inputting any key, the transmission will be performed accordingly.

```
00> Refer to readme.txt file for more details on Example Project and
00> FSP User's Manual for more information about CAN FD driver
00>
00> This Example Project demonstrates CAN FD operations on Renesas RZ MCUs using 1 RZ/G board.
00> On pressing any key on the RTT Viewer, data is transmitted from one channel to other.
00> On 1st transmission, Channel 0 transmits data to Channel 1. Channel 1 displays the received data.
00> On 2nd transmission, Channel 1 transmits updated data to Channel 0 as ACK. Channel 0 displays the received data,
00> then Channel 0 changes CAN frame to CANFD frame and updates data.
00> On 3rd transmission, Channel 0 transmits updated data to Channel 1. Channel 1 displays the received data,
00> then Channel 1 changes CAN frame to CANFD frame and updates data to transmits back to Channel 0 as ACK.
00> On 4th transmission, Channel 1 transmits updated data to Channel 0 as ACK. Channel 0 displays the received data.
00>
00> Please enter any key on Terminal Emulator to initiate CAN transmission.
< h
00>
00> User input: h
00>
00> 1. Transmission of data over classic CAN Frame
00>
00> Classic CAN transmission is successful
00> Received 'TX_MESG' on classic frame.
00> 2. Responding with 'RX_MESG' using classic CAN frame
00>
00> CAN transmission after receive is successful. Sent back the ACK using classic CAN frame
00> Received Acknowledgement for Classic CAN Frame transmission.
00> CAN operation Successful. Data length = 8
00>
00> 3. Data transmission over FD frame
00>
00> CAN transmission on FD Frame after receiving classic frame ACK is successful
00> Received data over FD Frame.
00> CAN operation Successful. Data length = 16
00>
00> 4. Sending modified data over FD Frame now as acknowledgement for received FD data.
00>
00> CAN transmission on FD Frame as acknowledgement is successful
00> Received Acknowledgement for FD Frame.
00> CAN operation Successful. Data length = 16
```

6.2 RIIC Master

6.2.1 Project Overview

The example project demonstrates the typical use of the RIIC master HAL module APIs. The project initializes RIIC master module with fast mode and interfaces with PmodACL™ Board for ADXL345.

On powers up after establishing the connection of sensor with RZ/G2L board, it displays accelerometer axis data on RTTviewer. Any API/event failure will be displayed on RTTviewer.

6.2.2 Hardware Requirements

External hardware: Pmod ACL

6.2.3 Hardware Settings

Please connect each hardware as below.

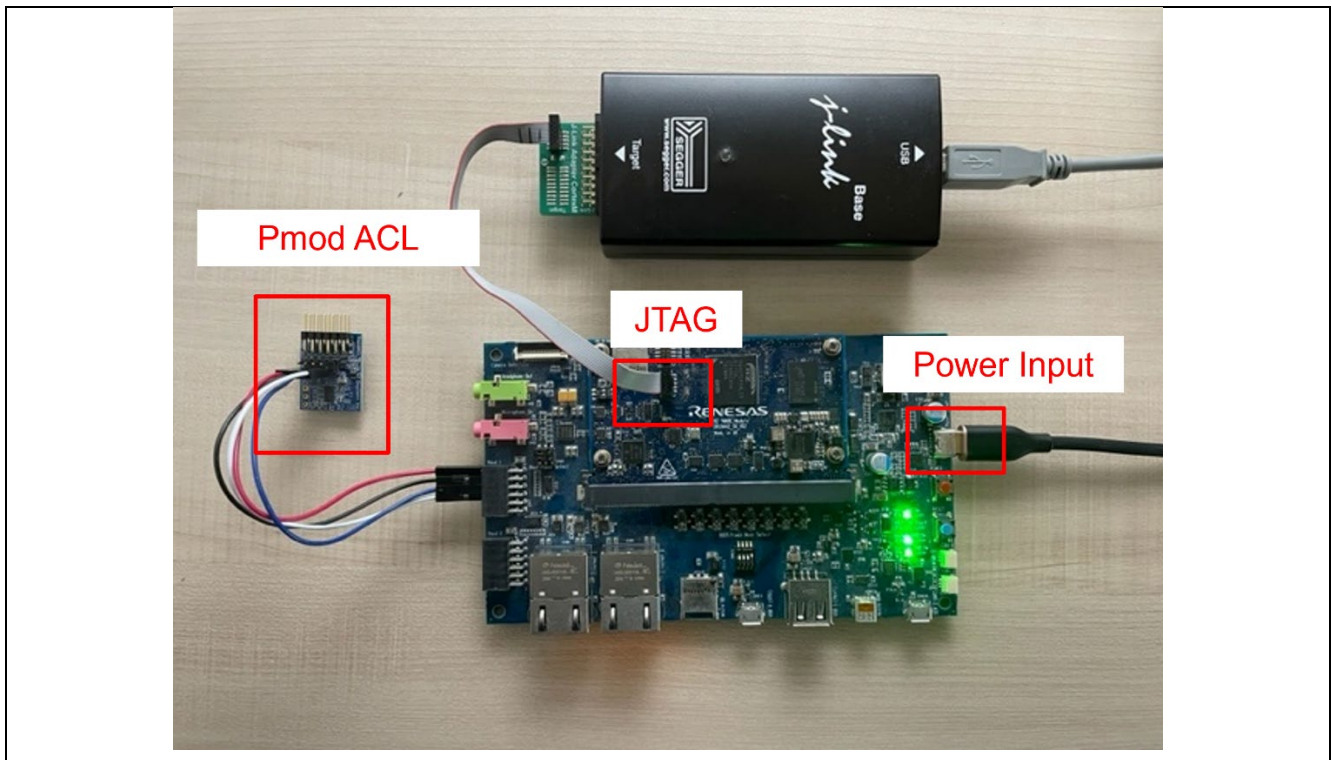

Board Setting (RZ/G2L, RZ/G2LC, RZ/G2UL)

Please set the connection between Pmod ACL and PMOD1 on board as below.

Connection of Pmod ACL	
SCL:	Pmod ACL J2 PIN5 – PMOD1 PIN3
SDA:	Pmod ACL J2 PIN6 – PMOD1 PIN4
GND:	Pmod ACL J2 PIN7 – PMOD1 PIN5
VCC:	Pmod ACL J2 PIN8 – PMOD1 PIN6

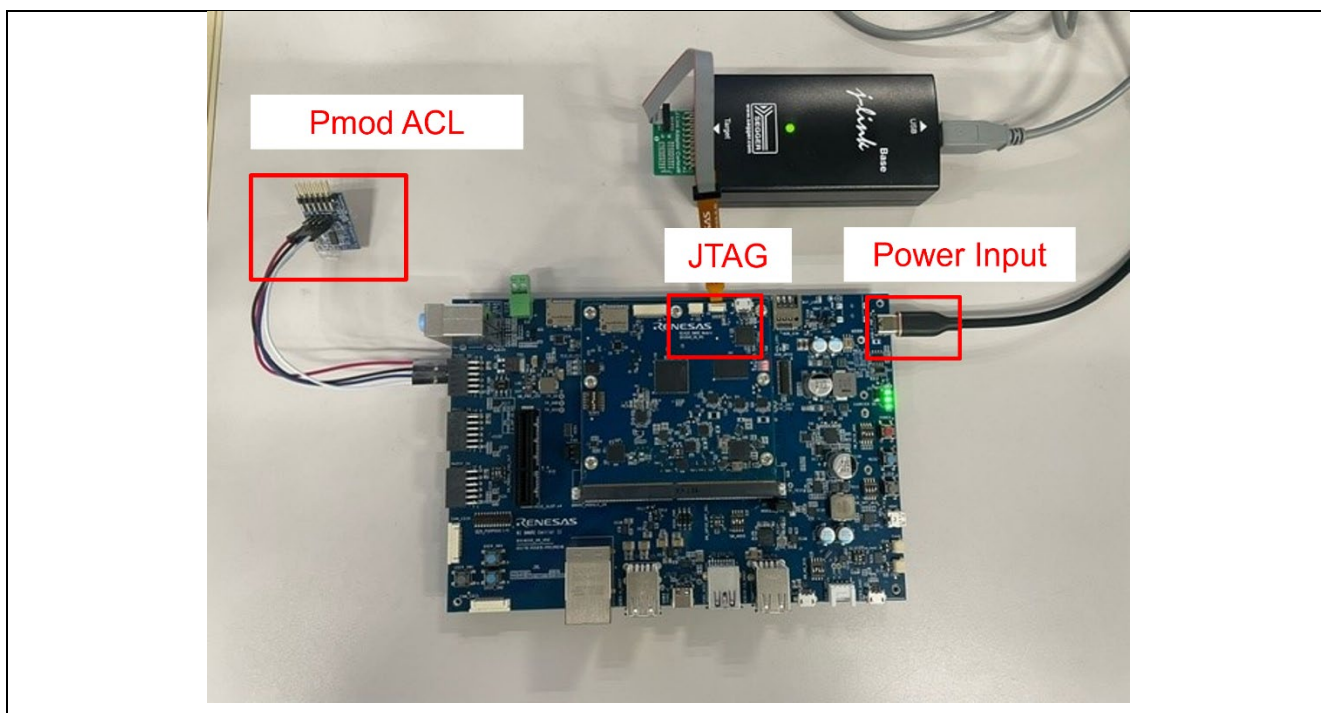
**Board Setting (RZ/G3S)**

Please set the connection between Pmod ACL and PMOD1_6A on board as below.

Connection of Pmod ACL	
SCL:	Pmod ACL J2 PIN5 – PMOD1_6A PIN3
SDA:	Pmod ACL J2 PIN6 – PMOD1_6A PIN4
GND:	Pmod ACL J2 PIN7 – PMOD1_6A PIN5
VCC:	Pmod ACL J2 PIN8 – PMOD1_6A PIN6

Please set each DIP switch and jumpers as below.

Board	RZ/G2L EVK	RZ/G2LC EVK	RZ/G2UL EVK	RZ/G3S
Module board	SW1-1: OFF SW1-2: Don't care.	SW1-1: OFF SW1-2: Don't care. SW1-3: Don't care. SW1-4: Don't care. SW1-5: Don't care. SW1-6: Don't care.	SW1-1: OFF SW1-2: Don't care. SW1-3: Don't care.	SW_CONFIG_1: OFF SW_CONFIG_2: OFF SW_CONFIG_3: ON SW_CONFIG_4: OFF SW_CONFIG_5: OFF SW_CONFIG_6: OFF
Carrier board	SW1: Don't care. SW2: Don't care. SW3: 1-2 SW4: 1-2 SW5: Don't care. SW6: Don't care. SW7: Don't care. SW8: Don't care. SW11-1: OFF SW11-2: OFF SW11-3: OFF SW11-4: ON CN4: Jumper connects 1-3 Jumper connects 2-4			SW_MODE_1: OFF SW_MODE_2: ON SW_MODE_3: OFF SW_MODE_4: ON PMOD_PWR_SEL: Jumper connects 2-4

6.2.4 Operation

After running the example, the message below is displayed on console. The sensor information is shown.

```

Refer to readme.txt file for more details on Example Project and
FSP User's Manual for more information about r_riic_master driver

This project utilizes PMOD ACL sensor as iic slave device
Upon successful initialization, MPU displays sensor axis data

If SDA line is kept in LOW by any error
Please input any character on J-Link RTT Viewer to Open bus.

X-axis = 243.00, Y-axis = 4.00, Z-axis = 65488.00
X-axis = 245.00, Y-axis = 3.00, Z-axis = 65490.00
X-axis = 244.00, Y-axis = 5.00, Z-axis = 65488.00

```

6.2.5 Channel to be used

As mentioned in section **Error! Reference source not found.**, user can change the board in FSP Configuration. If a user changed the board kit from RZ/G2L Evaluation Board Kit to RZ/G2LC Evaluation Board Kit or RZ/G2UL Evaluation Board Kit, the channel to be used should be changed in FSP Configuration.

The channel to be used can be confirmed on stack's property shown below.

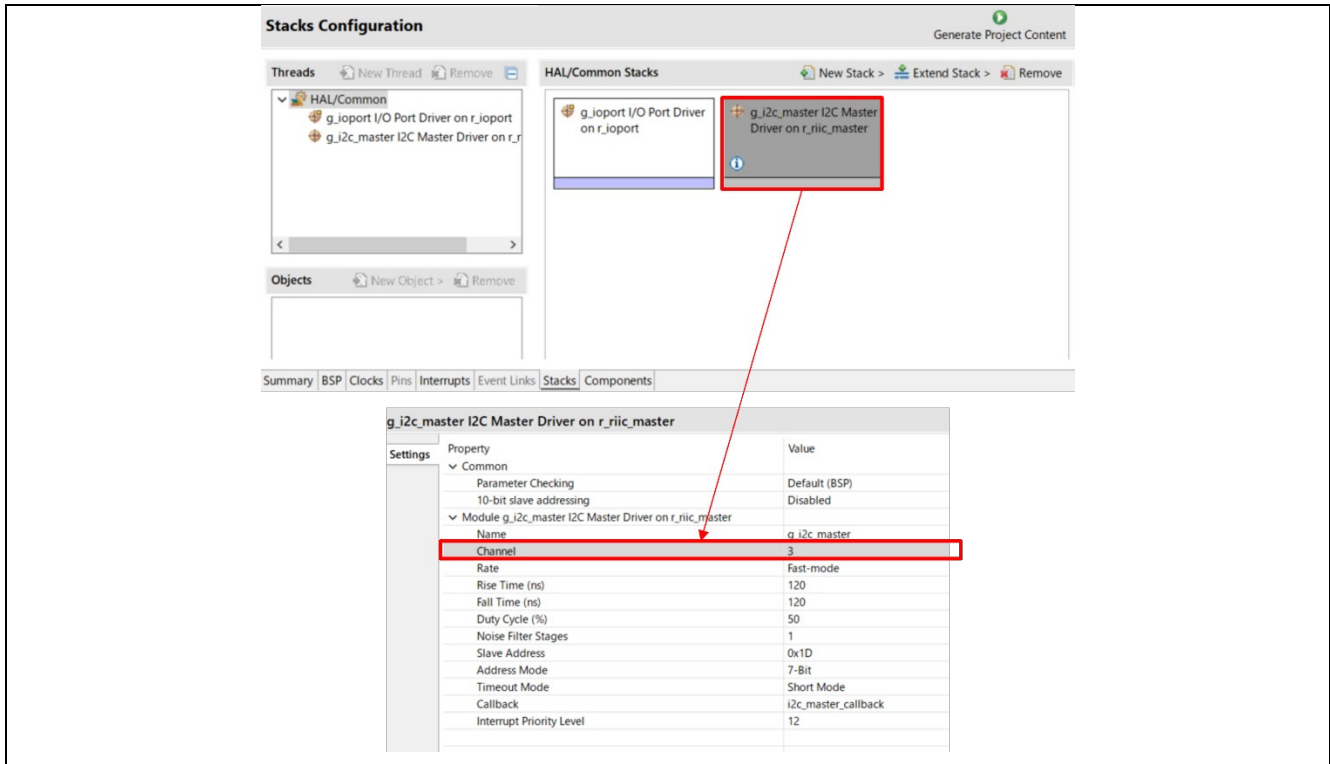

The channel to be used on each board is shown below.

RZ/G2L EVK	RZ/G2LC EVK	RZ/G2UL EVK
Ch 3	Ch 2	Ch 1

6.3 RSPI

6.3.1 Project Overview

The RSPI example for RZ/G2L, RZ/G2UL specification is different from RZ/G3S.

For RZ/G2L, RZ/G2UL:

The example project demonstrates the typical use of the RSPI HAL module APIs. The project configures RSPI channels (Channel 0 and Channel 1) in Master and Slave mode. Once the module is initialized and the channels are configured, Master and Slave can transmit and receive data based on commands from user sent through JLinkRTTViewer.

For RZ/G3S:

The example project demonstrates the typical use of the RSPI HAL module APIs. The project configures RSPI channel 0 in Master and Pmod SF3 in Slave. Once the module is initialized and the channels are configured, Master can write data to Slave and read it back based on commands from user sent through JLink RTT Viewer.

6.3.2 Hardware Requirements

External hardware: Pmod SF3 (RZ/G3S environment only.)

6.3.3 Hardware Settings

Please connect each hardware as below.

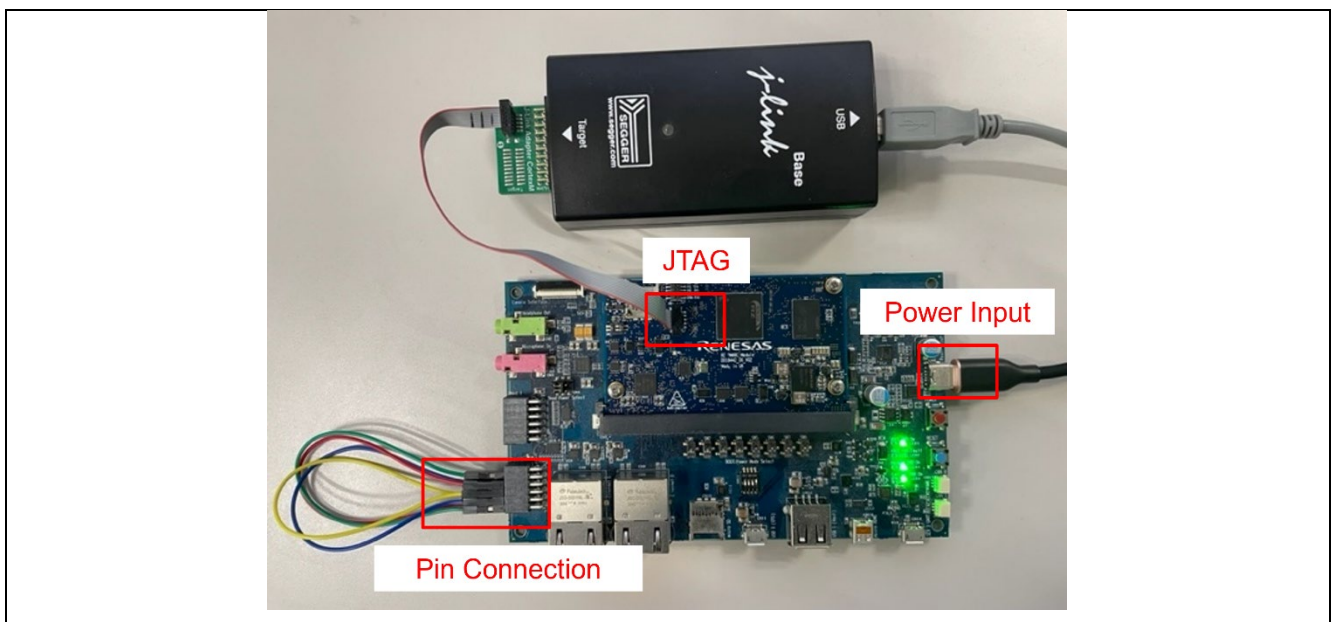

Board Setting (RZ/G2L, RZ/G2UL)

Please set the Pin Connection as below.

RZ/G2L EVK	RZ/G2UL EVK
MISO: PMOD0 PIN3 - PMOD0 PIN8	MISO: PMOD0 PIN3 - PMOD1 PIN8
MOSI: PMOD0 PIN2 - PMOD0 PIN10	MOSI: PMOD0 PIN2 - PMOD1 PIN7
CK: PMOD0 PIN4 - PMOD0 PIN7	CK: PMOD0 PIN4 - PMOD0 PIN8
SSL: PMOD0 PIN1 - PMOD0 PIN11	SSL: PMOD0 PIN1 - PMOD0 PIN9

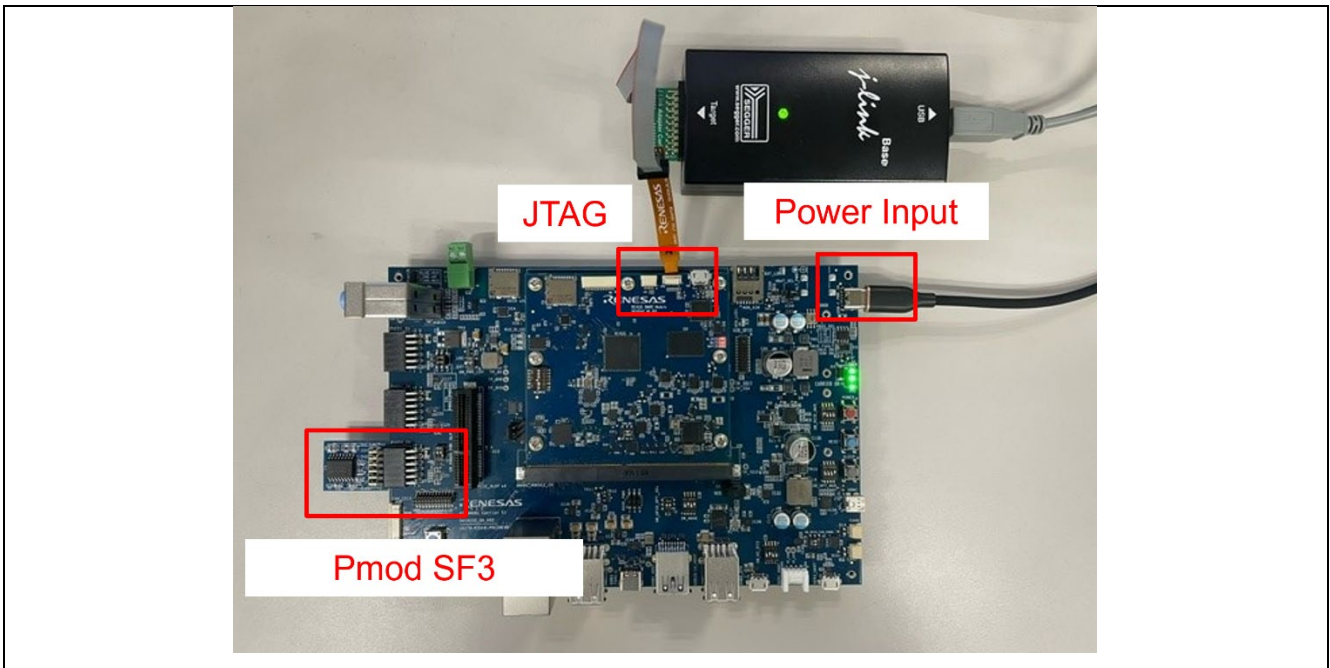

Board Setting (RZ/G3S)

Please set each DIP switch and jumpers as below.

Board	RZ/G2L EVK	RZ/G2UL EVK	RZ/G3S EVK
Module board	SW1-1: OFF SW1-2: Don't care.	SW1-1: OFF SW1-2: Don't care. SW1-3: OFF	SW_CONFIG_1: OFF SW_CONFIG_2: OFF SW_CONFIG_3: ON SW_CONFIG_4: OFF SW_CONFIG_5: OFF SW_CONFIG_6: OFF
Carrier board	SW1: Don't care. SW2: Don't care. SW3: Don't care. SW4: Don't care. SW5: Don't care. SW6: Don't care. SW7: Don't care. SW8: Don't care. SW11-1: OFF SW11-2: OFF SW11-3: OFF SW11-4: ON CN4: Jumper connects 1-3 Jumper connects 2-4	SW1: Don't care. SW2: Don't care. SW3: Don't care. SW4: Don't care. SW5: 1-2 SW6: 1-2 SW7: 1-2 SW8: 1-2 SW11-1: OFF SW11-2: OFF SW11-3: OFF SW11-4: ON CN4: Jumper connects 1-3 Jumper connects 2-4	SW_MODE_1: OFF SW_MODE_2: ON SW_MODE_3: OFF SW_MODE_4: ON PMOD_PWR_SEL: Jumper connects 1-3

6.3.4 Operation

In the case of RZ/G2L, RZ/G2UL, after running the example, the message below is displayed on console.

```
00> Refer to readme.txt file for more details on Example Project and
00> FSP User's Manual for more information about r_rspi driver
00>
00> The project initializes RSPI driver and configures RSPI channels in Master and Slave mode.
00> After initialization, master and slave can transmit and receive data based on the commands from user.
00> Refer to the MPU User Manual for valid bit rates and corresponding clock settings.
00>
00> ** SPI INIT SUCCESSFUL **
00>
00> Select from the below Menu options
00>
00> Press 1 for Write() and Read()
00> Press 2 for WriteRead()
00> Press 3 to Exit
```

Enter "1" to run Write() and Read() example and transmission will be performed after input data from Master to Slave. Then, Slave sends back same data to Master.

```
00> Press 1 for Write() and Read()
00> Press 2 for WriteRead()
00> Press 3 to Exit
< 1
00>
00> Enter text input for Master buffer. Data size should not exceed 64 bytes.
< aaa
00>
00> MASTER SEND: aaa
00>
00> SLAVE RECEIVE: aaa
00>
00> Master transmitted user input data to Slave
00>
00> Slave transmitted the data back to Master
00>
00> Master received data: aaa
00>
00> ** SPI WRITE AND READ Demo Successful**
00>
00> Enter any other key to go back to the main menu
```

Enter "2" to run WriteRead() example. User can specify the data for Master and Slave. Transmission will be performed after inputting each data. Master received data and Slave received data will be shown on console once the transmission complete.

```
00> Select from the below Menu options
00>
00> Press 1 for Write() and Read()
00> Press 2 for WriteRead()
00> Press 3 to Exit
< 2
00>
00> Enter text input for Master buffer. Data size should not exceed 64 bytes.
< abcdefghijklmnopqrstuvwxyz012345
00>
00> Enter text input for Slave buffer. Data size should not exceed 64 bytes.
< abcdefghijklmnopqrstuvwxyz012345
00>
00> Master buffer data transmitted to Slave
00>
00> Slave buffer data transmitted to Master
00>
00> Master received data: abcdefghijklmnopqrstuvwxyz012345
00>
00> Slave received data: abcdefghijklmnopqrstuvwxyz012345
00> ** SPI WRITE_READ Demo Successful**
00>
00> Enter any other key to go back to the main menu
```

In the case of RZ/G3S, after running the example, the message below is displayed on console.

```
00> Refer to readme.txt file for more details on Example Project and
00> FSP User's Manual for more information about r_rsipi driver
00>
00> The project initializes RSPI driver and configures RSPI channel 0
00> as Master and Pmod SF3 as Slave. After initialization, master
00> can transmit and receive data based on the commands from user.
00> Refer to the MPU User Manual for valid bit rates and corresponding
00> clock settings.
00>
00> ** RSPI INIT SUCCESSFUL **
00>
00> Select from the below Menu options
00>
00> Press 1 for Write() to Pmod SF3
00> Press 2 for Read() from Pmod SF3
00> Press 3 to Exit
```

Enter "1" to run Write() to Pmod SF3 example and transmission will be performed after input data from Master to Slave.

```
Select from the below Menu options
Press 1 for Write() to Pmod SF3
Press 2 for Read() from Pmod SF3
Press 3 to Exit
1
Enter text input to write into Pmod SF3. Data size should not exceed 256 bytes.
Hello from Renesas!
Data write to Pmod SF3: Hello from Renesas!
** RSPI WRITE to Pmod SF3 Demo Successful**
Enter any other key to go back to the main menu
```

Enter "2" to run Read() from Pmod SF3 example. Reading data from Pmod SF3 will be performed and received data will be shown on console once the transmission complete.

```
Select from the below Menu options
Press 1 for Write() to Pmod SF3
Press 2 for Read() from Pmod SF3
Press 3 to Exit
2
Data read from Pmod SF3: Hello from Renesas!
** RSPI READ from Pmod SF3 Demo Successful**
```

6.3.5 Channel to be used

As mentioned in section **Error! Reference source not found.**, user can change the board in FSP Configuration. If a user changed the board kit from RZ/G2L Evaluation Board Kit to RZ/G2UL Evaluation Board Kit, the channel to be used should be changed in FSP Configuration.

The channel to be used can be confirmed on stack's property shown below.

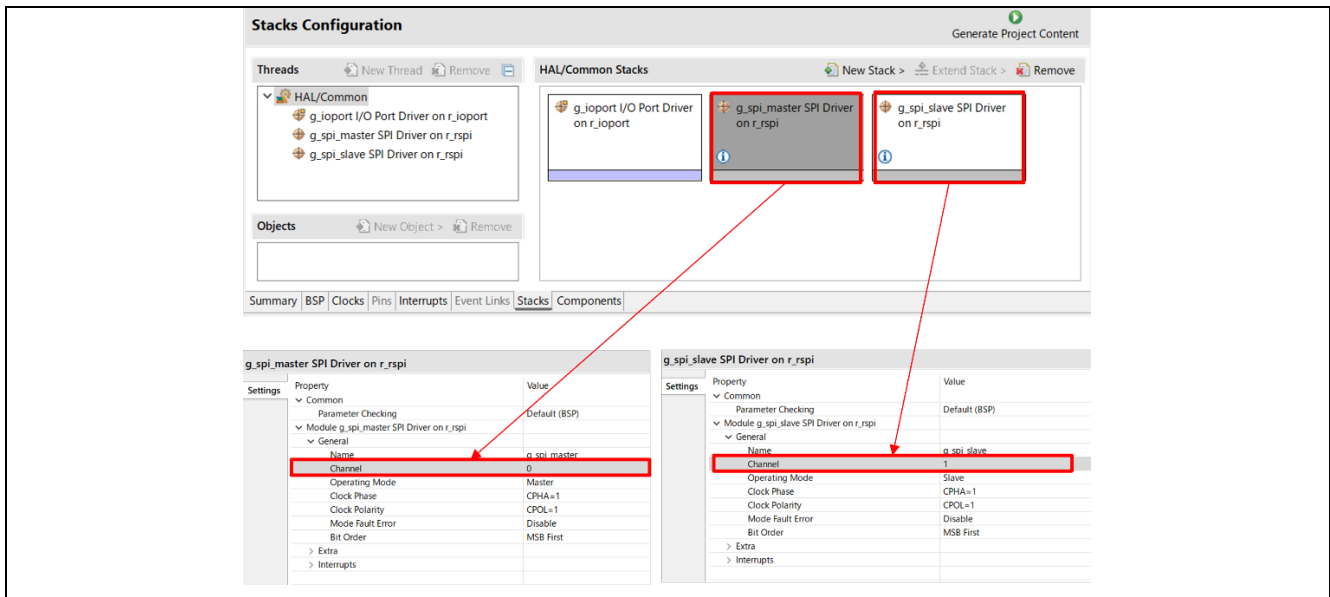

The channel to be used on each board is shown below.

RZ/G2L EVK	RZ/G2UL EVK
Master: Ch 0 Slave: Ch 1	Master: Ch 1 Slave: Ch 0

6.4 SCIF

6.4.1 Project Overview

The example project demonstrates the typical use of the UART HAL module APIs. The project initializes the UART with Baud rate of 115200 bps and GTM module. Using a Terminal Program (like Tera Term) user can provide a value & press enter key to set the period of the Pmod LED signal.

The range of input values are displayed on the JLinkRTTViewer. Any failure will also be displayed using JLinkRTTViewer. To see user input values on Serial terminal, enable local echo option.

6.4.2 Hardware Requirements

External hardware: Pmod USBUART and Pmod LED

6.4.3 Hardware Settings

Please connect each hardware as below.

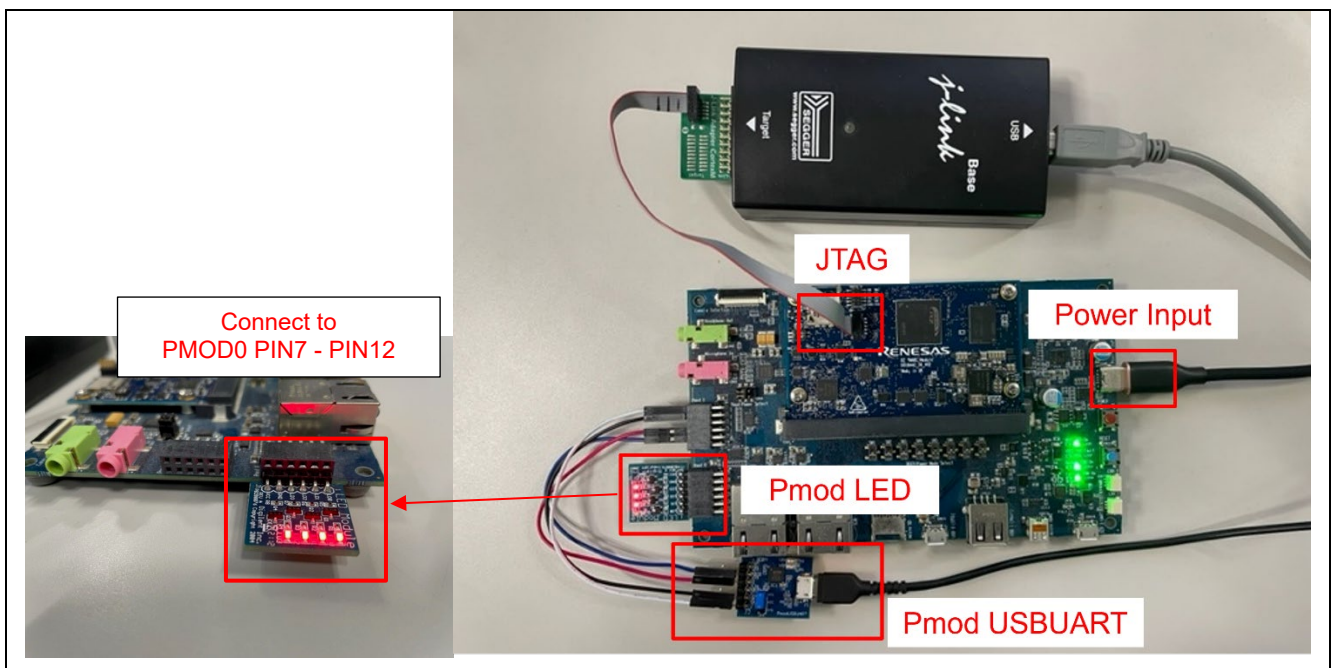

Board Setting (RZ/G2L, RZ/G2LC)

Please set the connection between Pmod USBUART and PMOD1 on the board below.

Connection of Pmod USBUART	
RXD:	Pmod USBUART J2 PIN2 – PMOD1 PIN2
TXD:	Pmod USBUART J2 PIN3 – PMOD1 PIN3
GND:	Pmod USBUART J2 PIN5 – PMOD1 PIN5
VCC:	Pmod USBUART J2 PIN6 – PMOD1 PIN6

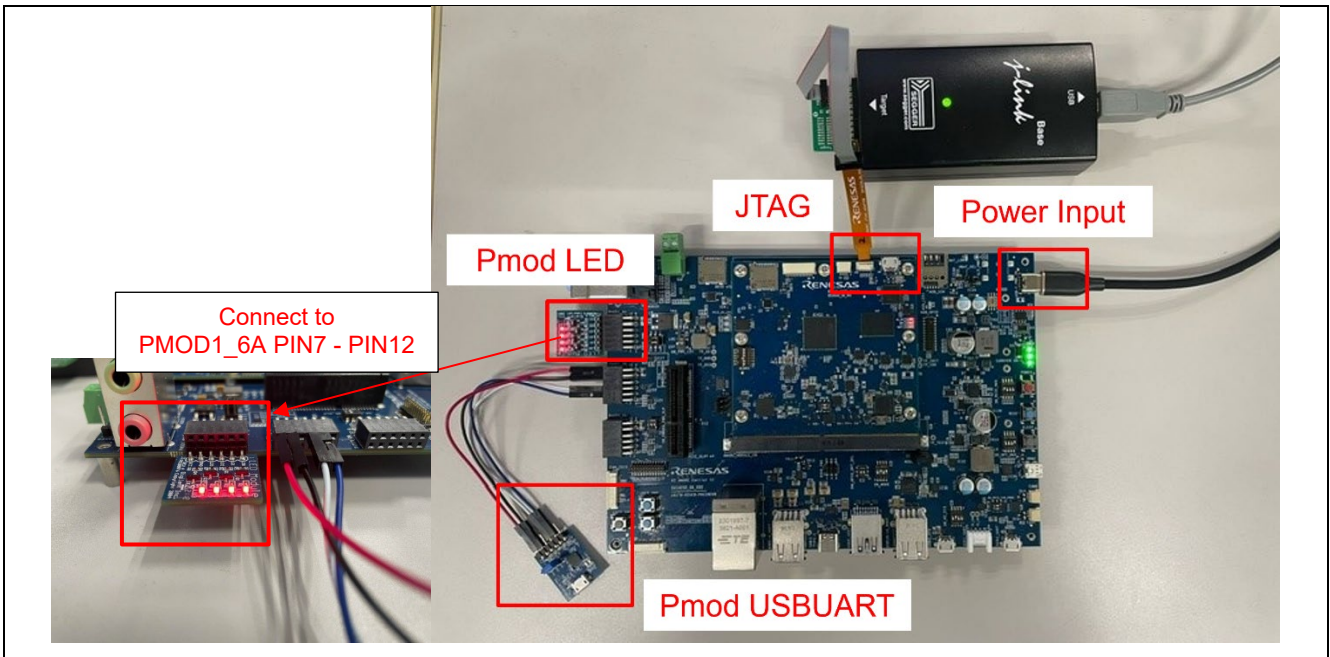

Board Setting (RZ/G3S)

Please set the connection between Pmod USBUART and PMOD1_3A on the board below.

Connection of Pmod USBUART	
RXD:	Pmod USBUART J2 PIN2 – PMOD1_3A PIN2
TXD:	Pmod USBUART J2 PIN3 – PMOD1_3A PIN3
GND:	Pmod USBUART J2 PIN5 – PMOD1_3A PIN5
VCC:	Pmod USBUART J2 PIN6 – PMOD1_3A PIN6

Please set each DIP switch and jumpers as below.

Board	RZ/G2L EVK	RZ/G2LC EVK	RZ/G3S
Module board	SW1-1: OFF SW1-2: Don't care.	SW1-1: OFF SW1-2: Don't care. SW1-3: ON SW1-4: Don't care. SW1-5: Don't care. SW1-6: Don't care.	SW_CONFIG_1: OFF SW_CONFIG_2: OFF SW_CONFIG_3: ON SW_CONFIG_4: OFF SW_CONFIG_5: OFF SW_CONFIG_6: OFF
Carrier board	SW1: Don't care. SW2: 2-3 SW3: 2-3 SW4: Don't care. SW5: Don't care. SW6: Don't care. SW7: Don't care. SW8: Don't care. SW11-1: OFF SW11-2: OFF SW11-3: OFF SW11-4: ON CN4: Jumper connects 1-3 Jumper connects 2-4		SW_MODE_1: OFF SW_MODE_2: ON SW_MODE_3: OFF SW_MODE_4: ON SW_M2_DIS_4: ON PMOD_PWR_SEL: Jumper connects 2-4 SW_OPT_MUX_4: ON

6.4.4 Operation

After running the example, the message below is displayed on console.

```
00> Refer to readme.txt file for more details on Example Project and
00> FSP User's Manual for more information about r_scif_uart driver
00>
00>
00> The project initializes the UART with baud rate of 115200 bps.
00> Open Serial Terminal with this baud rate value and
00> Provide Input ranging from 1 - 2000 to set LED Intensity
```

User can specify a value for LED blinking on Terminal Program.

```
500
Accepted value, the led is blinking with that value
Please set the next value
█
```

The configuration of Terminal Program is as below.

- Speed: 115200bps
- Data: 8bit
- Parity: None
- Stop bits: 1bit
- Flow control: None

Also, enables local echo option to see user input values on Serial terminal.

6.4.5 Channel to be used

As mentioned in section **Error! Reference source not found.**, user can change the board in FSP Configuration. If a user changed the board kit from RZ/G2L Evaluation Board Kit to RZ/G2LC Evaluation Board Kit, the channel to be used should be changed in FSP Configuration.

The channel to be used can be confirmed on stack's property shown below.

The screenshot shows the 'Stacks Configuration' interface. In the 'HAL/Common Stacks' pane, the 'g_uart UART Driver on r_scif_uart' stack is highlighted with a red box. A red arrow points from this stack to the 'Channel' property in the settings table below, which is also highlighted with a red box.

Property	Value
Common	
Parameter Checking	Default (BSP)
RS485 Flow (Driver Enable) Control Support	Disable
Module g_uart UART Driver on r_scif_uart	
General	
Name	g_uart
Channel	2
Data Bits	8bits
Parity	None
Stop Bits	1bit
> Baud	
> Flow Control	
> Extra	
> Interrupts	

The channel to be used on each board is shown as below.

RZ/G2L EVK	RZ/G2LC EVK
Ch 2	Ch 1

6.5 GPT (Input Capture)

6.5.1 Project Overview

The Example Project demonstrates the functionality of GPT Input capture module. GPT4 is used to generate periodic pulses of 500msec duration and provided as input to GPT3 used as Input capture.

GPT3 counts the event pulse received at its input. Based on the period and capture event, the time period of pulse is calculated and displayed on RTTViewer.

6.5.2 Hardware Requirements

External hardware: None

6.5.3 Hardware Settings

Please connect each hardware as below.

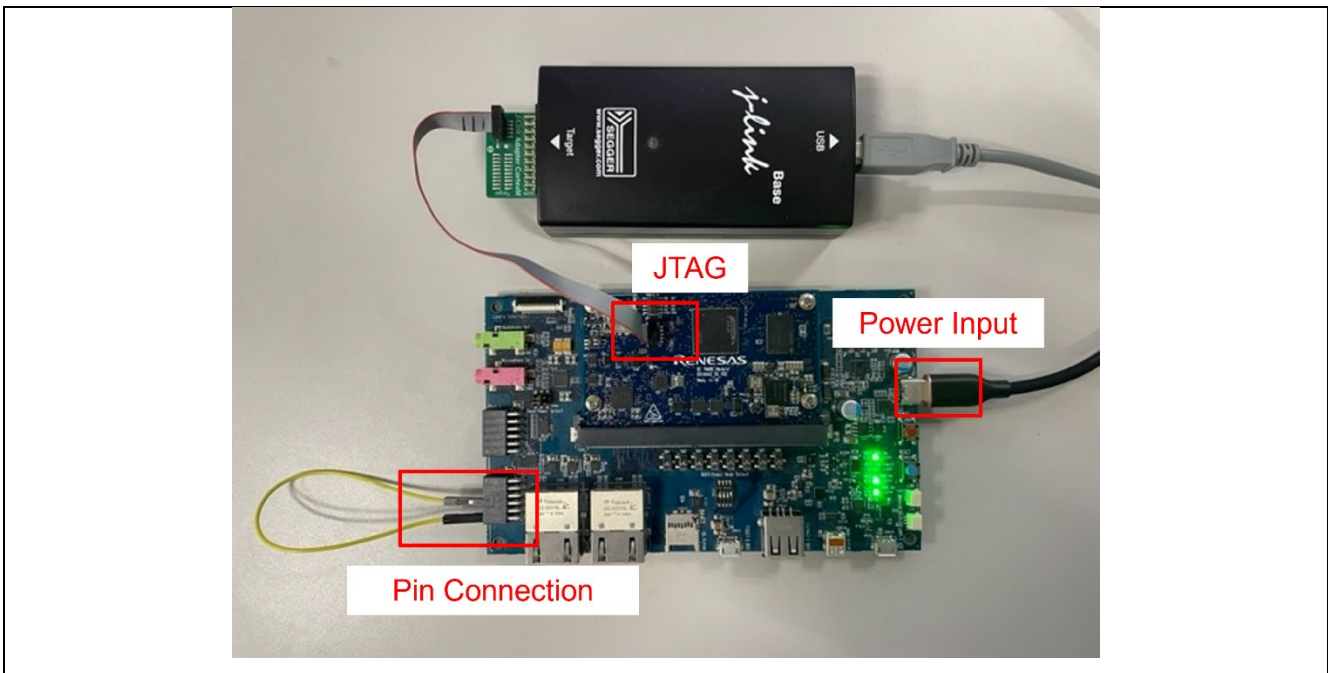

Board Setting (RZ/G2L, RZ/G2LC)

Please set the Pin Connection as below.

RZ/G2L EVK	RZ/G2LC EVK
PMOD0 PIN7 - PMOD0 PIN9	PMOD0 PIN7 – PMOD1 PIN1

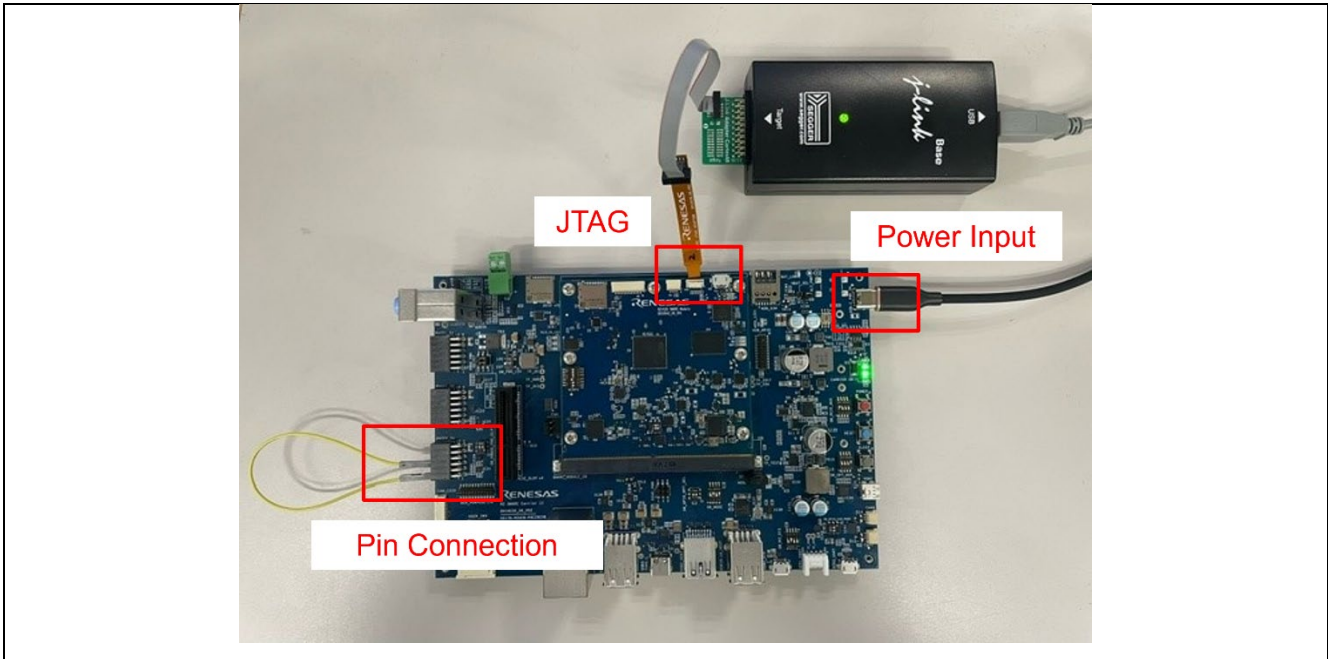

Board Setting (RZ/G3S)

Please set the Pin Connection as below.

RZ/G3S EVK
PMOD0_2A PIN7 - PMOD0_2A PIN9

Please set each DIP switch and jumpers as below.

Board	RZ/G2L EVK	RZ/G2LC EVK	RZ/G3S EVK
Module board	SW1-1: OFF SW1-2: Don't care.	SW1-1: OFF SW1-2: Don't care. SW1-3: Don't care. SW1-4: Don't care. SW1-5: Don't care. SW1-6: Don't care.	SW_CONFIG_1: OFF SW_CONFIG_2: OFF SW_CONFIG_3: ON SW_CONFIG_4: OFF SW_CONFIG_5: OFF SW_CONFIG_6: OFF
Carrier board	SW1: Don't care. SW2: Don't care. SW3: Don't care. SW4: Don't care. SW5: Don't care. SW6: Don't care. SW7: Don't care. SW8: Don't care. SW11-1: OFF SW11-2: OFF SW11-3: OFF SW11-4: ON CN4: Jumper connects 1-3 Jumper connects 2-4	SW1: 2-3 SW2: Don't care. SW3: Don't care. SW4: Don't care. SW5: Don't care. SW6: Don't care. SW7: Don't care. SW8: Don't care. SW11-1: OFF SW11-2: OFF SW11-3: OFF SW11-4: ON CN4: Jumper connects 1-3 Jumper connects 2-4	SW_MODE_1: OFF SW_MODE_2: ON SW_MODE_3: OFF SW_MODE_4: ON SW_PMOD0_PWR_SLP_1: Short 3-2 PMOD_PWR_SELECT: Jumper connects 1-3

6.5.4 Operation

After running the example, the message below is displayed on console.

```
00> Refer to readme.txt file for more details on Example Project and
00> FSP User's Manual for more information about r_gpt driver
00>
00> The EP demonstrates the functionality of GPT Input capture module.
00> GPT4 is used to generate periodic pulses of 500msec duration and
00> provided as input to GPT Input capture(GPT3).GPT3 counts the event
00> pulse received at its input. Based on the period and capture event,
00> the time period of pulse is calculated and displayed on RTTViewer.
00>
00> Pulse width measurement value(in second) - 0.25000
00>
00> Pulse width measurement value(in second) - 0.25000
00>
00> Pulse width measurement value(in second) - 0.25000
00>
00> Pulse width measurement value(in second) - 0.25000
00>
00> Pulse width measurement value(in second) - 0.25000
00>
00> Pulse width measurement value(in second) - 0.25000
00>
00> Pulse width measurement value(in second) - 0.25000
00>
00> Pulse width measurement value(in second) - 0.25000
00>
```

6.6 GPT (PWM)

6.6.1 Project Overview

The example project demonstrates typical use of GPT HAL module APIs. Users have the provision to input value as per displayed menu through JLinkRTTViewer to select different GPT supported modes (Periodic, PWM, One-Shot).

In periodic mode, the user can enter the period within the permitted ranges to change the frequency of the user Pmod LED. In PWM mode, the user can enter the duty cycle within the specified range to adjust the intensity of the user Pmod LED. In One-Shot mode, output will be displayed on JlinkRTTViewer.

Any failure will also be displayed on JlinkRTTViewer.

6.6.2 Hardware Requirements

External hardware: Pmod LED

6.6.3 Hardware Settings

Please connect each hardware as below.

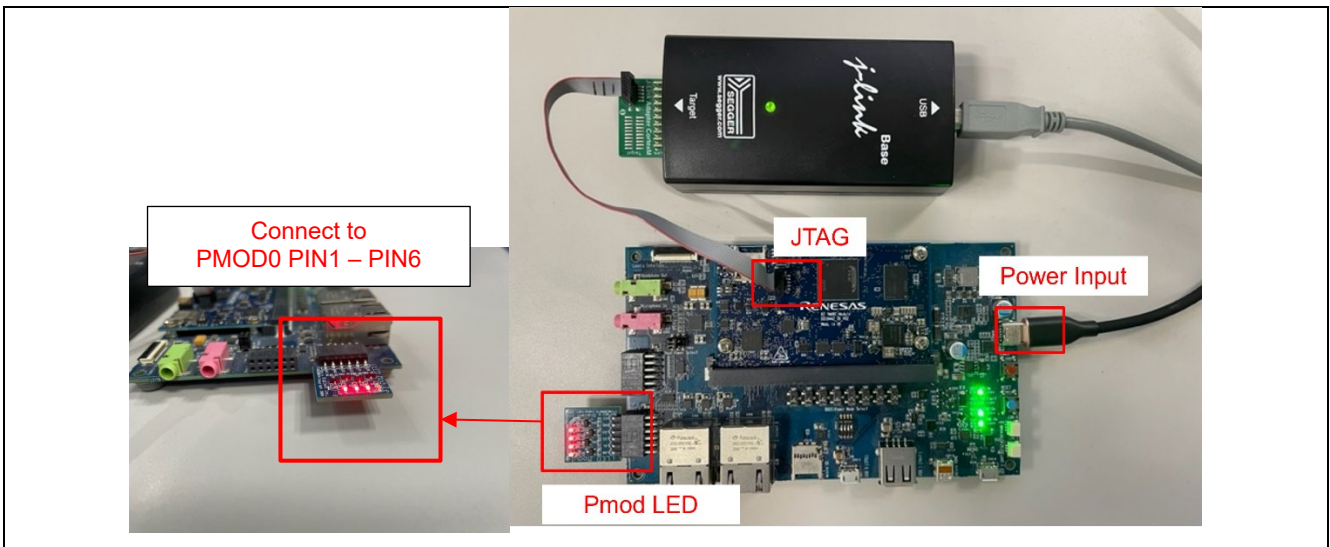

Board Setting (RZ/G2L, RZ/G2LC)

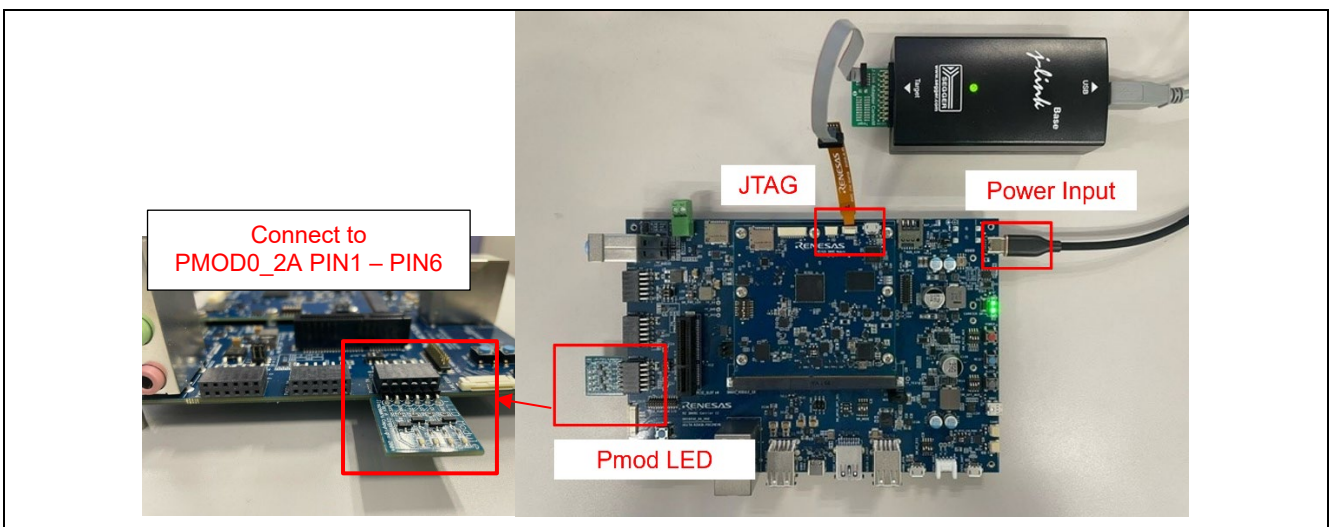

Board Setting (RZ/G3S)

Please set each DIP switch and jumpers as below.

Board	RZ/G2L EVK	RZ/G2LC EVK	RZ/G3S EVK
Module board	SW1-1: OFF SW1-2: Don't care.	SW1-1: OFF SW1-2: Don't care. SW1-3: Don't care. SW1-4: ON SW1-5: Don't care. SW1-6: Don't care.	SW_CONFIG_1: OFF SW_CONFIG_2: OFF SW_CONFIG_3: ON SW_CONFIG_4: OFF SW_CONFIG_5: OFF SW_CONFIG_6: OFF
Carrier board	SW1: Don't care. SW2: Don't care. SW3: Don't care. SW4: Don't care. SW5: Don't care. SW6: Don't care. SW7: Don't care. SW8: Don't care. SW11-1: OFF SW11-2: OFF SW11-3: OFF SW11-4: ON CN4: Jumper connects 1-3 Jumper connects 2-4		SW_MODE_1: OFF SW_MODE_2: ON SW_MODE_3: OFF SW_MODE_4: ON PMOD_PWR_SEL: Jumper connects 1-3

6.6.4 Operation

After running the example, the message below is displayed on console.

```
00> Refer to readme.txt file for more details on Example Project and
00> FSP User's Manual for more information about r_gpt driver
00>
00> The project initializes GPT module in Periodic, PWM or One-shot mode based on user input from the displayed menu options.
00> In periodic mode, user can enter the time period within the permitted ranges to change the frequency of the user LED.
00> In PWM mode, user can enter the duty cycle within the specified range to adjust the intensity of the user LED.
00> In ONE SHOT mode, Output will be displayed on JlinkRTTViewer when timer expires.
00>
00> Menu Options
00> 1. Enter 1 for Periodic mode
00> 2. Enter 2 for PWM mode
00> 3. Enter 3 for one shot mode
00> User Input:
```

In periodic mode, the user can enter period of the timer, then LED starts blink.

```
00> Menu Options
00> 1. Enter 1 for Periodic mode
00> 2. Enter 2 for PWM mode
00> 3. Enter 3 for one shot mode
00> User Input:
< 1
00>
00> Enter the desired period in millisecond
< 500
00> Opened Timer in Periodic Mode
00> Started Timer in Periodic Mode
```

In periodic mode, the user can enter the duty cycle, then LED starts blink.

```
00> Menu Options
00> 1. Enter 1 for Periodic mode
00> 2. Enter 2 for PWM mode
00> 3. Enter 3 for one shot mode
00> User Input:
  < 2
00> Periodic Timer Instance Closed, Start PWM Timer Instance
00>
00> Enter The Desired Duty Cycle in Percentage of Range 0 - 100:
  < 30
00> Opened Timer in PWM Mode
00> Started Timer in PWM Mode
00>
```

In One-Shot mode, One-shot timer is started after selecting this mode.

```
00> Menu Options
00> 1. Enter 1 for Periodic mode
00> 2. Enter 2 for PWM mode
00> 3. Enter 3 for one shot mode
00> User Input:
  < 3
00> PWM Timer Instance Closed, Start ONE-SHOT Timer Instance
00> Opened Timer in ONE-SHOT Mode
00> Started Timer in ONE-SHOT Mode
00>
00> Timer Expired in One-Shot Mode
00>
```

6.7 GTM

6.7.1 Project Overview

This Example Project demonstrates the functionality of GTM in periodic mode and one-shot mode. On providing any input on the RTTviewer, GTM channel 2 starts in one-shot mode. GTM channel 1 starts in periodic mode when GTM channel 2 expires. Timer in periodic mode expires periodically at a time period specified by user and toggles the LED0 on Pmod LED.

6.7.2 Hardware Requirements

External hardware: Pmod LED

6.7.3 Hardware Settings

Please connect each hardware as below.

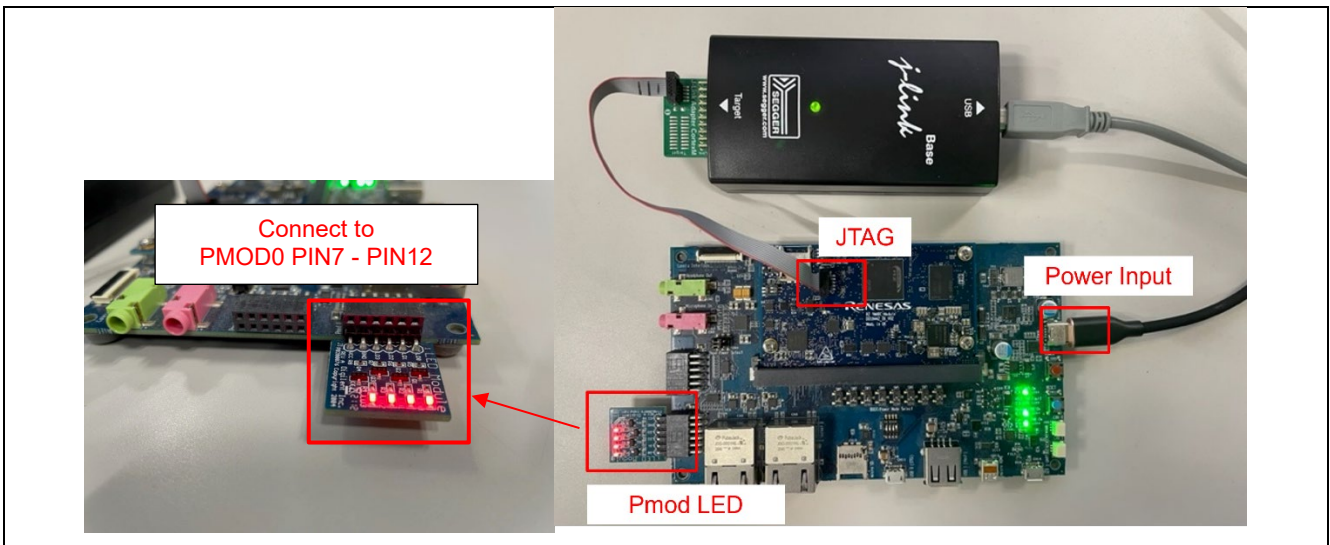

Board Setting (RZ/G2L, RZ/G2LC, RZ/G2UL)

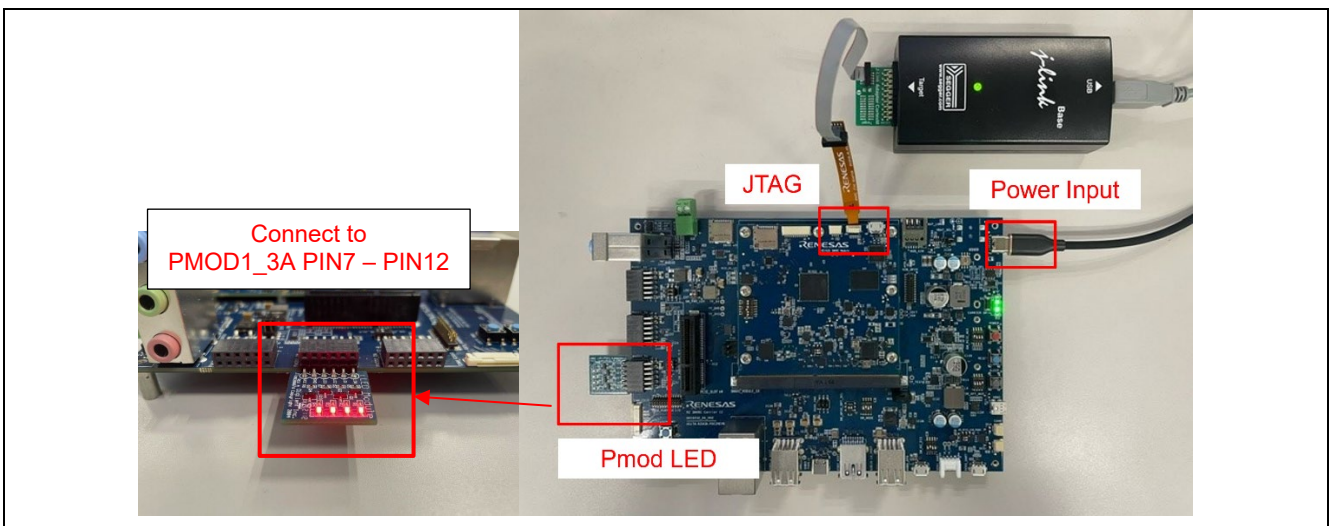

Board Setting (RZ/G3S)

Please set each DIP switch and jumpers as below.

Board	RZ/G2L EVK	RZ/G2LC EVK	RZ/G2UL EVK	RZ/G3S EVK
Module board	SW1-1: OFF SW1-2: Don't care.	SW1-1: OFF SW1-2: Don't care. SW1-3: Don't care. SW1-4: Don't care. SW1-5: Don't care. SW1-6: Don't care.	SW1-1: OFF SW1-2: Don't care. SW1-3: Don't care.	SW_CONFIG_1: OFF SW_CONFIG_2: OFF SW_CONFIG_3: ON SW_CONFIG_4: OFF SW_CONFIG_5: OFF SW_CONFIG_6: OFF
Carrier board	SW1: Don't care. SW2: Don't care. SW3: Don't care. SW4: Don't care. SW5: Don't care. SW6: Don't care. SW7: Don't care. SW8: Don't care. SW11-1: OFF SW11-2: OFF SW11-3: OFF SW11-4: ON CN4: Jumper connects 1-3 Jumper connects 2-4			SW_MODE_1: OFF SW_MODE_2: ON SW_MODE_3: OFF SW_MODE_4: ON SW_M2_DIS_4: ON PMOD_PWR_SEL: Jumper connects 2-4

6.7.4 Operation

After running the example, the message below is displayed on console. Users can input the period for One-shot mode and Periodic mode.

```

00> This Example Project demonstrates the functionality of GTM in periodic mode and one-shot mode.
00> On providing any input on the RTTviewer, GTM channel 2 starts in one-shot mode. GTM channel 1
00> starts in periodic mode when GTM channel 2 expires. Timer in periodic mode expires periodically
00> at a time period specified by user and toggles the Pmod0 pin 7 LED.
00>
00> Please enter time period values for one-shot and periodic mode timers in milliseconds
00> Valid range: 1 to 2000
00>
00> One-shot mode:
00> < 1000
00>
00> Time period for one-shot mode timer: 1000
00>
00> Periodic mode:
00> < 1000
00>
00> Time period for periodic mode timer: 1000
00>
00> Enter any key to start or stop the timers
00> <
00>
00> GTM2 is Enabled in OneShot mode
00>
00> One-shot mode GTM timer elapsed
00>
00> GTM1 is Enabled in Periodic mode
00> LED will toggle for set time period
00> Enter any key to stop timers

```

6.8 FreeRTOS

6.8.1 Project Overview

The example projects demonstrate Message Queue and Semaphore between tasks and interrupt. Message Queue is demonstrated between Tasks and between Task and interrupt. GTM timer periodically generates interrupt at 1000msec. For the first few seconds, messages are shared between Sender and Receiver Tasks and GTM ISR0. Receiver task pends on Message Queue, receives and displays message received on RTTViewer periodically at 500msec. For the next few seconds, Semaphore Task waits for semaphore until it is released by GTM ISR1. GTM ISR1 releases semaphore periodically at 1000msec.

All the tasks run with equal priority level.

6.8.2 Hardware Requirements

External hardware: None

6.8.3 Hardware Settings

Please connect each hardware as below.

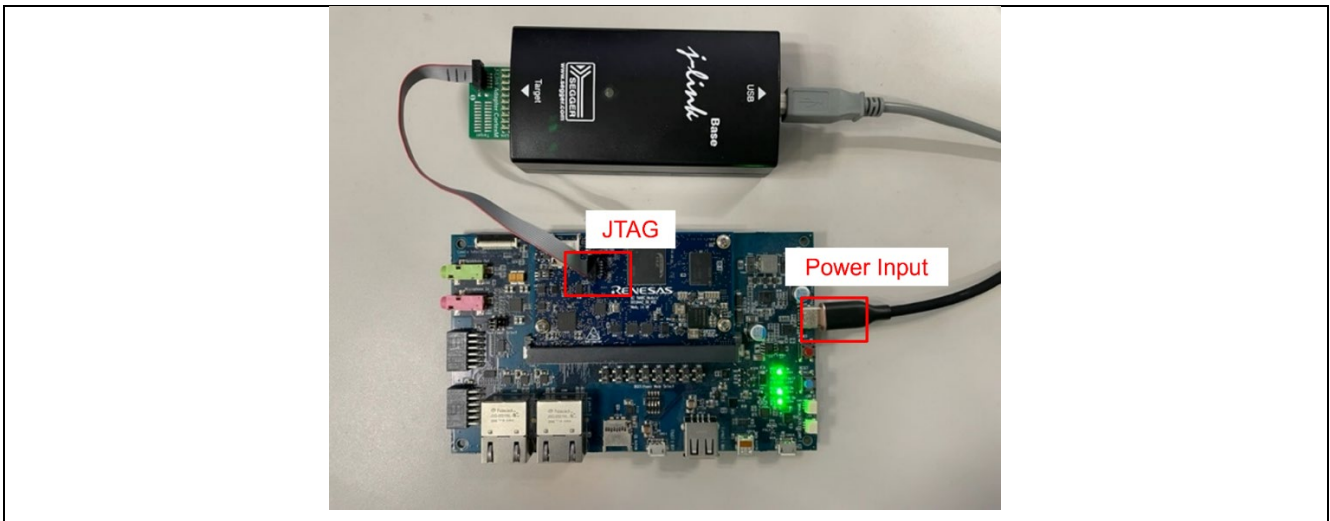

Board Setting (RZ/G2L, RZ/G2LC, RZ/G2UL)

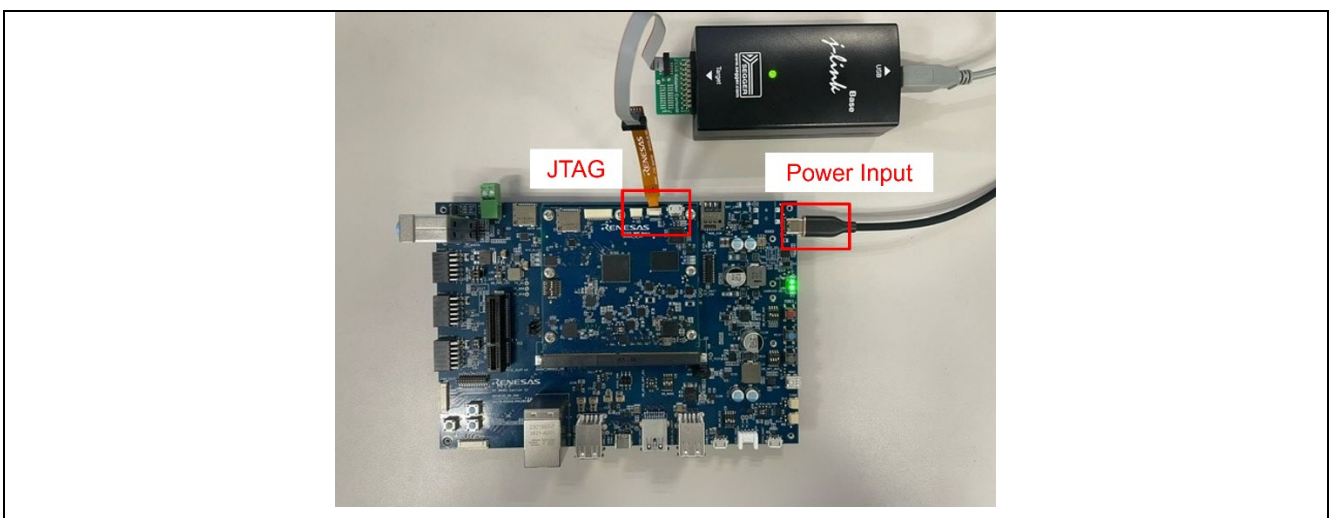

Board Setting (RZ/G3S)

Please set each DIP switch and jumpers as below.

Board	RZ/G2L EVK	RZ/G2LC EVK	RZ/G2UL EVK	RZ/G3S EVK
Module board	SW1-1: OFF SW1-2: Don't care.	SW1-1: OFF SW1-2: Don't care. SW1-3: Don't care. SW1-4: Don't care. SW1-5: Don't care. SW1-6: Don't care.	SW1-1: OFF SW1-2: Don't care. SW1-3: Don't care.	SW_CONFIG_1: OFF SW_CONFIG_2: OFF SW_CONFIG_3: ON SW_CONFIG_4: OFF SW_CONFIG_5: OFF SW_CONFIG_6: OFF
Carrier board	SW1: Don't care. SW2: Don't care. SW3: Don't care. SW4: Don't care. SW5: Don't care. SW6: Don't care. SW7: Don't care. SW8: Don't care. SW11-1: OFF SW11-2: OFF SW11-3: OFF SW11-4: ON CN4: Jumper connects 1-3 Jumper connects 2-4			SW_MODE_1: OFF SW_MODE_2: ON SW_MODE_3: OFF SW_MODE_4: ON PMD_PWR_SELECT: Jumper connects 1-3 Jumper connects 2-4

6.8.4 Operation

After running the example, the message below is displayed on console.

```

00> Messages are shared between Sender_Task, ISR and Receiver_Task for the first few seconds.
00> Later, Sender and Receiver Tasks will be suspended timer will be stopped. Semaphore is acquired
00> and released between Semaphore Task and ISR for the next few seconds and Semaphore Task is suspended.
00> To restart the application, power cycle the board.
00>
00> Sender_Task : Starting g_periodic_timer_msgq timer
00> GTM Timer Started successfully
00>
00> Sender_Task : Message posted on Queue successfully
00> Sender_Task : Going on delay for 500ms
00> Receiver Task : Message received Successfully
00> Data : 100
00> Sender : Sender_Task
00>
00> Sender_Task : After delay of 500ms
00>
00> Sender_Task : Message posted on Queue successfully
00> Sender_Task : Going on delay for 500ms
00> Receiver Task : Message received Successfully
00> Data : 100
00> Sender : Sender_Task
00>
00> Sender_Task : After delay of 500ms
00>
00> Sender_Task : Message posted on Queue successfully
00> Sender_Task : Going on delay for 500ms
00> Receiver Task : Message received Successfully
00> Data : 100
00> Sender : Sender_Task
00>
00> Receiver Task : Message received Successfully
00> Data : 200
00> Sender : GTM Callback
00>
00> Sender_Task : After delay of 500ms
00>
00> Sender_Task : Message posted on Queue successfully
00> Sender_Task : Going on delay for 500ms
00> Receiver Task : Message received Successfully
00> Data : 100
00> Sender : Sender_Task
00>
00> Sender_Task : After delay of 500ms
    
```

6.9 INTC_IRQ

6.9.1 Project Overview

The example project demonstrates the typical use of the INTC IRQ module APIs. The project initializes the IRQ interrupt in Interrupt Controller. User is requested to press the push button to trigger the external IRQ and this then will start toggling of user LED.

6.9.2 Hardware Requirements

External hardware: Pmod BUTTON and Pmod LED

6.9.3 Hardware Settings

Please connect each hardware as below.

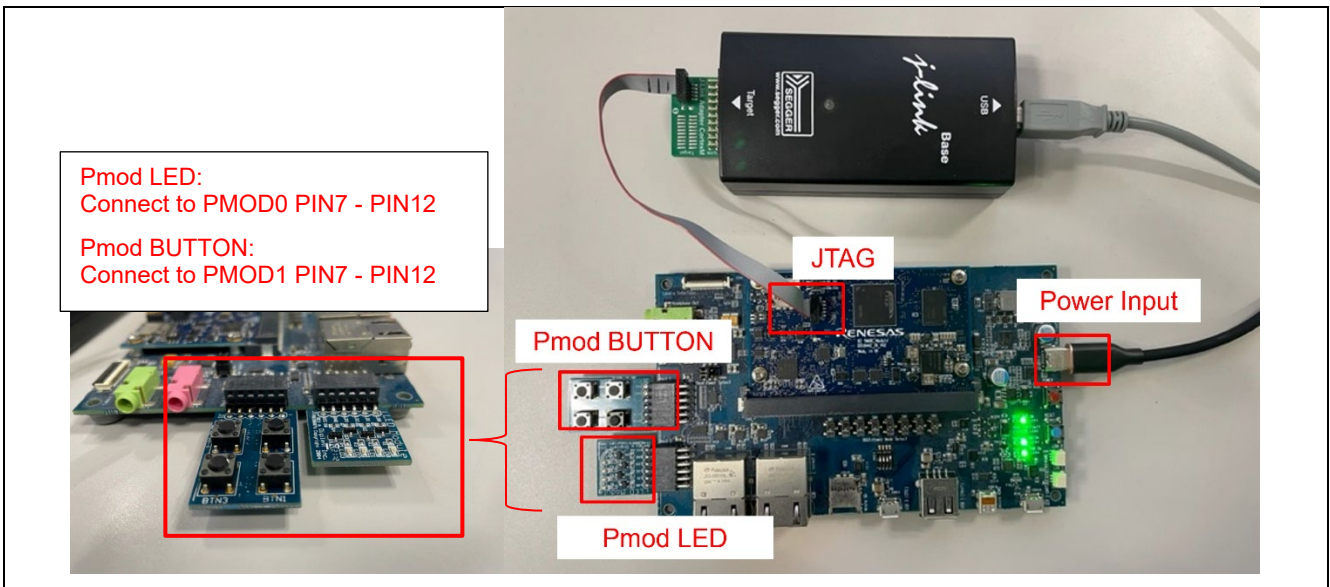

Board Setting (RZ/G2L, RZ/G2LC, RZ/G2UL)

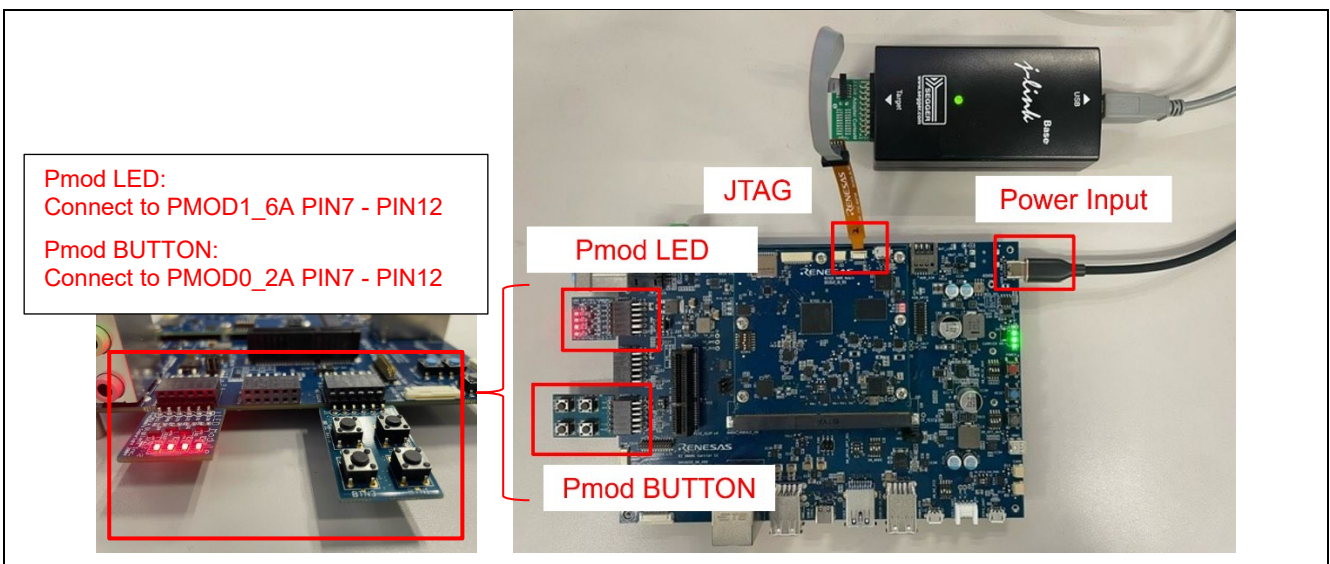

Board Setting (RZ/G3S)

Please set each DIP switches and jumpers as below.

Board	RZ/G2L EVK	RZ/G2LC EVK	RZ/G2UL EVK	RZ/G3S EVK
Module board	SW1-1: OFF SW1-2: Don't care.	SW1-1: OFF SW1-2: Don't care. SW1-3: Don't care. SW1-4: Don't care. SW1-5: Don't care. SW1-6: Don't care.	SW1-1: OFF SW1-2: Don't care. SW1-3: OFF	SW_CONFIG_1: OFF SW_CONFIG_2: OFF SW_CONFIG_3: ON SW_CONFIG_4: OFF SW_CONFIG_5: OFF SW_CONFIG_6: OFF
Carrier board	SW1: Don't care. SW2: Don't care. SW3: Don't care. SW4: Don't care. SW5: 3-2 SW6: Don't care. SW7: Don't care. SW8: Don't care. SW11-1: OFF SW11-2: OFF SW11-3: OFF SW11-4: ON CN4: Jumper connects 1-3 Jumper connects 2-4			SW_MODE_1: OFF SW_MODE_2: ON SW_MODE_3: OFF SW_MODE_4: ON SW_M2_DIS_4: ON PMOD_PWR_SELECT: Jumper connects 1-3 Jumper connects 2-4

6.9.4 Operation

After running the example, the message below is displayed on console. LED ON/OFF status is displayed when pressing the button (RZ/G3S: BTN3, others: BTN0) of Pmod BUTTON.

```
00> Refer to readme.txt file for more details on Example Project and
00> FSP User's Manual for more information about r_intc_irq driver
00>
00> This Example Project demonstrates the functionality of INTC_IRQ driver.
00> On pressing the user push button, an external IRQ is triggered, which toggles on-board LED.
00>
00> User Pushbutton Pressed
00> LED State: High{ON}
00>
00> User Pushbutton Pressed
00> LED State: Low{OFF}
```

6.9.5 Channel to be used

As mentioned in section **Error! Reference source not found.**, user can change the board in FSP Configuration. If user changed the board kit from RZ/G2L Evaluation Board Kit to RZ/G2LC Evaluation Board Kit or RZ/G2UL Evaluation Board Kit, the channel to be used should be changed in FSP Configuration.

The channel to be used can be confirmed on stack's property shown below.

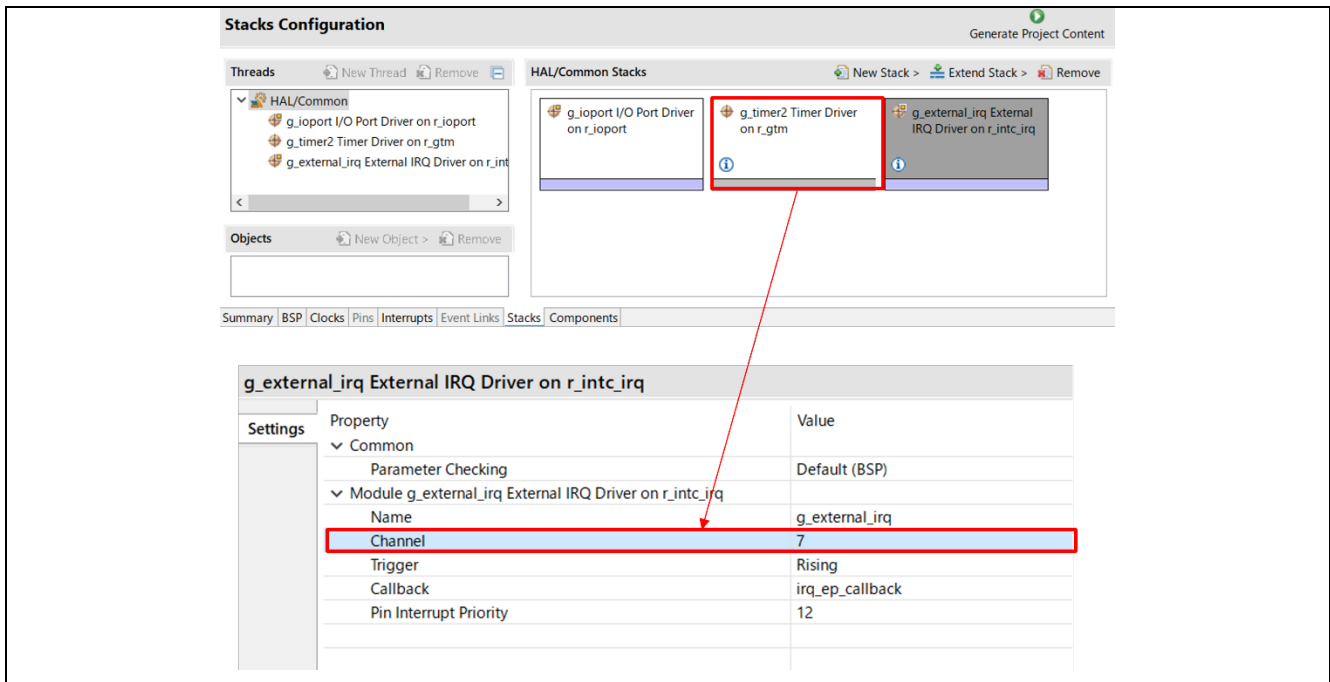

The channel to be used on each board is shown below.

RZ/G2L EVK	RZ/G2LC EVK	RZ/G2UL EVK
Ch 7	Ch 7	Ch 2

6.10 WDT

6.10.1 Project Overview

The example project demonstrates the use of WDT module with the collaboration of module IRQ, GTM, WDT and button/led. The operation of this example is as below:

- Start GTM timer having a callback every 1 second, to refresh WDT and blink the led (LD2 on Pmod LED).
- If the button BTN3 (on Pmod BUTTON) is pressed, IRQ is triggered to stop GTM timer, and after 2 seconds, WDT will reset MPU.

As mentioned, this WDT example is only supported for RZ/G3S.

6.10.2 Hardware Requirements

External hardware: Pmod BUTTON and Pmod LED

6.10.3 Hardware Settings

Please connect each hardware as below.

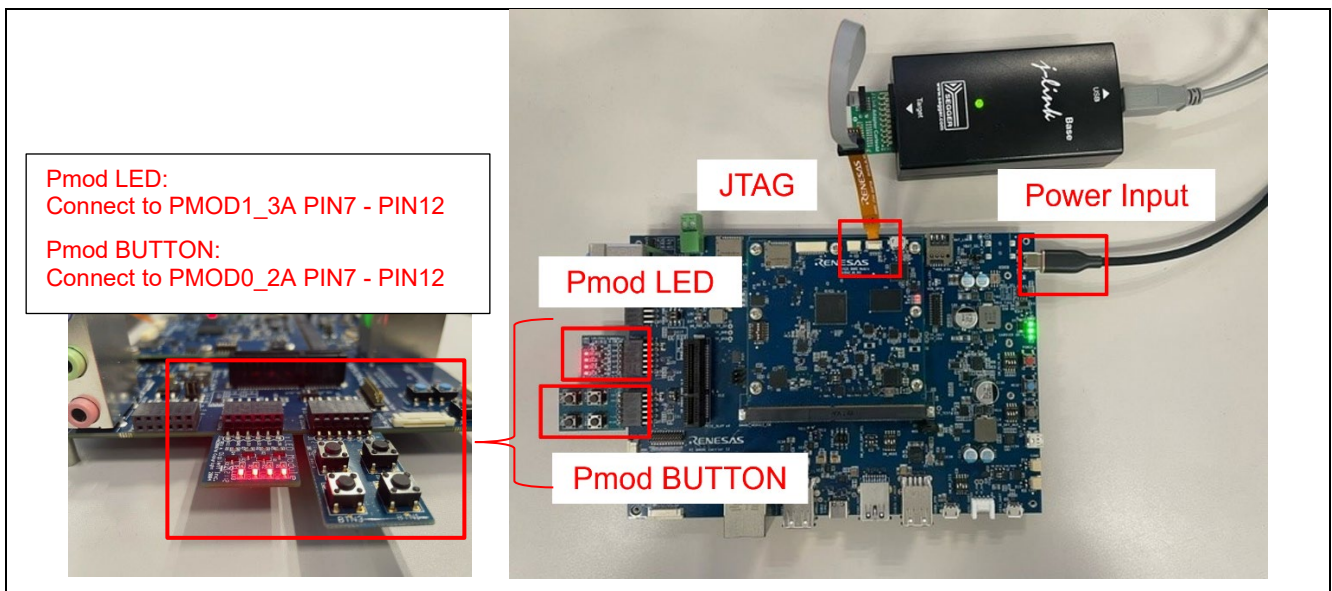

Board Setting (RZ/G3S)

Please set each DIP switch and jumpers as below.

Board	RZ/G3S EVK	
Module board	SW_CONFIG_1: OFF SW_CONFIG_2: OFF SW_CONFIG_3: ON SW_CONFIG_4: OFF SW_CONFIG_5: OFF SW_CONFIG_6: OFF	
Carrier board	SW_PMOD0_PWR_SLP: 5-6 PMOD_PWR_SEL: Jumper connects 1-3 Jumper connects 2-4	
	#Boot mode 2# (Note) SW_MODE_1: OFF SW_MODE_2: OFF SW_MODE_3: OFF SW_MODE_4: ON	#Boot mode 3# (Note) SW_MODE_1: OFF SW_MODE_2: ON SW_MODE_3: OFF SW_MODE_4: ON

Note: Need to switch the Boot mode to run this example. Please refer section 6.10.4 for the detail.

6.10.4 Preparation

As background, this WDT example should be written to flash ROM which is different from others. The reason is that MPU will reset by WDT. Therefore, please follow the steps to write sample program binary files.

1. Set the board to #boot mode 3#, download Flash Writer to RAM and write the Bootloader. See [Linux Start-up Guide for RZ/G3S Board Support Package v1.0.0 \(renesas.com\)](#) for details in chapter 4.2, 4.3 and 4.4 (from page 20 to 28). The image of Flash Writer (FlashWriter-smarc-rzg3s.mot) and files of Bootloader (bl2_bp_spi-smarc-rzg3s.srec and fip-smarc-rzg3s.srec) are prepared at flash_boot folder in this project.
2. After writing two Bootloader files normally, program wdt_rzg3s_evk_ep.srec using Flash Writer with the parameter stated below:

Address to load to RAM	Address to save to ROM
23000	200000

The log below is shown on the terminal.

```
>xls2
===== Qspi writing of RZ/G2 Board Command =====
Load Program to Spiflash
Writes to any of SPI address.
Program size & Qspi Save Address
===== Please Input Program Top Address =====
Please Input : H'23000
===== Please Input Qspi Save Address =====
Please Input : H'200000
please send ! ('!' & CR stop load)
```

3. Send "wdt_rzg3s_evk_ep.srec" from terminal software after the message "please send!" is shown.
4. After successfully downloading the binary, messages like below are shown on the terminal.

```
Erase SPI Flash memory...
Erase Completed
Write to SPI Flash memory.
===== Qspi Save Information =====
SpiFlashMemory Stat Address : H'00200000
SpiFlashMemory End Address : H'00203DF2
=====
```

5. After writing above files normally, turn off the power of the board and switch to #boot mode 2# by changing the SW_MODE. When power-on the board again, Trusted Firmware-A (TF-A) will start first, and TF-A will then launch the WDT example program.

6.10.5 Operation

When J-Link is connected to the board, the message below is displayed on console. After inputting "1" to initial WDT and start GTM timer, the GTM timer will refresh WDT counter and blink the LED2 of Pmod LED. When pressing the BTN3 of Pmod BUTTON, IRQ is triggered to stop GTM timer, and after 2 seconds, WDT will reset MPU. At the same time, the WDT Reset will be detected in the next launch.

```

00> Refer to readme.txt file for more details on Example Project and
00> FSP User's Manual for more information about r_wdt driver
00>
00> This example project demonstrates the typical use of the WDT HAL module APIs.
00> User input initializes the WDT and start GTM timer.
00> WDT counter is refreshed periodically every 1 second when the GTM timer expires.
00> And WDT refresh message will be printed out every three refreshes.
00> On pressing the Push button, WDT counter stops from refreshing.
00> WDT resets the MPU in 2 seconds.
00>
00> Enter 1 to Enable WDT
00>
00> User Input:
< 1
00> WDT initialized, GTM Timer Started
00> To stop WDT counter from refreshing, press the push button
00> WDT counter has been refreshed three times.
00> Push button is pressed.
00> GTM timer stopped.
00>
00> *****
00> * Renesas FSP Example Project for r_wdt Module *
00> * Example Project Version 2.0 *
00> * Flex Software Pack Version 2.0.0 *
00> *****
00> Refer to readme.txt file for more details on Example Project and
00> FSP User's Manual for more information about r_wdt driver
00>
00> This example project demonstrates the typical use of the WDT HAL module APIs.
00> User input initializes the WDT and start GTM timer.
00> WDT counter is refreshed periodically every 1 second when the GTM timer expires.
00> And WDT refresh message will be printed out every three refreshes.
00> On pressing the Push button, WDT counter stops from refreshing.
00> WDT resets the MPU in 2 seconds.
00>
00> ***** WDT Reset detected *****
00>
00> Enter 1 to Enable WDT
00>
00> User Input:

```

7. References

FSP GitHub:	github.com/renesas/rzg-fsp
FSP User Manual:	renesas.github.io/rzg-fsp/
Getting Started Guide	Getting Started with RZ/G Flexible Software Package V2.0.0 (renesas.com)
FSP Example Projects:	RZ/G Multi-OS Package Renesas
Evaluation Kit Manual:	SMARC EVK of RZ/G2L, RZ/G2LC, RZ/G2UL, RZ/V2L, and RZ/Five Start-up Guide Rev.1.03 (renesas.com)
Linux Start-up Guide:	SMARC EVK of RZ/G3S Linux Start-up Guide
Knowledge Base:	Knowledge Base (renesas.com)
Renesas Support:	RZ/G2L Support (renesas.com) RZ/G2LC Support (renesas.com) RZ/G2UL Support (renesas.com) RZ/G3S Support (renesas.com)

Revision History

Rev.	Date	Description	
		Page	Summary
2.00	Feb.29.24	1	Added support for RZ/G3S.
		4, 8	Updated the description and figure based on the latest development environment.
		13, 14	Added description how to update the pin configuration in the case of changing the target board.
		17 to 48	Added description for RZ/G3S EVK environment.
1.00	Nov.27.23	–	First release document.

General Precautions in the Handling of Microprocessing Unit and Microcontroller Unit Products

The following usage notes are applicable to all Microprocessing unit and Microcontroller unit products from Renesas. For detailed usage notes on the products covered by this document, refer to the relevant sections of the document as well as any technical updates that have been issued for the products.

1. Precaution against Electrostatic Discharge (ESD)

A strong electrical field, when exposed to a CMOS device, can cause destruction of the gate oxide and ultimately degrade the device operation. Steps must be taken to stop the generation of static electricity as much as possible, and quickly dissipate it when it occurs. Environmental control must be adequate. When it is dry, a humidifier should be used. This is recommended to avoid using insulators that can easily build up static electricity.

Semiconductor devices must be stored and transported in an anti-static container, static shielding bag or conductive material. All test and measurement tools including work benches and floors must be grounded. The operator must also be grounded using a wrist strap. Semiconductor devices must not be touched with bare hands. Similar precautions must be taken for printed circuit boards with mounted semiconductor devices.

2. Processing at power-on

The state of the product is undefined at the time when power is supplied. The states of internal circuits in the LSI are indeterminate and the states of register settings and pins are undefined at the time when power is supplied. In a finished product where the reset signal is applied to the external reset pin, the states of pins are not guaranteed from the time when power is supplied until the reset process is completed. In a similar way, the states of pins in a product that is reset by an on-chip power-on reset function are not guaranteed from the time when power is supplied until the power reaches the level at which resetting is specified.

3. Input of signal during power-off state

Do not input signals or an I/O pull-up power supply while the device is powered off. The current injection that results from input of such a signal or I/O pull-up power supply may cause malfunction and the abnormal current that passes in the device at this time may cause degradation of internal elements. Follow the guideline for input signal during power-off state as described in your product documentation.

4. Handling of unused pins

Handle unused pins in accordance with the directions given under handling of unused pins in the manual. The input pins of CMOS products are generally in the high-impedance state. In operation with an unused pin in the open-circuit state, extra electromagnetic noise is induced in the vicinity of the LSI, an associated shoot-through current flows internally, and malfunctions occur due to the false recognition of the pin state as an input signal become possible.

5. Clock signals

After applying a reset, only release the reset line after the operating clock signal becomes stable. When switching the clock signal during program execution, wait until the target clock signal is stabilized. When the clock signal is generated with an external resonator or from an external oscillator during a reset, ensure that the reset line is only released after full stabilization of the clock signal. Additionally, when switching to a clock signal produced with an external resonator or by an external oscillator while program execution is in progress, wait until the target clock signal is stable.

6. Voltage application waveform at input pin

Waveform distortion due to input noise or a reflected wave may cause malfunction. If the input of the CMOS device stays in the area between V_{IL} (Max.) and V_{IH} (Min.) due to noise, for example, the device may malfunction. Take care to prevent chattering noise from entering the device when the input level is fixed, and also in the transition period when the input level passes through the area between V_{IL} (Max.) and V_{IH} (Min.).

7. Prohibition of access to reserved addresses

Access to reserved addresses is prohibited. The reserved addresses are provided for possible future expansion of functions. Do not access these addresses as the correct operation of the LSI is not guaranteed.

8. Differences between products

Before changing from one product to another, for example to a product with a different part number, confirm that the change will not lead to problems. The characteristics of a microprocessing unit or microcontroller unit products in the same group but having a different part number might differ in terms of internal memory capacity, layout pattern, and other factors, which can affect the ranges of electrical characteristics, such as characteristic values, operating margins, immunity to noise, and amount of radiated noise. When changing to a product with a different part number, implement a system-evaluation test for the given product.

Notice

1. Descriptions of circuits, software and other related information in this document are provided only to illustrate the operation of semiconductor products and application examples. You are fully responsible for the incorporation or any other use of the circuits, software, and information in the design of your product or system. Renesas Electronics disclaims any and all liability for any losses and damages incurred by you or third parties arising from the use of these circuits, software, or information.
2. Renesas Electronics hereby expressly disclaims any warranties against and liability for infringement or any other claims involving patents, copyrights, or other intellectual property rights of third parties, by or arising from the use of Renesas Electronics products or technical information described in this document, including but not limited to, the product data, drawings, charts, programs, algorithms, and application examples.
3. No license, express, implied or otherwise, is granted hereby under any patents, copyrights or other intellectual property rights of Renesas Electronics or others.
4. You shall be responsible for determining what licenses are required from any third parties, and obtaining such licenses for the lawful import, export, manufacture, sales, utilization, distribution or other disposal of any products incorporating Renesas Electronics products, if required.
5. You shall not alter, modify, copy, or reverse engineer any Renesas Electronics product, whether in whole or in part. Renesas Electronics disclaims any and all liability for any losses or damages incurred by you or third parties arising from such alteration, modification, copying or reverse engineering.
6. Renesas Electronics products are classified according to the following two quality grades: "Standard" and "High Quality". The intended applications for each Renesas Electronics product depends on the product's quality grade, as indicated below.
 - "Standard": Computers; office equipment; communications equipment; test and measurement equipment; audio and visual equipment; home electronic appliances; machine tools; personal electronic equipment; industrial robots; etc.
 - "High Quality": Transportation equipment (automobiles, trains, ships, etc.); traffic control (traffic lights); large-scale communication equipment; key financial terminal systems; safety control equipment; etc.Unless expressly designated as a high reliability product or a product for harsh environments in a Renesas Electronics data sheet or other Renesas Electronics document, Renesas Electronics products are not intended or authorized for use in products or systems that may pose a direct threat to human life or bodily injury (artificial life support devices or systems; surgical implantations; etc.), or may cause serious property damage (space system; undersea repeaters; nuclear power control systems; aircraft control systems; key plant systems; military equipment; etc.). Renesas Electronics disclaims any and all liability for any damages or losses incurred by you or any third parties arising from the use of any Renesas Electronics product that is inconsistent with any Renesas Electronics data sheet, user's manual or other Renesas Electronics document.
7. No semiconductor product is absolutely secure. Notwithstanding any security measures or features that may be implemented in Renesas Electronics hardware or software products, Renesas Electronics shall have absolutely no liability arising out of any vulnerability or security breach, including but not limited to any unauthorized access to or use of a Renesas Electronics product or a system that uses a Renesas Electronics product. RENESAS ELECTRONICS DOES NOT WARRANT OR GUARANTEE THAT RENESAS ELECTRONICS PRODUCTS, OR ANY SYSTEMS CREATED USING RENESAS ELECTRONICS PRODUCTS WILL BE INVULNERABLE OR FREE FROM CORRUPTION, ATTACK, VIRUSES, INTERFERENCE, HACKING, DATA LOSS OR THEFT, OR OTHER SECURITY INTRUSION ("Vulnerability Issues"). RENESAS ELECTRONICS DISCLAIMS ANY AND ALL RESPONSIBILITY OR LIABILITY ARISING FROM OR RELATED TO ANY VULNERABILITY ISSUES. FURTHERMORE, TO THE EXTENT PERMITTED BY APPLICABLE LAW, RENESAS ELECTRONICS DISCLAIMS ANY AND ALL WARRANTIES, EXPRESS OR IMPLIED, WITH RESPECT TO THIS DOCUMENT AND ANY RELATED OR ACCOMPANYING SOFTWARE OR HARDWARE, INCLUDING BUT NOT LIMITED TO THE IMPLIED WARRANTIES OF MERCHANTABILITY, OR FITNESS FOR A PARTICULAR PURPOSE.
8. When using Renesas Electronics products, refer to the latest product information (data sheets, user's manuals, application notes, "General Notes for Handling and Using Semiconductor Devices" in the reliability handbook, etc.), and ensure that usage conditions are within the ranges specified by Renesas Electronics with respect to maximum ratings, operating power supply voltage range, heat dissipation characteristics, installation, etc. Renesas Electronics disclaims any and all liability for any malfunctions, failure or accident arising out of the use of Renesas Electronics products outside of such specified ranges.
9. Although Renesas Electronics endeavors to improve the quality and reliability of Renesas Electronics products, semiconductor products have specific characteristics, such as the occurrence of failure at a certain rate and malfunctions under certain use conditions. Unless designated as a high reliability product or a product for harsh environments in a Renesas Electronics data sheet or other Renesas Electronics document, Renesas Electronics products are not subject to radiation resistance design. You are responsible for implementing safety measures to guard against the possibility of bodily injury, injury or damage caused by fire, and/or danger to the public in the event of a failure or malfunction of Renesas Electronics products, such as safety design for hardware and software, including but not limited to redundancy, fire control and malfunction prevention, appropriate treatment for aging degradation or any other appropriate measures. Because the evaluation of microcomputer software alone is very difficult and impractical, you are responsible for evaluating the safety of the final products or systems manufactured by you.
10. Please contact a Renesas Electronics sales office for details as to environmental matters such as the environmental compatibility of each Renesas Electronics product. You are responsible for carefully and sufficiently investigating applicable laws and regulations that regulate the inclusion or use of controlled substances, including without limitation, the EU RoHS Directive, and using Renesas Electronics products in compliance with all these applicable laws and regulations. Renesas Electronics disclaims any and all liability for damages or losses occurring as a result of your noncompliance with applicable laws and regulations.
11. Renesas Electronics products and technologies shall not be used for or incorporated into any products or systems whose manufacture, use, or sale is prohibited under any applicable domestic or foreign laws or regulations. You shall comply with any applicable export control laws and regulations promulgated and administered by the governments of any countries asserting jurisdiction over the parties or transactions.
12. It is the responsibility of the buyer or distributor of Renesas Electronics products, or any other party who distributes, disposes of, or otherwise sells or transfers the product to a third party, to notify such third party in advance of the contents and conditions set forth in this document.
13. This document shall not be reprinted, reproduced or duplicated in any form, in whole or in part, without prior written consent of Renesas Electronics.
14. Please contact a Renesas Electronics sales office if you have any questions regarding the information contained in this document or Renesas Electronics products.

(Note1) "Renesas Electronics" as used in this document means Renesas Electronics Corporation and also includes its directly or indirectly controlled subsidiaries.

(Note2) "Renesas Electronics product(s)" means any product developed or manufactured by or for Renesas Electronics.

(Rev.5.0-1 October 2020)

Corporate Headquarters

TOYOSU FORESIA, 3-2-24 Toyosu,
Koto-ku, Tokyo 135-0061, Japan

www.renesas.com

Trademarks

Renesas and the Renesas logo are trademarks of Renesas Electronics Corporation. All trademarks and registered trademarks are the property of their respective owners.

Contact information

For further information on a product, technology, the most up-to-date version of a document, or your nearest sales office, please visit:

www.renesas.com/contact/.