

# Application Note

## PV88090-Dynamic Voltage Control (DVC)

### AN-PV-008

#### Abstract

*Dynamic Voltage Control (DVC) facilitates the increase or decrease of power rail voltages dynamically as the load increases on a processor. This functionality save system power when the loading is low while allowing increased processor clocking when system needs it. This application note illustrates the use of DVC using the PV88090 PMIC.*

---

## Contents

<b>Abstract</b> .....	<b>1</b>
<b>Contents</b> .....	<b>2</b>
<b>Figures</b> .....	<b>2</b>
<b>Tables</b> .....	<b>2</b>
<b>1 Terms and Definitions</b> .....	<b>3</b>
<b>2 References</b> .....	<b>3</b>
<b>3 Introduction</b> .....	<b>4</b>
<b>4 DVC</b> .....	<b>4</b>
4.1 DVC Setting - Buck Converter .....	<b>5</b>
<b>5 Conclusions</b> .....	<b>9</b>
<b>Revision History</b> .....	<b>10</b>

## Figures

Figure 1: Traditional DVC solution .....	4
Figure 2: PV88090 Simplified Block Diagram for one Buck stage .....	4
Figure 3: PV88090 DVC up transition measurement example .....	5
Figure 4: PV88090 DVC down transition measurement example.....	5
Figure 5: Dialog GUI - BUCKx_CONF0[6:0] .....	6
Figure 6: Dialog GUI - BUCKx_CONF3[7:6] .....	6
Figure 7: DVC step-up with 12.5mV/μS slew rate.....	6
Figure 8: DVC step-down with 12.5mV/μS slew rate .....	7
Figure 9: Setting in Dialog GUI_Sending 0X60 to BUCK1_CONF0 .....	8
Figure 10: DVC step-down from 1.2V to 1.15V .....	8
Figure 11: Setting in Dialog GUI_Sending 0x58 to BUCK1_CONF0 .....	8
Figure 12: Dynamic Voltage Control step-up from 1.15V to 1.2V .....	9

## Tables

Table 1: Buck1 Output Voltage region .....	5
Table 2: Buck2/3 Output Voltage region .....	6
Table 3: LV Buck1 Output Voltage - region1 .....	7

## 1 Terms and Definitions

GUI	Graphical User Interface
LVBuck	Low Voltage Buck converter

## 2 References

- [1] S. Mittal, "A survey of techniques for improving energy efficiency in embedded computing systems", *IJCAET*, 6(4), 440-459, 2014.

### 3 Introduction

The power consumed by processor cores is proportional to the operating frequency and to supply voltage. DVC is used to optimize performance, power consumption and thermal performance of processor devices. DVC increases voltage to increase processor performance, and decreases voltage to saving power. This technique, initially used in laptops and mobile devices [1], is now becoming prevalent in tethered systems.

### 4 DVC

Traditionally, a mount of resistor divider and MOSFET, as shown in Figure 1, is used to change the divide ratio for adjusting the output voltage of converter. It needs many components and control signals, and therefore, also a large layout area. PV88090 provides DVC, which supports adaptive adjustment of the supply voltage dependent on the processor load, via direct register write in the I2C interface. This simplified the schematics, as shown in Figure 2. The DVC slew rate is also adjustable in the I2C to minimize the overshoot when the output voltage level is not acceptable. For examples of how the PV88090 DVC minimizes overshoot and undershoot, see Figure 3 and Figure 4.

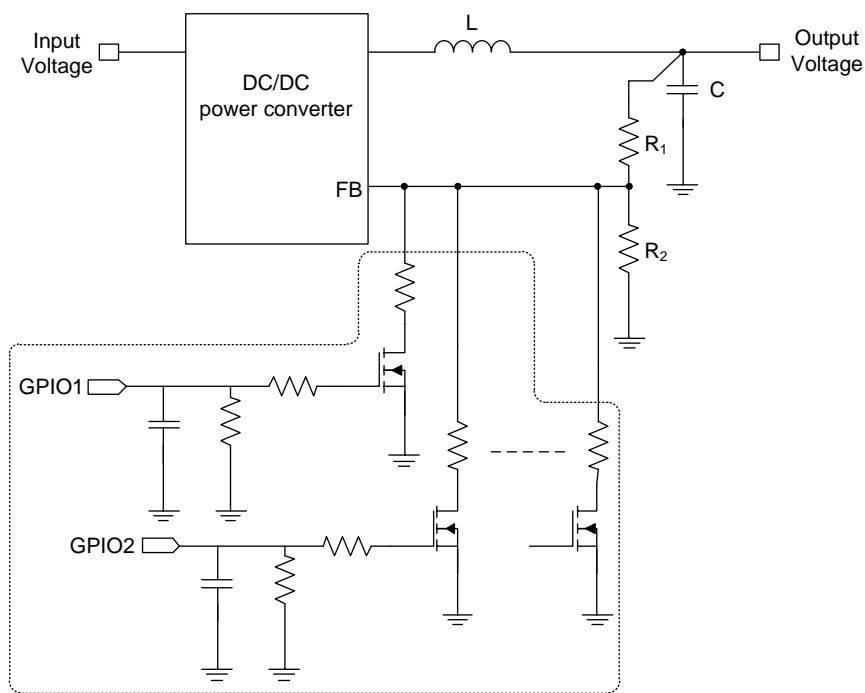

Figure 1: Traditional DVC solution

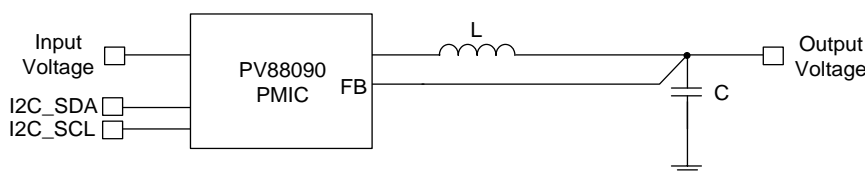

Figure 2: PV88090 Simplified Block Diagram for one Buck stage

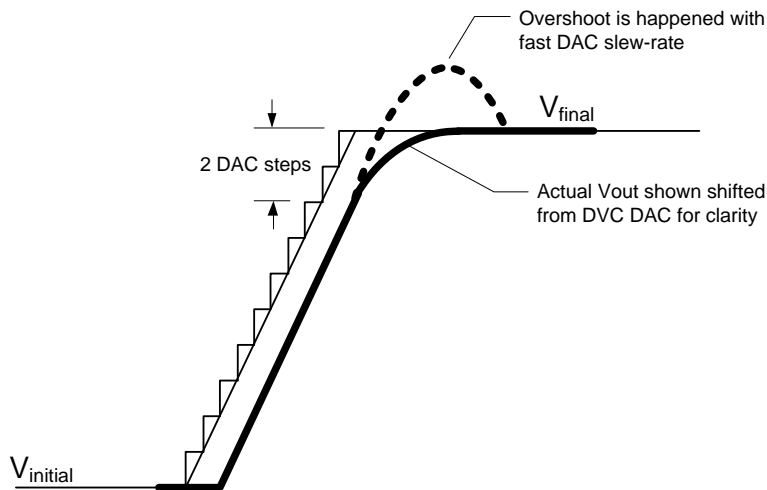

Figure 3: PV88090 DVC up transition measurement example

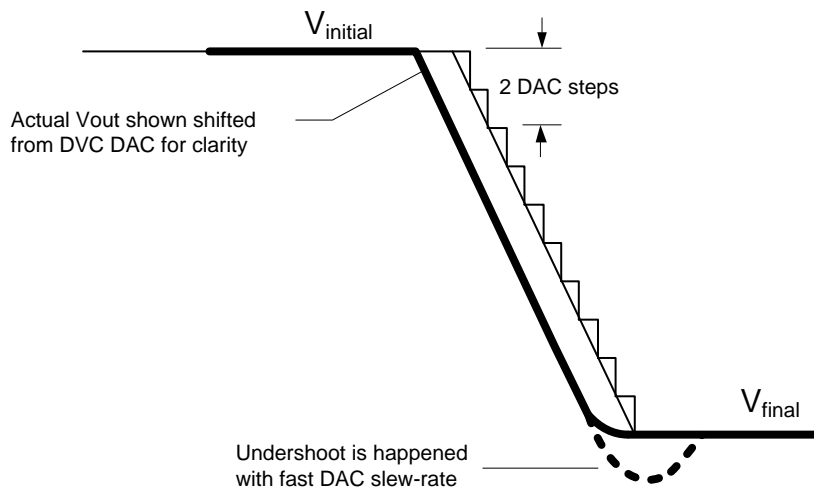

Figure 4: PV88090 DVC down transition measurement example

### 4.1 DVC Setting - Buck Converter

The LVBuck converters support DVC. The output voltage range of BUCK1 is 0.75V to 3.3V, to 3.6V for LVBuck2/3 with different output voltage region showed in Table 1 and Table 2. Generally, the core voltage of processor is in region 1.

Set register BUCKx\_CONF0[6:0] to the target voltage based on your processor requirement. This is done using Dialog's full featured GUI as shown in Figure 5.

Table 1: Buck1 Output Voltage region

Region	Min (V)	Max (V)	Step (mV)
1	0.9	1.3	12.5

Table 2: Buck2/3 Output Voltage region

Region	Min (V)	Max (V)	Step (mV)
1	0.6	1.4	6.25
2	1.4	2.2	6.25

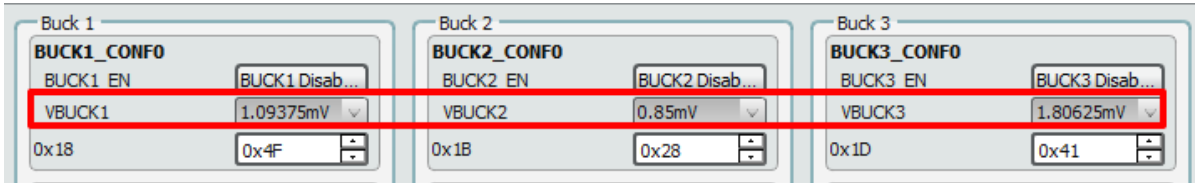

Figure 5: Dialog GUI - BUCKx\_CONF0[6:0]

The DVC slew rate is adjustable for preventing overshoot or undershoot on the output voltage by setting register Buckx\_CONF3[7:6]. This is done using Dialog's full featured GUI as shown in Figure 6. Generally, higher slew rate are more likely to cause overshoot or undershoot. **Error! Reference source not found.** to Figure 8 shows the DVC waveform with different slew. The overshoot and undershoot due to faster slew rate can be observed in Figure 7 and Figure 8.

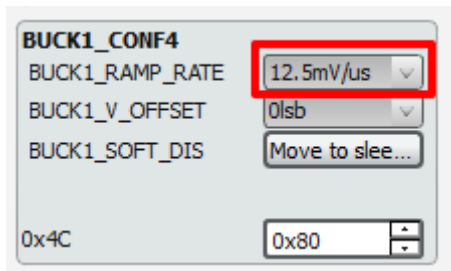

Figure 6: Dialog GUI - BUCKx\_CONF3[7:6]

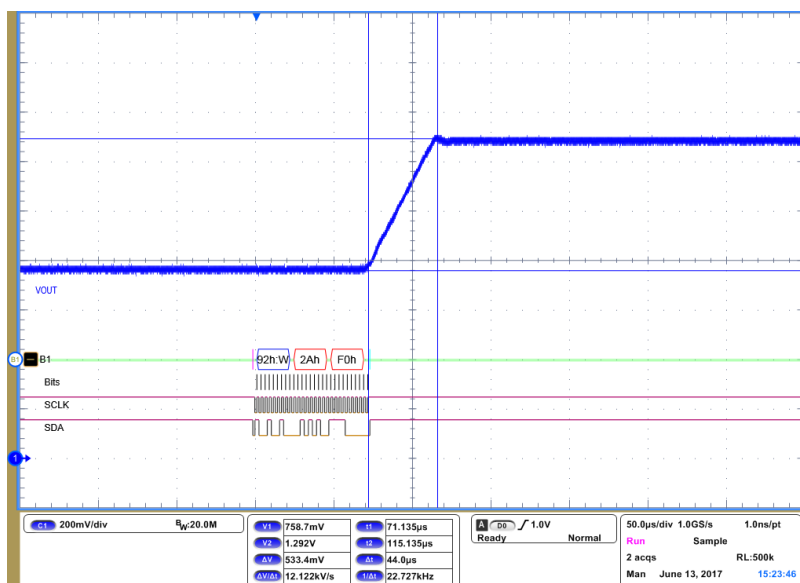

Figure 7: DVC step-up with 12.5mV/μS slew rate

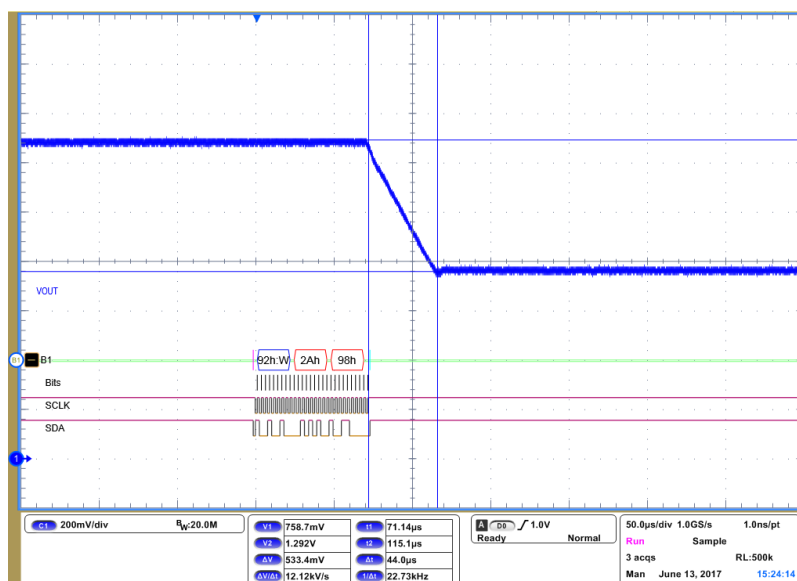

Figure 8: DVC step-down with 12.5mV/µs slew rate

By way of example, a processor is supplied by the LV Buck1 for the typical core voltage 1.2V. The LV Buck1 output voltage is in region1, the output voltage table as shown in 1. In idle mode, the core voltage of the process is 1.15V required for saving power. We choose the slew rate 3.125mV/µs for preventing overshoot. Sending the command 0xD8 to BUCK1\_CONF0(0x2A) via I2C interface as shown in Figure 9 and the behavior is shown in Figure 10. The output voltage return to 1.2V that means sending the command 0xE0 to BUCK1\_CONF0(0x2A) as shown in Figure 11 and the waveform is shown in Figure 12.

Table 3: LV Buck1 Output Voltage - region1

Register BUCK1\_CONF0

Address	Name	POR value			
0x0018	BUCK1_CONF0	0x50			
7	6	5	4		
BUCK1_EN					
Field name	Bits	Type	FOR		
BUCK1_EN	[7]	RW OTP	0x0	Value	
				0x0 (POR)	0: BUCK1 Disabled
				0x1	1: BUCK1 Enabled
VBUCK1	[6:0]	RW OTP	0x50	Buck Dual Phase Voltage.	
				Value	
				0x0	0000000: 600mV
				0x1	0000001: 606.25mV
				0x2	0000001: 612.5mV
				...	...
				0x3D	1111101: 1.38125V
0x3E	1111110: 1.3875V				
0x3F	1111111: 1.39375V				

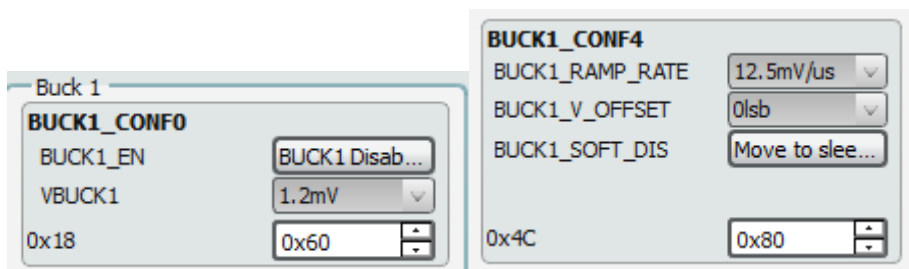

Figure 9: Setting in Dialog GUI\_Sending 0X60 to BUCK1\_CONF0

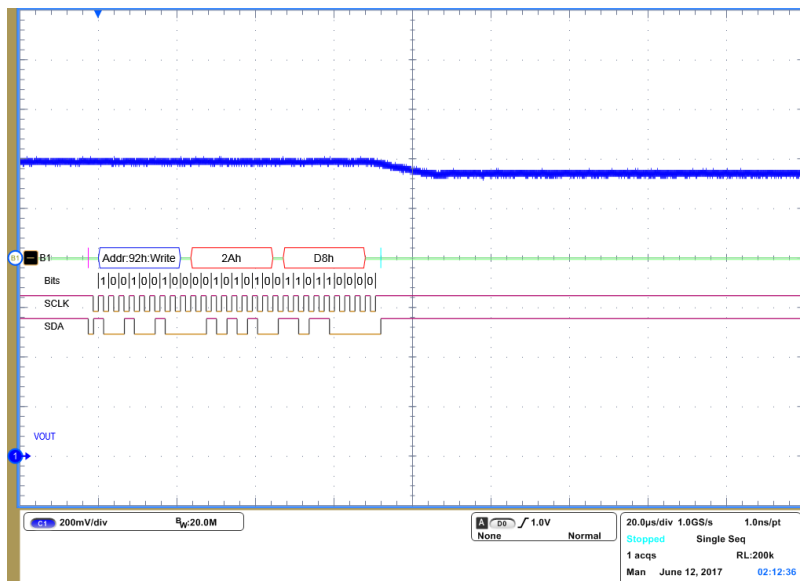

Figure 10: DVC step-down from 1.2V to 1.15V

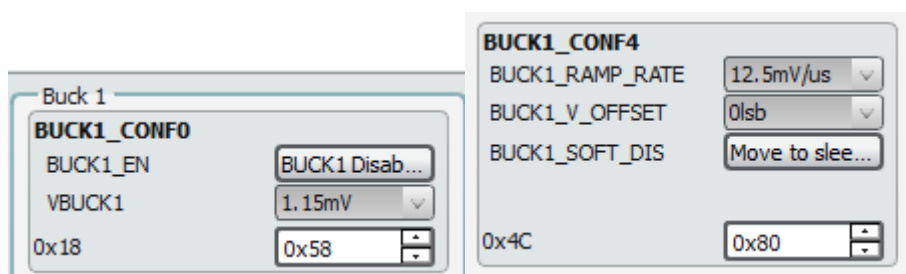

Figure 11: Setting in Dialog GUI\_Sending 0x58 to BUCK1\_CONF0



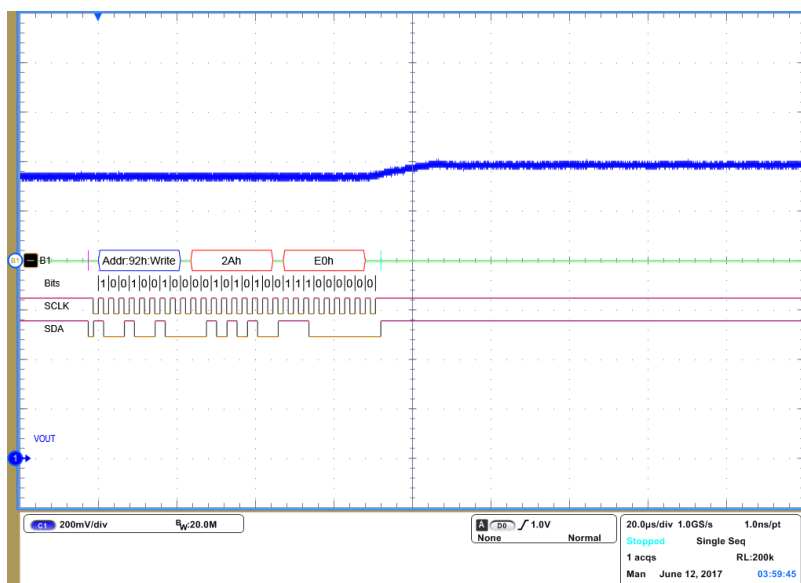

Figure 12: Dynamic Voltage Control step-up from 1.15V to 1.2V

## 5 Conclusions

Both the LVBUCKs and HVBUCK in PV88090 support dynamic voltage control(DVC) function. The DVC slew rate is flexible to meet different application for preventing overshoot and undershoot. The I2c interface provides a standard and flexible way to control this feature.

## Revision History

Revision	Date	Description
1.0	<23-Sun-2017>	Initial version.

### Disclaimer

Information in this document is believed to be accurate and reliable. However, Dialog Semiconductor does not give any representations or warranties, expressed or implied, as to the accuracy or completeness of such information. Dialog Semiconductor furthermore takes no responsibility whatsoever for the content in this document if provided by any information source outside of Dialog Semiconductor.

Dialog Semiconductor reserves the right to change without notice the information published in this document, including without limitation the specification and the design of the related semiconductor products, software and applications.

Applications, software, and semiconductor products described in this document are for illustrative purposes only. Dialog Semiconductor makes no representation or warranty that such applications, software and semiconductor products will be suitable for the specified use without further testing or modification. Unless otherwise agreed in writing, such testing or modification is the sole responsibility of the customer and Dialog Semiconductor excludes all liability in this respect.

Customer notes that nothing in this document may be construed as a license for customer to use the Dialog Semiconductor products, software and applications referred to in this document. Such license must be separately sought by customer with Dialog Semiconductor.

All use of Dialog Semiconductor products, software and applications referred to in this document are subject to Dialog Semiconductor's [Standard Terms and Conditions of Sale](http://www.dialog-semiconductor.com), available on the company website ([www.dialog-semiconductor.com](http://www.dialog-semiconductor.com)) unless otherwise stated.

Dialog and the Dialog logo are trademarks of Dialog Semiconductor plc or its subsidiaries. All other product or service names are the property of their respective owners.

© 2018 Dialog Semiconductor. All rights reserved.

## Contacting Dialog Semiconductor

### United Kingdom (Headquarters)

*Dialog Semiconductor (UK) LTD*  
Phone: +44 1793 757700

### Germany

*Dialog Semiconductor GmbH*  
Phone: +49 7021 805-0

### The Netherlands

*Dialog Semiconductor B.V.*  
Phone: +31 73 640 8822

### Email:

[enquiry@diasemi.com](mailto:enquiry@diasemi.com)

### North America

*Dialog Semiconductor Inc.*  
Phone: +1 408 845 8500

### Japan

*Dialog Semiconductor K. K.*  
Phone: +81 3 5425 4567

### Taiwan

*Dialog Semiconductor Taiwan*  
Phone: +886 281 786 222

### Web site:

[www.dialog-semiconductor.com](http://www.dialog-semiconductor.com)

### Korea

*Dialog Semiconductor Korea*  
Phone: +82 2 3469 8200

### Hong Kong

*Dialog Semiconductor Hong Kong*  
Phone: +852 3769 5200

### China (Shenzhen)

*Dialog Semiconductor China*  
Phone: +86 755 2981 3669

### China (Shanghai)

*Dialog Semiconductor China*  
Phone: +86 21 5424 9058

## IMPORTANT NOTICE AND DISCLAIMER

RENESAS ELECTRONICS CORPORATION AND ITS SUBSIDIARIES (“RENESAS”) PROVIDES TECHNICAL SPECIFICATIONS AND RELIABILITY DATA (INCLUDING DATASHEETS), DESIGN RESOURCES (INCLUDING REFERENCE DESIGNS), APPLICATION OR OTHER DESIGN ADVICE, WEB TOOLS, SAFETY INFORMATION, AND OTHER RESOURCES “AS IS” AND WITH ALL FAULTS, AND DISCLAIMS ALL WARRANTIES, EXPRESS OR IMPLIED, INCLUDING, WITHOUT LIMITATION, ANY IMPLIED WARRANTIES OF MERCHANTABILITY, FITNESS FOR A PARTICULAR PURPOSE, OR NON-INFRINGEMENT OF THIRD-PARTY INTELLECTUAL PROPERTY RIGHTS.

These resources are intended for developers who are designing with Renesas products. You are solely responsible for (1) selecting the appropriate products for your application, (2) designing, validating, and testing your application, and (3) ensuring your application meets applicable standards, and any other safety, security, or other requirements. These resources are subject to change without notice. Renesas grants you permission to use these resources only to develop an application that uses Renesas products. Other reproduction or use of these resources is strictly prohibited. No license is granted to any other Renesas intellectual property or to any third-party intellectual property. Renesas disclaims responsibility for, and you will fully indemnify Renesas and its representatives against, any claims, damages, costs, losses, or liabilities arising from your use of these resources. Renesas' products are provided only subject to Renesas' Terms and Conditions of Sale or other applicable terms agreed to in writing. No use of any Renesas resources expands or otherwise alters any applicable warranties or warranty disclaimers for these products.

(Disclaimer Rev.1.01 Jan 2024)

### Corporate Headquarters

TOYOSU FORESIA, 3-2-24 Toyosu,  
Koto-ku, Tokyo 135-0061, Japan  
[www.renesas.com](http://www.renesas.com)

### Trademarks

Renesas and the Renesas logo are trademarks of Renesas Electronics Corporation. All trademarks and registered trademarks are the property of their respective owners.

### Contact Information

For further information on a product, technology, the most up-to-date version of a document, or your nearest sales office, please visit [www.renesas.com/contact-us/](http://www.renesas.com/contact-us/).