

EFT Immunity of the RAA78815x Family of 5V RS-485/RS-422 Transceivers

Abstract

This application note discusses the immunity of the RAA78815x family ([RAA788150](#), [RAA788152](#), [RAA788153](#), [RAA788155](#), [RAA788156](#), [RAA788158](#)) of RS-485/RS-422 transceivers to repetitive Electrical Fast Transients (EFT) as defined in IEC61000-4-4. It describes the EFT test setup and the transceiver performance under the application of EFT pulses. Subsequent ATE tests confirm an EFT immunity of 5kV at 5kHz and 100kHz repetition rates for all RAA78815x transceivers, the highest possible test voltage of the AXOS-5 test system, which places this transceiver family into the highest special test level category of IEC61000-4-4.

Contents

1. EFT Test according to IEC61000-4-4	2
2. Actual Test Setup	3
3. Test Performance	4
4. Conclusion	6
5. References	6
6. Revision History	6

List of Figures

Figure 1. EFT Pulse Waveform	2
Figure 2. EFT Test Timing	2
Figure 3. Test Setup with a Capacitive Clamp and Two EUTs for Laboratory Tests	2
Figure 4. Schematic of Laboratory Test Setup	3
Figure 5. Photograph of Laboratory Test Setup	3
Figure 6. RO1 and RO2 during EFT Test with low Repetition Rate	4
Figure 7. Data Input and differential Bus Voltage during EFT Test with low Repetition Rate	4
Figure 8. RO1 and RO2 during EFT Test with high Repetition Rate	4
Figure 9. Data Input and differential Bus Voltage during EFT Test with high Repetition Rate	4
Figure 10. Normal Transceiver Operation was confirmed after each Test Run	5
Figure 11. EFT Test Data Sheet	5

1. EFT Test according to IEC61000-4-4

The EFT test applies a burst of 75 fast transients that are coupled into the data lines of an RS-485 data link. Significant for the test pulses are the high amplitude, the short rise time, the high repetition rate, and the low energy of the transients. This test checks the immunity of RS-485/RS-422 transceivers when subjected to fast transients, such as those generated by the switching of inductive loads and relay contact bounce. The preferred test levels for the electrical fast transient test, applicable to data ports are listed in Table 1.

Table 1. EFT Test Levels

Test Level	Test Voltage (kV)	Repetition Frequency (kHz) ^[1]
1	0.25	5 or 100
2	0.5	5 or 100
3	1	5 or 100
4	2	5 or 100
X ^[2]	Special	Special

1. The use of 5kHz repetition rates is traditional, however, 100kHz is closer to reality.
2. X is an open level. The level has to be specified in the dedicated equipment specification.

An EFT transient has a rise time of 5ns and a pulse width (where V_{Test} is $> 50\% V_{Test-PK}$) of 50ns (Figure 1). The burst period is 300ms and consists of 75 EFT pulses (t_{Burst}) followed by a break interval. Depending on the repetition frequency, t_{Burst} is 15ms at $f_{Rep} = 5kHz$, or 0.75ms at $f_{Rep} = 100kHz$. The total test time, comprising multiple burst periods, is not less than one minute (Figure 2).

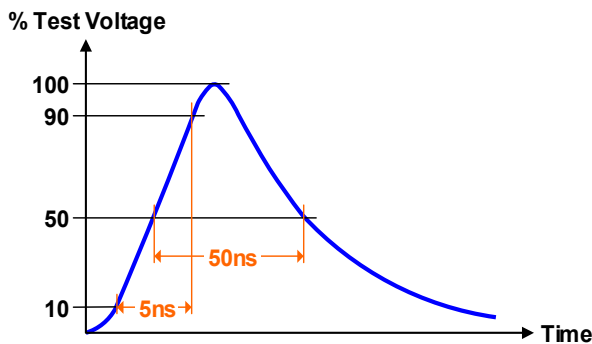

Figure 1. EFT Pulse Waveform

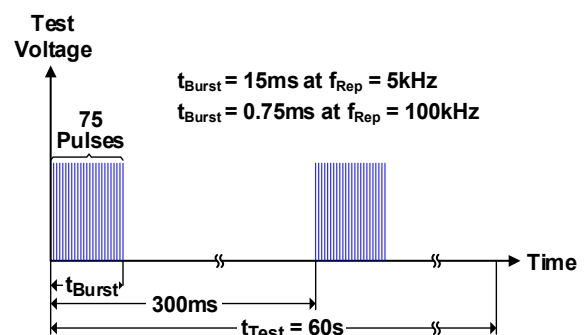

Figure 2. EFT Test Timing

Figure 3 depicts the principle test set-up for the application of the test voltage by a capacitive coupling clamp for laboratory test purposes.

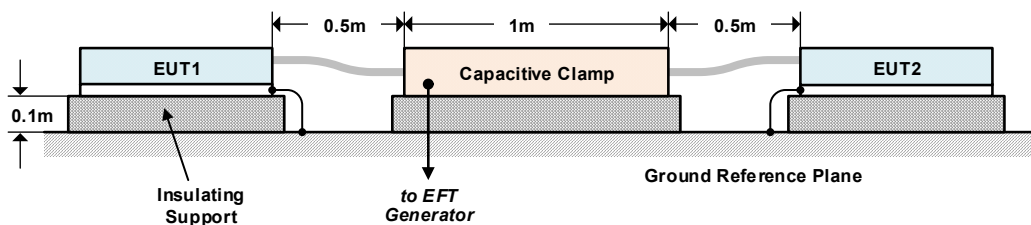

Figure 3. Test Setup with a Capacitive Clamp and Two EUTs for Laboratory Tests

In this setup, two Equipment Under Test (EUTs) are tested simultaneously. With both EUTs being equally distanced from the clamp by 0.5m, and a capacitive clamp length of 1m, the total test cable length is 2m (6ft). The entire setup is placed on top of a ground reference plane, with the EUTs and the clamp being isolated from the reference plane by an insulating support material of 0.1m height.

2. Actual Test Setup

Figure 4 shows the schematic of the test setup for testing the EFT immunity of RS-485 transceivers. A data signal in form of a square wave is applied to the data input (DI) of the left node. This node is configured as a driver whose output signal is looped back to the receiver output (RO1) and captured with the oscilloscope. The driver transmits data to the receiving node on the right, whose output (RO2) is also captured with the scope. For each EFT test, the test voltage is raised and applied while transmitting data, until one of the transceivers latches up.

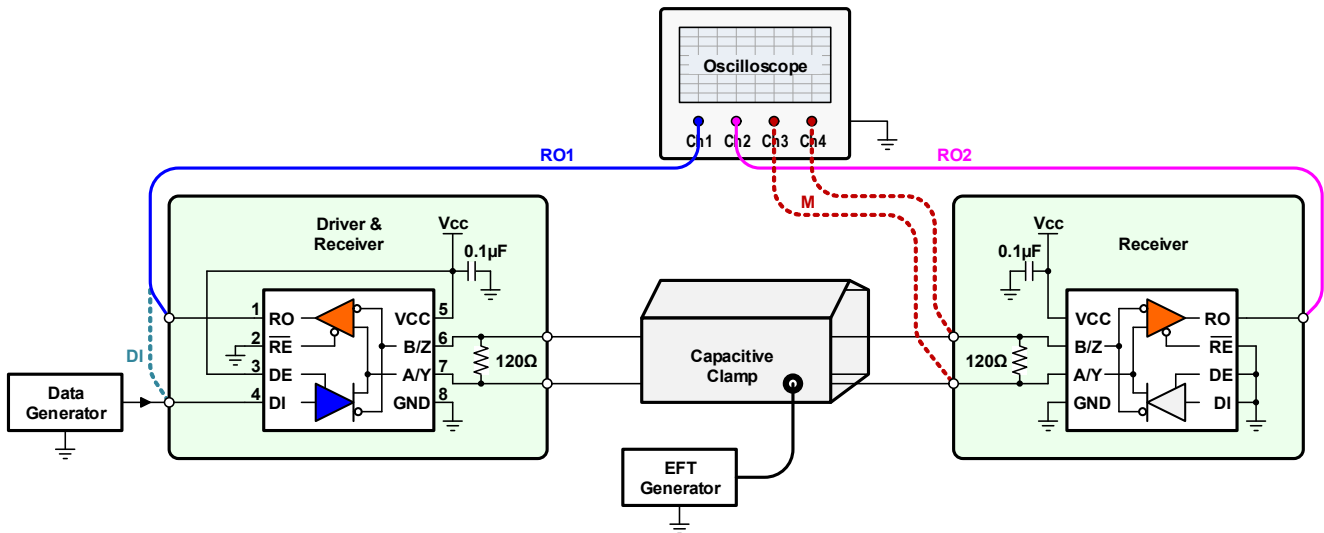

Figure 4. Schematic of Laboratory Test Setup

A second measurement (dotted lines) is performed that captures the differential bus signal (M) and compares it with the data input (DI). M is the math-function of the scope that calculates the difference of the individually measured signals on the A and B bus lines.

Figure 5 shows a photograph of the actual test setup using the AXOS-5 test system.

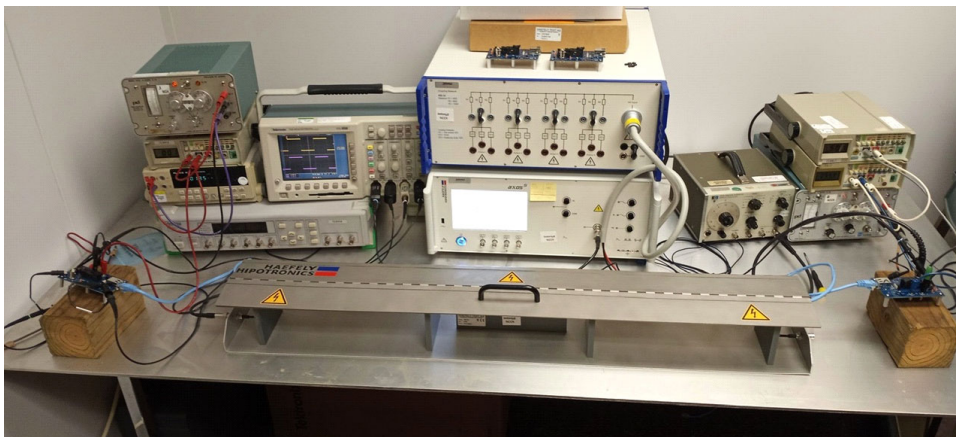

Figure 5. Photograph of Laboratory Test Setup

3. Test Performance

Figure 6 depicts the receiver output signals during the EFT test with 5kHz repetition rate. Figure 7 shows the data input and the differential bus voltage during the same test. Both figures show that the driver and the receivers recover fast after an EFT event.

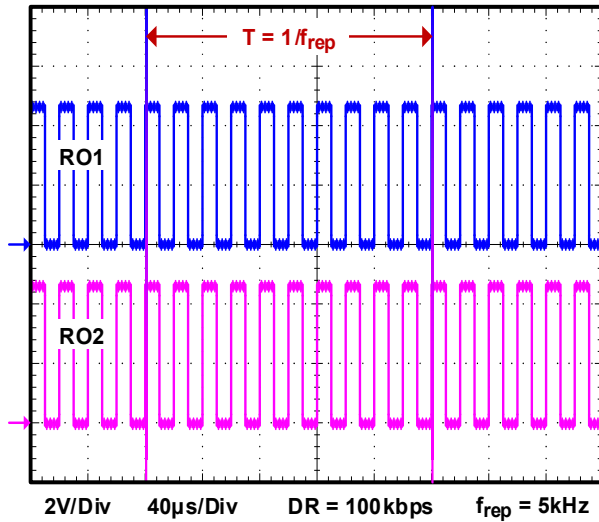

Figure 6. RO1 and RO2 during EFT Test with low Repetition Rate

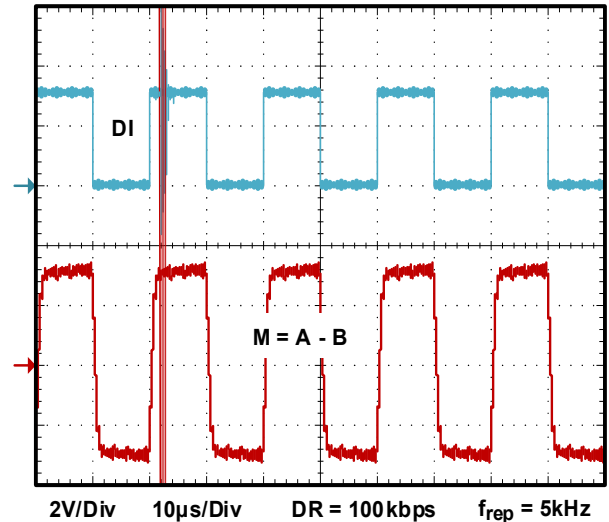

Figure 7. Data Input and differential Bus Voltage during EFT Test with low Repetition Rate

Figure 8 depicts the receiver outputs during the EFT test with 100kHz repetition rate at a data rate of 10kbps. Therefore, each bit experiences five EFT transients. Figure 9 shows the data input and the differential bus voltage during the same test. It can be seen that even at a high repetition rate, the driver and both receivers recover fast after each EFT event.

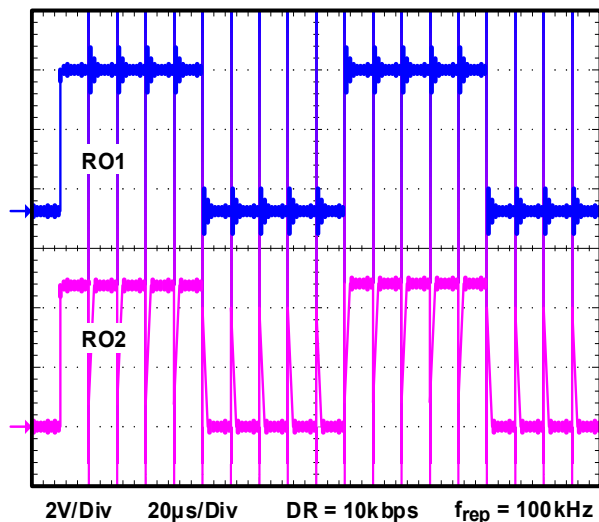

Figure 8. RO1 and RO2 during EFT Test with high Repetition Rate

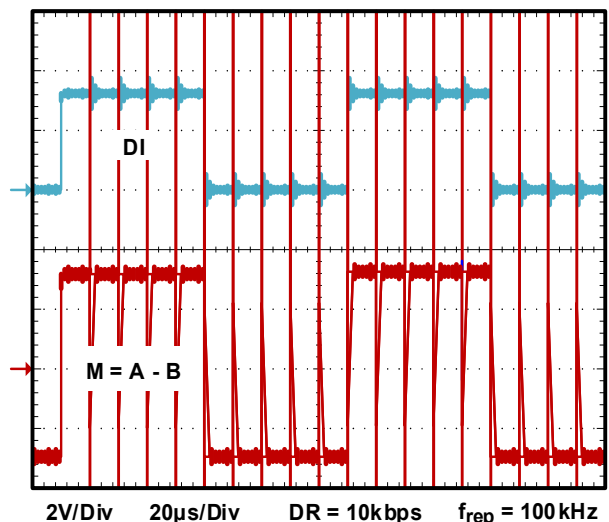

Figure 9. Data Input and differential Bus Voltage during EFT Test with high Repetition Rate

After each test run, both receiver outputs were observed for normal transceiver operation during data transmission, which is shown in Figure 10.

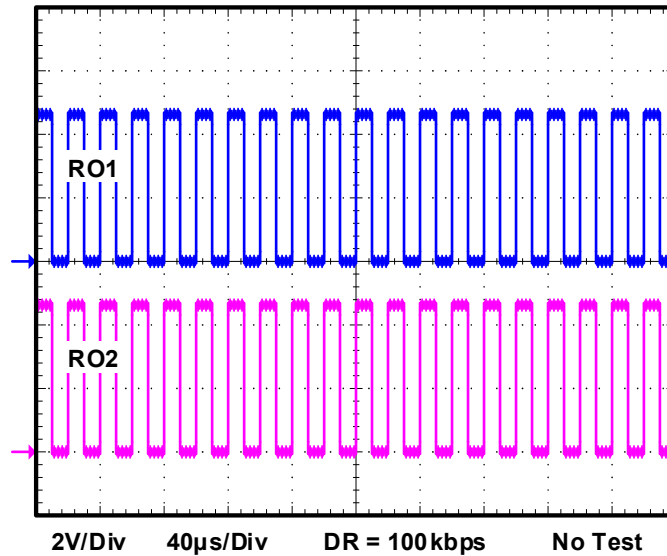

Figure 10. Normal Transceiver Operation was confirmed after each Test Run

In addition to the visual confirmation of normal transceiver operation, all transceivers were tested on an Automatic Test System (ATE) for parametric performance. The pass criterion required that a device did not show any parametric shift. The results of the EFT and ATE tests have been recorded in the EFT test datasheet, shown in Figure 11.

Note: To save space, only the highest EFT pass-levels are shown.

RENESAS		TEST DATA SHEET						Product Type		RAA78815x			
								Date		08/19/2020			
Type of Test		EFT Immunity per IEC61000-4-4						Recorded by		A. Erzinger			
Board Used / Equip.		Burst Period 300ms, Rep. Freq. = 5kHz / 100kHz, Burst Length = 15ms / 0.75ms											
Other special setup		DR = 100kbps, Test time = 60s for each Polarity											
Mode	Parameter	Half-Duplex Transceivers						Full-Duplex Transceivers					
		RAA788152		RAA788155		RAA788158		RAA788150		RAA788153		RAA788156	
	VCC = 5V												
	Rep. Freq. (kHz)	5	100	5	100	5	100	5	100	5	100	5	100
	Burst (ms)	15	0.75	15	0.75	15	0.75	15	0.75	15	0.75	15	0.75
	EFT Voltage*												
TX	+5kV	OK	OK	OK	OK	OK	OK						
	-5kV	OK	OK	OK	OK	OK	OK						
RX	+5kV	OK	OK	OK	OK	OK	OK						
	-5kV	OK	OK	OK	OK	OK	OK						
TX/RX	+5kV							OK	OK	OK	OK	OK	OK
	-5kV							OK	OK	OK	OK	OK	OK
	ATE-Test	Pass		Pass		Pass		Pass		Pass		Pass	

Figure 11. EFT Test Data Sheet

4. Conclusion

The RAA78815x family of 5V RS-485/RS-422 transceivers passed all EFT tests with 5kV test voltage, the highest possible test voltage of the AXOS-5 test system, which places this transceiver family into the highest special test level category (Table 2).

Table 2. EFT Test Level Category for RAA78815x Transceivers

Test Level	Test Voltage (kV)	Repetition Frequency (kHz)	Components
1	0.25	5 or 100	RAA788150, RAA788152, RAA788153, RAA788155, RAA788156, RAA788158
2	0.5	5 or 100	
3	1	5 or 100	
4	2	5 or 100	
X	5	5 and 100	

Although the RAA78815x transceivers possess high EFT immunity, the remaining components of a bus node, such as UART, MCU, and LDO voltage regulator, can have less immunity. To ensure the survivability of these components, and not only the transceiver, it is beneficial to protect an entire bus node circuit with external transient voltage suppressor (TVS) devices. Their design, functional principle, and application in combination with Renesas transceivers are explained in the application notes listed in the reference section.

5. References

The following references can be located on the [RS-485/RS-422 Serial Interface](#) family page.

- AN1976: Important Transient Immunity Tests for RS-485 Networks
- AN1977: Transient Voltage Suppressors: Operation and Features
- AN1978: Surge Protection for Renesas' Standard RS-485 Transceivers
- AN1979: Surge Protection simplified with Renesas' Overvoltage Protected (OVP) Transceivers
- R15AN0002: RS-485 Transient Protection in Industrial DC-Supply Buses

6. Revision History

Rev.	Date	Description
1.0	Jun 8, 2021	Initial release

IMPORTANT NOTICE AND DISCLAIMER

RENESAS ELECTRONICS CORPORATION AND ITS SUBSIDIARIES (“RENESAS”) PROVIDES TECHNICAL SPECIFICATIONS AND RELIABILITY DATA (INCLUDING DATASHEETS), DESIGN RESOURCES (INCLUDING REFERENCE DESIGNS), APPLICATION OR OTHER DESIGN ADVICE, WEB TOOLS, SAFETY INFORMATION, AND OTHER RESOURCES “AS IS” AND WITH ALL FAULTS, AND DISCLAIMS ALL WARRANTIES, EXPRESS OR IMPLIED, INCLUDING, WITHOUT LIMITATION, ANY IMPLIED WARRANTIES OF MERCHANTABILITY, FITNESS FOR A PARTICULAR PURPOSE, OR NON-INFRINGEMENT OF THIRD PARTY INTELLECTUAL PROPERTY RIGHTS.

These resources are intended for developers skilled in the art designing with Renesas products. You are solely responsible for (1) selecting the appropriate products for your application, (2) designing, validating, and testing your application, and (3) ensuring your application meets applicable standards, and any other safety, security, or other requirements. These resources are subject to change without notice. Renesas grants you permission to use these resources only for development of an application that uses Renesas products. Other reproduction or use of these resources is strictly prohibited. No license is granted to any other Renesas intellectual property or to any third party intellectual property. Renesas disclaims responsibility for, and you will fully indemnify Renesas and its representatives against, any claims, damages, costs, losses, or liabilities arising out of your use of these resources. Renesas' products are provided only subject to Renesas' Terms and Conditions of Sale or other applicable terms agreed to in writing. No use of any Renesas resources expands or otherwise alters any applicable warranties or warranty disclaimers for these products.

(Rev.1.0 Mar 2020)

Corporate Headquarters

TOYOSU FORESIA, 3-2-24 Toyosu,
Koto-ku, Tokyo 135-0061, Japan
www.renesas.com

Contact Information

For further information on a product, technology, the most up-to-date version of a document, or your nearest sales office, please visit:
www.renesas.com/contact/

Trademarks

Renesas and the Renesas logo are trademarks of Renesas Electronics Corporation. All trademarks and registered trademarks are the property of their respective owners.