

RA2L1 Group

Self-capacitance Waterproof Touch Button Demo Sample Software

Introduction

The CTSU2, the enhanced version of the Renesas Capacitive Touch Sensing Unit (CTSUS), supports an active shield as one of its anti-noise countermeasures. This document describes the self-capacitance waterproof touch button demo software, which implements the active shield function.

Target Device

RA2L1 (R7FA2L1AB2DFP)

Contents

1. Overview	2
2. Self-capacitance Touch Button: water resistance and noise immunity	2
3. Actual Device Operations	3
4. Software Specifications	6
4.1 Operational Overview	6
4.2 Operating Environment	8
4.3 File Structure	9
4.4 List of Functions	9
4.4.1 r_touch_waterproof_demo_main.....	9
4.4.1 r_touch_max_diff_button.....	10
4.4.2 r_timer0_callback	10
4.5 List of Constants	11
4.6 List of Variations	11
4.7 MCU Resources Used in Application	12
4.8 Touch Interface Settings	13
4.9 Button Sensitivity Adjustment.....	13
Revision History	14

1. Overview

This document describes how to design in waterproof buttons based on self-capacitance detection, using the hardware and software used in the self-capacitance waterproof touch button demo set (referred to “demo set” herein).

2. Self-capacitance Touch Button: water resistance and noise immunity

Figure 2-1 shows parasitic capacitance when a water droplet adheres to the GND shield button. Capacitance detection touch buttons tend to generate a false detection when exposed to water. The self-capacitive button features a GND shield for enhanced noise immunity, yet if a drop of water forms over the touch electrode and the GND shield, it creates a capacitive component which increases the capacitance and causes a false detection.

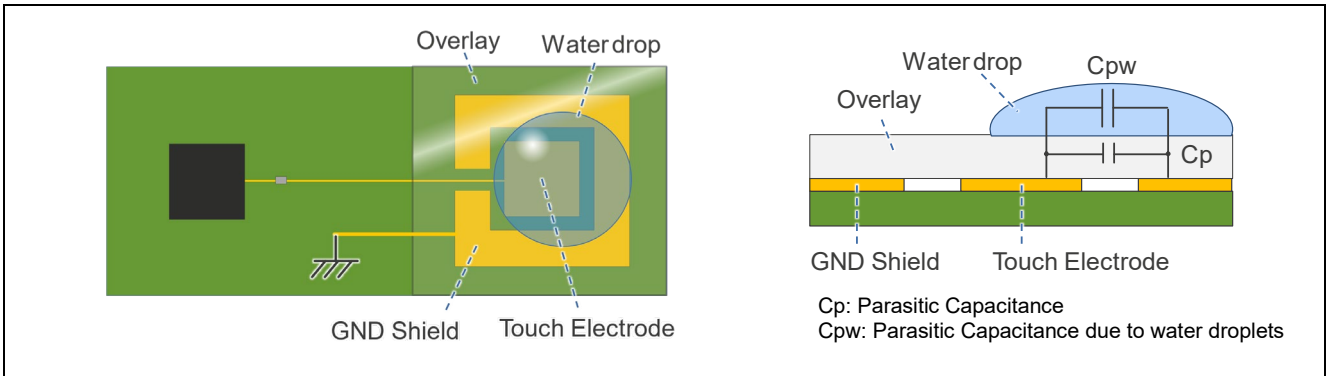

Figure 2-1 Parasitic Capacitance when Water Droplet Adheres to GND Shield Button

As the CTSU estimates the capacitance of a touch electrode from the charge/discharge current, when there is a potential difference in the capacitance component, a charge/discharge current is generated and the button may detect touch (be actuated) even if not actually touched. The CTSU2 resolves this issue by supporting an active shield that drives the shield pattern at the same potential as the electrode, enhancing both the noise immunity and water resistance of the self-capacitance method button. Figure 2-2 shows an image of parasitic capacitance cancellation by the CTSU2’s active shield.

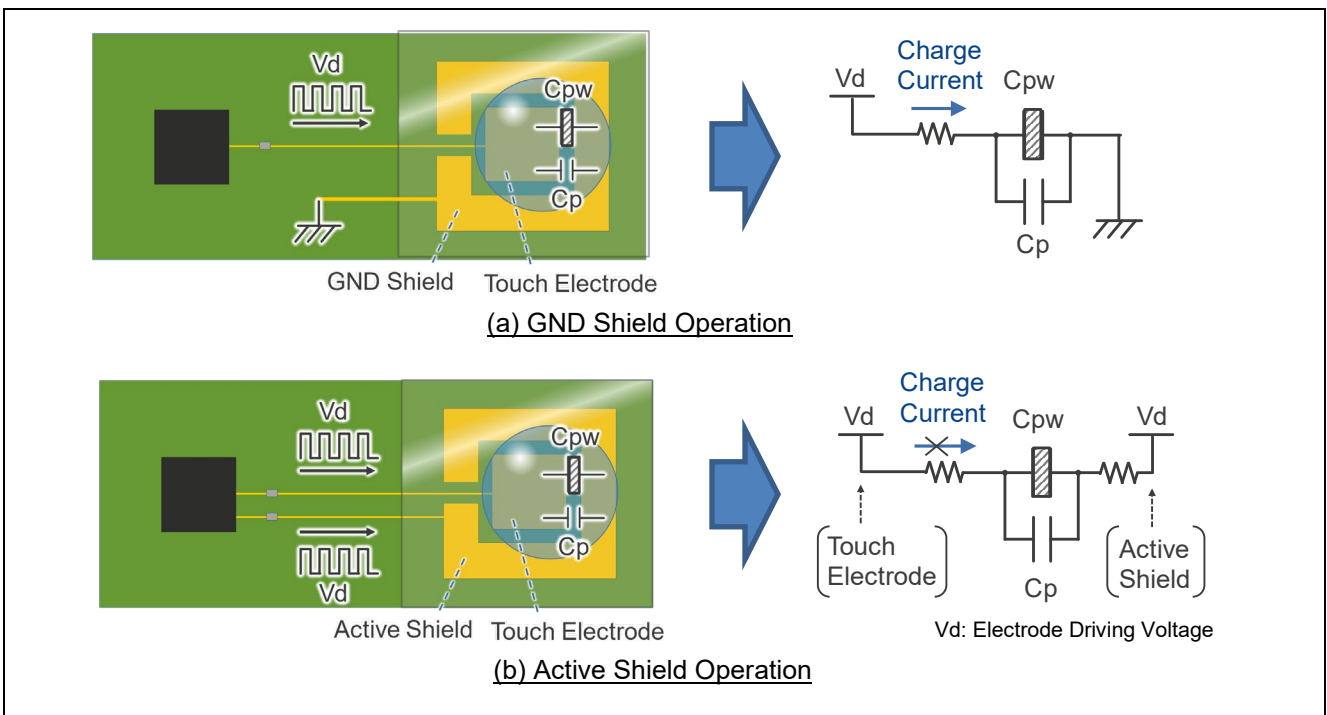

Figure 2-2 Image of Parasitic Capacitance Cancellation on CTSU2 Active Shield Button

Figure 2-3 shows the operations of the CTSU’s non-measured pins. Because the CTSU’s non-measured pins are fixed to low, a false detection may be generated even with no GND pattern surrounding the area if multiple buttons are exposed by water. In the CTSU2, on the other hand, the non-measured and measured pins are driven by the same potential, reducing the possibility of a false detection caused by adjacent button electrodes.

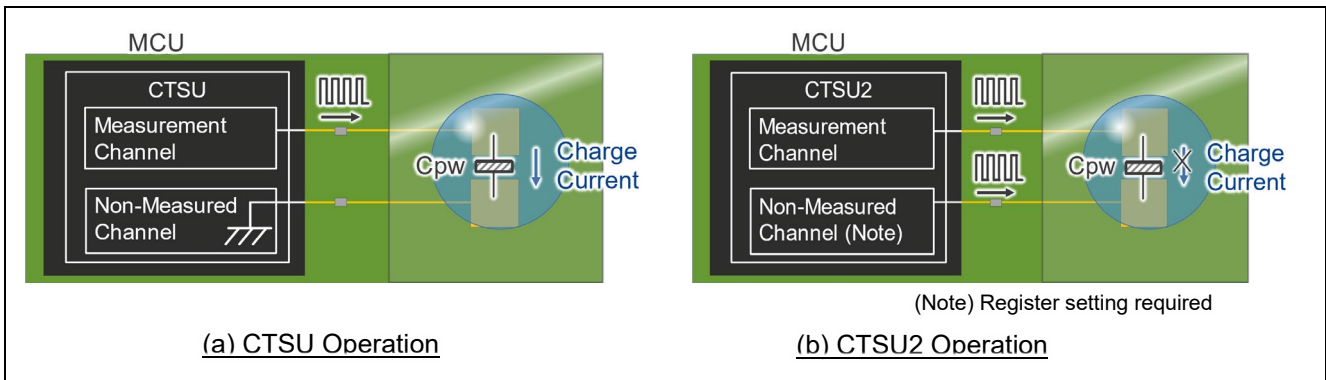

Figure 2-3 CTSU Non-Measured Pin Operations

3. Actual Device Operations

Figure 3-1 shows an external view of the electrode board used in this demo set. The demo board has a GND shield button that can be used with the conventional CTSU and an active shield button that can be used with the CTSU2, allowing a comparative evaluation of waterproof characteristics. In addition, software can be used to turn on the LED that corresponds to each button.

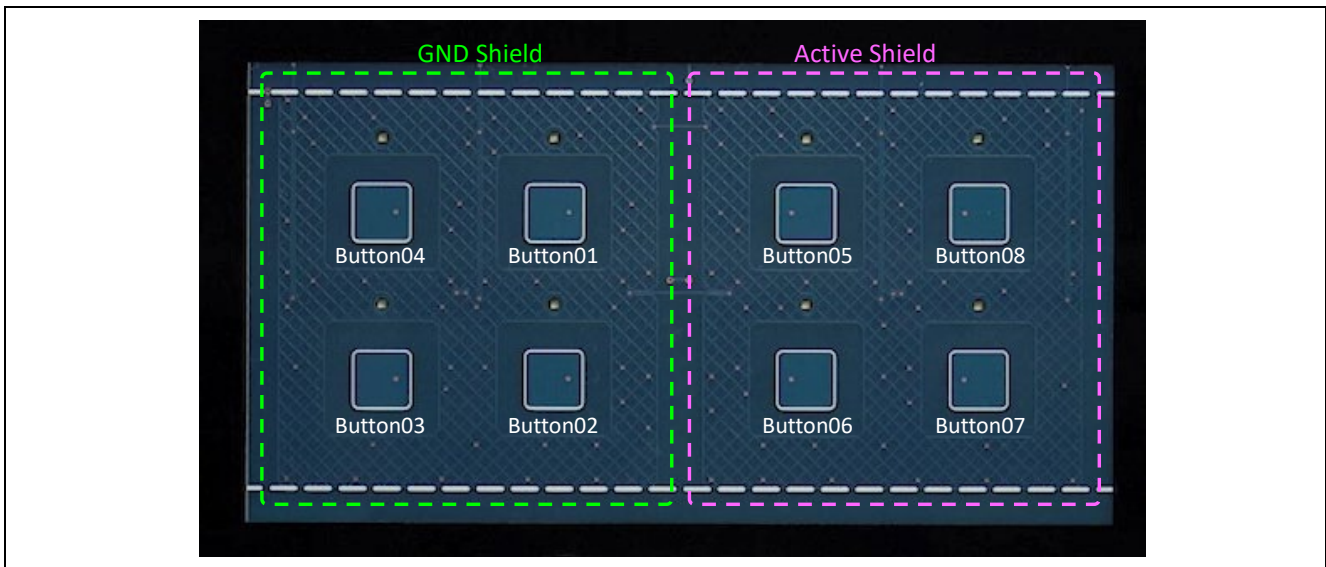

Figure 3-1 Self-Capacitance Touch Electrode Board for Waterproof Evaluation

Figure 3-2 shows the count value waveform when a water droplet adheres to a GND shield button. As the droplet covers both the GDN shield and the buttons, the count value exceeds the threshold and a touch is detected.

- ① No-touch state, initial state
- ② No-touch state, buttons completely covered with water. Touch detected when all buttons exceed threshold.
- ③ Button01 touch detected
- ④ Button02 touch detected
- ⑤ Button03 touch detected
- ⑥ Button04 touch detected



Figure 3-2 Count Value Waveform When Water Droplet Adheres to GND Shield Buttons

Figure 3-3 shows operations when a water droplet adheres to a GND shield button. Due to a false detection, all buttons detect touch (are actuated) and the corresponding LEDs light up.

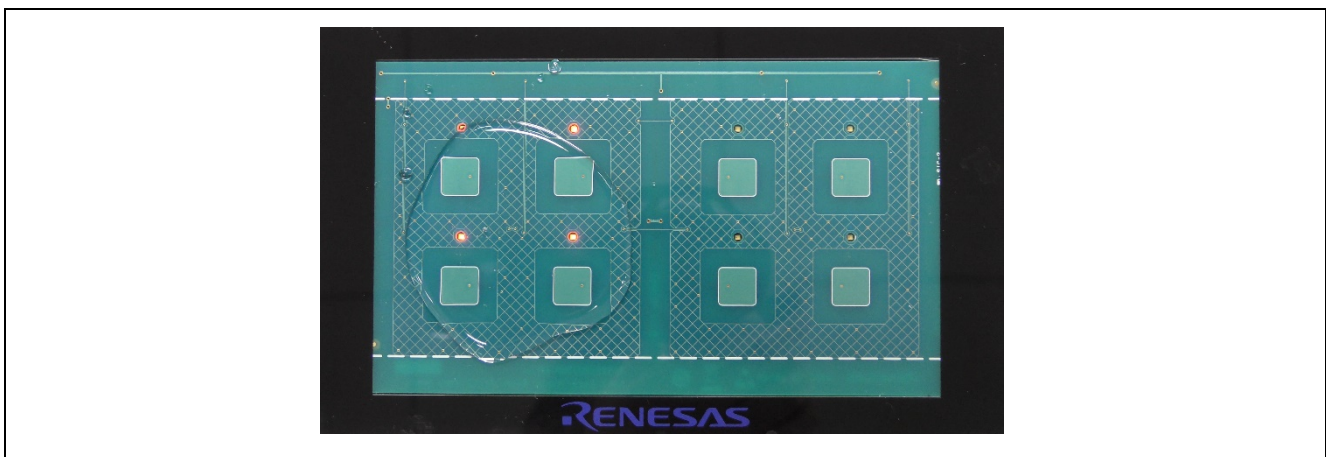

Figure 3-3 Operations when Water Droplet is Adhered to GND Shield Buttons

Figure 3-4 shows the changes in the count value and threshold when a droplet adheres to the active shield buttons. Using the active shield prevents false detections even when the buttons are covered by a droplet.

- ① No-touch state, initial state
- ② No-touch state, buttons completely covered with water.
Touch is not detected (button not actuated) despite the increase in sensor count. The threshold follows the value due to drift correction.
- ③ Button05 touch detected
When the count value for Button05 exceeds the threshold (Threshold05), touch is detected (button is actuated). Although the water droplet causes the count value of other buttons to increase, the value does not exceed the corresponding threshold, and therefore touch is not detected (button is not actuated).
- ④ Button06 touch detected
Operations are the same as with Button05, but due to differing sensitivities, other buttons may exceed their thresholds and falsely detect touch (button is actuated). In such cases, false detection must be prevented by adjusting touch parameters, such as threshold or drift correction interval, or controlling button detection by software.
- ⑤ Button07 touch detected
- ⑥ Button08 touch detected

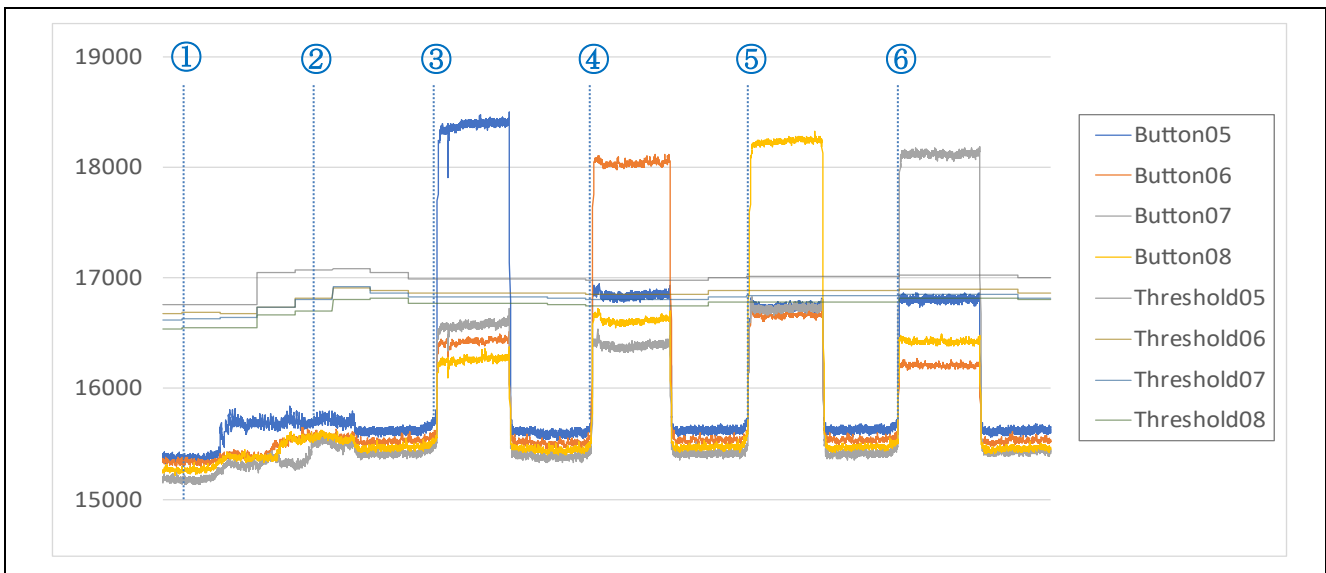

Figure 3-4 Active Shield Button Count Value Waveform

Figure 3-5 shows operations when a droplet is adhered to the active shield button. The active shield prevents the LED from turning ON as the button does not falsely detect touch (not actuated) if covered by a droplet.

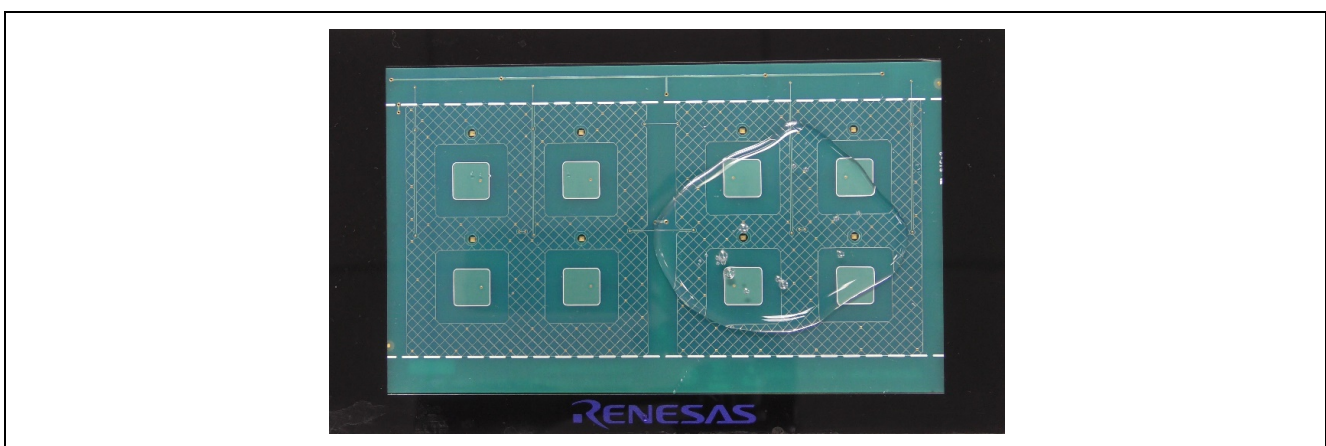

Figure 3-5 Operations when Water Droplet Adheres to Active Shield Buttons

4. Software Specifications

4.1 Operational Overview

Figure 4-1 shows the flowchart for the sample program.

In addition to the project output by the FSP Configurator and the project tuned by the QE for Capacitive Touch, this sample program includes two new functions: maximum count value difference button detection processing for the self-capacitance waterproof button and LED control processing. The periodic timer generates timing to improve touch response and control LEDs. The touch module's config01 and config02 indicate control structures. config01 is for the GND shield button group and config02 is for the active shield button group. For setting details, see 4.8 Touch Interface Settings.

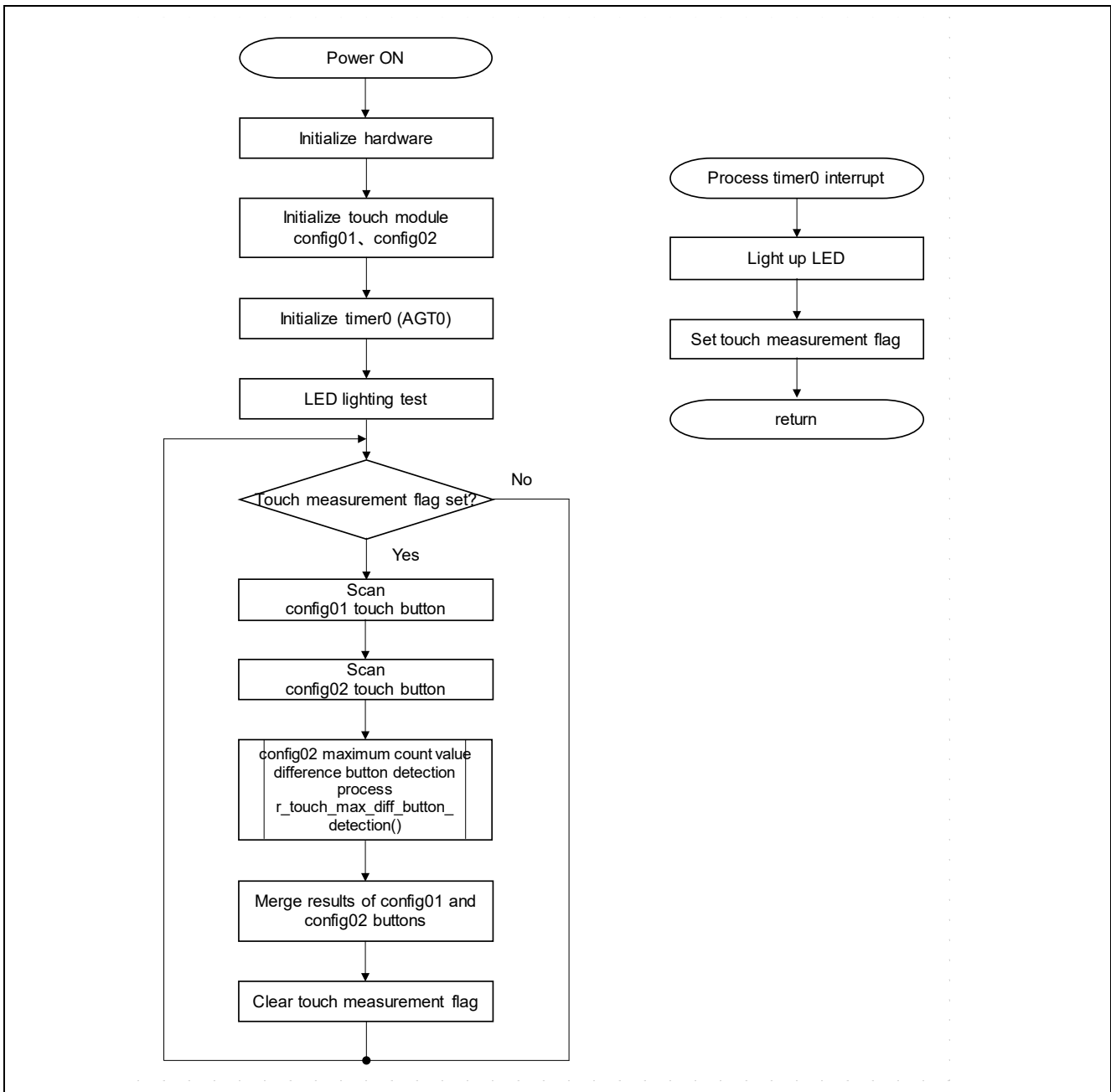

Figure 4-1 Sample Program Flowchart

Figure 4-2 shows the flowchart for the maximum count value difference button detection process. This process detects the channel with the maximum count value when the button defined in the control structure detects a touch, and judges it as the button being pressed. To improve response to continuous press, drift correction for all channels is disabled during button detection.

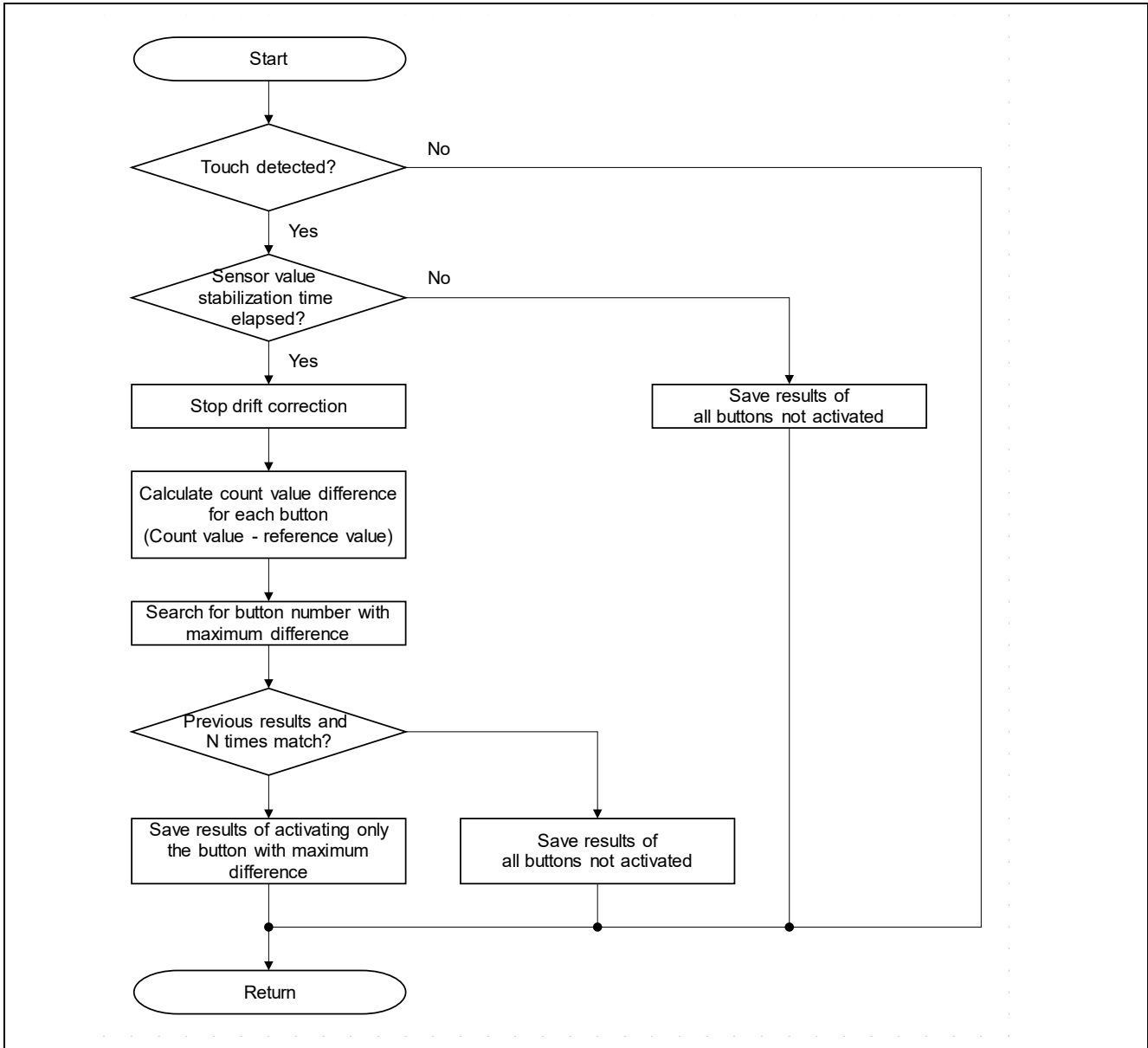

Figure 4-2 Flowchart for Maximum Count Value Difference Button Detection Process

4.2 Operating Environment

Table 4-1 details the conditions for the hardware development environment; Table 4-2 shows the same for the software development environment.

Table 4-1 Hardware Conditions

Item	Specification
CPU board	RA2L1 Cap Touch CPU Board (RTK0EG0018C01001BJ) (RA2L1 Capacitive Touch Evaluation System (RTK0EG0022S01001BJ) included)
MCU used	RA2L1 (R7FA2L1AB2DFP)
Operating frequency	48MHz
Electrode board	<ul style="list-style-type: none"> • Self-Capacitance Touch Electrode Board for Waterproof Evaluation <ul style="list-style-type: none"> — Self-capacitance button (GND shield): 4 buttons — Self-capacitance button (active shield): 4 buttons — LEDs: 8 • FFC conversion board for Capacitive Touch Evaluation System • Overlay: acrylic 2mm
Power supply	5.0V

Table 4-2 Software Development Environment

Item	Specification
Integrated Development Environment (IDE)	Renesas e ² studio Version: 2021-07 (21.7.0)
Compiler	GCC ARM Embedded 9.2.1.20191025
FSP	Version 3.3.0 or later
Capacitive touch sensor development support tool	QE for Capacitive Touch V2.0.0 or later
Emulator	Renesas E2 Lite emulator

4.3 File Structure

Table 4-3 displays the project file structure. The types of files generated by the FSP Smart Configurator and QE for Capacitive Touch have been omitted for brevity. Similarly, the software descriptions for LED control have been omitted from this document.

Table 4-3 Project File Structure

Folder/File Name	Description of Change
Project	-
qe_gen (file structure omitted)	-
ra (file structure omitted)	-
ra_gen (file structure omitted)	-
src	-
hal_entry.c	Main function was added to demo program.
r_touch_waterproof_demo.c	Source code for controlling the demo set was added.
r_touch_waterproof_demo_led.c	Source code for LED control was added. Description not included in this document.
r_touch_waterproof_demo_led.h	Header file for LED control was added. Description not included in this document.
QE_Touch (file structure omitted)	-
ra_cfg (file structure omitted)	-
script (file structure omitted)	-

-: no change

4.4 List of Functions

Table 4-4 lists the functions used in r_touch_waterproof_demo.c.

Table 4-4 r_touch_waterproof_demo.c Functions

Function Name	Description
r_touch_waterproof_demo_main()	Demo program main function
r_touch_max_diff_button()	Maximum count value difference button detection function
r_timer0_callback	AGT0 interrupt function

4.4.1 r_touch_waterproof_demo_main

This is the main routine for the sample program.

Format

```
void r_touch_waterproof_demo_main(void)
```

Argument

None

Return value

None

Description

This is the main routine for the sample program

4.4.1 r_touch_max_diff_button

Only the button that has the largest count value difference among the buttons defined in the control structure is actuated (touch detected).

Format

```
void r_touch_max_diff_button_detection(ctsu_ctrl_t * const p_ctrl, uint64_t * p_data)
```

Argument

ctsu_ctrl_t * const p_ctrl

Pointer to control structure (normally generated by QE for Capacitive Touch)

uint64_t * p_data

Pointer to button storing the button detection results

Return Value

None

Description

Only the button that has the largest count value difference among the buttons defined in the control structure is actuated (touch detected).

Specify the pointers for target button's control structure and button detection results in the argument.

Call this function after executing the touch module's RM_TOUCH_ScanStart() and RM_TOUCH_DagtaGet() functions.

4.4.2 r_timer0_callback

AGT0 module interrupt handling

Format

```
void r_timer0_callback(timer_callback_args_t * p_args)
```

Argument

timer_callback_args_t * p_args

Callback function parameter data

Return value

None

Description

This function handles the AGT0 interrupt. For this sample software, the function controls the LEDs and the touch detection processing execution flag.

4.5 List of Constants

Table 4-5 lists the constants used in `r_touch_waterproof_demo.c`.

Table 4-5 `r_touch_waterproof_demo.c` Constants

Constant Name	Initial Value	Description
TOUCH_SCAN_10ms_COUNT	2	Number of counts per 10ms interval
TOUCH_SCAN_INTERVAL	TOUCH_SCAN_10ms_COUNT	Sets the touch detection interval. The interval for this sample software is set to the set value x 5ms.
TOUCH_BUTTON_MVA_COUNT	4	Sets the moving average sample count for the touch middleware using the count value at which the sensor count value stabilizes. Normally, this is the same value as the control structure moving average count (<code>num_moving_average</code> of <code>touch_cfg_t</code>).
TOUCH_MAX_DIFF_BUTTON_DEBOUNCE_COUNT	4	Specifies the number of chatter removal samples for the maximum count value difference button detection processing. This constant is set independently of the number of consecutive match measurements in the control structure (<code>on_freq</code> and <code>off_freq</code> of <code>touch_cfg_t</code>).

4.6 List of Variations

Table 4-6 lists the variations used in `r_touch_waterproof_demo.c`.

Table 4-6 `r_touch_waterproof_demo.c` Variations

Variation Name	Type	Initial value	Description
button_status	uint64_t	0	Stores the touch button detection results.
g_touch_scan_wait	uint8_t	0	Counts the number of waits until the touch detection interval.
g_touch_scan_flag	uint8_t	0	Touch detection interval flag 0: Do not execute touch detection process 1: Execute touch detection process

4.7 MCU Resources Used in Application

Table 4-7 lists the MCU resources used in application.

Table 4-7 MCU Resources Used in Application

Module Name	Port Name	Use
IOPORT	P104 P105 P102 P103 P100 P012	LED control
CTSU	TS0 TS8-CFC TS9-CFC TS11-CFC	Touch detection pin (GND shield button group)
	TS2-CFC TS5 TS6 TS7	Touch detection pin (Active shield button group)
	TS4	Active shield output pin
AGT0	—	5ms interval timer

4.8 Touch Interface Settings

Figure 4-3 shows the touch interface settings. Figure 4-4 shows the structure (method) settings. The touch interface structure (method) assigns the GND shield button group to config01 and the active shield button group to config02.



Figure 4-3 Touch Interface Settings

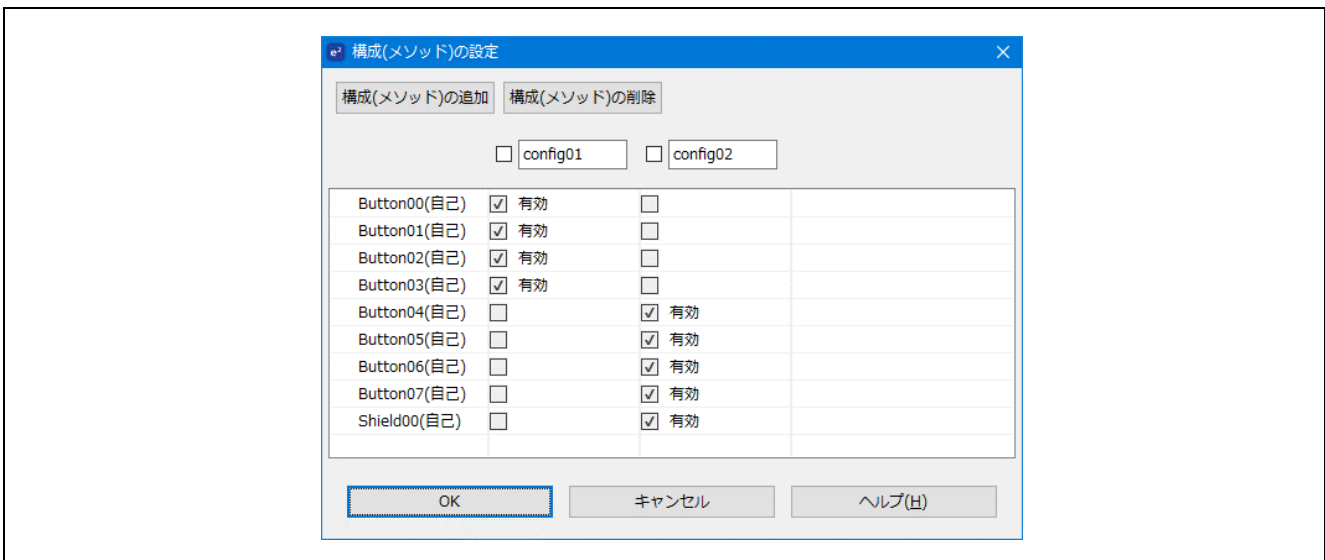

Figure 4-4 Structure (Method) Settings

4.9 Button Sensitivity Adjustment

Button sensitivity is adjusted with QE for Capacitive Touch. For details on how to make adjustments, please follow the QE for Capacitive Touch tutorial.

Revision History

Rev.	Date	Description	
		Page	Summary
1.0	Sep.30.21	-	First edition issued

General Precautions in the Handling of Microprocessing Unit and Microcontroller Unit Products

The following usage notes are applicable to all Microprocessing unit and Microcontroller unit products from Renesas. For detailed usage notes on the products covered by this document, refer to the relevant sections of the document as well as any technical updates that have been issued for the products.

1. Precaution against Electrostatic Discharge (ESD)

A strong electrical field, when exposed to a CMOS device, can cause destruction of the gate oxide and ultimately degrade the device operation. Steps must be taken to stop the generation of static electricity as much as possible, and quickly dissipate it when it occurs. Environmental control must be adequate. When it is dry, a humidifier should be used. This is recommended to avoid using insulators that can easily build up static electricity.

Semiconductor devices must be stored and transported in an anti-static container, static shielding bag or conductive material. All test and measurement tools including work benches and floors must be grounded. The operator must also be grounded using a wrist strap. Semiconductor devices must not be touched with bare hands. Similar precautions must be taken for printed circuit boards with mounted semiconductor devices.

2. Processing at power-on

The state of the product is undefined at the time when power is supplied. The states of internal circuits in the LSI are indeterminate and the states of register settings and pins are undefined at the time when power is supplied. In a finished product where the reset signal is applied to the external reset pin, the states of pins are not guaranteed from the time when power is supplied until the reset process is completed. In a similar way, the states of pins in a product that is reset by an on-chip power-on reset function are not guaranteed from the time when power is supplied until the power reaches the level at which resetting is specified.

3. Input of signal during power-off state

Do not input signals or an I/O pull-up power supply while the device is powered off. The current injection that results from input of such a signal or I/O pull-up power supply may cause malfunction and the abnormal current that passes in the device at this time may cause degradation of internal elements. Follow the guideline for input signal during power-off state as described in your product documentation.

4. Handling of unused pins

Handle unused pins in accordance with the directions given under handling of unused pins in the manual. The input pins of CMOS products are generally in the high-impedance state. In operation with an unused pin in the open-circuit state, extra electromagnetic noise is induced in the vicinity of the LSI, an associated shoot-through current flows internally, and malfunctions occur due to the false recognition of the pin state as an input signal become possible.

5. Clock signals

After applying a reset, only release the reset line after the operating clock signal becomes stable. When switching the clock signal during program execution, wait until the target clock signal is stabilized. When the clock signal is generated with an external resonator or from an external oscillator during a reset, ensure that the reset line is only released after full stabilization of the clock signal. Additionally, when switching to a clock signal produced with an external resonator or by an external oscillator while program execution is in progress, wait until the target clock signal is stable.

6. Voltage application waveform at input pin

Waveform distortion due to input noise or a reflected wave may cause malfunction. If the input of the CMOS device stays in the area between V_{IL} (Max.) and V_{IH} (Min.) due to noise, for example, the device may malfunction. Take care to prevent chattering noise from entering the device when the input level is fixed, and also in the transition period when the input level passes through the area between V_{IL} (Max.) and V_{IH} (Min.).

7. Prohibition of access to reserved addresses

Access to reserved addresses is prohibited. The reserved addresses are provided for possible future expansion of functions. Do not access these addresses as the correct operation of the LSI is not guaranteed.

8. Differences between products

Before changing from one product to another, for example to a product with a different part number, confirm that the change will not lead to problems. The characteristics of a microprocessing unit or microcontroller unit products in the same group but having a different part number might differ in terms of internal memory capacity, layout pattern, and other factors, which can affect the ranges of electrical characteristics, such as characteristic values, operating margins, immunity to noise, and amount of radiated noise. When changing to a product with a different part number, implement a system-evaluation test for the given product.

Notice

1. Descriptions of circuits, software and other related information in this document are provided only to illustrate the operation of semiconductor products and application examples. You are fully responsible for the incorporation or any other use of the circuits, software, and information in the design of your product or system. Renesas Electronics disclaims any and all liability for any losses and damages incurred by you or third parties arising from the use of these circuits, software, or information.
2. Renesas Electronics hereby expressly disclaims any warranties against and liability for infringement or any other claims involving patents, copyrights, or other intellectual property rights of third parties, by or arising from the use of Renesas Electronics products or technical information described in this document, including but not limited to, the product data, drawings, charts, programs, algorithms, and application examples.
3. No license, express, implied or otherwise, is granted hereby under any patents, copyrights or other intellectual property rights of Renesas Electronics or others.
4. You shall be responsible for determining what licenses are required from any third parties, and obtaining such licenses for the lawful import, export, manufacture, sales, utilization, distribution or other disposal of any products incorporating Renesas Electronics products, if required.
5. You shall not alter, modify, copy, or reverse engineer any Renesas Electronics product, whether in whole or in part. Renesas Electronics disclaims any and all liability for any losses or damages incurred by you or third parties arising from such alteration, modification, copying or reverse engineering.
6. Renesas Electronics products are classified according to the following two quality grades: "Standard" and "High Quality". The intended applications for each Renesas Electronics product depends on the product's quality grade, as indicated below.

"Standard": Computers; office equipment; communications equipment; test and measurement equipment; audio and visual equipment; home electronic appliances; machine tools; personal electronic equipment; industrial robots; etc.

"High Quality": Transportation equipment (automobiles, trains, ships, etc.); traffic control (traffic lights); large-scale communication equipment; key financial terminal systems; safety control equipment; etc.

Unless expressly designated as a high reliability product or a product for harsh environments in a Renesas Electronics data sheet or other Renesas Electronics document, Renesas Electronics products are not intended or authorized for use in products or systems that may pose a direct threat to human life or bodily injury (artificial life support devices or systems; surgical implantations; etc.), or may cause serious property damage (space system; undersea repeaters; nuclear power control systems; aircraft control systems; key plant systems; military equipment; etc.). Renesas Electronics disclaims any and all liability for any damages or losses incurred by you or any third parties arising from the use of any Renesas Electronics product that is inconsistent with any Renesas Electronics data sheet, user's manual or other Renesas Electronics document.
7. No semiconductor product is absolutely secure. Notwithstanding any security measures or features that may be implemented in Renesas Electronics hardware or software products, Renesas Electronics shall have absolutely no liability arising out of any vulnerability or security breach, including but not limited to any unauthorized access to or use of a Renesas Electronics product or a system that uses a Renesas Electronics product. RENESAS ELECTRONICS DOES NOT WARRANT OR GUARANTEE THAT RENESAS ELECTRONICS PRODUCTS, OR ANY SYSTEMS CREATED USING RENESAS ELECTRONICS PRODUCTS WILL BE INVULNERABLE OR FREE FROM CORRUPTION, ATTACK, VIRUSES, INTERFERENCE, HACKING, DATA LOSS OR THEFT, OR OTHER SECURITY INTRUSION ("Vulnerability Issues"). RENESAS ELECTRONICS DISCLAIMS ANY AND ALL RESPONSIBILITY OR LIABILITY ARISING FROM OR RELATED TO ANY VULNERABILITY ISSUES. FURTHERMORE, TO THE EXTENT PERMITTED BY APPLICABLE LAW, RENESAS ELECTRONICS DISCLAIMS ANY AND ALL WARRANTIES, EXPRESS OR IMPLIED, WITH RESPECT TO THIS DOCUMENT AND ANY RELATED OR ACCOMPANYING SOFTWARE OR HARDWARE, INCLUDING BUT NOT LIMITED TO THE IMPLIED WARRANTIES OF MERCHANTABILITY, OR FITNESS FOR A PARTICULAR PURPOSE.
8. When using Renesas Electronics products, refer to the latest product information (data sheets, user's manuals, application notes, "General Notes for Handling and Using Semiconductor Devices" in the reliability handbook, etc.), and ensure that usage conditions are within the ranges specified by Renesas Electronics with respect to maximum ratings, operating power supply voltage range, heat dissipation characteristics, installation, etc. Renesas Electronics disclaims any and all liability for any malfunctions, failure or accident arising out of the use of Renesas Electronics products outside of such specified ranges.
9. Although Renesas Electronics endeavors to improve the quality and reliability of Renesas Electronics products, semiconductor products have specific characteristics, such as the occurrence of failure at a certain rate and malfunctions under certain use conditions. Unless designated as a high reliability product or a product for harsh environments in a Renesas Electronics data sheet or other Renesas Electronics document, Renesas Electronics products are not subject to radiation resistance design. You are responsible for implementing safety measures to guard against the possibility of bodily injury, injury or damage caused by fire, and/or danger to the public in the event of a failure or malfunction of Renesas Electronics products, such as safety design for hardware and software, including but not limited to redundancy, fire control and malfunction prevention, appropriate treatment for aging degradation or any other appropriate measures. Because the evaluation of microcomputer software alone is very difficult and impractical, you are responsible for evaluating the safety of the final products or systems manufactured by you.
10. Please contact a Renesas Electronics sales office for details as to environmental matters such as the environmental compatibility of each Renesas Electronics product. You are responsible for carefully and sufficiently investigating applicable laws and regulations that regulate the inclusion or use of controlled substances, including without limitation, the EU RoHS Directive, and using Renesas Electronics products in compliance with all these applicable laws and regulations. Renesas Electronics disclaims any and all liability for damages or losses occurring as a result of your noncompliance with applicable laws and regulations.
11. Renesas Electronics products and technologies shall not be used for or incorporated into any products or systems whose manufacture, use, or sale is prohibited under any applicable domestic or foreign laws or regulations. You shall comply with any applicable export control laws and regulations promulgated and administered by the governments of any countries asserting jurisdiction over the parties or transactions.
12. It is the responsibility of the buyer or distributor of Renesas Electronics products, or any other party who distributes, disposes of, or otherwise sells or transfers the product to a third party, to notify such third party in advance of the contents and conditions set forth in this document.
13. This document shall not be reprinted, reproduced or duplicated in any form, in whole or in part, without prior written consent of Renesas Electronics.
14. Please contact a Renesas Electronics sales office if you have any questions regarding the information contained in this document or Renesas Electronics products.

(Note1) "Renesas Electronics" as used in this document means Renesas Electronics Corporation and also includes its directly or indirectly controlled subsidiaries.

(Note2) "Renesas Electronics product(s)" means any product developed or manufactured by or for Renesas Electronics.

(Rev.5.0-1 October 2020)

Corporate Headquarters

TOYOSU FORESIA, 3-2-24 Toyosu,
Koto-ku, Tokyo 135-0061, Japan
www.renesas.com

Trademarks

Renesas and the Renesas logo are trademarks of Renesas Electronics Corporation. All trademarks and registered trademarks are the property of their respective owners.

Contact information

For further information on a product, technology, the most up-to-date version of a document, or your nearest sales office, please visit:
www.renesas.com/contact/.