

Renesas RA Family

QE for Capacitive Touch usage for Keil® MDK

Introduction

This document will demonstrate how to generate QE code for Capacitive Touch in e² studio and copy QE code to Keil® MDK for ARM using Renesas RA Microcontrollers.

Target Device

Capacitive Touch Evaluation System for RA2L1 (RSSK RA2L1)

Operating Environment

IDE	Keil® Microcontroller Development Kit Version 5.36 or later e ² studio version 2021-10 is used for Capacitive Touch tuning and code generation
Configuration Tool	RA Smart Configurator (RA SC) v2021-10 and FSP v3.5.0
Toolchains	GNU Arm Embedded Toolchain: 10.3-2021.10 (GNU ARM Embedded 10.3.1.20210824)
QE	Renesas QE for Capacitive Touch v3.0.1

Note: Please download and install tools from the following URL in advance.

- Renesas QE download site:
<https://www.renesas.com/software-tool/qe-tools-particular-applications>
- FSP with e² studio installer download site:
<https://github.com/renesas/fsp/releases>
- Keil® MDK Getting Started site:
<https://www2.keil.com/mdk5/install>

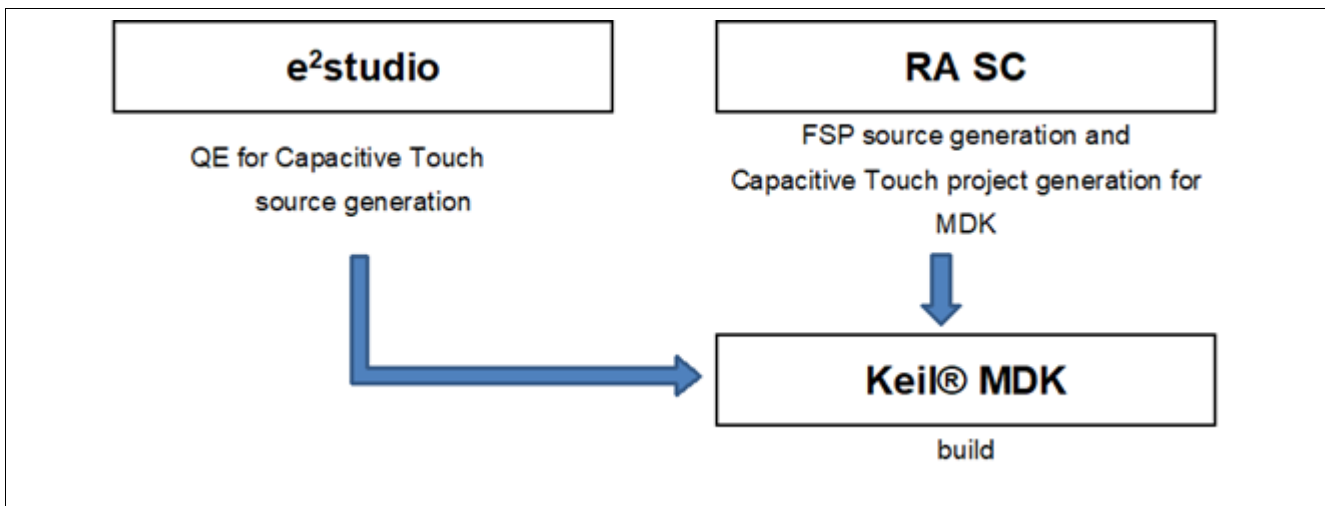

Figure 1. Configuration diagram when using QE for Capacitive Touch with Keil® MDK

Contents

1. Creating a project in e ² studio.....	3
2. Create Capacitive Touch Configuration in e ² studio.....	6
3. Capacitive Touch Tuning in e ² studio.....	12
4. Creating new project in Keil® MDK.....	16
5. Adding TOUCH Driver in Keil® MDK	21
6. Copying QE files to Keil® MDK	23
7. Run Capacitive Touch Project in Keil® MDK.....	26
Revision History.....	30

1. Creating a project in e² studio

A project generation wizard is available in e² studio to generate an RA project with a project name and the associated device and board, including board-level drivers.

Start the e² studio application and choose a workspace folder in the Workspace Launcher. To create a new RA project, follow these steps:

1. Select **File > New > C/C++ Project**.
2. Select the **Renesas RA: Renesas RA C/C++ Project** template. Click **Next** to continue.

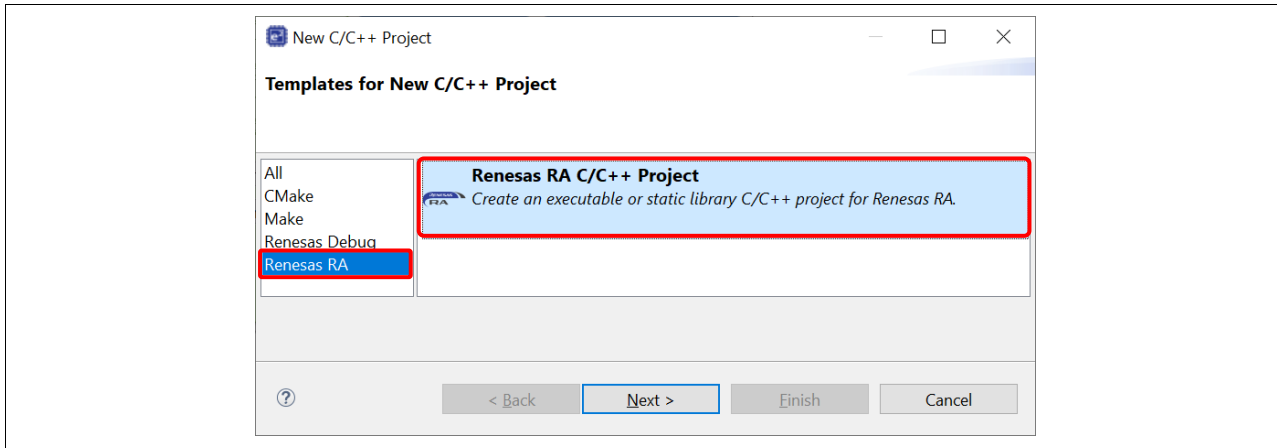

Figure 2. Templates Selection

3. In the next dialog box, enter a project name and click **Next**.

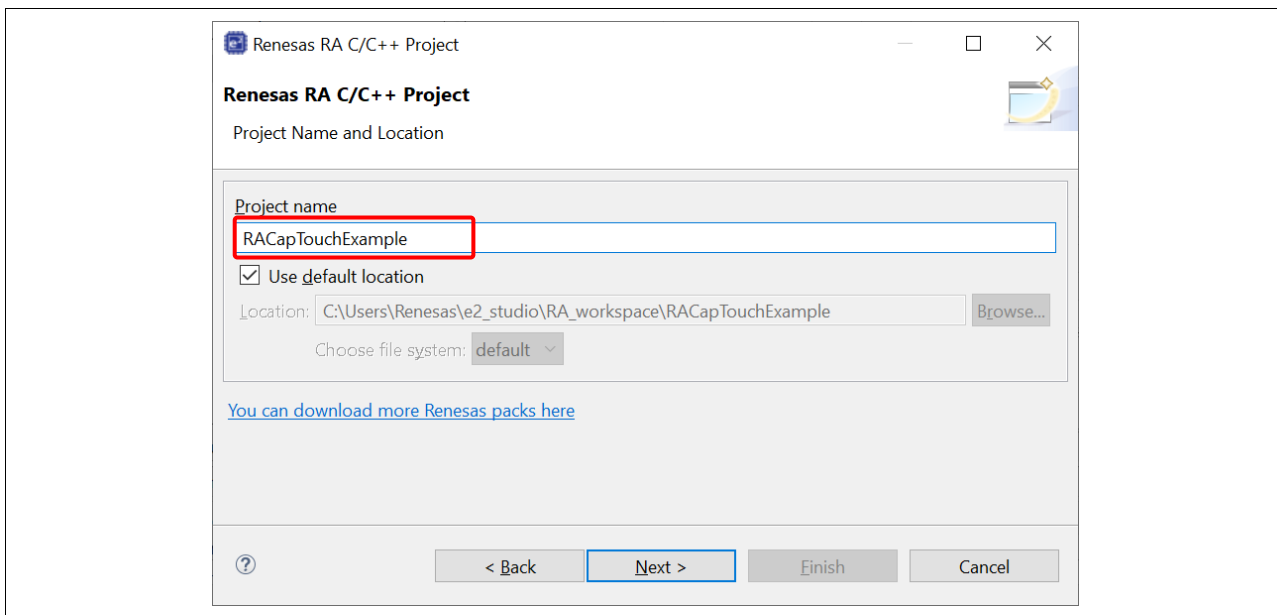

Figure 3. Project Name and Location

4. In the device selection dialog, enter device and tool information:
 - FSP version: **3.5.0**
 - Board: **RSSK-RA2L1**
 - Device: Auto selected
 - Language: **C**
 - Toolchain version: Latest GNU Arm Embedded Toolchain approved for use with Renesas RA. (for example, GCC ARM Embedded 10.3.1.20210824)
 - Debugger: **J-Link ARM**
 - Click **Next** to continue

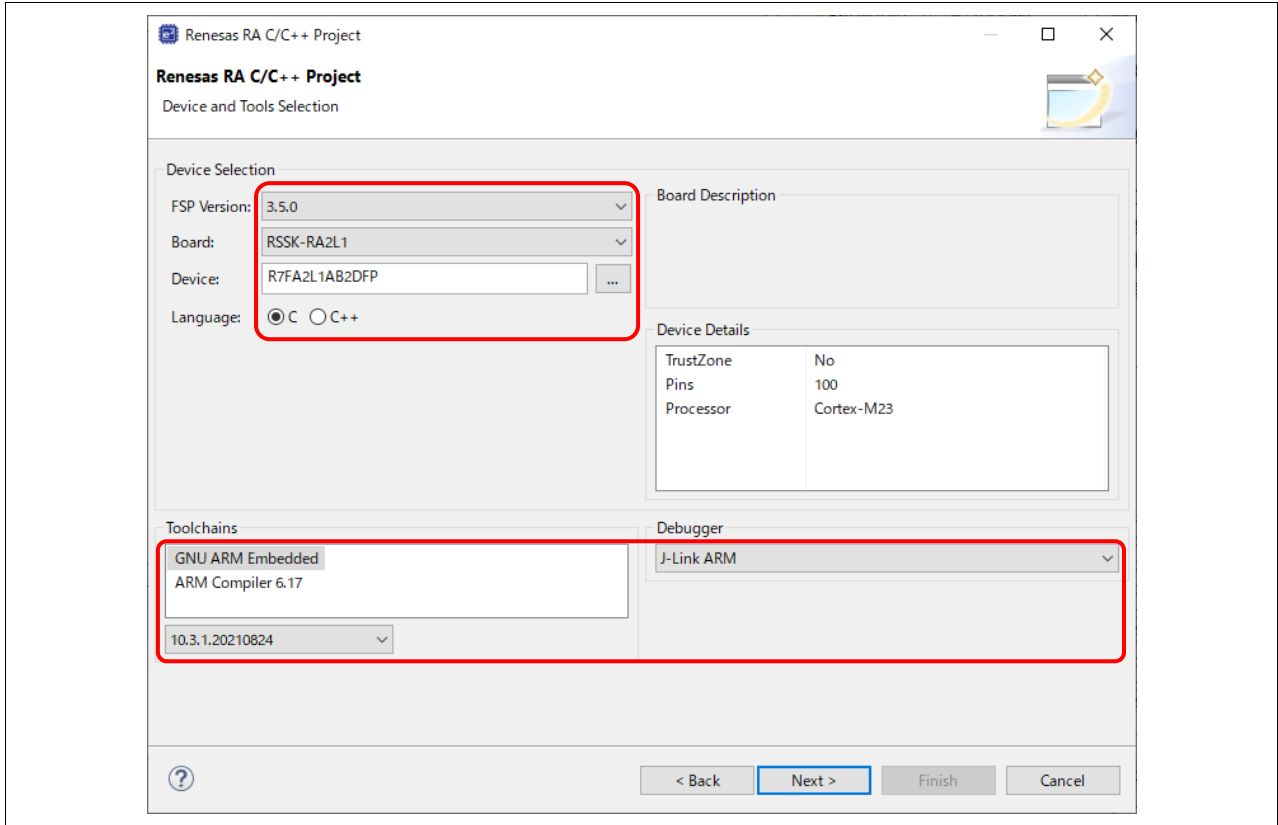

Figure 4. Create New Project for RSSK-RA2L1

5. Build Artifact Selection: **Executable**
 RTOS Selection: **No RTOS**

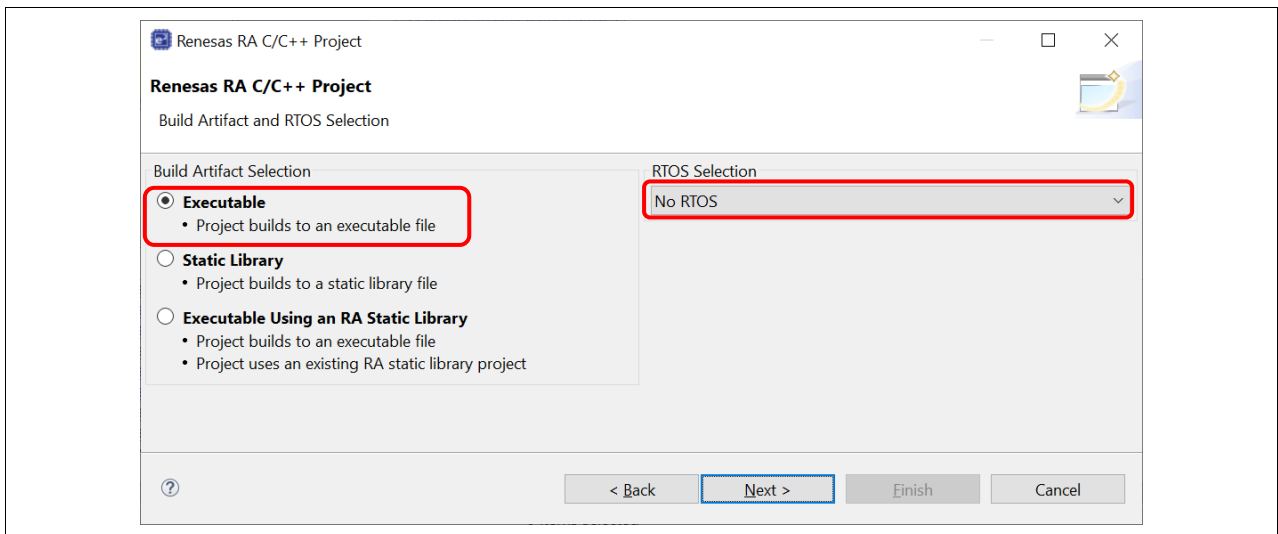

Figure 5. Build Artifact and RTOS Selection

6. In the project template dialog, select **Bare Metal - Minimal** and click **Finish**.

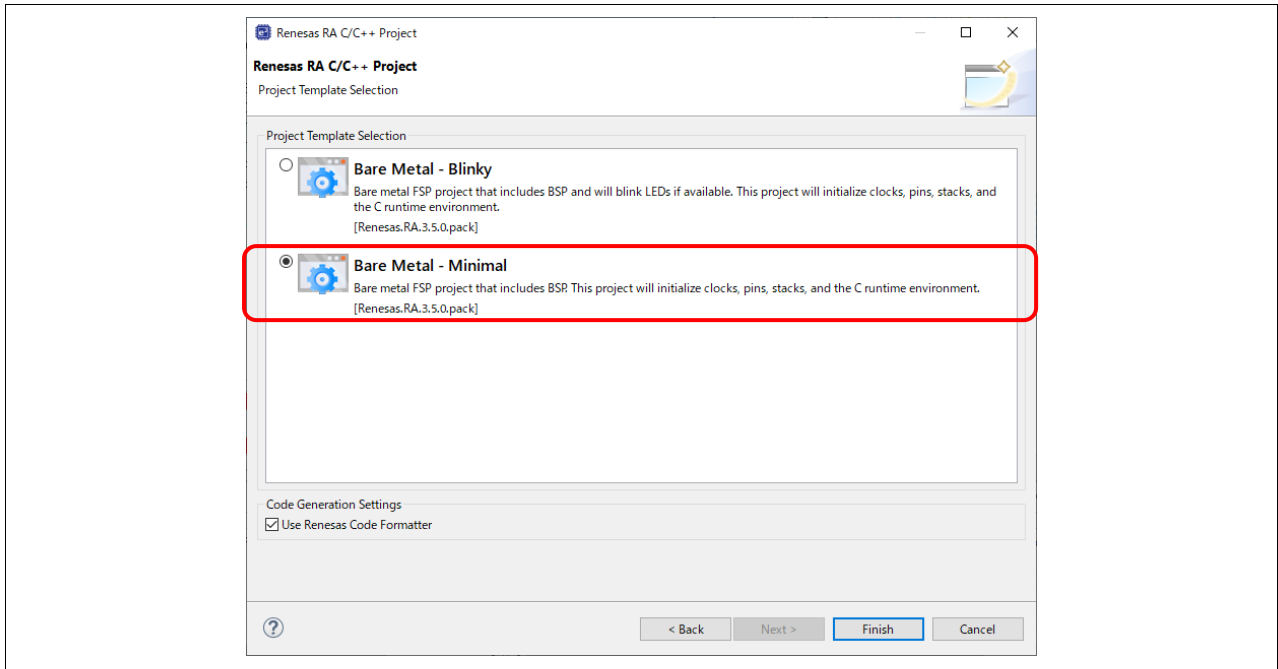

Figure 6. Project Template Selection

7. Once template selection is complete, e² studio creates a new project with the **FSP Configuration** perspective open and ready for project configuration.

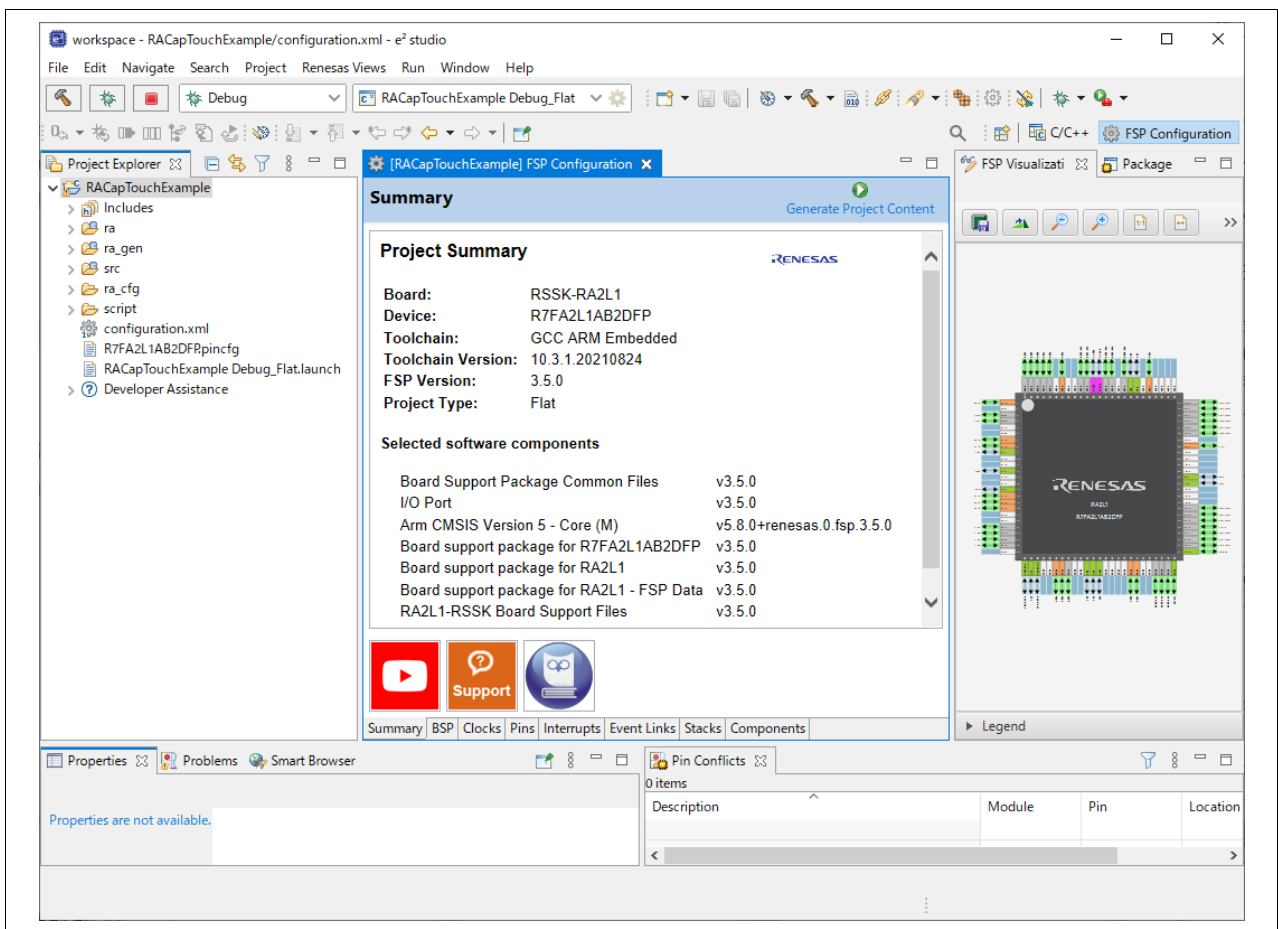

Figure 7. New Project for RSSK RA2L1

2. Create Capacitive Touch Configuration in e² studio

1. If you have not installed the QE for Capacitive Touch, select **Renesas Views > Renesas Software Installer** from the menu of e² studio to install it.
2. In the **Renesas Software Installer** dialog box, select **Renesas QE**, then click **Next**.
3. Select **QE for Capacitive Touch** and click **Finish** to install it.

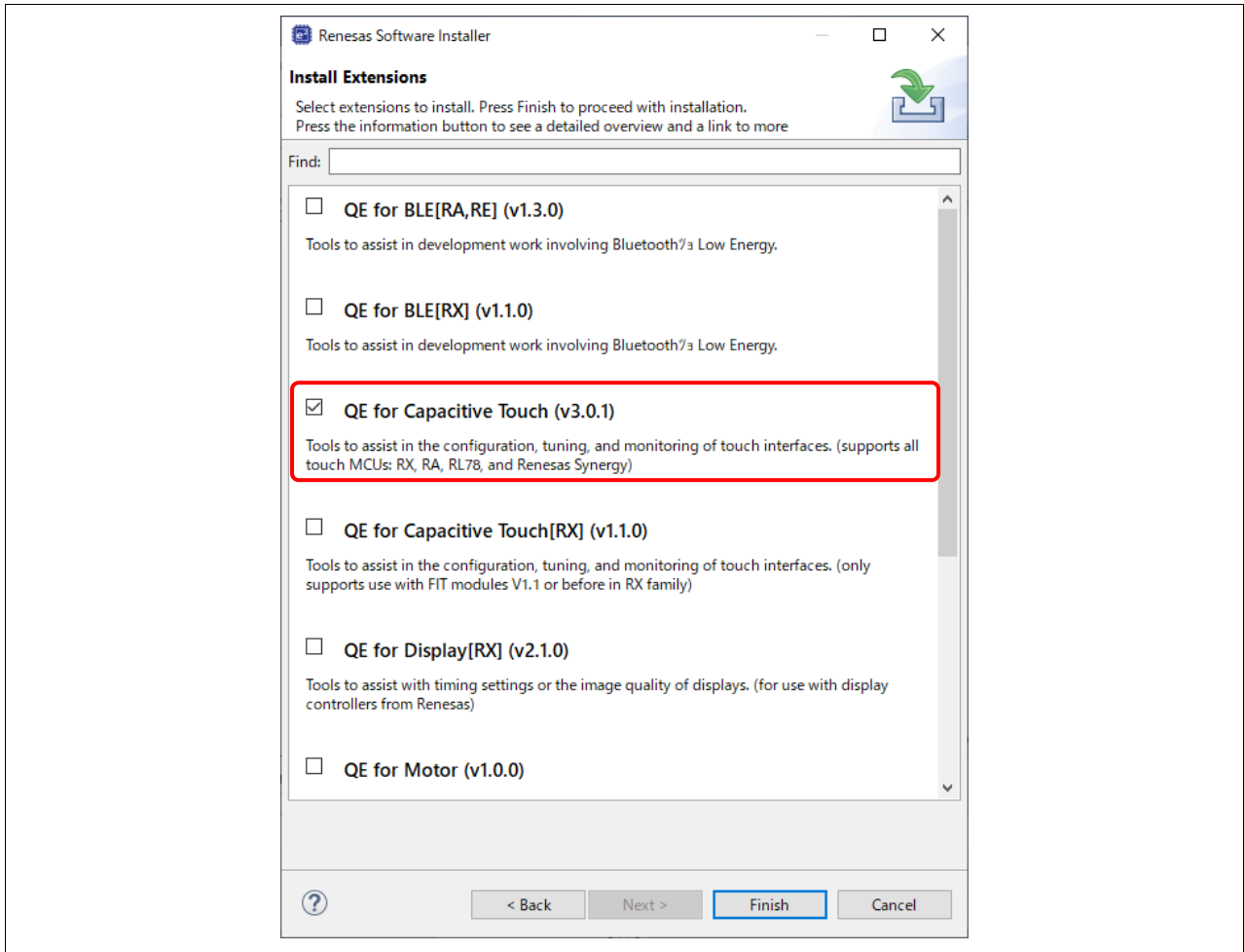

Figure 8. Install QE for Capacitive Touch

4. From the menu of e² studio, select **Renesas Views > Renesas QE > CapTouch Main (QE)** to open the main perspective for configuring Capacitive Touch to the project.

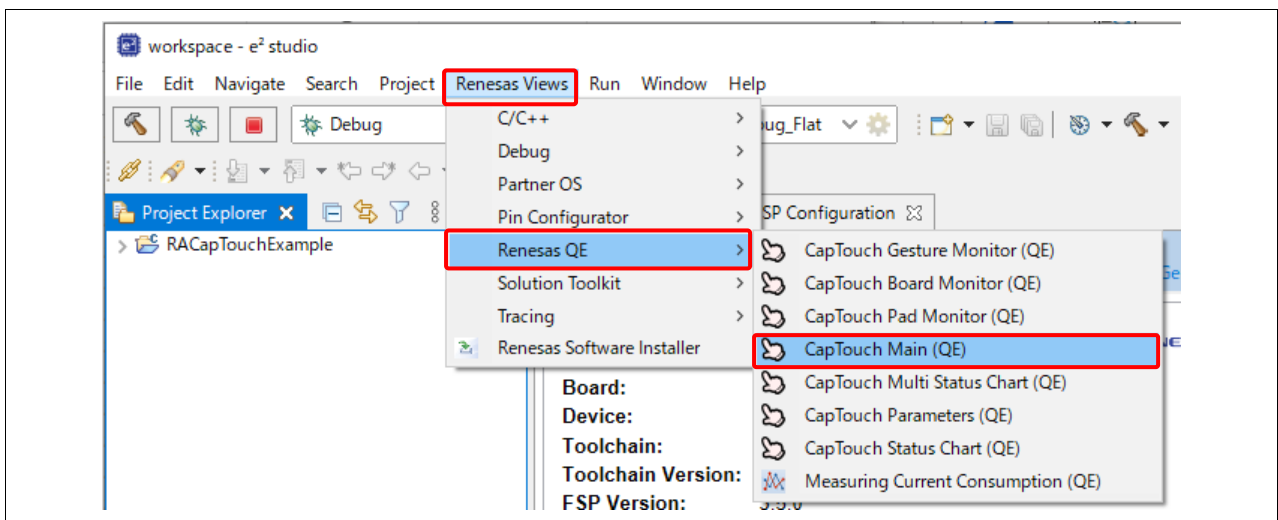

Figure 9. Open CapTouch Main (QE)

- In the **CapTouch Main (QE)** pane, select the project to configure the Touch interface for by using the pull-down tab and selecting the **RACapTouchExample** project as shown below.

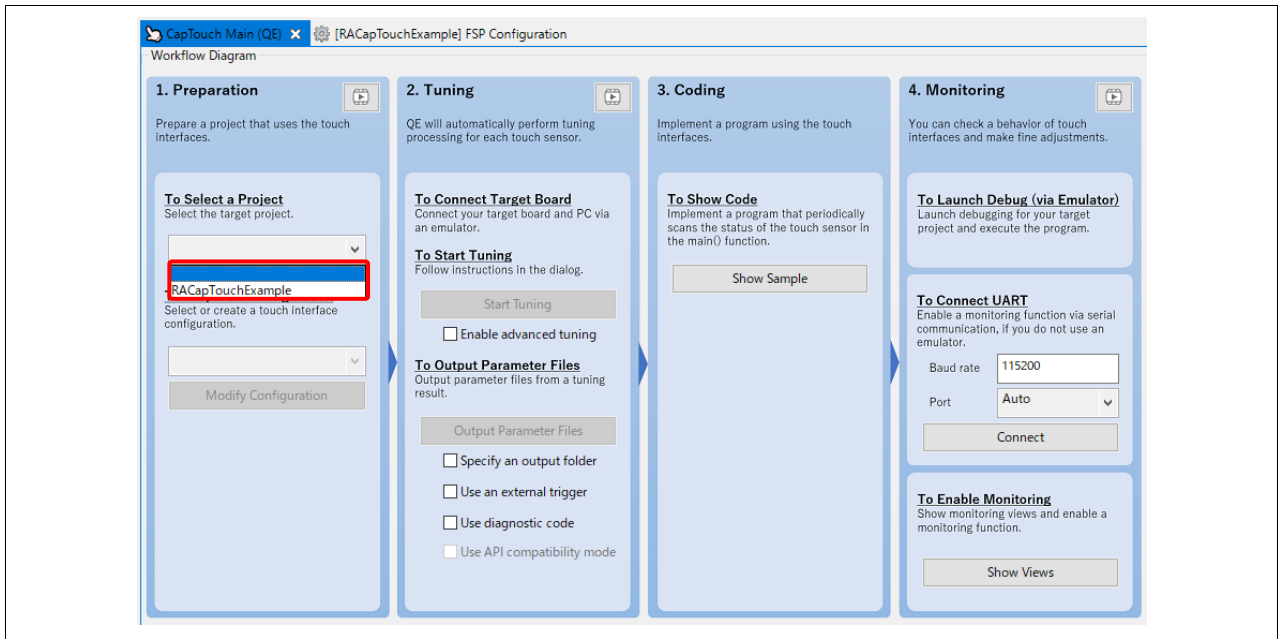

Figure 10. Select Project

- Create a new Touch configuration by using the lower pull-down and selecting **Create a new configuration**.

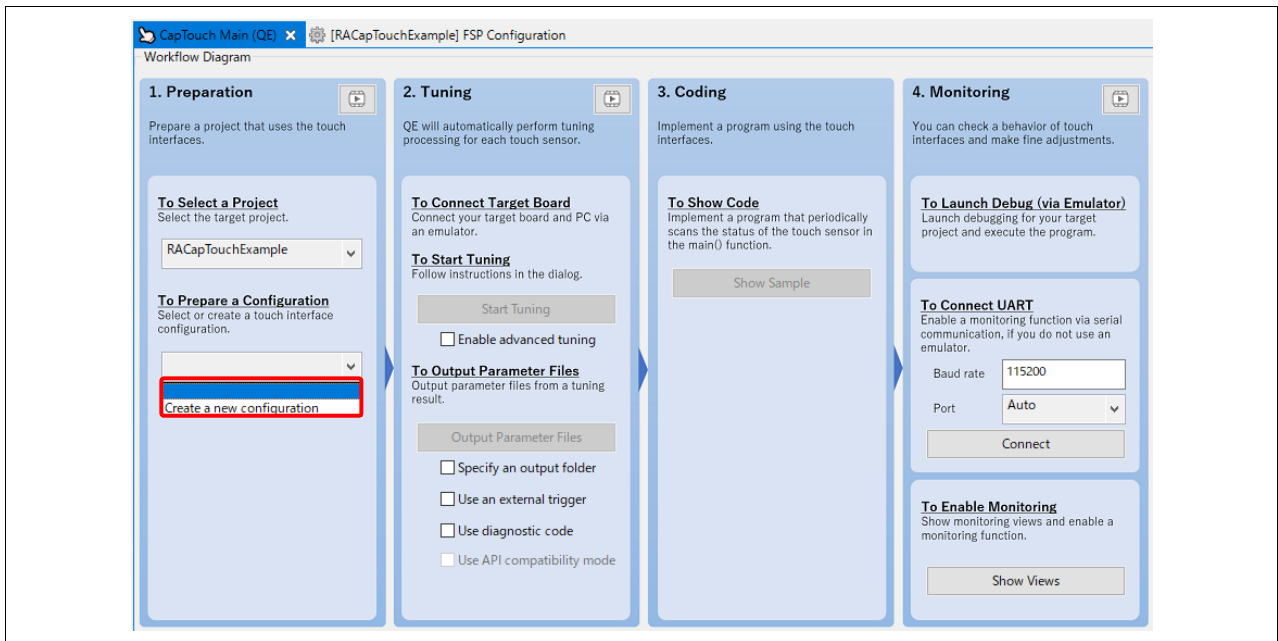

Figure 11. Create New Touch Configuration

7. A new menu window will open with the default blank canvas for creating the Touch interface.

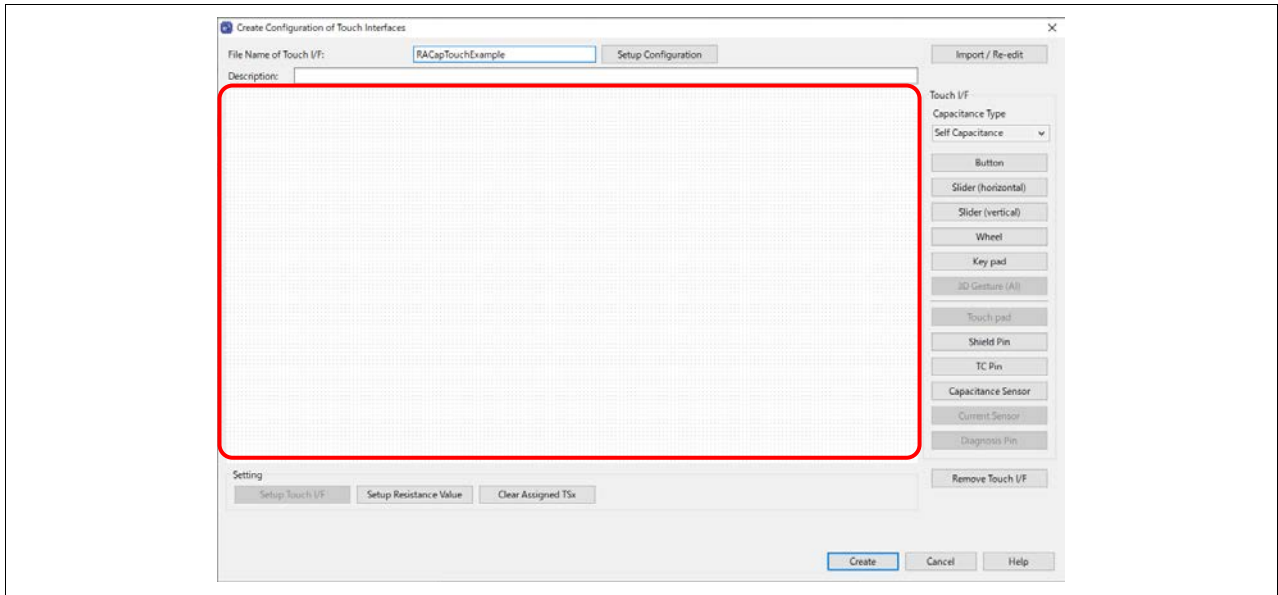

Figure 12. Blank Canvas

8. Add 3 buttons to the canvas by:
 - a. Selecting the **Button** menu item from the right-hand side and moving the mouse onto the canvas.
 - b. Click the left-hand mouse button to drop the button icon. Do this three times to add three buttons.
 - c. Press the **ESC** key to exit once the three buttons are added.

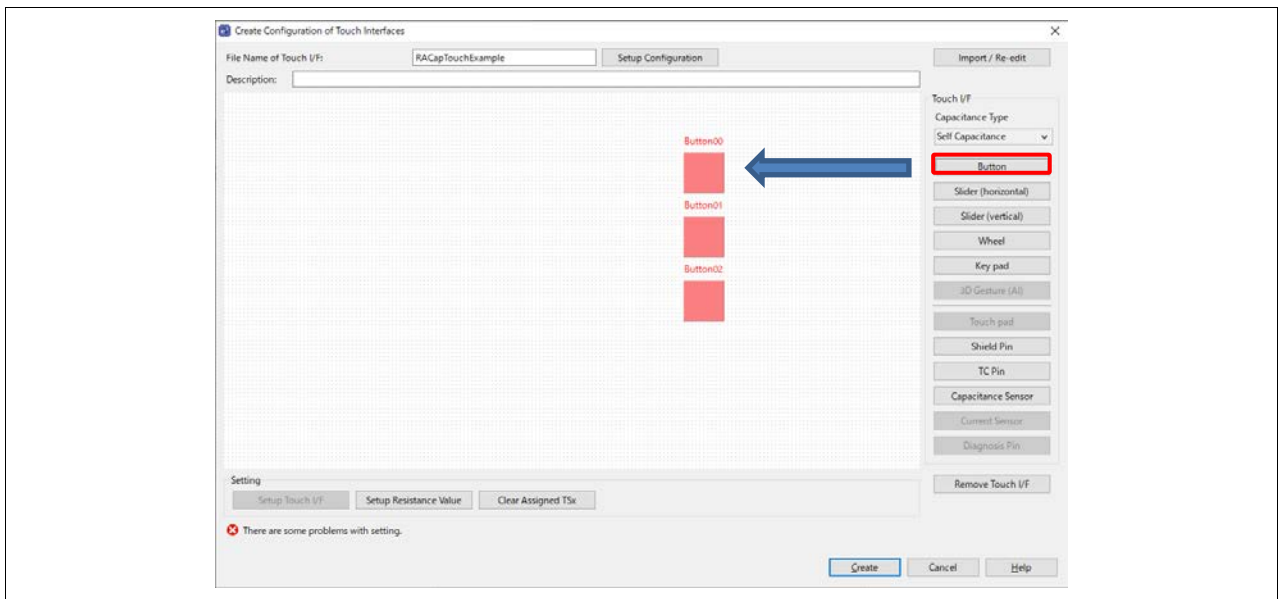

Figure 13. Create New Touch Button

9. Assign Touch Sensor to buttons:
 - a. Double click on **Button00** and a dialog box will appear. Rename it to TS_B1. Using the pull-down and select **TS11** as the MCU sensor to assign to this button.
 - b. Double click on **Button01** and a dialog box will appear. Rename it to TS_B2. Using the pull-down and select **TS10** as the MCU sensor to assign to this button.
 - c. Double click on **Button02** and a dialog box will appear. Rename it to TS_B3. Using the pull-down and select **TS09** as the MCU sensor to assign to this button.

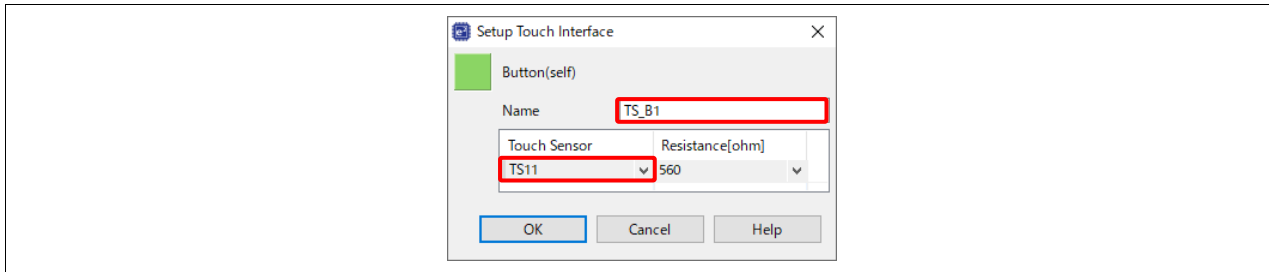

Figure 14. Assign Touch Sensor to Button

10. Select the **Wheel** menu item from the right-hand side and add it onto the canvas. Press **ESC** once completed.
11. Double click on **Wheel00** and a dialog box will appear. Using the pull-down and select **TS21, TS18, TS32, TS23** as the MCU sensors to assign to this wheel.

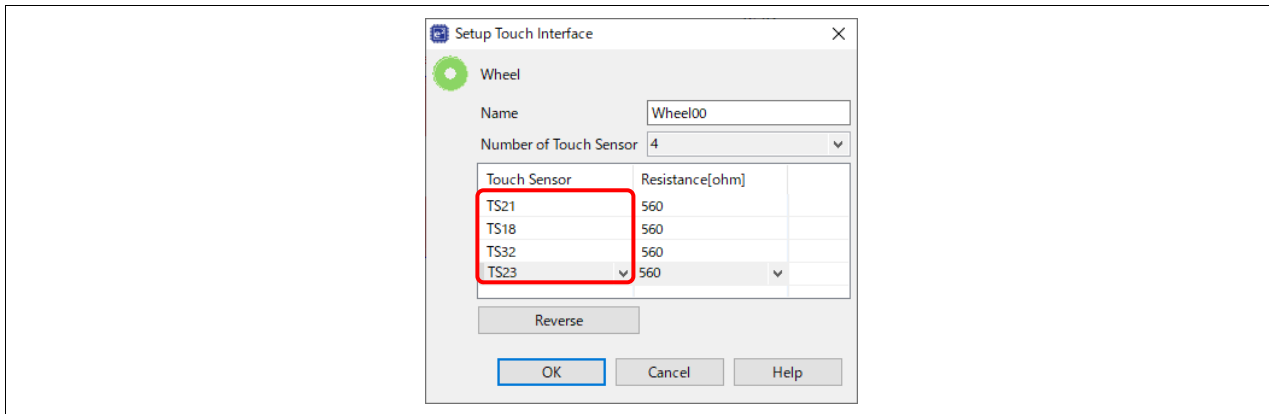

Figure 15. Assign Touch Sensor to Wheel

12. Select the **Slider (horizontal)** menu item from the right-hand side and add it onto the canvas. Press **ESC** once completed.
13. Double click on **Slider00** and a dialog box will appear.
 - a. Select Number of Touch Sensor: 5.
 - b. Using the pull-down and select TS06, TS07, TS05, TS02 and TS04 as the MCU sensors to assign to this slider.

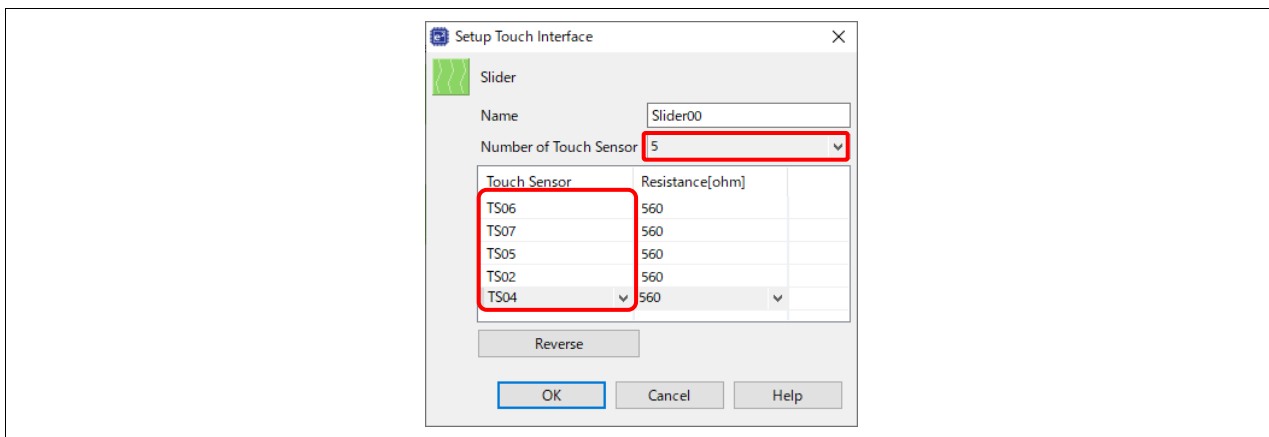

Figure 16. Assign Touch Sensor to Slider

14. Select the **Shield Pin** menu item from the right-hand side.
 - a. Add the 1st shield to canvas to cover the 3 buttons.
 - b. Add the 2nd shield to canvas to cover the wheel.
 - c. Add the 3rd shield to canvas to cover the slider.
 - d. Press **ESC** once completed.
15. Assign Touch Sensor to shields:
 - a. Double click on **Shield00** and a dialog box will appear. Assign **TS00** to this shield.
 - b. Double click on **Shield01** and a dialog box will appear. Assign **TS14** to this shield.
 - c. Double click on **Shield02** and a dialog box will appear. Assign **TS08** to this shield.
16. This completes the addition of the Touch interface like shown below **Figure 17**.

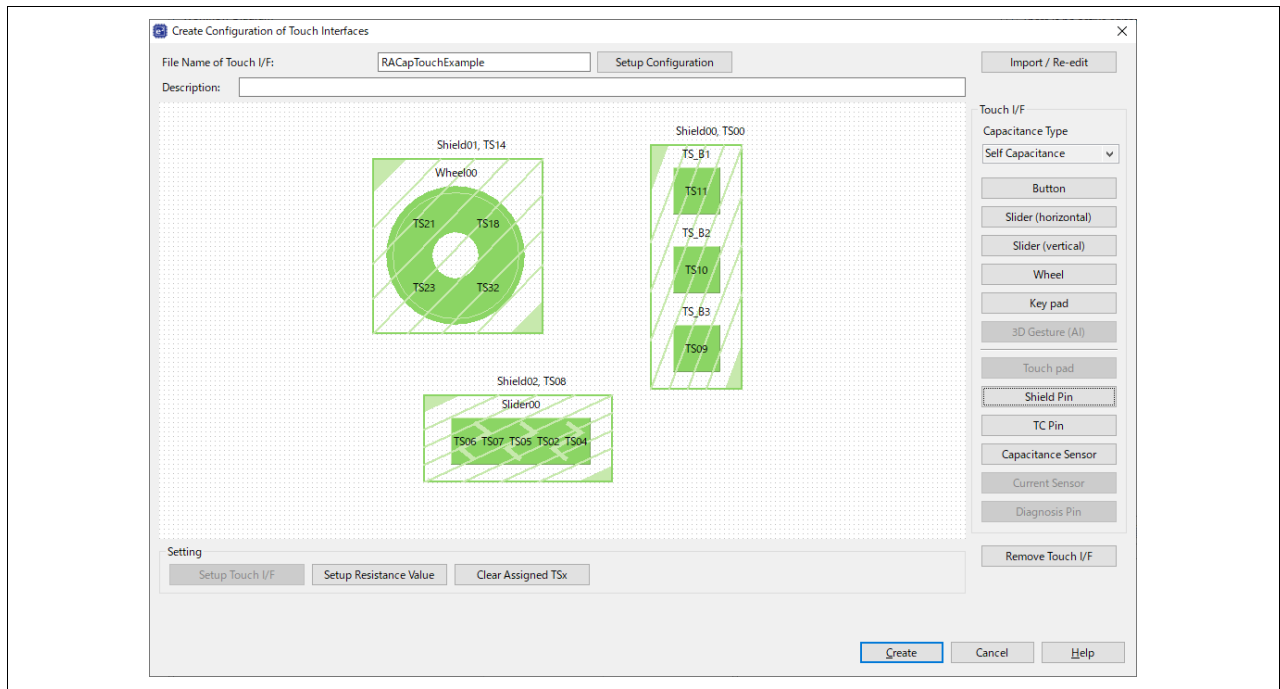

Figure 17. Complete New Touch Interface

17. Next, set the touch interface configuration. Press **Setup Configuration** button to open the **Setup Configuration (methods)** dialog and set the three active shields.

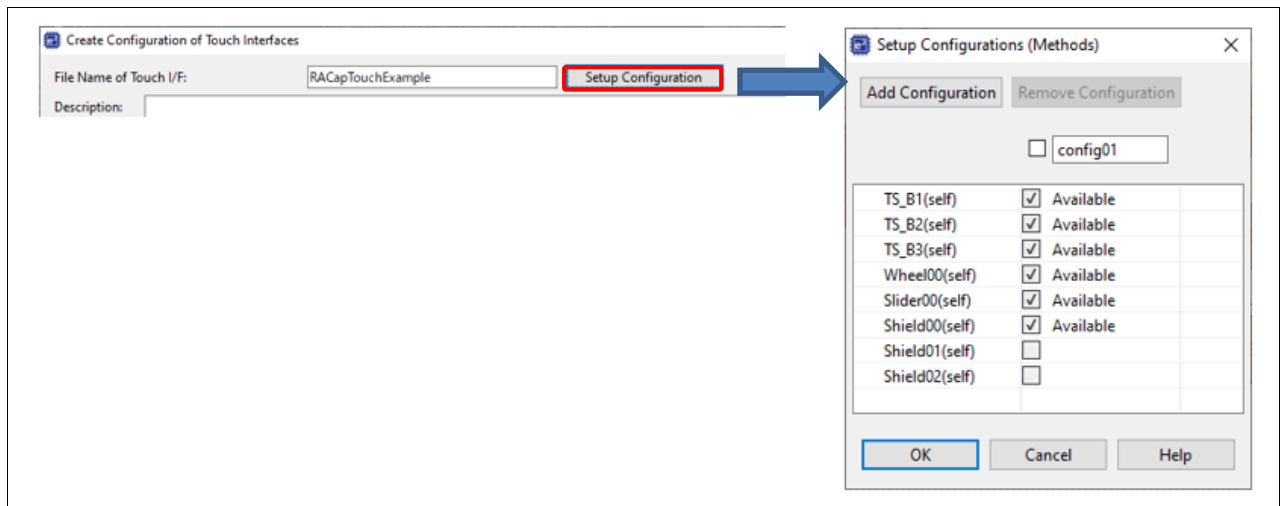

Figure 18. Setup Configurations (Methods)

18. The following steps to configure like **Figure 19**.
 - a. Uncheck **Wheel00(self)** and **Slider00(self)** to compose **Shield00(self)** with **TS_B1(self)**, **TS_B2(self)** and **TS_B3(self)** as **config01**.
 - b. Press **Add Configuration**, **config02** is added.
 - c. Uncheck **TS_B1(self)**, **TS_B2(self)**, **TS_B3(self)**, **Slider00(self)**, **Shield00(self)** and **Shield02(self)** to compose **Shield01(self)** with **Wheel00(self)** and **Shield01(self)** as **config02**.
 - d. Press **Add Configuration**, **config03** is added.
 - e. Uncheck **TS_B1(self)**, **TS_B2(self)**, **TS_B3(self)**, **Wheel00(self)**, **Shield00(self)** and **Shield01(self)** to compose **Shield02(self)** with **Slider00(self)** and **Shield02(self)** as **config03**.
 - f. Click **OK** to close the dialog box.

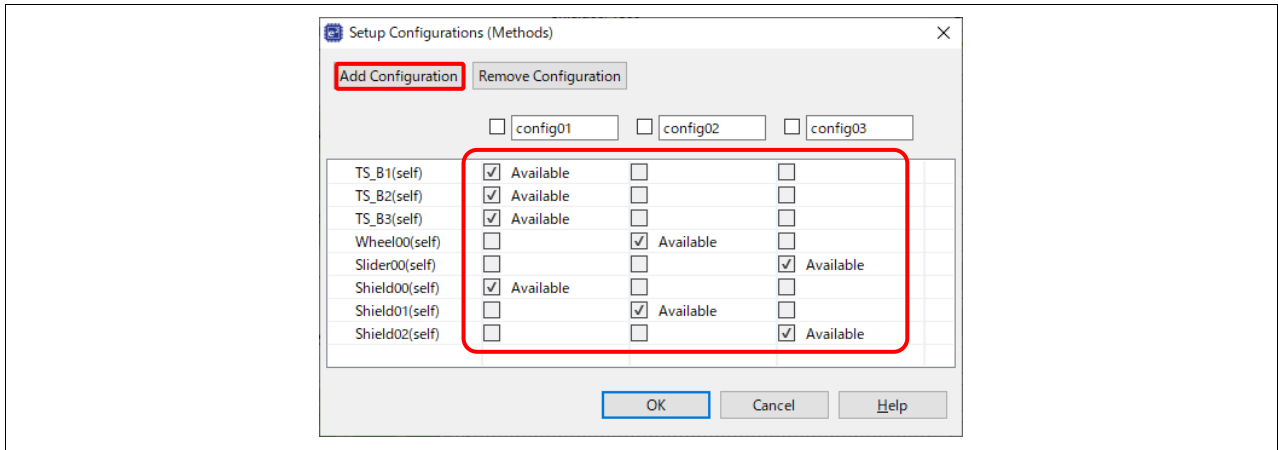

Figure 19. Setting Setup Configurations (Methods)

19. This is the final Touch Interface. Click **Create** button bottom right of the **Configuration of Touch Interfaces** window to set up the Touch Interface.
20. The CapTouch Main (QE) will now display the configuration of the Touch interface in the main view pane.

Touch I/F Configuration: RACapTouchExample

Method	Kind	Name	Touch Sensor	Parasitic Capacitance[pF]	Sensor Drive Pulse Frequency[MHz]	Threshold	Scan Time[ms]	Overflow
config01	Button(self)	TS_B1	TS11	-	-	-	-	None
config01	Button(self)	TS_B2	TS10	-	-	-	-	None
config01	Button(self)	TS_B3	TS09	-	-	-	-	None
config01	Shield Electrode Pin	Shield00	TS00	-	-	-	-	-
config02	Wheel	Wheel00	TS21, TS18, TS32, TS23	-	-	-	-	None
config02	Wheel TS	(Wheel00)	TS21	-	-	-	-	-
config02	Wheel TS	(Wheel00)	TS18	-	-	-	-	-
config02	Wheel TS	(Wheel00)	TS32	-	-	-	-	-
config02	Wheel TS	(Wheel00)	TS23	-	-	-	-	-
config02	Shield Electrode Pin	Shield01	TS14	-	-	-	-	-
config03	Slider	Slider00	TS06, TS07, TS05, TS02, TS04	-	-	-	-	None
config03	Slider TS	(Slider00)	TS06	-	-	-	-	-
config03	Slider TS	(Slider00)	TS07	-	-	-	-	-
config03	Slider TS	(Slider00)	TS05	-	-	-	-	-
config03	Slider TS	(Slider00)	TS02	-	-	-	-	-
config03	Slider TS	(Slider00)	TS04	-	-	-	-	-
config03	Shield Electrode Pin	Shield02	TS08	-	-	-	-	-

Figure 20. Main View Pane Displays the Touch Configuration

21. Build the project by clicking the hammer icon. The project should build without any errors or warnings.

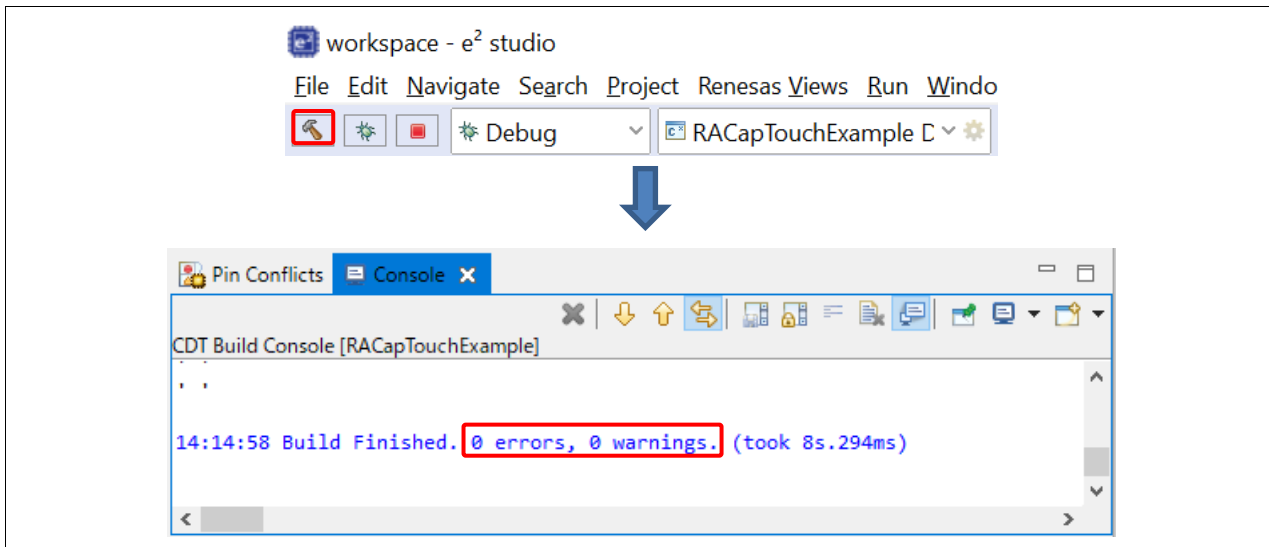

Figure 21. Build Project

3. Capacitive Touch Tuning in e² studio

1. Connect the board with a PC. Refer to the **Figure 53** for how to connect.
2. To start the automatic tuning process, click the button **Start Tuning** in CapTouch Main (QE).

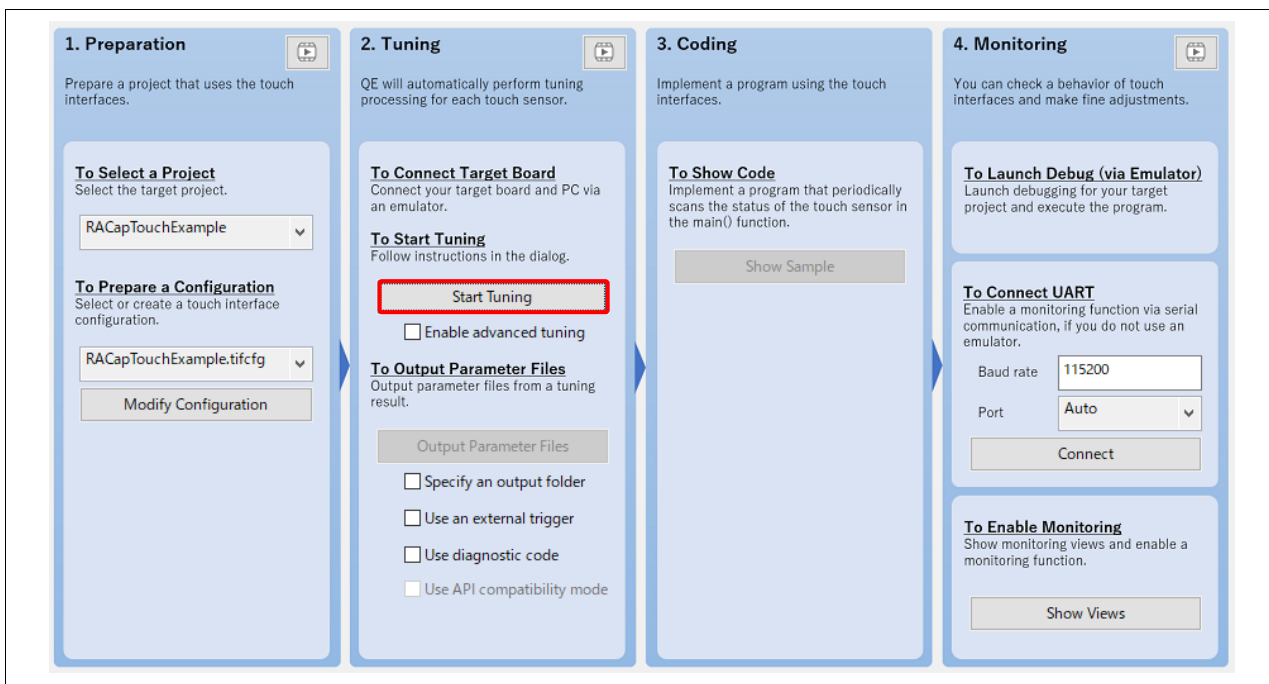

Figure 22. Start Tuning

- At the start of the first debug session, e² studio may display a message indicating the Debug perspective will be switched to. Click the **Remember my decision** check box and **Switch** to continue the Debug process and the QE for Capacitive Touch automatic tuning.

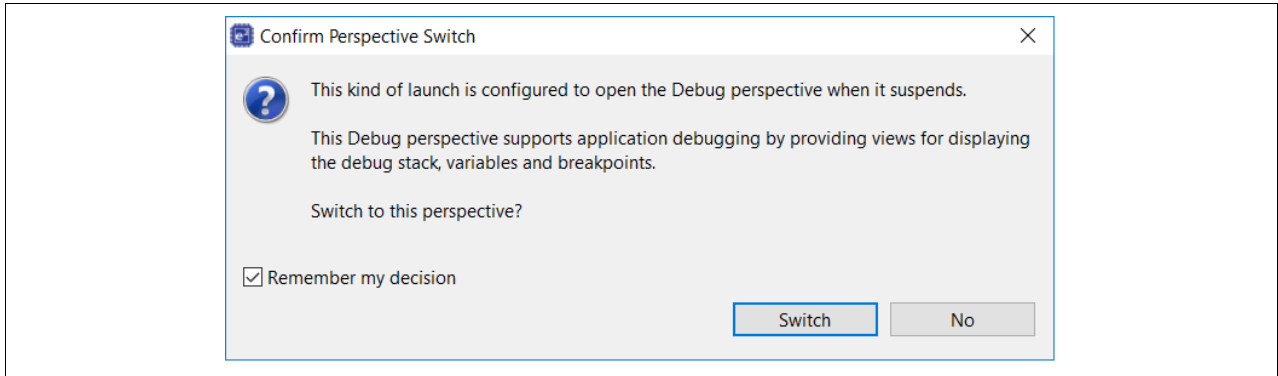

Figure 23. Switch Perspective

- QE for Capacitive Touch automatic tuning will now begin. Please read the tuning dialog windows carefully as they will guide you through the tuning process. An example screen is shown below. Typically, no interaction is required during the initial tuning process steps.

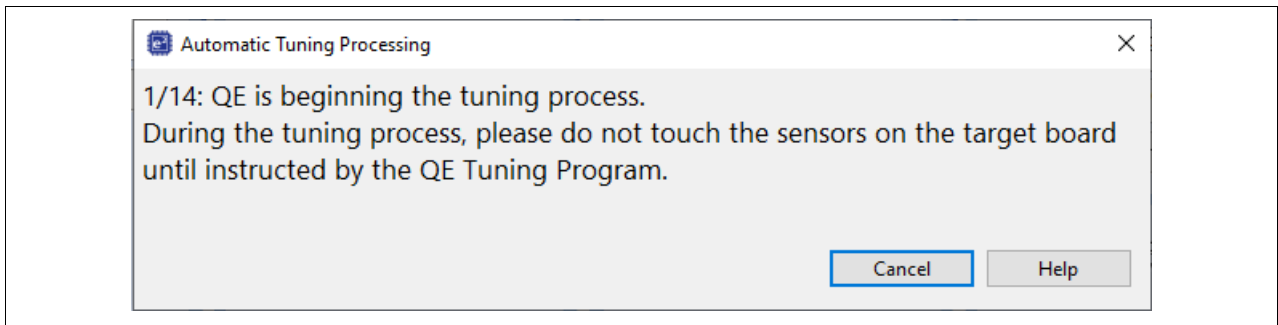

Figure 24. Tuning Dialog Window

- After several automated steps, you will arrive at the dialog box with information like what is shown below. This is the Touch sensitivity measurement step of the tuning process. Press using normal Touch pressure on the sensor being indicated in the dialog box (TS_B3, TS09). When pressing the bar graph will increase to the right and the Touch counts go numerically up. While holding that pressure, **press any key on the PC keyboard** to accept the measurement.

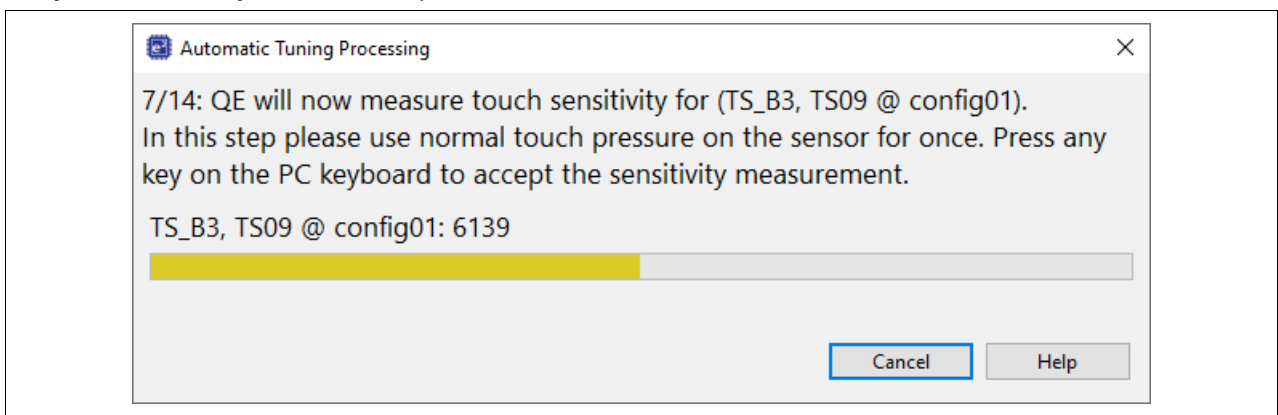

Figure 25. Measure Touch Button TS_B3

- 6. Repeat the process for buttons TS_B2 and TS_B1.

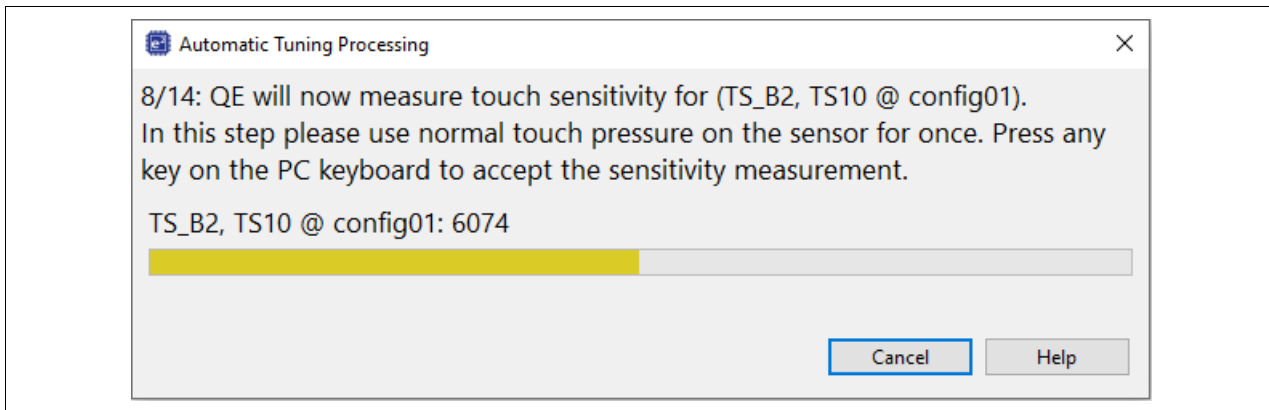

Figure 26. Measure Touch Button TS_B2

- 7. Next, we will measure the sensitivity of the wheel. Move your finger across the wheel sensors 3-4 times. After that, **press any key on the PC keyboard** to accept the measurement.

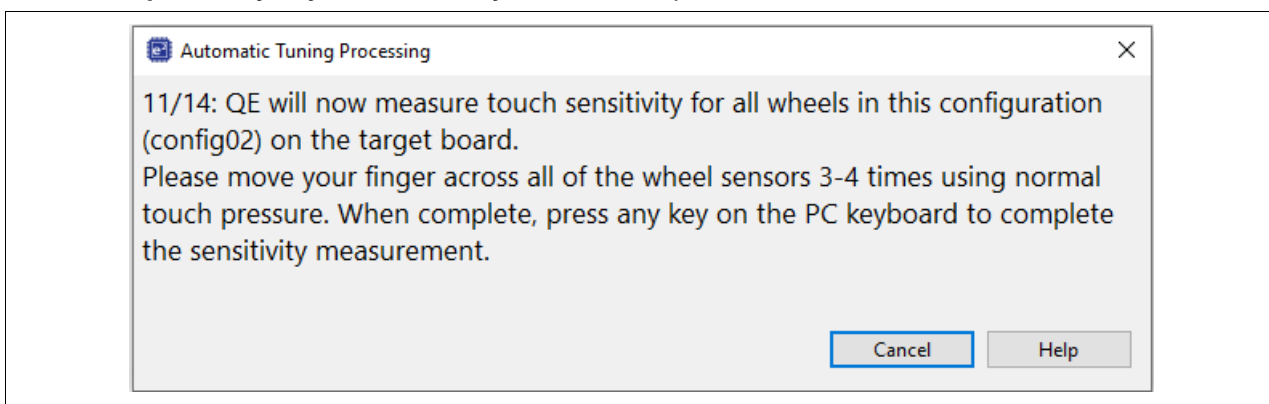

Figure 27. Repeat Measurement 3 Times

- 8. Next, we will adjust the slider. Move your finger across the slider 3-4 times. After that, **press any key on the PC keyboard** to accept the measurement.

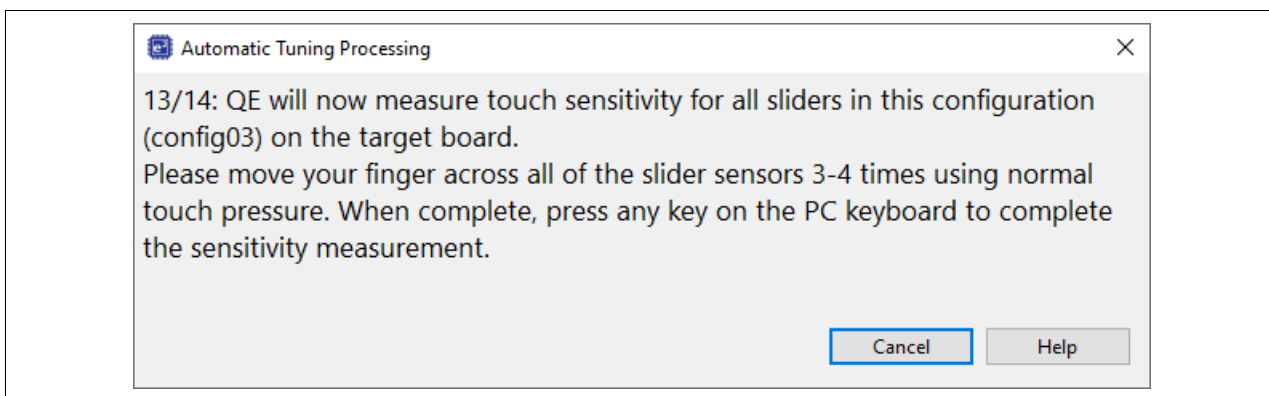

Figure 28. Repeat Measurement 3 Times

- Once complete, you will see a screen like what is shown below. This is the detection threshold that is used by the middleware to determine if a Touch event has occurred.

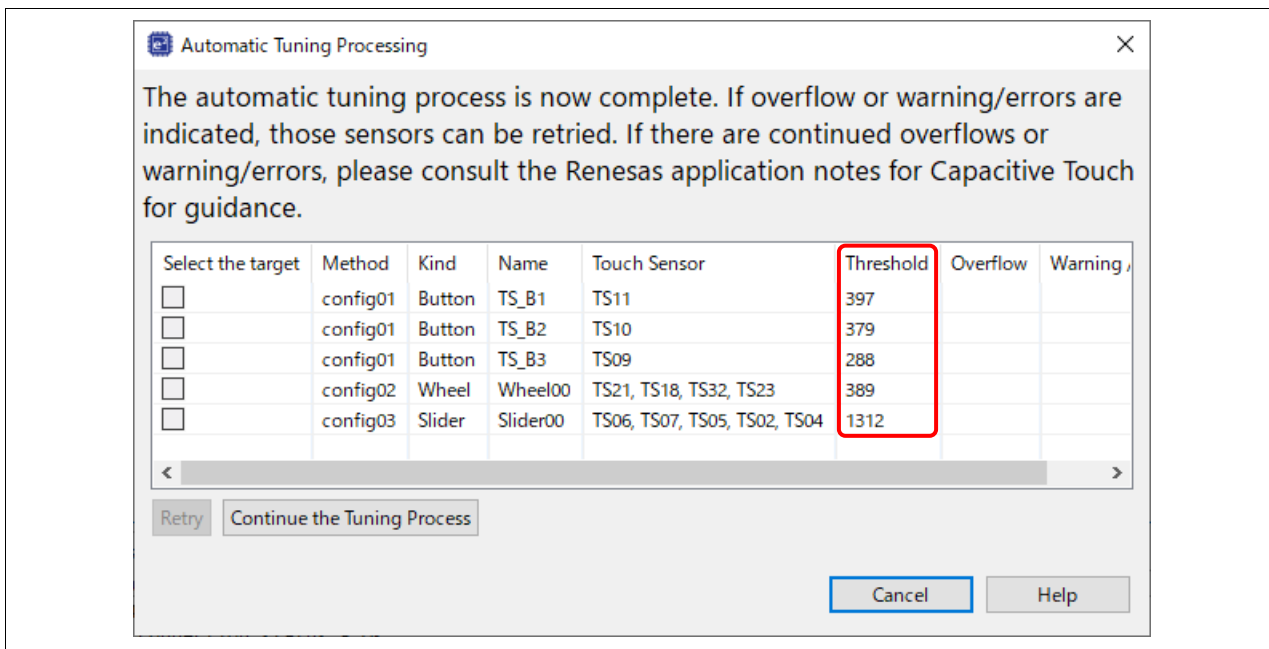

Figure 29. Threshold for Touch Event

- Click the **Continue the Tuning Process** button in the dialog box shown. This will exit the tuning process and disconnect from the Debug session on the target. You should return to the default **CapTouch Main (QE)** screen in the e² studio IDE.

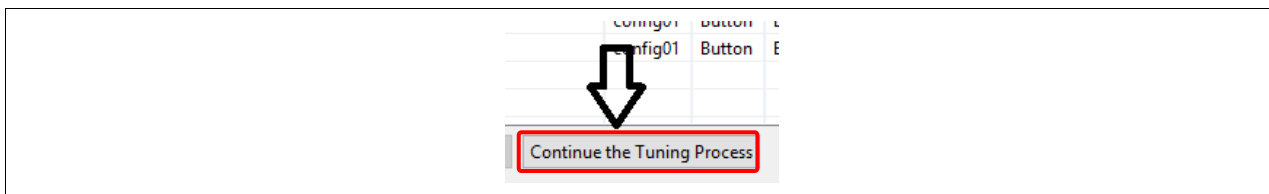

Figure 30. Continue the Tuning Process

- After the tuning process is completed, the default view of the CapTouch Main (QE) presented here will be the results of the tuning process for the sensors in the configuration. This gives the user a quick way to examine the tuning results.

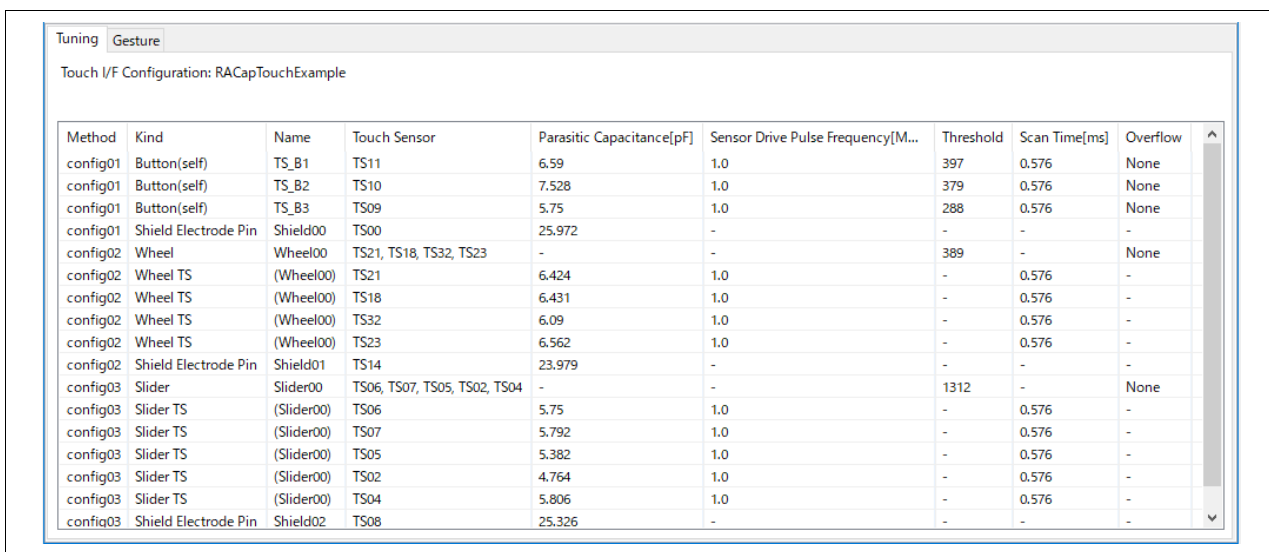

Figure 31. Tuning Result

12. Finally, output the tuning parameter files. Click the button **Output Parameter Files**.

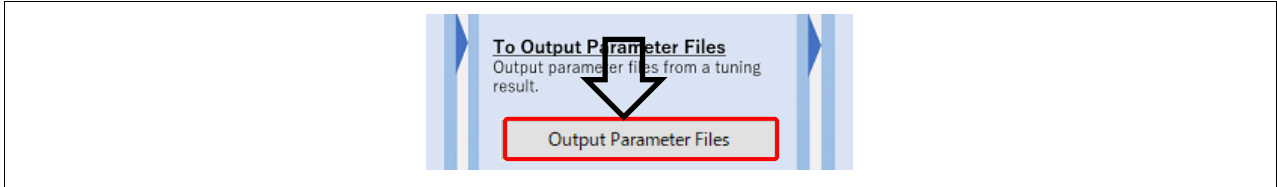

Figure 32. Continue the Tuning Process

13. Look at the **Project Explorer** window and you will see that files have been added. These contain the needed tuning information to enable Touch detection using the **r_ctsu** and **rm_touch** FSP modules.

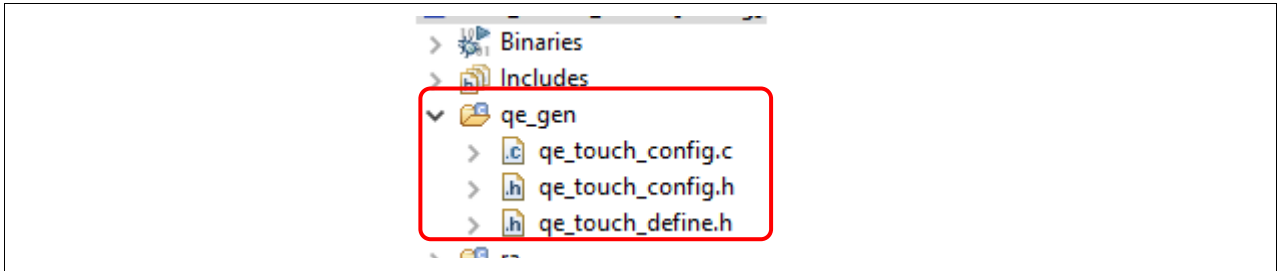

Figure 33. Output Parameter Files

4. Creating new project in Keil® MDK

1. Install the Keil® Microcontroller Development Kit version 5.36 or later (for RA device support) from <https://www2.keil.com/mdk5/install>.
2. Install the RA Smart Configurator (RA SC) from <https://www.renesas.com/smart-configurator>.
Note: Please check the version of the RA Smart Configurator installer. If the FSP is not v3.5.0, download and install the latest version from <https://github.com/renesas/fsp/releases>.
3. Import the RA device pack. See “2.6.2 Using RA Smart Configurator with Keil MDK” in the Renesas Flexible Software Package (FSP) User’s Manual for details.
<https://www.renesas.com/us/en/software-tool/flexible-software-package-fsp#document>
4. To create a third-party IDE project with the RA Smart Configurator, run the “rasc.exe” application. In the “New Renesas RA FSP Project” wizard, enter the **Project name** and **Location**.

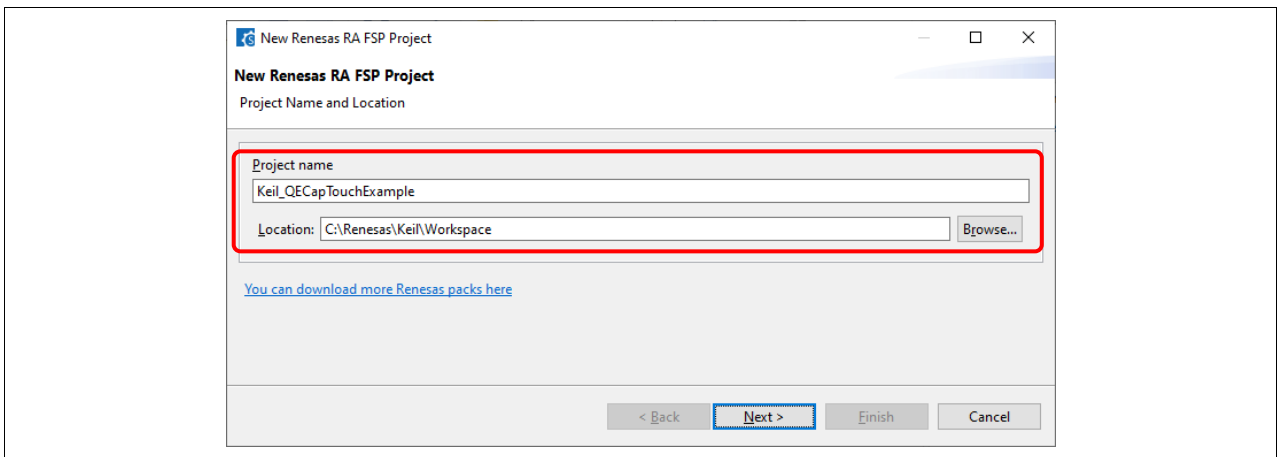

Figure 34. Project Name and Location

- 5. Device and Tools Selection.
 - Board: **RSSK-RA2L1**
 - Device: Auto selected
 - Language: **C**IDE Project Type: **Keil MDK Version 5**
Toolchains: **ARM Compiler 6**

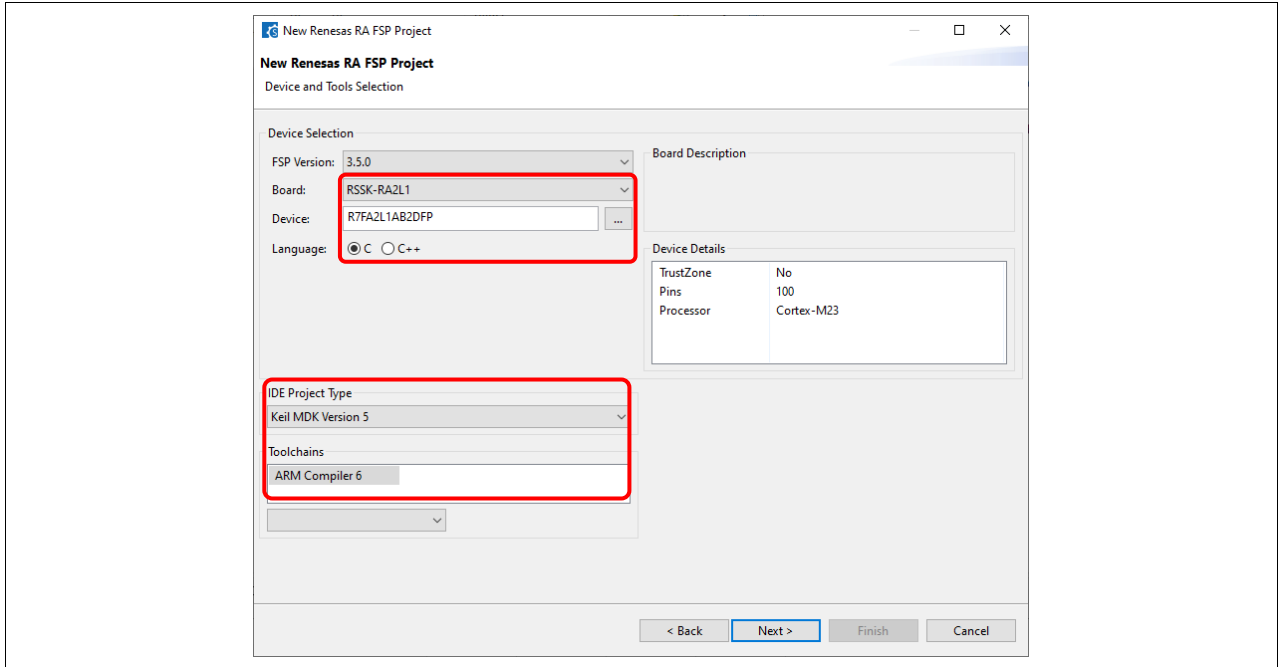

Figure 35. Board Selection for RSSK RA2L1

- 6. RTOS Selection: **No RTOS.**

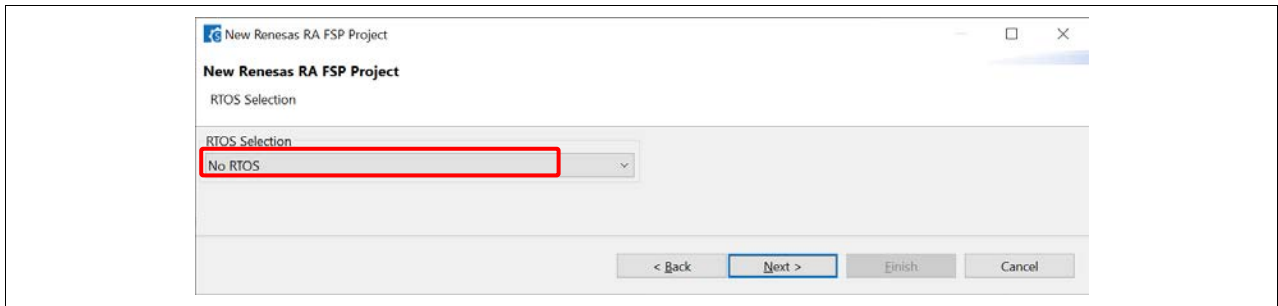

Figure 36. RTOS Selection

7. Project Template Selection: **Bare Metal – Minimum**. Click **Finish** to create project.

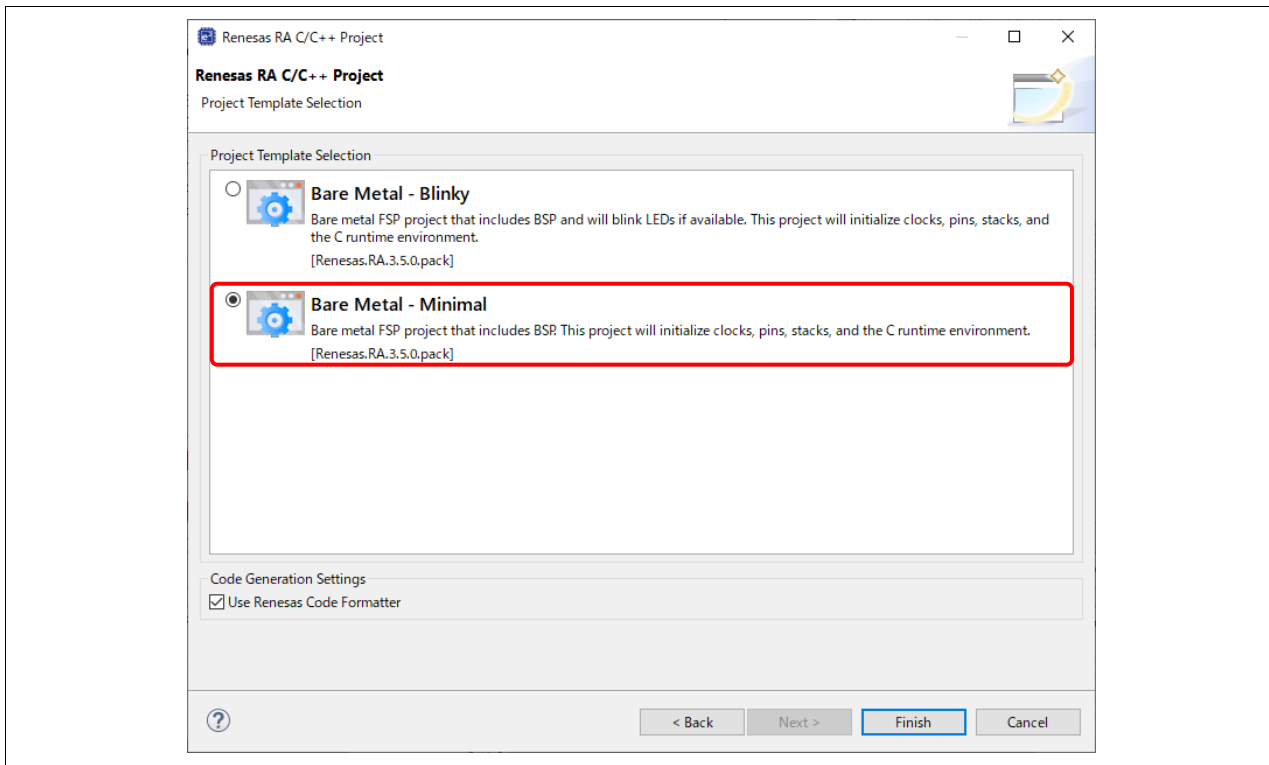

Figure 37. Template Selection

8. After creating the project, the **DDSC Smart Configurator** window will pop-up.

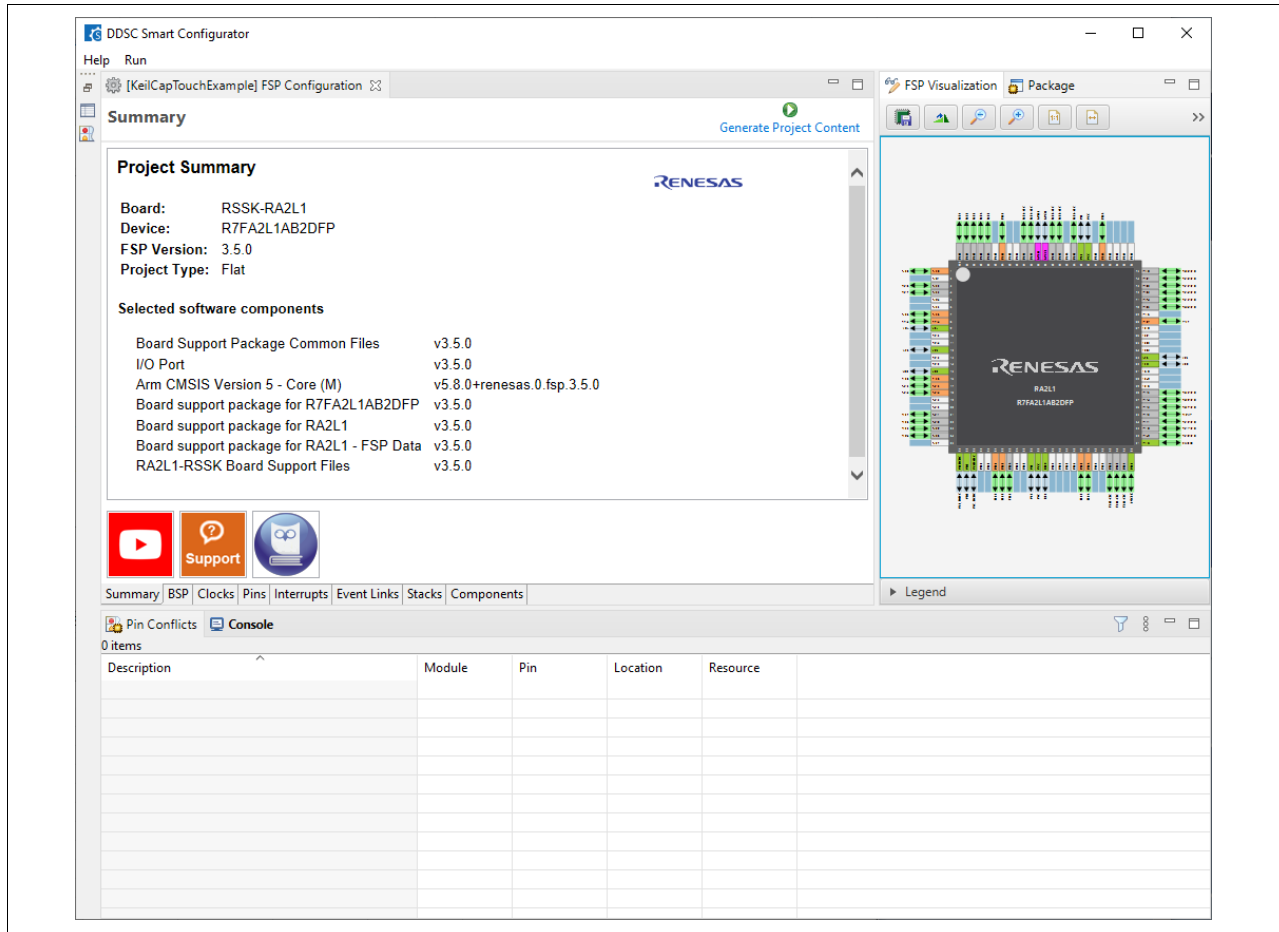

Figure 38. Smart Configurator Window

9. Navigate to the project location in Windows Explorer and double-click on the main workspace (Keil® MDK *.uvprojx file) to open project.

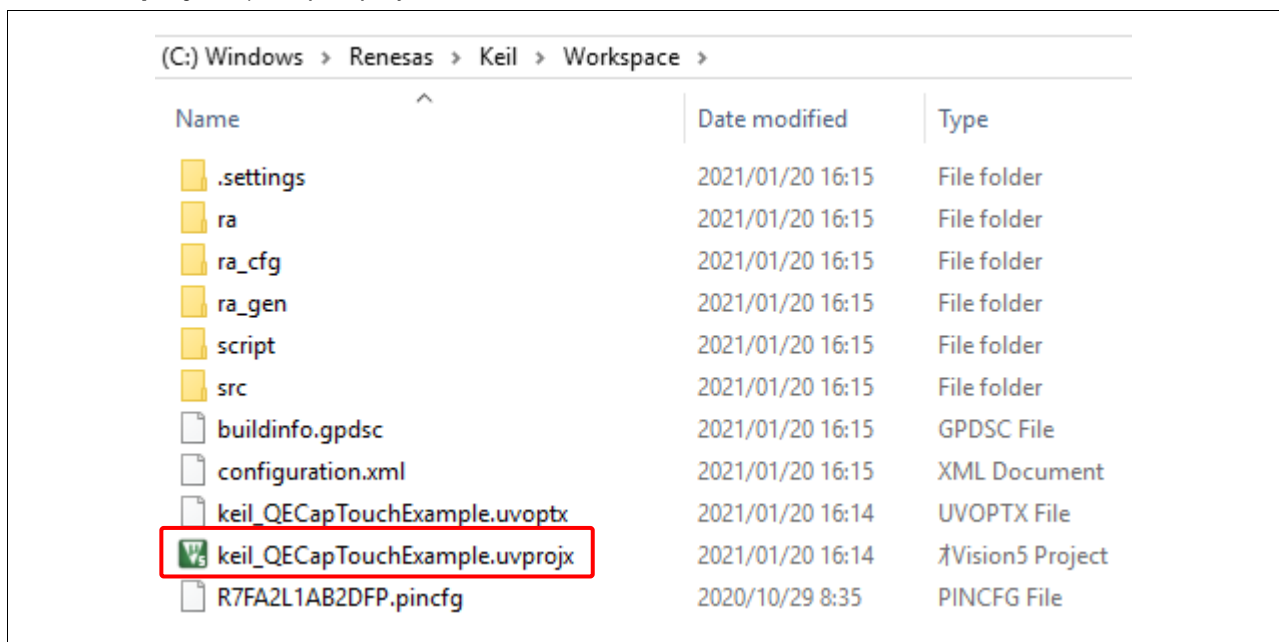

Figure 39. Project Location

- Project is opened by Keil® MDK. Right-click on the project and select **Rebuild all target files**. The project should be built without error.

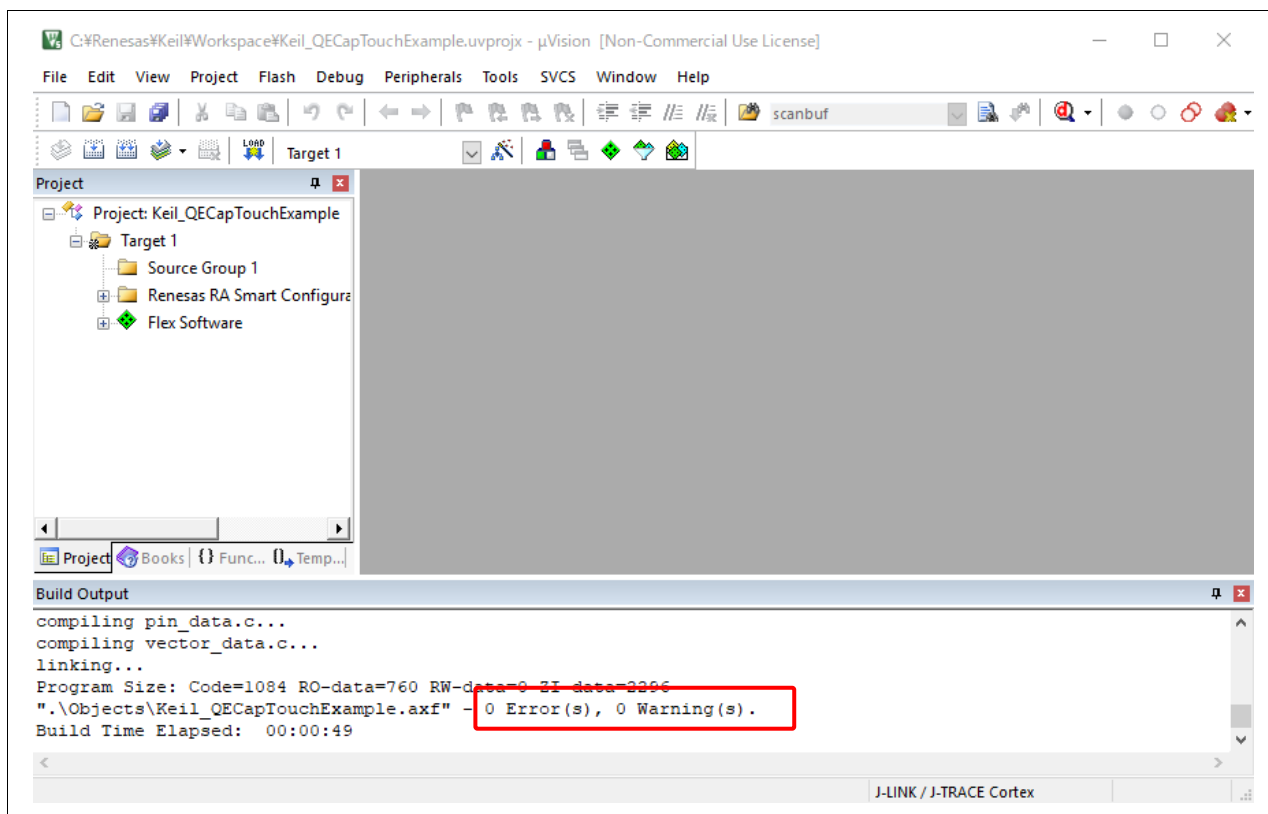

Figure 40. Project is Built Successfully

- After a project created with the RA Smart Configurator has been opened in Keil® MDK, its FSP configuration can be changed by relaunching the RA Smart Configurator from the IDE. Follow the instructions below to reopen the RA Smart Configurator.
- In the menu of Keil® MDK, select **Tools > Configure Tools Menu...** Then, select **New** and fill in the fields as follows.

Menu Text: **RA Smart Configurator**
 Command: Select **Browse...** and navigate to **rasc.exe**
 Initial Folder: Select **Browse...** and navigate to **Workspace**
 Argument: **--device \$D --compiler ARMv6 configuration.xml**

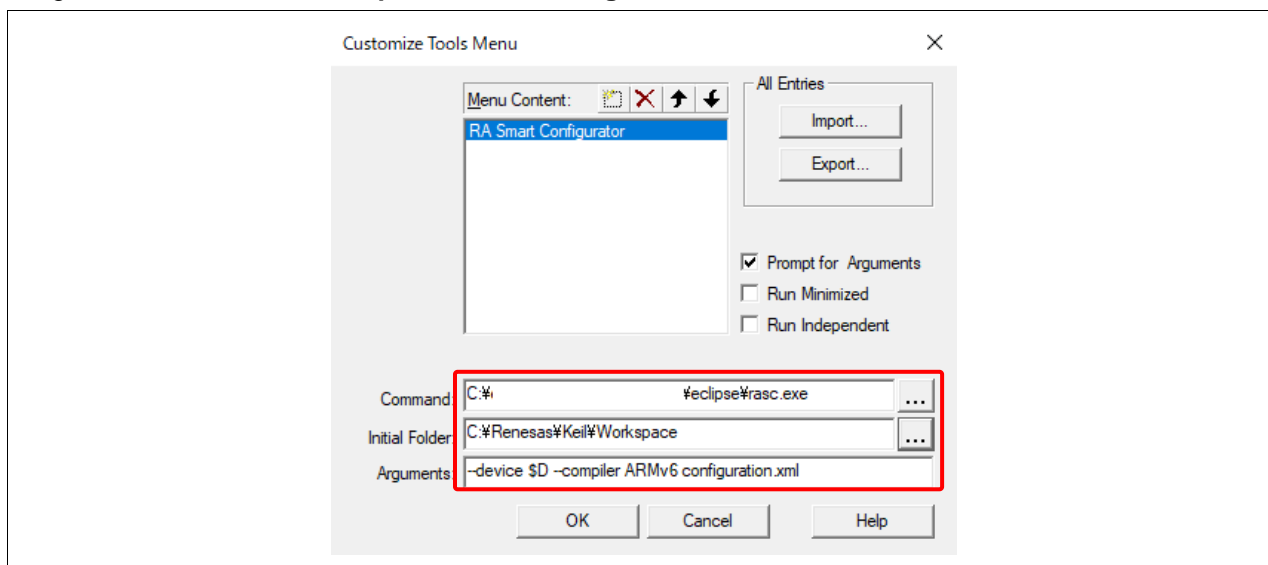

Figure 41. How to Use RA Smart Configurator in Keil® MDK

- Now, an FSP configuration of a created project can be reopened by selecting **Tool > RA Smart Configurator** in Keil® MDK.

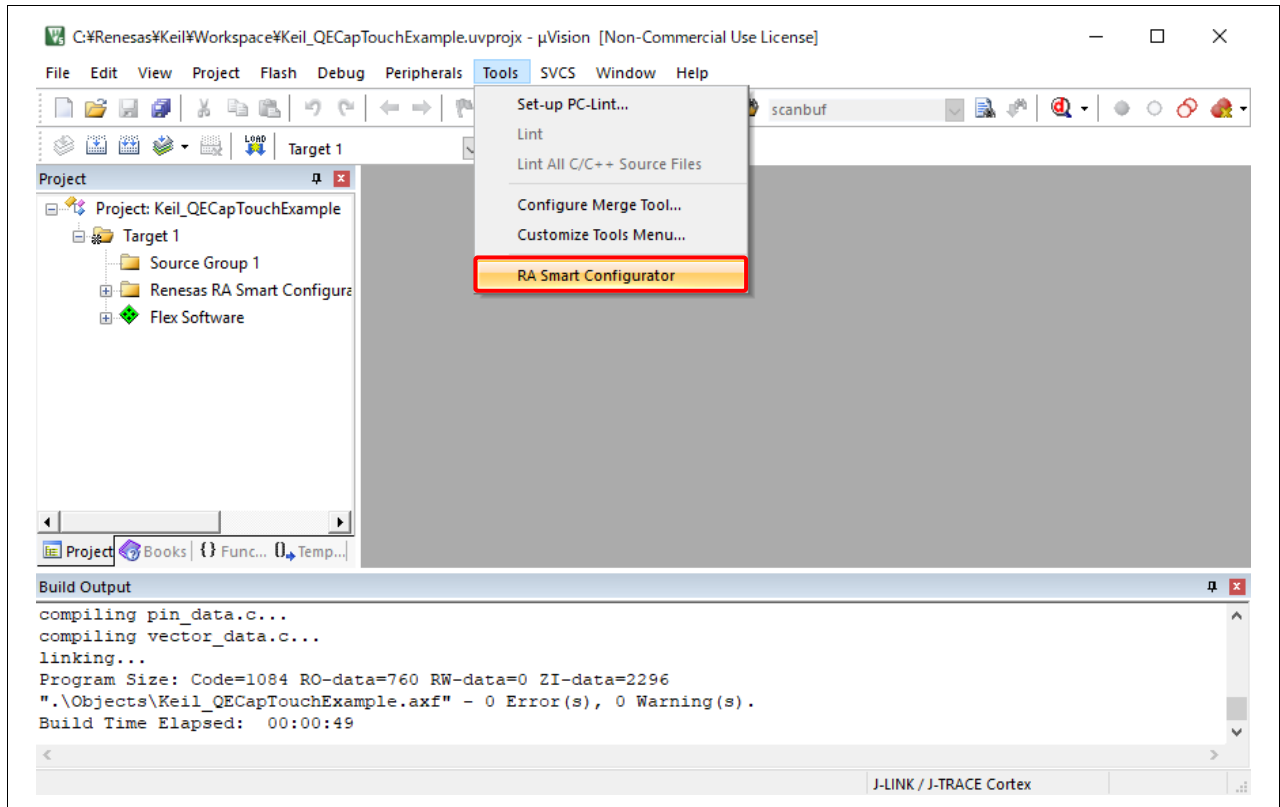

Figure 42. RA Smart Configurator Has Been Added

5. Adding TOUCH Driver in Keil® MDK

- In Smart Configurator, select the **Pins** tab at the bottom of the pane. Type **ctsu** in the search box and select **CTSU0** pin in the search result.

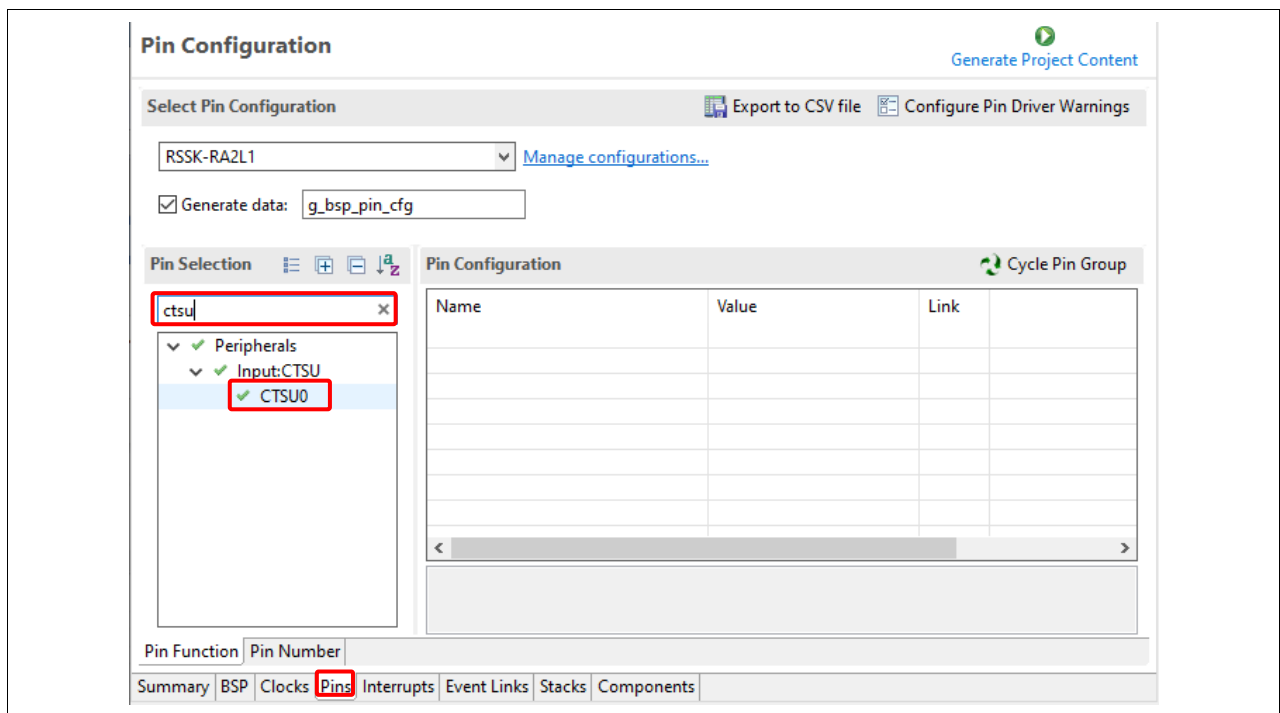

Figure 43. Select Pin CTSU0

- Make sure the **Operation Mode** and the following **TS pins** are enabled:
 TSCAP, TS00, TS04, TS05, TS06, TS07, TS18, TS21, TS23, TS02-CFC, TS08-CFC, TS09-CFC, TS10-CFC, TS11-CFC, TS14-CFC, and TS32-CFC.

Pin Configuration

Select Pin Configuration Export to CSV file Configure Pin Driver Warnings

RSSK-RA2L1 [Manage configurations...](#)

Generate data:

Pin Selection Cycle Pin Group

cts0

- Peripherals
 - Input:CTS0
 - CTS00

Name	Value	Lock	Link
Operation Mode	Enabled		
Input/Output			
TSCAP	✓ P112		
TS00	✓ P204		
TS02-CFC	✓ P303		
TS04	✓ P408		
TS05	✓ P409		
TS06	✓ P410		
TS07	✓ P411		
TS08-CFC	✓ P302		
TS09-CFC	✓ P301		
TS10-CFC	✓ P109		
TS11-CFC	✓ P110		
TS12-CFC	✓ P111		
TS13-CFC	✓ P104		
TS14-CFC	✓ P103		
TS15-CFC	✓ P102		
TS16-CFC	✓ P101		
TS17	✓ P403		
TS18	✓ P402		
TS21	✓ P000		
TS22	✓ P001		
TS23	✓ P002		
TS24	✓ P003		
TS25	✓ P004		
TS26-CFC	✓ P100		
TS27-CFC	✓ P113		
TS28-CFC	✓ P015		
TS29-CFC	✓ P114		
TS30-CFC	✓ P010		
TS31-CFC	✓ P011		
TS32-CFC	✓ P012		
TS33-CFC	✓ P013		
TS34-CFC	✓ P105		
TS35-CFC	✓ P115		

Module name: CTSU0

Pin Function | Pin Number

Summary | BSP | Clocks | Pins | Interrupts | Event Links | Stacks | Components

Figure 44. Enable TS Pins for RSK-RA2L1

3. Move to the **Stacks** tab. Add the Capacitive Touch middleware by clicking **New Stack > CapTouch > Touch (rm_touch)**.

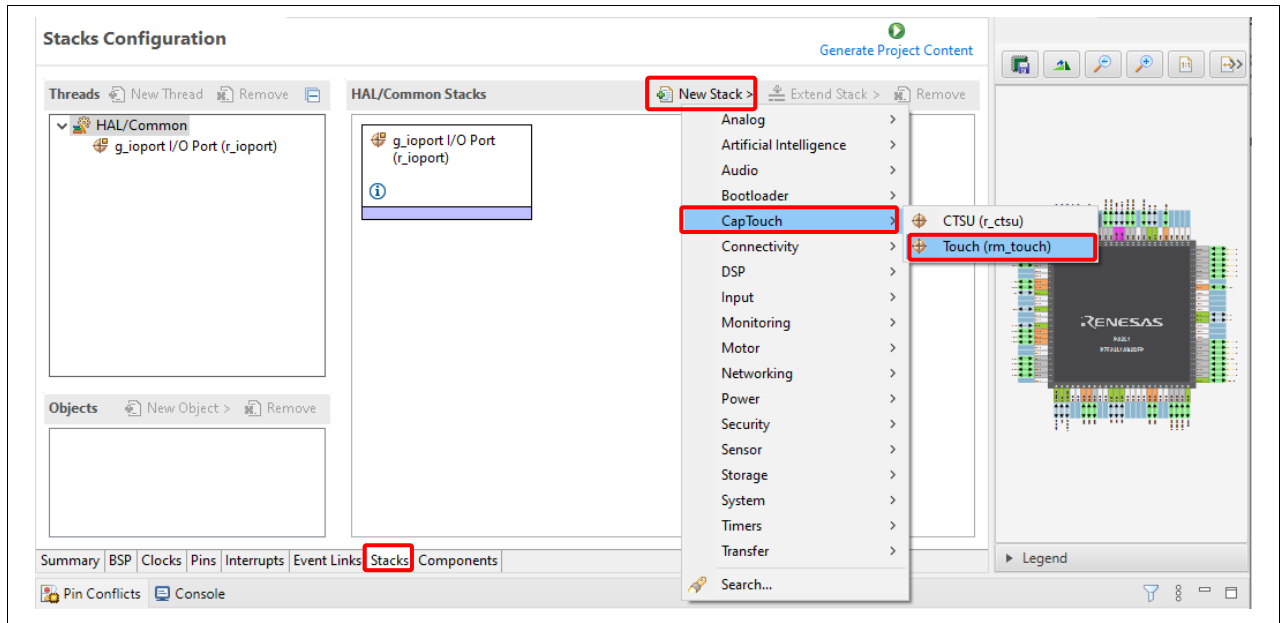

Figure 45. Add TOUCH Driver

4. Click on the  button to generate source file.

6. Copying QE files to Keil® MDK

1. Copy the **qe_gen** folder in e² studio and paste it to the Keil® MDK project folder.

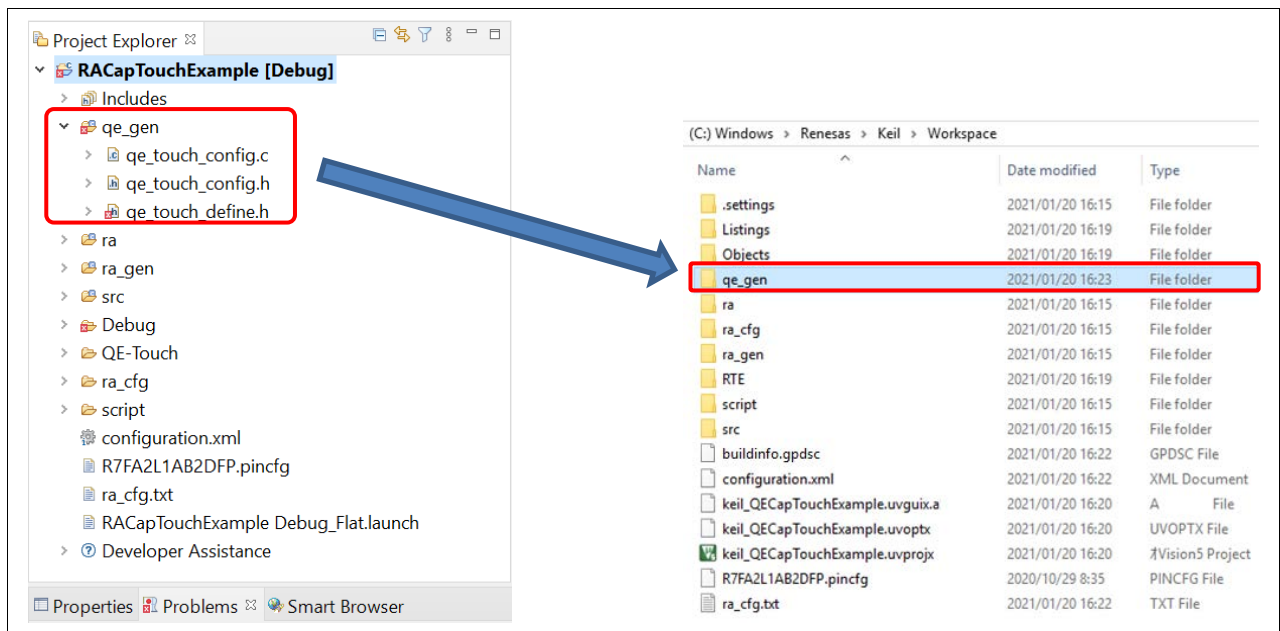

Figure 46. Copy qe_gen Folder to Keil® MDK

- In Keil® MDK, click on the **Source Group 1**. Rename the group name **qe_gen**.

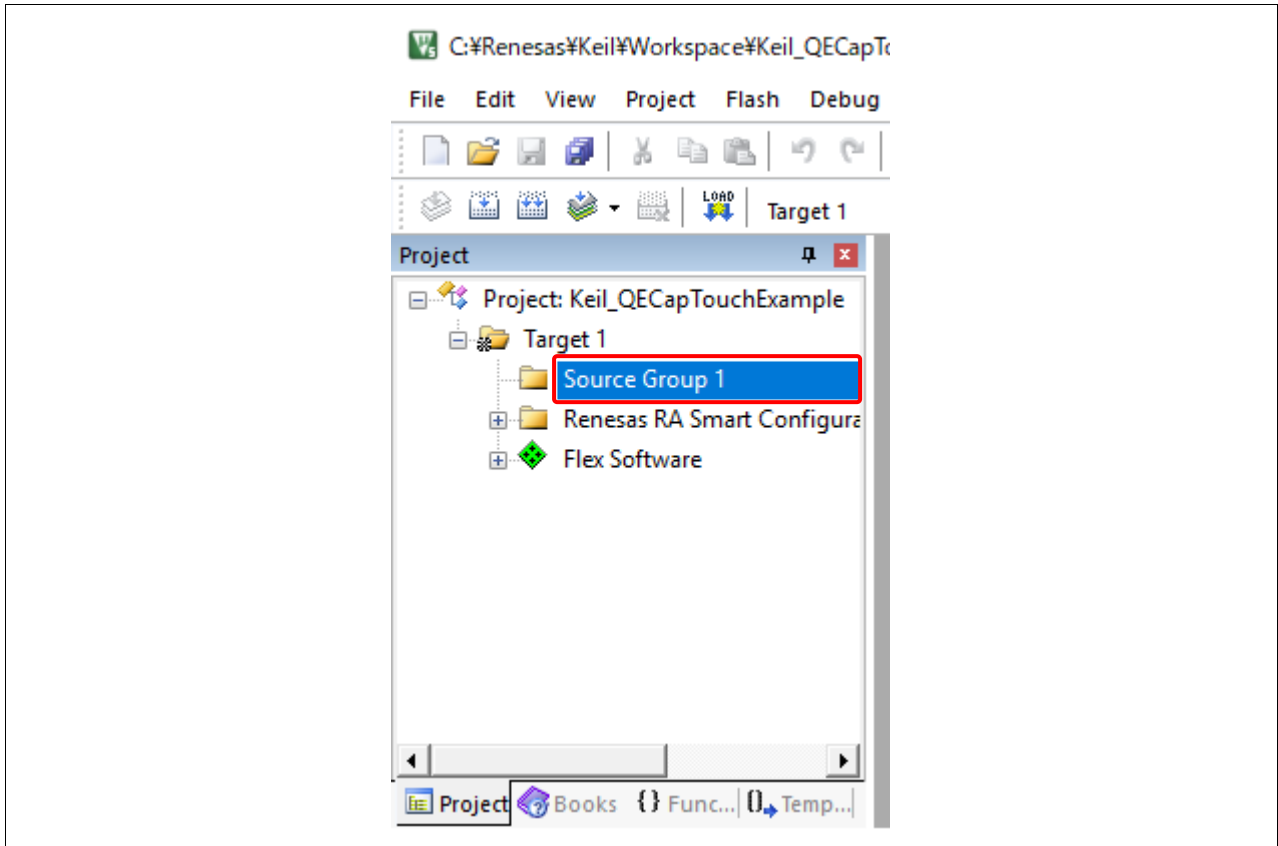

Figure 47. Create New Group

- Right-click on **qe_gen** group and select **Add Existing Files to Group 'qe_gen'...**. Select all the source files inside the **qe_gen** folder and click **Add** to add them to the project.

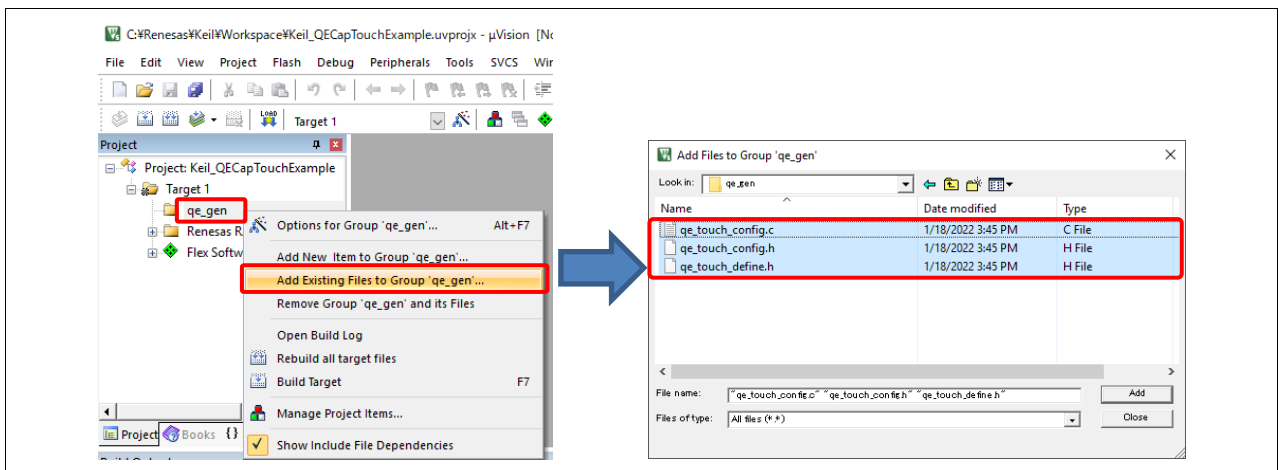

Figure 48. Add Source Files

- Right click on project name and select **Options for Target 'Target 1'...** In the **Options** dialog, select **C/C++ (AC6)**. Click on the [...] button to add include directory.

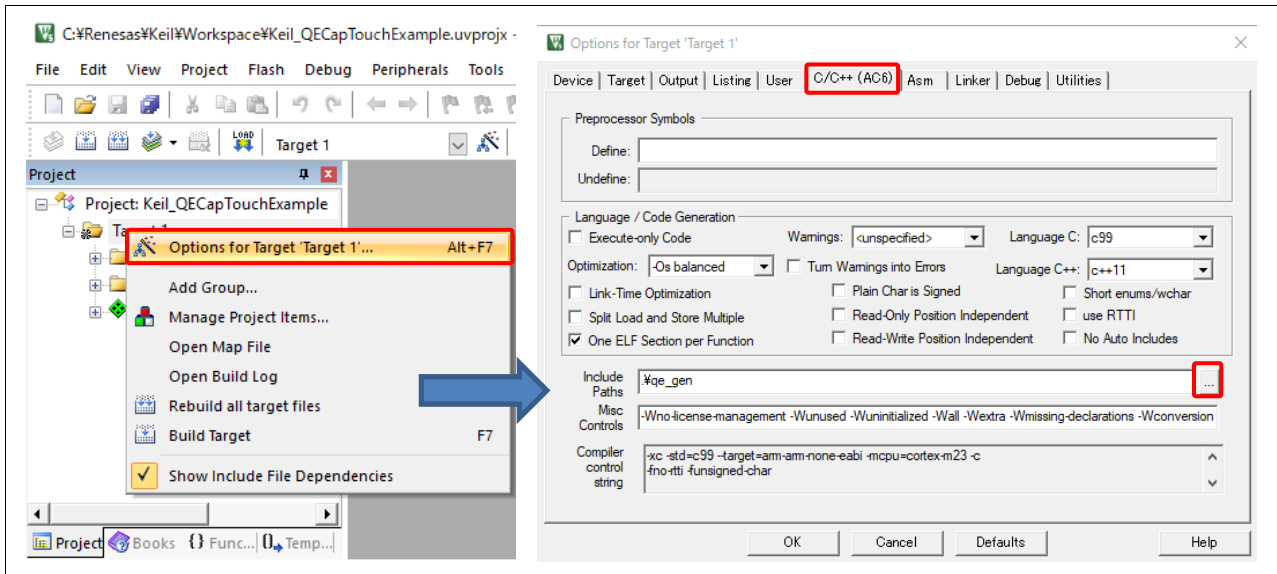

Figure 49. Open Project Option

- Click on the empty row and add the **qe_gen** folder to the list of include directories. The triangle button can be used to change the absolute path to relative path. Click OK to close the dialog.

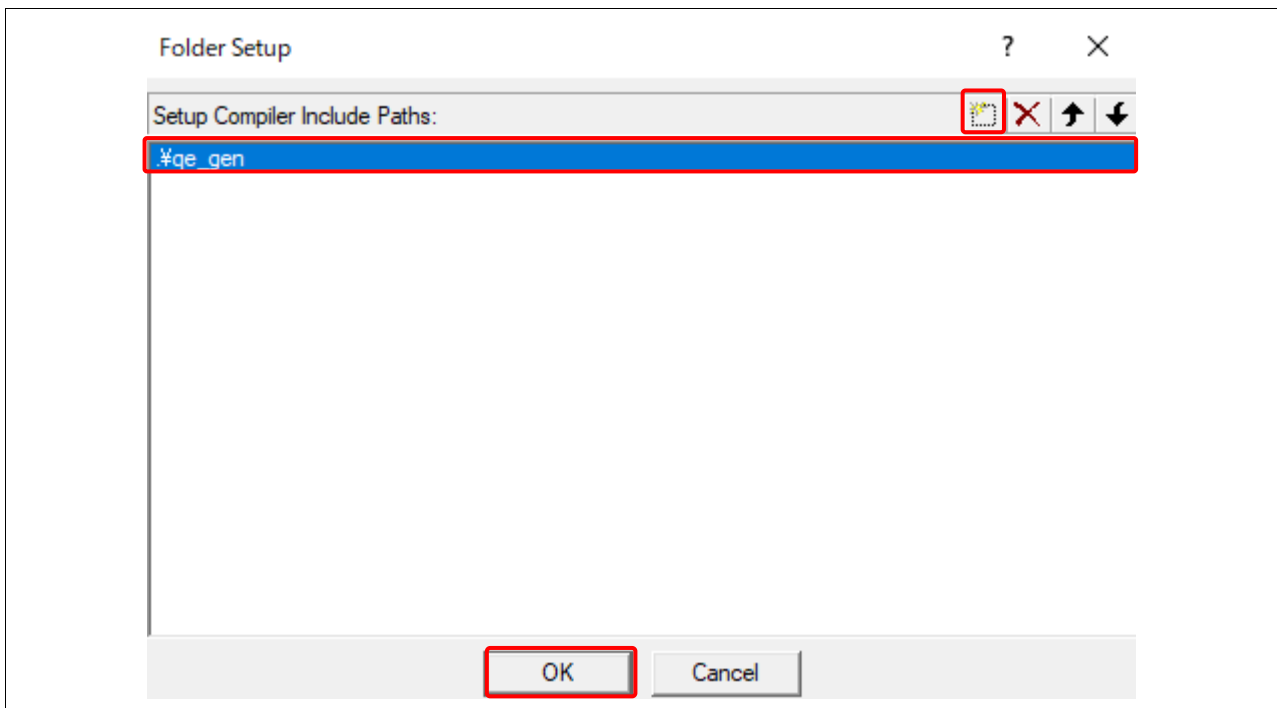

Figure 50. Add qe_gen To List of Include Directories

- Right-click on the project and select **Rebuild all target files**. The project should be built without error.

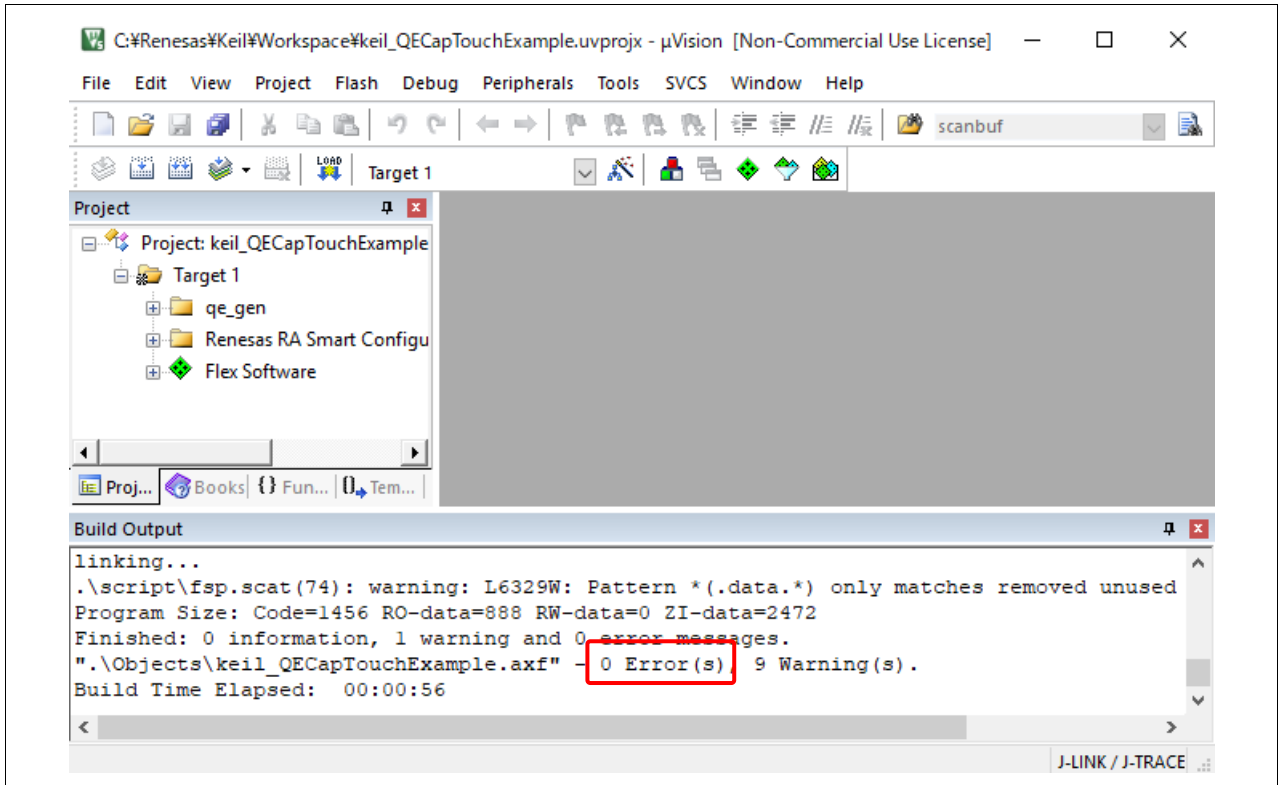

Figure 51. Build Successfully

7. Run Capacitive Touch Project in Keil® MDK

- Connect the board to the target PC using the USB cable connected to CN5 on the board.

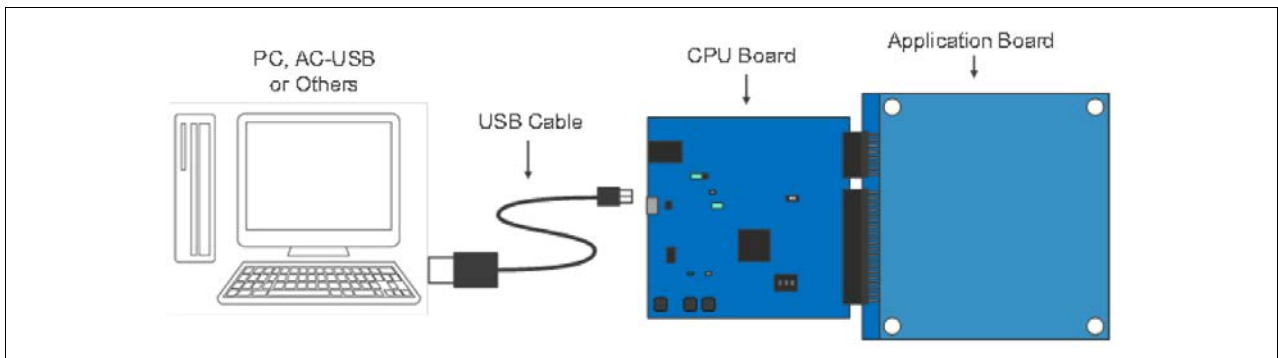

Figure 52. Power Supply to Board

2. Debugger connection:

Connect the debugger cable from the Debugger port (J1) of RSSK-RA2L1 board to the J-Link. Connect the other side of J-Link to the host PC using a USB cable.

The picture below shows the connection between the host PC and the RSSK-RA2L1 board.

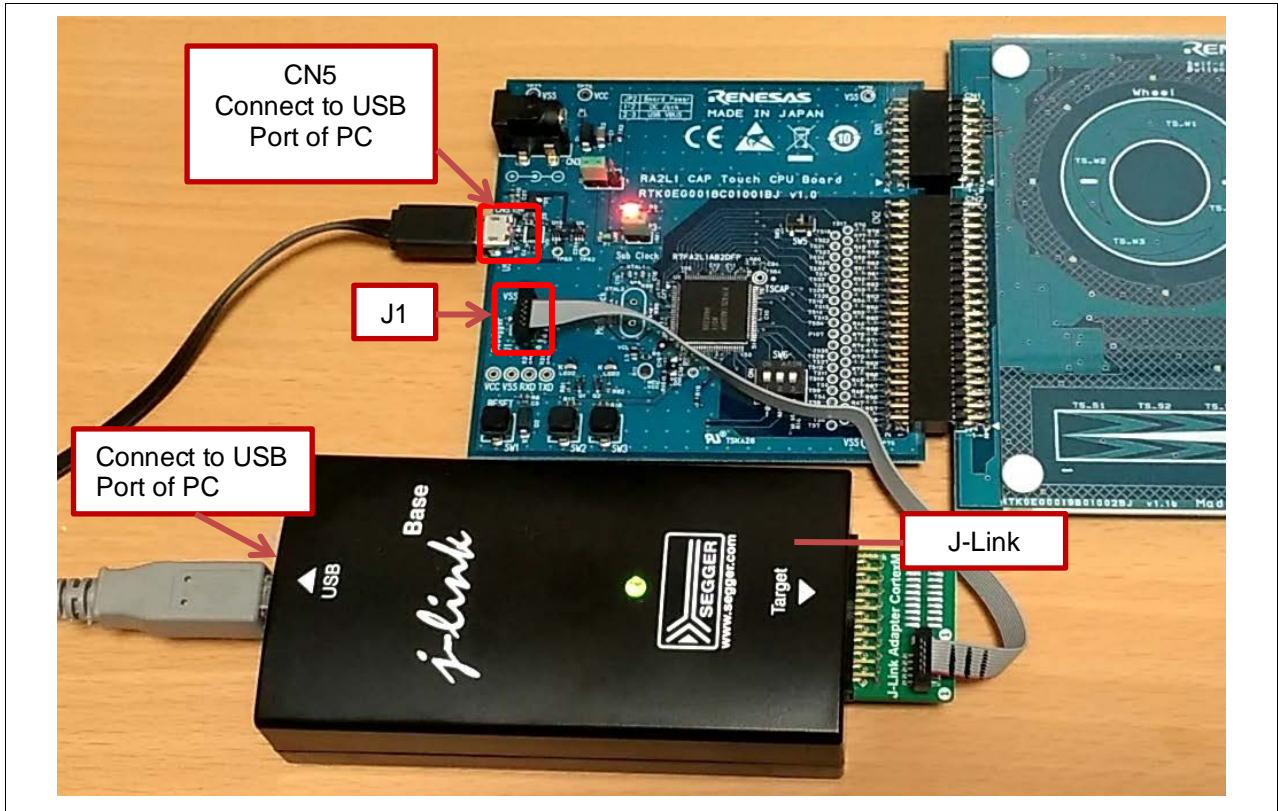

Figure 53. Debug Connection

3. Click **Project**, select **Download and Debug**.

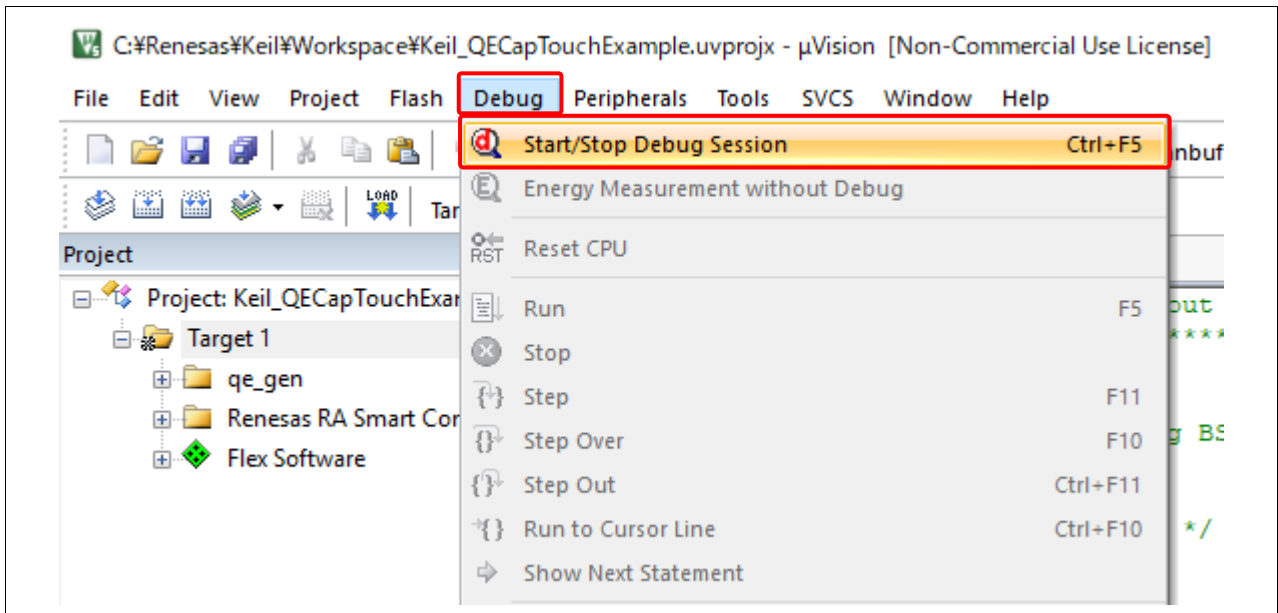

Figure 54. Download & Debug Project

4. The **Disassembly** window will pop up and the project should run smoothly.

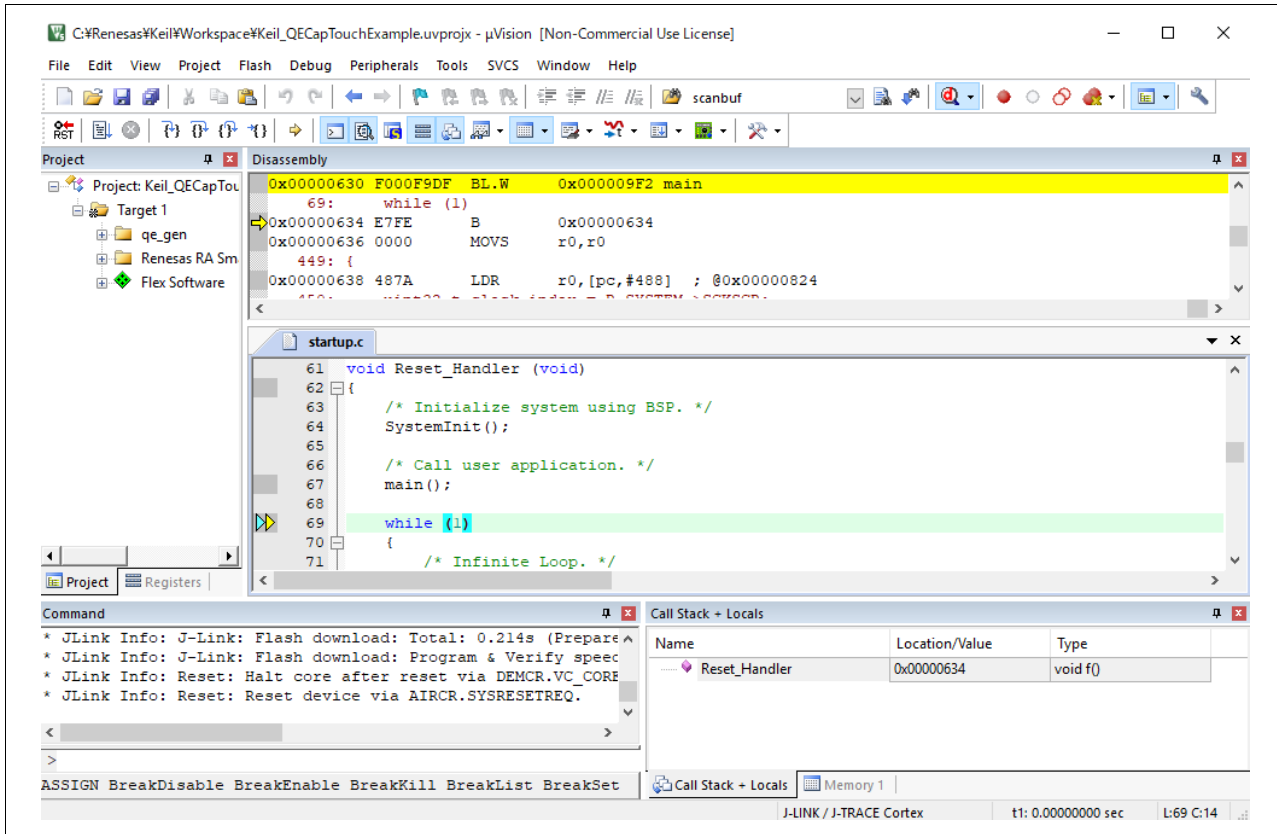

Figure 55. Run Project Smoothly

Website and Support

Visit the following vanity URLs to learn about key elements of the RA family, download components and related documentation, and get support.

RA Product Information	www.renesas.com/ra
RA Product Support Forum	www.renesas.com/ra/forum
RA Flexible Software Package	www.renesas.com/FSP
Renesas Support	www.renesas.com/support

Revision History

Rev.	Date	Description	
		Page	Summary
1.0.0	Feb 26, 2021	-	First release
1.10	Jan 26, 2022	1	Update to Operating Environment
		-	Changed version FSP to v3.5.0
		-	Changed version QE for Capacitive Touch to v3.0.1
		4	Changed debugger to J-Link
		10	Added Setup Configuration

General Precautions in the Handling of Microprocessing Unit and Microcontroller Unit Products

The following usage notes are applicable to all Microprocessing unit and Microcontroller unit products from Renesas. For detailed usage notes on the products covered by this document, refer to the relevant sections of the document as well as any technical updates that have been issued for the products.

1. Precaution against Electrostatic Discharge (ESD)

A strong electrical field, when exposed to a CMOS device, can cause destruction of the gate oxide and ultimately degrade the device operation. Steps must be taken to stop the generation of static electricity as much as possible, and quickly dissipate it when it occurs. Environmental control must be adequate. When it is dry, a humidifier should be used. This is recommended to avoid using insulators that can easily build up static electricity.

Semiconductor devices must be stored and transported in an anti-static container, static shielding bag or conductive material. All test and measurement tools including work benches and floors must be grounded. The operator must also be grounded using a wrist strap. Semiconductor devices must not be touched with bare hands. Similar precautions must be taken for printed circuit boards with mounted semiconductor devices.

2. Processing at power-on

The state of the product is undefined at the time when power is supplied. The states of internal circuits in the LSI are indeterminate and the states of register settings and pins are undefined at the time when power is supplied. In a finished product where the reset signal is applied to the external reset pin, the states of pins are not guaranteed from the time when power is supplied until the reset process is completed. In a similar way, the states of pins in a product that is reset by an on-chip power-on reset function are not guaranteed from the time when power is supplied until the power reaches the level at which resetting is specified.

3. Input of signal during power-off state

Do not input signals or an I/O pull-up power supply while the device is powered off. The current injection that results from input of such a signal or I/O pull-up power supply may cause malfunction and the abnormal current that passes in the device at this time may cause degradation of internal elements. Follow the guideline for input signal during power-off state as described in your product documentation.

4. Handling of unused pins

Handle unused pins in accordance with the directions given under handling of unused pins in the manual. The input pins of CMOS products are generally in the high-impedance state. In operation with an unused pin in the open-circuit state, extra electromagnetic noise is induced in the vicinity of the LSI, an associated shoot-through current flows internally, and malfunctions occur due to the false recognition of the pin state as an input signal become possible.

5. Clock signals

After applying a reset, only release the reset line after the operating clock signal becomes stable. When switching the clock signal during program execution, wait until the target clock signal is stabilized. When the clock signal is generated with an external resonator or from an external oscillator during a reset, ensure that the reset line is only released after full stabilization of the clock signal. Additionally, when switching to a clock signal produced with an external resonator or by an external oscillator while program execution is in progress, wait until the target clock signal is stable.

6. Voltage application waveform at input pin

Waveform distortion due to input noise or a reflected wave may cause malfunction. If the input of the CMOS device stays in the area between V_{IL} (Max.) and V_{IH} (Min.) due to noise, for example, the device may malfunction. Take care to prevent chattering noise from entering the device when the input level is fixed, and also in the transition period when the input level passes through the area between V_{IL} (Max.) and V_{IH} (Min.).

7. Prohibition of access to reserved addresses

Access to reserved addresses is prohibited. The reserved addresses are provided for possible future expansion of functions. Do not access these addresses as the correct operation of the LSI is not guaranteed.

8. Differences between products

Before changing from one product to another, for example to a product with a different part number, confirm that the change will not lead to problems. The characteristics of a microprocessing unit or microcontroller unit products in the same group but having a different part number might differ in terms of internal memory capacity, layout pattern, and other factors, which can affect the ranges of electrical characteristics, such as characteristic values, operating margins, immunity to noise, and amount of radiated noise. When changing to a product with a different part number, implement a system-evaluation test for the given product.

Notice

1. Descriptions of circuits, software and other related information in this document are provided only to illustrate the operation of semiconductor products and application examples. You are fully responsible for the incorporation or any other use of the circuits, software, and information in the design of your product or system. Renesas Electronics disclaims any and all liability for any losses and damages incurred by you or third parties arising from the use of these circuits, software, or information.
 2. Renesas Electronics hereby expressly disclaims any warranties against and liability for infringement or any other claims involving patents, copyrights, or other intellectual property rights of third parties, by or arising from the use of Renesas Electronics products or technical information described in this document, including but not limited to, the product data, drawings, charts, programs, algorithms, and application examples.
 3. No license, express, implied or otherwise, is granted hereby under any patents, copyrights or other intellectual property rights of Renesas Electronics or others.
 4. You shall be responsible for determining what licenses are required from any third parties, and obtaining such licenses for the lawful import, export, manufacture, sales, utilization, distribution or other disposal of any products incorporating Renesas Electronics products, if required.
 5. You shall not alter, modify, copy, or reverse engineer any Renesas Electronics product, whether in whole or in part. Renesas Electronics disclaims any and all liability for any losses or damages incurred by you or third parties arising from such alteration, modification, copying or reverse engineering.
 6. Renesas Electronics products are classified according to the following two quality grades: "Standard" and "High Quality". The intended applications for each Renesas Electronics product depends on the product's quality grade, as indicated below.
 - "Standard": Computers; office equipment; communications equipment; test and measurement equipment; audio and visual equipment; home electronic appliances; machine tools; personal electronic equipment; industrial robots; etc.
 - "High Quality": Transportation equipment (automobiles, trains, ships, etc.); traffic control (traffic lights); large-scale communication equipment; key financial terminal systems; safety control equipment; etc.
- Unless expressly designated as a high reliability product or a product for harsh environments in a Renesas Electronics data sheet or other Renesas Electronics document, Renesas Electronics products are not intended or authorized for use in products or systems that may pose a direct threat to human life or bodily injury (artificial life support devices or systems; surgical implantations; etc.), or may cause serious property damage (space system; undersea repeaters; nuclear power control systems; aircraft control systems; key plant systems; military equipment; etc.). Renesas Electronics disclaims any and all liability for any damages or losses incurred by you or any third parties arising from the use of any Renesas Electronics product that is inconsistent with any Renesas Electronics data sheet, user's manual or other Renesas Electronics document.
7. No semiconductor product is absolutely secure. Notwithstanding any security measures or features that may be implemented in Renesas Electronics hardware or software products, Renesas Electronics shall have absolutely no liability arising out of any vulnerability or security breach, including but not limited to any unauthorized access to or use of a Renesas Electronics product or a system that uses a Renesas Electronics product. RENESAS ELECTRONICS DOES NOT WARRANT OR GUARANTEE THAT RENESAS ELECTRONICS PRODUCTS, OR ANY SYSTEMS CREATED USING RENESAS ELECTRONICS PRODUCTS WILL BE INVULNERABLE OR FREE FROM CORRUPTION, ATTACK, VIRUSES, INTERFERENCE, HACKING, DATA LOSS OR THEFT, OR OTHER SECURITY INTRUSION ("Vulnerability Issues"). RENESAS ELECTRONICS DISCLAIMS ANY AND ALL RESPONSIBILITY OR LIABILITY ARISING FROM OR RELATED TO ANY VULNERABILITY ISSUES. FURTHERMORE, TO THE EXTENT PERMITTED BY APPLICABLE LAW, RENESAS ELECTRONICS DISCLAIMS ANY AND ALL WARRANTIES, EXPRESS OR IMPLIED, WITH RESPECT TO THIS DOCUMENT AND ANY RELATED OR ACCOMPANYING SOFTWARE OR HARDWARE, INCLUDING BUT NOT LIMITED TO THE IMPLIED WARRANTIES OF MERCHANTABILITY, OR FITNESS FOR A PARTICULAR PURPOSE.
 8. When using Renesas Electronics products, refer to the latest product information (data sheets, user's manuals, application notes, "General Notes for Handling and Using Semiconductor Devices" in the reliability handbook, etc.), and ensure that usage conditions are within the ranges specified by Renesas Electronics with respect to maximum ratings, operating power supply voltage range, heat dissipation characteristics, installation, etc. Renesas Electronics disclaims any and all liability for any malfunctions, failure or accident arising out of the use of Renesas Electronics products outside of such specified ranges.
 9. Although Renesas Electronics endeavors to improve the quality and reliability of Renesas Electronics products, semiconductor products have specific characteristics, such as the occurrence of failure at a certain rate and malfunctions under certain use conditions. Unless designated as a high reliability product or a product for harsh environments in a Renesas Electronics data sheet or other Renesas Electronics document, Renesas Electronics products are not subject to radiation resistance design. You are responsible for implementing safety measures to guard against the possibility of bodily injury, injury or damage caused by fire, and/or danger to the public in the event of a failure or malfunction of Renesas Electronics products, such as safety design for hardware and software, including but not limited to redundancy, fire control and malfunction prevention, appropriate treatment for aging degradation or any other appropriate measures. Because the evaluation of microcomputer software alone is very difficult and impractical, you are responsible for evaluating the safety of the final products or systems manufactured by you.
 10. Please contact a Renesas Electronics sales office for details as to environmental matters such as the environmental compatibility of each Renesas Electronics product. You are responsible for carefully and sufficiently investigating applicable laws and regulations that regulate the inclusion or use of controlled substances, including without limitation, the EU RoHS Directive, and using Renesas Electronics products in compliance with all these applicable laws and regulations. Renesas Electronics disclaims any and all liability for damages or losses occurring as a result of your noncompliance with applicable laws and regulations.
 11. Renesas Electronics products and technologies shall not be used for or incorporated into any products or systems whose manufacture, use, or sale is prohibited under any applicable domestic or foreign laws or regulations. You shall comply with any applicable export control laws and regulations promulgated and administered by the governments of any countries asserting jurisdiction over the parties or transactions.
 12. It is the responsibility of the buyer or distributor of Renesas Electronics products, or any other party who distributes, disposes of, or otherwise sells or transfers the product to a third party, to notify such third party in advance of the contents and conditions set forth in this document.
 13. This document shall not be reprinted, reproduced or duplicated in any form, in whole or in part, without prior written consent of Renesas Electronics.
 14. Please contact a Renesas Electronics sales office if you have any questions regarding the information contained in this document or Renesas Electronics products.

(Note1) "Renesas Electronics" as used in this document means Renesas Electronics Corporation and also includes its directly or indirectly controlled subsidiaries.

(Note2) "Renesas Electronics product(s)" means any product developed or manufactured by or for Renesas Electronics.

(Rev.5.0-1 October 2020)

Corporate Headquarters

TOYOSU FORESIA, 3-2-24 Toyosu,
Koto-ku, Tokyo 135-0061, Japan
www.renesas.com

Trademarks

Renesas and the Renesas logo are trademarks of Renesas Electronics Corporation. All trademarks and registered trademarks are the property of their respective owners.

Contact information

For further information on a product, technology, the most up-to-date version of a document, or your nearest sales office, please visit:
www.renesas.com/contact/.