

RL78/G14

R01AN4686EJ0100

Rev.1.00

Measuring Distance to an Object with Ultrasonic Sensor

Feb 21, 2019

Introduction

This application note describes an example to measure distance to an object with ultrasonic sensor.

The timer array unit and the serial interface IICA are used to control ultrasonic sensor and LCD character display module.

Target Device

RL78/G14

When applying the sample program covered in this application note to another microcomputer, modify the program according to the specifications for the target microcomputer and conduct an extensive evaluation of the modified program.

Contents

1. Specifications	3
1.1 Method of Controlling an Ultrasonic Sensor.....	4
1.2 Converting Time to Distance	4
1.3 Format of LCD Character Display	4
2. Conditions of Operation Confirmation Test	5
3. Hardware	6
3.1 Example of Hardware Configuration	6
3.2 Used Pins	6
4. Software Explanation	7
4.1 Operation Outline	7
4.2 Option Byte Settings	8
4.3 Constants	8
4.4 Global Variables	9
4.5 Functions	9
4.6 Function Specifications	10
4.7 Flowcharts	13
4.7.1 Overall Flow.....	13
4.7.2 Initialization Function	13
4.7.3 System Initial Setting.....	14
4.7.4 CPU Initial Setting	15
4.7.5 I/O Port Setup.....	16
4.7.6 Serial Interface IICA Initialization Function	17
4.7.7 Timer Array Unit Initial Setting.....	19
4.7.8 Main Processing	21
4.7.9 LCD Character Display Initialization Function.....	23
4.7.10 LCD Character Display Command Send Function.....	24
4.7.11 LCD Character Display Data Send Function.....	25
4.7.12 TAU00 Operation Start Function	26
4.7.13 TAU01 Operation Start Function	26
4.7.14 Calculate Distance Function.....	27
4.7.15 TAU00 Interrupt Function	28
4.7.16 TAU01 Interrupt Function	29
5. Sample Code.....	30

1. Specifications

In this application note, measure distance to an object with ultrasonic sensor in each interval time. The Timer Array Unit (TAU) is used to control ultrasonic sensor. Time-of-Flight (TOF) value output by ultrasonic sensor is converted to distance. The distance is displayed on the LCD character display with Serial Interface IICA.

Table 1.1 shows the required peripheral functions and their uses.

Table 1.1 Used Peripheral Functions and Purposes

Peripheral Functions	Purposes
TAU00	To generate pulse wave that activates ultrasonic sensor.
TAU01	To capture sensor output
IICA0	To communicate with the LCD character display

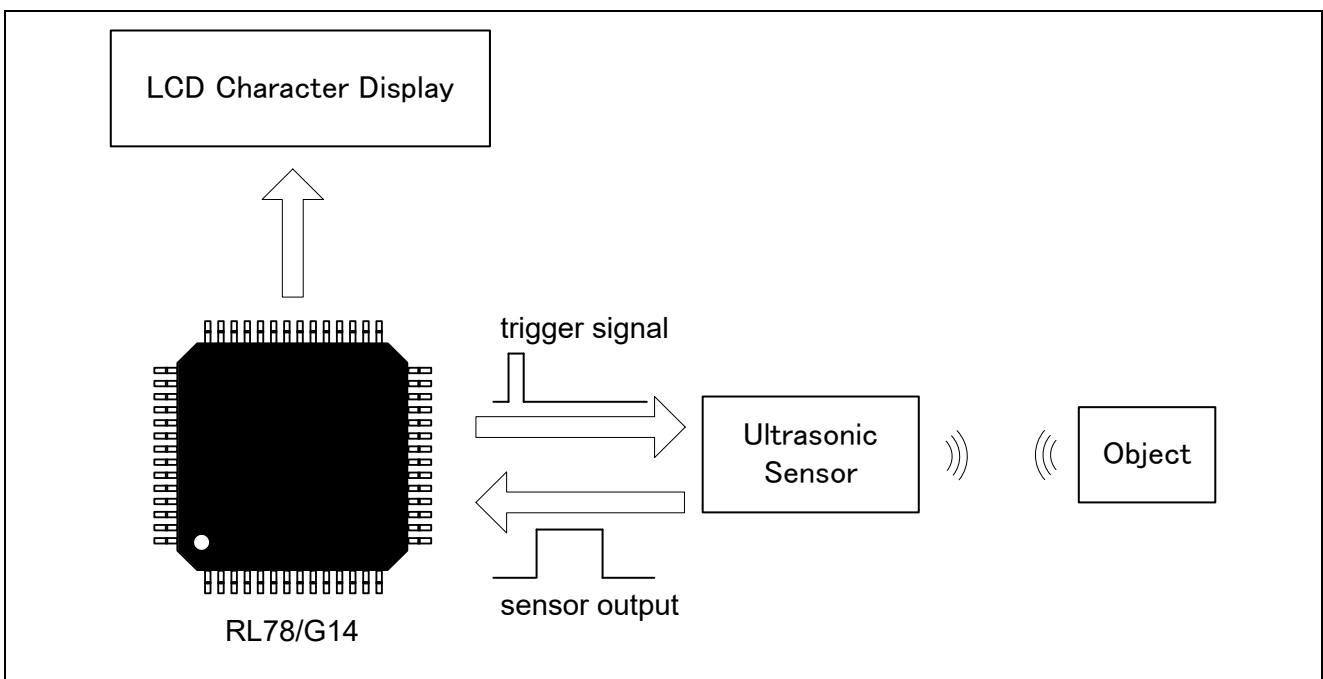

Figure 1.1 Outline of Distance Measuring System

1.1 Method of Controlling an Ultrasonic Sensor.

An ultrasonic sensor used in this application note consists of a transmitting speaker and a receiving microphone. The sensor outputs the time sound travels between the sensor and an object.

For example, when a trigger signal is input to the sensor as shown in Figure 1.2, the sensor outputs an output signal which width has proportional to the distance to the object.

To generate the trigger signal, the "square wave output" function of the timer array unit is used. And to measure the high-level width output by the sensor, the "input signal high-/low-level width measurement" function is used. Also, to reduce noise, calculate moving average of the measurement result.

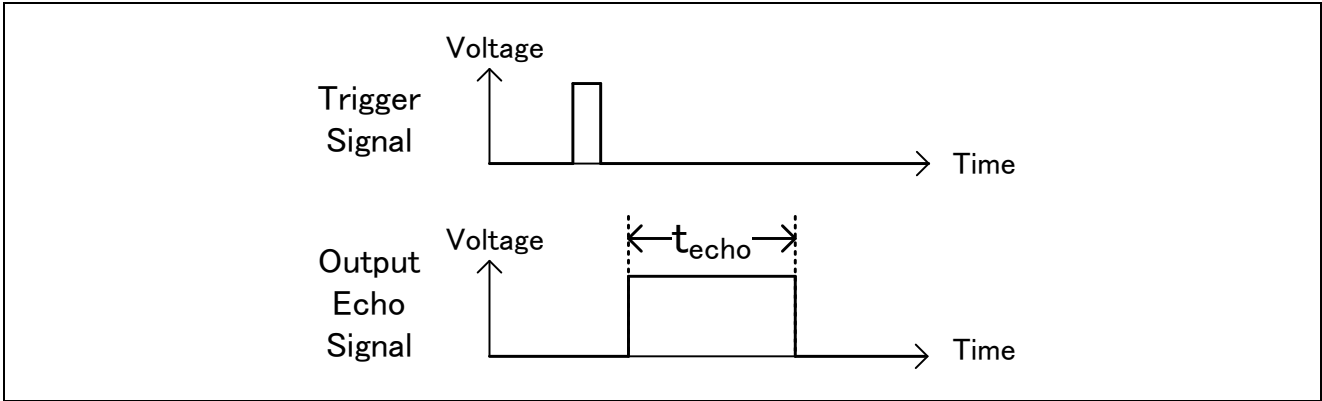

Figure 1.2 Trigger Signal and Output Echo Signal

1.2 Converting Time to Distance

The Euclidean distance between the ultrasonic sensor and the target surface d [m] can be obtained by converting t_{echo} [s] using following expressions (1.1) and (1.2). The sound velocity c is assumed to be constant at 340.29 [m/s].

$$d \text{ [m]} = \frac{t_{echo} \text{ [s]}}{2} c, \quad c = 340.29 \text{ [m/s]} \tag{1.1}$$

$$t_{echo} \text{ [s]} = \frac{TDR01}{f_{TCLK} \text{ [Hz]}} \tag{1.2}$$

1.3 Format of LCD Character Display

For the LCD character display, I2C connection and 16 × 2 display HD44780 compatible products are used.

The distance measured by the sensor is displayed in the format shown in Figure 1.3. (display range is 0 to 999.9 cm)

D	I	S	T	A	N	C	E	:									
1	2	3	.	4	c	m											

Figure 1.3 Display Pattern of the LCD Character Display.

2. Conditions of Operation Confirmation Test

The sample code with this application note runs properly under the conditions below.

Table 2.1 Operation Confirmation Conditions

Items	Contents
MCU	RL78/G14 (R5F104PJA)
Operating frequencies	High-speed on-chip oscillator (HOCO) clock: 32 MHz CPU/peripheral hardware clock: 32 MHz
Operating voltage	5.0V LVD operations (VLVD): reset mode TYP. 2.75 [V] Rising edge 2.76 to 2.87 [V] Falling edge 2.70 to 2.81 [V]
Integrated development environment (CS+)	CS+ for CC V7.00.00 from Renesas Electronics Corp.
C compiler (CS+)	CC-RL V1.07.00 from Renesas Electronics Corp.

3. Hardware

3.1 Example of Hardware Configuration

Figure 3.1 shows an example of the hardware configuration used in this application note.

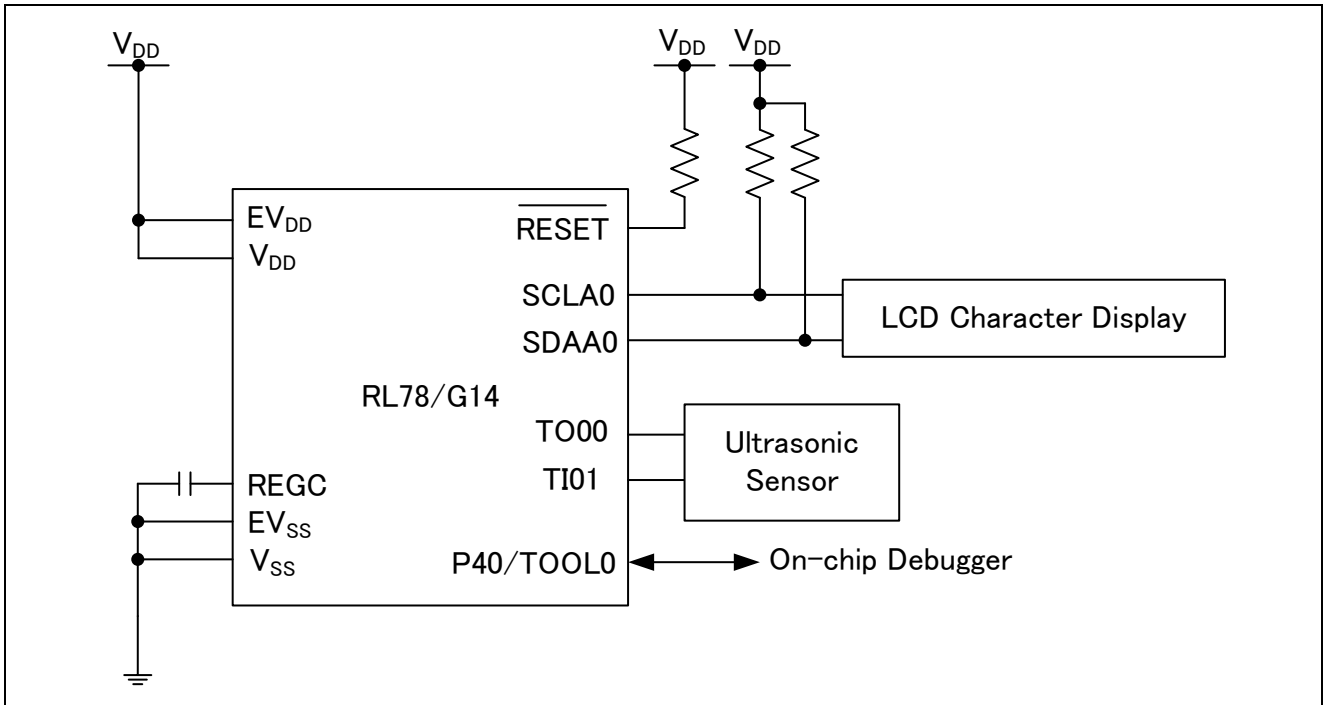

Figure 3.1 Hardware Configuration

Note 1: This simplified circuit diagram was created to show an overview of connections only.

When actually designing your circuit, make sure the design includes sufficient pin processing and meets electrical characteristic requirements. (Connect each input-only port to V_{DD} or V_{SS} through a resistor.)

Note 2: Connect any pins whose name begins with EVSS to VSS and any pins whose name begins with EVDD to VDD, respectively.

Note 3: VDD must be held at not lower than the reset release voltage (VLVD) that is specified as LVD.

3.2 Used Pins

Table 3.1 shows list of used Pins and assigned functions.

Table 3.1 List of Pins and Functions

Pin Name	Input/Output	Function
SCLA0	Output	I ² C serial clock
SDAA0	Output	I ² C serial data bus
TO00	Output	Trigger signal for ultrasonic sensor
TI01	Inpt	Output signal from ultrasonic sensor

4. Software Explanation

4.1 Operation Outline

In the sample program in this application note, after initializing the timer array unit Serial Interface IICA, MCU shifts to HALT mode.

MCU releases HALT mode by INTTM00 or INTTM01 interrupt. If capturing of sensor output have been completed, display the calculated distance to LCD character display, then shifts to HALT mode. In other case, just shifts to HALT mode.

① Initialize the Timer Array Unit

< Conditions for setting channel 0 >

- Timer operation mode is set to Interval Timer.
- Interval time is set to 100 us by the Timer data register (TDR).
- Timer interrupt (INTTM00) from timer channel 0 is used. (INTTM00)
- Timer interrupt is generated when counting is started (INTTM00)
-

< Conditions for setting channel 1 >

- Timer operation mode is set to “capture & one-count” mode.
- Set the measurable pulse interval to $2 \text{ us} < \text{TI01} < 131.071 \text{ ms}$.
- Enable the noise filter of TI01
- Both edges (to measure high-level width)
- Select TI01 pin input edge to both edge for measuring high-level width
- Timer interrupt is generated when counting is started (INTTM01)

② Initialize serial interface IICA

- Set the transfer mode to single master.
- Select the count clock to $f\text{CLK} / 2$.
- Set the local address to 10H.
- Select the normal mode as the operation mode.
- Set the transfer clock frequency to 50000 Hz.

③ Initialize LCD display pattern.

④ MCU shifts to HALT mode.

⑤ MCU releases HALT mode by interrupts.

⑥ If capturing of sensor output have been completed, display the calculated distance to LCD character display,

⑦ Repeat steps ④ to ⑥ above.

4.2 Option Byte Settings

Table 4.1 lists the option byte settings.

Table 4.1 Option Byte Settings

Address	Setting Value	Contents
000C0H/010C0H	1110 1111B	Operation of Watchdog timer is stopped (counting is stopped after reset.)
000C1H/010C1H	0111 1111B	LVD operations (VLVD): reset mode TYP. 2.75 [V] Rising edge 2.76 to 2.87 [V] Falling edge 2.70 to 2.81 [V]
000C2H/010C2H	1110 1000B	HS mode, High-speed on-chip oscillator clock: 32 MHz
000C3H/010C3H	1000 0100B	On-chip debugging enabled

4.3 Constants

Table 4.2 lists the constants that are used in this sample program.

Table 4.2 Constants in the Sample Program

Constant Name	Setting Value	Contents
MOVE_AVERAGE_NUM	5	number of samples to calculate moving average
DISTANCE_SENSOR_WAIT_MSEC	250	interval time of activating the ultrasonic sensor
LCD_SLAVE_ADDR	A0H	I2C slave address for the LCD character display module

4.4 Global Variables

Table 4.3 lists the global variables.

Table 4.3 Global Variables

Type	Variable Name	Contents	Functions used in
uint32_t	g_distance_echo_sum	Sum of high-level width measurement result for calculate moving average.	user_main(), r_tau0_channel1_interrupt()
uint8_t	g_f_distance_updated	Whether high-level width measurement is completed or not	user_main(), r_tau0_channel1_interrupt()

4.5 Functions

Table 4.4 lists the functions.

Table 4.4 Functions

Function Name	Outline
main	Main processing
user_main	User main processing
R_MAIN_UserInit	Main initial setting
calc_distance	Convert the time it took a sound to travel between objects to distance.
LCD_Init	LCD character display initialization function
write_command	Send a control command to the LCD character display
write_data	Send a display data to the LCD character display
wait_msec	Wait for n [ms] set by argument
wait_1msec	Wait for 1 [ms]

[Function Name]	lcd_init	
Outline	LCD character display initialization function	
Header	lcd.h	
Declaration	void LCD_Init(void);	
Description	Initialize LCD character display	
Arguments	None	
Return value	None	
Remarks	None	
[Function Name]	calc_distance	
Outline	Convert time to distance	
Header	None	
Declaration	uint16_t calc_distance(uint16_t tdr);	
Description	Convert the time it took a sound to travel between two objects to distance.	
Arguments	tdr	Measurement result of high-level width (TDR register value)
Return value	distance	Distance to the object [mm]
Remarks	None	
[Function Name]	write_command	
Outline	Control command send function to LCD character display	
Header	lcd.h	
Declaration	void write_command(uint8_t command)	
Description	Send a control command to the LCD character display	
Arguments	command	Control command
Return value	None	
Remarks	None	
[Function Name]	write_data	
Outline	Display data send function to LCD character display	
Header	lcd.h	
Declaration	void write_data(uint8_t* data, uint8_t data_num)	
Description	Send display data to the LCD character display	
Arguments	data	Address of data buffer
Return value	data_num	Size of data [Byte]
Remarks	None	
Outline	None	

4.7 Flowcharts

4.7.1 Overall Flow

Figure 4.1 shows an overall flow of the sample code.

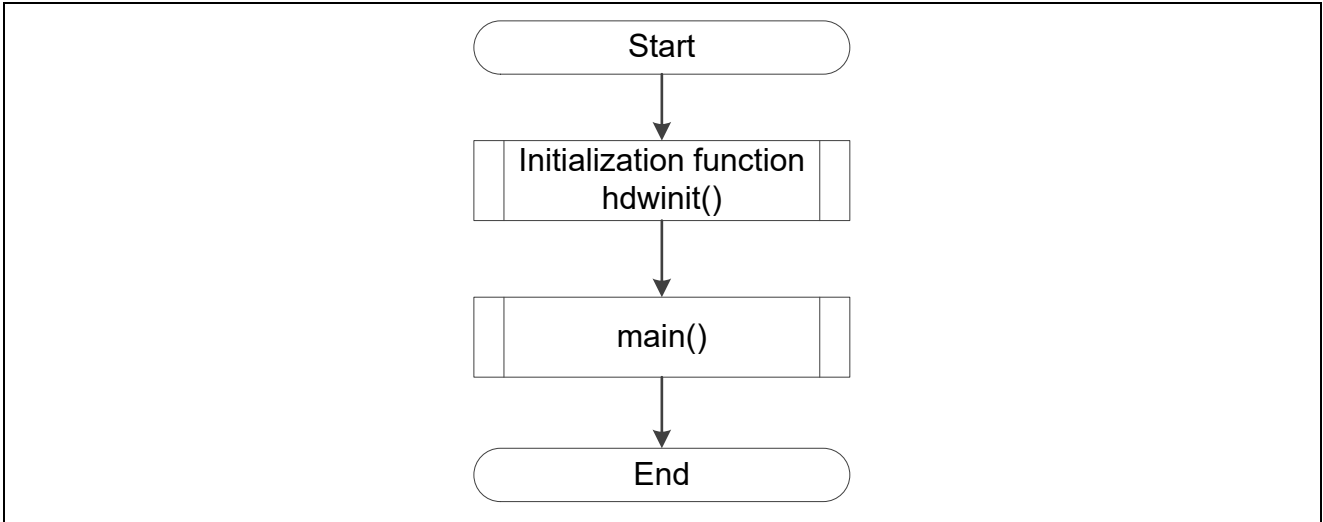

Figure 4.1 Overall Flow

Note: Refer to the RL78/G14 user's manual (hardware) for details on individual registers.

4.7.2 Initialization Function

Figure 4.2 shows the flowchart of the initialization function.

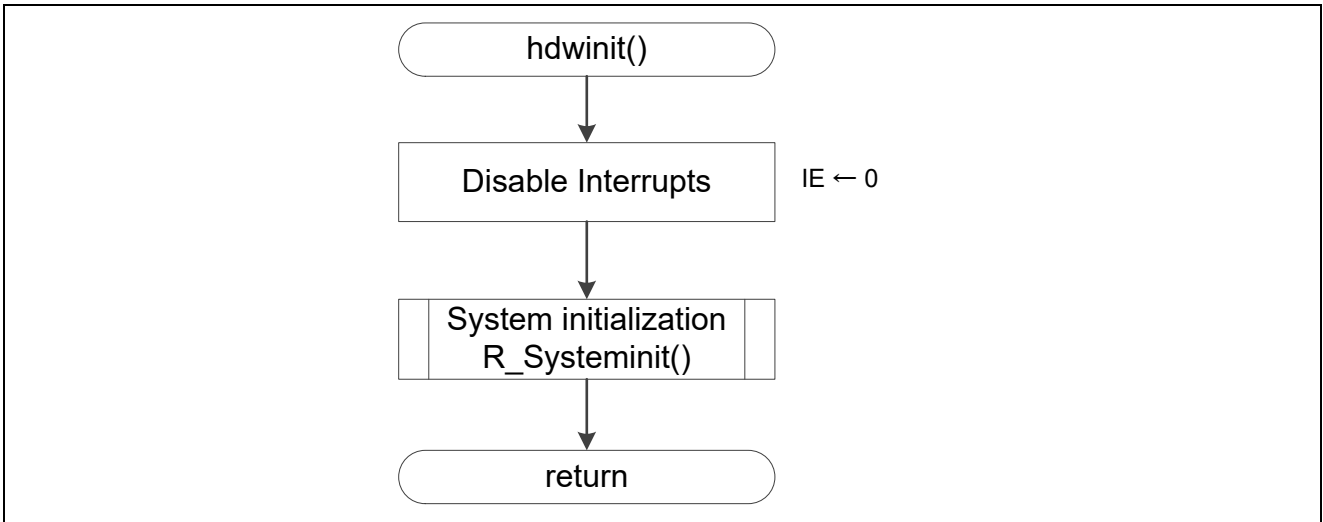

Figure 4.2 Initialization function

Note: Refer to the RL78/G14 user's manual (hardware) for details on individual registers.

4.7.3 System Initial Setting

Figure 4.3 shows the flowchart of the system initial setting.

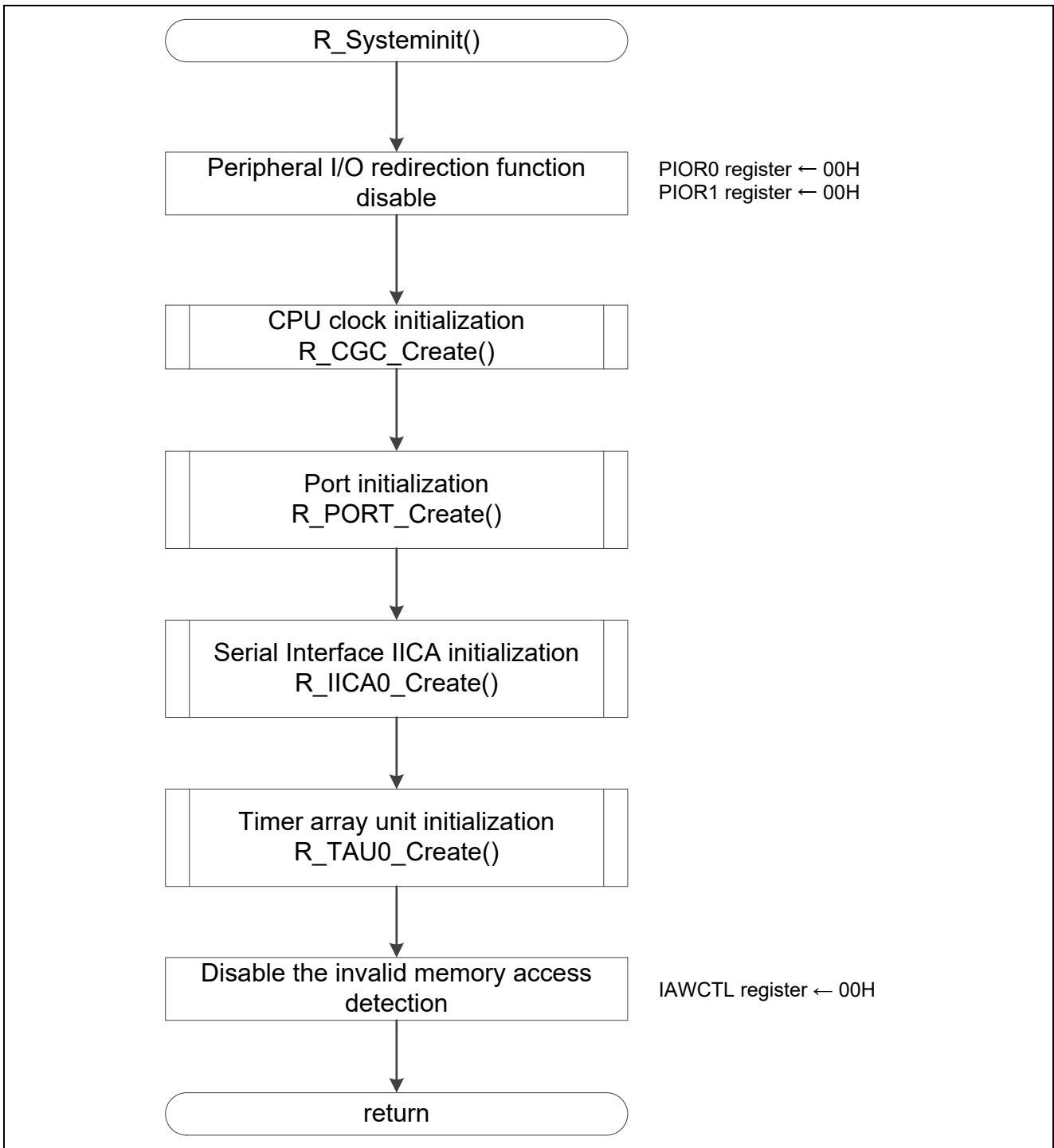

Figure 4.3 System initial setting

Note: Refer to the RL78/G14 user’s manual (hardware) for details on individual registers.

4.7.4 CPU Initial Setting

Figure 4.4 shows the flowchart of the CPU initial setting.

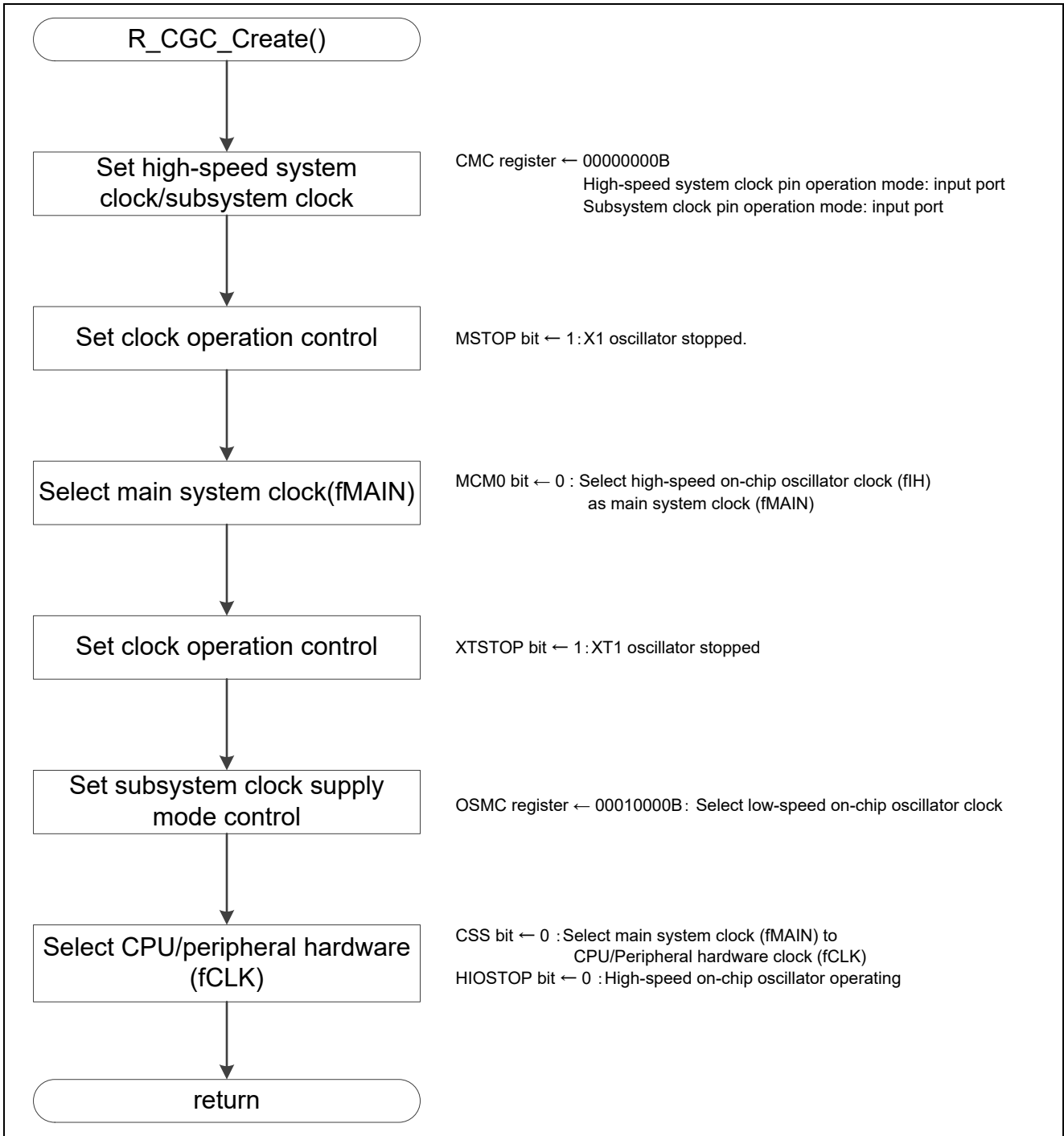

Figure 4.4 CPU Initial Setting

Note: Refer to the RL78/G14 user’s manual (hardware) for details on individual registers.

4.7.5 I/O Port Setup

Figure 4.5 Shows the flowchart of I/O port setup.

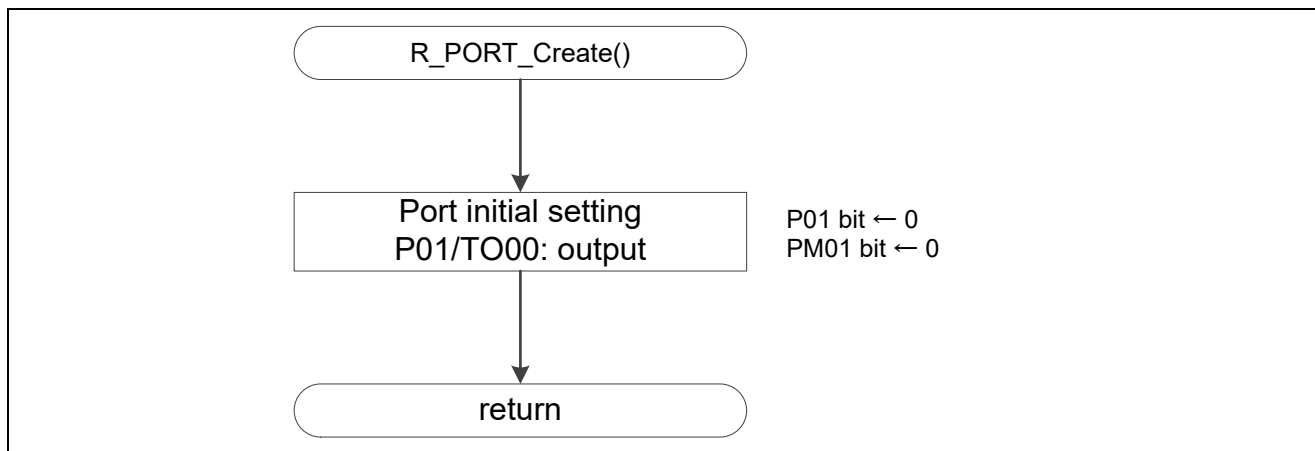

Figure 4.5 I/O Port Setup

Note: Refer to the RL78/G14 user's manual (hardware) for details on individual registers.

When actually designing your circuit, make sure the design includes sufficient pin processing and meets electrical characteristic requirements. (Connect each input-only port to V_{DD} or V_{SS} through a resistor.)

4.7.6 Serial Interface IICA Initialization Function

Figure 4.6, Figure 4.7 Shows the flowchart of Serial Interface IICA Initialization Function.

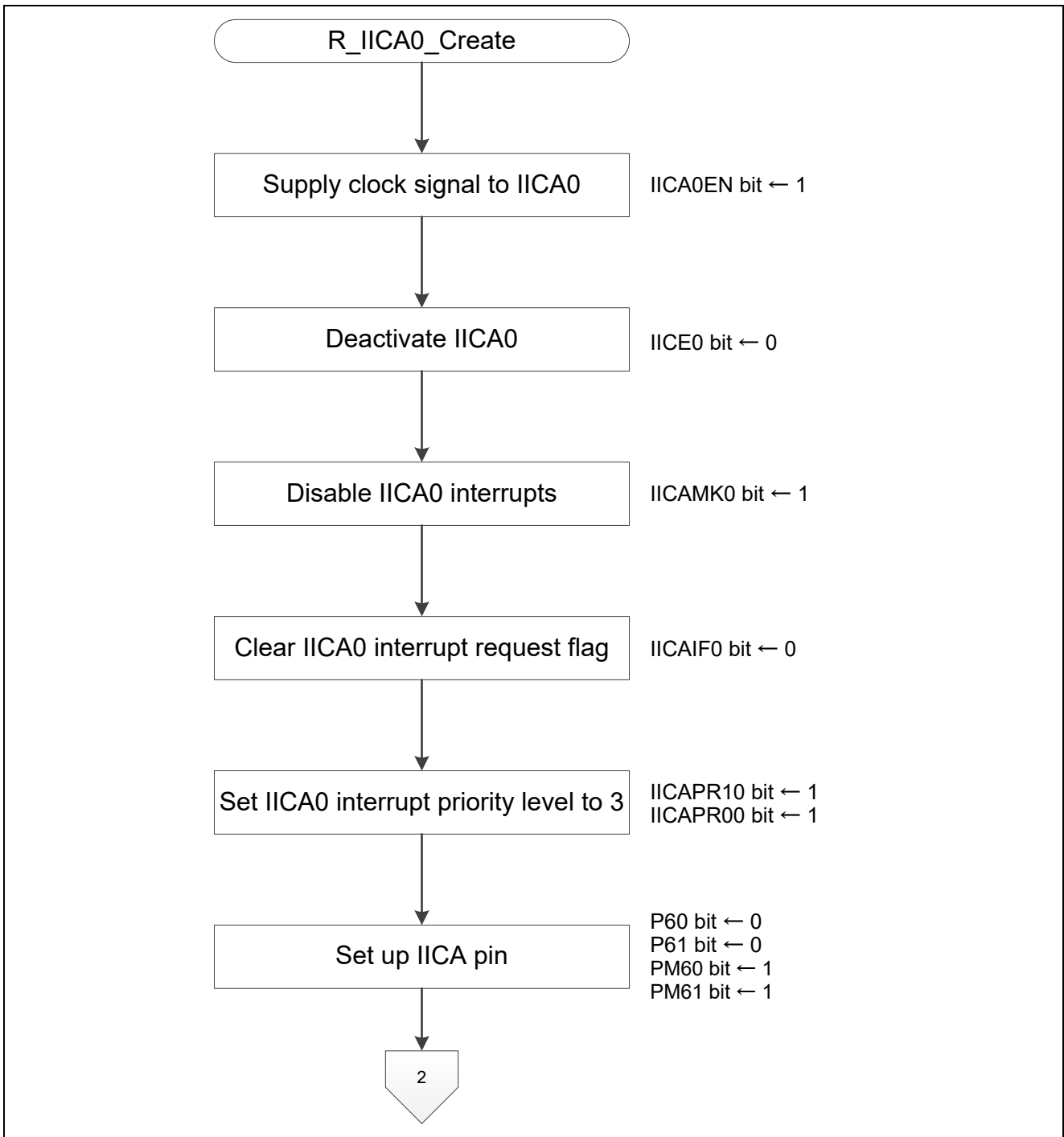

Figure 4.6 Serial Interface IICA initialization function (1/2)

Note: Refer to the RL78/G14 user's manual (hardware) for details on individual registers.

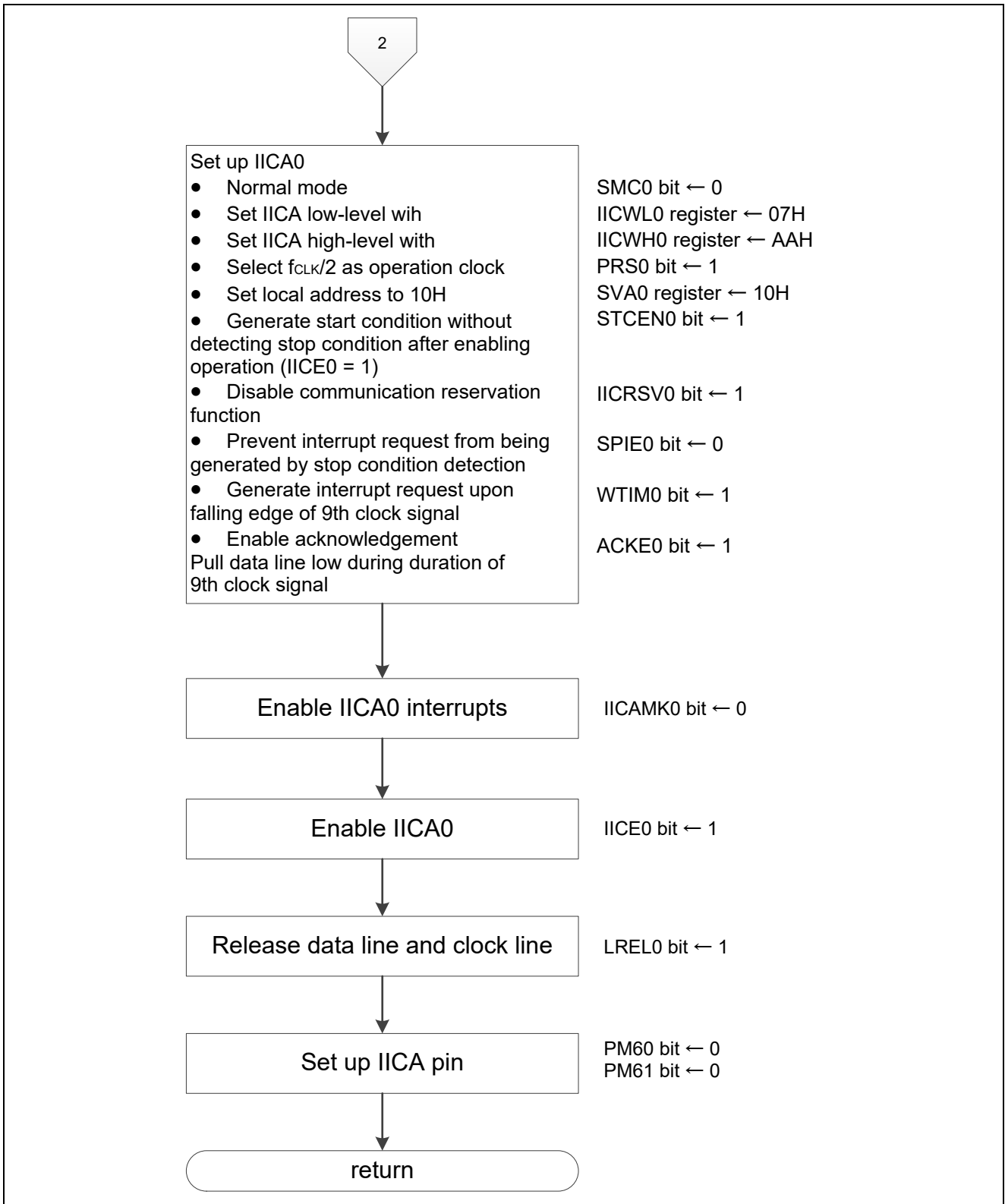

Figure 4.7 Serial Interface IICA initialization function (2/2)

Note: Refer to the RL78/G14 user's manual (hardware) for details on individual registers.

4.7.7 Timer Array Unit Initial Setting

Figure 4.8, Figure 4.9 shows the flowchart for the timer array unit initial setting.

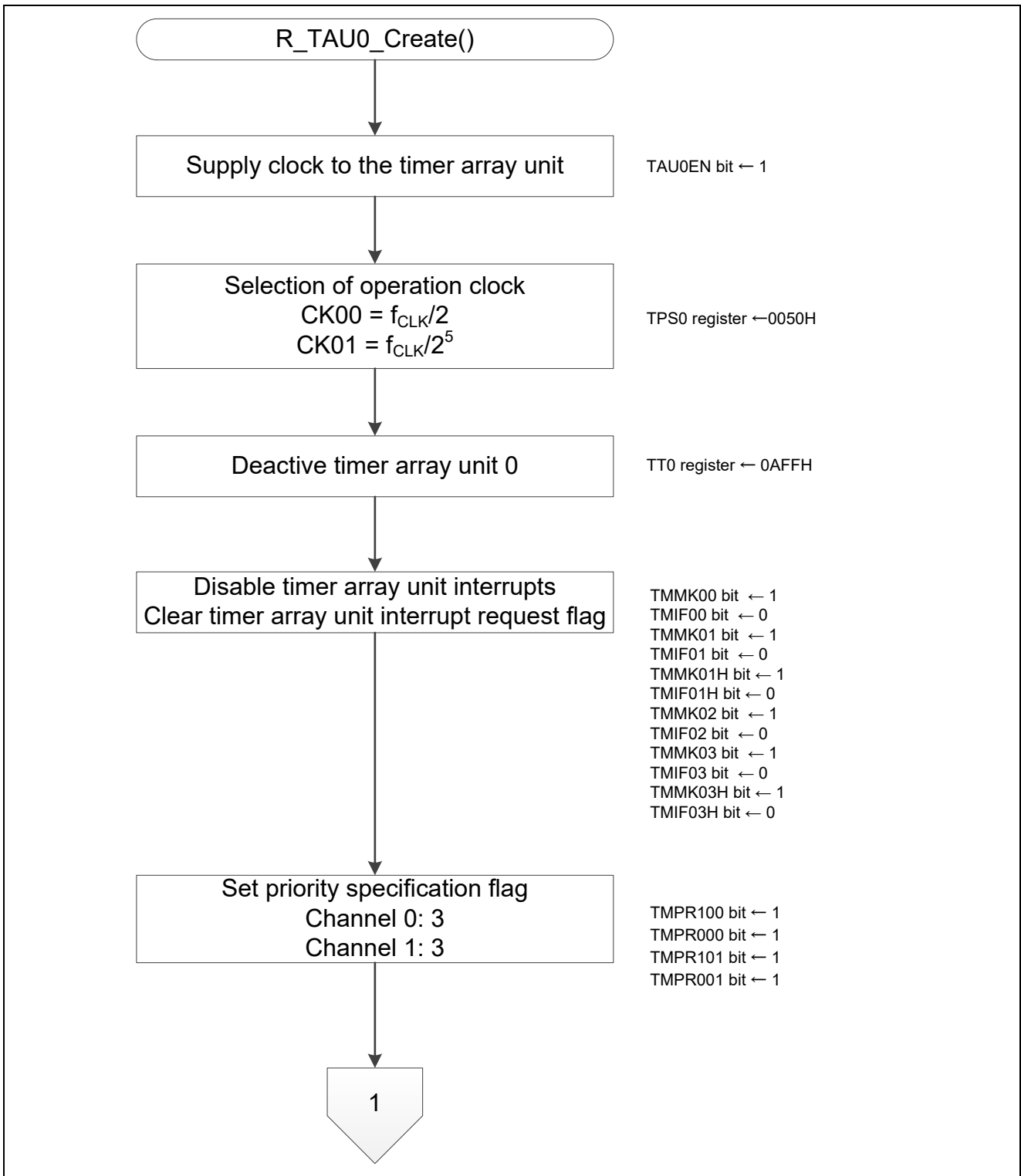

Figure 4.8 Timer array unit initial setting (1/2)

Note: Refer to the RL78/G14 user's manual (hardware) for details on individual registers.

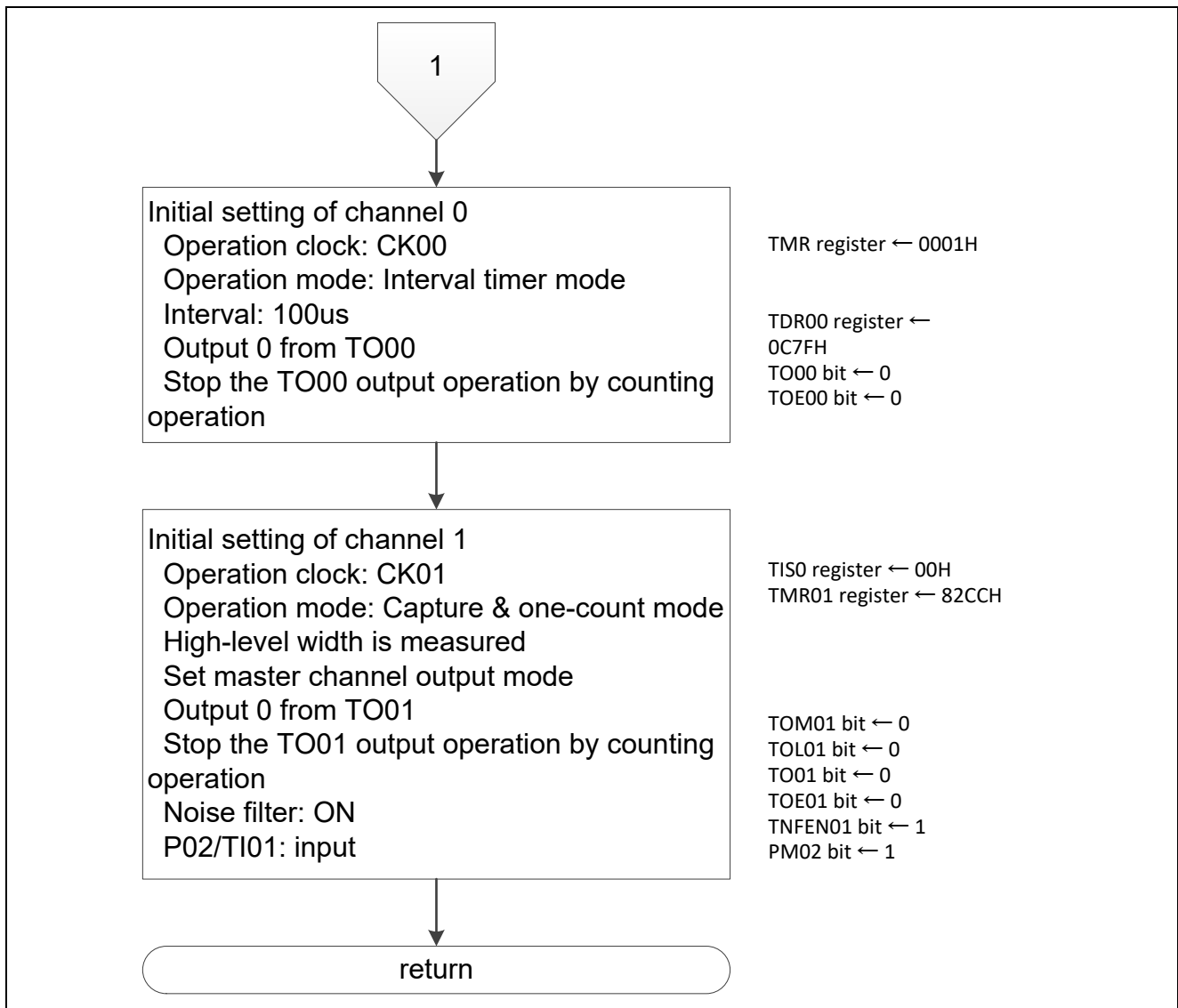

Figure 4.9 Timer array unit initial setting (2/2)

Note: Refer to the RL78/G14 user's manual (hardware) for details on individual registers.

4.7.8 Main Processing

Figure 4.10, Figure 4.11, Figure 4.12 Shows the flowchart of main processing.

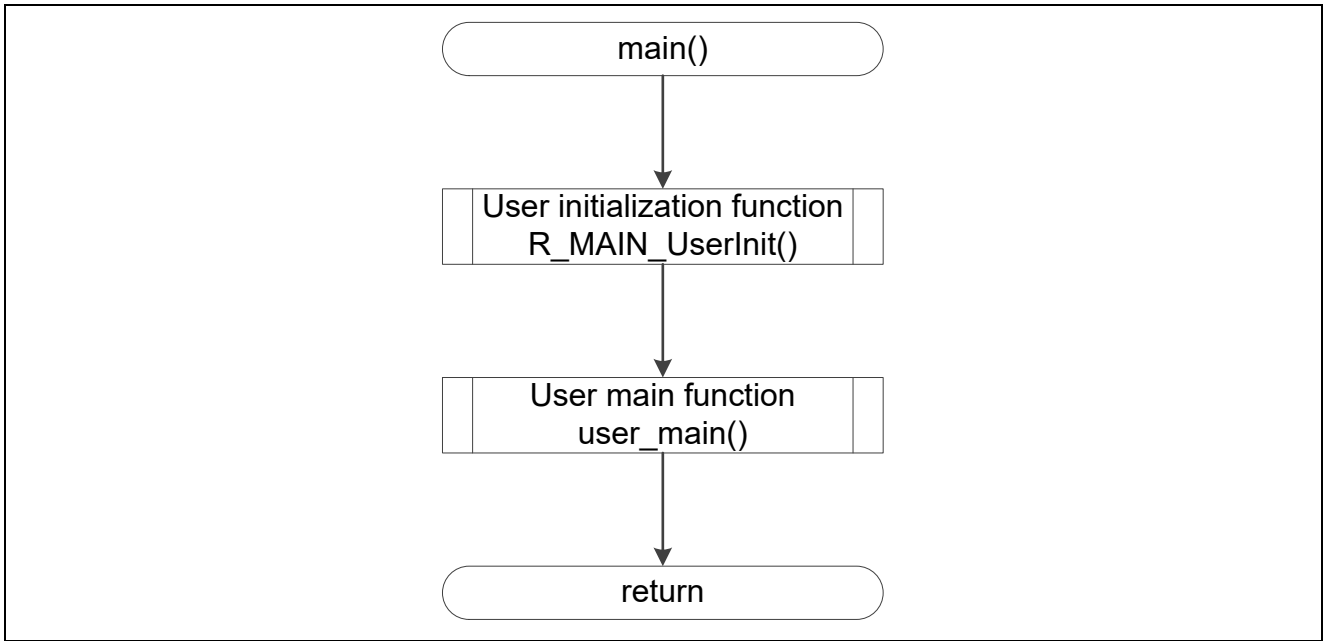

Figure 4.10 Main Processing (1/3)

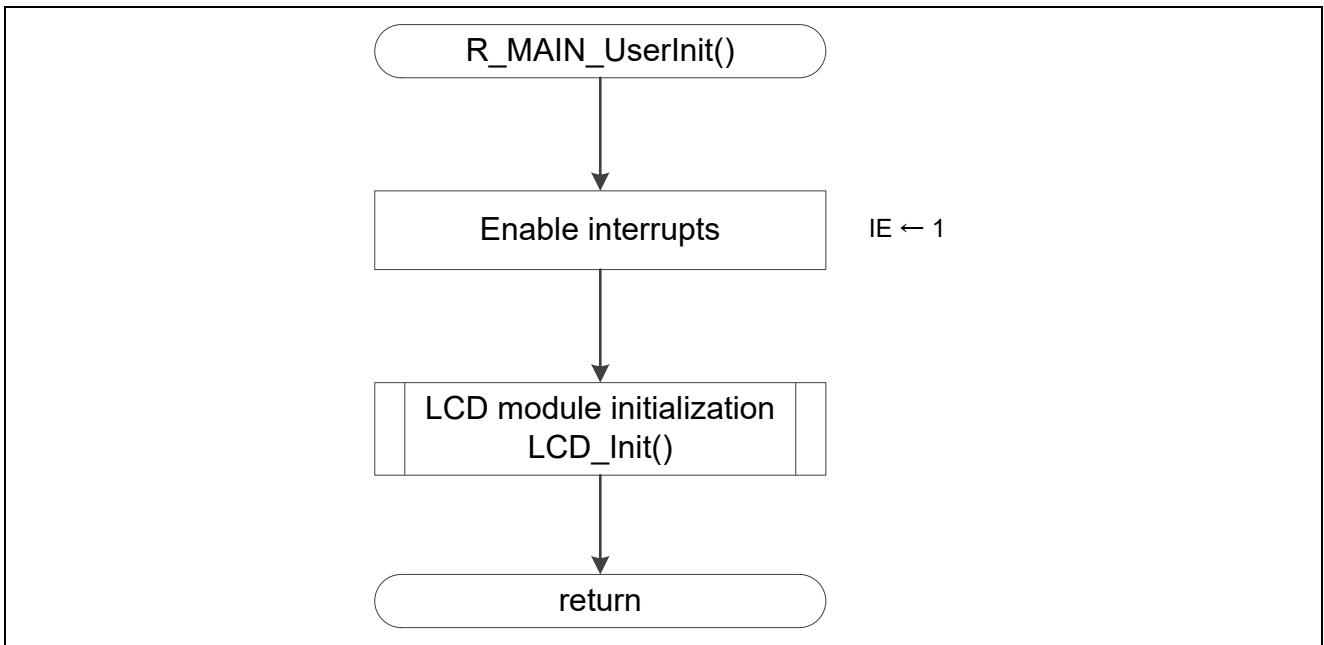

Figure 4.11 Main Processing (2/3)

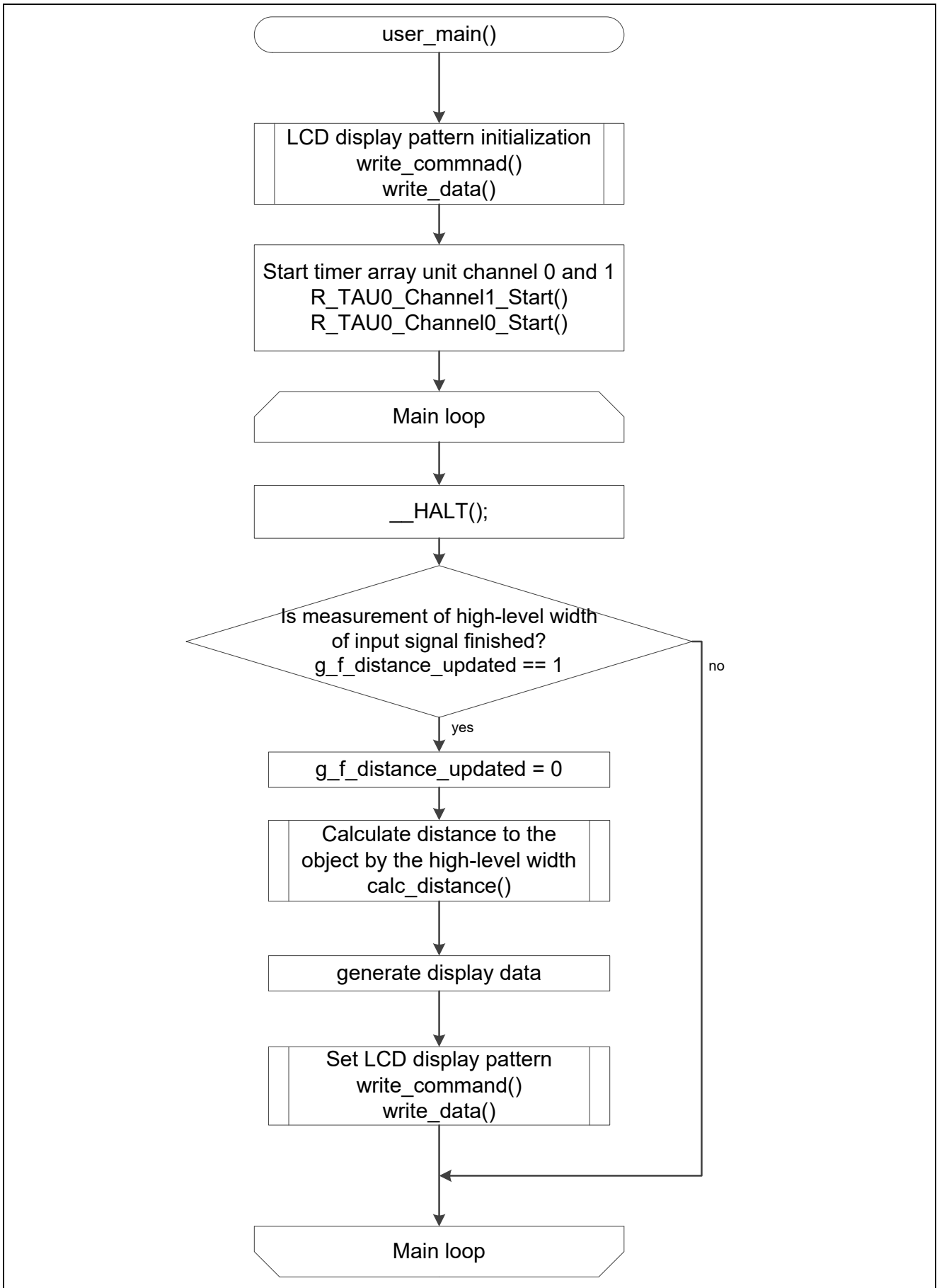

Figure 4.12 Main Processing (3/3)

4.7.9 LCD Character Display Initialization Function

Figure 4.13 shows the flowchart of LCD character display initialization function.

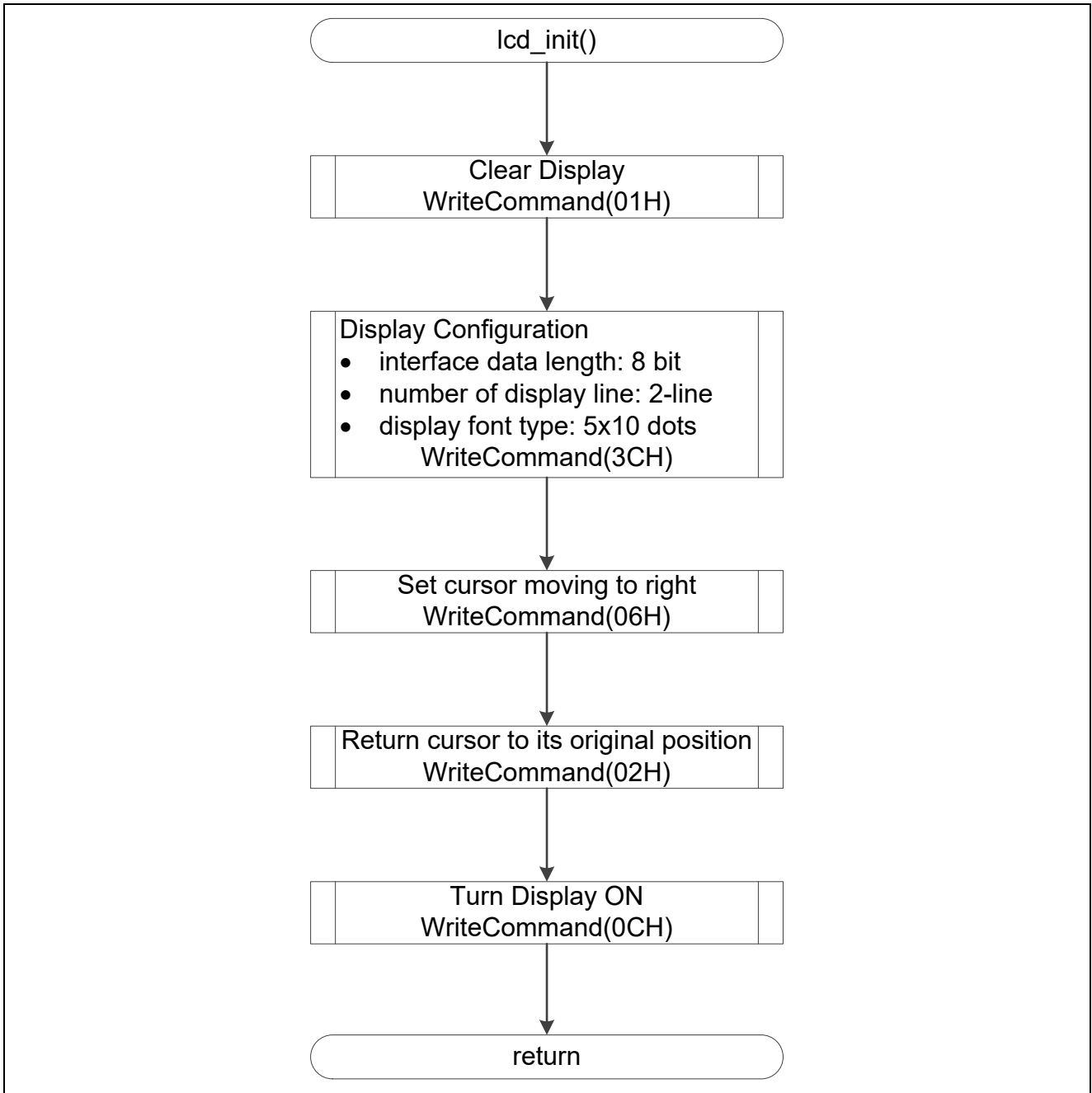

Figure 4.13 LCD Character Display Initialization Function

4.7.10 LCD Character Display Command Send Function

Figure 4.14 shows the flowchart of LCD character display command send function.

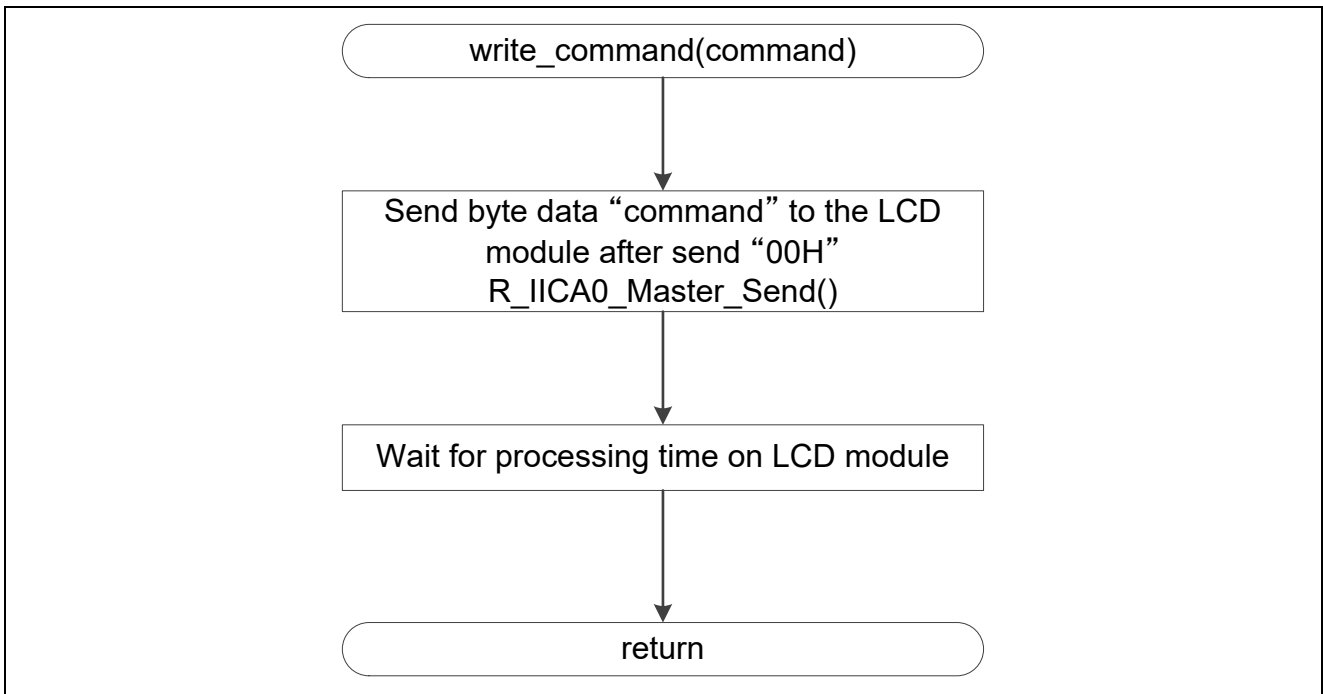

Figure 4.14 LCD Character Display Command Send Function

4.7.11 LCD Character Display Data Send Function

Figure 4.15 show the flowchart of LCD character display data send function.

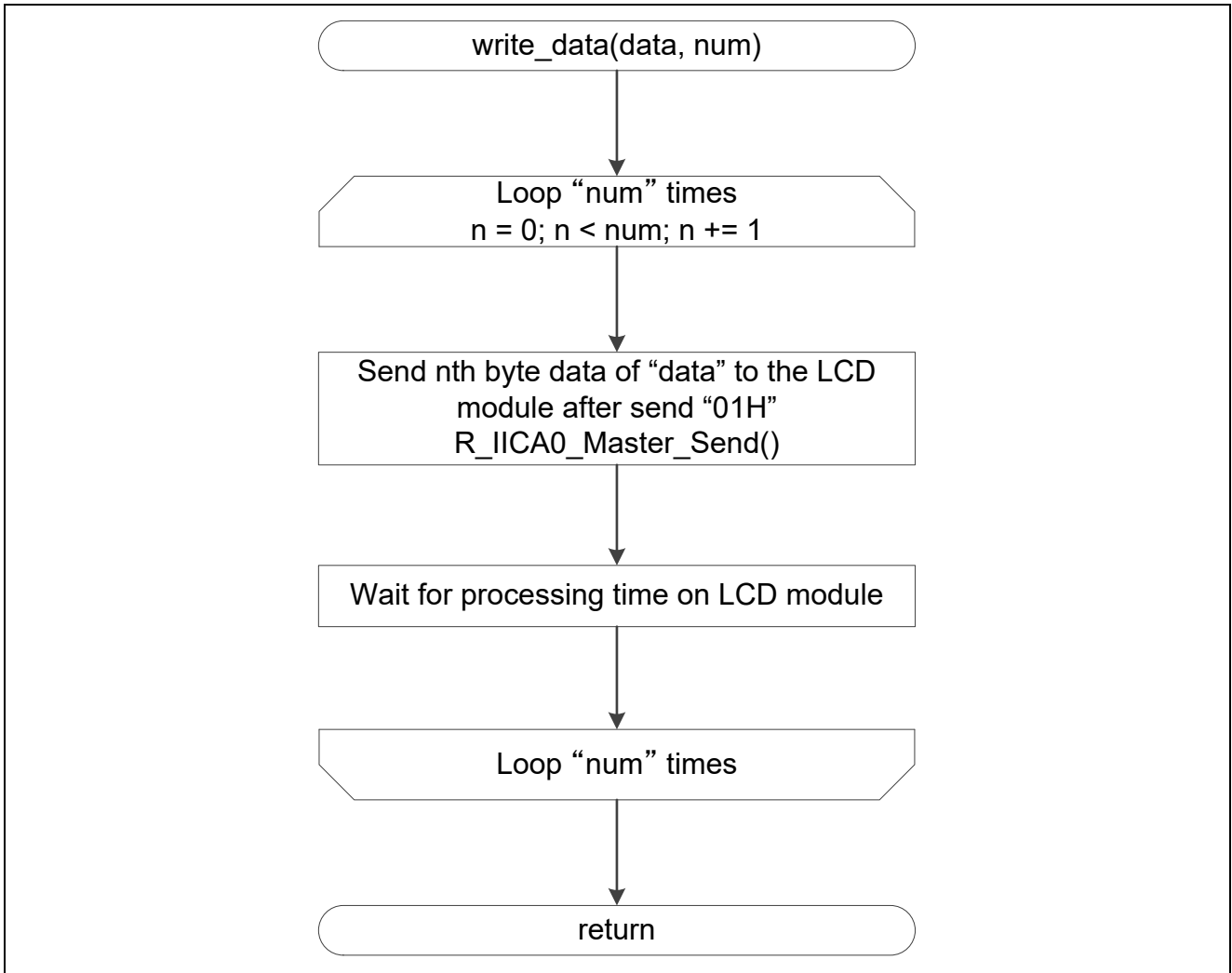

Figure 4.15 LCD Character Display Data Send Function

4.7.12 TAU00 Operation Start Function

Figure 4.16 shows the flowchart of TAU00 operation start function.

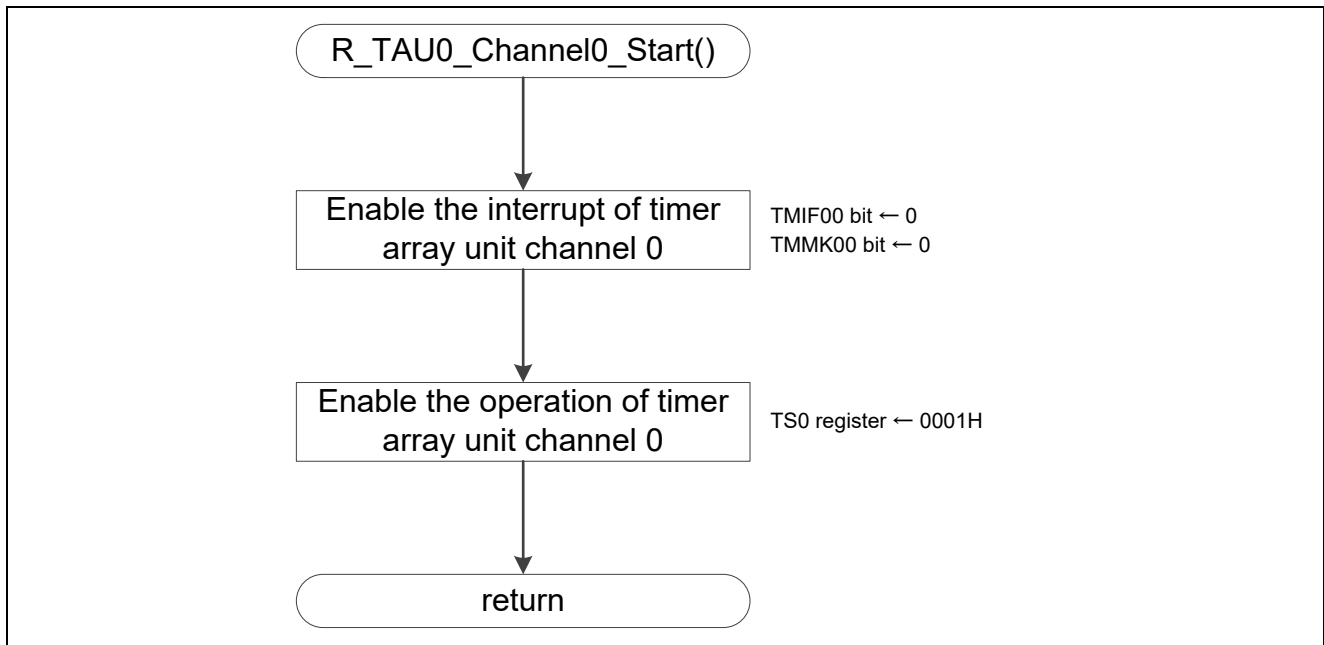

Figure 4.16 TAU00 Operation Start Function

Note: Refer to the RL78/G14 user's manual (hardware) for details on individual registers.

4.7.13 TAU01 Operation Start Function

Figure 4.17 shows the flowchart of TAU01 operation start function.

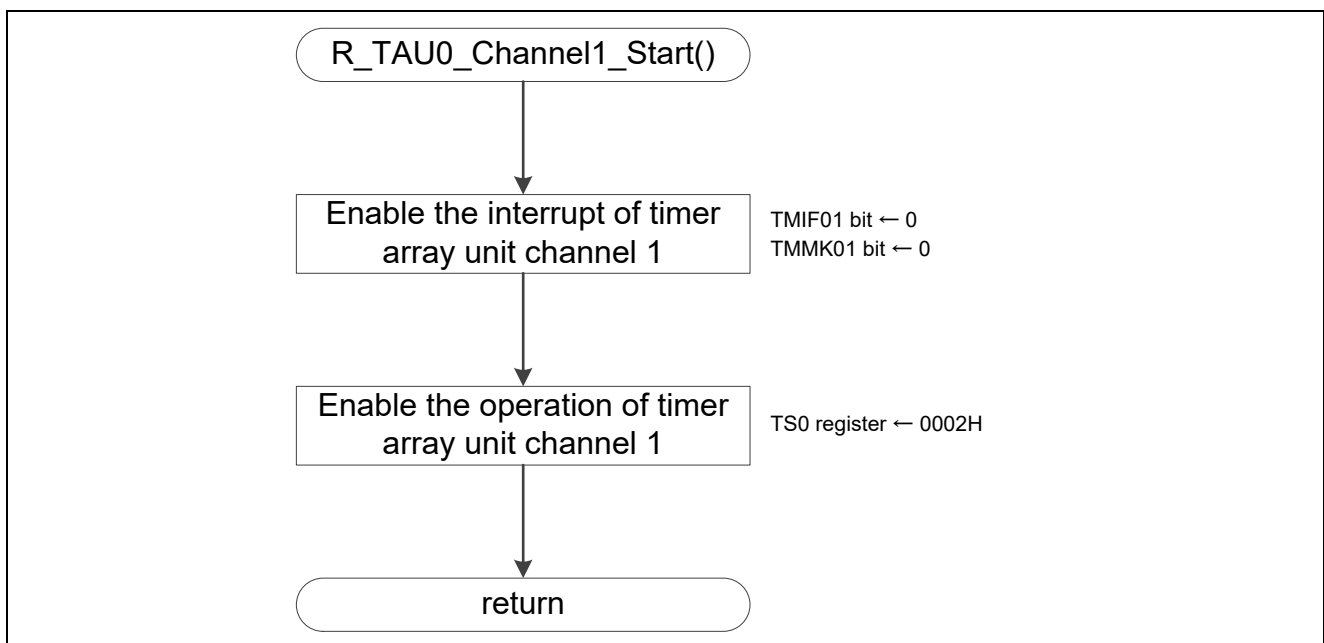

Figure 4.17 TAU01 Operation Start Function

Note: Refer to the RL78/G14 user's manual (hardware) for details on individual registers.

4.7.14 Calculate Distance Function

Figure 4.18 shows the flowchart of calculate distance function

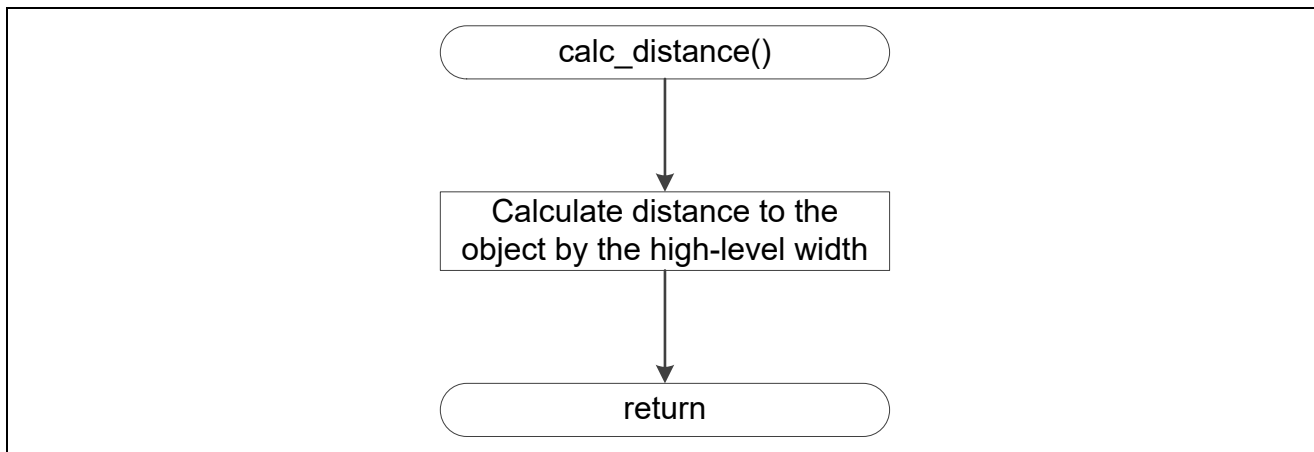

Figure 4.18 Calculate Distance Function

4.7.15 TAU00 Interrupt Function

Figure 4.19 shows the flowchart of TAU00 interrupt function

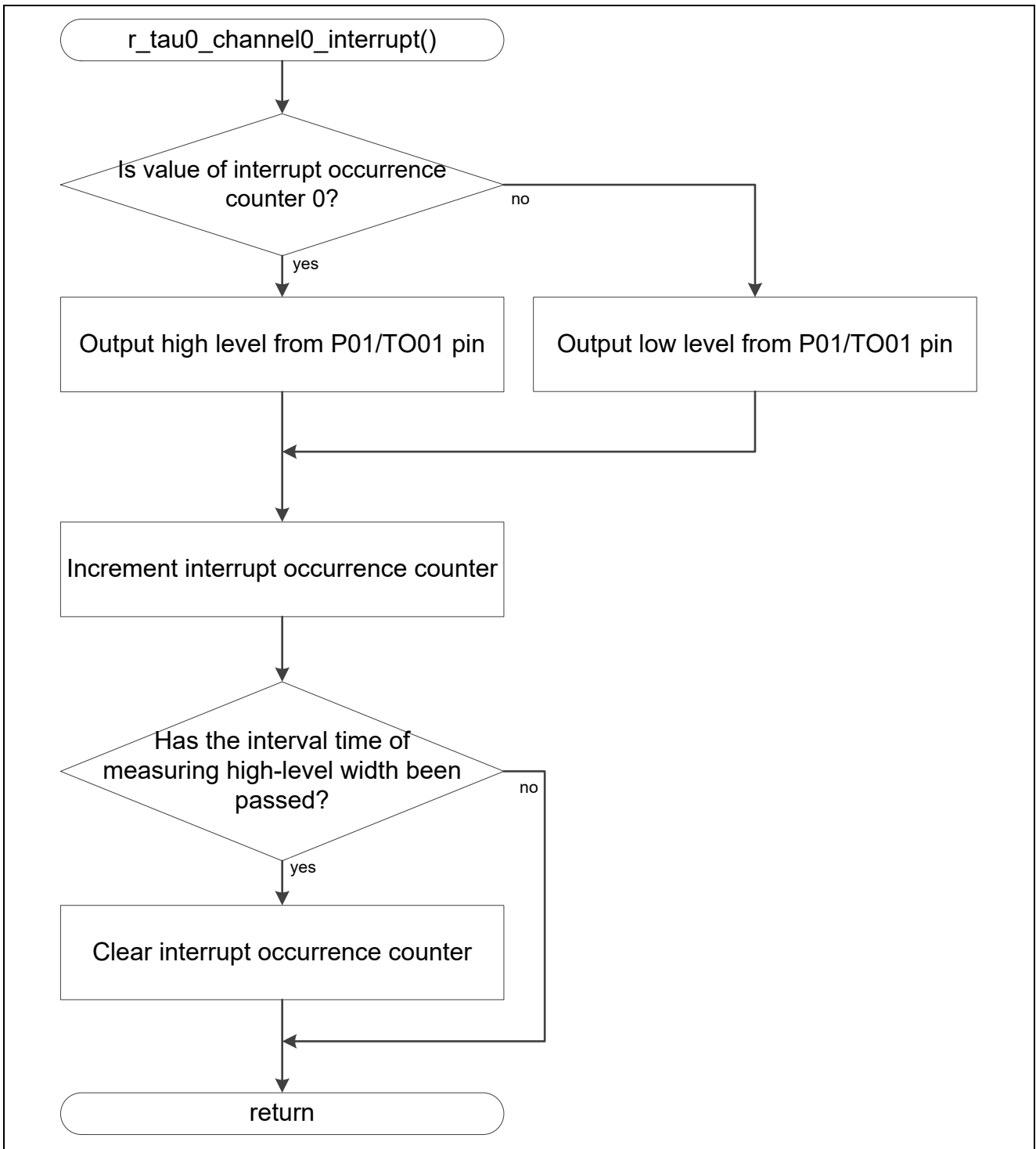

Figure 4.19 TAU00 Interrupt Function

4.7.16 TAU01 Interrupt Function

Figure 4.20 shows the flowchart of TAU01 interrupt function

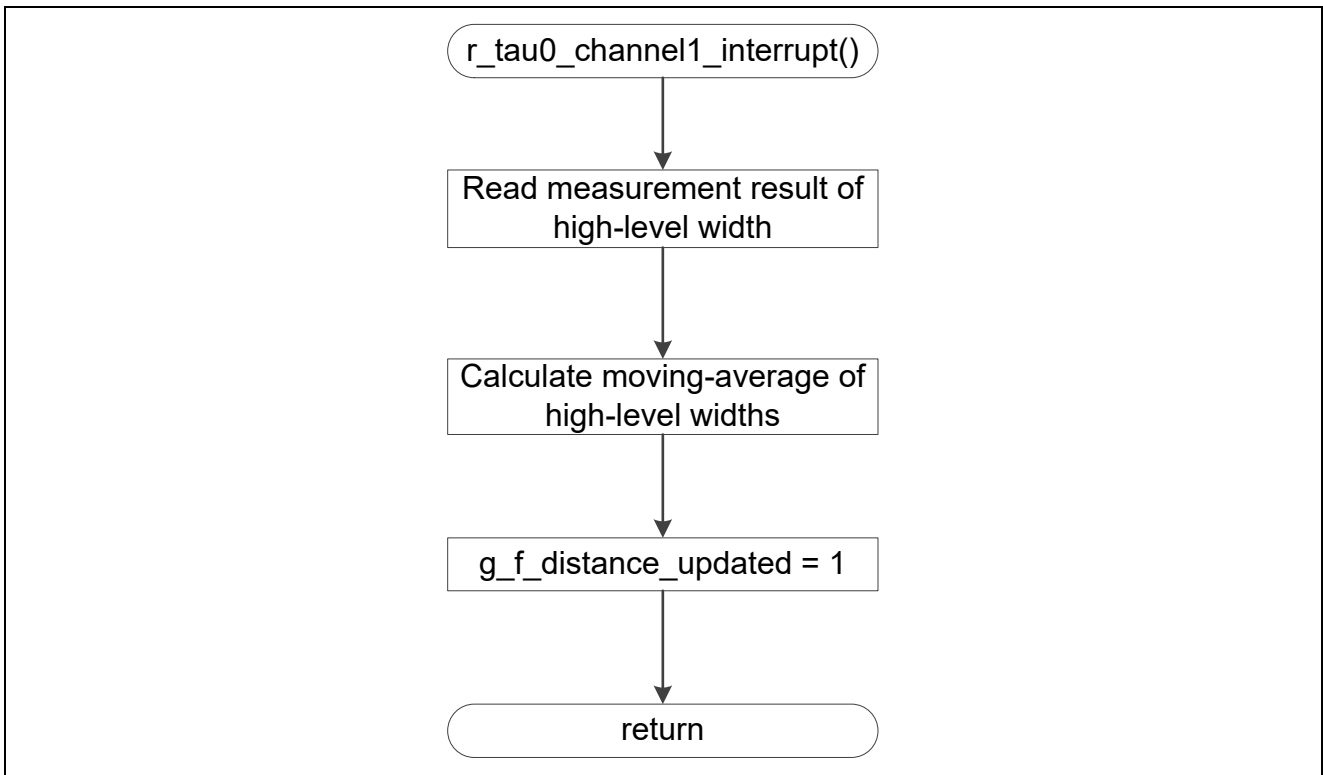

Figure 4.20 TAU01 Interrupt Function

5. Sample Code

Sample code can be downloaded from the Renesas Electronics website.

Website and Support

Renesas Electronics Website

<http://www.renesas.com/>

Inquiries

<http://www.renesas.com/contact/>

All trademarks and registered trademarks are the property of their respective owners.

Revision History

Rev.	Date	Description	
		Page	Summary
1.00	Feb. 21, 2019	-	First edition

General Precautions in the Handling of Microprocessing Unit and Microcontroller Unit Products

The following usage notes are applicable to all Microprocessing unit and Microcontroller unit products from Renesas. For detailed usage notes on the products covered by this document, refer to the relevant sections of the document as well as any technical updates that have been issued for the products.

1. Precaution against Electrostatic Discharge (ESD)

A strong electrical field, when exposed to a CMOS device, can cause destruction of the gate oxide and ultimately degrade the device operation. Steps must be taken to stop the generation of static electricity as much as possible, and quickly dissipate it when it occurs. Environmental control must be adequate. When it is dry, a humidifier should be used. This is recommended to avoid using insulators that can easily build up static electricity.

Semiconductor devices must be stored and transported in an anti-static container, static shielding bag or conductive material. All test and measurement tools including work benches and floors must be grounded. The operator must also be grounded using a wrist strap. Semiconductor devices must not be touched with bare hands. Similar precautions must be taken for printed circuit boards with mounted semiconductor devices.

2. Processing at power-on

The state of the product is undefined at the time when power is supplied. The states of internal circuits in the LSI are indeterminate and the states of register settings and pins are undefined at the time when power is supplied. In a finished product where the reset signal is applied to the external reset pin, the states of pins are not guaranteed from the time when power is supplied until the reset process is completed. In a similar way, the states of pins in a product that is reset by an on-chip power-on reset function are not guaranteed from the time when power is supplied until the power reaches the level at which resetting is specified.

3. Input of signal during power-off state

Do not input signals or an I/O pull-up power supply while the device is powered off. The current injection that results from input of such a signal or I/O pull-up power supply may cause malfunction and the abnormal current that passes in the device at this time may cause degradation of internal elements. Follow the guideline for input signal during power-off state as described in your product documentation.

4. Handling of unused pins

Handle unused pins in accordance with the directions given under handling of unused pins in the manual. The input pins of CMOS products are generally in the high-impedance state. In operation with an unused pin in the open-circuit state, extra electromagnetic noise is induced in the vicinity of the LSI, an associated shoot-through current flows internally, and malfunctions occur due to the false recognition of the pin state as an input signal become possible.

5. Clock signals

After applying a reset, only release the reset line after the operating clock signal becomes stable. When switching the clock signal during program execution, wait until the target clock signal is stabilized. When the clock signal is generated with an external resonator or from an external oscillator during a reset, ensure that the reset line is only released after full stabilization of the clock signal. Additionally, when switching to a clock signal produced with an external resonator or by an external oscillator while program execution is in progress, wait until the target clock signal is stable.

6. Voltage application waveform at input pin

Waveform distortion due to input noise or a reflected wave may cause malfunction. If the input of the CMOS device stays in the area between V_{IL} (Max.) and V_{IH} (Min.) due to noise, for example, the device may malfunction. Take care to prevent chattering noise from entering the device when the input level is fixed, and also in the transition period when the input level passes through the area between V_{IL} (Max.) and V_{IH} (Min.).

7. Prohibition of access to reserved addresses

Access to reserved addresses is prohibited. The reserved addresses are provided for possible future expansion of functions. Do not access these addresses as the correct operation of the LSI is not guaranteed.

8. Differences between products

Before changing from one product to another, for example to a product with a different part number, confirm that the change will not lead to problems. The characteristics of a microprocessing unit or microcontroller unit products in the same group but having a different part number might differ in terms of internal memory capacity, layout pattern, and other factors, which can affect the ranges of electrical characteristics, such as characteristic values, operating margins, immunity to noise, and amount of radiated noise. When changing to a product with a different part number, implement a system-evaluation test for the given product.

Notice

1. Descriptions of circuits, software and other related information in this document are provided only to illustrate the operation of semiconductor products and application examples. You are fully responsible for the incorporation or any other use of the circuits, software, and information in the design of your product or system. Renesas Electronics disclaims any and all liability for any losses and damages incurred by you or third parties arising from the use of these circuits, software, or information.
 2. Renesas Electronics hereby expressly disclaims any warranties against and liability for infringement or any other claims involving patents, copyrights, or other intellectual property rights of third parties, by or arising from the use of Renesas Electronics products or technical information described in this document, including but not limited to, the product data, drawings, charts, programs, algorithms, and application examples.
 3. No license, express, implied or otherwise, is granted hereby under any patents, copyrights or other intellectual property rights of Renesas Electronics or others.
 4. You shall not alter, modify, copy, or reverse engineer any Renesas Electronics product, whether in whole or in part. Renesas Electronics disclaims any and all liability for any losses or damages incurred by you or third parties arising from such alteration, modification, copying or reverse engineering.
 5. Renesas Electronics products are classified according to the following two quality grades: "Standard" and "High Quality". The intended applications for each Renesas Electronics product depends on the product's quality grade, as indicated below.
 - "Standard": Computers; office equipment; communications equipment; test and measurement equipment; audio and visual equipment; home electronic appliances; machine tools; personal electronic equipment; industrial robots; etc.
 - "High Quality": Transportation equipment (automobiles, trains, ships, etc.); traffic control (traffic lights); large-scale communication equipment; key financial terminal systems; safety control equipment; etc.
- Unless expressly designated as a high reliability product or a product for harsh environments in a Renesas Electronics data sheet or other Renesas Electronics document, Renesas Electronics products are not intended or authorized for use in products or systems that may pose a direct threat to human life or bodily injury (artificial life support devices or systems; surgical implantations; etc.), or may cause serious property damage (space system; undersea repeaters; nuclear power control systems; aircraft control systems; key plant systems; military equipment; etc.). Renesas Electronics disclaims any and all liability for any damages or losses incurred by you or any third parties arising from the use of any Renesas Electronics product that is inconsistent with any Renesas Electronics data sheet, user's manual or other Renesas Electronics document.
6. When using Renesas Electronics products, refer to the latest product information (data sheets, user's manuals, application notes, "General Notes for Handling and Using Semiconductor Devices" in the reliability handbook, etc.), and ensure that usage conditions are within the ranges specified by Renesas Electronics with respect to maximum ratings, operating power supply voltage range, heat dissipation characteristics, installation, etc. Renesas Electronics disclaims any and all liability for any malfunctions, failure or accident arising out of the use of Renesas Electronics products outside of such specified ranges.
 7. Although Renesas Electronics endeavors to improve the quality and reliability of Renesas Electronics products, semiconductor products have specific characteristics, such as the occurrence of failure at a certain rate and malfunctions under certain use conditions. Unless designated as a high reliability product or a product for harsh environments in a Renesas Electronics data sheet or other Renesas Electronics document, Renesas Electronics products are not subject to radiation resistance design. You are responsible for implementing safety measures to guard against the possibility of bodily injury, injury or damage caused by fire, and/or danger to the public in the event of a failure or malfunction of Renesas Electronics products, such as safety design for hardware and software, including but not limited to redundancy, fire control and malfunction prevention, appropriate treatment for aging degradation or any other appropriate measures. Because the evaluation of microcomputer software alone is very difficult and impractical, you are responsible for evaluating the safety of the final products or systems manufactured by you.
 8. Please contact a Renesas Electronics sales office for details as to environmental matters such as the environmental compatibility of each Renesas Electronics product. You are responsible for carefully and sufficiently investigating applicable laws and regulations that regulate the inclusion or use of controlled substances, including without limitation, the EU RoHS Directive, and using Renesas Electronics products in compliance with all these applicable laws and regulations. Renesas Electronics disclaims any and all liability for damages or losses occurring as a result of your noncompliance with applicable laws and regulations.
 9. Renesas Electronics products and technologies shall not be used for or incorporated into any products or systems whose manufacture, use, or sale is prohibited under any applicable domestic or foreign laws or regulations. You shall comply with any applicable export control laws and regulations promulgated and administered by the governments of any countries asserting jurisdiction over the parties or transactions.
 10. It is the responsibility of the buyer or distributor of Renesas Electronics products, or any other party who distributes, disposes of, or otherwise sells or transfers the product to a third party, to notify such third party in advance of the contents and conditions set forth in this document.
 11. This document shall not be reprinted, reproduced or duplicated in any form, in whole or in part, without prior written consent of Renesas Electronics.
 12. Please contact a Renesas Electronics sales office if you have any questions regarding the information contained in this document or Renesas Electronics products.

(Note1) "Renesas Electronics" as used in this document means Renesas Electronics Corporation and also includes its directly or indirectly controlled subsidiaries.

(Note2) "Renesas Electronics product(s)" means any product developed or manufactured by or for Renesas Electronics.

(Rev.4.0-1 November 2017)

Corporate Headquarters

TOYOSU FORESIA, 3-2-24 Toyosu,
Koto-ku, Tokyo 135-0061, Japan
www.renesas.com

Trademarks

Renesas and the Renesas logo are trademarks of Renesas Electronics Corporation. All trademarks and registered trademarks are the property of their respective owners.

Contact information

For further information on a product, technology, the most up-to-date version of a document, or your nearest sales office, please visit:
www.renesas.com/contact/