

## RL78/G1M

### 120-degree conducting control of permanent magnetic synchronous motor (Implementation)

---

#### Summary

This application note explains the sample programs driving a permanent magnet synchronous motor in the 120-degree conducting method using the RL78/G1M microcontroller. This note also explains how to use the motor control development support tool, 'Renesas Motor Workbench (RMW)'.

These sample programs are only able to be used as references, and Renesas Electronics Corporation does not guarantee their operation. Please use them after carrying out a thorough evaluation in a suitable environment.

#### Operation checking device

Operations of the sample programs have been checked using the following device.  
RL78/G1M (R5F11W68ASM)

#### Target sample programs

This application note regards the following sample programs.

- RL78G1M\_MRSSK\_120\_CSP\_CC\_V100 (IDE: CS+ for CC)
- RL78G1M\_MRSSK\_120\_E2S\_CC\_V100 (IDE: e2studio)

For the 24 V Motor Control Evaluation System & RL78/G1M CPU card:

RL78/G1M 120-degree conducting control sample program

The Hall effect sensor and sensorless mode can be changed by rewriting "MTRCONF\_SENSOR\_MODE" in the configuration definition file "r\_mtr\_config.h" to 0: HALL and 1: LESS, and compiling.

#### Reference

- RL78/G1M User's Manual: Hardware (R01UH0904EJ0100)
- Application note: '120-degree conducting control of permanent magnet synchronous motor: algorithm' (R01AN2657EJ0120)
- Renesas Motor Workbench V.2.00 User's Manual (R21UZ0004EJ0202: Renesas-Motor-Workbench-V2-0d)
- Renesas Solution Starter Kit 24V Motor Control Evaluation System for RX23T User's Manual (R20UT3697EJ0120)

## Contents

1. Overview .....	3
2. System overview .....	4
3. Descriptions of the control program .....	10
4. Usage of Motor Control Development Support Tool, 'Renesas Motor Workbench' .....	45

## 1. Overview

This application note explains how to implement the 120-degree conducting control sample programs of the permanent magnet synchronous motor (PMSM) using the RL78/G1M microcontroller, and how to use the motor control development support tool, "Renesas Motor Workbench". Note that these sample programs use the algorithm described in the application note "120degree conducting control of permanent magnet synchronous motor: algorithm".

### 1.1 Development environment

Table 1-1 and Table 1-2 show the development environment of the sample programs explained in this application note.

**Table 1-1 – Development Environment of the Sample Programs (H/W)**

Microcontroller	Evaluation board	Motor
RL78/G1M (R5F11W68ASM)	24V inverter board <sup>1</sup> & RL78/G1M CPU card <sup>2</sup>	TSUKASA <sup>2</sup> TG-55L

**Table 1-2 – Development Environment of the Sample Programs (S/W)**

CS+ version	Build tool version
V8.03.00	CC-RL V1.09.00

e <sup>2</sup> studio version	Build tool version
2020-07	CC-RL V1.09.00

For purchase and technical support, please contact sales representatives and dealers of Renesas Electronics Corporation.

#### Notes:

1. 24V inverter board (RTK0EM0001B00012BJ) is a product of Renesas Electronics Corporation.
2. The following RL78/G1M CPU cards can be used.  
T5108: Desk Top Laboratories Inc. (<http://desktoplab.co.jp/>)
3. TG-55L is a product of TSUKASA ELECTRIC.  
TSUKASA ELECTRIC. (<https://www.tsukasa-d.co.jp/en/>)

## 2. System overview

An overview of this system is provided below.

### 2.1 Hardware configuration

The hardware configuration is shown below.

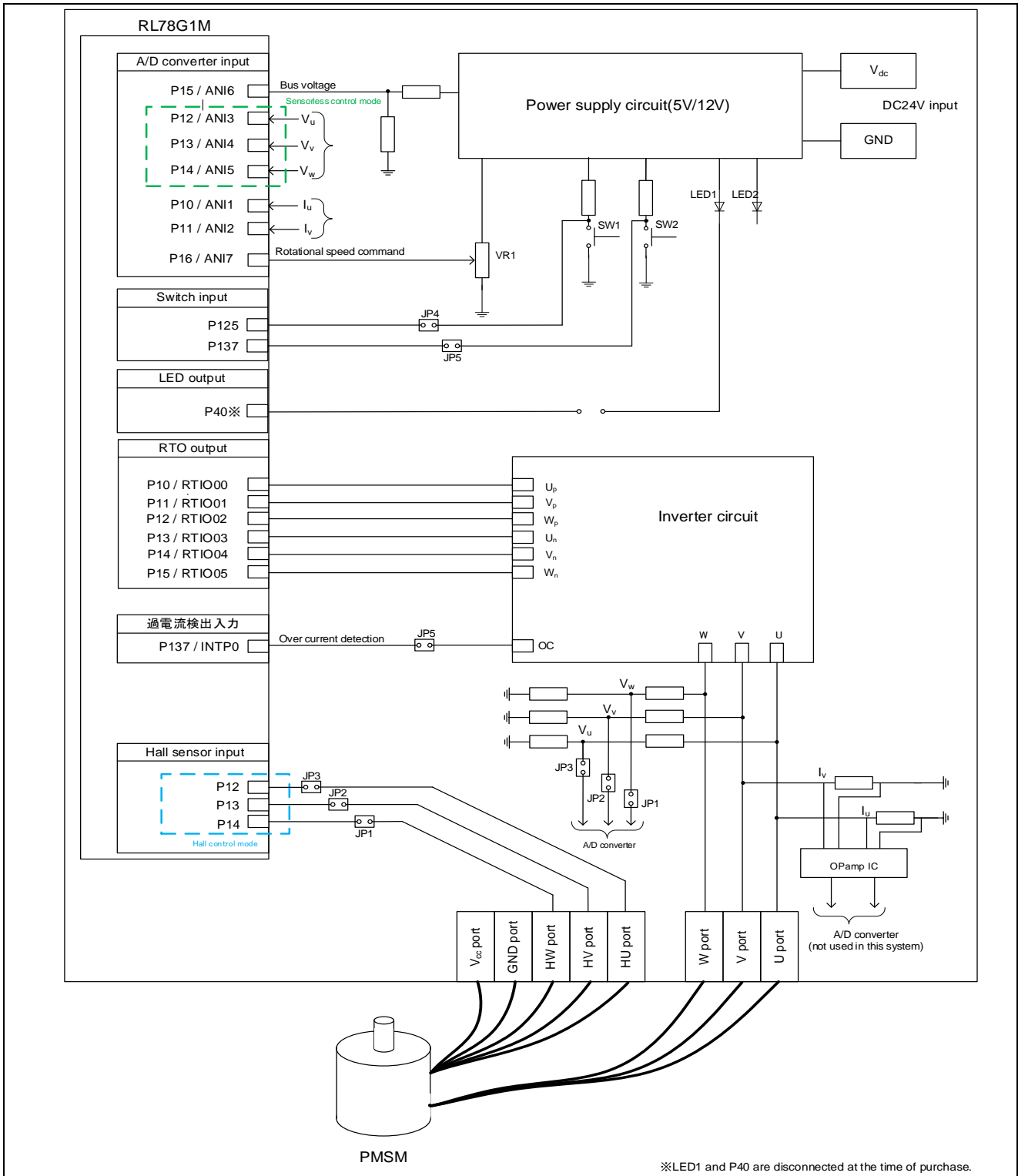

Figure 2-1 – Hardware Configuration Diagram

## 2.2 Hardware specifications

### 2.2.1 User interface

Table 2-1 is a list of user interfaces of this system.

**Table 2-1 – User Interface**

Item	Interface component	Function
VR1	Variable resistor	Rotational speed command value input (analog values)
SW1	Toggle switch	Command of recovery from error status
SW2	Toggle switch	(Not used in this system)
LED1	Yellow green LED	(Not used in this system)
LED2	Yellow green LED	(Not used in this system)
LED3	Yellow green LED	(Not used in this system)
RESET	Push switches	(Not used in this system)

The system's RL78/G1M microcontroller port interfaces are listed in Table 2-2.

**Table 2-2 – Port Interface**

R5F11W68ASM Port Names	Function
P15 / ANI6	Inverter bus voltage measurement
P16 / ANI7	Rotational speed command values input (analog values)
P125	ERROR RESET toggle switch <sup>3</sup>
P137	Toggle switch (not used in this system) <sup>4</sup>
P40	LED1 on/off control (not used in this system)
P12 / ANI3	U phase voltage measurement (A/D) <sup>2</sup>
P13 / ANI4	V phase voltage measurement (A/D) <sup>2</sup>
P14 / ANI5	W phase voltage measurement (A/D) <sup>2</sup>
P12	Hall effect sensor input <sup>1,2</sup> (HU)
P13	Hall effect sensor input <sup>1,2</sup> (HV)
P14	Hall effect sensor input <sup>1,2</sup> (HW)
P00 / RTIO00	PORT output / PWM output ( $U_p$ )
P01 / RTIO01	PORT output / PWM output ( $V_p$ )
P02 / RTIO02	PORT output / PWM output ( $W_p$ )
P03 / RTIO03	PORT output / PWM output ( $U_n$ )
P04 / RTIO04	PORT output / PWM output ( $V_n$ )
P05 / RTIO05	PORT output / PWM output ( $W_n$ )
P125 / RESET	System reset (not used in this system) <sup>3</sup>
P137 / INTPO	PWM emergency stop input at the time of overcurrent detection <sup>4</sup>

1: When Hall effect sensors on the motor included in the 24V inverter kit are used, equip the ferrite core included in this kit with cables for 3 Hall effect sensors to avoid sensor noise.

2: Short 2-3 of JP1-3 in Hall effect sensor control mode, or 1-2 in senseless control mode.

3: In this system, because P125 is used to detect the status of SW1, short 2-3 of JP4. (However, when writing a program to the microcontroller, by using the E1emulator, short 1-2.)

4: In this system, P137 is used for overcurrent detection, so short 1-2 of JP5.

## 2.2.2 Peripheral functions

Table 2-3 is a list of peripheral functions used in this system.

**Table 2-3 – List of Peripheral Functions**

Peripheral Function	Usage
10-bit A/D converter	<ul style="list-style-type: none"> <li>Rotational speed command value input (Board UI mode)</li> <li>Inverter bus voltage measurement</li> <li>Voltage of each phase U, V, and W measurement</li> </ul>
Timer Array Unit (TAU)	<ul style="list-style-type: none"> <li>PWM output</li> <li>Free-running timer for rotational speed measurement</li> <li>Delay timer for changing conducting pattern (sensorless control mode)</li> </ul>
12-bit Interval timer (IT)	1 [ms] interval timer
Real-time output control circuit	Output waveform and output port control
External interrupt (INTP0)	Overcurrent detection

(1) 10-bit A/D converter

The rotational speed command value input, U phase voltage ( $V_u$ ), V phase voltage ( $V_v$ ), W phase voltage ( $V_w$ ), and inverter bus voltage ( $V_{dc}$ ) are measured by using the “10-bit A/D converter”.

(2) Timer Array Unit (TAU)

a. PWM output

Used to output non-complementary PWM.

b. Free-running timer for rotational speed measurement

This channel 1 of TAU is used as a free-running counter for rotational speed calculation.

c. Delay timer for changing conducting pattern

The channel 3 of TAU is used as delay timer for changing conducting pattern with  $\pi/6$  phase from the zero-crossing point.

(3) 12-bit Interval timer (IT)

Used as a 1 millisecond interval timer.

(4) Real-time output control circuit (RTO)

Sets the  $U_p$  to  $W_n$  PWM, high level and low output.

In addition, by using the forced cutoff function, all output terminals are set to low level output when overcurrent is detected.

(5) External interrupt (INTP0)

An overcurrent is detected by an external circuit.

## 2.3 Software structure

### 2.3.1 Software file structure

The folder and file configurations of the sample programs Table 2-4 are given below.

**Table 2-4 – Folder and File Configuration of the Sample Program**

Folder		file	content
config		r_mtr_config.h	Common definition for software configuration
		r_mtr_motor_parameter.h	Configuration definition for motor parameters
		r_mtr_control_parameter.h	Configuration definition for control parameters
		r_mtr_inverter_parameter.h	Configuration definition for inverter parameters
application	main	main.h main.c	Main function
	board	r_mtr_board.h r_mtr_board.c	Function definition for board UI
	ics	r_mtr_ics.h r_mtr_ics.c	Function definition for Analyzer <sup>(Note1)</sup> UI
		ICS_define.h	CPU definition for RMW
		RL78G1M_vector.c	Interrupt vector function definition for RMW
		ics2_RL78G1M.h	Function declaration for RMW
		ICS2_RL78G1M.lib	Communication library for RMW
	driver	auto_generation	cstart.asm hdwinit.asm iodefine.h
		mtr_ctrl_mrssh.h, mtr_ctrl_mrssh.c	Function definition for inverter board control
		r_mtr_ctrl_rl78g1m.h, r_mtr_ctrl_rl78g1m.c	Function definition for MCU control
middle		r_mtr_fixed.h	Fixed point definition
		r_mtr_common.h	Common definition
		r_mtr_parameter.h	Various parameter definition
		r_mtr_driver_access.h, r_mtr_driver_access.c	Function definition for User access
		r_mtr_statemachine.h, r_mtr_statemachine.c	Function definition for state transition
		r_mtr_120.h r_mtr_120.c	Function definition for 120-degree conducting control
		r_mtr_interrupt.c	Interrupt function definition

Note 1: Regarding the specification of the Analyzer function in the motor control development support tool “Renesas Motor Workbench (RMW)”, please refer to Chapter 4.

The identifier ‘ics/ICS (ICS is the previous motor control development support tool, ‘In Circuit Scope’) is attached to the name of folders, files, functions, and variables related to ‘Renesas Motor Workbench’.

### 2.3.2 Module configuration

Figure 2-2 shows module configuration of the sample programs.

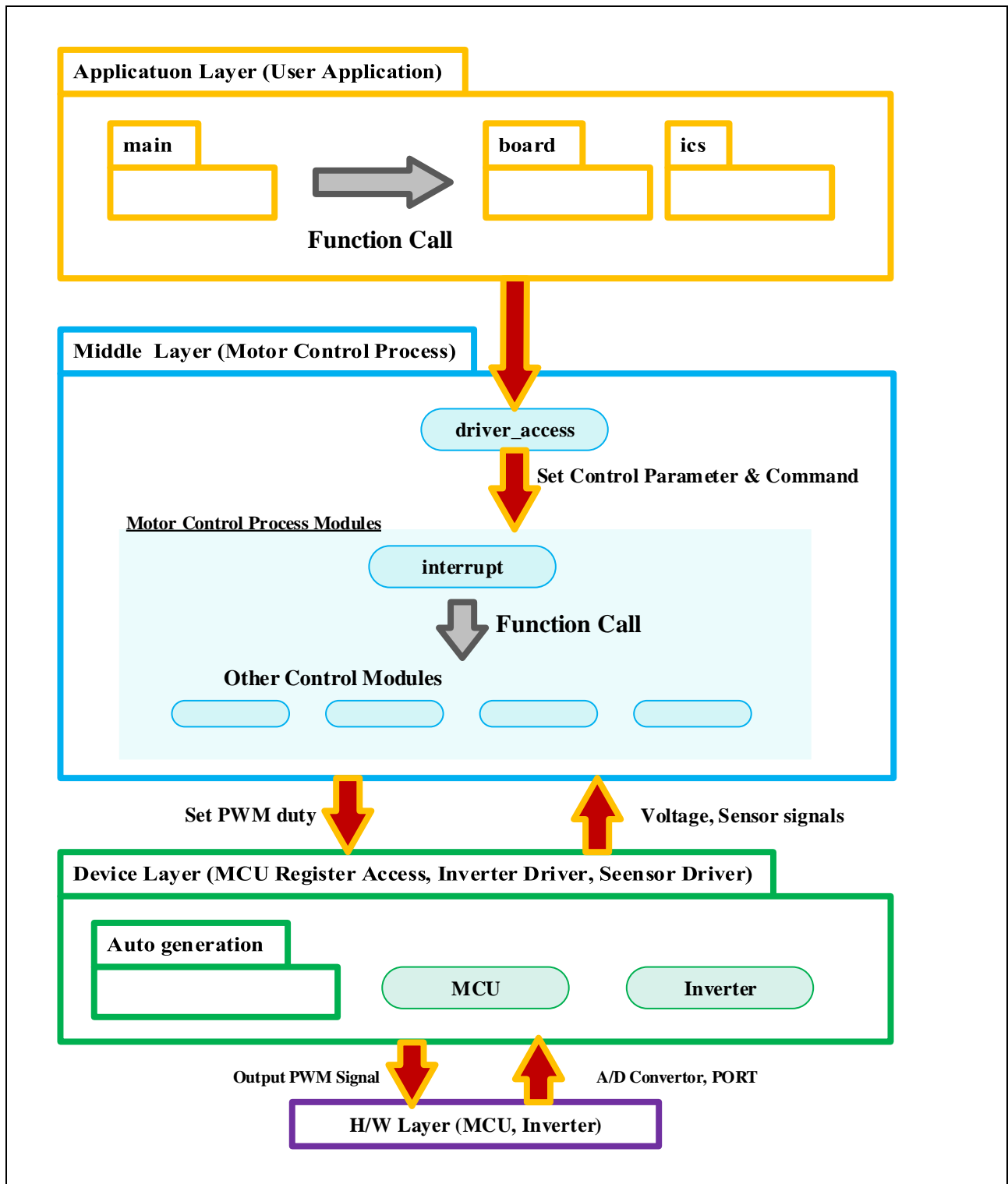

Figure 2-2 – Module Configuration of the Sample Programs



## 2.4 Software specifications

Table 2-5 shows the basic specifications of target software of this application note. For details on 120-degree conducting control, refer to the application note “120-degree conducting control of permanent magnet synchronous motor: algorithm”.

**Table 2-5 – Basic Specifications of Software**

Item	Content
Control method	120-degree conducting method (chopping upper arm)
Motor rotation start/stop	Determined based on the input value of VR1 (P16) (minimum speed or more: rotation starts, less than minimum speed: stop) or input from Renesas Motor Workbench
Position detection of rotor magnetic pole	Hall effect sensor: Position detection based on signal from Hall effect sensors (every 60 degrees) Sensorless: Position detection based on induced voltage measured by A/D converters (every 60 degrees) · When position of rotor is detected, PWM duty and conducting pattern are set.
Input voltage	DC24[V]
Main clock frequency	CPU clock: $f_{CLK}$ 20 [MHz]
Carrier frequency (PWM)	20 [kHz]
Control cycle	Speed PI control: every 1 [ms]
Rotational speed control range	Hall effect sensor control mode: 530 [rpm] to 3200 [rpm] <sup>(Note1)</sup> Sensorless control mode: 265 [rpm] to 3200 [rpm] <sup>(Note1)</sup> Both CW and CCW are supported
Optimization	Perform the default optimization (None)
Processing stop for protection	· Disables the motor control signal output (six outputs), under any of the following conditions. 1. Inverter bus voltage exceeds 28 V (monitored per 1 [ms]) 2. Inverter bus voltage is less than 15 V (monitored per 1 [ms]) 3. Rotational speed exceeds 3900 rpm (monitored per 1 [ms]) 4. Hall pattern change or zero-crossing are not detected for 200 [ms]. 5. Detection of unexpected output voltage pattern 6. Detection of overcurrent by external circuit (low level input in INTPO port)

Note1 : Please refrain from driving motor over rated speed for a long period.

## 2.5 User option bytes

The settings of the user option byte area of the RL78/G1M flash memory are shown below.

**Table 2-6 – User option byte settings**

Setting	Address	value	Description
F2E3F9	000C0H	11110010B	Enable watchdog timer counter operation (Starts counting after reset is released) Overflow time: 7.36 [ms]
	000C1H	11100011B	· P125/KR1/RESET pin: Port function · Selectable power-on reset detection voltage Rising edge: 4.28 [V] Falling edge: 4.20 [V]
	000C2H	11111001B	CPU clock $f_{CLK}$ : 20 [MHz]

### 3. Descriptions of the control program

The target sample programs of this application note are explained here.

#### 3.1 Contents of control

##### 3.1.1 Motor start/stop

Starting and stopping of the motor are controlled by input from Renesas Motor Workbench or VR1. In addition, an analog input port is assigned to VR1. The input is A/D converted within the main loop to generate a rotational speed command value. When the rotation command value exceeds the minimum speed (Hall control mode: 530 [rpm], sensorless control mode: 265 [rpm]), the rotation starts, and when it is less than the minimum speed, the rotation stops.

##### 3.1.2 A/D Converter

###### (1) Motor rotational speed command value

The motor rotational speed command value can be set by Renesas Motor Workbench input or A/D conversion of the VR1 output value (analog value). The A/D converted VR1 value is used as rotational speed command value, as shown below. Maximum value of conversion ratio is set to achieve maximum speed by VR1 input. Only higher 8bits are used for calculation of rotational speed command value.

**Table 3-1 – Conversion Ratio of the Rotation Speed Command Value**

Item	Conversion ratio (Command value: A/D conversion value)		Channel
Rotational speed command value	CW	0 [rpm] to 3200 [rpm] : 01FFH to 03FFH	ANI7
	CCW	-3200 [rpm] to 0 [rpm] : 0000H to 01FFH	

###### (2) Inverter bus voltage

Inverter bus voltage is measured as given in Table 3-2. It is used for modulation factor calculation and over/low voltage detection. (When an abnormality is detected, PWM is stopped). Only higher 8bits are used for calculation of bus voltage.

**Table 3-2 – Inverter Bus Voltage Conversion Ratio**

Item	Conversion ratio (Inverter bus voltage: A/D conversion value)	Channel
Inverter bus voltage	0 [V] to 111 [V] : 0000H to 03FFH	ANI6

###### (3) U phase, V phase, and W phase voltage

The U, V and W phase voltages are measured as shown in Table 3-3 and are used for determining zero-crossing of induced voltage.

**Table 3-3 – Conversion Ratio of U, V, and W Phase Voltage**

Item	Conversion ratio (U, V, and W phase voltage: A/D conversion value)	Channel
U, V, W phase voltages	0 [V] to 111 [V] : 0000H to 03FFH	ANI12, ANI13, ANI14

**Note:** For more details on A/D conversion, refer to RL78/G1M User's Manual: Hardware.

### 3.1.3 Speed control

In this system, rotational speed is calculated from the difference between the current timer value and the previous timer value  $2\pi$  [rad]. The timer values are obtained when patterns are switched after Hall effect sensor pattern change at Hall effect sensor control mode or zero-crossing of induced voltage at sensorless control mode, while having the timer of performed free running.

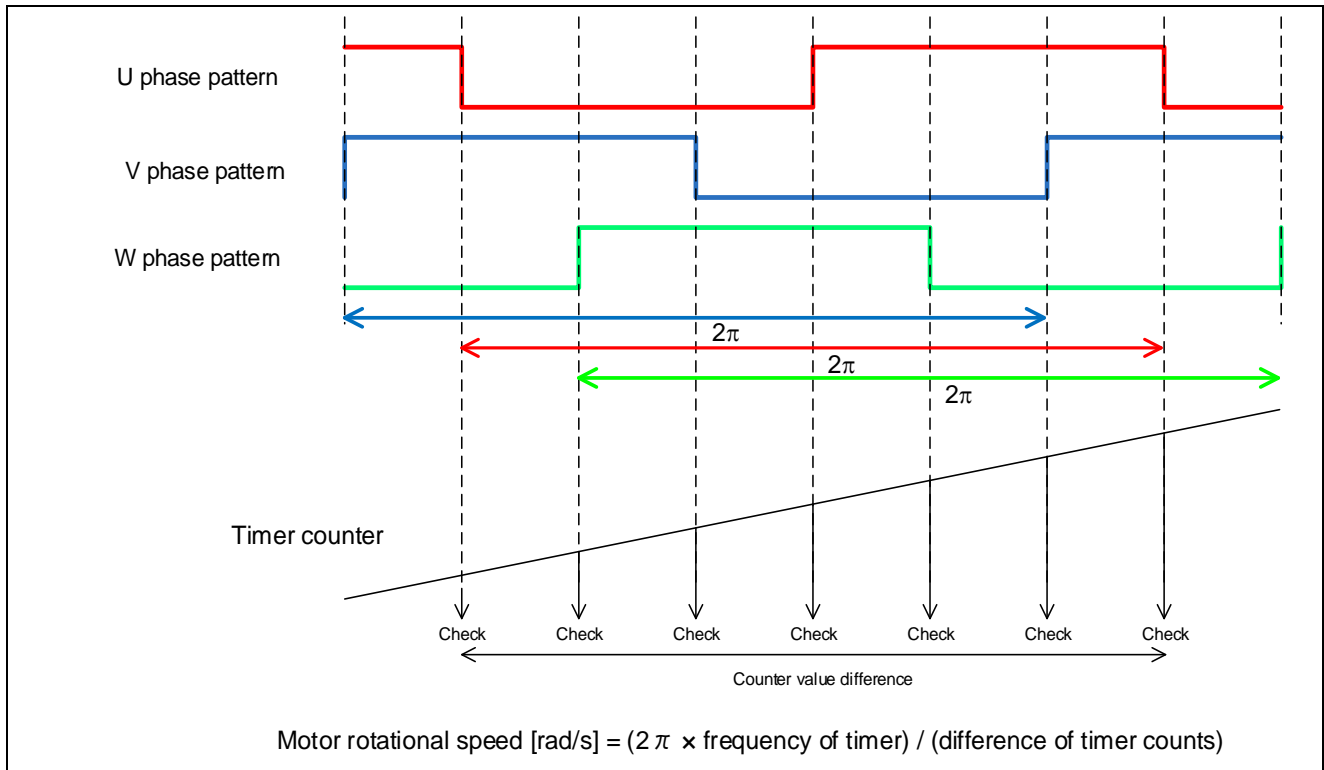

Figure 3-1 – Method of Calculation for Rotational Speed

The target sample software of this application note uses PI control for speed control. A voltage command value is calculated by the following formula of speed PI control.

$$v^* = (K_{P\omega} + \frac{K_{I\omega}}{s})(\omega^* - \omega)$$

$v^*$  : Voltage command value       $\omega^*$  : Speed command value       $\omega$  : Rotation speed  
 $K_{P\omega}$  : Speed PI proportional gain       $K_{I\omega}$  : Speed PI integral gain       $s$  : Laplace operator

For more details on PI control, please refer to specialized books.

### 3.1.4 Voltage control by PWM

PWM control is used for controlling output voltage. The PWM control is a control method that continuously adjusts the average voltage by varying the duty of pulse, as shown in Figure 3-2.

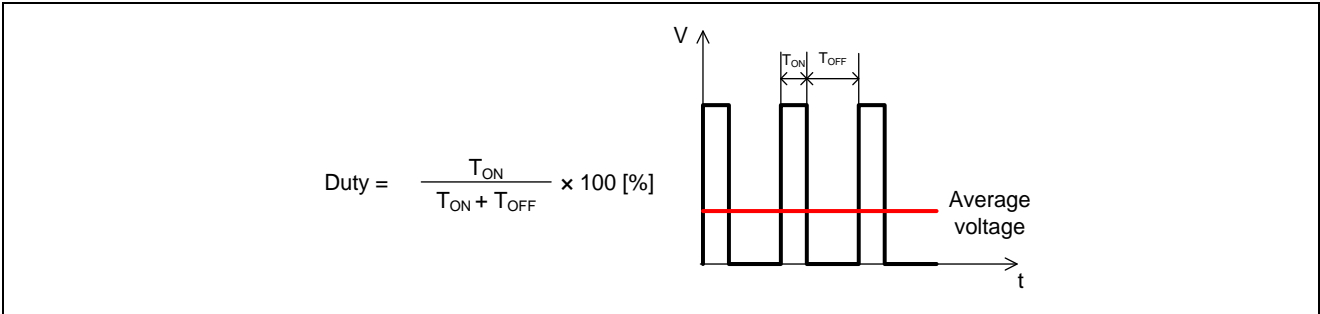

Figure 3-2 – PWM Control

Here, modulation factor “m” is defined as follows.

$$m = \frac{V}{E}$$

*m*: Modulation factor      *V*: Command value voltage      *E*: Inverter bus voltage

This modulation factor is set to registers for PWM duty in TAU.

In the target software of this application note, non-complementary upper arm chopping is used to control the output voltage and speed. Figure 3-3 shows an example of output waveforms when upper arm chopping is used.

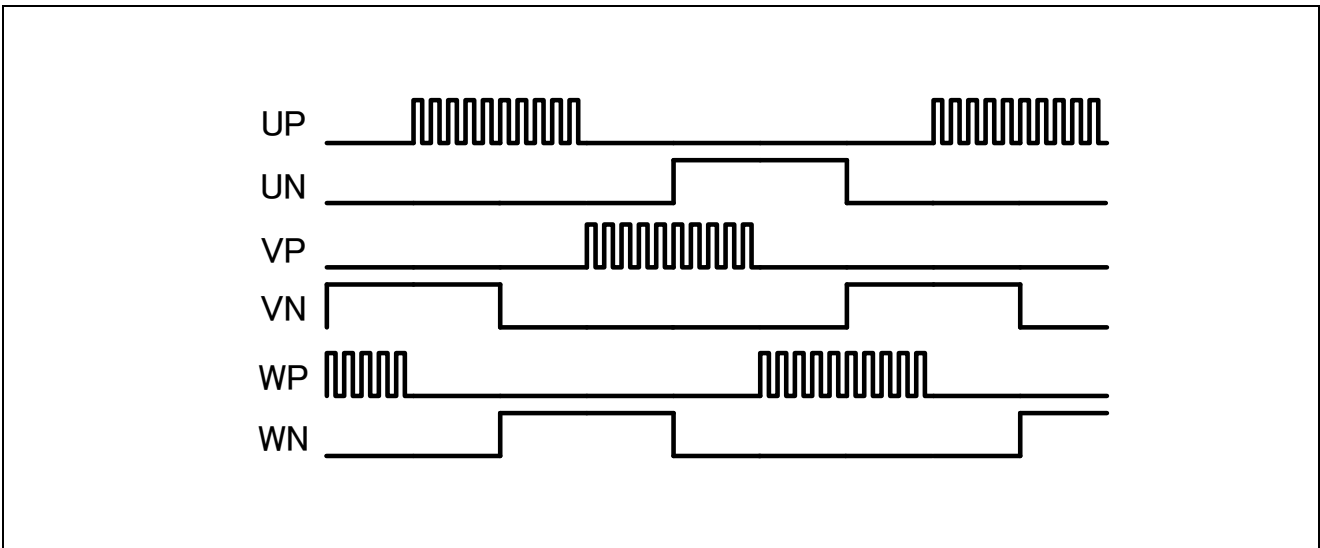

Figure 3-3 – Non-Complementary Upper Arm Chopping

### 3.1.5 State transitions

Figure 3-4 shows state transition diagrams of 120-degree conducting control software.

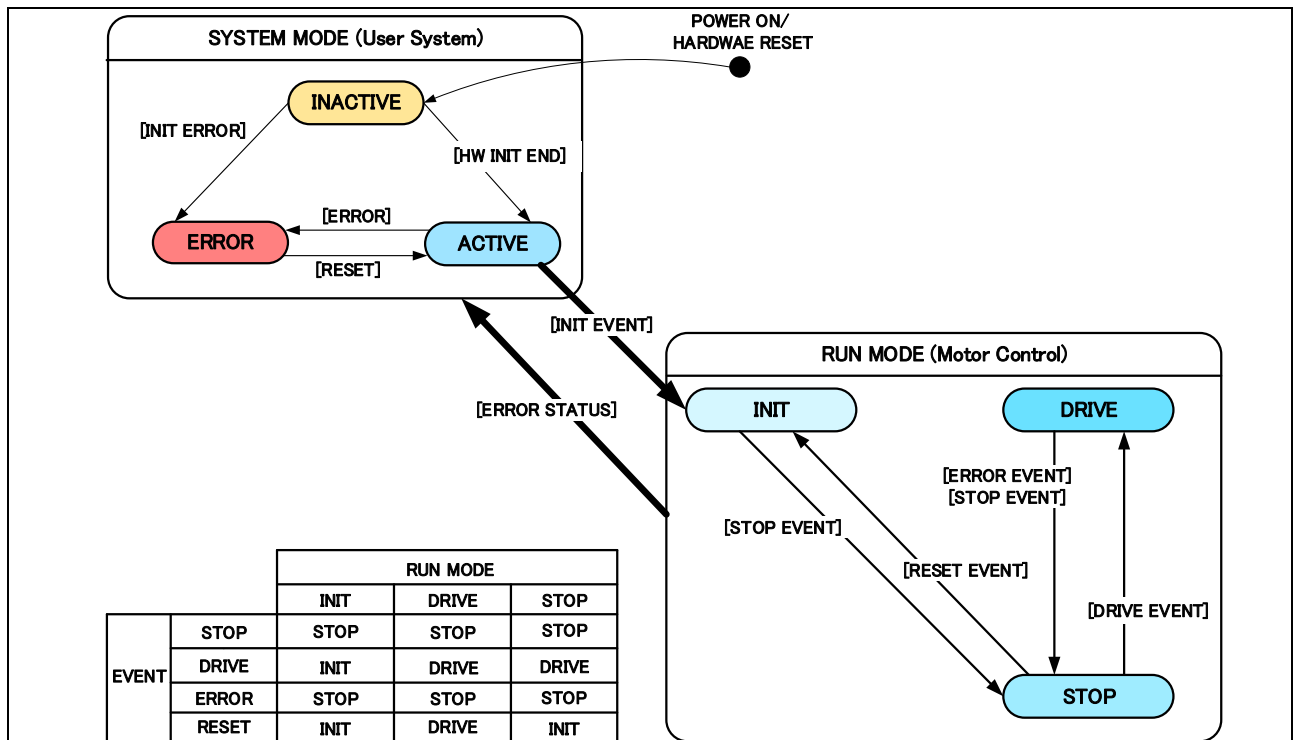

Figure 3-4 – State Transition Diagram 120-degree Conducting Control Software

(1) SYSTEM MODE

“SYSTEM MODE” indicates the operating states of the system. “SYSTEM MODE” has 3 states, which are motor drive stop (INACTIVE), motor drive (ACTIVE), and abnormal condition (ERROR).

(2) RUN MODE

“RUN MODE” indicates the condition of the motor control. The state is changed by occurrence of “EVENT”.

(3) EVENT

“Event” indicates the change of “RUN MODE”. When “EVENT” occurs, “RUN MODE” changes as shown table in Figure 3-4. Each “Event” is caused by occurrence as shown in Table 3-4.

Table 3-4 – List of “EVENT”

“EVENT” name	Occurrence factor
STOP	By user operation
DRIVE	By user operation
ERROR	When the system detects an error
RESET	By user operation

### 3.1.6 Start-up method

#### (1) Hall effect sensor control mode

In the Hall effect sensor control mode, after changing to “MTR\_MODE\_DRIVE”, the output pattern is selected from the initial Hall effect sensor signal. Then, voltage is applied and the state is changed to PI control mode. The rotational speed is calculated after the second hall effect sensor interruption.

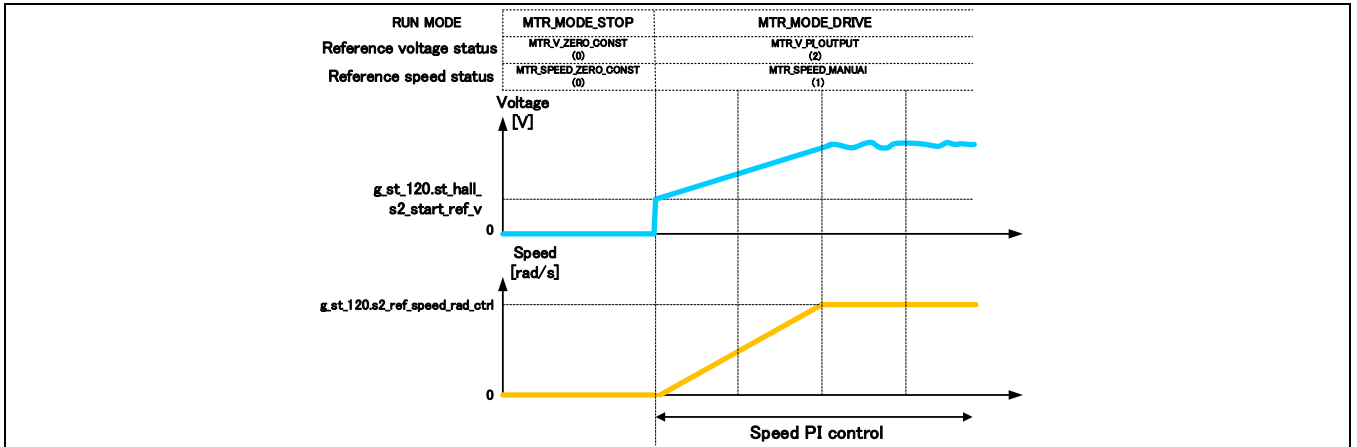

Figure 3-5 – Start-up sequence (hall effect sensor control mode)

#### (2) Sensorless control mode

In sensorless control mode, the position of the magnetic poles is estimated every 60 degrees from induced voltage that is generated from the variation of magnetic flux due to the rotation of the permanent magnet (rotor). However, since the induced voltage is generated by the rotation, at low speed it is difficult to estimate the position of the rotor.

Therefore, the method to generate a rotating magnetic field by forcibly switching conducting pattern in the synchronous speed regardless of the position of the rotor, is often used.

Figure 3-6 shows the start-up method in the sample software. In “MTR\_MODE\_DRIVE”, at first, the rotor is drawn in. Second, mode is changed to open-loop drive mode. When reference control speed reaches to change speed, mode is changed to PI control mode.

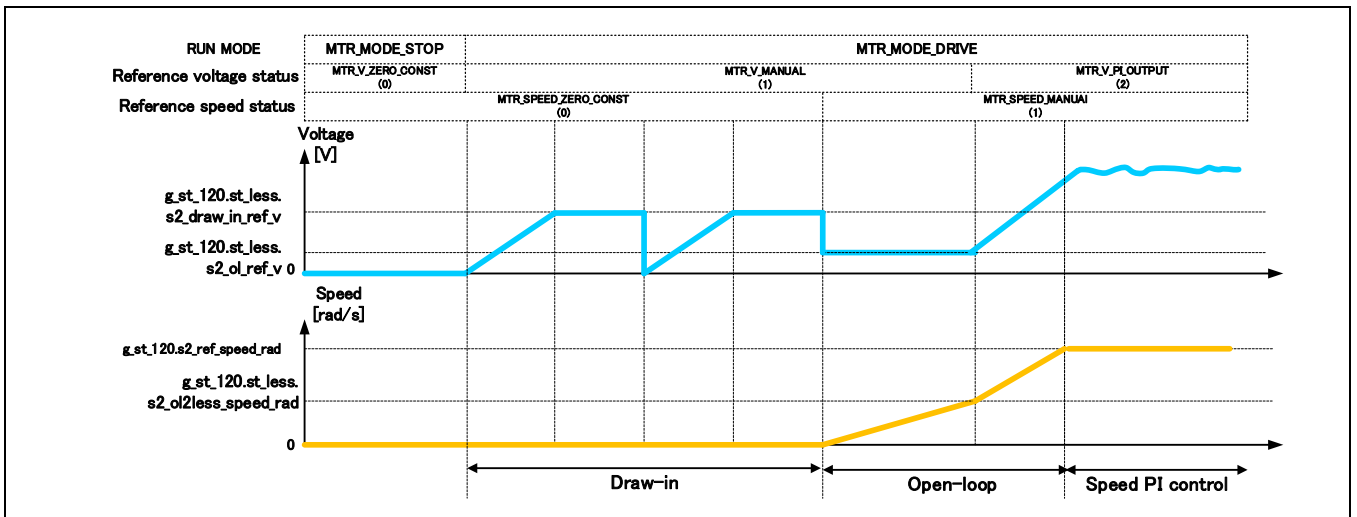

Figure 3-6 – Startup Sequence (Sensorless Control Mode)

### 3.1.7 System protection function

This system has the following types of error status and emergency stop functions in case of occurrence of respective error. Refer to Table 3-5 for settings related to the system protection function.

- Overcurrent error for hardware  
When an emergency stop signal (over current detection) from the external hardware is detected, voltage output is stopped.
- Overvoltage error  
The inverter bus voltage is monitored at the overvoltage monitoring cycle. When the inverter bus voltage exceeds the overvoltage limit, voltage output is stopped. The threshold value of the overvoltage is set in consideration of the error of resistance value of the detection circuit.
- Low voltage error  
The inverter bus voltage is monitored at the low voltage monitoring cycle. When the inverter bus voltage lowers undervoltage limit, voltage output is stopped. The threshold value of the low voltage is set in consideration of the error of resistance value of the detection circuit.
- Rotational speed error  
The rotational speed is monitored at the rotational speed monitoring cycle. When the rotational speed exceeds the over speed limit, voltage output is stopped.
- Timeout error  
The timeout counter is monitored at the timeout monitoring cycle. When pattern switching by Hall pattern change in Hall effect sensor control mode or zero-crossing of induced voltage in sensorless control mode don't happen for a timeout period, voltage output is stopped.
- Pattern error  
The output voltage pattern is monitored at the pattern monitoring cycle. When unexpected pattern is detected in voltage pattern set from Hall effect sensor in Hall effect sensor control mode or induced voltage in sensorless control mode, voltage output is stopped.

**Table 3-5 – Setting Value of Each System Protection Function**

Kinds of error	Threshold	
Over current error	Over current limit [A]	2.0
Over voltage error	Overvoltage limit [V]	28
	Monitoring cycle [ms]	1
Under voltage error	Low voltage limit [V]	15
	Monitoring cycle [ms]	1
Rotational speed error	Speed limit [rpm]	3900
	Monitoring cycle [ms]	1
Timeout error	Timeout value [ms]	200
	Monitoring cycle [ms]	1

### 3.2 Function specifications of 120-degree conducting control software

Lists of functions used in this control program are shown below. Functions not used in this system are undescribed.

**Table 3-6 – List of Functions “main.c”**

file	function	process
main.c	main argument: none return: none	Initialization and main loop <ul style="list-style-type: none"> <li>• initialization</li> <li>⇒initialization of hardware</li> <li>⇒initialization of system variables</li> <li>⇒initialization of ICS communication</li> <li>⇒initialization of control system</li> <li>⇒reset process</li> <li>⇒waiting for stability of bus voltage</li> <li>• main loop</li> <li>⇒system control depending on input from UI</li> <li>⇒clear watch dog timer</li> <li>⇒ICS communication process</li> </ul>
	ics_ui argument: none return: none	Process for ICS UI (GUI) <ul style="list-style-type: none"> <li>• input values of command variables to ICS variables</li> <li>• change motor status depending on input event</li> <li>• initialization of system variables when reset event occurs</li> </ul>
	board_ui argument: none return: none	Process of board UI (H/W) <ul style="list-style-type: none"> <li>• change motor status depending on state of switch</li> <li>• determination of command rotational speed by value of VR1</li> </ul>
	software_init argument: none return: none	Initialization of system variables <ul style="list-style-type: none"> <li>• initialization of variables for main process</li> <li>• initialization of ICS variables</li> </ul>
	mtr_ics_process [inline function] argument: none return: none	ICS communication process



**Table 3-7 – List of Functions “r\_mtr\_ics.c”**

file	function	process
r_mtr_ics.c	mtr_set_com_variables argument: none return: none	Preprocess to set control variables • input values of command variables to ICS variables • input values of ICS variables to ICS buffer variables
	mtr_ics_variables_init argument: none return: none	Initialization of command variables
	R_MTR_Limit argument: (int16_t) s2_value / target value (int16_t) s2_max / maximum limit (int16_t) s2_min / minimum limit return: (int16_t) s2_temp / limited value	Limit between maximum and minimum values

**Table 3-8 – List of Functions “r\_mtr\_board.c”**

file	function	process
r_mtr_board.c	mtr_remove_chattering argument: (uint8_t) u1_sw / switch signal (uint8_t) u1_on_off / switch status return: (uint8_t) u1_flag_chattering / flag for chattering	Remove chattering of switch signal

**Table 3-9 – List of Functions “r\_mtr\_ctrl\_mrsk.c”**

file	function	process
r_mtr_ctrl_mrsk.c	R_MTR_GetSw1 argument: none return: (uint8_t) MTR_PORT_SW1 / state of SW1	Get state of SW1

**Table 3-10 – List of Functions in “r\_mtr\_ctrl\_rl78g1m.h”**

file	function	process
r_mtr_ctrl_rl78g1m.h	mtr_input_hall(signal) argument: none return: none	Input Hall effect sensor signal
	mtr_get_tcr02(cnt) argument: none return: none	Get free run timer counts
	mtr_set_rtoutc(gate) argument: none return: none	Set voltage pattern by RTO
	mtr_set_tdr01(duty) argument: none return: none	Set PWM duty
	mtr_clear_wdt() argument: none return: none	Clear watch dog timer (WDT)
	mtr_get_adcr(v) argument: none return: none	Get A/D result
	mtr_clear_rtointpclr() argument: none return: none	Clear forced cutoff
	mtr_oc_intr_enable() argument: none return: none	Enable overcurrent interrupt
	mtr_oc_intr_disable() argument: none return: none	Disable overcurrent interrupt
	mtr_set_tdr03() argument: none return: none	[sensorless control mode] Set delay count
	mtr_start_delay_cnt() argument: none return: none	[sensorless control mode] Start delay timer
	mtr_stop_delay_cnt() argument: none return: none	[sensorless control mode] Stop delay timer
	mtr_clear_inttm03() argument: none return: none	[sensorless control mode] Disable delay interrupt

**Table 3-11 – List of Functions in “r\_mtr\_ctrl\_rl78g1m.c”**

file	function	process
r_mtr_ctrl_rl78g1m.c	R_MTR_InitHardware argument: none return: none	Initialization of peripheral functions
	mtr_init_unused_pins argument: none return: none	Initialization of unused pins
	mtr_init_ui argument: none return: none	Initialization of ports for board UI
	mtr_init_clock argument: none return: none	Initialization of clock
	mtr_init_it argument: none return: none	Initialization of 12-bit interval timer (IT)
	mtr_init_rto argument: none return: none	Initialization of real-time output control circuit (RTO)
	mtr_init_adc argument: none return: none	Initialization of A/D converter
	mtr_init_tau argument: none return: none	Initialization of timer array unit (TAU)
	mtr_init_intp argument: none return: none	Initialization of external interrupt (INTP)
	mtr_init_hall argument: none return: none	[Hall effect sensor control mode] Initialization of pins for hall effect sensor
	R_MTR_get_adc argument: (uint8_t) u1_ad_ch / channel of A/D conversion return: (int16_t) s2_ad_value / result of A/D conversion	Get the result of A/D conversion
	R_MTR_get_v_uvw_adc argument: (int16_t) *s2_v_uvw / UVW voltages return: none	[sensorless control mode] Get the results of A/D conversion of UVW voltage
	R_MTR_ctrl_stop argument: none return: none	Stop motor control • Voltage output prohibited

**Table 3-12 – List of Functions “r\_mtr\_driver\_access.c”**

file	function	process
r_mtr_driver_access.c	R_MTR_InitControl argument: none return: none	Initialization of control system • initialization of motor status • initialization of control variables
	R_MTR_IcsInput argument: (mtr_ctrl_input_t) *st_ics_input / ICS structure return: none	Input values of ICS variables to ICS buffer variables
	R_MTR_SetVariables [inline function] argument: none return: none	Input values of ICS buffer variables to control variables
	R_MTR_InputBuffParamReset argument: none return: none	Reset ICS buffer variables
	R_MTR_ExecEvent argument: (uint8_t) u1_event / event return: none	Change motor status and execute event process
	R_MTR_GetStatus argument: none return: (uint8_t) mtr_statemachine_get_status(g_st_120.st_stm) / motor status	Get motor status
	R_MTR_GetErrorStatus argument: none return: (uint16_t) g_st_120.u2_error_status / error status	Get error status
	R_MTR_Get_Dir argument: none return: (uint8_t) g_st_120.u1_dir / direction of rotation	Get direction of rotation
	R_MTR_SetSpeed argument: (int16_t) s2_ref_speed_rpm / command rotational speed return: (uint8_t) u1_stop_req / flag for requiring flag	Set command speed
	R_MTR_ChargeCapacitor argument: none return: (uint16_t) u2_charge_cap_error / timeout error	Waiting for stability of bus voltage
R_MTR_UpdatePolling argument: none return: none	Set control variables	

**Table 3-13 – List of Functions “r\_mtr\_statemachine.c”**

file	function	process
r_mtr_statemachine.c	mtr_statemachine_init argument: (st_mtr_statemachine_t) *p_state_machine / structure for motor status return: none	Initialization of motor status
	mtr_statemachine_reset argument: (st_mtr_statemachine_t) *p_state_machine / structure for motor status return: none	Reset motor status motor status
	mtr_state_machine_event argument: (st_mtr_statemachine_t) *p_state_machine / structure for motor status (void) *p_object / structure for control variables (uint8_t) u1_event / event return: none	Execute event process
	mtr_statemachine_get_status argument: (st_mtr_statemachine_t) *p_state_machine / structure for motor status return: (uint8_t) p_state_machine->u1_status / motor status	Get motor status
	mtr_act_none argument: (st_mtr_statemachine_t) *st_stm / structure for motor status (void) *p_param / structure for control variables return: none	No process is performed
	mtr_act_init argument: (st_mtr_statemachine_t) *st_stm / structure for motor status (void) *p_param / structure for control variables return: none	Initialization of control variables
	mtr_act_error argument: (st_mtr_statemachine_t) *st_stm / structure for motor status (void) *p_param / structure for control variables return: none	Stop motor control
	mtr_act_drive argument: (st_mtr_statemachine_t) *st_stm / structure for motor status (void) *p_param / structure for control variables return: none	Reset control variables
	mtr_act_stop argument: (st_mtr_statemachine_t) *st_stm / structure for motor status (void) *p_param / structure for control variables return: none	Stop motor control

**Table 3-14 – List of Functions in “r\_mtr\_120.h”**

file	function	process
r_mtr_120.h	mtr_conv_q_voltage(v) argument: none return: none	Q value conversion of voltage
	mtr_conv_kp_voltage(kp) argument: none return: none	Q value conversion of proportional gain
	mtr_conv_kidt_voltage(kidt) argument: none return: none	Q value conversion of integral gain
	mtr_conv_rpm2rad(v) argument: none return: none	Unit conversion of rotational speed from [rpm] to [rad/s]

**Table 3-15 – List of Functions in “r\_mtr\_120.c”**

file	function	process
r_mtr_120.c	mtr_120_motor_default_init argument: (st_mtr_120_control_t) *st_120 / structure for control variables return: none	Initialization of control variables
	mtr_120_motor_reset argument: (st_mtr_120_control_t) *st_120 / structure for control variables return: none	Reset control variables

**Table 3-16 – List of Functions “r\_mtr\_interrupt.c” [1/ 3]**

file	function	process
r_mtr_interrupt.c	mtr_over_current_interrupt argument: none return: none	Overcurrent detection process <ul style="list-style-type: none"> <li>• disable over current interrupt</li> <li>• execute error event</li> <li>• set error status</li> </ul>
	mtr_carrier_interrupt argument: none return: none	Carrier interrupt <b>【Hall effect sensor control mode】</b> <ul style="list-style-type: none"> <li>• obtain bus voltage</li> <li>• detect Hall pattern change</li> <li>• prepare for rotational speed calculation</li> <li>• set voltage pattern</li> </ul> [sensorless control mode] <ul style="list-style-type: none"> <li>• obtain UVW and bus voltages</li> <li>• draw-in process</li> <li>• zero-cross detection</li> <li>• prepare for rotational speed calculation</li> <li>• open-loop process</li> <li>• calculate delay counts</li> <li>• start delay timer</li> </ul>
	mtr_prepare_speed_calc [inline function] argument: none return: none	Prepare for Calculation of rotational speed
	mtr_set_chopping_pattern [inline function] argument: (uint8_t) u1_pattern / conducting pattern return: none	Set chopping pattern
	mtr_set_speed_ref [inline function] argument: none return: none	Set reference speed
	mtr_set_voltage_ref [inline function] argument: none return: none	Set reference voltage
	mtr_pi_ctrl [inline function] argument: (st_mtr_pi_control_t) *pi_ctrl / structure for PI control return: (int16_t) s2_ref_v_delta / variation of output voltage	PI control calculation (velocity form)
	mtr_duty_calc [inline function] argument: (int16_t) s2_ref_v / reference voltage (int16_t) s2_vdc_ad / bus voltage return: (uint16_t) u4_temp / duty	Duty calculation
	mtr_abs [inline function] argument: (int16_t) s2_value / input value return: (int16_t) s2_temp / conversion value	Conversion to absolute value
mtr_limit_value [inline function] argument: (int16_t) s2_value / input value (int16_t) s2_limit_value / limit value return: (int16_t) s2_temp / conversion value	Limit process	

**Table 3-17 – List of Functions “r\_mtr\_interrupt.c” [2/3]**

file	function	process
r_mtr_interrupt.c	mtr_error_check [inline function] argument: none return: none	Error check
	mtr_1ms_interrupt_hall argument: none return: none	[Hall effect sensor control mode] IT interrupt (1 [ms]) <ul style="list-style-type: none"> <li>• set reference speed and voltage states</li> <li>• calculate reference speed and voltage</li> <li>• starting-up process</li> <li>• calculate rotational speed</li> <li>• check error</li> </ul>
	mtr_speed_calc [inline function] argument: none return: none	[Hall effect sensor control mode] Calculate rotational speed
	mtr_1ms_interrupt_less argument: none return: none	[sensorless control mode] IT interrupt (1 [ms]) <ul style="list-style-type: none"> <li>• set reference speed and voltage states</li> <li>• calculate reference speed and voltage</li> <li>• draw-in process</li> <li>• calculate rotational speed</li> <li>• calculate counts for open-loop drive</li> <li>• check error</li> </ul>
	mtr_delay_interrupt argument: none return: none	[sensorless control mode] TAU03 interrupt <ul style="list-style-type: none"> <li>• set voltage pattern</li> </ul>
	mtr_draw_in_pattern_set [inline function] argument: none return: none	[sensorless control mode] Set voltage pattern in draw-in state
	mtr_detect_zerocross [inline function] argument: (st_mtr_sensorless_control_t) *st_less / structure for control variables return: (uint16_t) u2_temp_signal / voltage pattern	[sensorless control mode] Estimate position of rotor from zero-crossing of induced voltage
	mtr_drive_openloop [inline function] argument: none return: none	[sensorless control mode] Open-loop drive process
	mtr_set_angle_shift [inline function] argument: none return: none	[sensorless control mode] Calculation of delay count after zero-crossing



**Table 3-18 – List of Functions “r\_mtr\_interrupt.c” [3/3]**

file	function	process
r_mtr_interrupt.c	mtr_openloop_pattern_set [inline function] argument: none return: (uint8_t) u1_pattern / voltage pattern	[sensorless control mode] Set voltage pattern at open-loop drive
	mtr_start_delay_timer [inline function] argument: none return: none	[sensorless control mode] Start delay timer
	mtr_stop_delay_timer [inline function] argument: none return: none	[sensorless control mode] Stop delay timer

### 3.3 Lists of variables of sensorless 120-degree conducting control software

Lists of variables used in this control program are shown below. However, note that the local variables are not mentioned.

In the sample programs, fixed-point number is used for calculation. Therefore, in advance, some control variables are set in fixed-point number. Bits number in fractional part of fixed-point number is expressed in the Q format. “Qn” means n bits left shift.

**Table 3-19 – List of variables “main.c”**

variable	type	Qn	content	Remarks
g_u1_system_mode	static uint8_t	Q0	Mode system management	
g_u1_motor_status	static uint8_t	Q0	Motor status management	
g_u1_reset_req	static uint8_t	Q0	Reset command flag for SW2	
g_u1_stop_req	static uint8_t	Q0	Stop command flag for VR1	
g_u2_error_status	static uint16_t	Q0	Error status management	
g_u1_flag_ui_change	static uint8_t	Q0	UI changing flag	
g_u2_conf_hw	uint16_t	Q0	RMW configuration variables	
g_u2_conf_sw	uint16_t	Q0		
g_u2_conf_tool	uint16_t	Q0		
gui_u1_active_gui	uint8_t	Q0		
g_u2_conf_sw_ver	uint16_t	Q0		
com_s2_sw_userif	int16_t	Q0	Management variable for UI	0:ICS_UI 1:BOARD_UI
g_s2_sw_userif	int16_t	Q0		
com_u1_run_event	uint8_t	Q0	Input event and change run mode	0 : MTR_EVENT_STOP 1 : MTR_EVENT_DRIVE 2 : MTR_EVENT_ERROR 3 : MTR_EVENT_RESET
g_u1_run_event	uint8_t	Q0		
g_u2_init_error	uint16_t	Q0	Initialization error management	

**Table 3-20 – List of variables “r\_mtr\_board.c”**

variable	type	Qn	content	Remarks
u1_sw_cnt	static uint8_t	Q0	Counter for judgement of chattering	

**Table 3-21 – List of variables “r\_mtr\_ics.c”**

variable	type	Qn	content	Remarks
com_u1_direction	uint8_t	Q0	Direction of rotation	0 : CW 1 : CCW
com_s2_ref_speed_rpm	int16_t	Q0	Command rotational speed [rpm]	Mechanical angle
com_s2_ramp_limit_v	int16_t	Q9	Limit of variation of voltage [V/ms]	
com_s2_kp_speed	int16_t	Q18	Proportional gain for speed PI control [V s/rad]	
com_s2_kidt_speed	int16_t	Q22	Integral gain for speed PI control [V s/rad]	
com_s2_ramp_speed_rpm	int16_t	Q0	Acceleration [rpm/ms]	Hall effect sensor control model
com_s2_start_ref_v	int16_t	Q9	Reference voltage at starting [V]	
com_s2_ol_ramp_speed_rpm	int16_t	Q0	Acceleration at open-loop drive [rpm/ms]	sensorless control mode
com_s2_less_ramp_speed_rpm	int16_t	Q0	Acceleration at sensorless control [rpm/ms]	
com_s2_draw_in_ref_v	int16_t	Q9	Reference voltage at draw-in [V]	
com_s2_ol_ref_v	int16_t	Q9	Reference voltage at open-loop drive [V]	
com_s2_ol2less_speed_rpm	int16_t	Q0	Speed to transition to PI control[rpm]	
com_s2_angle_shift_adjust	int16_t	Q0	adjust delay counts	
com_s2_enable_write	int16_t	Q0	Variable to allow to input ICS structure	
g_s2_enable_write	int16_t	Q0		
st_ics_input	mtr_ctrl_input_t	Q0	Variable to allow to input ICS structure	
com_u1_direction	uint8_t	Q0	Structure for ICS input	structure

**Table 3-22 – List of variables “r\_mtr\_parameter.h / Structure : st\_mtr\_ctrl\_gain\_t”**

variable	type	Qn	content	Remarks
s2_speed_pi_kp	int16_t	Q18	Proportional gain for speed PI control	
s2_speed_pi_kidt	int16_t	Q22	Integral gain for speed PI control	

**Table 3-23 – List of variables “r\_mtr\_driver\_access.h / Structure : mtr\_ctrl\_input\_t”**

variable	type	Qn	content	Remarks
u1_dir	uint8_t	Q0	Direction of rotation	
s2_ref_speed_rad	int16_t	Q4	Command rotational speed [rad/s]	electric angle
s2_ramp_limit_v	int16_t	Q9	Limit of variation of voltage [V/ms]	
s2_ramp_speed_rad	int16_t	Q4	Acceleration [krad/s <sup>2</sup> ]	
s2_start_ref_v	int16_t	Q9	Reference voltage at starting [V]	Hall effect sensor control mode
s2_ol_ramp_speed_rad	int16_t	Q4	Acceleration at open-loop drive [krad/s <sup>2</sup> ]	sensorless control mode
s2_less_ramp_speed_rad	int16_t	Q4	Acceleration at sensorless control [krad/s <sup>2</sup> ]	
s2_draw_in_ref_v	int16_t	Q9	Reference voltage at draw-in [V]	
s2_ol_ref_v	int16_t	Q9	Reference voltage at open-loop drive [V]	
s2_ol2less_speed_rad	int16_t	Q4	Speed to transition to PI control[rad/s]	
s2_angle_shift_adjust	int16_t	Q0	adjust delay counts	
st_gain	st_mtr_ctrl_gain_t	-	structure for PI control	structure

**Table 3-24 – List of variable “r\_mtr\_driver\_access.c”**

variable	type	Qn	content	Remarks
g_u1_trig_enable_write	uint8_t	Q0	Flag to allow to input ICS values	
st_ics_input_buff	mtr_ctrl_input_t	-	Buffer for ICS input	structure

**Table 3-25 – List of variables “r\_mtr\_statemachine.h / Structure : st\_mtr\_statemachine\_t”**

variable	type	Qn	content	Remarks
u1_status	uint8_t	Q0	Motor status	
u1_status_next	uint8_t	Q0	Next motor status	
u1_current_event	uint8_t	Q0	execution event	

**Table 3-26 – List of variables “r\_mtr\_statemachine.c”**

variable	type	Qn	content	Remarks
state_transition_table [MTR_SIZE_EVENT] [MTR_SIZE_STATE]	static uint8_t	Q0	Macro array for state transition	Array
mtr_action_table [MTR_SIZE_EVENT] [MTR_SIZE_STATE]	static mtr_action_t	Q0	Function array for state transition	Array

**Table 3-27 – List of variables in “r\_mtr\_120.h / structure: st\_mtr\_pi\_control\_t”**

variable	type	Qn	content	Remarks
s2_kp	int16_t	Q18	Proportional gain for speed PI control [(V s)/rad]	
s2_kidt	int16_t	Q22	Integral gain for speed PI control [(V s)/rad]	
s4_pre_refp	int32_t	Q22	Previous proportional term [V]	

**Table 3-28 – List of variables in “r\_mtr\_120.h / structure : st\_mtr\_hall\_control\_t”**

variable	type	Qn	content	Remarks
u1_hall_signal	uint8_t	Q0	Signal from Hall effect sensor	Hall effect sensor control model
u1_pre_hall_signal	uint8_t	Q0	Previous signal from Hall effect sensor	
u1_first_rotation_cnt	uint8_t	Q0	Pattern counter for first rotation	
s2_start_ref_v	int16_t	Q9	Reference voltage at open-loop drive [V]	

**Table 3-29 – List of variables in “r\_mtr\_120.h / structure: st\_mtr\_sensorless\_control\_t”**

variable	type	Qn	content	Remarks
u1_state_draw_in	uint8_t	Q0	Draw-in state management	sensorless control mode
u1_flag_pattern_change	uint8_t	Q0	Flag for detection of voltage pattern change	
u1_flag_set_v_pattern	uint8_t	Q0	Flag for setting voltage pattern	
u1_flag_ol2less	uint8_t	Q0	Flag to transition to PI control	
u1_flag_zc	uint8_t	Q0	Flag for zero-crossing detection avoiding commutation	
u1_flag_vdc_adc	uint8_t	Q0	Flag for measurement bus voltage	
u1_bemf_signal	uint8_t	Q0	Estimated Hall pattern	
u1_pre_bemf_signal	uint8_t	Q0	Previous estimated Hall pattern	
u1_set_v_pattern	uint8_t	Q0	Voltage pattern	
u1_ol_v_pattern_num	uint8_t	Q0	Ring buffer for voltage pattern at open-loop drive	
u2_cnt_carrier	uint16_t	Q0	Counter every carrier interruption	
u2_cnt_delay	uint16_t	Q0	Delay counts	
u2_ol_pattern_period	uint16_t	Q0	Period for pattern change at open-loop drive	
u2_cnt_draw_in	uint16_t	Q0	Counter for pattern change at draw-in	
u2_v_const_period	uint16_t	Q0	Period for pattern change at draw-in	
s2_vu_ad	int16_t	Q0	Voltage of U phase	
s2_vv_ad	int16_t	Q0	Voltage of V phase	
s2_vw_ad	int16_t	Q0	Voltage of W phase	
s2_vn_ad	int16_t	Q0	Estimated neutral voltage	
s2_ol2less_speed_rad	int16_t	Q4	Speed to transition to PI control [rad/s]	
s2_ol_ramp_speed_rad	int16_t	Q4	Acceleration at open-loop drive [krad/s <sup>2</sup> ]	
s2_less_ramp_speed_rad	int16_t	Q4	Acceleration at PI control[krad/s <sup>2</sup> ]	
s2_draw_in_ref_v	int16_t	Q9	Reference voltage at draw-in [V]	
s2_ol_ref_v	int16_t	Q9	Reference voltage at open-loop drive [V]	
s2_angle_shift_adjust	int16_t	Q0	Adjust delay counts	

**Table 3-30 – List of variable “r\_mtr\_interrupt.c”**

variable	type	Qn	content	Remarks
g_st_120	st_mtr_120_control_t	-	Structure for 120 conducting control	structure
g_u1_ol_v_pattern_table[2][7]	Uint8_t	Q0	Array for voltage pattern	Array

### 3.4 Macro definitions of sensorless 120-degree conducting control software

Lists of macro definitions used in this control program are shown below.

**Table 3-31 – List of Macro definitions “r\_mtr\_config.h”**

Macro	Definition value	Qn	content	Remarks
RL78_G1M_MRSSK	-	-	Select CPU board	
IP_MRSSK	-	-	Select inverter board	
MP_TG55L	-	-	Select motor parameters	
CP_TG55L	-	-	Select control parameters	
ICS_UI	0	-	RMW UI	Default
BOARD_UI	1	-	RSSK board UI	
MTRCONF_DEFAULT_UI	0/1	-	Select UI	BOARD_UI / ICS_UI
HALL	0	-	Hall effect sensor	
LESS	1	-	Sensorless	Default
MTRCONF_SENSOR_MODE	0/1	-	Select sensor to detect position of rotor	HALL / LESS

**Table 3-32 – List of Macro definitions “r\_mtr\_motor\_parameter.h”**

Macro	Definition value	Qn	content	Remarks
MP_POLE_PAIRS	2	-	Number of pole pairs	
MP_RESISTANCE	9.125f	-	Resistance [ $\Omega$ ]	
MP_D_INDUCTANCE	0.003844f	-	D-axis inductance[H]	
MP_Q_INDUCTANCE	0.004315f	-	Q-axis inductance[H]	
MP_MAGNETIC_FLUX	0.02144f	-	Induced voltage constant [V s/rad]	
MP_ROTOR_INERTIA	0.000002050f	-	Rotor inertia [kgm <sup>2</sup> ]	
MP_NOMINAL_CURRENT_RMS	0.42f	-	Nominal current [A]	

**Table 3-33 – List of Macro definitions “r\_mtr\_control\_parameter.h”**

Macro	Definition value	Qn	content	Remarks
CP_MAX_SPEED_RPM	3200	-	Maximum limit of command rotational speed [rpm]	Mechanical angle
CP_LIMIT_SPEED_RPM	3900	-	Maximum limit of estimated rotational speed [rpm]	Mechanical angle
CP_RAMP_LIMIT_V	0.25	-	Limit for variation of voltage [V]	
CP_MIN_SPEED_RPM	530 [Hall effect sensor control mode]/ 265 [sensorless control mode]	-	Minimum limit of command rotational speed [rpm]	Mechanical angle
CP_SPEED_PI_KP	0.03015119f [Hall effect sensor control mode]/ 0.001041950f [sensorless control mode]	-	Proportional gain for speed PI control [V s/rad]	
CP_SPEED_PI_KIDT	0.02192814f [Hall effect sensor control mode]/ 0.000551114f [sensorless control mode]	-	Integral gain for speed PI control [V s/rad]	
CP_HALL2OL_REV_SPEED_RPM	530	-	Speed to transition to open-loop drive [rpm]	Hall effect sensor control mode
CP_RAMP_SPEED_RPM	30	-	Acceleration [rpm/ms]	
CP_START_REF_V	3.5f	-	Initial voltage [V]	
CP_OL2LESS_SPEED_RPM	530	-	Speed to transition to open-loop drive [rpm]	sensorless control mode
CP_OL_RAMP_SPEED_RPM	2	-	Acceleration at open-loop drive [rpm/ms]	
CP_LESS_RAMP_SPEED_RPM	10	-	Acceleration at sensorless control [rpm/ms]	
CP_OL_REF_V	4.3f	-	Reference voltage at open loop [V]	
CP_DRAW_IN_REF_V	20.0f	-	Reference voltage at draw-in[V]	

**Table 3-34 – List of Macro definitions “r\_mtr\_inverter\_parameter.h”**

Macro	Definition value	Qn	content	Remarks
IP_VDC_RANGE	111.0f	-	Range of bus voltage [V]	
IP_INPUT_V	24.0f	-	Input voltage [V]	
IP_OVERVOLTAGE_LIMIT	28.0f	-	Upper limit of voltage [V]	
IP_UNDERVOLTAGE_LIMIT	15.0f	-	Lower limit of voltage [V]	



**Table 3-35 – List of Macro definitions “main.h”**

Macro	Definition value	Qn	content	Remarks
MODE_INACTIVE	0x00	-	Inactive mode	
MODE_ACTIVE	0x01	-	Active mode	
MODE_ERROR	0x02	-	Error mode	
SIZE_STATE	3	-	Number of states	

**Table 3-36 – List of Macro definitions “ICS\_define.h”**

Macro	Definition value	Qn	content	Remarks
RL78	-	-	CPU definition	

**Table 3-37 – List of Macro definitions “r\_mtr\_ics.h”**

Macro	Definition value	Qn	content	Remarks
ICS_ADDR	0xFE00	-	Address of ICS	
ICS_INT_LEVEL	2	-	ICS interrupt level setting	
ICS_NUM	0x40	-	Data size of ICS communication	
ICS_BRR	9	-	ICS bit rate register selection	
ICS_MODE	0	-	ICS interrupt mode setting	
ADJUST_ICS_PERIOD	150	-	Adjust period of ICS communication process	

**Table 3-38 – List of Macro definitions “r\_mtr\_board.h”**

Macro	Definition value	Qn	content	Remarks
SW_CHATTERING_CNT	10	-	Counts for judgement to remove chattering	
VR1_MARGIN	400	-	Margin value for VR1	
VR1_SCALING	$\text{mtr\_conv\_rpm2rad}(\text{CP\_MAX\_SPEED\_RPM} + \text{VR1\_MARGIN}) / 0x0200$	Q4	Scaling factor for speed calculation	
VR1_OFFSET	0x1FF	-	Offset for VR1	

Table 3-39 – List of Macro definitions in “r\_mtr\_ctrl\_rl78g1m.h” [1/2]

Macro	Definition value	Qn	content	Remarks
MTR_CARRIER_FREQ	20.0f	-	Frequency of carrier interrupt [kHz]	
MTR_TAU0_FREQ	20.0f	-	Frequency of TAU0 [MHz]	
MTR_1MS_FREQ	1.0f	-	Frequency of 1ms interrupt [kHz]	
MTR_IT_FREQ	15.0f	-	Frequency of 12-bit interval timer [kHz]	
MTR_TAU_PWM_CNT	(uint16_t)(MTR_TAU0_FREQ / MTR_CARRIER_FREQ * 1000 - 1)	-	Resister counts of carrier interrupt	
MTR_IT_1MS_CNT	(uint16_t)(MTR_IT_FREQ / MTR_1MS_FREQ - 1)	-	Resister counts of 1ms interrupt	
MTR_VDC_SCALING	(int16_t)(IP_VDC_RANGE / 1023.0f * (1 << MTR_Q_VOLTAGE))	Q9	Scaling factor to convert to voltage	
MTR_DUTY_BIT_SHIFT	5	-	Bits shift for duty calculation	
MTR_DUTY_SCALING	MTR_TAU_PWM_CNT >> (MTR_Q_VOLTAGE - MTR_DUTY_BIT_SHIFT)	-	Scaling factor for duty calculation	
MTR_TIME_WAIT_CHARGE_CAP	4300	-	Waiting time for capacitor charge	
MTR_CNT_WAIT_CHARGE_CAP	20	-	Number of loop times for capacitor charge	
MTR_PORT_HALL_U	P1_bit.no2	-	U phase Hall effect sensor input port	
MTR_PORT_HALL_V	P1_bit.no3	-	V phase Hall effect sensor input port	
MTR_PORT_HALL_W	P1_bit.no4	-	W phase Hall effect sensor input port	
MTR_PORT_UP	P0_bit.no0	-	U phase (positive phase) output port	
MTR_PORT_UN	P0_bit.no1	-	U phase (negative phase) output port	
MTR_PORT_VP	P0_bit.no2	-	V phase (positive phase) output port	
MTR_PORT_VN	P0_bit.no3	-	V phase (negative phase) output port	
MTR_PORT_WP	P0_bit.no4	-	W phase (positive phase) output port	
MTR_PORT_WN	P0_bit.no5	-	W phase (negative phase) output port	
MTR_PORT_SW1	P12_bit.no5	-	SW1 input port	
MTR_PORT_SW2	P13_bit.no7	-	SW2 input port	
MTR_PORT_LED1	P4_bit.no0	-	LED1 output port	
MTR_TAU1_CNT	TCR01	-	TAU1 count resister	
MTR_ADCCH_VR1	7	-	A/D converter channel of VR1	
MTR_ADCCH_VDC	6	-	A/D converter channel of bus voltage	
MTR_ADCCH_VU	3	-	A/D converter channel of U phase voltage	
MTR_ADCCH_VV	4	-	A/D converter channel of V phase voltage	
MTR_ADCCH_VW	5	-	A/D converter channel of W phase voltage	
MTR_ADCCH_IU	1	-	A/D converter channel of U phase current	
MTR_ADCCH_IV	2	-	A/D converter channel of V phase current	

**Table 3-40 – List of Macro definitions in “r\_mtr\_rl78g1m.h” [2/2]**

Macro	Definition value	Qn	content	Remarks
MTR_UP_H	0x0010	-	Voltage pattern	
MTR_UP_L	0x0000	-		
MTR_UP_PWM	0x0001	-		
MTR_VP_H	0x0020	-		
MTR_VP_L	0x0000	-		
MTR_VP_PWM	0x0002	-		
MTR_WP_H	0x0040	-		
MTR_WP_L	0x0000	-		
MTR_WP_PWM	0x0004	-		
MTR_UN_H	0x0080	-		
MTR_UN_L	0x0000	-		
MTR_UN_PWM	0x0008	-		
MTR_VN_H	0x1000	-		
MTR_VN_L	0x0000	-		
MTR_VN_PWM	0x0100	-		
MTR_WN_H	0x2000	-		
MTR_WN_L	0x0000	-		
MTR_WN_PWM	0x0200	-		
MTR_ALL_OFF	0x0000	-		
ERROR_NONE	0x00	-	No error	
ERROR_CHARGE_CAP_TIMEOUT	0x01	-	Timeout error of capacitor charge	

**Table 3-41 – List of Macro definitions “r\_mtr\_common.h”**

Macro	Definition value	Qn	content	Remarks
MTR_TWOPI	2*3.14159265359f	-	2π	
MTR_TWOPI_60	MTR_TWOPI/60	-	2π/60	
MTR_CW	0	-	CW	
MTR_CCW	1	-	CCW	
MTR_ON	0	-	ON	
MTR_OFF	1	-	OFF	
MTR_CLR	0	-	Flag clear	
MTR_SET	1	-	Flag set	

**Table 3-42 – List of Macro definitions “r\_mtr\_fixed.h”**

Macro	Definition value	Qn	content	Remarks
MTR_Q_VOLTAGE	9	-	Q-format of voltage	
MTR_Q_AFREQ	4	-	Q-format of angular frequency	
MTR_Q_SPEED_KP	18	-	Q-format of proportional gain	
MTR_Q_SPEED_KIDT	22	-	Q-format of integral gain	
RSFT_AFREQ_KP_2VOLTAGE	MTR_Q_SPEED_KP + MTR_Q_AFREQ – MTR_Q_VOLTAGE	-	Right shift, (KP * speed) to voltage	
RSFT_AFREQ_KIDT_2VOLTAGE	MTR_Q_SPEED_KIDT + MTR_Q_AFREQ – MTR_Q_VOLTAGE	-	Right shift, (KIDT * speed) to voltage	

**Table 3-43 – List of Macro definitions “r\_mtr\_parameter.h”**

Macro	Definition value	Qn	content	Remarks
MTR_SPEED_CALC_BASE	(int32_t)(156000 * MTR_TWOPI * (1 << MTR_Q_AFREQ))	Q9	Calculation parameter to convert the timer counter to rotational speed	
MTR_SPEED_CALC_BASE_1ST	MTR_SPEED_CALC_BASE/6	Q9	Calculation parameter to convert the timer counter to rotational speed at first speed calculation	
MTR_SPEED_CALC_BASE_2ND	MTR_SPEED_CALC_BASE/3	Q9	Calculation parameter to convert the timer counter to rotational speed at second speed calculation	
MTR_SPEED_CALC_BASE_3RD	MTR_SPEED_CALC_BASE/2	Q9	Calculation parameter to convert the timer counter to rotational speed at third speed calculation	
MTR_SPEED_CALC_BASE_4TH	MTR_SPEED_CALC_BASE*2/3	Q9	Calculation parameter to convert the timer counter to rotational speed at fourth speed calculation	
MTR_SPEED_CALC_BASE_5TH	MTR_SPEED_CALC_BASE*5/6	Q9	Calculation parameter to convert the timer counter to rotational speed at fifth speed calculation	
MTR_OL_CNT_CALC_BASE	MTR_CARRIER_FREQ * 1000 * MTR_TWOPI / MTR_PATTERN_NUM	-	Calculation parameter to convert rotational speed to timer counter at open-loop drive	
MTR_MAX_SPEED_RAD	mtr_conv_rpm2rad(CP_MAX_SPEED_RPM)	Q4	Maximum reference rotational speed [rad/s]	
MTR_MIN_SPEED_RAD	mtr_conv_rpm2rad(CP_MIN_SPEED_RPM)	Q4	Minimum reference rotational speed [rad/s]	
MTR_MAX_DRIVE_V	mtr_conv_q_voltage(IP_INPUT_V * 0.90f)	Q9	Maximum output voltage [V]	
MTR_MIN_DRIVE_V	mtr_conv_q_voltage(IP_INPUT_V * 0.0f)	Q9	Minimum output voltage [V]	
MTR_MCU_ON_V	mtr_conv_q_voltage(IP_INPUT_V * 0.8)	Q9	MCU stable supply voltage [V]	

**Table 3-44 – List of Macro definitions “r\_mtr\_statemachine.h”**

Macro	Definition value	Qn	content	Remarks
MTR_MODE_INIT	0x00	Q0	Initialization mode	
MTR_MODE_DRIVE	0x01	Q0	Drive mode	
MTR_MODE_STOP	0x02	Q0	Stop mode	
MTR_SIZE_STATE	3	Q0	Number of states	
MTR_EVENT_STOP	0x00	Q0	Stop event	
MTR_EVENT_DRIVE	0x01	Q0	Run event	
MTR_EVENT_ERROR	0x02	Q0	Error event	
MTR_EVENT_RESET	0x03	Q0	Reset event	
MTR_SIZE_EVENT	4	Q0	Number of events	

**Table 3-45 – List of Macro definitions in “r\_mtr\_120.h” [1/2]**

Macro	Definition value	Qn	content	Remarks
MTR_TIMEOUT_CNT	200	-	Counts for timeout	
MTR_HALL2OL_REV_SPE ED_RAD	FIX_fromfloat(CP_HALL2OL_REV_ SPEED_RPM * PU_SF_AFREQ, MTR_Q_AFREQ)	Q4	Speed to transition to PI control at reverse of direction	Hall effect sensor control mode
MTR_AVOID_COMMUTAT ION	4	-	Counts for avoiding to detect zero-crossing after commutation	Sensorless control mode
MTR_DRAW_IN_1ST_PAT TERN	1	-	Voltage pattern at first draw-in	
MTR_DRAW_IN_2ND_PA TTERN	2	-	Voltage pattern at second draw- in	
MTR_PATTERN_CW_V_U	2	-	Voltage pattern at CW rotation	
MTR_PATTERN_CW_W_ U	3	-		
MTR_PATTERN_CW_W_V	1	-		
MTR_PATTERN_CW_U_V	5	-		
MTR_PATTERN_CW_U_ W	4	-		
MTR_PATTERN_CW_V_W	6	-		
MTR_PATTERN_CCW_V_ U	5 [Hall effect sensor control mode]/ 3 [sensorless control mode]	-		Voltage patten at CCW rotation
MTR_PATTERN_CCW_V_ W	1 [Hall effect sensor control mode]/ 2 [sensorless control mode]	-		
MTR_PATTERN_CCW_U_ W	3 [Hall effect sensor control mode]/ 6 [sensorless control mode]	-		
MTR_PATTERN_CCW_U_ V	2 [Hall effect sensor control mode]/ 4 [sensorless control mode]	-		
MTR_PATTERN_CCW_W _V	6 [Hall effect sensor control mode]/ 5 [sensorless control mode]	-		
MTR_PATTERN_CCW_W _U	4 [Hall effect sensor control mode]/ 1 [sensorless control mode]	-		
MTR_PATTERN_NUM	6	-	Number of voltage patterns	

**Table 3-46 – List of Macro definitions in “r\_mtr\_120.h” [2/2]**

Macro	Definition value	Qn	content	Remarks
MTR_ERROR_NONE	0x00	-	No error	
MTR_ERROR_OVER_CURRENT	0x01	-	Over current error	
MTR_ERROR_OVER_VOLTAGE	0x02	-	Over voltage error	
MTR_ERROR_OVER_SPEED	0x04	-	Over speed error	
MTR_ERROR_HALL_TIMEOUT	0x08	-	Timeout error for Hall effect sensor control mode	
MTR_ERROR_BEMF_TIMEOUT	0x10	-	Timeout error for sensorless control mode	
MTR_ERROR_HALL_PATTERN	0x20	-	Hall pattern error	
MTR_ERROR_BEMF_PATTERN	0x40	-	BEMF pattern error	
MTR_ERROR_UNDER_VOLTAGE	0x80	-	Under voltage error	
MTR_ERROR_UNKNOWN	0xff	-	Undefined error	
MTR_DRAW_IN_NONE	0	-	No operation	
MTR_DRAW_IN_1ST	1	-	First draw-in	
MTR_DRAW_IN_2ND	2	-	Second draw-in	
MTR_DRAW_IN_FINISH	3	-	Draw-in finished	
MTR_SPEED_ZERO_CONST	0	-	Reference speed 0 const mode	
MTR_SPEED_MANUAL	1	-	Reference speed manual input mode	
MTR_V_ZERO_CONST	0	-	Reference voltage zero const mode	
MTR_V_MANUAL	1	-	Reference voltage manual input mode	
MTR_V_PI_OUTPUT	2	-	Reference voltage PI output mode	

### 3.5 Control flows (flow charts)

#### 3.5.1 Main process

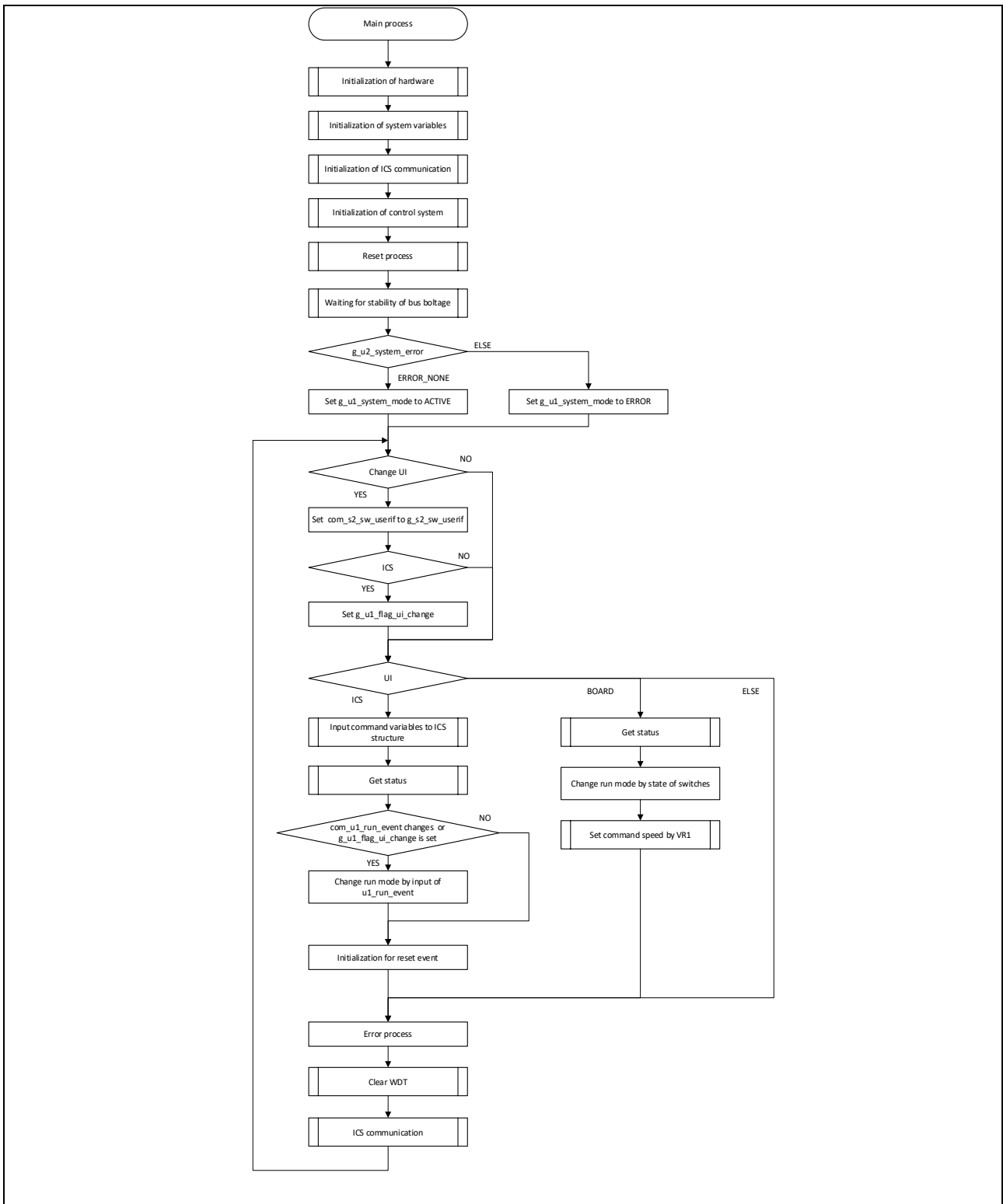

Figure 3-7 – Main Process Flowchart

### 3.5.2 Carrier cycle interrupt handling

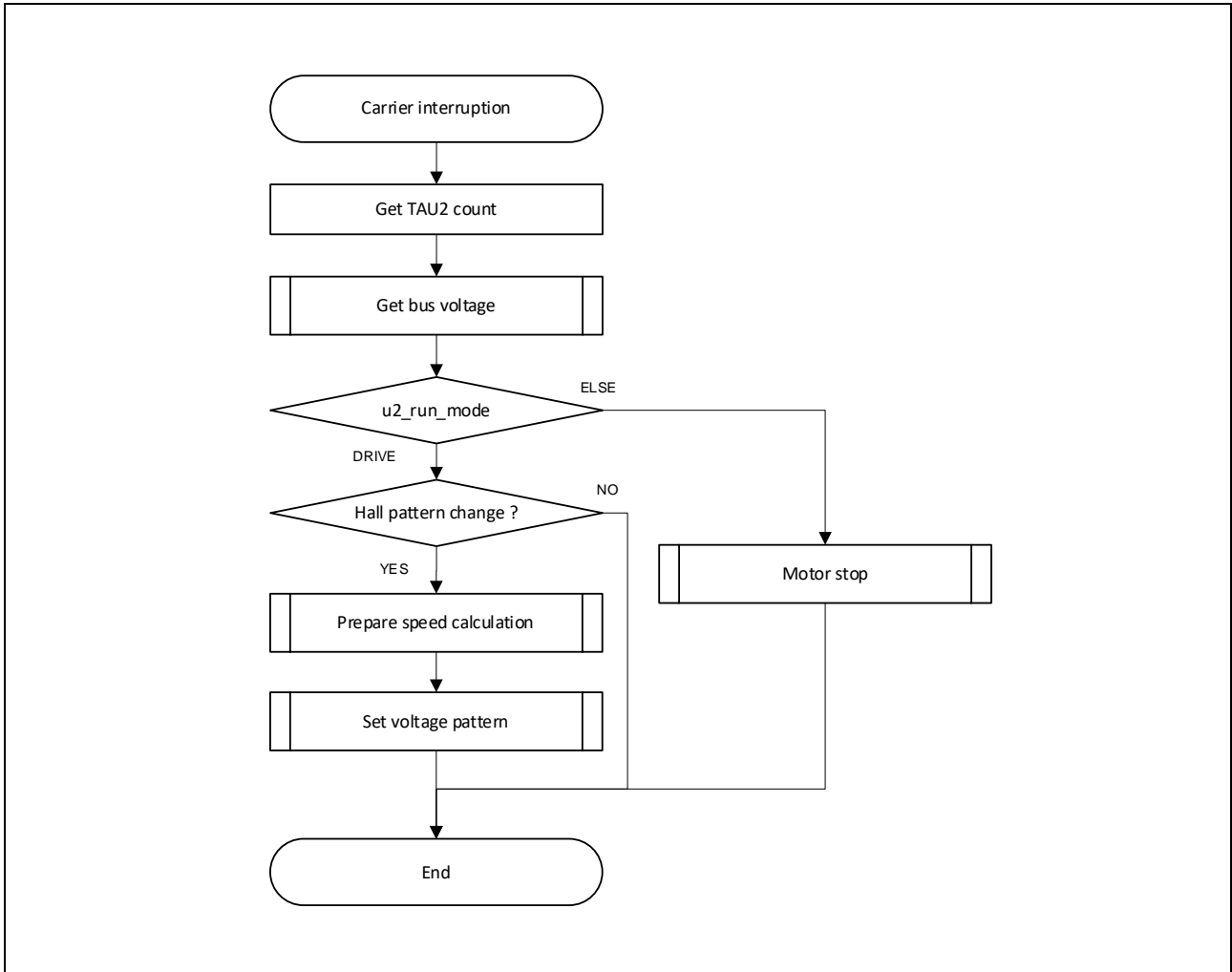

Figure 3-8 – Carrier Cycle Interrupt Handling Flowchart (Hall Effect Sensor Control Mode)



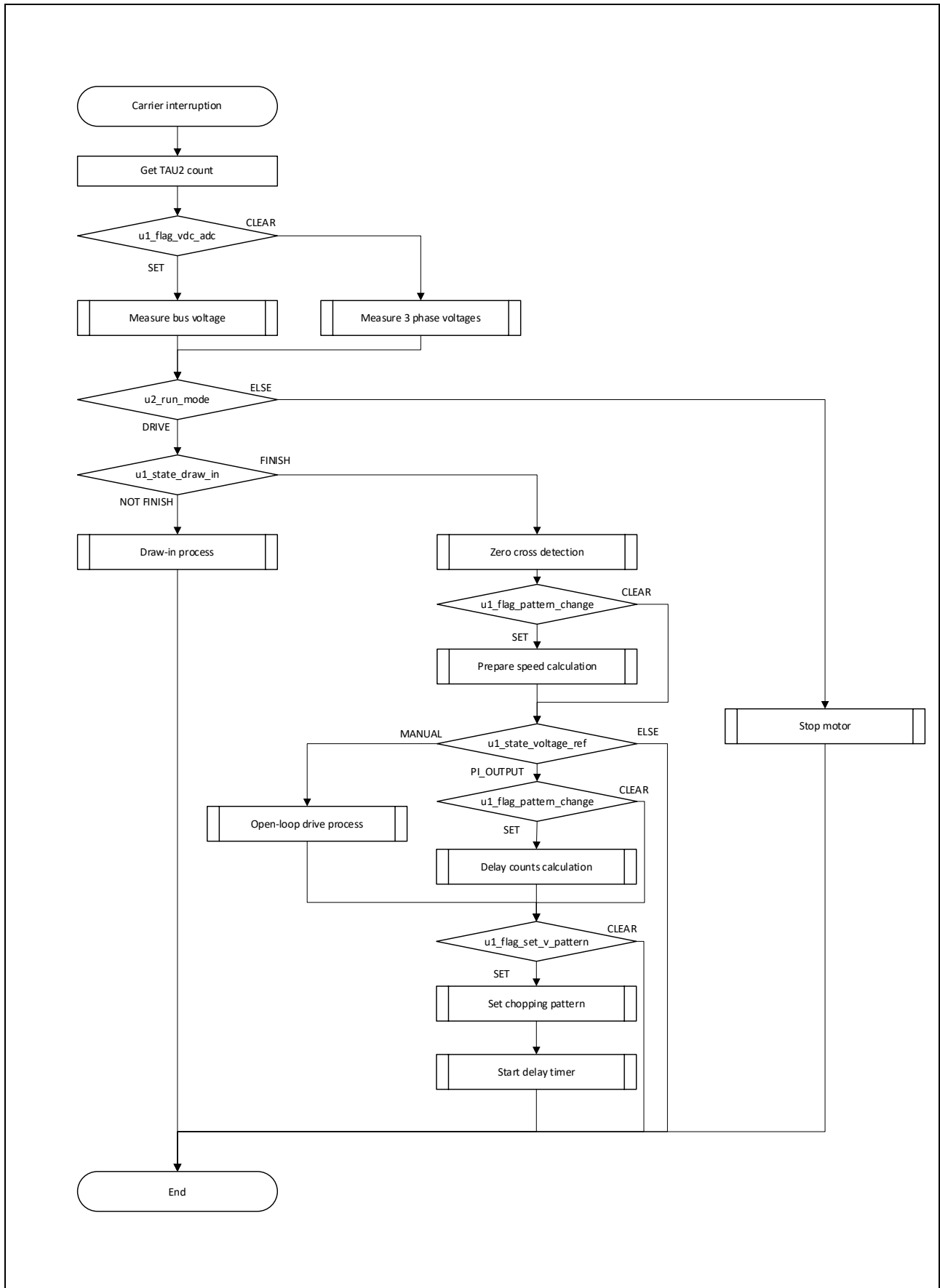

Figure 3-9 – Carrier Cycle Interrupt Handling Flowchart (Sensorless Control Mode)

### 3.5.3 1 [ms] interrupt handling

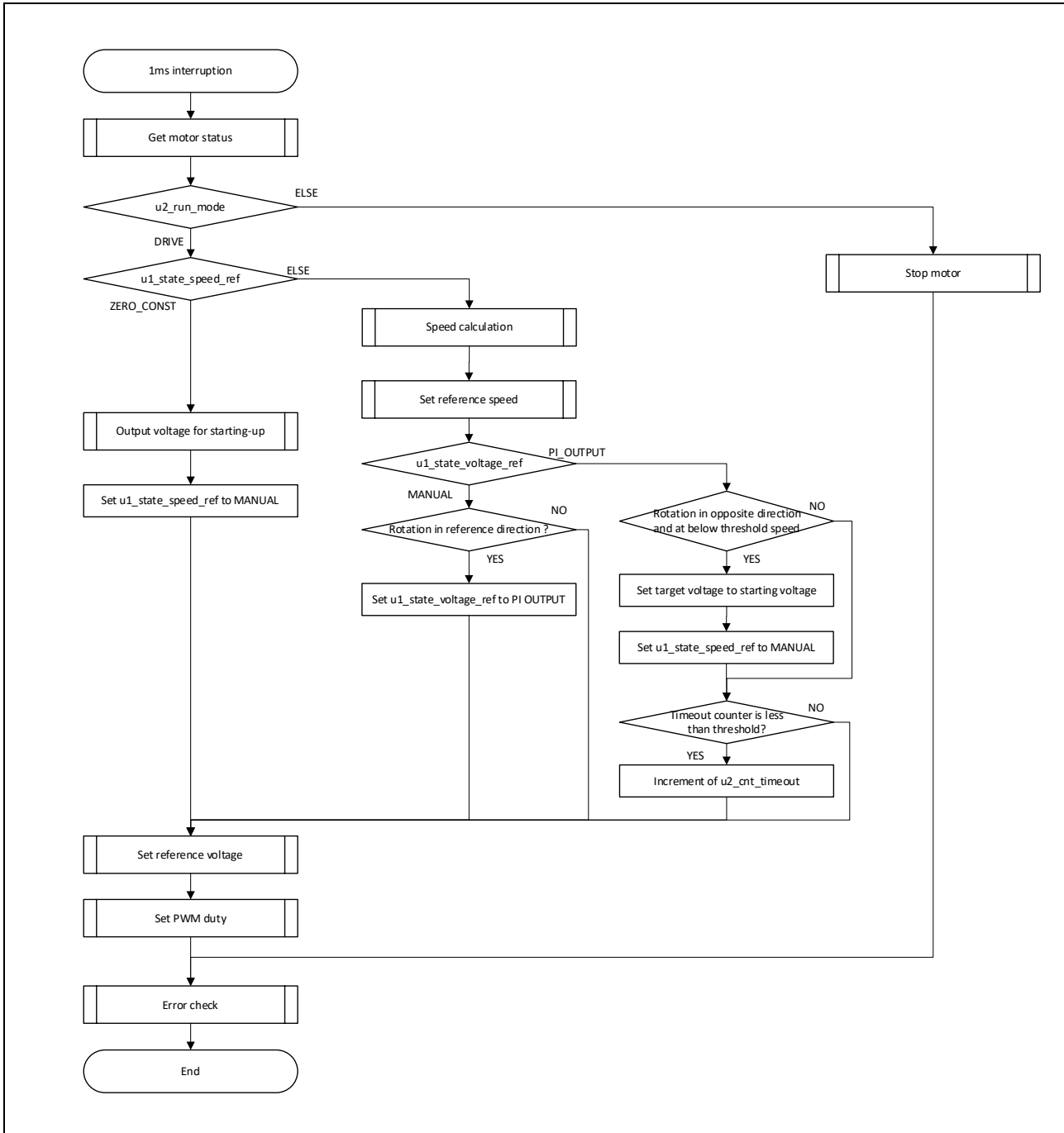

Figure 3-10 – 1 [ms] Interrupt Handling(Hall effect sensor control mode)

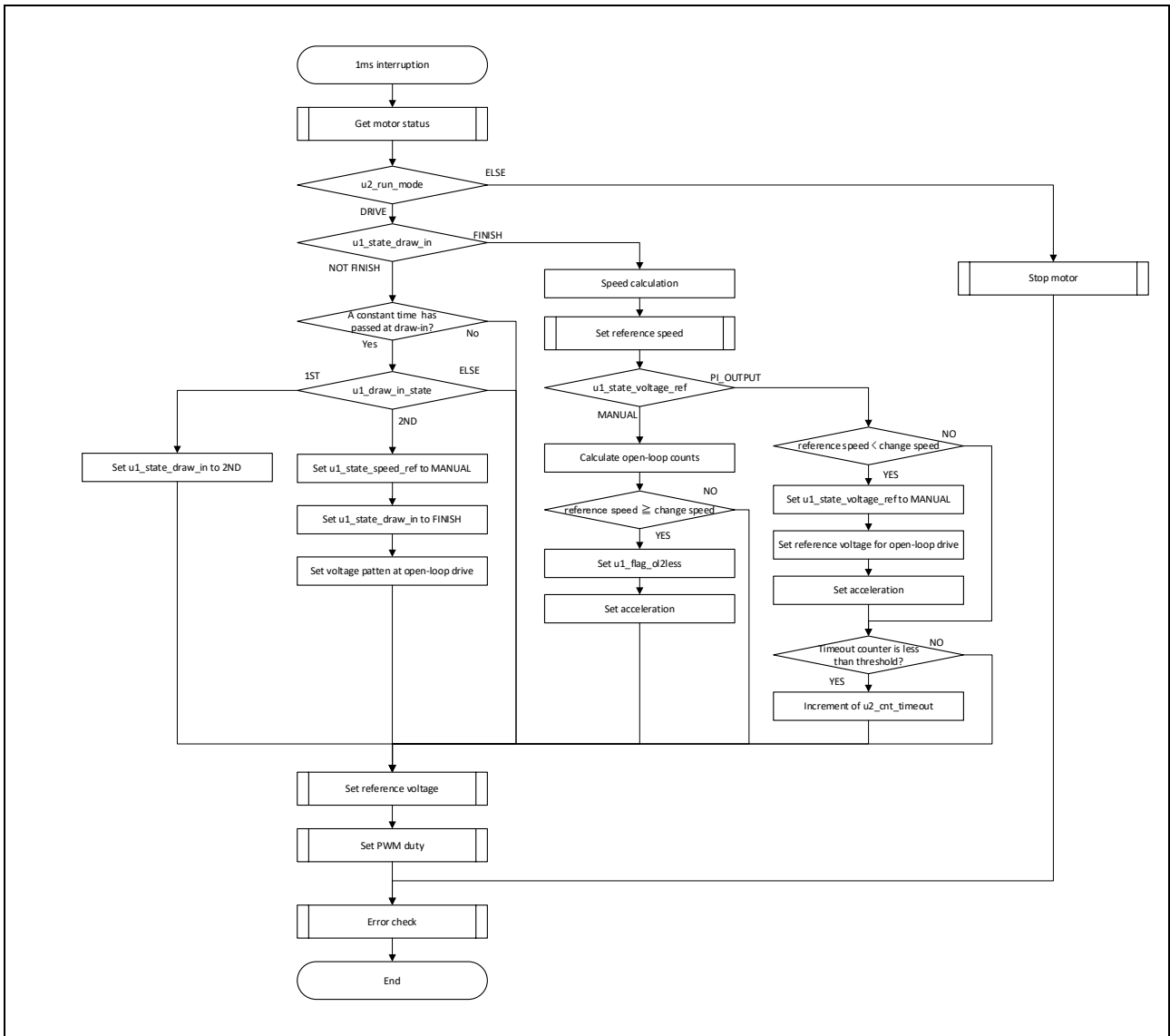

Figure 3-11 – 1 [ms] Interrupt Handling (sensorless control mode)

### 3.5.4 Overcurrent interrupt handling

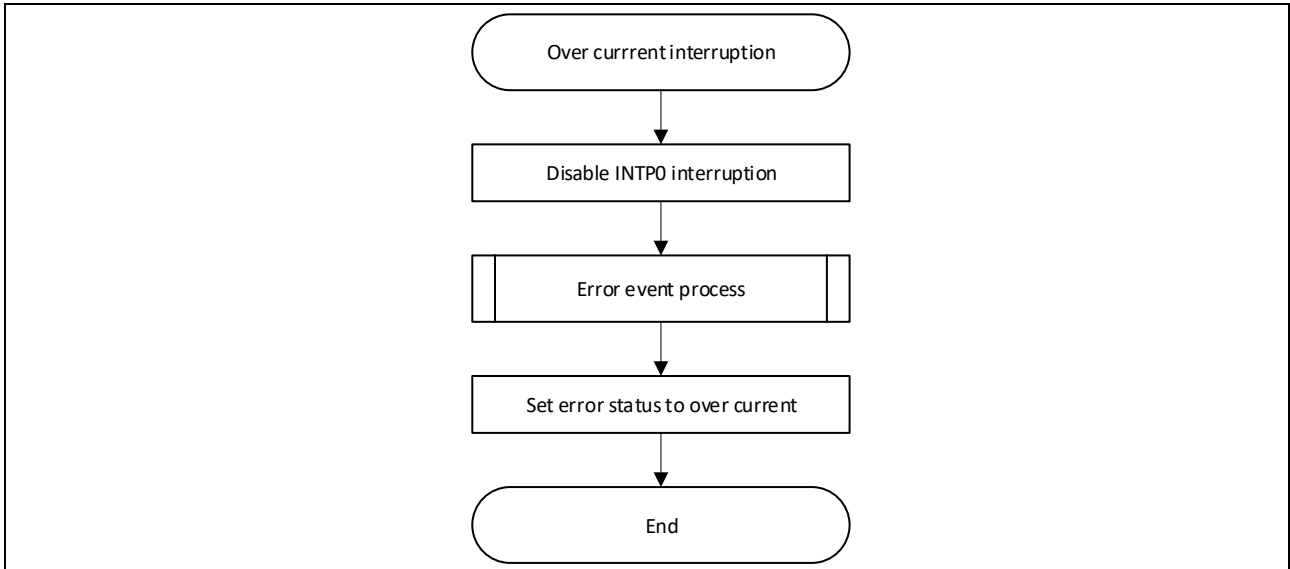

Figure 3-12 – Over Current Detection Interrupt Handling

### 3.5.5 Delay timer interrupt handling

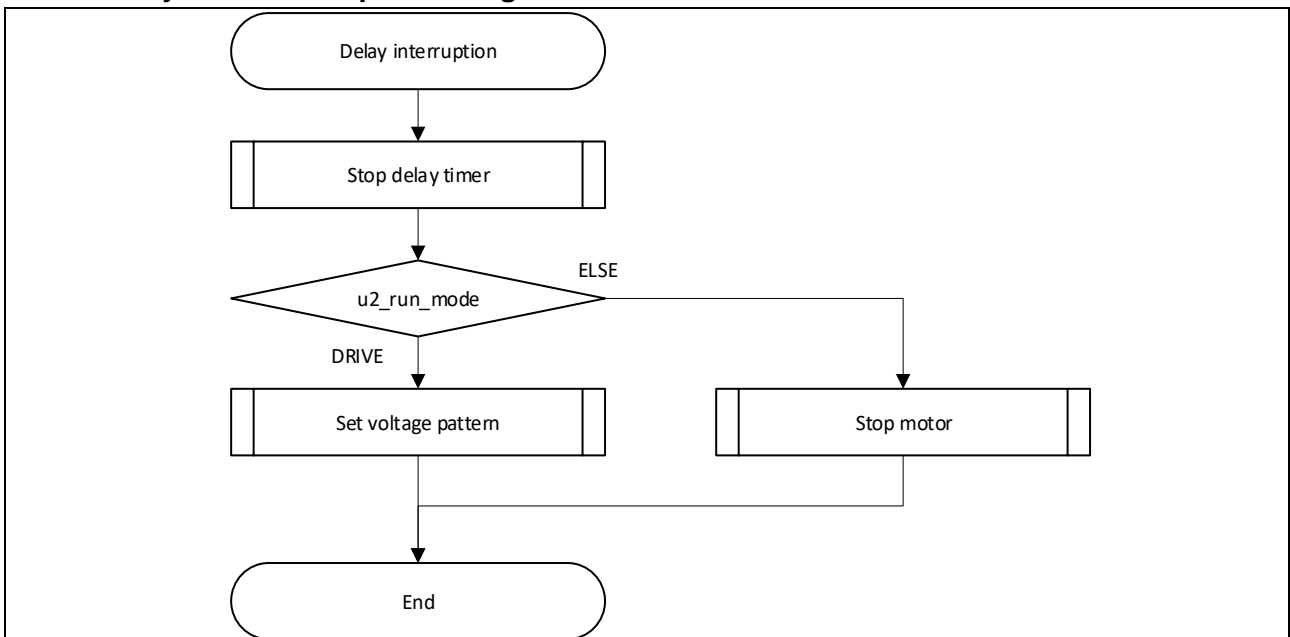

Figure 3-13 – Delay timer Interrupt Handling

## 4. Usage of Motor Control Development Support Tool, ‘Renesas Motor Workbench’

### 4.1 Overview

In the target sample programs described in this application note, user interfaces (rotating/stop command, rotation speed command, etc.) based on the motor control development support tool, ‘Renesas Motor Workbench’ can be used. Please refer to ‘Renesas Motor Workbench V 2.0 User’s Manual’ for usage and more details. You can find ‘Renesas Motor Workbench’ on Renesas Electronics Corporation website.

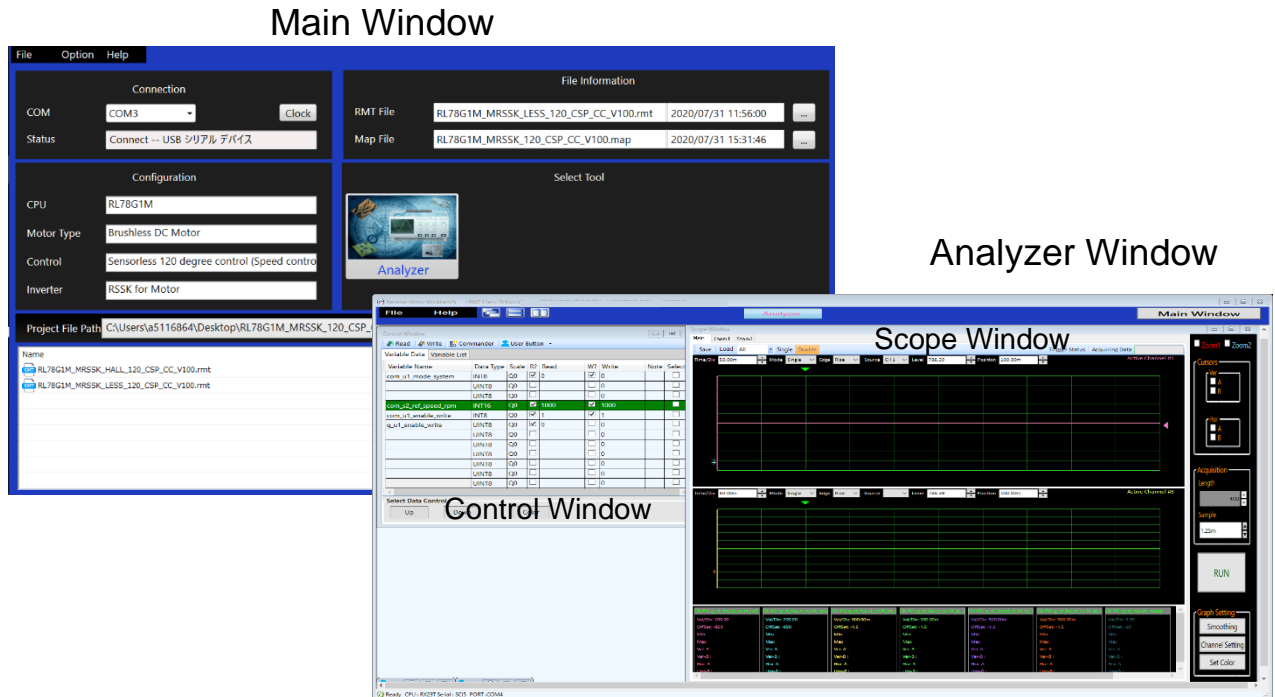

Figure 4-1 – Renesas Motor Workbench– Appearance

#### Set up for Renesas Motor Workbench



- (1) Start ‘Renesas Motor Workbench’ by clicking this icon
- (2) Drop down menu [File] → [Open RMT File(O)].  
And select RMT file in ‘[Project Folder]/application/ics’.
- (3) Use the ‘Connection’ COM select menu to choose the COM port.
- (4) Click the ‘Analyzer’ icon in right side of Main Window.  
(Then, “Analyzer Window” will be displayed.)
- (5) Please refer to ‘4.3 Analyzer Operation Example for Analyzer’ for motor driving operation.

## 4.2 List of variables for Analyzer

Table 4-1 is a list of variables for Analyzer. These variable values are reflected to the protect variables when the same values as g\_s2\_enable\_write are written to com\_s2\_enable\_write. However, note that variables with (\*) do not depend on com\_s2\_enable\_write.

**Table 4-1 – List of Variables for Analyzer**

variable	type	content	Remarks ([ ]: reflection variable name)
com_u1_run_event (*)	uint8_t	Input event and change run mode 0: Stop event 1: Drive event 2: Error event 3: Reset event	[g_u1_run_event]
com_s2_sw_userif (*)	int16_t	Management variable for UI 0: Analyzer use (default) 1: Board user interface use	[g_s2_sw_userif]
com_u1_direction	uint8_t	Direction of rotation 0 : CW 1 : CCW	[g_st_120.u1_ref_dir]
com_s2_ref_speed_rpm	int16_t	Command rotational speed [rpm]	[g_st_120.s2_ref_speed_rad]
com_s2_ramp_limit_v	int16_t	Limit of variation of voltage [V/ms]	[g_st_120.s2_ramp_limit_v]
com_s2_kp_speed	int16_t	Proportional gain for speed PI control [V s/rad]	[g_st_120.st_pi_speed.s2_kp]
com_s2_kidt_speed	int16_t	Integral gain for speed PI control [V s/rad]	[g_st_120.st_pi_speed.s2_kidt]
com_s2_ramp_speed_rpm	int16_t	Acceleration [rpm/ms]	[g_st_120.s2_ramp_speed_rad]
com_s2_start_ref_v	int16_t	Reference voltage at starting[V]	[g_st_120.st_hall.s2_start_ref_v]
com_s2_ol_ramp_speed_rpm	int16_t	Acceleration at open-loop drive [rpm/ms]	[g_st_120.st_less.s2_ol_ramp_speed_rad]
com_s2_less_ramp_speed_rpm	int16_t	Acceleration at PI control [RPM/ms]	[g_st_120.st_less.s2_less_ramp_speed_rad]
com_s2_draw_in_ref_v	int16_t	Reference voltage at draw-in [V]	[g_st_120.st_less.s2_draw_in_ref_v]
com_s2_ol_ref_v	int16_t	Reference voltage at open-loop drive[V]	[g_st_120.st_less.s2_ol_ref_v]
com_s2_ol2less_speed_rpm	int16_t	Speed to transition to PI control[rpm]	[g_st_120.st_less.s2_ol2less_speed_rad]
com_s2_angle_shift_adjust	int16_t	adjust delay counts	[g_st_120.st_less.s2_angle_shift_adjust]
com_s2_enable_write	int16_t	Variable to allow to input ICS structure	[g_s2_enable_write]

### 4.3 Operation Example for Analyzer

An example of motor driving operation using Analyzer is shown below. For operation “Control Window Figure 4-1” is used. Refer to ‘Renesas Motor Workbench V 2.0 User’s Manual’ for “Control Window”.

- Driving the motor
  - (1) The [W?] check boxes contain checkmarks for “com\_u1\_run\_event”, “com\_s2\_ref\_speed\_rpm”, “com\_s2\_enable\_write”
  - (2) Input a reference speed value in the [Write] box of “com\_s2\_ref\_speed\_rpm”.
  - (3) Click the “Write” button.
  - (4) Click the “Read” button. Confirm the [Read] box of “com\_s2\_ref\_speed\_rpm”, “g\_s2\_enable\_write”.
  - (5) Input a same value of “g\_s2\_enable\_write” in the [Write] box of “com\_s2\_ref\_speed\_rpm”.
  - (6) Input a value of “1” in the [Write] box of “com\_u1\_run\_event”.
  - (7) Click the “Write” button.

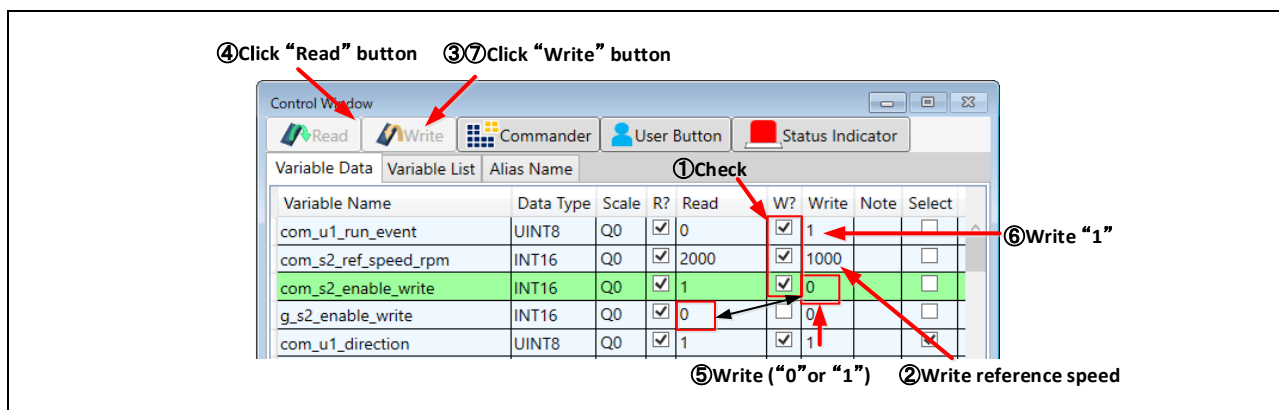

Figure 4-2 – Procedure - Driving the motor

- Stop the motor
  - (1) Type a value of “0” in the [Write] box of “com\_u1\_run\_event”
  - (2) Click the “Write” button.

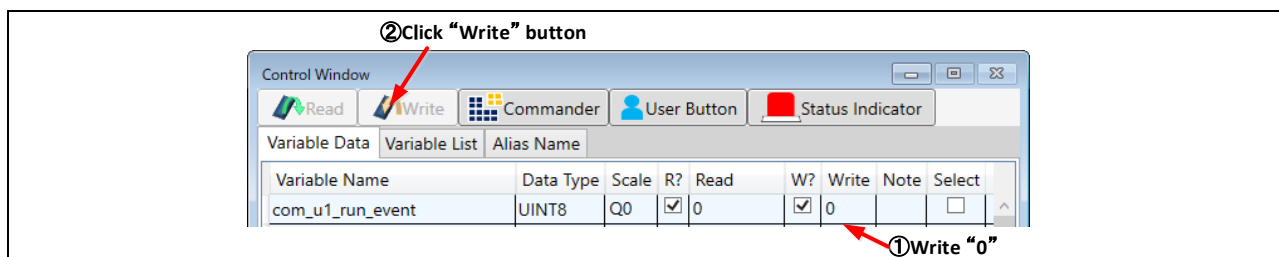

Figure 4-3 – Procedure - Stop the motor

- Error cancel operation
  - (1) Type a value of “3” in the [Write] box of “com\_u1\_run\_event”
  - (2) Click the “Write” button.

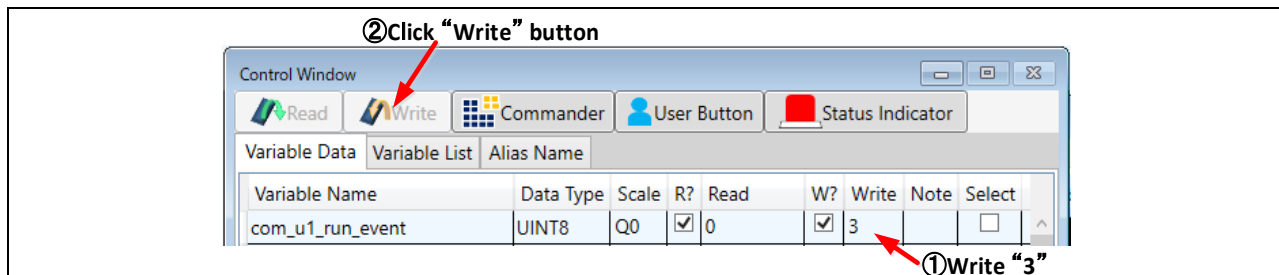

Figure 4-4 – Procedure - Error cancel operation

**Revision record**

Rev.	Date	Description	
		Page	Summary
1.00	2020/08/01	-	First edition issued



# General Precautions in the Handling of Microprocessing Unit and Microcontroller Unit Products

The following usage notes are applicable to all Microprocessing unit and Microcontroller unit products from Renesas. For detailed usage notes on the products covered by this document, refer to the relevant sections of the document as well as any technical updates that have been issued for the products.

## 1. Precaution against Electrostatic Discharge (ESD)

A strong electrical field, when exposed to a CMOS device, can cause destruction of the gate oxide and ultimately degrade the device operation. Steps must be taken to stop the generation of static electricity as much as possible, and quickly dissipate it when it occurs. Environmental control must be adequate. When it is dry, a humidifier should be used. This is recommended to avoid using insulators that can easily build up static electricity.

Semiconductor devices must be stored and transported in an anti-static container, static shielding bag or conductive material. All test and measurement tools including work benches and floors must be grounded. The operator must also be grounded using a wrist strap. Semiconductor devices must not be touched with bare hands. Similar precautions must be taken for printed circuit boards with mounted semiconductor devices.

## 2. Processing at power-on

The state of the product is undefined at the time when power is supplied. The states of internal circuits in the LSI are indeterminate and the states of register settings and pins are undefined at the time when power is supplied. In a finished product where the reset signal is applied to the external reset pin, the states of pins are not guaranteed from the time when power is supplied until the reset process is completed. In a similar way, the states of pins in a product that is reset by an on-chip power-on reset function are not guaranteed from the time when power is supplied until the power reaches the level at which resetting is specified.

## 3. Input of signal during power-off state

Do not input signals or an I/O pull-up power supply while the device is powered off. The current injection that results from input of such a signal or I/O pull-up power supply may cause malfunction and the abnormal current that passes in the device at this time may cause degradation of internal elements. Follow the guideline for input signal during power-off state as described in your product documentation.

## 4. Handling of unused pins

Handle unused pins in accordance with the directions given under handling of unused pins in the manual. The input pins of CMOS products are generally in the high-impedance state. In operation with an unused pin in the open-circuit state, extra electromagnetic noise is induced in the vicinity of the LSI, an associated shoot-through current flows internally, and malfunctions occur due to the false recognition of the pin state as an input signal become possible.

## 5. Clock signals

After applying a reset, only release the reset line after the operating clock signal becomes stable. When switching the clock signal during program execution, wait until the target clock signal is stabilized. When the clock signal is generated with an external resonator or from an external oscillator during a reset, ensure that the reset line is only released after full stabilization of the clock signal. Additionally, when switching to a clock signal produced with an external resonator or by an external oscillator while program execution is in progress, wait until the target clock signal is stable.

## 6. Voltage application waveform at input pin

Waveform distortion due to input noise or a reflected wave may cause malfunction. If the input of the CMOS device stays in the area between  $V_{IL}$  (Max.) and  $V_{IH}$  (Min.) due to noise, for example, the device may malfunction. Take care to prevent chattering noise from entering the device when the input level is fixed, and also in the transition period when the input level passes through the area between  $V_{IL}$  (Max.) and  $V_{IH}$  (Min.).

## 7. Prohibition of access to reserved addresses

Access to reserved addresses is prohibited. The reserved addresses are provided for possible future expansion of functions. Do not access these addresses as the correct operation of the LSI is not guaranteed.

## 8. Differences between products

Before changing from one product to another, for example to a product with a different part number, confirm that the change will not lead to problems. The characteristics of a microprocessing unit or microcontroller unit products in the same group but having a different part number might differ in terms of internal memory capacity, layout pattern, and other factors, which can affect the ranges of electrical characteristics, such as characteristic values, operating margins, immunity to noise, and amount of radiated noise. When changing to a product with a different part number, implement a system-evaluation test for the given product.

## Notice

1. Descriptions of circuits, software and other related information in this document are provided only to illustrate the operation of semiconductor products and application examples. You are fully responsible for the incorporation or any other use of the circuits, software, and information in the design of your product or system. Renesas Electronics disclaims any and all liability for any losses and damages incurred by you or third parties arising from the use of these circuits, software, or information.
2. Renesas Electronics hereby expressly disclaims any warranties against and liability for infringement or any other claims involving patents, copyrights, or other intellectual property rights of third parties, by or arising from the use of Renesas Electronics products or technical information described in this document, including but not limited to, the product data, drawings, charts, programs, algorithms, and application examples.
3. No license, express, implied or otherwise, is granted hereby under any patents, copyrights or other intellectual property rights of Renesas Electronics or others.
4. You shall not alter, modify, copy, or reverse engineer any Renesas Electronics product, whether in whole or in part. Renesas Electronics disclaims any and all liability for any losses or damages incurred by you or third parties arising from such alteration, modification, copying or reverse engineering.
5. Renesas Electronics products are classified according to the following two quality grades: "Standard" and "High Quality". The intended applications for each Renesas Electronics product depends on the product's quality grade, as indicated below.  
"Standard": Computers; office equipment; communications equipment; test and measurement equipment; audio and visual equipment; home electronic appliances; machine tools; personal electronic equipment; industrial robots; etc.  
"High Quality": Transportation equipment (automobiles, trains, ships, etc.); traffic control (traffic lights); large-scale communication equipment; key financial terminal systems; safety control equipment; etc.  
Unless expressly designated as a high reliability product or a product for harsh environments in a Renesas Electronics data sheet or other Renesas Electronics document, Renesas Electronics products are not intended or authorized for use in products or systems that may pose a direct threat to human life or bodily injury (artificial life support devices or systems; surgical implantations; etc.), or may cause serious property damage (space system; undersea repeaters; nuclear power control systems; aircraft control systems; key plant systems; military equipment; etc.). Renesas Electronics disclaims any and all liability for any damages or losses incurred by you or any third parties arising from the use of any Renesas Electronics product that is inconsistent with any Renesas Electronics data sheet, user's manual or other Renesas Electronics document.
6. When using Renesas Electronics products, refer to the latest product information (data sheets, user's manuals, application notes, "General Notes for Handling and Using Semiconductor Devices" in the reliability handbook, etc.), and ensure that usage conditions are within the ranges specified by Renesas Electronics with respect to maximum ratings, operating power supply voltage range, heat dissipation characteristics, installation, etc. Renesas Electronics disclaims any and all liability for any malfunctions, failure or accident arising out of the use of Renesas Electronics products outside of such specified ranges.
7. Although Renesas Electronics endeavors to improve the quality and reliability of Renesas Electronics products, semiconductor products have specific characteristics, such as the occurrence of failure at a certain rate and malfunctions under certain use conditions. Unless designated as a high reliability product or a product for harsh environments in a Renesas Electronics data sheet or other Renesas Electronics document, Renesas Electronics products are not subject to radiation resistance design. You are responsible for implementing safety measures to guard against the possibility of bodily injury, injury or damage caused by fire, and/or danger to the public in the event of a failure or malfunction of Renesas Electronics products, such as safety design for hardware and software, including but not limited to redundancy, fire control and malfunction prevention, appropriate treatment for aging degradation or any other appropriate measures. Because the evaluation of microcomputer software alone is very difficult and impractical, you are responsible for evaluating the safety of the final products or systems manufactured by you.
8. Please contact a Renesas Electronics sales office for details as to environmental matters such as the environmental compatibility of each Renesas Electronics product. You are responsible for carefully and sufficiently investigating applicable laws and regulations that regulate the inclusion or use of controlled substances, including without limitation, the EU RoHS Directive, and using Renesas Electronics products in compliance with all these applicable laws and regulations. Renesas Electronics disclaims any and all liability for damages or losses occurring as a result of your noncompliance with applicable laws and regulations.
9. Renesas Electronics products and technologies shall not be used for or incorporated into any products or systems whose manufacture, use, or sale is prohibited under any applicable domestic or foreign laws or regulations. You shall comply with any applicable export control laws and regulations promulgated and administered by the governments of any countries asserting jurisdiction over the parties or transactions.
10. It is the responsibility of the buyer or distributor of Renesas Electronics products, or any other party who distributes, disposes of, or otherwise sells or transfers the product to a third party, to notify such third party in advance of the contents and conditions set forth in this document.
11. This document shall not be reprinted, reproduced or duplicated in any form, in whole or in part, without prior written consent of Renesas Electronics.
12. Please contact a Renesas Electronics sales office if you have any questions regarding the information contained in this document or Renesas Electronics products.

(Note1) "Renesas Electronics" as used in this document means Renesas Electronics Corporation and also includes its directly or indirectly controlled subsidiaries.

(Note2) "Renesas Electronics product(s)" means any product developed or manufactured by or for Renesas Electronics.

(Rev.4.0-1 November 2017)

## Corporate Headquarters

TOYOSU FORESIA, 3-2-24 Toyosu,  
Koto-ku, Tokyo 135-0061, Japan  
[www.renesas.com](http://www.renesas.com)

## Trademarks

Renesas and the Renesas logo are trademarks of Renesas Electronics Corporation. All trademarks and registered trademarks are the property of their respective owners.

## Contact information

For further information on a product, technology, the most up-to-date version of a document, or your nearest sales office, please visit:  
[www.renesas.com/contact/](http://www.renesas.com/contact/).