

RX Family

Simple I²C Module Using Firmware Integration Technology

Introduction

This application note describes the simple I²C module using firmware integration technology (FIT) for communications between devices using the serial communications interface (SCI).

Target Device

This API supports the following device.

- RX110, RX111, RX113 Groups
- RX130, RX13T Groups
- RX140 Groups
- RX230, RX231, RX23E-A, RX23E-B, RX23T, RX23W Groups
- RX24T, RX24U Groups
- RX260, RX261, RX26T Groups
- RX64M Group
- RX65N, RX651 Groups
- RX660 Group
- RX66T Group
- RX66N Group
- RX671 Group
- RX71M Group
- RX72T Group
- RX72M Group
- RX72N Group

When using this application note with other Renesas MCUs, careful evaluation is recommended after making modifications to comply with the alternate MCU.

Target Compilers

- Renesas Electronics C/C++ Compiler Package for RX Family
- GCC for Renesas RX
- IAR C/C++ Compiler for Renesas RX

For details of the confirmed operation contents of each compiler, refer to "6.3 Operating Test Environment".

Contents

1. Overview.....	4
1.1 SCI Simple I ² C Mode FIT Module.....	4
1.2 Outline of the API.....	4
1.3 Overview of SCI Simple I ² C Mode FIT Module.....	5
1.3.1 Specifications of SCI Simple I ² C Mode FIT Module.....	5
1.3.2 Master Transmission.....	6
1.3.3 Master Reception.....	10
1.3.4 State Transition.....	13
1.3.5 Flags when Transitioning States.....	14
1.4 Using SCI Simple I ² C Mode FIT Module.....	14
1.4.1 Using SCI Simple I ² C Mode FIT Module in C++ project.....	14
2. API Information.....	15
2.1 Hardware Requirements.....	15
2.2 Software Requirements.....	15
2.3 Supported Toolchains.....	15
2.4 Usage of Interrupt Vector.....	15
2.5 Header Files.....	22
2.6 Integer Types.....	22
2.7 Configuration Overview.....	23
2.8 Code Size.....	27
2.9 Parameters.....	28
2.10 Return Values.....	28
2.11 Adding the FIT Module to Your Project.....	29
2.12 “for”, “while” and “do while” statements.....	30
3. API Functions.....	31
R_SCI_IIC_Open().....	31
R_SCI_IIC_MasterSend().....	33
R_SCI_IIC_MasterReceive().....	39
R_SCI_IIC_Close().....	43
R_SCI_IIC_GetStatus().....	45
R_SCI_IIC_Control().....	47
R_SCI_IIC_GetVersion().....	49
4. Pin Settings.....	50
5. Demo Projects.....	53
5.1 sciiic_send_demo_rskrx64m, sciiic_send_demo_rskrx64m_gcc.....	53
5.2 sciiic_receive_demo_rskrx64m, sciiic_receive_demo_rskrx64m_gcc.....	53
5.3 sciiic_send_demo_rskrx231, sciiic_send_demo_rskrx231_gcc.....	53
5.4 sciiic_receive_demo_rskrx231, sciiic_receive_demo_rskrx231_gcc.....	54
5.5 sciiic_send_demo_rskrx671, sciiic_send_demo_rskrx671_gcc.....	54
5.6 sciiic_receive_demo_rskrx671, sciiic_receive_demo_rskrx671_gcc.....	54
5.7 sciiic_send_demo_rskrx72n, sciiic_send_demo_rskrx72n_gcc.....	54
5.8 sciiic_receive_demo_rskrx72n, sciiic_receive_demo_rskrx72n_gcc.....	54

5.9	Adding a Demo to a Workspace	54
5.10	Downloading Demo Projects.....	55
6.	Appendices.....	56
6.1	Communication Method	56
6.1.1	States for API Operation.....	56
6.1.2	Events During API Operation	56
6.1.3	Protocol State Transitions.....	57
6.1.4	Protocol State Transition Table	61
6.1.5	Functions Used on Protocol State Transitions	61
6.1.6	Flag States on State Transitions	62
6.2	Interrupt Request Generation Timing	64
6.2.1	Master Transmission	64
6.2.2	Master Reception.....	65
6.2.3	Master Transmit/Receive.....	66
6.3	Operating Test Environment.....	67
6.4	Troubleshooting	78
7.	Sample Code.....	79
7.1	Example when Accessing One Slave Device Continuously with One Channel	79
7.2	Example when Accessing Two Slave Devices with One Channel	83
7.3	Example when Accessing Two Slave Devices with Two Channels.....	88
8.	Reference Documents.....	94
	Related Technical Updates	95
	Revision History	96

1. Overview

The simple I²C module using firmware integration technology (SCI simple I²C mode FIT module ⁽¹⁾) provides a method to transmit and receive data between the master and slave devices using the SCI. The SCI simple I²C mode is in compliance with single master mode of the NXP I²C-bus (Inter-IC-Bus) interface.

Note:

1. When the description says “module” in this document, it indicates the SCI simple I²C mode FIT module.

Features supported by this module are as follows:

- Single master mode (slave transmission or slave reception is not supported).
- Bus condition waveform generation
- Communication mode can be standard or fast mode and the maximum communication rate is 384 kbps.

Limitations

- This module cannot be used with the DMAC and the DTC.
- This module does not support transmission with 10-bit address.
- Multiple interrupts are not supported.
- API function calls except for the R_SCI_IIC_GetStatus function are disabled in the callback function.
- The I flag must be set to 1 to use interrupts.
- When using SCI (Simple I²C Mode) FIT Module and SCI Module Firmware Integration Technology (R01AN1815) in combination, the same channel cannot be used at the same time.

1.1 SCI Simple I²C Mode FIT Module

This module is implemented in a project and used as the API. Refer to 2.11 Adding the FIT Module to Your Project for details on implementing the module to the project.

1.2 Outline of the API

Table 1.1 lists the API Functions.

Table 1.1 API Functions

Item	Contents
R_SCI_IIC_Open()	The function initializes the SCI simple I ² C mode FIT module. This function must be called before calling any other API functions.
R_SCI_IIC_MasterSend()	Starts master transmission. Changes the transmit pattern according to the parameters. Operates batched processing until stop condition generation.
R_SCI_IIC_MasterReceive()	Starts master reception. Changes the receive pattern according to the parameters. Operates batched processing until stop condition generation.
R_SCI_IIC_Close()	This function completes the simple I ² C communication and releases the SCI used.
R_SCI_IIC_GetStatus()	Returns the state of this module.
R_SCI_IIC_Control()	This function outputs conditions, Hi-Z from the SSSDA pin, and one-shot of the SSCL clock. Also it resets the settings of this module. This function is mainly used when a communication error occurs.
R_SCI_IIC_GetVersion()	Returns the current version of this module.

1.3 Overview of SCI Simple I²C Mode FIT Module

1.3.1 Specifications of SCI Simple I²C Mode FIT Module

1. This module supports master transmission and reception.
 - There are four transmit patterns that can be used for master transmission. Refer to 1.3.2 for details on master transmission.
 - Master reception and master transmit/receive can be selected for master reception. Refer to 1.3.3 for details on master reception.
2. An interrupt occurs when any of the following operations completes: start condition generation, slave address transmission, data reception, or stop condition generation. In the SCI (simple I²C mode) interrupt handling, the communication control function is called and the operation is continued.
3. The module supports multiple channels. When the device used has multiple channels, simultaneous communication is available using multiple channels.
4. Multiple slave devices on the same channel bus can be controlled. However, while communication is in progress (the period from start condition generation to stop condition generation), communication with other devices is not available. Figure 1.1 shows an Example of Controlling Multiple Slave Devices.

When slave devices A and B are connected to channel 0.

ST: Start condition, SP: Stop condition

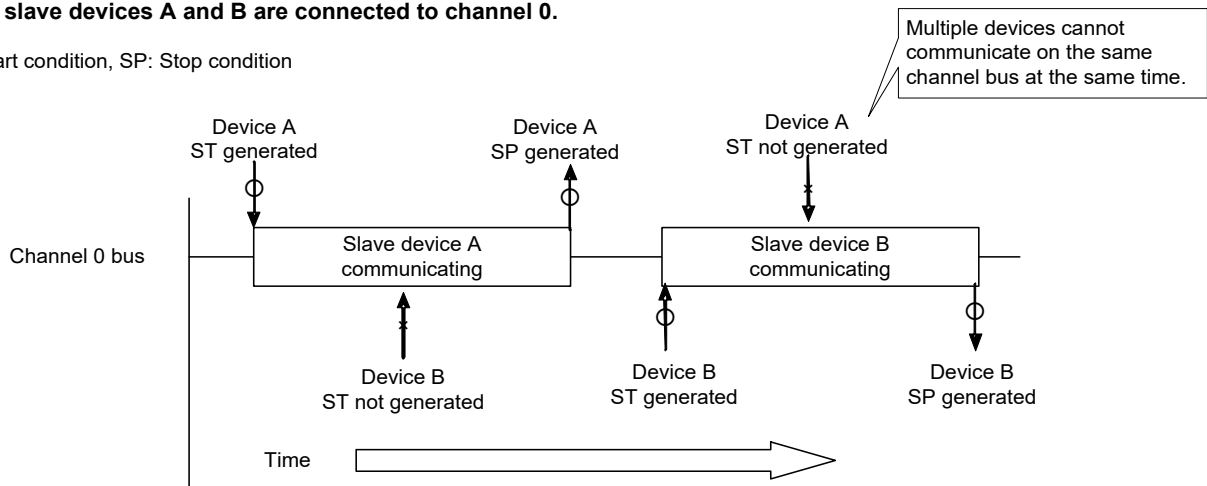

Figure 1.1 Example of Controlling Multiple Slave Devices

1.3.2 Master Transmission

Data is transmitted from the master device (master (RX MCU)) to the slave device (slave).

With this module, four patterns of waveforms can be generated for master transmission. A pattern is selected according to the arguments set in the parameters which are members of the I²C communication information structure. Refer to 2.9 Parameters for details on the I²C communication information structure. Figure 1.2 to Figure 1.5 show the transmit patterns.

(1) Pattern 1

Data is transmitted from the master (RX MCU) to the slave.

A start condition is generated and then the slave address is transmitted. The eighth bit specifies the transfer direction. This bit is set to 0 (write) when transmitting. Then the first data is transmitted. The first data is used when there is data to be transmitted in advance before performing the data transmission. For example, if the slave is an EEPROM, the EEPROM internal address can be transmitted. Next the second data is transmitted. The second data is the data to be written to the slave. When a data transmission has started and all data transmissions have completed, a stop condition is generated, and the bus is released.

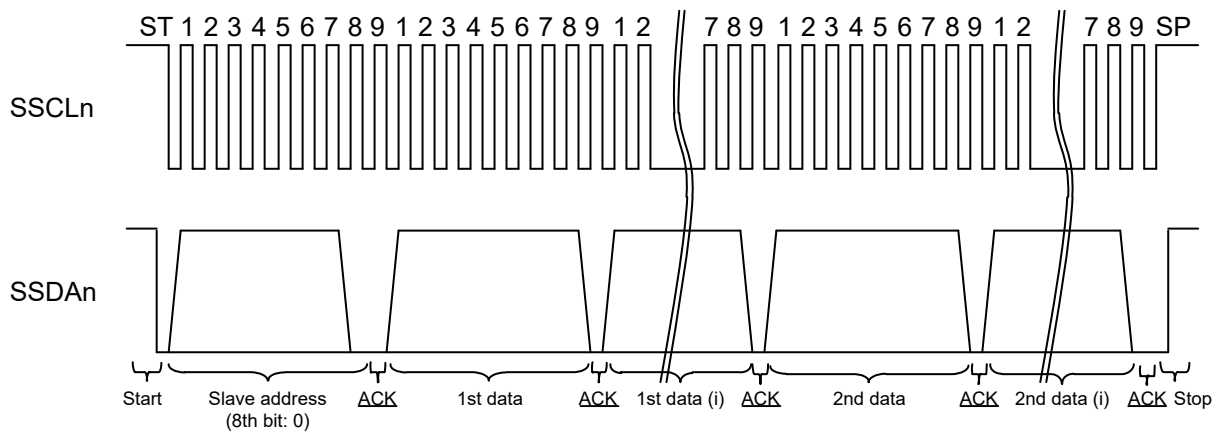

n: Channel number

ST: Start condition generation

SP: Stop condition generation

ACK: Acknowledge: 0

* A signal with an underline indicates data transmission from the slave to the master.

Figure 1.2 Signals for Pattern 1 of Master Transmission

(2) Pattern 2

Data is transmitted from the master (RX MCU) to the slave. However, when the first data is not set, transmission for the first data is not performed.

Operations from start condition generation through to slave address transmission are the same as the operations for pattern 1. Then the second data is transmitted without transmitting the first data. When all data transmissions have completed, a stop condition is generated and the bus is released.

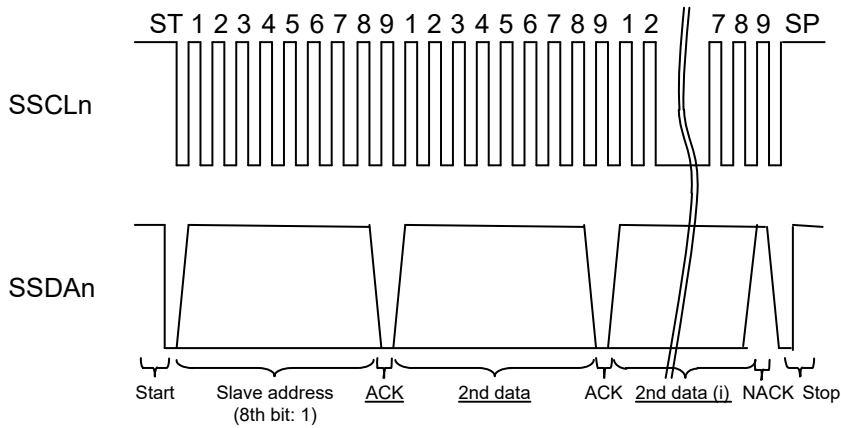

n: Channel number
 ST: Start condition generation
 SP: Stop condition generation
 * A signal with an underline indicates data transmission from the slave to the master.
 NACK: Acknowledge: 1
 ACK: Acknowledge: 0

Figure 1.3 Signals for Pattern 2 of Master Transmission

(3) Pattern 3

Operations from start condition generation through to slave address transmission are the same as the operations for pattern 1. When neither the first data nor the second data are set, data transmission is not performed, then a stop condition is generated, and the bus is released.

This pattern is useful for detecting connected devices or when performing acknowledge polling to verify the EEPROM rewriting state.

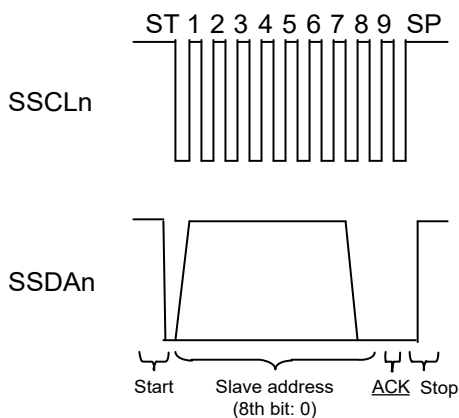

n: Channel number
 ST: Start condition generation
 SP: Stop condition generation
 ACK: Acknowledge: 0
 * A signal with an underline indicates data transmission from the slave to the master.

Figure 1.4 Signals for Pattern 3 of Master Transmission

(4) Pattern 4

After a start condition is generated, when the slave address, first data, and second data are not set, slave address transmission and data transmission are not performed. Then a stop condition is generated and the bus is released.

This pattern is useful for just releasing the bus.

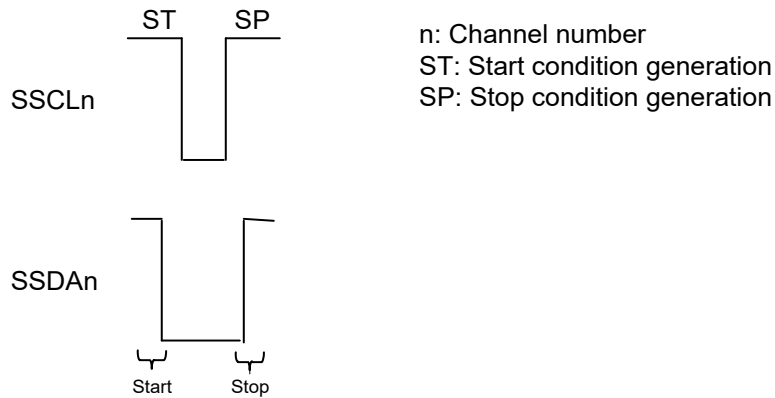

Figure 1.5 Signals for Pattern 4 of Master Transmission

Figure 1.6 shows the procedure of master transmission. The callback function is called after generating a stop condition. Specify the function name in the CallBackFunc of the I²C communication information structure member.

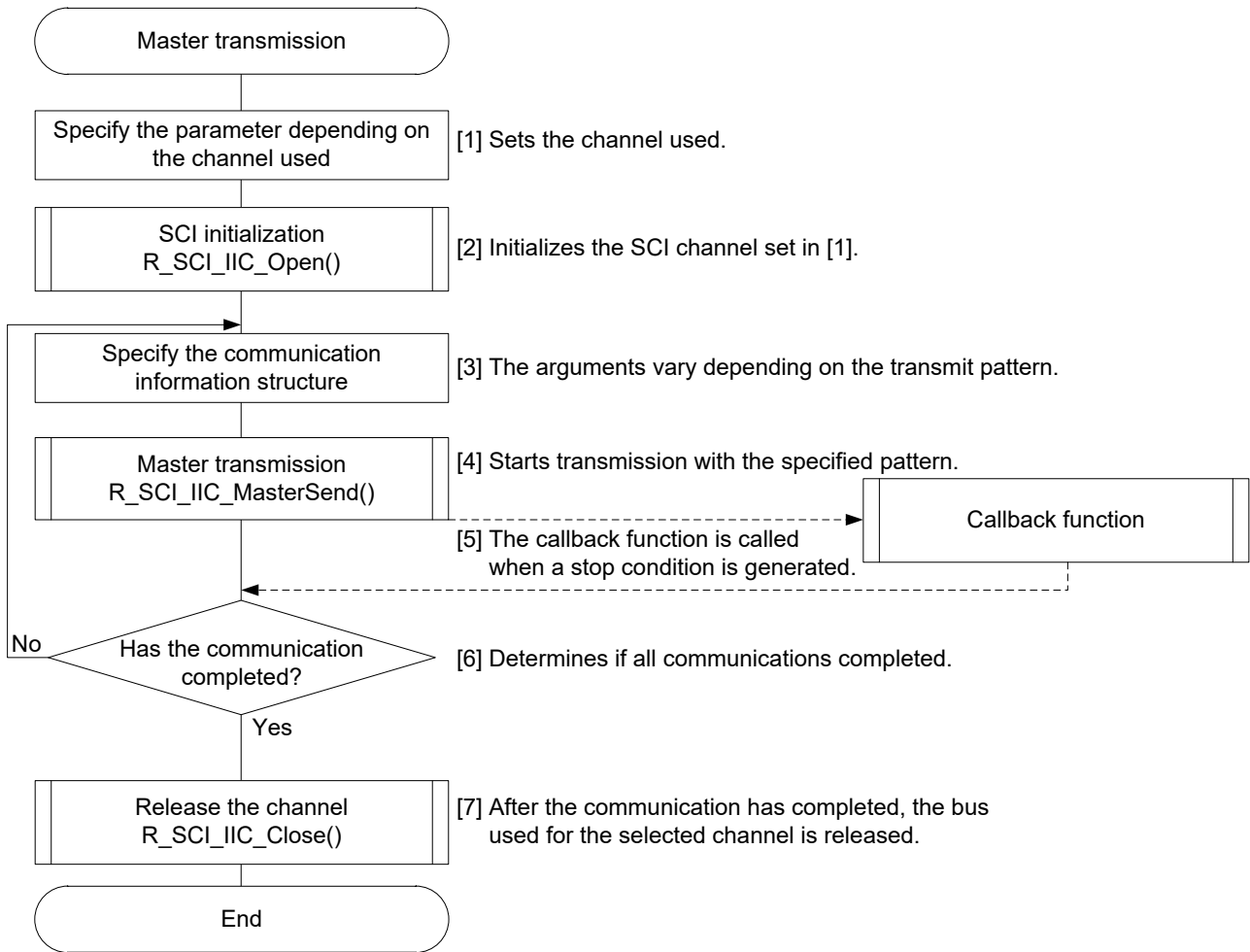

Figure 1.6 Example of Master Transmission

1.3.3 Master Reception

The master (RX MCU) receives data from the slave. This module supports master reception and master transmit/receive. The receive pattern is selected according to the arguments set in the parameters which are members of the I²C communication information structure. Refer to 2.9 Parameters for details on the I²C communication information structure. Figure 1.7 and Figure 1.8 show receive patterns.

(1) Master Reception

The master (RX MCU) receives data from the slave.

A start condition is generated and then the slave address is transmitted. The eighth bit specifies the transfer direction. This bit is set to 1 (read) when receiving. Then data reception starts. An ACK is transmitted each time 1-byte data is received except the last data. A NACK is transmitted when the last data is received to notify the slave that all data receptions have completed. Then a stop condition is generated and the bus is released.



n: Channel number

ST: Start condition generation

SP: Stop condition generation

NACK: Acknowledge: 1

ACK: Acknowledge: 0

* A signal with an underline indicates data transmission from the slave to the master.

Figure 1.7 Signals for Master Reception

(2) Master Transmit/Receive

The master (RX MCU) transmits data to the slave (master transmission). After the transmission completes, a restart condition is generated, the transfer direction is changed to 1 (read), and the master receives data from the slave (master reception).

A start condition is generated and then the slave address is transmitted. The eighth bit is the bit specifies the transfer direction. This bit is set to 0 (write) when transmitting. Then the first data is transmitted. When the data transmission completes, a restart condition is generated and the slave address is transmitted. Then the eighth bit is set to 1 (read) and a data reception starts. An ACK is transmitted each time 1-byte data is received except the last data. A NACK is transmitted when the last data is received to notify the slave that all data receptions have completed. Then a stop condition is generated and the bus is released.

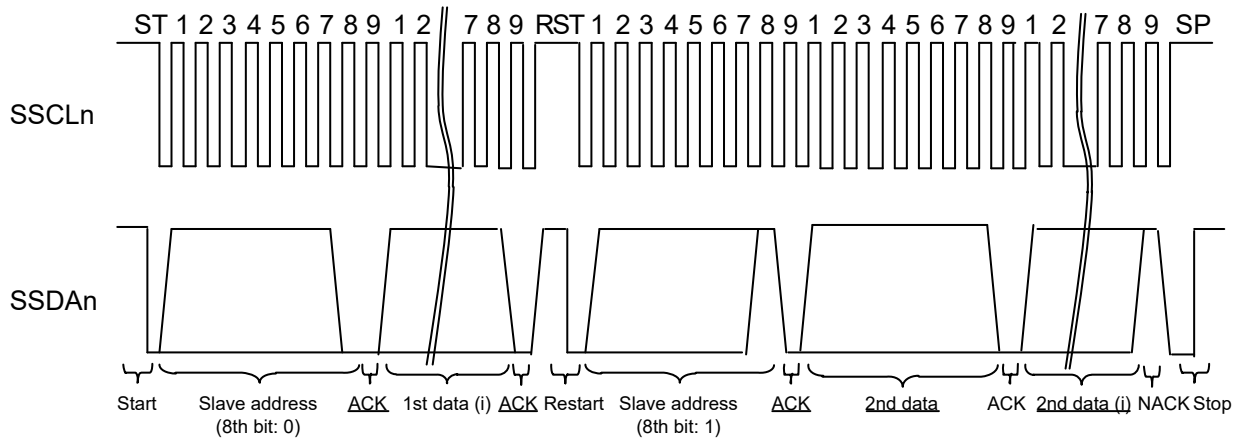

n: Channel number

ST: Start condition generation

NACK: Acknowledge: 1

SP: Stop condition generation

ACK: Acknowledge: 0

RST: Restart condition generation

* A signal with an underline indicates data transmission from the slave to the master.

Figure 1.8 Signals for Master Transmit/Receive

Figure 1.9 shows the procedure of master reception. The callback function is called after generating a stop condition. Specify the function name in the CallbackFunc of the I²C communication information structure member.

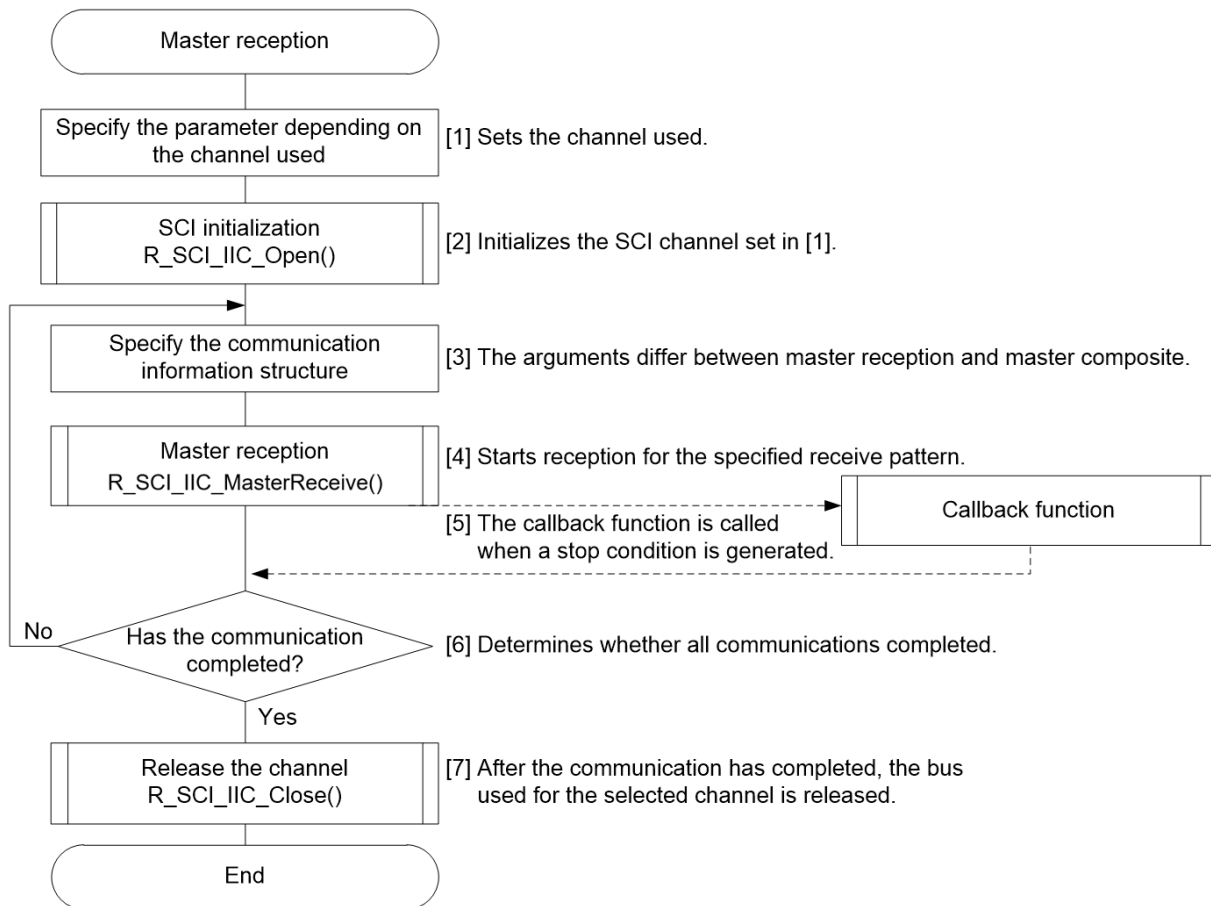

Figure 1.9 Example of Master Reception

1.3.4 State Transition

States entered in this module are uninitialized state, idle state, and communicating state.

Figure 1.10 shows the State Transition Diagram.

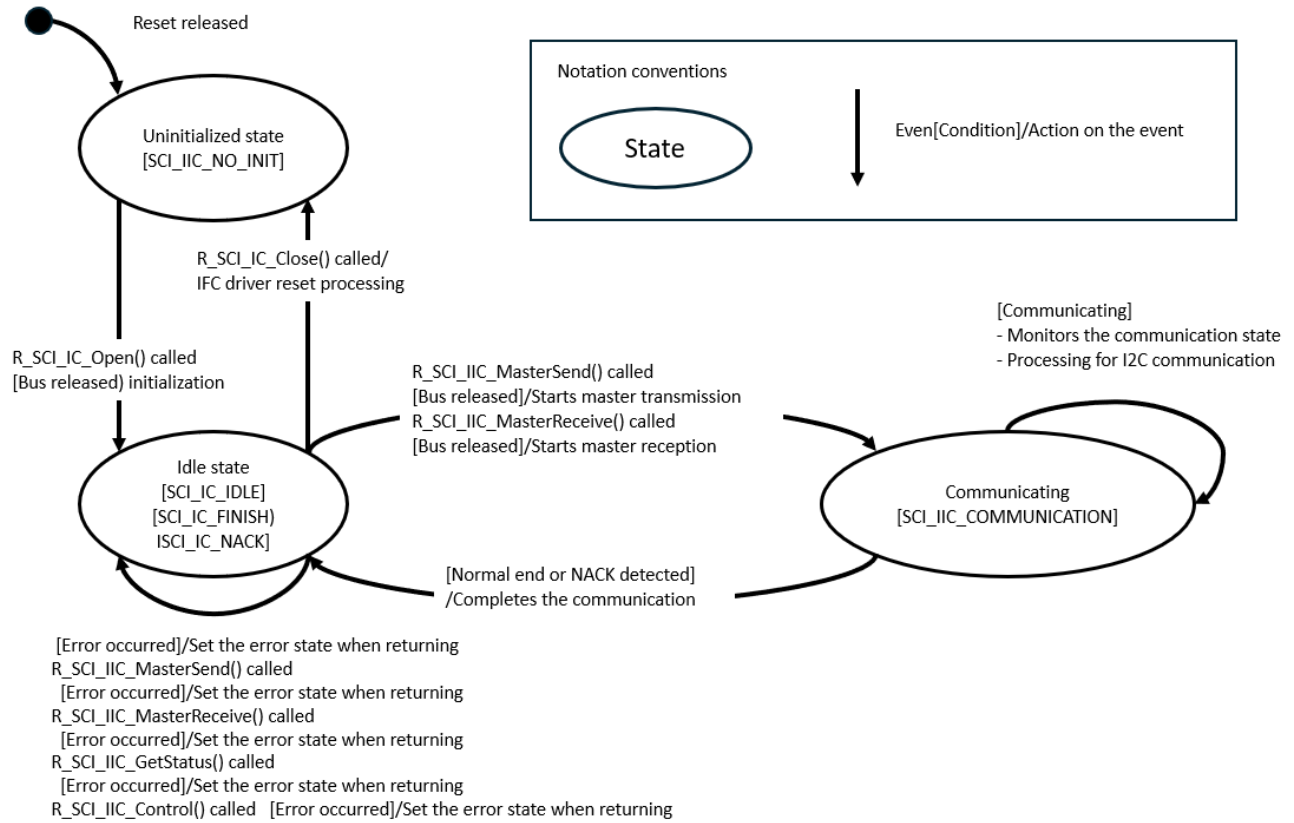

Figure 1.10 State Transition Diagram

1.3.5 Flags when Transitioning States

dev_sts is the device state flag and is one of the I²C communication information structure members. The flag stores the communication state of the device. Using this flag enables controlling multiple slaves on the same channel.

Table 1.2 lists the Device State Flags when Transitioning States.

Table 1.2 Device State Flags when Transitioning States

State	Device State Flag (dev_sts)
Uninitialized state	SCI_IIC_NO_INIT
Idle states	SCI_IIC_IDLE SCI_IIC_FINISH SCI_IIC_NACK
Communicating (master transmission)	SCI_IIC_COMMUNICATION
Communicating (master reception)	SCI_IIC_COMMUNICATION
Communicating (master transmit/receive)	SCI_IIC_COMMUNICATION
Error	SCI_IIC_ERROR

1.4 Using SCI Simple I2C Mode FIT Module

1.4.1 Using SCI Simple I2C Mode FIT Module in C++ project

For C++ project, add SCI Simple I2C Mode FIT module interface header file within extern "C":

```
extern "C"
{
    #include "r_smc_entry.h"
    #include "r_sci_iic_rx_if.h"
}
```

2. API Information

This driver API adheres to the Renesas API naming standards.

2.1 Hardware Requirements

This driver requires your MCU supports the following feature:

- SCI

2.2 Software Requirements

This driver is dependent upon the following packages:

- Board Support Package Module (r_bsp) Rev.5.20 or higher

2.3 Supported Toolchains

This driver has been confirmed to work with the toolchain listed in 6.3 Operating Test Environment for details.

2.4 Usage of Interrupt Vector

The TXI interrupt and TEI interrupt are enabled by execution of R_SCI_IIC_MasterSend function or R_SCI_IIC_MasterReceive function (with specified condition)(while the macro definition SCI_IIC_CFG_CHI_INCLUDE (i = 0 to 12) is 1).

Table 2.1 to Table 2.6 shows the interrupt vectors used by the Simple I²C FIT module.

Table 2.1 List of Usage of Interrupt Vectors - 1 -

Device	Contents
RX110 RX111 RX13T	TXI1 interrupt [channel 1] (vector no.: 220) TEI1 interrupt [channel 1] (vector no.: 221) TXI5 interrupt [channel 5] (vector no.: 224) TEI5 interrupt [channel 5] (vector no.: 225) TXI12 interrupt [channel 12] (vector no.: 240) TEI12 interrupt [channel 12] (vector no.: 241)
RX113 RX130 RX230 RX231 RX23E-B	TXI0 interrupt [channel 0] (vector no.: 216) TEI0 interrupt [channel 0] (vector no.: 217) TXI1 interrupt [channel 1] (vector no.: 220) TEI1 interrupt [channel 1] (vector no.: 221) TXI5 interrupt [channel 5] (vector no.: 224) TEI5 interrupt [channel 5] (vector no.: 225) TXI6 interrupt [channel 6] (vector no.: 228) TEI6 interrupt [channel 6] (vector no.: 229) TXI8 interrupt [channel 8] (vector no.: 232) TEI8 interrupt [channel 8] (vector no.: 233) TXI9 interrupt [channel 9] (vector no.: 236) TEI9 interrupt [channel 9] (vector no.: 237) TXI12 interrupt [channel 12] (vector no.: 240) TEI12 interrupt [channel 12] (vector no.: 241)

RX140	TXI1 interrupt [channel 1] (vector no.: 220) TEI1 interrupt [channel 1] (vector no.: 221) TXI5 interrupt [channel 5] (vector no.: 224) TEI5 interrupt [channel 5] (vector no.: 225) TXI6 interrupt [channel 6] (vector no.: 228) TEI6 interrupt [channel 6] (vector no.: 229) TXI8 interrupt [channel 8] (vector no.: 232) TEI8 interrupt [channel 8] (vector no.: 233) TXI9 interrupt [channel 9] (vector no.: 236) TEI9 interrupt [channel 9] (vector no.: 237) TXI12 interrupt [channel 12] (vector no.: 240) TEI12 interrupt [channel 12] (vector no.: 241)
RX23E-A RX260 RX261	TXI1 interrupt [channel 1] (vector no.: 220) TEI1 interrupt [channel 1] (vector no.: 221) TXI5 interrupt [channel 5] (vector no.: 224) TEI5 interrupt [channel 5] (vector no.: 225) TXI6 interrupt [channel 6] (vector no.: 228) TEI6 interrupt [channel 6] (vector no.: 229) TXI12 interrupt [channel 12] (vector no.: 240) TEI12 interrupt [channel 12] (vector no.: 241)
RX23T	TXI1 interrupt [channel 1] (vector no.: 220) TEI1 interrupt [channel 1] (vector no.: 221) TXI5 interrupt [channel 5] (vector no.: 224) TEI5 interrupt [channel 5] (vector no.: 225)

Table 2.2 List of Usage of Interrupt Vectors - 2 -

Device	Contents
RX23W	TXI1 interrupt [channel 1] (vector no.: 220) TEI1 interrupt [channel 1] (vector no.: 221) TXI5 interrupt [channel 5] (vector no.: 224) TEI5 interrupt [channel 5] (vector no.: 225) TXI8 interrupt [channel 8] (vector no.: 232) TEI8 interrupt [channel 8] (vector no.: 233) TXI12 interrupt [channel 12] (vector no.: 240) TEI12 interrupt [channel 12] (vector no.: 241)
RX24T	TXI1 interrupt [channel 1] (vector no.: 220) TEI1 interrupt [channel 1] (vector no.: 221) TXI5 interrupt [channel 5] (vector no.: 224) TEI5 interrupt [channel 5] (vector no.: 225) TXI6 interrupt [channel 6] (vector no.: 228) TEI6 interrupt [channel 6] (vector no.: 229)
RX24U	TXI1 interrupt [channel 1] (vector no.: 220) TEI1 interrupt [channel 1] (vector no.: 221) TXI5 interrupt [channel 5] (vector no.: 224) TEI5 interrupt [channel 5] (vector no.: 225) TXI6 interrupt [channel 6] (vector no.: 228) TEI6 interrupt [channel 6] (vector no.: 229) TXI8 interrupt [channel 8] (vector no.: 232) TEI8 interrupt [channel 8] (vector no.: 233) TXI9 interrupt [channel 9] (vector no.: 236) TEI9 interrupt [channel 9] (vector no.: 237) TXI11 interrupt [channel 11] (vector no.: 252) TEI11 interrupt [channel 11] (vector no.: 253)
RX64M RX71M	TXI0 interrupt [channel 0] (vector no.: 59) TXI1 interrupt [channel 1] (vector no.: 61) TXI2 interrupt [channel 2] (vector no.: 63) TXI3 interrupt [channel 3] (vector no.: 81) TXI4 interrupt [channel 4] (vector no.: 83) TXI5 interrupt [channel 5] (vector no.: 85) TXI6 interrupt [channel 6] (vector no.: 87) TXI7 interrupt [channel 7] (vector no.: 99) TXI12 interrupt [channel 12] (vector no.: 117) GROUPBL0 interrupt (vector no.: 110) <ul style="list-style-type: none"> • TEI0 interrupt [channel 0] (group interrupt source no.: 0) • TEI1 interrupt [channel 1] (group interrupt source no.: 2) • TEI2 interrupt [channel 2] (group interrupt source no.: 4) • TEI3 interrupt [channel 3] (group interrupt source no.: 6) • TEI4 interrupt [channel 4] (group interrupt source no.: 8) • TEI5 interrupt [channel 5] (group interrupt source no.: 10) • TEI6 interrupt [channel 6] (group interrupt source no.: 12) • TEI7 interrupt [channel 7] (group interrupt source no.: 14) • TEI12 interrupt [channel 12] (group interrupt source no.: 16)

Table 2.3 List of Usage of Interrupt Vectors - 3 -

Device	Contents
RX65N RX651 RX660 RX671	TXI0 interrupt [channel 0] (vector no.: 59) TXI1 interrupt [channel 1] (vector no.: 61) TXI2 interrupt [channel 2] (vector no.: 63) TXI3 interrupt [channel 3] (vector no.: 81) TXI4 interrupt [channel 4] (vector no.: 83) TXI5 interrupt [channel 5] (vector no.: 85) TXI6 interrupt [channel 6] (vector no.: 87) TXI7 interrupt [channel 7] (vector no.: 99) TXI8 interrupt [channel 8] (vector no.: 101) TXI9 interrupt [channel 9] (vector no.: 103) TXI10 interrupt [channel 10] (vector no.: 105) TXI11 interrupt [channel 11] (vector no.: 115) TXI12 interrupt [channel 12] (vector no.: 117) GROUPBL0 interrupt (vector no.: 110) <ul style="list-style-type: none"> • TEI0 interrupt [channel 0] (group interrupt source no.: 0) • TEI1 interrupt [channel 1] (group interrupt source no.: 2) • TEI2 interrupt [channel 2] (group interrupt source no.: 4) • TEI3 interrupt [channel 3] (group interrupt source no.: 6) • TEI4 interrupt [channel 4] (group interrupt source no.: 8) • TEI5 interrupt [channel 5] (group interrupt source no.: 10) • TEI6 interrupt [channel 6] (group interrupt source no.: 12) • TEI7 interrupt [channel 7] (group interrupt source no.: 14) • TEI12 interrupt [channel 12] (group interrupt source no.: 16) GROUPBL1 interrupt (vector no.: 111) <ul style="list-style-type: none"> • TEI8 interrupt [channel 8] (group interrupt source no.: 24) • TEI9 interrupt [channel 9] (group interrupt source no.: 26) GROUPAL0 interrupt (vector no.: 112) <ul style="list-style-type: none"> • TEI10 interrupt [channel 10] (group interrupt source no.: 8) • TEI11 interrupt [channel 11] (group interrupt source no.: 12)

Table 2.4 List of Usage of Interrupt Vectors - 4 -

Device	Contents
RX66T RX72T	TXI1 interrupt [channel 1] (vector no.: 61) TXI5 interrupt [channel 5] (vector no.: 85) TXI6 interrupt [channel 6] (vector no.: 87) TXI8 interrupt [channel 8] (vector no.: 101) TXI9 interrupt [channel 9] (vector no.: 103) TXI11 interrupt [channel 11] (vector no.: 115) TXI12 interrupt [channel 12] (vector no.: 117) GROUPBL0 interrupt (vector no.: 110) <ul style="list-style-type: none"> • TEI1 interrupt [channel 1] (group interrupt source no.: 2) • TEI5 interrupt [channel 5] (group interrupt source no.: 10) • TEI6 interrupt [channel 6] (group interrupt source no.: 12) • TEI12 interrupt [channel 12] (group interrupt source no.: 16) GROUPBL1 interrupt (vector no.: 111) <ul style="list-style-type: none"> • TEI8 interrupt [channel 8] (group interrupt source no.: 24) • TEI9 interrupt [channel 9] (group interrupt source no.: 26) GROUPAL0 interrupt (vector no.: 112) <ul style="list-style-type: none"> • TEI11 interrupt [channel 11] (group interrupt source no.: 12)

Table 2.5 List of Usage of Interrupt Vectors - 5 -

Device	Contents
RX66N RX72M RX72N	<p>TXI0 interrupt [channel 0] (vector no.: 59)</p> <p>TXI1 interrupt [channel 1] (vector no.: 61)</p> <p>TXI2 interrupt [channel 2] (vector no.: 63)</p> <p>TXI3 interrupt [channel 3] (vector no.: 81)</p> <p>TXI4 interrupt [channel 4] (vector no.: 83)</p> <p>TXI5 interrupt [channel 5] (vector no.: 85)</p> <p>TXI6 interrupt [channel 6] (vector no.: 87)</p> <p>TXI7 interrupt [channel 7] (vector no.: 99)</p> <p>TXI8 interrupt [channel 8] (vector no.: 101)</p> <p>TXI9 interrupt [channel 9] (vector no.: 103)</p> <p>TXI10 interrupt [channel 10] (vector no.: 105)</p> <p>TXI11 interrupt [channel 11] (vector no.: 115)</p> <p>TXI12 interrupt [channel 12] (vector no.: 117)</p> <p>GROUPBL0 interrupt (vector no.: 110)</p> <ul style="list-style-type: none"> • TEI0 interrupt [channel 0] (group interrupt source no.: 0) • TEI1 interrupt [channel 1] (group interrupt source no.: 2) • TEI2 interrupt [channel 2] (group interrupt source no.: 4) • TEI3 interrupt [channel 3] (group interrupt source no.: 6) • TEI4 interrupt [channel 4] (group interrupt source no.: 8) • TEI5 interrupt [channel 5] (group interrupt source no.: 10) • TEI6 interrupt [channel 6] (group interrupt source no.: 12) • TEI12 interrupt [channel 12] (group interrupt source no.: 16) <p>GROUPAL0 interrupt (vector no.: 112)</p> <ul style="list-style-type: none"> • TEI7 interrupt [channel 7] (group interrupt source no.: 14) • TEI8 interrupt [channel 8] (group interrupt source no.: 24) • TEI9 interrupt [channel 9] (group interrupt source no.: 26) • TEI10 interrupt [channel 10] (group interrupt source no.: 8) • TEI11 interrupt [channel 11] (group interrupt source no.: 12)

Table 2.6 List of Usage of Interrupt Vectors - 6 -

Device	Contents
RX26T	TXI1 interrupt [channel 1] (vector no.: 61) TXI5 interrupt [channel 5] (vector no.: 85) TXI6 interrupt [channel 6] (vector no.: 87) TXI12 interrupt [channel 12] (vector no.: 117) GROUPBL0 interrupt (vector no.: 110) <ul style="list-style-type: none">• TEI1 interrupt [channel 1] (group interrupt source no.: 2)• TEI5 interrupt [channel 5] (group interrupt source no.: 10)• TEI6 interrupt [channel 6] (group interrupt source no.: 12)• TEI12 interrupt [channel 12] (group interrupt source no.: 16)

2.5 Header Files

All API calls and their supporting interface definitions are located in `r_sci_iic_rx_if.h`.

2.6 Integer Types

This project uses ANSI C99. These types are defined in `stdint.h`.

2.7 Configuration Overview

The configuration options in this module are specified in `r_sci_iic_rx_config.h` and `r_sci_iic_rx_pin_config.h`. The option names and setting values are listed in the table below.

Configuration options in <code>r_sci_iic_rx_config.h</code> (1/2)	
SCI_IIC_CFG_PARAM_CHECKING_ENABLE - Default value = 1	Selectable whether to include parameter checking in the code. - When this is set to 0, parameter checking is omitted. - When this is set to 1, parameter checking is included.
SCI_IIC_CFG_CHi_INCLUDED <i>i</i> = 0 to 12 - When <i>i</i> = 0 to 12, the default value = 0	Selectable whether to use available channels. - When this is set to 0, relevant processes for the channel are omitted from the code. - When this is set to 1, relevant processes for the channel are included in the code. To use a channel, please change the definition value of the channel to be used to 1.
SCI_IIC_CFG_CHi_BITRATE_BPS <i>i</i> = 0 to 12 - Default value = 384000 for all	Specifies the bit rate. Specify a value less than or equal to 384000 (384 kbit/sec.). The bit rate setting should be based on this definition value and the clock setting definition value specified by RX Family Board Support Package Module (BSP FIT module). Depending on the target device to be used and the BSP FIT module clock setting, the actual bit rate may differ from the expected bit rate.
SCI_IIC_CFG_CHi_INT_PRIORITY <i>i</i> = 0 to 12 - Default value = 2 for all	Specifies interrupt priority levels for condition generation, receive-data-full, transmit-data-empty, and transmit-end interrupts. Specify the level between 1 and 15.
SCI_IIC_CFG_CHi_DIGITAL_FILTER <i>i</i> = 0 to 12 - Default value = 1 for all	Selectable whether to use the noise cancellation function for the SSCL and SSSDA input signals. - When this is set to 0, the noise cancellation function is disabled. - When this is set to 1, the noise cancellation function is enabled.
SCI_IIC_CFG_CHi_FILTER_CLOCK <i>i</i> = 0 to 12 - Default value = 1 for all	Select the sampling clock used for digital noise filter. - When this is set to 1, the clock divided by 1 is used. - When this is set to 2, the clock divided by 2 is used. - When this is set to 3, the clock divided by 4 is used. - When this is set to 4, the clock divided by 8 is used.
SCI_IIC_CFG_CHi_SSDA_DELAY_SELECT <i>i</i> = 0 to 12 - Default value = 18 for all	Select the delay time for output on the SSSDA pin relative to the falling edge of the output on the SSCL pin. Specify the delay between 1 and 31. The default value is a value based on PCLK which operates in 60 MHz and is the clock source of the on-chip baud rate generator. The SSSDA delay time is increased or decreased according to the clock source of the on-chip baud rate generator. When the bit rate or the PCLK frequency is set to low speed, the SSSDA falling timing may occur after the SSCL falling timing in the start condition. Confirm and set an appropriate value depending on the user system.

Configuration options in <i>r_sci_iic_rx_config.h</i> (2/2)	
<pre> SCI_IIC_CFG_BUS_CHECK_COUNTER i = 0 to 12 - Default value = 1000 </pre>	<p>Specifies the timeout counter (number of times to perform bus checking) when the simple I²C API function performs bus checking.</p> <p>Specify a value less than or equal to 0xFFFFFFFF.</p> <p>The bus checking is performed after generating each condition using the simple I²C control function (R_SCI_IIC_Control function).</p> <p>With the bus checking, the timeout counter is decremented after generating each condition. When the counter reaches 0, the API determines that a timeout has occurred and returns an error (Busy) as the return value.</p> <p>* The timeout counter is used for the bus not to be locked by the bus lock or others. Therefore specify the value greater than or equal to the time for that the other device holds the SCL pin low.</p> <p>Setting time for the timeout (ns) $\approx \left(\frac{1}{f_{CLK}} \text{ (Hz)}\right) \times \text{counter value} \times 10$</p>
<pre> SCI_IIC_CFG_PORT_SETTING_PROCESSING - Default value = 1 </pre>	<p>Specifies whether to include processing for port setting (*) in the code.</p> <p>* Processing for port setting is the setting to use ports selected by R_SCI_IIC_CFG_SCLi_SSCLi_PORT, R_SCI_IIC_CFG_SCLi_SSCLi_BIT, R_SCI_IIC_CFG_SCLi_SSDAi_PORT, and R_SCI_IIC_CFG_SCLi_SSDAi_BIT as pins SSCL and SSDA.</p> <ul style="list-style-type: none"> - When this is set to 0, processing for port setting is omitted from the code. - When this is set to 1, processing for port setting is included in the code. - When you assume this setting 0, please set four definitions mentioned above.

Configuration options in *r_sci_iic_rx_pin_config.h* (1/2)

<pre>R_SCI_IIC_CFG_SCIi_SSCLi_PORT i = 0 to 12 - When i = 0, the default value = '2' - When i = 1, the default value = '1' - When i = 2, the default value = '5' - When i = 3, the default value = '2' - When i = 4, the default value = 'B' - When i = 5, the default value = 'B' - When i = 6, the default value = 'B' - When i = 7, the default value = '9' - When i = 8, the default value = 'C' - When i = 9, the default value = 'B' - When i = 10, the default value = '8' - When i = 11, the default value = '7' - When i = 12, the default value = 'E'</pre>	<p>Selects port groups used as the SSCL pins. Specify the value as an ASCII code in the range '0' to 'K'.</p>
<pre>R_SCI_IIC_CFG_SCIi_SSCLi_BIT i = 0 to 12 - When i = 0, the default value = '1' - When i = 1, the default value = '5' - When i = 2, the default value = '2' - When i = 3, the default value = '5' - When i = 4, the default value = '0' - When i = 5, the default value = '1' - When i = 6, the default value = '1' - When i = 7, the default value = '2' - When i = 8, the default value = '6' - When i = 9, the default value = '6' - When i = 10, the default value = '1' - When i = 11, the default value = '6' - When i = 12, the default value = '2'</pre>	<p>Selects pins used as the SSCL pins. Specify the value as an ASCII code in the range '0' to '7'.</p>
<pre>R_SCI_IIC_CFG_SCIi_SSDAi_PORT i = 0 to 12 - When i = 0, the default value = '2' - When i = 1, the default value = '1' - When i = 2, the default value = '5' - When i = 3, the default value = '2' - When i = 4, the default value = 'B' - When i = 5, the default value = 'B' - When i = 6, the default value = 'B' - When i = 7, the default value = '9' - When i = 8, the default value = 'C' - When i = 9, the default value = 'B' - When i = 10, the default value = '8' - When i = 11, the default value = '7' - When i = 12, the default value = 'E'</pre>	<p>Selects port groups used as the SSDA pin. Specify the value as an ASCII code in the range '0' to 'K'.</p>

Configuration options in *r_sci_iic_rx_pin_config.h* (2/2)

R_SCI_IIC_CFG_SCIi_SSDAi_BIT

i = 0 to 12

- When i = 0, the default value = '0'
- When i = 1, the default value = '6'
- When i = 2, the default value = '0'
- When i = 3, the default value = '3'
- When i = 4, the default value = '1'
- When i = 5, the default value = '2'
- When i = 6, the default value = '2'
- When i = 7, the default value = '0'
- When i = 8, the default value = '7'
- When i = 9, the default value = '7'
- When i = 10, the default value = '2'
- When i = 11, the default value = '7'
- When i = 12, the default value = '1'

Selects port groups used as the SSDA pin.
Specify the value as an ASCII code in the range
'0' to '7'.

2.8 Code Size

Typical code sizes associated with this module are listed below. Information is listed for a single representative device of the RX100 Series, RX200 Series, and RX600 Series, respectively.

The ROM (code and constants) and RAM (global data) sizes are determined by the build-time configuration options described in 2.7 Configuration Overview. The table lists reference values when the C compiler's compile options are set to their default values, as described in 2.3, Supported Toolchains. The compile option default values are optimization level: 2, optimization type: for size, and data endianness: little-endian. The code size varies depending on the C compiler version and compile options.

The values in the table below are confirmed under the following conditions.

Module Revision: r_sci_iic_rx rev2.80

Compiler Version: Renesas Electronics C/C++ Compiler Package for RX Family V3.06.00

(The option of “-lang = c99” is added to the default settings of the integrated development environment.)

GCC for Renesas RX 8.03.00.202405

(The option of “-std=gnu99” is added to the default settings of the integrated development environment.)

IAR C/C++ Compiler for Renesas RX version 5.10.01

(The default settings of the integrated development environment.)

Configuration Options: Default settings

ROM, RAM and Stack Memory Usage								
Device	Category		Memory Used					
			Renesas Compiler		GCC		IAR Compiler	
			With Parameter Checking	Without Parameter Checking	With Parameter Checking	Without Parameter Checking	With Parameter Checking	Without Parameter Checking
RX130	ROM	1 channel used	5442 bytes	5235 bytes	4196 bytes	4028 bytes	7404 bytes	7152 bytes
		2 channels used	5611 bytes	5408 bytes	4260 bytes	4092 bytes	7537 bytes	7285 bytes
	RAM	1 channel used	49 bytes		44 bytes		28 bytes	
		2 channels used	77 bytes		72 bytes		44 bytes	
	STACK *1	48 bytes		-		444 bytes		
RX231	ROM	1 channel used	4449 bytes	4322 bytes	4100 bytes	3932 bytes	6516 bytes	6266 bytes
		2 channels used	4618 bytes	4491 bytes	4164 bytes	3996 bytes	6649 bytes	6399 bytes
	RAM	1 channel used	41 bytes		44 bytes		28 bytes	
		2 channels used	69 bytes		72 bytes		44 bytes	
	STACK *1	48 bytes		-		452 bytes		
RX64M	ROM	1 channel used	4484 bytes	4357 bytes	4524 bytes	4364 bytes	6552 bytes	6338 bytes
		2 channels used	4653 bytes	4526 bytes	4620 bytes	4460 bytes	6681 bytes	6475 bytes
	RAM	1 channel used	41 bytes		44 bytes		32 bytes	
		2 channels used	69 bytes		72 bytes		48 bytes	
	STACK *1	48 bytes		-		452 bytes		

Note 1. The sizes of maximum usage stack of Interrupts functions is included.

2.9 Parameters

This section describes the structure whose members are API parameters. This structure is located in `r_sci_iic_rx_if.h` as are the prototype declarations of API functions.

The contents of the structure are referred and updated during communication. Do not rewrite the structure during communication (SCI_IIC_COMMUNICATION).

```
typedef struct
{
    uint8_t rsv2; /* Reserved area */
    uint8_t rsv1; /* Reserved area */
    sci_iic_ch_dev_status_t dev_sts; /* Device state flag */
    uint8_t ch_no; /* Channel number for the device used */
    sci_iic_callback callbackfunc; /* Callback function */
    uint32_t cnt2nd; /* Second data counter (number of bytes) */
    uint32_t cnt1st; /* First data counter (number of bytes) */
    uint8_t * p_data2nd; /* Pointer to the buffer to store the second data */
    uint8_t * p_data1st; /* Pointer to the buffer to store the first data */
    uint8_t * p_slv_adr; /* Pointer to the buffer to store the slave address */
} sci_iic_info_t;
```

2.10 Return Values

This section describes return values of API functions. This enumeration is located in `r_sci_iic_rx_if.h` as are the prototype declarations of API functions.

```
typedef enum /* Simple I2C-bus API state codes */
{
    SCI_IIC_SUCCESS, /* Processing completed successfully */
    SCI_IIC_ERR_LOCK_FUNC, /* Multiple calls occurred on the same channel. */
    SCI_IIC_ERR_INVALID_CHAN, /* Nonexistent channel */
    SCI_IIC_ERR_INVALID_ARG, /* Invalid parameter */
    SCI_IIC_ERR_NO_INIT, /* Uninitialized state */
    SCI_IIC_ERR_BUS_BUSY, /* Bus is busy. This state occurs with the following cases: */
    /* The initialization function or a start function is */
    /* called during communication. */
    /* A start function or advance function is called while */
    /* another device on the same channel is communicating. */
    SCI_IIC_ERR_OTHER /* Other error */
} sci_iic_return_t;
```

2.11 Adding the FIT Module to Your Project

This module must be added to each project in which it is used. Renesas recommends the method using the Smart Configurator described in (1) or (2) or (4) below. However, the Smart Configurator only supports some RX devices. Please use the methods of (3) for RX devices that are not supported by the Smart Configurator.

- (1) Adding the FIT module to your project using the Smart Configurator in e² studio
By using the Smart Configurator in e² studio, the FIT module is automatically added to your project. Refer to “RX Smart Configurator User’s Guide: e² studio (R20AN0451)” for details.
- (2) Adding the FIT module to your project using the Smart Configurator in CS+
By using the Smart Configurator Standalone version in CS+, the FIT module is automatically added to your project. Refer to “RX Smart Configurator User’s Guide: CS+ (R20AN0470)” for details.
- (3) Adding the FIT module to your project in CS+
In CS+, please manually add the FIT module to your project. Refer to “RX Family Adding Firmware Integration Technology Modules to CS+ Projects (R01AN1826)” for details.
- (4) Adding the FIT module to your project using the Smart Configurator in IAREW
By using the Smart Configurator Standalone version, the FIT module is automatically added to your project. Refer to “RX Smart Configurator User’s Guide: IAREW (R20AN0535)” for details.

2.12 “for”, “while” and “do while” statements

In this module, “for”, “while” and “do while” statements (loop processing) are used in processing to wait for register to be reflected and so on. For these loop processing, comments with “WAIT_LOOP” as a keyword are described. Therefore, if user incorporates fail-safe processing into loop processing, user can search the corresponding processing with “WAIT_LOOP”.

The following shows example of description.

while statement example :

```
/* WAIT LOOP */
while(0 == SYSTEM.OSCOVFSR.BIT.PLOVF)
{
    /* The delay period needed is to make sure that the PLL has stabilized. */
}
```

for statement example :

```
/* Initialize reference counters to 0. */
/* WAIT LOOP */
for (i = 0; i < BSP_REG_PROTECT_TOTAL_ITEMS; i++)
{
    g_protect_counters[i] = 0;
}
```

do while statement example :

```
/* Reset completion waiting */
do
{
    reg = phy_read(ether_channel, PHY_REG_CONTROL);
    count++;
} while ((reg & PHY_CONTROL_RESET) && (count < ETHER_CFG_PHY_DELAY_RESET)); /* WAIT_LOOP */
```

3. API Functions

R_SCI_IIC_Open()

The function initializes the simple I²C FIT module. This function must be called before calling any other API functions.

Format

```
sci_iic_return_t R_SCI_IIC_Open(
    sci_iic_info_t * p_sci_iic_info /* Structure data */
)
```

Parameters

** p_sci_iic_info*

This is the pointer to the I²C communication information structure.

Only the member of the structure used in this function is described here. Refer to 2.9 Parameters for details on the structure.

The contents of the structure are referred and updated during communication. Do not rewrite the structure during communication (SCI_IIC_COMMUNICATION).

For the parameter which has '(to be updated)' in the comment below, the argument for the parameter will be updated during the API execution.

```
sci_iic_ch_dev_status_t dev_sts; /* Device state flag (to be updated) */
uint8_t ch_no; /* Channel number */
```

Return Values

```
SCI_IIC_SUCCESS /* Processing completed successfully */
SCI_IIC_ERR_LOCK_FUNC /* The API is locked by the other task. */
SCI_IIC_ERR_INVALID_CHAN /* Nonexistent channel */
SCI_IIC_ERR_INVALID_ARG /* Invalid parameter */
SCI_IIC_ERR_OTHER /* The event occurred is invalid in the current state. */
```

Properties

Prototyped in r_sci_iic_rx_if.h.

Description

Performs the initialization to start the simple I²C-bus communication. Sets the SCI channel specified by the parameter. If the state of the channel is 'uninitialized (SCI_IIC_NO_INIT)', the following processes are performed.

- Setting the state flag
- Setting I/O ports
- Allocating I²C output ports
- Cancelling SCI module-stop state
- Initializing variables used by the API
- Initializing the SCI registers used for the simple I²C-bus communication
- Disabling the SCI interrupt

The bit rate set in initial setting to start simple I²C-bus communication.

The bit rate is set based on the setting value of "2.7 Configuration Overview" and the clock setting definition value specified by BSP FIT module.

Example

```
volatile sci_iic_return_t ret;
sci_iic_info_t          siic_info;

siic_info.dev_sts = SCI_IIC_NO_INIT;
siic_info.ch_no = 1;

ret = R_SCI_IIC_Open(&siic_info);
```

Special Notes

None

R_SCI_IIC_MasterSend()

Starts master transmission. Changes the transmit pattern according to the parameters. Operates batched processing until stop condition generation.

Format

```
sci_iic_return_t R_SCI_IIC_MasterSend(
    sci_iic_info_t * p_sci_iic_info /* Structure data */
)
```

Parameters

** p_sci_iic_info*

This is the pointer to the I²C communication information structure. The transmit patterns can be selected from four patterns by the parameter. Refer to the Special Notes in this section for available settings and the setting values for each transmit pattern. Also refer to 1.3.2 Master Transmission for details of each pattern.

Only members of the structure used in this function are described here. Refer to 2.9 Parameters for details on the structure.

The contents of the structure are referred and updated during communication. Do not rewrite the structure during communication (SCI_IIC_COMMUNICATION).

When setting the slave address, store it without shifting 1 bit to left.

For the parameter which has '(to be updated)' in the comment below, the argument for the parameter will be updated during the API execution.

```
uint8_t * p_slv_adr; /* Pointer to the buffer to store the slave address */
uint8_t * p_data1st; /* Pointer to the buffer to store the first data
                    (to be updated) */
uint8_t * p_data2nd; /* Pointer to the buffer to store the second data
                    (to be updated) */
sci_iic_ch_dev_status_t dev_sts; /* Device state flag (to be updated) */
uint32_t cnt1st; /* First data counter (number of bytes)
                (to be updated for only pattern 1) */
uint32_t cnt2nd; /* Second data counter (number of bytes)
                (to be updated for only pattern 1 and 2) */
sci_iic_callback callbackfunc; /* Callback function */
uint8_t ch_no; /* Channel number */
```

Return Values

SCI_IIC_SUCCESS /* Processing completed successfully */
SCI_IIC_ERR_INVALID_CHAN /* The channel is nonexistent. */
SCI_IIC_ERR_INVALID_ARG /* The parameter is invalid. */
SCI_IIC_ERR_NO_INIT /* Uninitialized state */
SCI_IIC_ERR_BUS_BUSY /* The bus state is busy. */
SCI_IIC_ERR_OTHER /* The event occurred is invalid in the current state. */

Properties

Prototyped in r_sci_iic_rx_if.h.

Description

Starts the simple I²C-bus master transmission. The transmission is performed with the SCI channel and transmit pattern specified by parameters. If the state of the channel is 'idle (SCI_IIC_IDEL)', the following processes are performed.

- Setting the state flag
- Initializing variables used by the API
- Enabling the SCI interrupts
- Releasing the I²C reset
- Allocating I²C output ports
- Generating a start condition

This function returns SCI_IIC_SUCCESS as a return value when the processing up to the start condition generation ends normally. This function returns SCI_IIC_ERR_BUS_BUSY as a return value when the following conditions are met to the start condition generation ends normally. ⁽¹⁾

- Either SCL or SDA line is in low state.

The transmission processing is performed sequentially in subsequent interrupt processing after this function return SCI_IIC_SUCCESS. Section "2.4 Usage of Interrupt Vector" should be referred for the interrupt to be used. For master transmission, the interrupt generation timing should be referred from "6.2.1 Master transmission".

After issuing a stop condition at the end of transmission, the callback function specified by the argument is called.

The transmission completion is performed normally or not, can be confirmed by checking the device status flag specified by the argument or the channel status flag g_sci_iic_ChStatus [], that is to be "SCI_IIC_FINISH" for normal completion.

Notes:

1. When SCL and SDA pin is not external pull-up, this function may return SCI_IIC_ERR_BUS_BUSY by detecting either SCL or SDA line is as in low state.

Example

- Case1: Transmit pattern 1

```
#include <stddef.h>          // NULL definition
#include "platform.h"
#include "r_sci_iic_rx_if.h"

void main(void);
void Callback_ch1(void);

void main(void)
{
    volatile sci_iic_return_t ret;
    sci_iic_info_t          siic_info;

    uint8_t slave_addr_eeprom[1] = {0x50}; /* Slave address for EEPROM */
    uint8_t access_addr1[1]      = {0x00}; /* 1st data field */
    uint8_t send_data[5]        = {0x81,0x82,0x83,0x84,0x85};

    /* Sets IIC Information (Send pattern 1) */
    siic_info.p_slv_adr    = slave_addr_eeprom;
    siic_info.p_data1st    = access_addr1;
```

```
siic_info.p_data2nd      = send_data;
siic_info.dev_sts       = SCI_IIC_NO_INIT;
siic_info.cnt1st       = 1;
siic_info.cnt2nd       = 3;
siic_info.callbackfunc = &Callback_ch1;
siic_info.ch_no        = 1;

/* SCI open */
ret = R_SCI_IIC_Open(&siic_info);
/* Start Master Send */
ret = R_SCI_IIC_MasterSend(&siic_info);

if (SCI_IIC_SUCCESS == ret)
{
    while(SCI_IIC_FINISH != siic_info.dev_sts);
}
else
{
    /* error */
}

/* Master send complete */
while(1);
}

void Callback_ch1(void)
{
    volatile sci_iic_return_t ret;
    sci_iic_mcu_status_t      iic_status;
    sci_iic_info_t            iic_info_ch;

    iic_info_ch.ch_no = 1;
    ret = R_SCI_IIC_GetStatus(&iic_info_ch, &iic_status);

    if (SCI_IIC_SUCCESS != ret)
    {
        /* Call error processing for the R_SCI_IIC_GetStatus() function*/
    }
    else
    {
        if (1 == iic_status.BIT.NACK)
        {
            /* Processing when a NACK is detected
            by verifying the iic_status flag. */
        }
    }
}
}
```

- Case2: Transmitting data to two slave devices (Slave 1 and slave 2) continuously.

```
#include <stddef.h>        // NULL definition
#include <stdio.h>         /* For printf */
#include "platform.h"
#include "r_sci_iic_rx_if.h"

void main(void);
void Callback_ch1(void);

void main(void)
{
    volatile sci_iic_return_t ret;
    volatile sci_iic_info_t      siic_info_slave1;
    volatile sci_iic_info_t      siic_info_slave2;

    uint8_t slave_addr_eeprom[1] = {0x50}; /* Slave address for EEPROM */
    uint8_t slave_addr_m16c[1]   = {0x01}; /* Slave address for M16C */
    uint8_t write_addr_slave1[1] = {0x01}; /* 1st data field */
    uint8_t write_addr_slave2[1] = {0x02}; /* 1st data field */
    uint8_t data_area_slave1[5]  = {0x81,0x82,0x83,0x84,0x85};
    uint8_t data_area_slave2[5]  = {0x18,0x28,0x38,0x48,0x58};
```

```
/* Sets 'Slave 1' Information (Send pattern 1) */
siic_info_slave1.p_slv_adr = slave_addr_eeprom;
siic_info_slave1.p_data1st = write_addr_slave1;
siic_info_slave1.p_data2nd = data_area_slave1;
siic_info_slave1.dev_sts = SCI_IIC_NO_INIT;
siic_info_slave1.cnt1st = 1;
siic_info_slave1.cnt2nd = 3;
siic_info_slave1.callbackfunc = &Callback_ch1;
siic_info_slave1.ch_no = 1;
uint8_t timeout_cnt1 = 0;
```

```
/* SCI open */
ret = R_SCI_IIC_Open(&siic_info_slave1);
/* Start Master Send */
ret = R_SCI_IIC_MasterSend(&siic_info_slave1);
```

```
while((SCI_IIC_FINISH != siic_info_slave1.dev_sts) &&
      (SCI_IIC_NACK != siic_info_slave1.dev_sts))
{
    timeout_cnt1 = timeout_cnt1 + 1; /*timeout counter is added*/
    if (timeout_cnt1 >= 100)
    {
        printf("Timeout Happend\n");
        break;
    }
    else
    {
        R_BSP_SoftwareDelay(10, BSP_DELAY_MICROSECS); /*BSP delay*/
    }
}
```

```
/* Sets 'Slave 2' Information (Send pattern 1) */
siic_info_slave2.p_slv_adr = slave_addr_m16c;
siic_info_slave2.p_data1st = write_addr_slave2;
```

To access multiple slave devices, rewrite the information structure for each slave device to be accessed.

```

siic_info_slave2.p_data2nd = data_area_slave2;
siic_info_slave2.dev_sts = SCI_IIC_NO_INIT;
siic_info_slave2.cnt1st = 1;
siic_info_slave2.cnt2nd = 3;
siic_info_slave2.callbackfunc = &Callback_ch1;
siic_info_slave2.ch_no = 1;
uint8_t timeout_cnt2 = 0;

```

```

/* Start Master Send */
ret = R_SCI_IIC_MasterSend(&siic_info_slave2);

while((SCI_IIC_FINISH != siic_info_slave2.dev_sts) &&
      (SCI_IIC_NACK != siic_info_slave2.dev_sts))
{
    timeout_cnt2 = timeout_cnt2 + 1; /*timeout counter is added*/
    if (timeout_cnt2 >= 100)
    {
        printf("Timeout Happend\n");
        break;
    }
    else
    {
        R_BSP_SoftwareDelay(10, BSP_DELAY_MICROSECS); /*BSP delay*/
    }
}
while(1);
}

void Callback_ch1(void)
{
    volatile sci_iic_return_t ret;
    sci_iic_mcu_status_t      iic_status;
    sci_iic_info_t           iic_info_ch;

    iic_info_ch.ch_no = 1;
    ret = R_SCI_IIC_GetStatus(&iic_info_ch, &iic_status);

    if (SCI_IIC_SUCCESS != ret)
    {
        /* Call error processing for the R_SCI_IIC_GetStatus() function*/
    }
    else
    {
        {
            if (1 == iic_status.BIT.NACK)
            {
                /* Processing when a NACK is detected
                by verifying the iic_status flag. */
            }
        }
    }
}

```

Special Notes

The table below lists available settings for each pattern.

Structure Member	Available Settings for Each Pattern of the Master Transmission			
	Pattern 1	Pattern 2	Pattern 3	Pattern 4
*p_slv_adr	Buffer pointer to the slave address storage			FIT_NO_PTR ⁽¹⁾
*p_data1st	Buffer pointer to the first data storage	FIT_NO_PTR ⁽¹⁾	FIT_NO_PTR ⁽¹⁾	FIT_NO_PTR ⁽¹⁾
*p_data2nd	Buffer pointer to the second data (transmit data) storage		FIT_NO_PTR ⁽¹⁾	FIT_NO_PTR ⁽¹⁾
dev_sts	Device state flag			
cnt1st	0000 0001h to FFFF FFFFh ⁽²⁾	0	0	0
cnt2nd	0000 0001h to FFFF FFFFh ⁽²⁾		0	0
callbackfunc	Specify the function name used			
ch_no	00h to FFh			
rsv1, rsv2	Reserved (value set here has no effect)			

Notes:

1. When using pattern 2, 3, or 4, set 'FIT_NO_PTR' as the argument of the parameter.
2. Do not set to 0.

R_SCI_IIC_MasterReceive()

Starts master reception. Changes the receive pattern according to the parameters. Operates batched processing until stop condition generation.

Format

```
sci_iic_return_t R_SCI_IIC_MasterReceive(
    sci_iic_info_t * p_sci_iic_info /* Structure data */
)
```

Parameters

** p_sci_iic_info*

This is the pointer to the I²C communication information structure. The receive pattern can be selected from master reception and master transmit/receive. Refer to the Special Notes in this section for available settings and the setting values for each receive pattern. Also refer to 1.3.3 Master Reception for details of each receive pattern.

Only members of the structure used in this function are described here. Refer to 2.9 Parameters for details on the structure.

The contents of the structure are referred and updated during communication. Do not rewrite the structure during communication (SCI_IIC_COMMUNICATION).

When setting the slave address, store it without shifting 1 bit to left.

For the parameter which has '(to be updated)' in the comment below, the argument for the parameter will be updated during the API execution.

```
uint8_t * p_slv_addr; /* Pointer to the buffer to store the slave address */
uint8_t * p_data1st; /* Pointer to the buffer to store the first data
                    (to be updated) */
uint8_t * p_data2nd; /* Pointer to the buffer to store the second data
                    (to be updated) */
sci_iic_ch_dev_status_t dev_sts; /* Device state flag (to be updated) */
uint32_t cnt1st; /* First data counter (number of bytes) */
                    (to be updated only for master transmit/receive)
*/
uint32_t cnt2nd; /* Second data counter (number of bytes) (to be updated) */
sci_iic_callback callbackfunc; /* Callback function */
uint8_t ch_no; /* Channel number */
```

Return Values

```
SCI_IIC_SUCCESS /* Processing completed successfully */
SCI_IIC_ERR_INVALID_CHAN /* The channel is nonexistent. */
SCI_IIC_ERR_INVALID_ARG /* The parameter is invalid. */
SCI_IIC_ERR_NO_INIT /* Uninitialized state */
SCI_IIC_ERR_BUS_BUSY /* The bus state is busy. */
SCI_IIC_ERR_OTHER /* The event occurred is invalid in the current state. */
```

Properties

Prototyped in r_sci_iic_rx_if.h.

Description

Starts the simple I²C-bus master reception. The reception is performed with the SCI channel and receive pattern specified by parameters. If the state of the channel is 'idle (SCI_IIC_IDEL)', the following processes are performed.

- Setting the state flag
- Initializing variables used by the API
- Enabling the SCI interrupts
- Releasing the I²C reset
- Allocating I²C output ports
- Generating a start condition

This function returns SCI_IIC_SUCCESS as a return value when the processing up to the start condition generation ends normally. This function returns SCI_IIC_ERR_BUS_BUSY as a return value when the following conditions are met to the start condition generation ends normally. ⁽¹⁾

- Either SCL or SDA line is in low state.

The reception processing is performed sequentially in subsequent interrupt processing after this function return SCI_IIC_SUCCESS. Section "2.4 Usage of Interrupt Vector" should be referred for the interrupt to be used. For master transmission, the interrupt generation timing should be referred from "6.2.2 Master Reception".

After issuing a stop condition at the end of reception, the callback function specified by the argument is called.

The reception completion is performed normally or not, can be confirmed by checking the device status flag specified by the argument or the channel status flag g_sci_iic_ChStatus [], that is to be "SCI_IIC_FINISH" for normal completion.

Notes:

1. When SCL and SDA pin is not external pull-up, this function may return SCI_IIC_ERR_BUS_BUSY by detecting either SCL or SDA line is as in low state.

Example

```
#include <stddef.h>          // NULL definition
#include "platform.h"
#include "r_sci_iic_rx_if.h"

void main(void);
void Callback_ch1(void);

void main(void)
{
    volatile sci_iic_return_t ret;
    sci_iic_info_t          siic_info;

    uint8_t slave_addr_eeprom[1] = {0x50}; /* Slave address for EEPROM */
    uint8_t access_addr1[1]      = {0x00}; /* 1st data field */
    uint8_t store_area[5]        = {0xFF, 0xFF, 0xFF, 0xFF, 0xFF};

    /* Sets IIC Information (Ch1) */
    siic_info.p_slv_adr = slave_addr_eeprom;
    siic_info.p_data1st = access_addr1;
    siic_info.p_data2nd = store_area;
}
```



```
siic_info.dev_sts = SCI_IIC_NO_INIT;
siic_info.cnt1st = 1;
siic_info.cnt2nd = 3;
siic_info.callbackfunc = &Callback_ch1;
siic_info.ch_no = 1;

/* SCI open */
ret = R_SCI_IIC_Open(&siic_info);
/* Start Master Receive */
ret = R_SCI_IIC_MasterReceive(&siic_info);
if (SCI_IIC_SUCCESS == ret)
{
    while(SCI_IIC_FINISH != siic_info.dev_sts);
}
else
{
    /* error */
}

/* Master receive complete */
while(1);
}

void Callback_ch1(void)
{
    volatile sci_iic_return_t ret;
    sci_iic_mcu_status_t      iic_status;
    sci_iic_info_t           iic_info_ch;

    iic_info_ch.ch_no = 1;
    ret = R_SCI_IIC_GetStatus(&iic_info_ch, &iic_status);

    if (SCI_IIC_SUCCESS != ret)
    {
        /* Call error processing for the R_SCI_IIC_GetStatus() function*/
    }
    else
    {
        if (1 == iic_status.BIT.NACK)
        {
            /* Processing when a NACK is detected
            by verifying the iic_status flag. */
        }
    }
}
}
```

Special Notes

The table below lists available settings for each receive pattern.

Structure Member	Available Settings for Each Pattern of the Master Reception	
	Master Reception	Master Transmit/Receive
*p_slv_adr	Buffer pointer to the slave address storage	
*p_data1st	(Value set here has no effect)	Buffer pointer to the first data storage
*p_data2nd	Buffer pointer to the second data (receive data) storage	
dev_sts	Device state flag	
cnt1st ⁽¹⁾	0	0000 0001h to FFFF FFFFh
cnt2nd ⁽²⁾	0000 0001h to FFFF FFFFh	0000 0001h to FFFF FFFFh
callbackfunc	Specify the function name used	
ch_no	00h to FFh	
rsv1, rsv2	Reserved (value set here has no effect)	

Notes:

1. The receive pattern is determined by whether cnt1st is 0 or not.
2. Do not set to 0.

R_SCI_IIC_Close()

This function completes the simple I²C communication and releases the SCI used.

Format

```
sci_iic_return_t R_SCI_IIC_Close(  
    sci_iic_info_t * p_sci_iic_info /* Structure data */  
)
```

Parameters

** p_sci_iic_info*

This is the pointer to the I²C communication information structure.

Only the member of the structure used in this function is described here. Refer to 2.9 Parameters for details on the structure.

The contents of the structure are referred and updated during communication. Do not rewrite the structure during communication (SCI_IIC_COMMUNICATION).

For the parameter which has '(to be updated)' in the comment below, the argument for the parameter will be updated during the API execution.

```
sci_iic_ch_dev_status_t dev_sts; /* Device state flag (to be updated) */  
uint8_t ch_no; /* Channel number */
```

Return Values

```
SCI_IIC_SUCCESS /* Processing completed successfully */  
SCI_IIC_ERR_INVALID_CHAN /* The channel is nonexistent. */  
SCI_IIC_ERR_INVALID_ARG /* The parameter is invalid. */
```

Properties

Prototyped in r_sci_iic_rx_if.h.

Description

Configures the settings to complete the simple I²C-bus communication. Disables the SCI channel specified by the parameter. The following processes are performed in this function.

- Entering the SCI module-stop state
- Releasing I²C output ports
- Disabling the SCI interrupt

To restart the communication, call the R_SCI_IIC_Open() function (initialization function). If the communication is forcibly terminated, that communication is not guaranteed.

Example

```
volatile sci_iic_return_t ret;
sci_iic_info_t          siic_info;

siic_info.ch_no = 1;

ret = R_SCI_IIC_Close(&siic_info);
```

Special Notes

None

R_SCI_IIC_GetStatus()

Returns the state of this module.

Format

```
sci_iic_return_t R_SCI_IIC_GetStatus(
    sci_iic_info_t * p_sci_iic_info /* Structure data */
    sci_iic_mcu_status_t *p_sci_iic_status /* State of this module */
)
```

Parameters

**p_sci_iic_info*

This is the pointer to the I²C communication information structure.

Only the member of the structure used in this function is described here. Refer to 2.9 Parameters for details on the structure.

The contents of the structure are referred and updated during communication. Do not rewrite the structure during communication (SCI_IIC_COMMUNICATION).

```
uint8_t ch_no; /* Channel number */
```

**p_sci_iic_status*

This contains the address to store the I²C state flag. If the argument is 'FIT_NO_PTR', the state is not returned.

Use the structure members listed below to specify parameters.

```
typedef union
{
    uint32_t LONG;
    struct st_sci_iic_status_flag
    {
        uint32_t rsv :27 /* Reserve bit */
        uint32_t SCLI:1; /* SSCL pin level */
        uint32_t SDAI:1; /* SSDA pin level */
        uint32_t NACK:1; /* NACK detection flag */
        uint32_t TRS :1; /* Transmit/receive mode level */
        uint32_t BSY :1; /* Bus state flag */
    }BIT;
} sci_iic_mcu_status_t;
```

Return Values

```
SCI_IIC_SUCCESS /* Processing completed successfully */
SCI_IIC_ERR_INVALID_CHAN /* The channel is nonexistent. */
SCI_IIC_ERR_INVALID_ARG /* The parameter is invalid. */
SCI_IIC_ERR_OTHER /* The event occurred is invalid in the current state. */
```

Properties

Prototyped in r_sci_iic_rx_if.h.

Description

Returns the state of this module.

By reading the register, pin level, variable, or others, obtains the state of the SCI channel which specified by the parameter, and returns the obtained state as 32-bit structure.

Example

```
volatile sci_iic_return_t ret;
sci_iic_info_t          siic_info;
sci_iic_mcu_status_t   iic_status;

siic_info.ch_no = 1

ret = R_SCI_IIC_GetStatus(&siic_info, &iic_status);
```

Special Notes

The following shows the state flag allocation.

b31 to b16
Reserved
Reserved
Rsv
Always 0

b15 to b8
Reserved
Reserved
Rsv
Always 0

b7 to b5	b4	b3	b2	b1	b0
Reserved	Pin level		Event detection	Mode	Bus state
Reserved	SSCL pin level	SSDA pin level	NACK detection	Send/receive mode	Bus busy/ready
Rsv	SCLI	SDAI	NACK	TRS	BSY
Always 0	0: Low level 1: High level		0: Not detected 1: Detected	0: Receive 1: Transmit	0: Idle 1: Busy

R_SCI_IIC_Control()

This function outputs conditions, Hi-Z from the SSSDA pin, and one-shot of the SSCL clock. Also it resets the settings of this module. This function is mainly used when a communication error occurs.

Format

```
sci_iic_return_t R_SCI_IIC_Control(
    r_sci_iic_info_t * p_sci_iic_info /* Structure data */
    sci_iic_ctrl_ptn_t ctrl_ptn /* Output pattern */
);
```

Parameters

** p_sci_iic_info*

This is the pointer to the I²C communication information structure.

Only the member of the structure used in this function is described here. Refer to 2.9 Parameters for details on the structure.

The contents of the structure are referred and updated during communication. Do not rewrite the structure during communication (SCI_IIC_COMMUNICATION).

For the parameter which has '(to be updated)' in the comment below, the argument for the parameter will be updated during the API execution.

```
sci_iic_ch_dev_status_t dev_sts; /* Device state flag (to be updated) */
uint8_t ch_no; /* Channel number */
```

ctrl_ptn

Specifies the output pattern. When selecting multiple options, specify them with '|'.

The following options can be selected simultaneously:

- The following three options can be specified simultaneously. Then they will be processed in the order listed.

- SCI_IIC_GEN_START_CON
- SCI_IIC_GEN_RESTART_CON
- SCI_IIC_GEN_STOP_CON

- The following two options can be specified simultaneously.

- SCI_IIC_GEN_SDA_HI_Z
- SCI_IIC_GEN_SSCL_ONESHOT

```
typedef uint8_t sci_iic_ctrl_ptn_t;
#define SCI_IIC_GEN_START_CON (sci_iic_ctrl_ptn_t) (0x01)
    /* Start condition generation */
#define SCI_IIC_GEN_STOP_CON (sci_iic_ctrl_ptn_t) (0x02)
    /* Stop condition generation */
#define SCI_IIC_GEN_RESTART_CON (sci_iic_ctrl_ptn_t) (0x04)
    /* Restart condition generation */
#define SCI_IIC_GEN_SSDA_HI_Z (sci_iic_ctrl_ptn_t) (0x08)
    /* Hi-Z output from the SSSDA pin */
#define SCI_IIC_GEN_SSCL_ONESHOT (sci_iic_ctrl_ptn_t) (0x10)
    /* SSCL clock one-shot output */
#define SCI_IIC_GEN_RESET (sci_iic_ctrl_ptn_t) (0x20)
    /* Simple I2C mode reset */
```

Return Values

```
SCI_IIC_SUCCESS /* Processing completed successfully */
SCI_IIC_ERR_INVALID_CHAN /* The channel is nonexistent. */
SCI_IIC_ERR_INVALID_ARG /* The parameter is invalid. */
SCI_IIC_ERR_BUS_BUSY /* The bus state is busy. */
SCI_IIC_ERR_OTHER /* The event occurred is invalid in the current state. */
```

Properties

Prototyped in r_sci_iic_rx_if.h.

Description

Outputs control signals of the simple I²C mode. Outputs conditions specified by the argument, Hi-Z from the SSDA pin, and one-shot of the SSCL clock. Also resets the simple I²C mode settings.

Example

```
volatile sci_iic_return_t ret;
sci_iic_info_t          siic_info;

siic_info.ch_no = 1;

/* Output an extra SSCL clock cycle after changes the SSDA pin in a high-
impedance state */
ret = R_SCI_IIC_Control(&siic_info, SCI_IIC_GEN_SSDA_HI_Z |
SCI_IIC_SSCL_ONESHOT);
```

Special Notes

None

R_SCI_IIC_GetVersion()

Returns the current version of this module.

Format

uint32_t R_SCI_IIC_GetVersion(void)

Parameters

None

Return Values

Version number

Properties

Prototyped in r_sci_iic_rx_if.h.

Description

This function will return the version of the currently installed SCI (simple I²C mode) FIT module. The version number is encoded where the top 2 bytes are the major version number and the bottom 2 bytes are the minor version number. For example, Version 4.25 would be returned as 0x00040019.

Example

```
uint32_t version;  
  
version = R_SCI_IIC_GetVersion();
```

Special Notes

None.

4. Pin Settings

To use the SCI (Simple I²C Mode) FIT module, assign input/output signals of the peripheral function to pins with the multi-function pin controller (MPC). The pin assignment is referred to as the "Pin Setting" in this document.

The SCI (Simple I²C Mode) FIT module can choose whether or not to perform the pin setting in the R_SCI_IIC_Open / R_SCI_IIC_MasterSend / R_SCI_IIC_MasterReceive / R_SCI_IIC_Close / R_SCI_IIC_Control function depending on the setting of the configuration option SCI_IIC_CFG_PORT_SET_PROCESSING.

For details of the configuration options, refer to "2.7 Configuration Overview".

When performing the Pin Setting in the e² studio, the Pin Setting feature of the Smart Configurator can be used. When using the pin setting feature, pins selected in the Pin Setting pane can be used in the Smart Configurator. The information of selected pins is reflected in the r_sci_iic_pin_config.h file. Values of the macro definitions listed in Table 4.1 and Table 4.2 are overwritten with values corresponding to the pins selected.

Table 4.1 Macro Definitions for the Pin Setting Feature – 1 –

Channel Selected	Pin Selected	Macro Definition
Channel 0	SSCL0 Pin	R_SCI_IIC_CFG_SCI0_SSCL0_PORT R_SCI_IIC_CFG_SCI0_SSCL0_BIT
	SSDA0 Pin	R_SCI_IIC_CFG_SCI0_SSDA0_PORT R_SCI_IIC_CFG_SCI0_SSDA0_BIT
Channel 1	SSCL1 Pin	R_SCI_IIC_CFG_SCI1_SSCL1_PORT R_SCI_IIC_CFG_SCI1_SSCL1_BIT
	SSDA1 Pin	R_SCI_IIC_CFG_SCI1_SSDA1_PORT R_SCI_IIC_CFG_SCI1_SSDA1_BIT
Channel 2	SSCL2 Pin	R_SCI_IIC_CFG_SCI2_SSCL2_PORT R_SCI_IIC_CFG_SCI2_SSCL2_BIT
	SSDA2 Pin	R_SCI_IIC_CFG_SCI2_SSDA2_PORT R_SCI_IIC_CFG_SCI2_SSDA2_BIT
Channel 3	SSCL3 Pin	R_SCI_IIC_CFG_SCI3_SSCL3_PORT R_SCI_IIC_CFG_SCI3_SSCL3_BIT
	SSDA3 Pin	R_SCI_IIC_CFG_SCI3_SSDA3_PORT R_SCI_IIC_CFG_SCI3_SSDA3_BIT
Channel 4	SSCL4 Pin	R_SCI_IIC_CFG_SCI4_SSCL4_PORT R_SCI_IIC_CFG_SCI4_SSCL4_BIT
	SSDA4 Pin	R_SCI_IIC_CFG_SCI4_SSDA4_PORT R_SCI_IIC_CFG_SCI4_SSDA4_BIT
Channel 5	SSCL5 Pin	R_SCI_IIC_CFG_SCI5_SSCL5_PORT R_SCI_IIC_CFG_SCI5_SSCL5_BIT
	SSDA5 Pin	R_SCI_IIC_CFG_SCI5_SSDA5_PORT R_SCI_IIC_CFG_SCI5_SSDA5_BIT
Channel 6	SSCL6 Pin	R_SCI_IIC_CFG_SCI6_SSCL6_PORT R_SCI_IIC_CFG_SCI6_SSCL6_BIT
	SSDA6 Pin	R_SCI_IIC_CFG_SCI6_SSDA6_PORT R_SCI_IIC_CFG_SCI6_SSDA6_BIT

Table 4.2 Macro Definitions for the Pin Setting Feature – 2 –

Channel Selected	Pin Selected	Macro Definition
Channel 7	SSCL7 Pin	R_SCI_IIC_CFG_SCI7_SSCL7_PORT R_SCI_IIC_CFG_SCI7_SSCL7_BIT
	SSDA7 Pin	R_SCI_IIC_CFG_SCI7_SSDA7_PORT R_SCI_IIC_CFG_SCI7_SSDA7_BIT
Channel 8	SSCL8 Pin	R_SCI_IIC_CFG_SCI8_SSCL8_PORT R_SCI_IIC_CFG_SCI8_SSCL8_BIT
	SSDA8 Pin	R_SCI_IIC_CFG_SCI8_SSDA8_PORT R_SCI_IIC_CFG_SCI8_SSDA8_BIT
Channel 9	SSCL9 Pin	R_SCI_IIC_CFG_SCI9_SSCL9_PORT R_SCI_IIC_CFG_SCI9_SSCL9_BIT
	SSDA9 Pin	R_SCI_IIC_CFG_SCI9_SSDA9_PORT R_SCI_IIC_CFG_SCI9_SSDA9_BIT
Channel 10	SSCL10 Pin	R_SCI_IIC_CFG_SCI10_SSCL10_PORT R_SCI_IIC_CFG_SCI10_SSCL10_BIT
	SSDA10 Pin	R_SCI_IIC_CFG_SCI10_SSDA10_PORT R_SCI_IIC_CFG_SCI10_SSDA10_BIT
Channel 11	SSCL11 Pin	R_SCI_IIC_CFG_SCI11_SSCL11_PORT R_SCI_IIC_CFG_SCI11_SSCL11_BIT
	SSDA11 Pin	R_SCI_IIC_CFG_SCI11_SSDA11_PORT R_SCI_IIC_CFG_SCI11_SSDA11_BIT
Channel 12	SSCL12 Pin	R_SCI_IIC_CFG_SCI12_SSCL12_PORT R_SCI_IIC_CFG_SCI12_SSCL12_BIT
	SSDA12 Pin	R_SCI_IIC_CFG_SCI12_SSDA12_PORT R_SCI_IIC_CFG_SCI12_SSDA12_BIT

Pins selected in the `r_sci_iic_pin_config.h` file are configured as peripheral function pins SSCL and SSDA after calling the `R_SCI_IIC_MasterSend` / `R_SCI_IIC_MasterReceive` / `R_SCI_IIC_Control` function.

The pins assigned to the peripheral function are released when the communication operation executed by the `R_SCI_IIC_MasterSend` / `R_SCI_IIC_MasterReceive` / `R_SCI_IIC_Control` function is completed or upon calling the `R_SCI_IIC_Close` function and then become general I/O pins (as input pins).

Pins SSCL and SSDA must be pulled up with an external resistor.

When the pin setting feature in this FIT module is not used according to the `SCI_IIC_CFG_PORT_SET_PROCESSING` setting, pins used in user processing must be configured after calling the `R_SCI_IIC_Open` function before calling the other APIs.

5. Demo Projects

Demo projects are complete stand-alone programs. They include function main() that utilizes the module and its dependent modules (e.g.. r_bsp).

In this section, it explains about GUI operation when you use e² studio.

5.1 sciic_send_demo_rskrx64m, sciic_send_demo_rskrx64m_gcc

Description

A simple demo of the RX64M SCI Simple I²C Mode Master Transmission for the RSKRX64M starter kit (FIT module "r_sci_iic_rx"). The demo uses the Simple I²C API from r_sci_iic_rx_if.h to start master transmission. The master device (RX MCU) transmits data to the slave device. When the master transmission is finished, print the finished message to the debug console by main().

Setup and Execution

1. Compile and download the sample code.
2. Click 'Reset Go' to start the software. If PC stops at Main, press F8 to resume.
3. Set breakpoints and watch global variables

Boards Supported

RSKRX64M

5.2 sciic_receive_demo_rskrx64m, sciic_receive_demo_rskrx64m_gcc

Description

A simple demo of the RX64M SCI Simple I²C Mode Master Reception for the RSKRX64M starter kit (FIT module "r_sci_iic_rx"). The demo uses the Simple I²C API from r_sci_iic_rx_if.h to start master reception. The master (RX MCU) receives data from the slave device. When the master reception is finished, print the received data to the debug console by main().

Boards Supported

RSKRX64M

5.3 sciic_send_demo_rskrx231, sciic_send_demo_rskrx231_gcc

Description

A simple demo of the RX231 SCI Simple I²C Mode Master Transmission for the RSKRX231 starter kit (FIT module "r_sci_iic_rx"). This demo is identical to the RX64M for demo above.

Boards Supported

RSKRX231

5.4 sciic_receive_demo_rskrx231, sciic_receive_demo_rskrx231_gcc

Description

A simple demo of the RX231 SCI Simple I²C Mode Master Reception for the RSKRX231 starter kit (FIT module "r_sci_iic_rx"). This demo is identical to the RX64M for demo above.

Boards Supported

RSKRX231

5.5 sciic_send_demo_rskrx671, sciic_send_demo_rskrx671_gcc

Description

A simple demo of the RX671 SCI Simple I²C Mode Master Transmission for the RSKRX671 starter kit (FIT module "r_sci_iic_rx"). This demo is identical to the RX64M for demo above.

Boards Supported

RSKRX671

5.6 sciic_receive_demo_rskrx671, sciic_receive_demo_rskrx671_gcc

A simple demo of the RX671 SCI Simple I²C Mode Master Reception for the RSKRX671 starter kit (FIT module "r_sci_iic_rx"). This demo is identical to the RX64M for demo above.

Boards Supported

RSKRX671

5.7 sciic_send_demo_rskrx72n, sciic_send_demo_rskrx72n_gcc

Description

A simple demo of the RX72N SCI Simple I²C Mode Master Transmission for the RSKRX72N starter kit (FIT module "r_sci_iic_rx"). This demo is identical to the RX64M for demo above.

Boards Supported

RSKRX72N

5.8 sciic_receive_demo_rskrx72n, sciic_receive_demo_rskrx72n_gcc

Description

A simple demo of the RX72N SCI Simple I²C Mode Master Reception for the RSKRX72N starter kit (FIT module "r_sci_iic_rx"). This demo is identical to the RX64M for demo above.

Boards Supported

RSKRX72N

5.9 Adding a Demo to a Workspace

Demo projects are found in the FITDemos subdirectory of the distribution file for this application note. To add a demo project to a workspace, select File>Import>General>Existing Projects into Workspace, then click "Next". From the Import Projects dialog, choose the "Select archive file" radio button. "Browse" to the FITDemos subdirectory, select the desired demo zip file, then click "Finish".

5.10 Downloading Demo Projects

Demo projects are not included in the RX Driver Package. When using the demo project, the FIT module needs to be downloaded. To download the FIT module, right click on the required application note and select "Sample Code (download)" from the context menu in the Smart Brower >> Application Notes tab.

6. Appendices

6.1 Communication Method

This API controls each processing such as start condition generation, slave address transmission, and others as a single protocol, and performs communication by combining these protocols.

6.1.1 States for API Operation

Table 6.1 lists the States Used for Protocol Control.

Table 6.1 States Used for Protocol Control (enum sci_iic_api_status_t)

No.	Constant Name	Description
STS0	SCI_IIC_STS_NO_INIT	Uninitialized state
STS1	SCI_IIC_STS_IDLE	Idle state
STS2	SCI_IIC_STS_ST_COND_WAIT	Wait state for a start condition to be generated
STS3	SCI_IIC_STS_SEND_SLVADR_W_WAIT	Wait state for the slave address [write] transmission to complete
STS4	SCI_IIC_STS_SEND_SLVADR_R_WAIT	Wait state for the slave address [read] transmission to complete
STS5	SCI_IIC_STS_SEND_DATA_WAIT	Wait state for the data transmission to complete
STS6	SCI_IIC_STS_RECEIVE_DATA_WAIT	Wait state for the data reception to complete
STS7	SCI_IIC_STS_SP_COND_WAIT	Wait state for a stop condition to be generated

6.1.2 Events During API Operation

Table 6.2 lists the Events Used for Protocol Control. When the interface functions accompanying this module are called, they are defined as events as well as interrupts.

Table 6.2 Events Used for Protocol Control (enum sci_iic_api_event_t)

No.	Event	Event Definition
EV0	SCI_IIC_EV_INIT	sci_iic_init_driver() called
EV1	SCI_IIC_EV_GEN_START_COND	sci_iic_generate_start_cond() called
EV2	SCI_IIC_EV_INT_START	STI interrupt occurred (interrupt flag: START)
EV3	SCI_IIC_EV_INT_ADD	TXI interrupt occurred
EV4	SCI_IIC_EV_INT_SEND	TXI interrupt occurred
EV5	SCI_IIC_EV_INT_STOP	STI interrupt occurred (interrupt flag: STOP)
EV6	SCI_IIC_EV_INT_NACK	STI interrupt occurred (interrupt flag: NACK)

6.1.3 Protocol State Transitions

In this module, a state transition occurs when an interface function provided is called or when an SCI (simple I²C mode) interrupt request is generated. Figure.6.1 to Figure 6.4 show protocol state transitions.

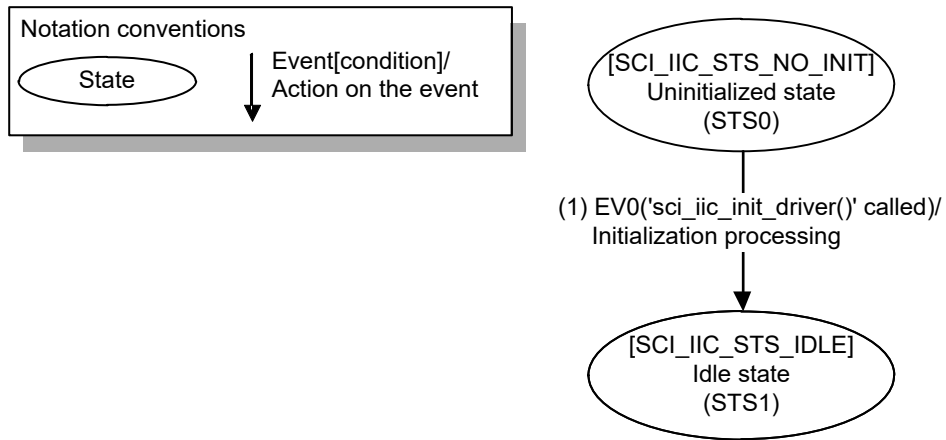

Figure.6.1 State Transition on Initialization

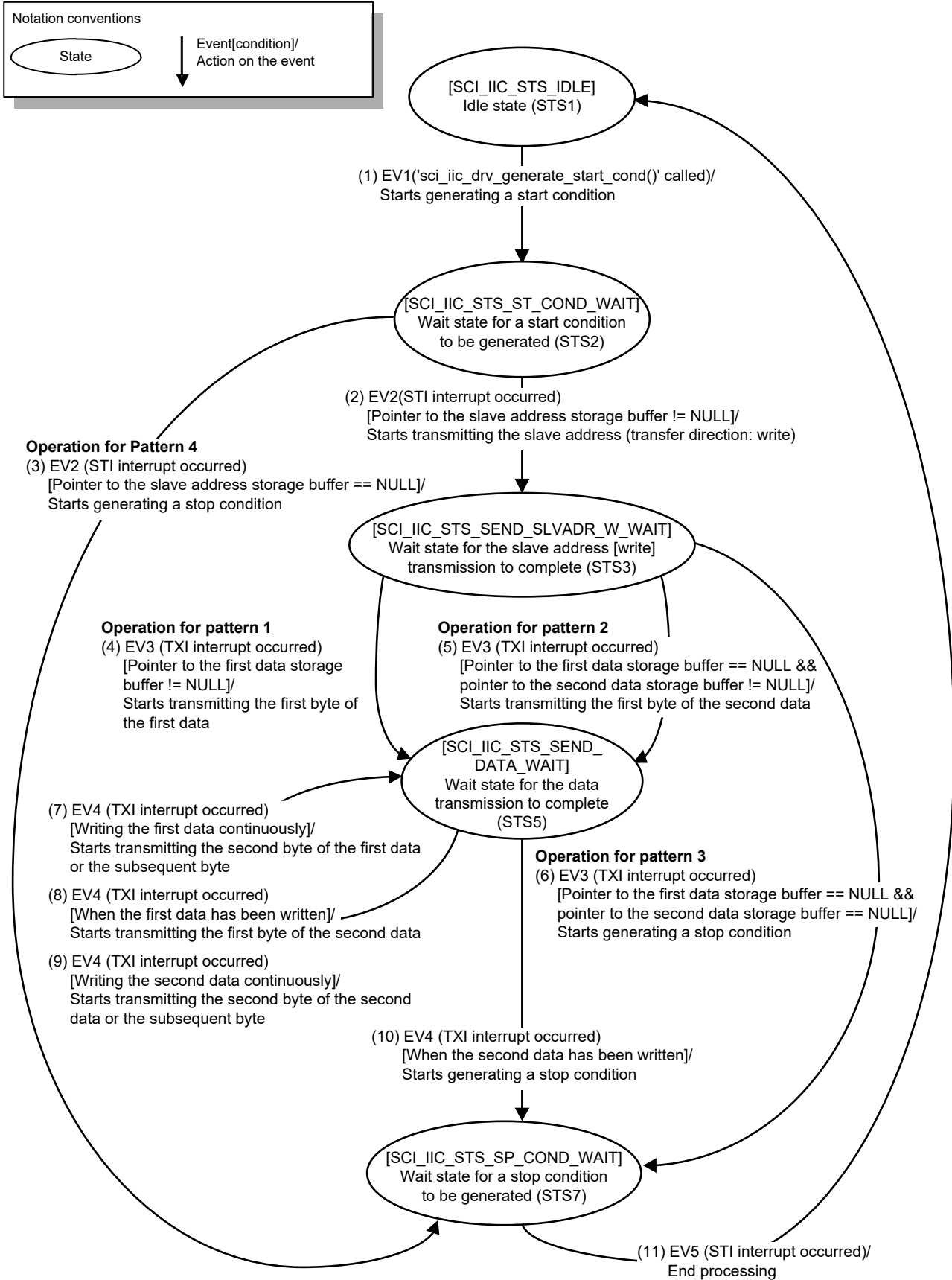

Figure 6.2 State Transition on Master Transmission

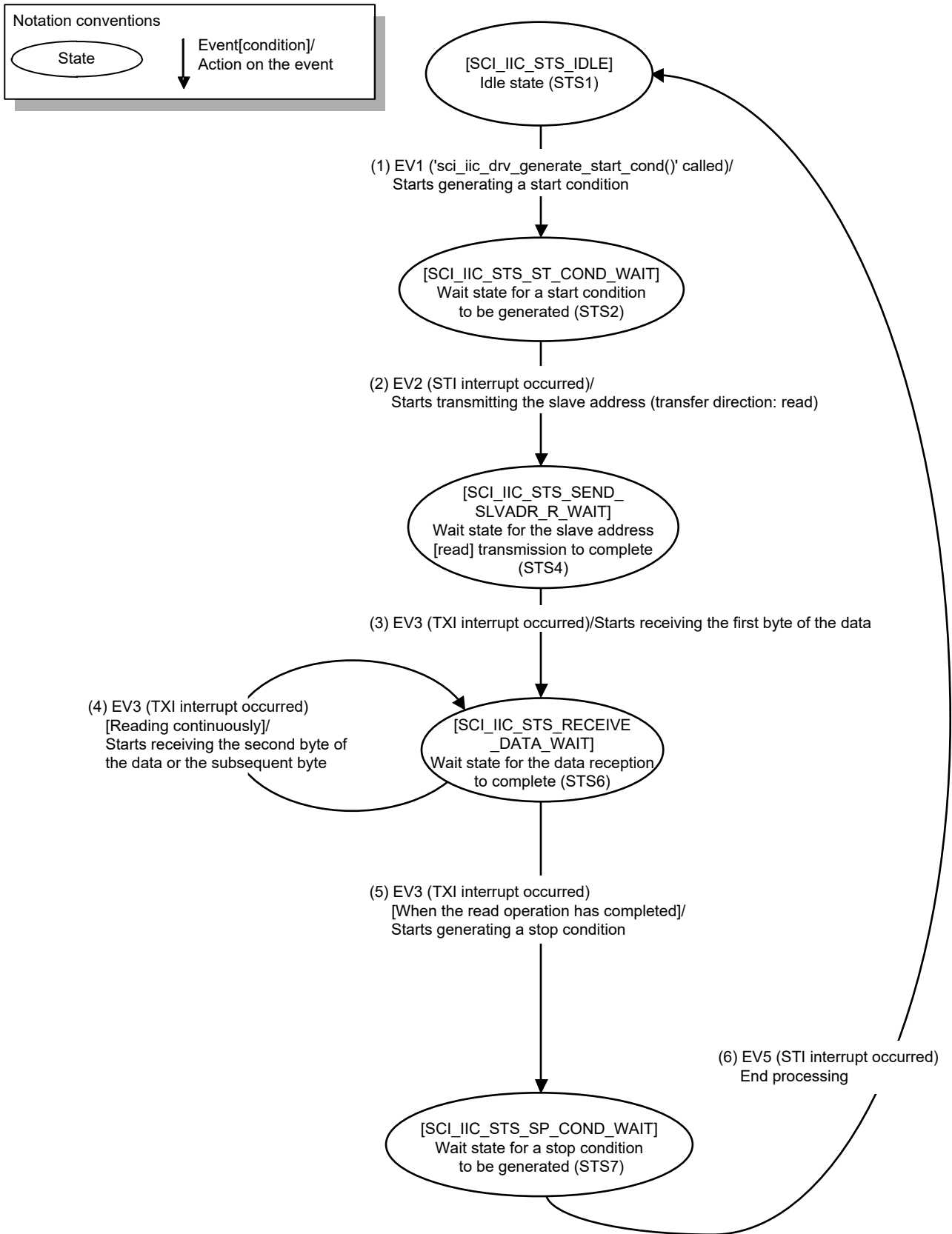

Figure 6.3 State Transition on Master Reception

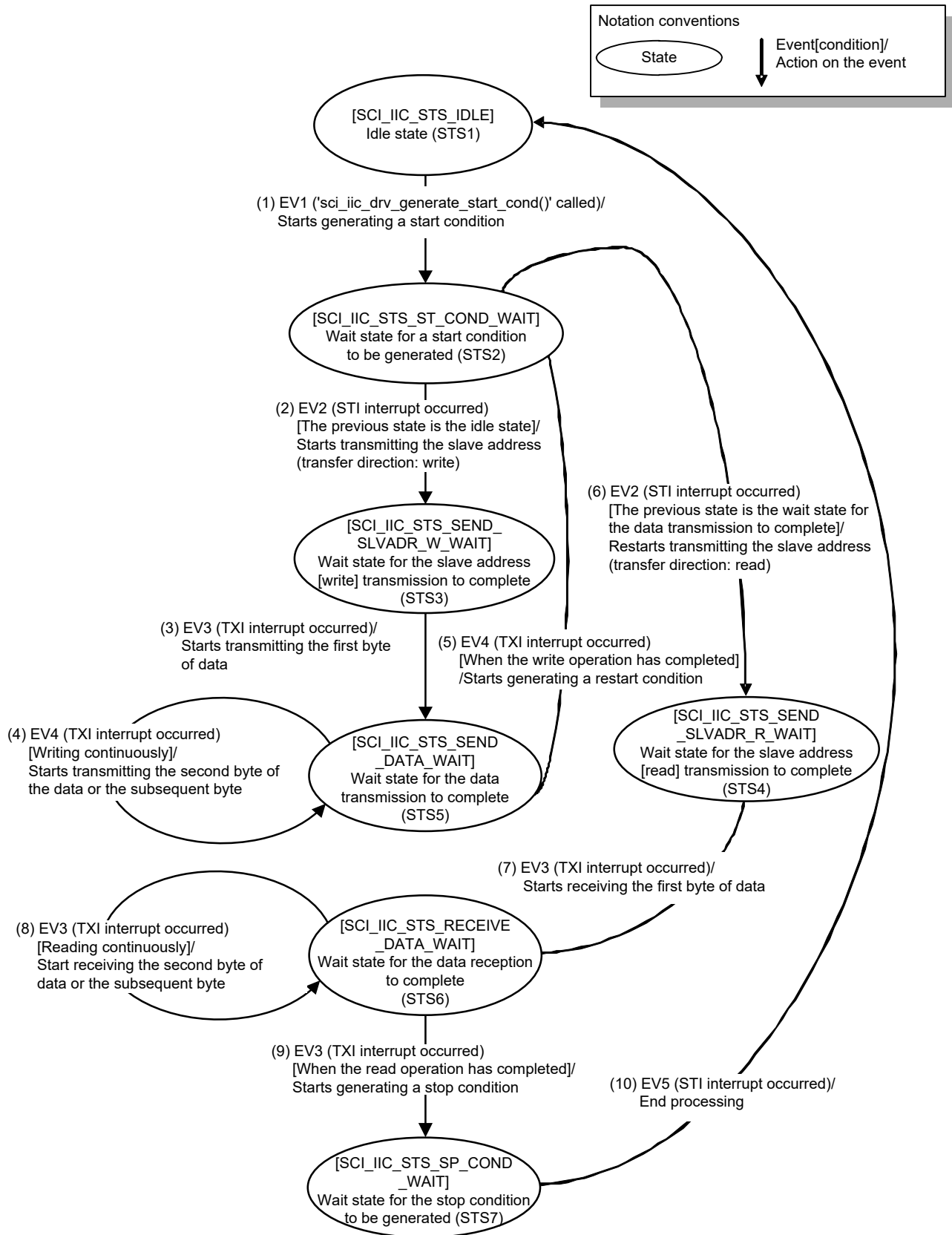

Figure 6.4 State Transition on Master Transmit/Receive

6.1.4 Protocol State Transition Table

The processing when the events in Table 6.2 occur in the states in Table 6.1 is shown in the Table 6.3 Protocol State Transition. Refer to Table 6.4 for details of each function.

Table 6.3 Protocol State Transition Table (gc_sci_iic_mtx_tbi[[]])⁽¹⁾

State		Event						
		EV0	EV1	EV2	EV3	EV4	EV5	EV6
STS0	Uninitialized state [SCI_IIC_STS_NO_INIT]	Func0	ERR	ERR	ERR	ERR	ERR	ERR
STS1	Idle state [SCI_IIC_STS_IDLE]	ERR	Func1	ERR	ERR	ERR	ERR	ERR
STS2	Wait state for a start condition to be generated [SCI_IIC_STS_ST_COND_WAIT]	ERR	ERR	Func2	ERR	ERR	ERR	Func7
STS3	Wait state for the slave address [write] transmission to complete [SCI_IIC_STS_SEND_SLVADR_W_WAIT]	ERR	ERR	ERR	Func3	ERR	ERR	Func7
STS4	Wait state for the slave address [read] transmission to complete [SCI_IIC_STS_SEND_SLVADR_R_WAIT]	ERR	ERR	ERR	Func3	ERR	ERR	Func7
STS5	Wait state for the data transmission to complete [SCI_IIC_STS_SEND_DATA_WAIT]	ERR	ERR	ERR	ERR	Func4	ERR	Func7
STS6	Wait state for the data reception to complete [SCI_IIC_STS_RECEIVE_DATA_WAIT]	ERR	ERR	ERR	Func5	ERR	ERR	Func7
STS7	Wait state for the stop condition to be generated [SCI_IIC_STS_SP_COND_WAIT]	ERR	ERR	ERR	ERR	ERR	Func6	Func7

Note:

1. ERR indicates SCI_IIC_ERR_OTHER. When an unexpected event is notified in a state, error processing will be performed.

6.1.5 Functions Used on Protocol State Transitions

Table 6.4 lists the Functions Used on Protocol State Transition.

Table 6.4 Functions Used on Protocol State Transition

Processing	Function	Overview
Func0	sci_iic_init_driver()	Initialization
Func1	sci_iic_generate_start_cond()	Start condition generation
Func2	sci_iic_after_gen_start_cond()	Processing after generating a start condition
Func3	sci_iic_after_send_slvadr()	Processing after transmitting the slave address
Func4	sci_iic_write_data_sending()	Data transmission
Func5	sci_iic_read_data_receiving()	Data reception
Func6	sci_iic_release()	Communication end processing
Func7	sci_iic_nack()	NACK error processing

6.1.6 Flag States on State Transitions

1) Controlling states of channels

Multiple slaves on the same bus can be exclusively controlled using the channel state flag 'g_sci_iic_ChStatus[]'. Each channel has the channel state flag and the flag is controlled by the global variable. When the initialization for this module has completed and the target bus is not being used for a communication, the flag becomes 'SCI_IIC_IDLE/SCI_IIC_FINISH/SCI_IIC_NACK' (idle state) and communication is available. When the bus is being used for communication, the flag becomes 'SCI_IIC_COMMUNICATION' (communicating). When communication is started, the flag is always verified. Thus, if a device is communicating on a bus, then no other device can start communicating on the same bus. Simultaneous communication can be achieved by controlling the channel state flag for each channel.

2) Controlling states of devices

Multiple slaves on the same channel can be controlled using the device state flag 'dev_sts' in the I²C communication information structure. The device state flag stores the state of communication for the device.

Table 6.5 lists States of Flags on State Transitions.

Table 6.5 States of Flags on State Transitions

State	Channel State Flag	Device State Flag (Communication Device)	I ² C Protocol Operating Mode	Current State of the Protocol Control
	g_sci_iic_ChStatus[]	I ² C Communication Information Structure *p_dev_sts	Internal Communication Information Structure api_Mode	Internal Communication Information Structure api_N_status
Uninitialized state	SCI_IIC_NO_INIT	SCI_IIC_NO_INIT	SCI_IIC_MODE_NONE	SCI_IIC_STS_NO_INIT
Idle state	SCI_IIC_IDLE	SCI_IIC_IDLE	SCI_IIC_MODE_NONE	SCI_IIC_STS_IDLE
	SCI_IIC_FINISH	SCI_IIC_FINISH		
	SCI_IIC_NACK	SCI_IIC_NACK		
Communicating (master transmission)	SCI_IIC_ COMMUNICATION	SCI_IIC_ COMMUNICATION	SCI_IIC_MODE_WRITE	SCI_IIC_STS_ST_COND_WAIT
				SCI_IIC_STS_SEND_SLVADR_W_WAIT
				SCI_IIC_STS_SEND_DATA_WAIT
				SCI_IIC_STS_SP_COND_WAIT
Communicating (master reception)	SCI_IIC_ COMMUNICATION	SCI_IIC_ COMMUNICATION	SCI_IIC_MODE_READ	SCI_IIC_STS_ST_COND_WAIT
				SCI_IIC_STS_SEND_SLVADR_R_WAIT
				SCI_IIC_STS_RECEIVE_DATA_WAIT
				SCI_IIC_STS_SP_COND_WAIT
Communicating (master transmit/receive)	SCI_IIC_ COMMUNICATION	SCI_IIC_ COMMUNICATION	SCI_IIC_MODE_ COMBINED	SCI_IIC_STS_ST_COND_WAIT
				SCI_IIC_STS_SEND_SLVADR_W_WAIT
				SCI_IIC_STS_SEND_SLVADR_R_WAIT
				SCI_IIC_STS_SEND_DATA_WAIT
				SCI_IIC_STS_RECEIVE_DATA_WAIT
SCI_IIC_STS_SP_COND_WAIT				
Error state	SCI_IIC_ERROR	SCI_IIC_ERROR	—	—

6.2 Interrupt Request Generation Timing

This section describes the interrupt request generation timings in this module.

Legend:

ST: Start condition

AD6 to AD0: Slave address

/W: Transfer direction bit: 0 (Write)

R: Transfer direction bit: 1 (Read)

/ACK: Acknowledge: 0

NACK: Acknowledge: 1

D7 to D0: Data

RST: Restart condition

SP: Stop condition

6.2.1 Master Transmission

(1) Pattern 1

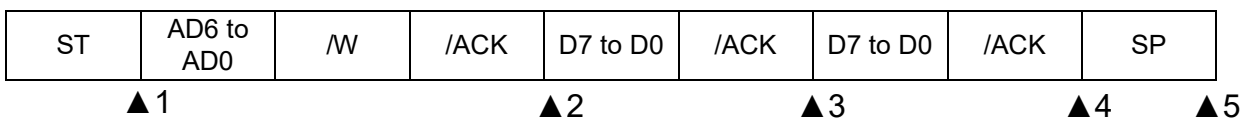

▲ 1: STI (START) interrupt: Start condition detected

▲ 2: TXI interrupt: Address transmission completed (transfer direction bit: write) ⁽¹⁾

▲ 3: TXI interrupt: Data transmission completed (first data) ⁽¹⁾

▲ 4: TXI interrupt: Data transmission completed (second data) ⁽¹⁾

▲ 5: STI (STOP) interrupt: Stop condition detected

(2) Pattern 2

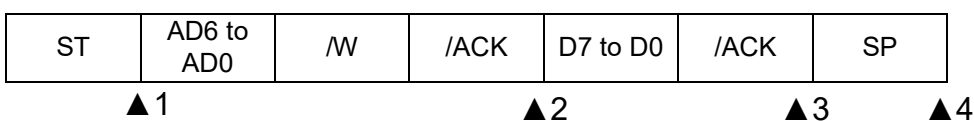

▲ 1: STI (START) interrupt: Start condition detected

▲ 2: TXI interrupt: Address transmission completed (transfer direction bit: write) ⁽¹⁾

▲ 3: TXI interrupt: Data transmission completed (second data) ⁽¹⁾

▲ 4: STI (STOP) interrupt: Stop condition detected

Note:

1. An interrupt request is generated on the rising edge of the ninth clock.

(3) Pattern 3



- ▲ 1: STI (START) interrupt: Start condition detected
- ▲ 2: TXI interrupt: Address transmission completed (transfer direction bit: write) ⁽¹⁾
- ▲ 3: STI (STOP) interrupt: Stop condition detected

(4) Pattern 4

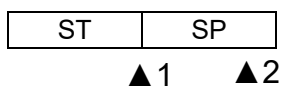

- ▲ 1: STI (START) interrupt: Start condition detected
- ▲ 2: STI (STOP) interrupt: Stop condition detected

Note:

1. An interrupt request is generated on the rising edge of the ninth clock.

6.2.2 Master Reception

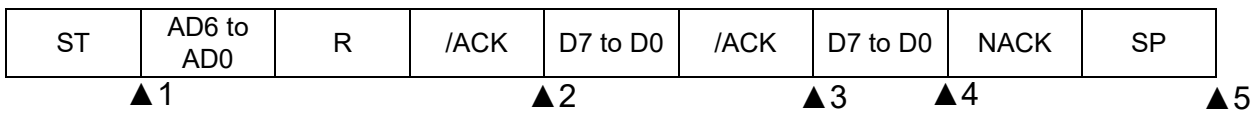

- ▲ 1: STI (START) interrupt: Start condition detected
- ▲ 2: TXI interrupt: Address transmission completed (transfer direction bit: read) ⁽¹⁾
- ▲ 3: TXI interrupt: Reception for the last data - 1 completed (second data) ⁽¹⁾
- ▲ 4: TXI interrupt: Reception for the last data completed (second data) ⁽²⁾
- ▲ 5: STI (STOP) interrupt: Stop condition detected

Notes:

1. An interrupt request is generated on the rising edge of the ninth clock.
2. An interrupt request is generated on the rising edge of the eighth clock.

6.2.3 Master Transmit/Receive

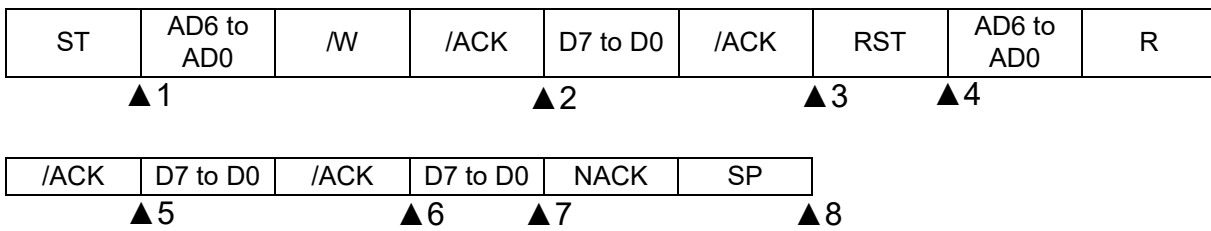

- ▲ 1: STI (START) interrupt: Start condition detected
- ▲ 2: TXI interrupt: Address transmission completed (transfer direction bit: write) ⁽¹⁾
- ▲ 3: TXI interrupt: Data transmission completed (first data) ⁽¹⁾
- ▲ 4: STI (START) interrupt: Restart condition detected
- ▲ 5: TXI interrupt: Address transmission completed (transfer direction bit: read) ⁽¹⁾
- ▲ 6: TXI interrupt: Reception for the last data - 1 completed (second data) ⁽¹⁾
- ▲ 7: TXI interrupt: Reception for the last data completed (second data) ⁽²⁾
- ▲ 8: STI (STOP) interrupt: Stop condition detected

Notes:

1. An interrupt request is generated on the rising edge of the ninth clock.
2. An interrupt request is generated on the rising edge of the eighth clock.

6.3 Operating Test Environment

This section describes for detailed the operating test environments of this module.

Table 6.6 Operation Test Environment for Rev.1.60 and Rev.1.70.

Item	Contents
Integrated development environment	Renesas Electronics e ² studio V3.1.2.09
C compiler	Renesas Electronics C/C++ compiler for RX Family V.2.02.00
	Compiler options: The integrated development environment default settings are used, with the following option added. -lang = c99
Endian order	Big-endian/Little-endian
Module version	Rev.1.60 and Rev.1.70
Board used	Renesas Starter Kit for RX111 (product number. R0K505111SxxxBE) Renesas Starter Kit for RX113 (product number. R0K505113SxxxBE) Renesas Starter Kit for RX231 (product number. R0K505231SxxxBE) Renesas Starter Kit+ for RX63N (product number. R0K50563NSxxxBE) Renesas Starter Kit+ for RX64M (product number. R0K50564MSxxxBE) Renesas Starter Kit+ for RX71M (product number. R0K50571MSxxxBE)

Table 6.7 Operation Test Environment for Rev.1.80.

Item	Contents
Integrated development environment	Renesas Electronics e ² studio V4.0.2.008
C compiler	Renesas Electronics C/C++ compiler for RX Family V.2.03.00
	Compiler options: The integrated development environment default settings are used, with the following option added. -lang = c99
Endian order	Big-endian/Little-endian
Module version	Rev.1.80
Board used	Renesas Starter Kit for RX130 (product number. R0K505113SxxxBE) Renesas Starter Kit for RX23T (product number. RTK500523TSxxxxxBE)

Table 6.8 Operation Confirmation Environment for Rev.1.90.

Item	Contents
Integrated development environment	Renesas Electronics e ² studio V4.1.0.018
C compiler	Renesas Electronics C/C++ compiler for RX Family V.2.03.00
	Compiler options: The integrated development environment default settings are used, with the following option added. -lang = c99
Endian order	Big-endian/Little-endian
Module version	Rev.1.90
Board used	Renesas Starter Kit for RX111 (product number. R0K505111SxxxBE) Renesas Starter Kit for RX113 (product number. R0K505113SxxxBE) Renesas Starter Kit for RX130 (product number. RTK5005130SxxxxxBE) Renesas Starter Kit for RX231 (product number. R0K505231SxxxBE) Renesas Starter Kit for RX23T (product number. RTK500523TSxxxxxBE) Renesas Starter Kit for RX24T (product number. RTK500524TSxxxxxBE) Renesas Starter Kit for RX63N (product number. R0K50563NSxxxBE) Renesas Starter Kit for RX64M (product number. R0K50564MSxxxBE) Renesas Starter Kit for RX71M (product number. R0K50571MSxxxBE)

Table 6.9 Operation Confirmation Environment for Rev.2.00.

Item	Contents
Integrated development environment	Renesas Electronics e ² studio V5.0.1.005
C compiler	Renesas Electronics C/C++ compiler for RX Family V.2.05.00
	Compiler options: The integrated development environment default settings are used, with the following option added. -lang = c99
Endian order	Big-endian/Little-endian
Module version	Rev.2.00
Board used	Renesas Starter Kit for RX231 (product number. R0K505231SxxxBE) Renesas Starter Kit+ for RX65N (product number. RTK500565NSxxxxxBE) Renesas Starter Kit for RX111 (product number. R0K505111SxxxBE) Renesas Starter Kit for RX130 (product number. RTK5005130SxxxxxBE) Renesas Starter Kit for RX231 (product number. R0K505231SxxxBE) Renesas Starter Kit for RX23T (product number. RTK500523TSxxxxxBE) Renesas Starter Kit for RX24T (product number. RTK500524TSxxxxxBE) Renesas Starter Kit+ for RX63N (product number. R0K50563NSxxxBE) Renesas Starter Kit+ for RX64M (product number. R0K50564MSxxxBE) Renesas Starter Kit+ for RX65N (product number. RTK500565NSxxxxxBE) Renesas Starter Kit+ for RX71M (product number. R0K50571MSxxxBE)

Table 6.10 Operation Confirmation Environment for Rev.2.20.

Item	Contents
Integrated development environment	Renesas Electronics e ² studio V6.0.0.001
C compiler	Renesas Electronics C/C++ compiler for RX Family V.2.06.00 C/C++ compiler for RX Family V.2.07.00
	Compiler options: The integrated development environment default settings are used, with the following option added. -lang = c99
Endian order	Big-endian/Little-endian
Module version	Rev.2.20
Board used	Renesas Starter Kit for RX24U (product number. RTK50524USxxxxxBE) Renesas Starter Kit for RX130-512KB (product number. RTK5051308SxxxxxBE) Renesas Starter Kit+ for RX65N-2MB (product number. RTK50565N2SxxxxxBE)

Table 6.11 Operation Confirmation Environment for Rev.2.30.

Item	Contents
Integrated development environment	Renesas Electronics e ² studio V7.0.0
C compiler	Renesas Electronics C/C++ compiler for RX Family V.3.00.00
	Compiler options: The integrated development environment default settings are used, with the following option added. -lang = c99
Endian order	Big-endian/Little-endian
Module version	Rev.2.30
Board used	Renesas Starter Kit for RX66T (product number. RTK50566T0SxxxxxBE)

Table 6.12 Operation Confirmation Environment for Rev.2.31.

Item	Contents
Integrated development environment	Renesas Electronics e ² studio V7.1.0
C compiler	Renesas Electronics C/C++ compiler for RX Family V.3.00.00
	Compiler options: The integrated development environment default settings are used, with the following option added. -lang = c99
Endian order	Big-endian/Little-endian
Module version	Rev.2.31

Table 6.13 Operation Confirmation Environment for Rev.2.40.

Item	Contents
Integrated development environment	Renesas Electronics e ² studio V7.3.0
C compiler	Renesas Electronics C/C++ compiler for RX Family V.3.01.00
	Compiler options: The integrated development environment default settings are used, with the following option added. -lang = c99
Endian order	Big-endian/Little-endian
Module version	Rev.2.40
Board used	Renesas Starter Kit for RX72T (product number. RTK5572Txxxxxxxxxx)

Table 6.14 Operation Confirmation Environment for Rev.2.41.

Item	Contents
Integrated development environment	Renesas Electronics e ² studio V7.3.0 IAR Embedded Workbench for Renesas RX 4.10.01
C compiler	Renesas Electronics C/C++ Compiler Package for RX Family V.3.01.00 Compiler option: The following option is added to the default settings of the integrated development environment. -lang = c99
	GCC for Renesas RX 4.08.04.201803 Compiler option: The following option is added to the default settings of the integrated development environment. -std=gnu99
	IAR C/C++ Compiler for Renesas RX version 4.10.01 Compiler option: The default settings of the integrated development environment.
Endian order	Big-endian/Little-endian
Module version	Rev.2.41
Board used	Renesas Starter Kit+ for RX65N (product number. RTK500565Nxxxxxx)

Table 6.15 Operation Confirmation Environment for Rev.2.42.

Item	Contents
Integrated development environment	Renesas Electronics e ² studio V7.2.0
C compiler	Renesas Electronics C/C++ compiler for RX Family V.3.01.00
	Compiler options: The integrated development environment default settings are used, with the following option added. -lang = c99
Endian order	Big-endian/Little-endian
Module version	Rev.2.42
Board used	Renesas Solution Starter Kit for RX23W (product No.: RTK5523Wxxxxxxxxxx)

Table 6.16 Operation Confirmation Environment for Rev.2.43.

Item	Contents
Integrated development environment	Renesas Electronics e ² studio V7.4.0 IAR Embedded Workbench for Renesas 4.12.01
C compiler	Renesas Electronics C/C++ Compiler Package for RX Family V.3.01.00 Compiler option: The following option is added to the default settings of the integrated development environment. -lang = c99
	GCC for Renesas RX 4.08.04.201902 Compiler option: The following option is added to the default settings of the integrated development environment. -std=gnu99
	IAR C/C++ Compiler for Renesas RX version 4.12.01 Compiler option: The default settings of the integrated development environment.
Endian order	Big-endian/Little-endian
Module version	Rev.2.43
Board used	Renesas Starter Kit+ for RX72M (product number. RTK5572Mxxxxxxxxxx)

Table 6.17 Operation Confirmation Environment for Rev.2.44.

Item	Contents
Integrated development environment	Renesas Electronics e ² studio V7.3.0 IAR Embedded Workbench for Renesas 4.12.01
C compiler	Renesas Electronics C/C++ Compiler Package for RX Family V.3.01.00 Compiler option: The following option is added to the default settings of the integrated development environment. -lang = c99
	GCC for Renesas RX 4.08.04.201902 Compiler option: The following option is added to the default settings of the integrated development environment. -std=gnu99
	IAR C/C++ Compiler for Renesas RX version 4.12.01 Compiler option: The default settings of the integrated development environment.
Endian order	Big-endian/Little-endian
Module version	Rev.2.44
Board used	RX13T CPU Card (product number.RTK0EMXA10C00000BJ)

Table 6.18 Operation Confirmation Environment for Rev.2.45.

Item	Contents
Integrated development environment	Renesas Electronics e ² studio 7.4.0 IAR Embedded Workbench for Renesas 4.12.01
C compiler	Renesas Electronics C/C++ Compiler Package for RX Family V.3.01.00 Compiler option: The following option is added to the default settings of the integrated development environment. -lang = c99
	GCC for Renesas RX 4.08.04.201902 Compiler option: The following option is added to the default settings of the integrated development environment. -std=gnu99
	IAR C/C++ Compiler for Renesas RX version 4.12.01 Compiler option: The default settings of the integrated development environment.
Endian order	Big-endian/Little-endian
Module version	Rev.2.45
Board used	Renesas Starter Kit+ for RX72N (product number. RTK5572Nxxxxxxxxxx) Renesas Starter Kit+ for RX72M (product number. RTK5572Mxxxxxxxxxx)

Table 6.19 Operation Confirmation Environment for Rev.2.46.

Item	Contents
Integrated development environment	Renesas Electronics e ² studio 7.7.0 IAR Embedded Workbench for Renesas 4.13.01
C compiler	Renesas Electronics C/C++ Compiler Package for RX Family V.3.02.00 Compiler option: The following option is added to the default settings of the integrated development environment. -lang = c99
	GCC for Renesas RX 8.03.00.201904 Compiler option: The following option is added to the default settings of the integrated development environment. -std=gnu99
	IAR C/C++ Compiler for Renesas RX version 4.13.01 Compiler option: The default settings of the integrated development environment.
Endian order	Big-endian/Little-endian
Module version	Rev.2.46
Board used	Renesas Solution Starter Kit for RX23E-A (RTK0ESXB10C00001BJ)

Table 6.20 Operation Confirmation Environment for Rev.2.47.

Item	Contents
Integrated development environment	Renesas Electronics e ² studio Version 2020-10 (20.10.0)
C compiler	Renesas Electronics C/C++ Compiler Package for RX Family V.3.02.00 Compiler option: The following option is added to the default settings of the integrated development environment. -lang = c99
Endian order	Big-endian/Little-endian
Module version	Rev.2.47
Board used	Renesas Starter Kit for RX231 (product number. R0K505231SxxxBE) Renesas Starter Kit+ for RX64M (product number. R0K50564MSxxxBE)

Table 6.21 Operation Confirmation Environment for Rev.2.48.

Item	Contents
Integrated development environment	Renesas Electronics e ² studio Version 2021-01 (21.1.0) IAR Embedded Workbench for Renesas 4.14.01
C compiler	Renesas Electronics C/C++ Compiler Package for RX Family V.3.03.00 Compiler option: The following option is added to the default settings of the integrated development environment. -lang = c99
	GCC for Renesas RX 8.03.00.202002 Compiler option: The following option is added to the default settings of the integrated development environment. -std=gnu99
	IAR C/C++ Compiler for Renesas RX version 4.14.01 Compiler option: The default settings of the integrated development environment.
Endian order	Big-endian/Little-endian
Module version	Rev.2.48
Board used	Renesas Starter Kit+ for RX671 (product number. RTK55671xxxxxxxxxx)

Table 6.22 Operation Confirmation Environment for Rev.2.49.

Item	Contents
Integrated development environment	Renesas Electronics e ² studio Version 2021-07 (21.7.0) IAR Embedded Workbench for Renesas 4.20.01
C compiler	Renesas Electronics C/C++ Compiler Package for RX Family V.3.03.00 Compiler option: The following option is added to the default settings of the integrated development environment. -lang = c99
	GCC for Renesas RX 8.03.00.202102 Compiler option: The following option is added to the default settings of the integrated development environment. -std=gnu99
	IAR C/C++ Compiler for Renesas RX version 4.20.01 Compiler option: The default settings of the integrated development environment.
Endian order	Big-endian/Little-endian
Module version	Rev.2.49
Board used	Target board for RX140 (product number. RTK5RX140xxxxxxxxxx)

Table 6.23 Operation Confirmation Environment for Rev.2.50.

Item	Contents
Integrated development environment	Renesas Electronics e ² studio Version 2022-04 (22.4.0) IAR Embedded Workbench for Renesas 4.20.03
C compiler	Renesas Electronics C/C++ Compiler Package for RX Family V.3.04.00 Compiler option: The following option is added to the default settings of the integrated development environment. -lang = c99
	GCC for Renesas RX 8.03.00.202104 Compiler option: The following option is added to the default settings of the integrated development environment. -std=gnu99 Linker option: The following user defined option should be added to the default settings of the integrated development environment, if “Optimize size (-Os)” is used: -Wl,--no-gc-sections This is to work around a GCC linker issue whereby the linker erroneously discard interrupt functions declared in FIT peripheral module
	IAR C/C++ Compiler for Renesas RX version 4.20.03 Compiler option: The default settings of the integrated development environment.
Endian order	Big-endian/Little-endian
Module version	Rev.2.50
Board used	Renesas Starter Kit for RX660 (product No.: RTK5056609HCxxxxBJ)

Table 6.24 Operation Confirmation Environment for Rev.2.60.

Item	Contents
Integrated development environment	Renesas Electronics e ² studio Version 2022-10 IAR Embedded Workbench for Renesas 4.20.03
C compiler	Renesas Electronics C/C++ Compiler Package for RX Family V.3.05.00 Compiler option: The following option is added to the default settings of the integrated development environment. -lang = c99
	GCC for Renesas RX 8.03.00.202204 Compiler option: The following option is added to the default settings of the integrated development environment. -std=gnu99 Linker option: The following user defined option should be added to the default settings of the integrated development environment, if “Optimize size (-Os)” is used: -Wl,--no-gc-sections This is to work around a GCC linker issue whereby the linker erroneously discard interrupt functions declared in FIT peripheral module
	IAR C/C++ Compiler for Renesas RX version 4.20.03 Compiler option: The default settings of the integrated development environment.
Endian order	Big-endian/Little-endian
Module version	Rev.2.60
Board used	Renesas Flexible Motor Control Kit for RX26T (Part Number: RTK0EMXE70S00020BJ) Renesas Starter Kit for RX64M (product No.: R0K50564Mxxxxxx) Renesas Starter Kit+ for RX72N (product No.: RTK5572NNDcxxxxxx) Renesas Starter Kit for RX231 (product No.: R0K505231SxxxBE) Renesas Starter Kit+ for RX671 (product No.: RTK55671EDCxxxxxBJ)

Table 6.25 Operation Confirmation Environment for Rev.2.70.

Item	Contents
Integrated development environment	Renesas Electronics e ² studio Version 2023-04 IAR Embedded Workbench for Renesas 4.20.03
C compiler	Renesas Electronics C/C++ Compiler Package for RX Family V.3.05.00 Compiler option: The following option is added to the default settings of the integrated development environment. -lang = c99
	GCC for Renesas RX 8.03.00.202204 Compiler option: The following option is added to the default settings of the integrated development environment. -std=gnu99 Linker option: The following user defined option should be added to the default settings of the integrated development environment, if “Optimize size (-Os)” is used: -WI,--no-gc-sections This is to work around a GCC linker issue whereby the linker erroneously discard interrupt functions declared in FIT peripheral module
	IAR C/C++ Compiler for Renesas RX version 4.20.03 Compiler option: The default settings of the integrated development environment.
Endian order	Big-endian/Little-endian
Module version	Rev.2.70
Board used	Renesas Solution Starter Kit for RX23E-B (product No.: RTK0ES1001C00001BJ)

Table 6.26 Operation Confirmation Environment for Rev.2.71.

Item	Contents
Integrated development environment	Renesas Electronics e ² studio Version 2023-07 IAR Embedded Workbench for Renesas 4.20.03
C compiler	Renesas Electronics C/C++ Compiler Package for RX Family V.3.05.00 Compiler option: The following option is added to the default settings of the integrated development environment. -lang = c99
	GCC for Renesas RX 8.03.00.202305 Compiler option: The following option is added to the default settings of the integrated development environment. -std=gnu99 Linker option: The following user defined option should be added to the default settings of the integrated development environment, if “Optimize size (-Os)” is used: -WI,--no-gc-sections This is to work around a GCC linker issue whereby the linker erroneously discard interrupt functions declared in FIT peripheral module
	IAR C/C++ Compiler for Renesas RX version 4.20.03 Compiler option: The default settings of the integrated development environment.
Endian order	Big-endian/Little-endian
Module version	Rev.2.71
Board used	Renesas Starter Kit+ for RX671 (product No.: RTK55671EDCxxxxxBJ)

Table 6.27 Operation Confirmation Environment for Rev.2.80.

Item	Contents
Integrated development environment	Renesas Electronics e ² studio Version 2024-07 IAR Embedded Workbench for Renesas 5.10.01
C compiler	Renesas Electronics C/C++ Compiler Package for RX Family V.3.06.00 Compiler option: The following option is added to the default settings of the integrated development environment. -lang = c99
	GCC for Renesas RX 8.03.00.202405 Compiler option: The following option is added to the default settings of the integrated development environment. -std=gnu99 Linker option: The following user defined option should be added to the default settings of the integrated development environment, if "Optimize size (-Os)" is used: -Wl,--no-gc-sections This is to work around a GCC linker issue whereby the linker erroneously discard interrupt functions declared in FIT peripheral module
	IAR C/C++ Compiler for Renesas RX version 5.10.01 Compiler option: The default settings of the integrated development environment.
Endian order	Big-endian/Little-endian
Module version	Rev.2.80
Board used	Evaluation Kit for RX261 (product No.: RTK5EK2610S00011BJ)

6.4 Troubleshooting

(1) Q: I have added the FIT module to the project and built it. Then I got the error: Could not open source file "platform.h".

A: The FIT module may not be added to the project properly. Check if the method for adding FIT modules is correct with the following documents:

- When using CS+:

Application note "Adding Firmware Integration Technology Modules to CS+ Projects (R01AN1826)"

- When using e² studio:

Application note "Adding Firmware Integration Technology Modules to Projects (R01AN1723)"

When using a FIT module, the board support package FIT module (BSP module) must also be added to the project. For this, refer to the application note "Board Support Package Module Using Firmware Integration Technology (R01AN1685)".

(2) Q: I have added the FIT module to the project and built it. Then I got the error: This MCU is not supported by the current r_sci_iic_rx module.

A: The FIT module you added may not support the target device chosen in the user project. Check if the FIT module supports the target device for the project used.

(3) Q: I have added the FIT module to the project and built it. Then I got an error for when the configuration setting is wrong.

A: The setting in the file "r_sci_iic_rx_config.h" may be wrong. Check the file "r_sci_iic_rx_config.h". If there is a wrong setting, set the correct value for that. Refer to 2.7 Configuration Overview for details.

7. Sample Code

7.1 Example when Accessing One Slave Device Continuously with One Channel

This section describes an example of using one SCI channel in simple I²C mode to continuously write to one slave device.

The procedure is as follows:

1. Execute the R_SCI_IIC_Open function to use SCI channel 1 in the SCI simple I²C mode FIT module.
2. Execute the R_SCI_IIC_MasterSend function to write 3-byte data to device A.
3. Update the transmit data.
4. Execute the R_SCI_IIC_MasterSend function to write 3-byte data to device A.
5. Execute the R_SCI_IIC_Close function to release SCI channel 1 from the SCI simple I²C mode FIT module.

```
#include <stddef.h> // NULL definition
#include "platform.h"
#include "r_sci_iic_rx_if.h"

/* Defines the number of retries when a NACK is detected. */
#define RETRY_TMO 10

/* Defines the number of software loops to wait until next communication starts when retrying*/
#define RETRY_WAIT_TIME 1000

/* Transmit size */
#define SEND_SIZE 3

/* Mode definitions in the sample code. */
typedef enum
{
    IDLE = 0U,           /* Being in idle state */
    BUSY,               /* I2C communication being performed */
    INITIALIZE,         /* Simple I2C mode FIT module initialization */
    DEVICE_A_WRITE,     /* Writing device A */
    FINISH,             /* Communication completed */
    RETRY_WAIT_DEV_A_WR, /* Waiting for retry writing device A */
    ERROR               /* Error occurred */
} sample_mode_t;

/* Variable for modes in the sample code */
volatile uint8_t sample_mode;

/* Variable for the number of retries */
uint32_t retry_cnt;

/* Variable for the number of transmissions */
uint8_t send_num = 0;

void main(void);
void Callback_deviceA(void);

void main(void)
{
    sci_iic_return_t ret; /* For verifying the return value of the API function */
    volatile uint32_t retry_wait_cnt = 0; /* Counter for adjusting the retry interval */

    sci_iic_info_t iic_info_deviceA; /* Information structure for device A */
    uint8_t slave_addr_deviceA[1] = {0x50}; /* Slave address of device A */
    uint8_t access_addr_deviceA[1] = {0x00}; /* Address to be accessed in device A */
    uint8_t send_data[6] = {0x81, 0x82, 0x83, 0x84, 0x85, 0x86}; /* Transmit data */
```

The following abbreviations are used in the program example:
 - ST: Start condition
 - SP: Stop condition

Figure 7.1 Example when Accessing One Slave Device Continuously with One Channel (1/4)

```

sample_mode = INITIALIZE;                                     /* Proceed to initialization processing */

while(1)
{
    switch(sample_mode)
    {
        /* Being in idle state */
        case IDLE:
            /* No operation is performed. */
            break;

            /* I2C communication being performed */
        case BUSY:
            /* No operation is performed. */
            break;

        /* Initializes the simple I2C mode FIT module. */
        case INITIALIZE:
            /* Verifies if it is the first time to communicate with device A. */
            if (0 == send_num)
            {
                /* Verifies if channel 1 is currently communicating. */
                if (SCI_IIC_COMMUNICATION == g_sci_iic_ChStatus[1])
                {
                    sample_mode = ERROR;          /* Proceed to error processing */
                }
                else
                {
                    /* Configures the device A information structure (transmit pattern 1). */
                    iic_info_deviceA.p_slv_adr = slave_addr_deviceA;
                    iic_info_deviceA.p_data1st = access_addr_deviceA;
                    iic_info_deviceA.p_data2nd = send_data;
                    iic_info_deviceA.dev_sts = SCI_IIC_NO_INIT;
                    iic_info_deviceA.cnt1st = sizeof(access_addr_deviceA);
                    iic_info_deviceA.cnt2nd = SEND_SIZE;
                    iic_info_deviceA.callbackfunc = &Callback_deviceA;
                    iic_info_deviceA.ch_no = 1;
                }

                retry_cnt = 0;

                /* SCI open processing */
                ret = R_SCI_IIC_Open(&iic_info_deviceA);

                if (SCI_IIC_SUCCESS == ret)
                {
                    sample_mode = DEVICE_A_WRITE; /* Proceed to write processing for
                                                    device A */
                }
                else
                {
                    /* Error processing at the R_SCI_IIC_Open() function call */
                    sample_mode = ERROR;          /* Proceed to error processing */
                }
            }
            /* Verifies if it is the second or the subsequent continuous communication
            with device A. */
            else if (1 <= send_num)
            {
                /* Verifies if channel 1 is currently communicating. */
                if (SCI_IIC_COMMUNICATION == g_sci_iic_ChStatus[1])
                {
                    sample_mode = ERROR;          /* Proceed to error processing */
                }
                else
                {
                    /* Information structure for device A (master transmission pattern 1) */
                    access_addr_deviceA[0] = (access_addr_deviceA[0] + SEND_SIZE);
                    iic_info_deviceA.p_data1st = access_addr_deviceA;
                    iic_info_deviceA.p_data2nd = (send_data + (SEND_SIZE * send_num));
                    iic_info_deviceA.cnt1st = sizeof(access_addr_deviceA);
                    iic_info_deviceA.cnt2nd = SEND_SIZE;
                }
            }
    }
}

```

A loop is performed with empty processing during idle or I²C communication.

The channel state can be verified with the global variable "g_sci_iic_ChStatus[]".

Initializes the transmit counters and pointers for the second transmission.

Figure 7.2 Example when Accessing One Slave Device Continuously with One Channel (2/4)

```

        sample_mode = DEVICE_A_WRITE; /* Proceed to write processing for
                                        device A */
    }
}
break;

/* Writes data to device A */
case DEVICE_A_WRITE:
    retry_cnt = retry_cnt + 1;

    /* Starts master transmission. */
    ret = R_SCI_IIC_MasterSend(&iic_info_deviceA);

    if (SCI_IIC_SUCCESS == ret)
    {
        sample_mode = BUSY; /* Then the state becomes "I2C communication
                                being performed". */
    }
    else if (SCI_IIC_ERR_BUS_BUSY == ret)
    {
        sample_mode = RETRY_WAIT_DEV_A_WR; /* Proceed to a wait for retry */
    }
    else
    {
        /* Error processing at the R_SCI_IIC_MasterSend() function call */
        sample_mode = ERROR; /* Proceed to error processing */
    }
}
break;

/* Waits for retry writing device A. */
case RETRY_WAIT_DEV_A_WR:
    retry_wait_cnt = retry_wait_cnt + 1;

    if (RETRY_TMO < retry_cnt)
    {
        retry_wait_cnt = 0;
        sample_mode = ERROR; /* Proceed to error processing */
    }

    if (RETRY_WAIT_TIME < retry_wait_cnt)
    {
        retry_wait_cnt = 0;

        switch (sample_mode)
        {
            case RETRY_WAIT_DEV_A_WR:
                sample_mode = DEVICE_A_WRITE; /* Proceed to write processing for
                                                device A */
                break;

            default:
                /* No operation is performed. */
                break;
        }
    }
}
break;

```

Processing from ST generation to SP generation is performed by executing the R_SCI_IIC_MasterSend function in the FIT module. After SP is output, the specified callback function (Callback_deviceA()) is called.

When the communication target is the EEPROM, if write operation is performed by sending the write command, a NACK is returned until the write operation is completed. In the sample code, retry to start communication is performed until an ACK is returned.

Figure 7.3 Example when Accessing One Slave Device Continuously with One Channel (3/4)

```

/* Communication end processing */
case FINISH:
    /* SCI close processing */
    ret = R_SCI_IIC_Close(&iic_info_deviceA);

    if (SCI_IIC_SUCCESS == ret)
    {
        sample_mode = IDLE;           /* Then the state becomes "idle". */
    }
    else
    {
        /* Error processing at the R_SCI_IIC_Close() function call */
        sample_mode = ERROR;         /* Proceed to error processing */
    }
    break;

/* Error occurred */
case ERROR:
    /* No operation is performed. */
    break;

default:
    /* No operation is performed. */
    break;
}
}
}

void Callback_deviceA(void)
{
    volatile sci_iic_return_t ret;
    sci_iic_mcu_status_t iic_status;
    sci_iic_info_t iic_info_ch;
    iic_info_ch.ch_no = 1;

    /* Obtains the simple I2C status. */
    ret = R_SCI_IIC_GetStatus(&iic_info_ch, &iic_status);

    if (SCI_IIC_SUCCESS != ret)
    {
        /* Error processing at the R_SCI_IIC_GetStatus() function call */
        sample_mode = ERROR;         /* Proceed to error processing */
    }
    else
    {
        if (1 == iic_status.BIT.NACK)
        {
            /* Processing when NACK is detected with the iic_status flag verification. */
            sample_mode = RETRY_WAIT_DEV_A_WR;
        }
        else
        {
            retry_cnt = 0;
            send_num++;
            if (1 >= send_num)
            {
                sample_mode = INITIALIZE; /* Proceed to initialization processing */
            }
            else
            {
                sample_mode = FINISH; /* Proceed to communication end processing */
            }
        }
    }
}
}
}

```

When the communication has been completed, the SCI channel used can be released by calling the R_SCI_IIC_Close function.

Call the R_SCI_IIC_Close function in the following cases:

- When entering low power consumption mode.
- When communication error occurred.
- When the SCI channel used needs to be released.

Figure 7.4 Example when Accessing One Slave Device Continuously with One Channel (4/4)

7.2 Example when Accessing Two Slave Devices with One Channel

This section describes an example of using one SCI channel in simple I²C mode to write to and read from two slave devices. In the sample code, I²C communication information structure is configured for each accessing device.

The procedure is as follows:

1. Execute the R_SCI_IIC_Open function to use SCI channel 1 in the SCI simple I²C mode FIT module.
2. Execute the R_SCI_IIC_MasterSend function to write 3-byte data to device A.
3. Execute the R_SCI_IIC_MasterReceive function to read 3-byte data from device B.
4. Execute the R_SCI_IIC_Close function to release SCI channel 1 from the SCI simple I²C mode FIT module.

```

#include <stddef.h> // NULL definition
#include "platform.h"
#include "r_sci_iic_rx_if.h"

/* Defines the number of retries when a NACK is detected. */
#define RETRY_TMO 10

/* Defines the number of software loops to wait until next communication starts when retrying*/
#define RETRY_WAIT_TIME 1000

/* Transmit size */
#define SEND_SIZE 3

/* Receive size */
#define RECEIVE_SIZE 3

/* Definitions for mode management in the sample code */
typedef enum
{
    IDLE = 0U,           /* Being in idle state */
    BUSY,              /* I2C communication being performed */
    INITIALIZE,        /* Simple I2C mode FIT module initialization */
    DEVICE_A_WRITE,    /* Writing device A */
    DEVICE_B_READ,     /* Reading device B */
    FINISH,            /* Communication completed */
    RETRY_WAIT_DEV_A_WR, /* Waiting for retry writing device A */
    RETRY_WAIT_DEV_B_RD, /* Waiting for retry reading device B */
    ERROR              /* Error occurred */
} sample_mode_t;

/* Variable for modes in the sample code */
volatile uint8_t sample_mode;

/* Variable for the number of retries */
volatile uint32_t retry_cnt;

void main(void);
void Callback_deviceA(void);
void Callback_deviceB(void);

void main(void)
{
    volatile sci_iic_return_t ret; /* For verifying the return value of the API function */
    volatile uint32_t retry_wait_cnt = 0; /* Counter for adjusting the retry interval */

    sci_iic_info_t iic_info_deviceA; /* Information structure for device A */
    sci_iic_info_t iic_info_deviceB; /* Information structure for device B */

```

The following abbreviations are used in the program example:

- ST: Start condition
- SP: Stop condition

Declares information structures as many as devices to communicate.

Figure 7.5 Example when Accessing Two Slave Devices with One Channel (1/5)

```

uint8_t slave_addr_deviceA[1] = {0x51};      /* Slave address of device A */
uint8_t slave_addr_deviceB[1] = {0x52};      /* Slave address of device B */
uint8_t access_addr_deviceA[1] = {0x00};     /* Address to be accessed in device A */
uint8_t access_addr_deviceB[2] = {0x00,0x00}; /* Address to be accessed in device B */
uint8_t send_data[5]          = {0x81,0x82,0x83,0x84,0x85}; /* Transmit data */
uint8_t store_area[5]         = {0xFF,0xFF,0xFF,0xFF,0xFF}; /* For receive data storage*/

sample_mode = INITIALIZE;                    /* Proceed to initialization processing */

while(1)
{
    switch(sample_mode)
    {
        /* Being in idle state */
        case IDLE:
            /* No operation is performed. */
            break;

            /* I2C communication being performed */
        case BUSY:
            /* No operation is performed. */
            break;

        /* Initializes the simple I2C mode FIT module. */
        case INITIALIZE:
            /* Verifies if channel 1 is currently communicating. */
            if (SCI_IIC_COMMUNICATION == g_sci_iic_ChStatus[1])
            {
                sample_mode = ERROR;          /* Proceed to error processing */
            }
            else
            {
                /* Configures the device A information structure (master transmit pattern 1). */
                iic_info_deviceA.p_slv_adr = slave_addr_deviceA;
                iic_info_deviceA.p_data1st = access_addr_deviceA;
                iic_info_deviceA.p_data2nd = send_data;
                iic_info_deviceA.dev_sts = SCI_IIC_NO_INIT;
                iic_info_deviceA.cnt1st = sizeof(access_addr_deviceA);
                iic_info_deviceA.cnt2nd = SEND_SIZE;
                iic_info_deviceA.callbackfunc = &Callback_deviceA;
                iic_info_deviceA.ch_no = 1;

                /* Configures the device B information structure (master transmit/receive). */
                iic_info_deviceB.p_slv_adr = slave_addr_deviceB;
                iic_info_deviceB.p_data1st = access_addr_deviceB;
                iic_info_deviceB.p_data2nd = store_area;
                iic_info_deviceB.dev_sts = SCI_IIC_NO_INIT;
                iic_info_deviceB.cnt1st = sizeof(access_addr_deviceB);
                iic_info_deviceB.cnt2nd = RECEIVE_SIZE;
                iic_info_deviceB.callbackfunc = &Callback_deviceB;
                iic_info_deviceB.ch_no = 1;

                retry_cnt = 0;                /* Resets the number of retries. */

                /* SCI open processing */
                ret = R_SCI_IIC_Open(&iic_info_deviceA);

                if (SCI_IIC_SUCCESS == ret)
                {
                    sample_mode = DEVICE_A_WRITE; /* Proceed to write processing for device A */
                }
                else
                {
                    /* Error processing at the R_SCI_IIC_Open() function call. */
                    sample_mode = ERROR;          /* Proceed to error processing */
                }

                break;
            }
        }
    }
}

```

A loop is performed with empty processing during idle or I²C communication.

The channel state can be verified with the global variable "g_sci_iic_ChStatus[]".

The SCI resource is maintained for each channel. Thus the R_SCI_IIC_Open function is executed only once.

Figure 7.6 Example when Accessing Two Slave Devices with One Channel (2/5)

```

/* Writes data to device A. */
case DEVICE_A_WRITE:
    retry_cnt = retry_cnt + 1;

    /* Starts master transmission. */
    ret = R_SCI_IIC_MasterSend(&iic_info_deviceA);

    if (SCI_IIC_SUCCESS == ret)
    {
        sample_mode = BUSY;          /* Then the state becomes "I2C communication
                                     being performed". */
    }
    else if (SCI_IIC_ERR_BUS_BUSY == ret)
    {
        sample_mode = RETRY_WAIT_DEV_A_WR; /* Proceed to a wait for retry */
    }
    else
    {
        /* Error processing at the R_SCI_IIC_MasterSend() function call. */
        sample_mode = ERROR;          /* Proceed to error processing */
    }
    break;

/* Reads data from device B. */
case DEVICE_B_READ:
    retry_cnt = retry_cnt + 1;

    /* Starts master transmit/receive. */
    ret = R_SCI_IIC_MasterReceive(&iic_info_deviceB);

    if (SCI_IIC_SUCCESS == ret)
    {
        sample_mode = BUSY;          /* Then the state becomes "I2C communication
                                     being performed". */
    }
    else if (SCI_IIC_ERR_BUS_BUSY == ret)
    {
        sample_mode = RETRY_WAIT_DEV_B_RD; /* Proceed to a wait for retry */
    }
    else
    {
        /* Error processing at the R_SCI_IIC_MasterReceive() function call. */
        sample_mode = ERROR;          /* Proceed to error processing */
    }
    break;

/* Waits for retry writing device A. */
/* Waits for retry reading device B. */
case RETRY_WAIT_DEV_A_WR:
case RETRY_WAIT_DEV_B_RD:
    retry_wait_cnt = retry_wait_cnt + 1;

    if (RETRY_TMO < retry_cnt)
    {
        retry_wait_cnt = 0;
        sample_mode = ERROR;          /* Proceed to error processing */
    }

    if (RETRY_WAIT_TIME < retry_wait_cnt)
    {
        retry_wait_cnt = 0;

        switch (sample_mode)
        {
            case RETRY_WAIT_DEV_A_WR:
                sample_mode = DEVICE_A_WRITE; /* Proceed to write processing for device A */
                break;

            case RETRY_WAIT_DEV_B_RD:
                sample_mode = DEVICE_B_READ; /* Proceed to read processing for device B */
                break;
        }
    }

```

Processing from ST generation to SP generation is performed by executing the R_SCI_IIC_MasterSend function in the FIT module. After SP is output, the specified callback function (Callback_deviceA()) is called.

Processing from ST generation to SP generation is performed by executing the R_SCI_IIC_MasterReceive function in the FIT module. After SP is output, the specified callback function (Callback_deviceB()) is called.

When the communication target is the EEPROM, if write operation is performed by sending the write command, a NACK is returned until the write operation is completed. In the sample code, retry to start communication is performed until an ACK is returned.

Figure 7.7 Example when Accessing Two Slave Devices with One Channel (3/5)

```

        default:
            /* No operation is performed. */
            break;
    }
}
break;

/* Communication end processing */
case FINISH:
    /* SCI close processing */
    ret = R_SCI_IIC_Close(&iic_info_deviceA);

    if (SCI_IIC_SUCCESS == ret)
    {
        sample_mode = IDLE;           /* Then the state becomes "idle". */
    }
    else
    {
        /* Error processing at the R_SCI_IIC_Close() function call */
        sample_mode = ERROR;         /* Proceed to error processing */
    }
    break;

/* Error occurred */
case ERROR:
    /* No operation is performed. */
    break;

default:
    /* No operation is performed. */
    break;
}
}
}

void Callback_deviceA(void)
{
    volatile sci_iic_return_t ret;
    sci_iic_mcu_status_t iic_status;
    sci_iic_info_t iic_info_ch;
    iic_info_ch.ch_no = 1;

    /* Obtains the simple I2C status. */
    ret = R_SCI_IIC_GetStatus(&iic_info_ch, &iic_status);

    if (SCI_IIC_SUCCESS != ret)
    {
        /* Error processing at the R_SCI_IIC_GetStatus() function call */
        sample_mode = ERROR;         /* Proceed to error processing */
    }
    else
    {
        if (1 == iic_status.BIT.NACK)
        {
            /* Processing when NACK is detected with the iic_status flag verification */
            sample_mode = RETRY_WAIT_DEV_A_WR; /* Proceed to a wait for retry */
        }
        else
        {
            retry_cnt = 0;
            sample_mode = DEVICE_B_READ;     /* Proceed to read processing for device B */
        }
    }
}

void Callback_deviceB(void)
{
    volatile sci_iic_return_t ret;
    sci_iic_mcu_status_t iic_status;
    sci_iic_info_t iic_info_ch;
    iic_info_ch.ch_no = 1;
}

```

When the communication has been completed, the SCI channel used can be released by calling the R_SCI_IIC_Close function.
 Call the R_SCI_IIC_Close function in the following cases:

- When entering low power consumption mode.
- When communication error occurred.
- When the SCI channel used needs to be released.

Figure 7.8 Example when Accessing Two Slave Devices with One Channel (4/5)

```
/* Obtains the simple I2C status. */
ret = R_SCI_IIC_GetStatus(&iic_info_ch, &iic_status);

if (SCI_IIC_SUCCESS != ret)
{
    /* Error processing at the R_SCI_IIC_GetStatus() function call */
    sample_mode = ERROR;          /* Proceed to error processing */
}
else
{
    if (1 == iic_status.BIT.NACK)
    {
        /* Processing when NACK is detected with the iic_status flag verification */
        sample_mode = RETRY_WAIT_DEV_B_RD;    /* Proceed to a wait for retry */
    }
    else
    {
        retry_cnt = 0;
        sample_mode = FINISH;                /* Proceed to communication end processing */
    }
}
}
```

Figure 7.9 Example when Accessing Two Slave Devices with One Channel (5/5)

7.3 Example when Accessing Two Slave Devices with Two Channels

This section describes an example of using two SCI channels in simple I²C mode to write and read two slave devices. Each channel writes to and reads from different slave device.

In the sample code, I²C communication information structure is configured for each accessing device.

The procedure is as follows:

1. Execute the R_SCI_IIC_Open function to use SCI channel 1 in the SCI simple I²C mode FIT module. Also execute the R_SCI_IIC_Open function to use SCI channel 5 in the SCI simple I²C mode FIT module.
2. Execute the R_SCI_IIC_MasterSend function to write 3-byte data to device A using SCI channel 1. Execute the R_SCI_IIC_MasterReceive function to read 3-byte data from device B using SCI channel 5.
3. Execute the R_SCI_IIC_Close function to release SCI channel 1 from the SCI simple I²C mode FIT module. Also execute the R_SCI_IIC_Close function to release SCI channel 5 from the SCI simple I²C mode FIT module.

```
#include <stddef.h> /* NULL definition */
#include "platform.h"
#include "r_sci_iic_rx_if.h"

/* Defines the number of retries when a NACK is detected. */
#define RETRY_TMO 10

/* Defines the number of software loops to wait until next communication starts when retrying*/
#define RETRY_WAIT_TIME 1000

/* Transmit size */
#define SEND_SIZE 3

/* Receive size */
#define RECEIVE_SIZE 3

/* Definitions for mode management in the sample code */
typedef enum
{
    IDLE = 0U, /* Being in idle state */
    BUSY, /* I2C communication being performed */
    INITIALIZE, /* Simple I2C mode FIT module initialization */
    DEVICE_A_WRITE, /* Writing device A */
    DEVICE_B_READ, /* Reading device B */
    FINISH, /* Communication completed */
    RETRY_WAIT_DEV_A_WR, /* Waiting for retry writing device A */
    RETRY_WAIT_DEV_B_RD, /* Waiting for retry reading device B */
    ERROR /* Error occurred */
} sample_mode_t;

/* Variable for modes in the sample code */
volatile uint8_t sample_mode_ch1;
volatile uint8_t sample_mode_ch5;

/* Variable for the number of retries */
volatile uint32_t retry_cnt_ch1;
volatile uint32_t retry_cnt_ch5;

void main(void);
void Callback_deviceA(void);
void Callback_deviceB(void);

void main(void)
{
```

The following abbreviations are used in the program example:
 - ST: Start condition
 - SP: Stop condition

Figure 7.10 Example when Accessing Two Slave Devices with Two Channels (1/6)

```

volatile sci_iic_return_t  ret;      /* For verifying the return value of the API function */
volatile uint32_t  retry_wait_cnt_ch1 = 0;      /* Counter for adjusting the retry interval */
volatile uint32_t  retry_wait_cnt_ch5 = 0;      /* Counter for adjusting the retry interval */

sci_iic_info_t  iic_info_deviceA;      /* Information structure for device A */
sci_iic_info_t  iic_info_deviceB;      /* Information structure for device B */
uint8_t  slave_addr_deviceA[1]  = {0x50};      /* Slave address of device A */
uint8_t  slave_addr_deviceB[1]  = {0x50};      /* Slave address of device B */
uint8_t  access_addr_deviceA[1]  = {0x00};      /* Address to be accessed in device A */
uint8_t  access_addr_deviceB[2]  = {0x00,0x00}; /* Address to be accessed in device B */
uint8_t  send_data[5]            = {0x81,0x82,0x83,0x84,0x85}; /* Transmit data */
uint8_t  store_area[5]          = {0xFF,0xFF,0xFF,0xFF,0xFF}; /* For receive data storage */

sample_mode_ch1 = INITIALIZE;      /* Ch1: Proceed to initialization processing */
sample_mode_ch5 = INITIALIZE;      /* Ch5: Proceed to initialization processing */

while (1)
{
    switch(sample_mode_ch1)
    {
        /* Being in idle state */
        case IDLE:
            /* No operation is performed. */
            break;

            /* I2C Communication being performed */
        case BUSY:
            /* No operation is performed. */
            break;

            /* Initializes the simple I2C mode FIT module. */
        case INITIALIZE:
            /* Verifies if channel 1 is currently communicating */
            if (SCI_IIC_COMMUNICATION == g_sci_iic_ChStatus[1])
            {
                sample_mode_ch1 = ERROR;      /* Ch1: Proceed to error processing */
            }
            else
            {
                /* Configures the device A information structure (master transmit pattern 1). */
                iic_info_deviceA.p_slv_adr = slave_addr_deviceA;
                iic_info_deviceA.p_data1st = access_addr_deviceA;
                iic_info_deviceA.p_data2nd = send_data;
                iic_info_deviceA.dev_sts = SCI_IIC_NO_INIT;
                iic_info_deviceA.cnt1st = sizeof(access_addr_deviceA);
                iic_info_deviceA.cnt2nd = SEND_SIZE;
                iic_info_deviceA.callbackfunc = &Callback_deviceA;
                iic_info_deviceA.ch_no = 1;
            }

            retry_cnt_ch1 = 0;      /* Resets the number of retries. */

            /* SCI open processing */
            ret = R_SCI_IIC_Open(&iic_info_deviceA);

            if (SCI_IIC_SUCCESS == ret)
            {
                sample_mode_ch1 = DEVICE_A_WRITE; /* Ch1: Proceed to write processing for device A */
            }
            else
            {
                /* Error processing at the R_SCI_IIC_Open() function call */
                sample_mode_ch1 = ERROR;      /* Ch1: Proceed to error processing */
            }
            break;

            /* Writes data to device A. */
        case DEVICE_A_WRITE:
            retry_cnt_ch1 = retry_cnt_ch1 + 1;
    }
}

```

Declares information structures for each device to be accessed.

Processing for different channels can be operated simultaneously. Therefore mode is controlled for each channel.

A loop is performed with empty processing during idle or I²C communication.

The channel state can be verified with the global variable "g_sci_iic_ChStatus[]".

Figure 7.11 Example when Accessing Two Slave Devices with Two Channels (2/6)

```

/* Starts master transmission. */
ret = R_SCI_IIC_MasterSend(&iic_info_deviceA);

if (SCI_IIC_SUCCESS == ret)
{
    sample_mode_ch1 = BUSY;          /* Then the channel 1 state becomes
                                     "I2C communication being performed". */
}
else if (SCI_IIC_ERR_BUS_BUSY == ret)
{
    sample_mode_ch1 = RETRY_WAIT_DEV_A_WR; /* Ch1: Proceed to a wait for retry */
}
else
{
    /* Error processing at the R_SCI_IIC_MasterSend() function call */
    sample_mode_ch1 = ERROR;          /* Ch1: Proceed to error processing */
}
break;
    Processing from ST generation to SP generation is performed by executing this function.
    After SP is output, the specified callback function (Callback_deviceA()) is called.

/* Waits for retry writing device A. */
case RETRY_WAIT_DEV_A_WR:
    retry_wait_cnt_ch1 = retry_wait_cnt_ch1 + 1;

    if (RETRY_TMO < retry_cnt_ch1)
    {
        retry_wait_cnt_ch1 = 0;
        sample_mode_ch1 = ERROR;      /* Ch1: Proceed to error processing */
    }

    if (RETRY_WAIT_TIME < retry_wait_cnt_ch1)
    {
        retry_wait_cnt_ch1 = 0;

        switch (sample_mode_ch1)
        {
            case RETRY_WAIT_DEV_A_WR:
                sample_mode_ch1 = DEVICE_A_WRITE; /* Ch1: Proceed to write processing
                                                    for device A*/

                break;

            default:
                /* No operation is performed. */

                break;
        }
    }
}
break;

/* Communication end processing */
case FINISH:
    /* SCI close processing */
    ret = R_SCI_IIC_Close(&iic_info_deviceA);

    if (SCI_IIC_SUCCESS == ret)
    {
        sample_mode_ch1 = IDLE;        /* Then the channel 1 state becomes "idle". */
    }
    else
    {
        /* Error processing at the R_SCI_IIC_Close() function call */
        sample_mode_ch1 = ERROR;      /* Ch1: Proceed to error processing */
    }
}
break;

/* Error occurred */
case ERROR:
    /* No operation is performed. */

    break;

default:
    /* No operation is performed. */

    break;
}

```

When the communication target is the EEPROM, if write operation is performed by sending the write command, a NACK is returned until the write operation is completed. In the sample code, retry to start communication is performed until an ACK is returned.

When the communication has been completed, the SCI channel used can be released by calling the R_SCI_IIC_Close function. Call the R_SCI_IIC_Close function in the following cases:

- When entering low power consumption mode.
- When communication error occurred.
- When the SCI channel used needs to be released.

Figure 7.12 Example when Accessing Two Slave Devices with Two Channels (3/6)

```

switch(sample_mode_ch5)
{
    /* Being in idle state */
    case IDLE:
        /* No operation is performed. */
        break;

    /* I2C communication being performed */
    case BUSY:
        /* No operation is performed. */
        break;

    /* Initializes the simple I2C mode FIT module. */
    case INITIALIZE:
        /* Verifies if channel 5 is currently communicating */
        if (SCI_IIC_COMMUNICATION == g_sci_iic_ChStatus[5])
        {
            sample_mode_ch5 = ERROR; /* Ch5: Proceed to error processing */
        }
        else
        {
            /* Configures the device B information structure (master transmit/receive).
            */

            iic_info_deviceB.p_slv_addr = slave_addr_deviceB;
            iic_info_deviceB.p_data1st = access_addr_deviceB;
            iic_info_deviceB.p_data2nd = store_area;
            iic_info_deviceB.dev_sts = SCI_IIC_NO_INIT;
            iic_info_deviceB.cnt1st = sizeof(access_addr_deviceB);
            iic_info_deviceB.cnt2nd = RECEIVE_SIZE;
            iic_info_deviceB.callbackfunc = &Callback_deviceB;
            iic_info_deviceB.ch_no = 5;
        }

        retry_cnt_ch5 = 0; /* Resets the number of retries. */

        /* SCI open processing */
        ret = R_SCI_IIC_Open(&iic_info_deviceB);

        if (SCI_IIC_SUCCESS == ret)
        {
            sample_mode_ch5 = DEVICE_B_READ; /* Ch5: Proceed to read processing for
            device B */
        }
        else
        {
            /* Error processing at the R_SCI_IIC_Open() function call */
            sample_mode_ch5 = ERROR; /* Ch5: Proceed to error processing */
        }

        break;

    case DEVICE_B_READ:
        retry_cnt_ch5 = retry_cnt_ch5 + 1;

        /* Starts master transmit/receive processing. */
        ret = R_SCI_IIC_MasterReceive(&iic_info_deviceB);

        if (SCI_IIC_SUCCESS == ret)
        {
            sample_mode_ch5 = BUSY; /* Then the channel 5 state becomes "I2C
            communication being performed". */
        }
        else if (SCI_IIC_ERR_BUS_BUSY == ret)
        {
            sample_mode_ch5 = RETRY_WAIT_DEV_B_RD; /* Ch5: Proceed to a wait for retry */
        }
        else
        {
            /* Error processing at the R_SCI_IIC_MasterReceive() function call */
            sample_mode_ch5 = ERROR; /* Ch5: Proceed to error processing */
        }
        break;
}

```

A loop is performed with empty processing during idle or I²C communication.

The channel state can be verified with the global variable "g_sci_iic_ChStatus[]".

Processing from ST generation to SP generation is performed by executing this function in the FIT module. After SP is output, the specified callback function (Callback_deviceB()) is called.

Figure 7.13 Example when Accessing Two Slave Devices with Two Channels (4/6)

```

/* Waits for retry reading device B. */
case RETRY_WAIT_DEV_B_RD:
    retry_wait_cnt_ch5 = retry_wait_cnt_ch5 + 1;

    if (RETRY_TMO < retry_cnt_ch5)
    {
        retry_wait_cnt_ch5 = 0;
        sample_mode_ch5 = ERROR; /* Ch5: Proceed to error processing */
    }
    if (RETRY_WAIT_TIME < retry_wait_cnt_ch5)
    {
        retry_wait_cnt_ch5 = 0;

        switch (sample_mode_ch5)
        {
            case RETRY_WAIT_DEV_B_RD:
                sample_mode_ch5 = DEVICE_B_READ; /* Ch5: Proceed to read processing for
                device B */

                break;
            default:
                /* No operation is performed. */
                break;
        }
    }
}
break;

/* Communication end processing */
case FINISH:
    /* SCI close processing */
    ret = R_SCI_IIC_Close(&iic_info_deviceB);

    if (SCI_IIC_SUCCESS == ret)
    {
        sample_mode_ch5 = IDLE; /* Then the channel 5 state becomes "idle". */
    }
    else
    {
        /* Error processing at the R_SCI_IIC_Close() function call */
        sample_mode_ch5 = ERROR; /* Ch5: Proceed to error processing */
    }
}
break;

/* Error occurred. */
case ERROR:
    /* No operation is performed. */
    break;

default:
    /* No operation is performed. */
    break;
}
}

void Callback_deviceA(void)
{
    volatile sci_iic_return_t ret;
    sci_iic_mcu_status_t iic_status;
    sci_iic_info_t iic_info_ch;
    iic_info_ch.ch_no = 1;

    /* Obtains the simple I2C status. */
    ret = R_SCI_IIC_GetStatus(&iic_info_ch, &iic_status);

    if (SCI_IIC_SUCCESS != ret)
    {
        /* Error processing at the R_SCI_IIC_GetStatus() function call */
        sample_mode_ch1 = ERROR; /* Ch1: Proceed to error processing */
    }
}

```

When the communication target is the EEPROM, if write operation is performed by sending the write command, a NACK is returned until the write operation is completed. In the sample code, retry to start communication is performed until an ACK is returned.

When the communication has been completed, the SCI channel used can be released by calling the R_SCI_IIC_Close function. Call the R_SCI_IIC_Close function in the following cases:

- When entering low power consumption mode.
- When communication error occurred.
- When the SCI channel used needs to be released.

Figure 7.14 Example when Accessing Two Slave Devices with Two Channels (5/6)

```

else
{
    if (1 == iic_status.BIT.NACK)
    {
        /* Processing when NACK is detected with the iic_status flag verification. */
        sample_mode_ch1 = RETRY_WAIT_DEV_A_WR; /* Ch1: Proceed to a wait for retry */
    }
    else
    {
        retry_cnt_ch1 = 0;
        sample_mode_ch1 = FINISH; /* Ch1: Proceed to communication end processing */
    }
}
}

void Callback_deviceB(void)
{
    volatile sci_iic_return_t ret;
    sci_iic_mcu_status_t iic_status;
    sci_iic_info_t iic_info_ch;
    iic_info_ch.ch_no = 5;

    /* Obtains the simple I2C status. */
    ret = R_SCI_IIC_GetStatus(&iic_info_ch, &iic_status);

    if (SCI_IIC_SUCCESS != ret)
    {
        /* Error processing at the R_SCI_IIC_GetStatus() function call. */
        sample_mode_ch5 = ERROR; /* Ch5: Proceed to error processing */
    }
    else
    {
        if (1 == iic_status.BIT.NACK)
        {
            /* Processing when NACK is detected with the iic_status flag verification */
            sample_mode_ch5 = RETRY_WAIT_DEV_B_RD; /* Ch5: Proceed to a wait for retry */
        }
        else
        {
            retry_cnt_ch5 = 0;
            sample_mode_ch5 = FINISH; /* Ch5: Proceed to communication end processing */
        }
    }
}
}

```

Figure 7.15 Example when Accessing Two Slave Devices with Two Channels (6/6)

8. Reference Documents

User's Manual: Hardware

The latest version can be downloaded from the Renesas Electronics website.

Technical Update/Technical News

The latest information can be downloaded from the Renesas Electronics website.

User's Manual: Development Tools

RX Family C/C++ Compiler CC-RX User's Manual (R20UT3248)

The latest version can be downloaded from the Renesas Electronics website.

Related Technical Updates

This module reflects the content of the following technical updates.

None

Revision History

Rev.	Date	Description	
		Page	Summary
1.60	Feb. 27, 2015	Program	<p>Modified the SCI simple I²C mode FIT module due to the software issue</p> <p>[Description] There are errors in the processing to set the clock source (CKS bit in the SMR register) and the bit rate (BRR register) for the on-chip baud rate generator, so the set values may differ from the expected values.</p> <p>[Conditions] When rev.1.50 or an earlier version of the SCI simple I²C mode FIT module is used with RX64M or RX71M, either of the following conditions is met:</p> <ul style="list-style-type: none"> - Divided-by-3 is selected as the PLL input frequency division ratio (PLIDIV bit in the PLLCR register). - The tenth place of the PLL frequency multiplication factor is 5 (STC bit in the PLLCR register). <p>[Workaround] Use rev.1.60 or a later version of the SCI simple I²C mode FIT module.</p>
			<p>Modified the SCI simple I²C mode FIT module due to the software issue</p> <p>[Description] When the bit rate is set to low, the program may go into an infinite loop.</p> <p>[Conditions] The following two conditions are met:</p> <ul style="list-style-type: none"> - Rev.1.50 or an earlier version of the SCI simple I²C mode FIT module is used. - The BRR register value calculated by the sci_iic_set_frequency function is greater than 255. (The bit rate is extremely low compared to PCLKB.) <p>Example: When PCLKB is 60 MHz, the bit rate is set to 200 bps or less. When PCLKB is 300 kHz, the bit rate is set to 1 bps.</p> <p>[Workaround] Use rev.1.60 or a later version of the SCI simple I²C mode FIT module</p>
1.70	May. 29, 2015		Added support for the RX231 Group.
1.80	Oct. 31, 2015	-	Added support for the RX130 Group, RX230 Group, RX23T Group.
		33	Format of 3.5 R_SCI_IIC_GetStatus(), modified

Rev.	Date	Description	
		Page	Summary
1.90	Mar. 4, 2016	-	Added support for the RX24T Group.
		5	Table 1.2 Required Memory Size, changed.
		17, 18	Added description of r_sci_iic_rx_pin_config.h to section 2.6, Configuration Overview.
		-	Changed "master composite" to "master transmit/receive".
		45	Modified the macro definition of the internal communication information structure api_Mode, which is the I ² C protocol operating mode in the communication in progress (master transmit/receive) state, in Table 4.5, States of Flags on State Transitions.
2.00	Oct. 1, 2016	-	Added support for the RX65N Group.
		15	2.6 Configuration Overview: Changed default value of SCI_IIC_CFG_CHi_SSDA_DELAY_SELECT.
		19	Changed code size description from "Table 1.2 Required Memory Size" to "2.7 Code Size."
2.20	Aug. 31, 2017	-	Added support for the RX24U Group.
		-	Added support for the RX65N-2MB edition.
		-	Added support for the RX130-512KB edition.
		-	Added support for the RX24T-512KB edition.
		1	Related Documents: Added the following document: "Renesas e ² studio Smart Configurator User Guide (R20AN0451)"
		16 to 18	2.4 Usage of Interrupt Vector: added.
		20	In "2.7 Configuration Overview ", SCI_IIC_CFG_CHi_INCLUDED describes the important points to be noted for using the compile time setting SCI_IIC_CFG_CHi_BITRATE_BPS describes the important points to be noted for bit rate setting.
		21	A notice of bit setting about SCI_IIC_CFG_PORT_SETTING_PROCESSING is added.
		25	2.11 Adding the FIT Module to Your Project: Revised.
		45, 46	4. Pin Settings: added.
		59 to 61	5.3 Operating Test Environment: Added.
		62	5.4 Troubleshooting: Added.
		Program	Changed default value of SCI_IIC_CFG_CH1_INCLUDED. Corrected the drive capacity control setting process by r_sci_iic_io_open() function of RX63N, RX64M, RX65N and RX71M.

Rev.	Date	Description	
		Page	Summary
2.30	Sep. 20, 2018	-	Added support for the RX66T Group.
		15	2.3 Supported Toolchains Added for Toolchain v.3.00.00
		19	2.4 Usage of Interrupt Vector: added. Table 2.4 List of Usage of Interrupt Vectors - 4 -
		23	In "2.7 Configuration Overview ", Specify the value as an ASCII code 'J' is changed to 'K'.
		25	2.8 Code Size: Changed code size for Rev2.30
		28	2.12 "for", "while" and "do while" statements: added
		49 to 50	5.Demo Projects: added
		-	Change 5.Appendices to 6.Appendices All file: Chapter 5 related number is changed to 6
		64	Operating Test Environment : added Table 6-11 Operation Confirmation Environment for Rev.2.30 is added
2.31	Dec. 03, 2018	64	6.3 Operation Confirmation Environment: Corrected board used in Table 6.11 Confirmed Operation Environment (Rev. 2.30). Added Table 6.12 Confirmed Operation Environment (Rev. 2.31).
		Program	Added document number of the application note accompanying the sample program of the FIT module to xml file.
2.40	Feb. 20, 2019	-	Added support for the RX72T Group.
		1	Related Documents: Changed the following documents' names RX Family Board Support Package Module Using Firmware Integration Technology (R01AN1685) RX Family Adding Firmware Integration Technology Modules to Projects (R01AN1723) RX Family Adding Firmware Integration Technology Modules to CS+ Projects (R01AN1826)
		15	2.3 Supported Toolchains Added for Toolchain v.3.01.00
		19	2.4 Usage of Interrupt Vector: RX72T added. Table 2.4 List of Usage of Interrupt Vectors - 4 -
		65	Operating Test Environment : added Table 6-13 Operation Confirmation Environment for Rev.2.40 is added
2.41	May. 20, 2019	-	Update the following compilers GCC for Renesas RX IAR C/C++ Compiler for Renesas RX.
		1	Deleted Related Documents.
		1	Added Target Compilers.
		15	Added revision of dependent r_bsp module in 2.2 Software Requirements.

Rev.	Date	Description	
		Page	Summary
2.41	May. 20, 2019	25	2.8 Code Size, amended
		47	3.7 R_SCI_IIC_GetVersion function, deleted special notes.
		66	Operating Test Environment : added Table 6-14 Operation Confirmation Environment for Rev.2.41 is added
		Program	RX63N is not supported in the following versions. Delete RX63N-processes' related note: Deleted RX63N from Target Devices.
2.42	Jun. 20, 2019	-	Added support for the RX23W Group.
		16	2.4 Usage of Interrupt Vector: RX23W added. Table 2.1 List of Usage of Interrupt Vectors - 1 -
		25	2.8 Code Size, amended
		65	Operating Test Environment : added Table 6-15 Operation Confirmation Environment for Rev.2.42 is added
2.43	Jul. 30, 2019	-	Added support for the RX72M Group.
		20	2.4 Usage of Interrupt Vector: RX72M added. Table 2.5 List of Usage of Interrupt Vectors - 5 -
		26	2.8 Code Size, amended
		30 to 47	Delete "Reentrant" item on the API description page.
		67	Operating Test Environment : added Table 6-16 Operation Confirmation Environment for Rev.2.43 is added
2.44	Oct. 30, 2019	-	Added support for the RX13T Group.
		16	2.4 Usage of Interrupt Vector: RX13T added. Table 2.1 List of Usage of Interrupt Vectors - 1 -
		26	2.8 Code Size, amended
		67	Operating Test Environment : added Table 6-17 Operation Confirmation Environment for Rev.2.44 is added
2.45	Nov. 22, 2019	-	Added support for the RX66N and RX72N Groups.
		16	2.4 Usage of Interrupt Vector: RX66N and RX72N added. Table 2.5 List of Usage of Interrupt Vectors - 5 -
		26	2.8 Code Size, amended
		68	Operating Test Environment : added Table 6-18 Operation Confirmation Environment for Rev.2.45 is added

Rev.	Date	Description	
		Page	Summary
2.45	Nov. 22, 2019	Program	<p>Modified the SCI simple I²C mode FIT module due to the software issue</p> <p>[Description] There are errors in the processing to set the clock source (CKS bit in the SMR register) and the bit rate (BRR register) for the onchip baud rate generator, so the set values may differ from the expected values.</p> <p>[Conditions] When rev.2.43 of the SCI simple I²C mode FIT module is used with RX72M, and the following two conditions are met: - SCI7, SCI8, or SCI9 of channel is used. - The operating frequency of PCLKA and PCLKB is different.</p> <p>[Workaround] Use rev.2.45 or a later version of the SCI simple I²C mode FIT module.</p>
2.46	Mar. 10, 2020	-	Added support for the RX23E-A Group.
		17	2.4 Usage of Interrupt Vector: RX23E-A added. Table 2.1 List of Usage of Interrupt Vectors - 1 -
		27	2.8 Code Size, amended
		29	Changed Section 2.11 Adding the FIT Module to Your Project.
		69	Operating Test Environment : added Table 6-19 Operation Confirmation Environment for Rev.2.46 is added
2.47	Oct. 30, 2020	-	Updated the sample code project due to the upgrade of the development environment.
2.48	Jun 30, 2021		Added support for the RX671 Group
		15	2.3 Supported Toolchains Added for Toolchain v.3.03.00
		19	2.4 Usage of Interrupt Vector: RX671 added. Table 2.3 List of Usage of Interrupt Vectors - 3 -
		70	Table 6-21 Operation Confirmation Environment for Rev.2.48 is Added.
2.49	Jul. 31, 2021	-	Added support for the RX140 Group.
		7 to 10	The contents of Figure 1.3, Figure 1.4, Figure 1.5, Figure 1.6 and Figure 1.7 are modified.
		16	2.4 Usage of Interrupt Vector: RX140 added. Table 2.1 List of Usage of Interrupt Vectors - 1 -
		26	2.8 Code Size, amended
		69	Table 6-22 Operation Confirmation Environment for Rev.2.49 is added.

Rev.	Date	Description	
		Page	Summary
2.50	Dec. 31, 2021	-	Added support for the RX660 Group.
		14	1.4 Using SCI Simple I ² C Mode FIT Module added
		15	2.3 Supported Toolchains Added for Toolchain v.3.04.00
		18	2.4 Usage of Interrupt Vector: RX660 added. Table 2.3 List of Usage of Interrupt Vectors - 3 -
		26	2.8 Code Size, amended
		71	Table 6.23 Operation Confirmation Environment for Rev.2.50 is added.
2.60	Jun. 15, 2022	-	Added support for the RX26T Group.
		15	2.3 Supported Toolchains, amended
		21	2.4 Usage of Interrupt Vector: RX26T added. Table 2.6 List of Usage of Interrupt Vectors - 6 -
		28	2.8 Code Size, amended
		54	Updated and added new demo project. Added RSKRX671, RSKRX72N to "5. Demo Projects".
		75	Table 6.24 Operation Confirmation Environment for Rev.2.60 is added.
		Program	Added support for RX26T Group. Updated and added new demo projects.
2.70	May. 29, 2023	-	Added support for the RX23E-B Group.
		15	2.4 Usage of Interrupt Vector: RX23E-B added. Table 2.6 List of Usage of Interrupt Vectors - 6 -
		27	2.8 Code Size, amended
		29, 49	Deleted the description of FIT configurator from "2.11 Adding the FIT Module to Your Project" and "4. Pin Settings"
		75	Table 6.25 Operation Confirmation Environment for Rev.2.70 is added.
		Program	Added support for RX23E-B Group.
2.71	Oct. 05, 2023	36, 37	3.2 R_SCI_IIC_MasterSend(): Fixed a bug "the While loop would not exit" in the example code when compiling option optimization level 2 (default).
		76	Table 6.26 Operation Confirmation Environment for Rev.2.71 is added.
2.80	Jun. 28, 2024	-	Added support for the RX260, RX261 Groups.
		16	2.4 Usage of Interrupt Vector: RX260, RX261 added. Table 2.1 List of Usage of Interrupt Vectors - 1 -
		27	2.8 Code Size, amended
		77	Table 6.27 Operation Confirmation Environment for Rev.2.80 is added.
		Program	Added support for RX260 Group, RX261 Group.

General Precautions in the Handling of Microprocessing Unit and Microcontroller Unit Products

The following usage notes are applicable to all Microprocessing unit and Microcontroller unit products from Renesas. For detailed usage notes on the products covered by this document, refer to the relevant sections of the document as well as any technical updates that have been issued for the products.

1. Precaution against Electrostatic Discharge (ESD)

A strong electrical field, when exposed to a CMOS device, can cause destruction of the gate oxide and ultimately degrade the device operation. Steps must be taken to stop the generation of static electricity as much as possible, and quickly dissipate it when it occurs. Environmental control must be adequate. When it is dry, a humidifier should be used. This is recommended to avoid using insulators that can easily build up static electricity.

Semiconductor devices must be stored and transported in an anti-static container, static shielding bag or conductive material. All test and measurement tools including work benches and floors must be grounded. The operator must also be grounded using a wrist strap. Semiconductor devices must not be touched with bare hands. Similar precautions must be taken for printed circuit boards with mounted semiconductor devices.

2. Processing at power-on

The state of the product is undefined at the time when power is supplied. The states of internal circuits in the LSI are indeterminate and the states of register settings and pins are undefined at the time when power is supplied. In a finished product where the reset signal is applied to the external reset pin, the states of pins are not guaranteed from the time when power is supplied until the reset process is completed. In a similar way, the states of pins in a product that is reset by an on-chip power-on reset function are not guaranteed from the time when power is supplied until the power reaches the level at which resetting is specified.

3. Input of signal during power-off state

Do not input signals or an I/O pull-up power supply while the device is powered off. The current injection that results from input of such a signal or I/O pull-up power supply may cause malfunction and the abnormal current that passes in the device at this time may cause degradation of internal elements. Follow the guideline for input signal during power-off state as described in your product documentation.

4. Handling of unused pins

Handle unused pins in accordance with the directions given under handling of unused pins in the manual. The input pins of CMOS products are generally in the high-impedance state. In operation with an unused pin in the open-circuit state, extra electromagnetic noise is induced in the vicinity of the LSI, an associated shoot-through current flows internally, and malfunctions occur due to the false recognition of the pin state as an input signal become possible.

5. Clock signals

After applying a reset, only release the reset line after the operating clock signal becomes stable. When switching the clock signal during program execution, wait until the target clock signal is stabilized. When the clock signal is generated with an external resonator or from an external oscillator during a reset, ensure that the reset line is only released after full stabilization of the clock signal. Additionally, when switching to a clock signal produced with an external resonator or by an external oscillator while program execution is in progress, wait until the target clock signal is stable.

6. Voltage application waveform at input pin

Waveform distortion due to input noise or a reflected wave may cause malfunction. If the input of the CMOS device stays in the area between V_{IL} (Max.) and V_{IH} (Min.) due to noise, for example, the device may malfunction. Take care to prevent chattering noise from entering the device when the input level is fixed, and also in the transition period when the input level passes through the area between V_{IL} (Max.) and V_{IH} (Min.).

7. Prohibition of access to reserved addresses

Access to reserved addresses is prohibited. The reserved addresses are provided for possible future expansion of functions. Do not access these addresses as the correct operation of the LSI is not guaranteed.

8. Differences between products

Before changing from one product to another, for example to a product with a different part number, confirm that the change will not lead to problems. The characteristics of a microprocessing unit or microcontroller unit products in the same group but having a different part number might differ in terms of internal memory capacity, layout pattern, and other factors, which can affect the ranges of electrical characteristics, such as characteristic values, operating margins, immunity to noise, and amount of radiated noise. When changing to a product with a different part number, implement a system-evaluation test for the given product.

Notice

1. Descriptions of circuits, software and other related information in this document are provided only to illustrate the operation of semiconductor products and application examples. You are fully responsible for the incorporation or any other use of the circuits, software, and information in the design of your product or system. Renesas Electronics disclaims any and all liability for any losses and damages incurred by you or third parties arising from the use of these circuits, software, or information.
 2. Renesas Electronics hereby expressly disclaims any warranties against and liability for infringement or any other claims involving patents, copyrights, or other intellectual property rights of third parties, by or arising from the use of Renesas Electronics products or technical information described in this document, including but not limited to, the product data, drawings, charts, programs, algorithms, and application examples.
 3. No license, express, implied or otherwise, is granted hereby under any patents, copyrights or other intellectual property rights of Renesas Electronics or others.
 4. You shall be responsible for determining what licenses are required from any third parties, and obtaining such licenses for the lawful import, export, manufacture, sales, utilization, distribution or other disposal of any products incorporating Renesas Electronics products, if required.
 5. You shall not alter, modify, copy, or reverse engineer any Renesas Electronics product, whether in whole or in part. Renesas Electronics disclaims any and all liability for any losses or damages incurred by you or third parties arising from such alteration, modification, copying or reverse engineering.
 6. Renesas Electronics products are classified according to the following two quality grades: "Standard" and "High Quality". The intended applications for each Renesas Electronics product depends on the product's quality grade, as indicated below.
 - "Standard": Computers; office equipment; communications equipment; test and measurement equipment; audio and visual equipment; home electronic appliances; machine tools; personal electronic equipment; industrial robots; etc.
 - "High Quality": Transportation equipment (automobiles, trains, ships, etc.); traffic control (traffic lights); large-scale communication equipment; key financial terminal systems; safety control equipment; etc.
- Unless expressly designated as a high reliability product or a product for harsh environments in a Renesas Electronics data sheet or other Renesas Electronics document, Renesas Electronics products are not intended or authorized for use in products or systems that may pose a direct threat to human life or bodily injury (artificial life support devices or systems; surgical implantations; etc.), or may cause serious property damage (space system; undersea repeaters; nuclear power control systems; aircraft control systems; key plant systems; military equipment; etc.). Renesas Electronics disclaims any and all liability for any damages or losses incurred by you or any third parties arising from the use of any Renesas Electronics product that is inconsistent with any Renesas Electronics data sheet, user's manual or other Renesas Electronics document.
7. No semiconductor product is absolutely secure. Notwithstanding any security measures or features that may be implemented in Renesas Electronics hardware or software products, Renesas Electronics shall have absolutely no liability arising out of any vulnerability or security breach, including but not limited to any unauthorized access to or use of a Renesas Electronics product or a system that uses a Renesas Electronics product. RENESAS ELECTRONICS DOES NOT WARRANT OR GUARANTEE THAT RENESAS ELECTRONICS PRODUCTS, OR ANY SYSTEMS CREATED USING RENESAS ELECTRONICS PRODUCTS WILL BE INVULNERABLE OR FREE FROM CORRUPTION, ATTACK, VIRUSES, INTERFERENCE, HACKING, DATA LOSS OR THEFT, OR OTHER SECURITY INTRUSION ("Vulnerability Issues"). RENESAS ELECTRONICS DISCLAIMS ANY AND ALL RESPONSIBILITY OR LIABILITY ARISING FROM OR RELATED TO ANY VULNERABILITY ISSUES. FURTHERMORE, TO THE EXTENT PERMITTED BY APPLICABLE LAW, RENESAS ELECTRONICS DISCLAIMS ANY AND ALL WARRANTIES, EXPRESS OR IMPLIED, WITH RESPECT TO THIS DOCUMENT AND ANY RELATED OR ACCOMPANYING SOFTWARE OR HARDWARE, INCLUDING BUT NOT LIMITED TO THE IMPLIED WARRANTIES OF MERCHANTABILITY, OR FITNESS FOR A PARTICULAR PURPOSE.
 8. When using Renesas Electronics products, refer to the latest product information (data sheets, user's manuals, application notes, "General Notes for Handling and Using Semiconductor Devices" in the reliability handbook, etc.), and ensure that usage conditions are within the ranges specified by Renesas Electronics with respect to maximum ratings, operating power supply voltage range, heat dissipation characteristics, installation, etc. Renesas Electronics disclaims any and all liability for any malfunctions, failure or accident arising out of the use of Renesas Electronics products outside of such specified ranges.
 9. Although Renesas Electronics endeavors to improve the quality and reliability of Renesas Electronics products, semiconductor products have specific characteristics, such as the occurrence of failure at a certain rate and malfunctions under certain use conditions. Unless designated as a high reliability product or a product for harsh environments in a Renesas Electronics data sheet or other Renesas Electronics document, Renesas Electronics products are not subject to radiation resistance design. You are responsible for implementing safety measures to guard against the possibility of bodily injury, injury or damage caused by fire, and/or danger to the public in the event of a failure or malfunction of Renesas Electronics products, such as safety design for hardware and software, including but not limited to redundancy, fire control and malfunction prevention, appropriate treatment for aging degradation or any other appropriate measures. Because the evaluation of microcomputer software alone is very difficult and impractical, you are responsible for evaluating the safety of the final products or systems manufactured by you.
 10. Please contact a Renesas Electronics sales office for details as to environmental matters such as the environmental compatibility of each Renesas Electronics product. You are responsible for carefully and sufficiently investigating applicable laws and regulations that regulate the inclusion or use of controlled substances, including without limitation, the EU RoHS Directive, and using Renesas Electronics products in compliance with all these applicable laws and regulations. Renesas Electronics disclaims any and all liability for damages or losses occurring as a result of your noncompliance with applicable laws and regulations.
 11. Renesas Electronics products and technologies shall not be used for or incorporated into any products or systems whose manufacture, use, or sale is prohibited under any applicable domestic or foreign laws or regulations. You shall comply with any applicable export control laws and regulations promulgated and administered by the governments of any countries asserting jurisdiction over the parties or transactions.
 12. It is the responsibility of the buyer or distributor of Renesas Electronics products, or any other party who distributes, disposes of, or otherwise sells or transfers the product to a third party, to notify such third party in advance of the contents and conditions set forth in this document.
 13. This document shall not be reprinted, reproduced or duplicated in any form, in whole or in part, without prior written consent of Renesas Electronics.
 14. Please contact a Renesas Electronics sales office if you have any questions regarding the information contained in this document or Renesas Electronics products.

(Note1) "Renesas Electronics" as used in this document means Renesas Electronics Corporation and also includes its directly or indirectly controlled subsidiaries.

(Note2) "Renesas Electronics product(s)" means any product developed or manufactured by or for Renesas Electronics.

(Rev.5.0-1 October 2020)

Corporate Headquarters

TOYOSU FORESIA, 3-2-24 Toyosu,
Koto-ku, Tokyo 135-0061, Japan
www.renesas.com

Trademarks

Renesas and the Renesas logo are trademarks of Renesas Electronics Corporation. All trademarks and registered trademarks are the property of their respective owners.

Contact information

For further information on a product, technology, the most up-to-date version of a document, or your nearest sales office, please visit:
www.renesas.com/contact/.