

Vector control for permanent magnetic synchronous motor with encoder - AB incremental type encoder

For Renesas Flexible Motor Control Series

Abstract

This application note describes the sample program for a permanent magnetic synchronous motor drive with vector control using encoder based on Renesas microcontroller. This application note also describes how to use the motor control development support tool, 'Renesas Motor Workbench'.

The targeted software for this application is only to be used as reference purposes only and Renesas Electronics Corporation does not guarantee the operations. Please use this after carrying out a thorough evaluation in a suitable environment.

Operation checking device

Operations of the target software of this application note are checked by using the following device.

- RA6T2 (R7FA6T2BD3CFP)
- RA6T3 (R7FA6T3BB3CFM)
- RA4T1 (R7FA4T1BB3CFM)
- RA8T1 (R7FA8T1AHECBD)

Target software

The following shows the target software for this application note:

- RA6T2_MCILV1_SPM_ENCD_FOC_E2S_V111
- RA6T3_MCILV1_SPM_ENCD_FOC_E2S_V101
- RA4T1_MCILV1_SPM_ENCD_FOC_E2S_V101
- RA8T1_MCILV1_SPM_ENCD_FOC_E2S_V101

Contents

1. Overview	4
2. Development environment	4
2.1 Operation check environment	4
2.2 Hardware specifications	5
2.2.1 Hardware configuration diagram	5
2.2.2 User interface	6
2.2.3 Peripheral functions	8
2.3 Software configuration	47
2.3.1 Software file configuration	47
2.3.2 Module configuration	49
2.4 Software specifications	50
2.5 Interrupt Priority	51
3. Descriptions of the control program	52
3.1 Contents of control	52
3.1.1 Motor start/stop	52
3.1.2 A/D Converter	52
3.1.3 Modulation (current control module)	53
3.1.4 State transition	54
3.1.5 Start-up method	55
3.1.6 Position Profile Generation (Position Profile of Trapezoidal Curve for Speed Command Value)	56
3.1.7 Speed Measurement	57
3.1.8 System protection function	59
3.1.9 AD triggers	60
3.2 Function specifications of vector control with encoder software	61
3.3 Contents of control	68
3.3.1 Configuration Options	68
3.3.2 Configuration Options for included modules	68
3.4 Control flowcharts	79
3.4.1 Main process	79
3.4.2 Current Control Period Interrupt (Carrier synchronized Interrupt) Process	80
3.4.3 Speed Control Period Interrupt Process	81
3.4.4 Over Current Detection Interrupt Process	82
3.4.5 Encoder signal interrupt processing	83
4. Evaluation environment explanation	84
4.1 Importing the Demo Project	84
4.2 Building and Debugging	85
4.3 Quick Start	86
4.4 Motor Control Development Support Tool 'Renesas Motor Workbench'	87

4.4.1	Overview.....	87
4.4.2	Easy function operation example	88
4.4.3	List of variables for Analyzer function	92
4.4.4	Operation Example for Analyzer	93
4.4.5	Tuner function.....	94
4.4.6	Example of changing communication speed.....	95
4.4.7	How to use the built-in communication library.....	96
5.	Reference Documents	99
	Revision History.....	100

1. Overview

This application note explains how to implement the vector control with encoder software that drives permanent magnetic synchronous motor (PMSM) using the RA series microcontroller and how to use the motor control development support tool, 'Renesas Motor Workbench'.

Note that this software uses the algorithm described in the application note 'Vector control with encoder for permanent magnet synchronous motor (Algorithm)' (R01AN3789), so please refer to that for the details of the algorithm.

2. Development environment

2.1 Operation check environment

Table 2-1 and Table 2-2 show development environment of the software explained in this application note.

Table 2-1 Hardware Development Environment

Classification	Product used
Microcomputer / CPU board P/N	RA6T2 (R7FA6T2BD3CFP) / RTK0EMA270C00000BJ RA4T1 (R7FA4T1BB3CFM) / RTK0EMA430C00000BJ RA6T3(R7FA6T3BB3CFM) / RTK0EMA330C00000BJ RA8T1(R7FA8T1AHECBD) / RTK0EMA5K0C00000BJ
Inverter board	MCI-LV-1 / RTK0EM0000S04020BJ
motor	BLY171D-24V-4000 (manufactured by Anaheim Automation)
Sensor	AMT102-V (manufactured by CUI DEVICES)

Table 2-2 Software Development Environment

e ² studio version	FSP version	Toolchain version
e ² studio : 2023-10	V5.1.0	GCC ARM Embedded : 10.3.1.20210824(RA6T2,RA6T3,RA4T1) 13.2.1.arm-13-7 (RA8T1)

For purchase and technical support, contact Sales representatives and dealers of Renesas Electronics Corporation.

2.2 Hardware specifications

2.2.1 Hardware configuration diagram

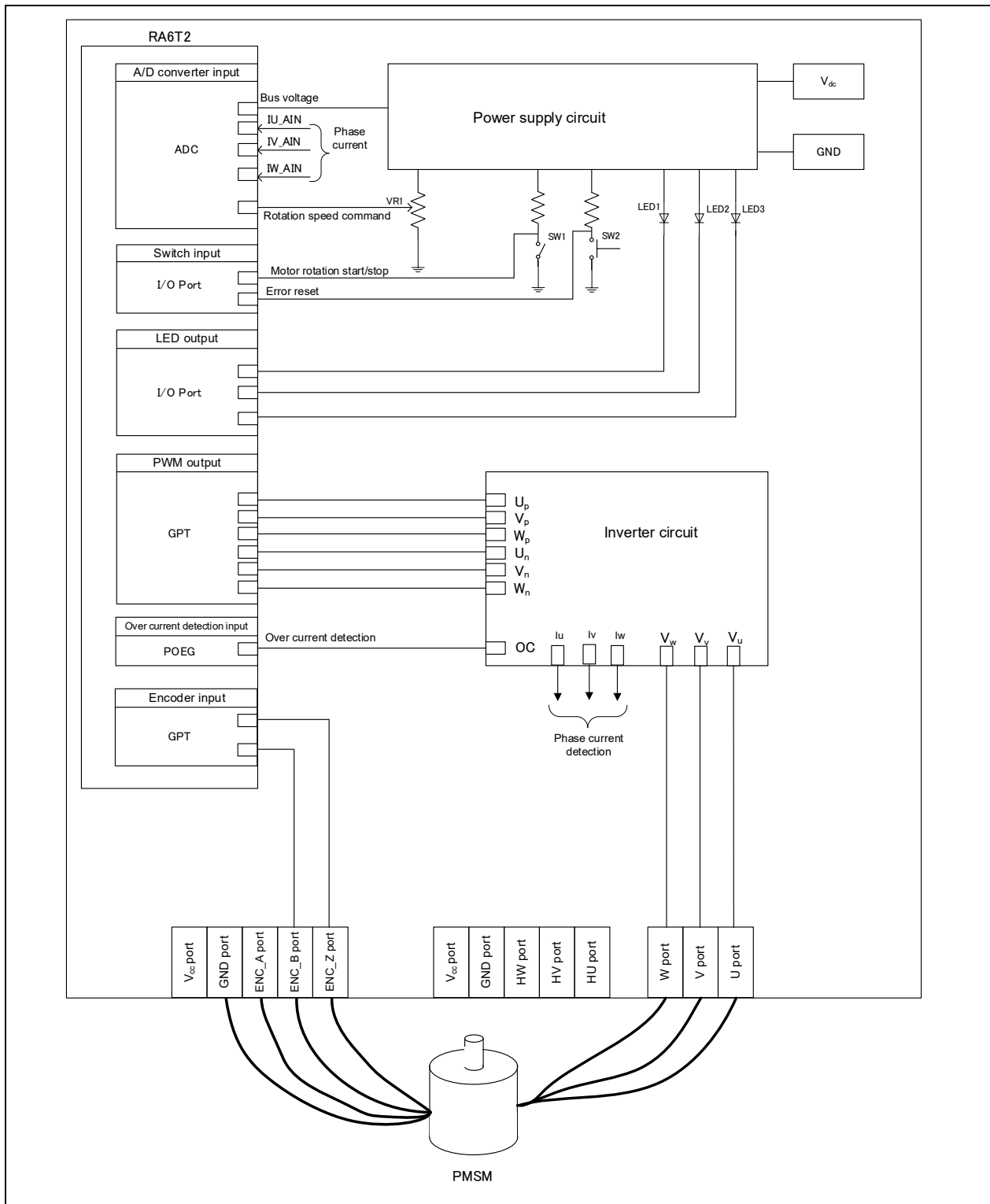

Figure 2-1 Hardware Configuration Diagram

2.2.2 User interface

Table 2-3 is lists of user interfaces of this system.

Table 2-3 User Interface

Item	Interface component	Function
Rotation speed command	Variable resistor (VR)	Reference value of rotation speed input (analog value)
START/STOP	Toggle switch (SW1)	Motor rotation start/stop command
ERROR RESET	Push switch (SW2)	Command of recovery from error status
LED1	Orange LED	- At the time of motor rotation: ON - At the time of stop: OFF
LED2	Orange LED	- At the time of error detection: ON - At the time of normal operation: OFF
LED3	Orange LED	- Positioning completed: ON - Positioning not completed: OFF (Only RA6T2)
RESET	Push switch (RESET)	System reset

List of port interfaces of this system is given in Table 2-4.

Table 2-4 Port Interfaces

Function	RA6T2	RA4T1	RA6T3	RA8T1
Inverter bus voltage measurement	PA06 / AN006	P004 / AN004	P004 / AN004	P008 / AN008
For rotation speed command value input (analog value)	PB00 / AN008	P005 / AN005	P005 / AN005	P014 / AN007
START/STOP toggle switch (SW1)	PD04	P304	P304	PA15
ERROR RESET push switch (SW2)	PD07	P200	P200	PA13
LED1 ON/OFF control	PD01	P113	P113	PA12
LED2 ON/OFF control	PD02	P106	P106	PA14
LED3 ON/OFF control	PD03	-	-	-
U phase current measurement	PA04 / AN004	P000 / AN000	P000 / AN000	P004 / AN000
V phase current measurement	PA02 / AN002	P001 / AN001	P001 / AN001	P005 / AN001
W phase current measurement	PA00 / AN000	P002 / AN002	P002 / AN002	P006 / AN002
PWM output (U_p)	PB04 / GTIOC4A	P409 / GTIOC1A	P409 / GTIOC1A	P115 / GTIOC5A
PWM output (V_p)	PB06 / GTIOC5A	P103 / GTIOC2A	P103 / GTIOC2A	P113 / GTIOC2A
PWM output (W_p)	PB08 / GTIOC6A	P111 / GTIOC3A	P111 / GTIOC3A	P300 / GTIOC3A
PWM output (U_n)	PB05 / GTIOC4B	P408 / GTIOC1B	P408 / GTIOC1B	P609 / GTIOC5B
PWM output (V_n)	PB07 / GTIOC5B	P102 / GTIOC2B	P102 / GTIOC2B	P114 / GTIOC2B
PWM output (W_n)	PB09 / GTIOC6B	P112 / GTIOC3B	P112 / GTIOC3B	P112 / GTIOC3B
Encoder A phase input	PC14 / GTIOC3A	P100 / GTIOC5A	P100 / GTIOC5A	P903 / GTIOC11A
Encoder B phase input	PC15 / GTIOC3B	P101 / GTIOC5B	P101 / GTIOC5B	P904 / GTIOC11B
PWM emergency stop input at the time of overcurrent detection	PC13 / GTETRGD	P104 / GTETRGB	P104 / GTETRGB	P613 / GTETRGA

List of port interfaces of the sensor.

Table 2-5 Port Interfaces

Function	MCI-LV-1
+5V	CN5 2pin
Encoder A phase input	CN5 6pin
Encoder B phase input	CN5 8pin
GND	CN5 10pin

2.2.3 Peripheral functions

List of the peripheral functions used in this system is given in Table 2-6.

Table 2-6 List of the Peripheral Functions

Peripheral	Purpose	RA6T2	RA4T1	RA6T3	RA8T1
12-bit A/D Converter	U phase current measurement	AN004	AN000	AN000	AN000
	V phase current measurement	AN002	AN001	AN001	AN001
	W phase current measurement	AN000	AN002	AN002	AN002
	Inverter bus voltage measurement	AN006	AN004	AN004	AN008
	For rotation speed command value input (analog value)	AN008	AN005	AN005	AN007
AGT	Speed control interval timer	AGT0	AGT0	AGT0	AGT0
GPT	U phase PWM output	CH4	CN1	CN1	CH5
	V phase PWM output	CH5	CN2	CN2	CH2
	W phase PWM output	CH6	CN3	CN3	CH3
	Encoder phase counter	CH3	CH5	CH5	CH11
	Encoder count capture	CH1	CH0	CH0	CH0
POEG	PWM emergency stop input at the time of overcurrent detection	Group D	Group B	Group B	Group A

2.2.3.1 RA6T2

(1) 12-bit A/D Converter (ADC)

U-phase current (I_u), V-phase current (I_v), W-phase current (I_w), inverter bus voltage (V_{dc}), and speed command (VR) are measured in "Single scan mode" (use a hardware trigger).

A/D conversion is implemented to be synchronized with carrier synchronized interrupt as GPT underflow (PWM valley) by using GPT trigger function.

(2) Low Power Asynchronous General-Purpose Timer (AGT)

The AGT is used as 500 [μ s] interval timer.

(3) General PWM Timer (GPT)

On the channel 4, 5, and 6, output with dead time is performed by using the complementary PWM Output Operating Mode.

(4) Phase Counting Timer (GPT)

Channel 3 is used as phase counting mode2 to measure the phase difference between encoder phase A and B signal and counts the encoder input.

(5) Free run timer (GPT)

Channel 1 is used as a free run timer for speed measurement.

(6) Port Output Enable for GPT (POEG)

The port executing PWM output are set to high impedance state when an overcurrent is detected (when a low level of the GTETRGD port is detected).

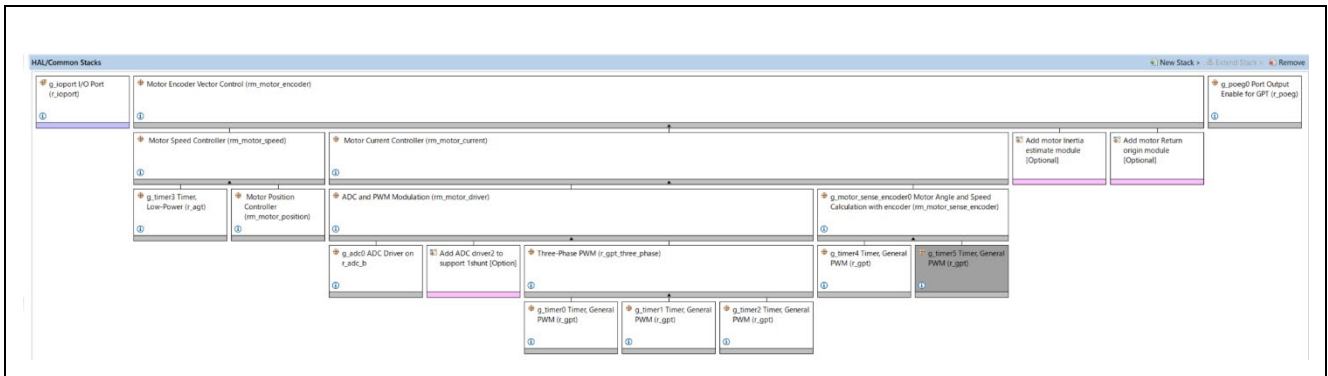

Figure 2-2 Overall FSP Stacks diagram

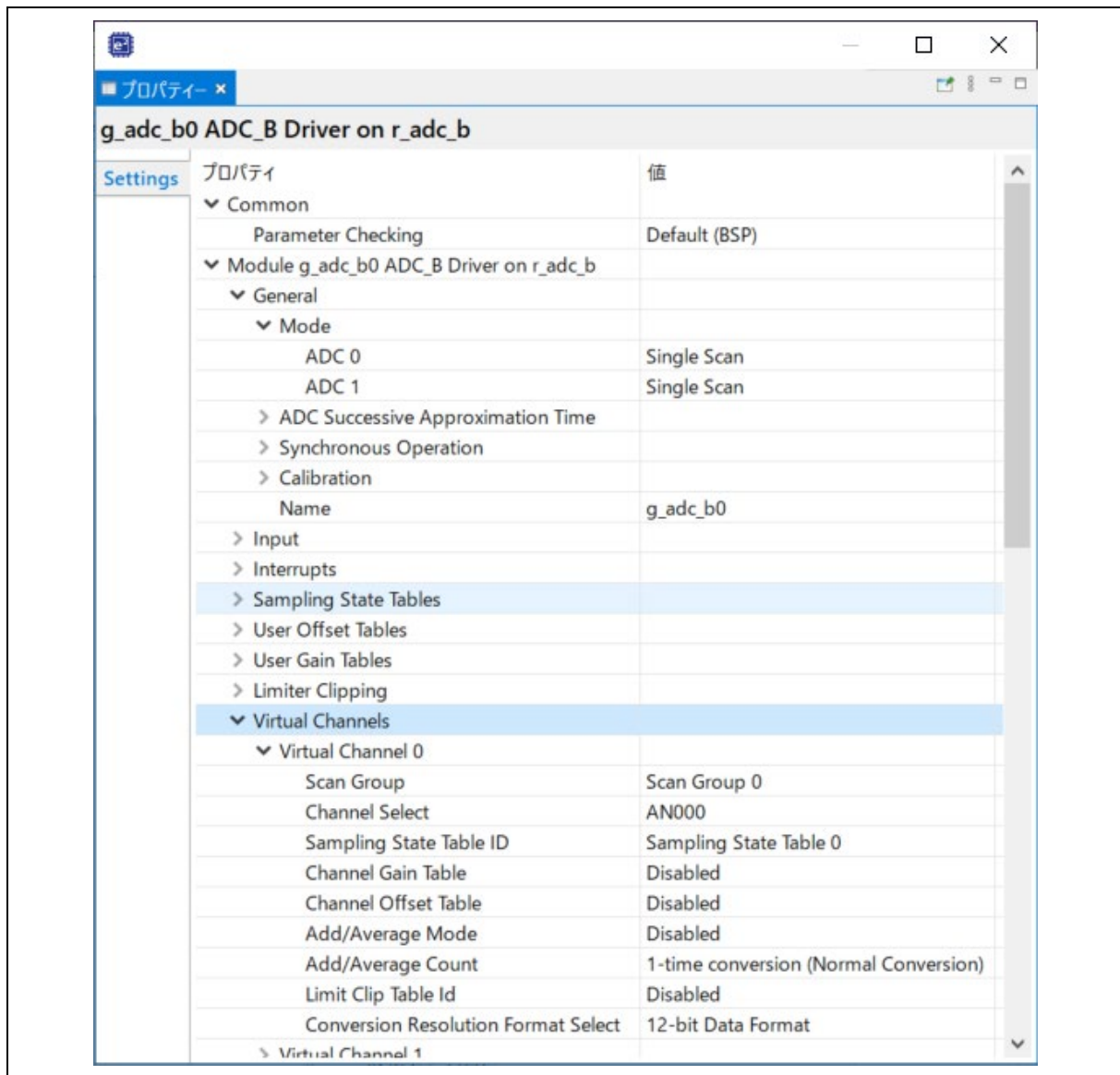

Figure 2-3 FSP Configuration of ADC Driver [1/3]

g_adc0 ADC Driver on r_adc_b		
Settings	Property	Value
API Info	▼ Virtual Channels	
	▼ Virtual Channel 0	
	Scan Group	Scan Group 0
	Channel Select	AN000
	Sampling State Table ID	Sampling State Entry 0
	Channel Gain Table	Disabled
	Channel Offset Table	Disabled
	Add/Average Mode	Disabled
	Add/Average Count	1-time conversion (Normal Conversion)
	Limit Clip Table Id	Disabled
	Conversion Resolution Format Select	12-bit Data Format
	▼ Virtual Channel 1	
	Scan Group	Scan Group 0
	Channel Select	AN002
	Sampling State Table ID	Sampling State Entry 0
	Channel Gain Table	Disabled
	Channel Offset Table	Disabled
	Add/Average Mode	Disabled
	Add/Average Count	1-time conversion (Normal Conversion)
	Limit Clip Table Id	Disabled
	Conversion Resolution Format Select	12-bit Data Format
	▼ Virtual Channel 2	
	Scan Group	Scan Group 0
	Channel Select	AN004
	Sampling State Table ID	Sampling State Entry 0
	Channel Gain Table	Disabled
	Channel Offset Table	Disabled
	Add/Average Mode	Disabled
	Add/Average Count	1-time conversion (Normal Conversion)
	Limit Clip Table Id	Disabled
	Conversion Resolution Format Select	12-bit Data Format
	▼ Virtual Channel 3	
	Scan Group	Scan Group 1
	Channel Select	AN006
	Sampling State Table ID	Sampling State Entry 0
	Channel Gain Table	Disabled
	Channel Offset Table	Disabled
	Add/Average Mode	Disabled
	Add/Average Count	1-time conversion (Normal Conversion)
	Limit Clip Table Id	Disabled
	Conversion Resolution Format Select	12-bit Data Format
	▼ Virtual Channel 4	
	Scan Group	Scan Group 1
	Channel Select	AN008
Sampling State Table ID	Sampling State Entry 0	
Channel Gain Table	Disabled	
Channel Offset Table	Disabled	
Add/Average Mode	Disabled	

Figure 2-4 FSP Configuration of ADC Driver [2/3]

g_adc0 ADC Driver on r_adc_b		
Settings	Property	Value
API Info	▼ Scan Group 0	
	> Self Diagnosis	
	> External Trigger Enable	
	> ELC Trigger Enable	
	▼ GPT Trigger Enable	
	GPT Channel 0 Request A	<input type="checkbox"/>
	GPT Channel 1 Request A	<input type="checkbox"/>
	GPT Channel 2 Request A	<input type="checkbox"/>
	GPT Channel 3 Request A	<input type="checkbox"/>
	GPT Channel 4 Request A	<input checked="" type="checkbox"/>
	GPT Channel 5 Request A	<input type="checkbox"/>
	GPT Channel 6 Request A	<input type="checkbox"/>
	GPT Channel 7 Request A	<input type="checkbox"/>
	GPT Channel 8 Request A	<input type="checkbox"/>
	GPT Channel 9 Request A	<input type="checkbox"/>
	GPT Channel 0 Request B	<input type="checkbox"/>
	GPT Channel 1 Request B	<input type="checkbox"/>
	GPT Channel 2 Request B	<input type="checkbox"/>
	GPT Channel 3 Request B	<input type="checkbox"/>
	GPT Channel 4 Request B	<input type="checkbox"/>
	GPT Channel 5 Request B	<input type="checkbox"/>
	GPT Channel 6 Request B	<input type="checkbox"/>
	GPT Channel 7 Request B	<input type="checkbox"/>
	GPT Channel 8 Request B	<input type="checkbox"/>
	GPT Channel 9 Request B	<input type="checkbox"/>
	Enable	Enable
	Converter Selection	ADC 0
	Start Trigger Delay	0
	Scan End Interrupt Enable	Enable
	Limit Clip Interrupt Enable	Disable
	FIFO Enable	Disable
	FIFO Interrupt Enable	Disable
	FIFO Interrupt Generation Level	0
	▼ Scan Group 1	
	> Self Diagnosis	
	> External Trigger Enable	
	> ELC Trigger Enable	
	> GPT Trigger Enable	
	Enable	Enable
	Converter Selection	ADC 1
	Start Trigger Delay	0
	Scan End Interrupt Enable	Disable
	Limit Clip Interrupt Enable	Disable
	FIFO Enable	Disable
	FIFO Interrupt Enable	Disable
FIFO Interrupt Generation Level	0	
> Scan Group 2		
> Scan Group 3		

Figure 2-5 FSP Configuration of ADC Driver [3/3]

g_timer3 Timer, Low-Power (r_agt)		
Settings	Property	Value
API Info	▼ Common	
	Parameter Checking	Default (BSP)
	Pin Output Support	Disabled
	Pin Input Support	Disabled
	▼ Module g_timer3 Timer, Low-Power (r_agt)	
	▼ General	
	Name	g_timer3
	Channel	0
	Mode	🔒 Periodic
	Period	30000
	Period Unit	Raw Counts
	Count Source	PCLKB
	> Output	
	> Input	
	▼ Interrupts	
	Callback	🔒 rm_motor_speed_cyclic
	Underflow Interrupt Priority	Priority 10

Figure 2-6 FSP Configuration of AGT Driver

g_timer0 Timer, General PWM (r_gpt)		
Settings	Property	Value
API Info	▼ Common	
	Parameter Checking	Default (BSP)
	Pin Output Support	Enabled with Extra Features
	Write Protect Enable	Disabled
	Clock Source	PCLKD
	▼ Module g_timer0 Timer, General PWM (r_gpt)	
	▼ General	
	Name	g_timer0
	Channel	4
	Mode	Triangle-Wave Symmetric PWM
	Period	50
	Period Unit	Microseconds
	▼ Output	
	> Custom Waveform	
	Duty Cycle Percent (only applicable in PWM mode)	50
	GTIOCA Output Enabled	True
	GTIOCA Stop Level	Pin Level Low
	GTIOCB Output Enabled	True
	GTIOCB Stop Level	Pin Level Low
	> Input	
	> Interrupts	
	▼ Extra Features	
	▼ Output Disable	
	> Output Disable POEG Trigger	
	POEG Link	POEG Channel 3
	GTIOCA Disable Setting	Set Hi Z
	GTIOCB Disable Setting	Set Hi Z
	▼ ADC Trigger	
	▼ Start Event Trigger (GPTE/GPTEH only)	
	Trigger Event A/D Converter Start Request A During	<input type="checkbox"/>
	Trigger Event A/D Converter Start Request A During	<input checked="" type="checkbox"/>
	Trigger Event A/D Converter Start Request B During	<input type="checkbox"/>
	Trigger Event A/D Converter Start Request B During	<input type="checkbox"/>
	▼ Dead Time	
	Dead Time Count Up (Raw Counts)	240
	Dead Time Count Down (Raw Counts) (GPTE/GPTEH o	240
	▼ ADC Trigger (GPTE/GPTEH only)	
	ADC A Compare Match (Raw Counts)	0
	ADC B Compare Match (Raw Counts)	0
	> Interrupt Skipping (GPTE/GPTEH only)	
	Extra Features	Enabled
	▼ Pins	
	GTIOC4A	PB04
	GTIOC4B	PB05

Figure 2-7 FSP Configuration of GPT Driver for PWM output

g_timer4 Timer, General PWM (r_gpt)		
Settings	Property	Value
API Info	▼ Common	
	Parameter Checking	Default (BSP)
	Pin Output Support	Enabled with Extra Features
	Write Protect Enable	Disabled
	Clock Source	PCLKD
	▼ Module g_timer4 Timer, General PWM (r_gpt)	
	▼ General	
	Name	g_timer4
	Channel	3
	Mode	🔒 Periodic
	Period	🔒 0xFFFFF
	Period Unit	Raw Counts
	▼ Output	
	> Custom Waveform	
	Duty Cycle Percent (only applicable in PWM mode)	50
	GTIOCA Output Enabled	False
	GTIOCA Stop Level	Pin Level Low
	GTIOCB Output Enabled	False
	GTIOCB Stop Level	Pin Level Low
	▼ Input	

Figure 2-8 FSP Configuration of GPT Driver for phase counting timer [1/5]

g_timer4 Timer, General PWM (r_gpt)		
Settings	Property	Value
API Info	GTIOCB Stop Level	Pin Level Low
	▼ Input	
	▼ Count Up Source	
	GTETRG A Rising Edge	<input type="checkbox"/>
	GTETRG A Falling Edge	<input type="checkbox"/>
	GTETRG B Rising Edge	<input type="checkbox"/>
	GTETRG B Falling Edge	<input type="checkbox"/>
	GTETRG C Rising Edge	<input type="checkbox"/>
	GTETRG C Falling Edge	<input type="checkbox"/>
	GTETRG D Rising Edge	<input type="checkbox"/>
	GTETRG D Falling Edge	<input type="checkbox"/>
	GTIOCA Rising Edge While GTIOCB Low	<input type="checkbox"/>
	GTIOCA Rising Edge While GTIOCB High	<input checked="" type="checkbox"/>
	GTIOCA Falling Edge While GTIOCB Low	<input checked="" type="checkbox"/>
	GTIOCA Falling Edge While GTIOCB High	<input type="checkbox"/>
	GTIOCB Rising Edge While GTIOCA Low	<input checked="" type="checkbox"/>
	GTIOCB Rising Edge While GTIOCA High	<input type="checkbox"/>
	GTIOCB Falling Edge While GTIOCA Low	<input type="checkbox"/>
	GTIOCB Falling Edge While GTIOCA High	<input checked="" type="checkbox"/>
	ADC0 ADI0 (End of A/D scanning operation(Gr.0))	<input type="checkbox"/>
	ADC0 ADI1 (End of A/D scanning operation(Gr.1))	<input type="checkbox"/>
	ADC0 ADI2 (End of A/D scanning operation(Gr.2))	<input type="checkbox"/>
	ADC0 ADI3 (End of A/D scanning operation(Gr.3))	<input type="checkbox"/>
	ADC0 ADI4 (End of A/D scanning operation(Gr.4))	<input type="checkbox"/>

Figure 2-9 FSP Configuration of GPT Driver for phase counting timer [2/5]

g_timer4 Timer, General PWM (r_gpt)		
Settings	Property	Value
API Info	▼ Count Down Source	
	GTETRGA Rising Edge	<input type="checkbox"/>
	GTETRGA Falling Edge	<input type="checkbox"/>
	GTETRGB Rising Edge	<input type="checkbox"/>
	GTETRGB Falling Edge	<input type="checkbox"/>
	GTETRGD Rising Edge	<input type="checkbox"/>
	GTETRGD Falling Edge	<input type="checkbox"/>
	GTETRCB Rising Edge	<input type="checkbox"/>
	GTETRCB Falling Edge	<input type="checkbox"/>
	GTETRCB Rising Edge While GTIOCB Low	<input checked="" type="checkbox"/>
	GTETRCB Rising Edge While GTIOCB High	<input type="checkbox"/>
	GTETRCB Falling Edge While GTIOCB Low	<input type="checkbox"/>
	GTETRCB Falling Edge While GTIOCB High	<input checked="" type="checkbox"/>
	GTIOCB Rising Edge While GTIOCA Low	<input type="checkbox"/>
	GTIOCB Rising Edge While GTIOCA High	<input checked="" type="checkbox"/>
	GTIOCB Falling Edge While GTIOCA Low	<input checked="" type="checkbox"/>
	GTIOCB Falling Edge While GTIOCA High	<input type="checkbox"/>
	ADC0 ADI0 (End of A/D scanning operation(Gr.0))	<input type="checkbox"/>
	ADC0 ADI1 (End of A/D scanning operation(Gr.1))	<input type="checkbox"/>

Figure 2-10 FSP Configuration of GPT Driver for phase counting timer [3/5]

g_timer4 Timer, General PWM (r_gpt)		
Settings	Property	Value
API Info	▼ Capture A Source	
	GTETRGA Rising Edge	<input type="checkbox"/>
	GTETRGA Falling Edge	<input type="checkbox"/>
	GTETRGB Rising Edge	<input type="checkbox"/>
	GTETRGB Falling Edge	<input type="checkbox"/>
	GTETRGD Rising Edge	<input type="checkbox"/>
	GTETRGD Falling Edge	<input type="checkbox"/>
	GTETRCB Rising Edge	<input type="checkbox"/>
	GTETRCB Falling Edge	<input type="checkbox"/>
	GTIOCA Rising Edge While GTIOCB Low	<input checked="" type="checkbox"/>
	GTIOCA Rising Edge While GTIOCB High	<input checked="" type="checkbox"/>
	GTIOCA Falling Edge While GTIOCB Low	<input checked="" type="checkbox"/>
	GTIOCA Falling Edge While GTIOCB High	<input checked="" type="checkbox"/>
	GTIOCB Rising Edge While GTIOCA Low	<input checked="" type="checkbox"/>
	GTIOCB Rising Edge While GTIOCA High	<input checked="" type="checkbox"/>
	GTIOCB Falling Edge While GTIOCA Low	<input checked="" type="checkbox"/>
	GTIOCB Falling Edge While GTIOCA High	<input checked="" type="checkbox"/>
	ADC0 ADI0 (End of A/D scanning operation(Gr.0))	<input type="checkbox"/>
	ADC0 ADI1 (End of A/D scanning operation(Gr.1))	<input type="checkbox"/>
	ADC0 ADI2 (End of A/D scanning operation(Gr.2))	<input type="checkbox"/>

Figure 2-11 FSP Configuration of GPT Driver for phase counting timer [4/5]

▼ Input	
> Count Up Source	
> Count Down Source	
> Start Source	
> Stop Source	
> Clear Source	
> Capture A Source	
> Capture B Source	
Noise Filter A Sampling Clock Select	Filter PCLKD / 4
Noise Filter B Sampling Clock Select	Filter PCLKD / 4
▼ Interrupts	
Callback	🔒 rm_motor_sense_encoder_interrupt
Overflow/Crest Interrupt Priority	Disabled
Capture A Interrupt Priority	Priority 3
Capture B Interrupt Priority	Disabled
Underflow/Trough Interrupt Priority	Disabled
> Extra Features	
▼ Pins	
GTIOC3A	PC14
GTIOC3B	PC15

Figure 2-12 FSP Configuration of GPT Driver for phase counting timer [5/5]

g_timer5 Timer, General PWM (r_gpt)		
Settings	Property	Value
API Info	▼ Common	
	Parameter Checking	Default (BSP)
	Pin Output Support	Enabled with Extra Features
	Write Protect Enable	Disabled
	Clock Source	PCLKD
	▼ Module g_timer5 Timer, General PWM (r_gpt)	
	▼ General	
	Name	g_timer5
	Channel	1
	Mode	🔒 Periodic
	Period	🔒 0xFFFFFFFF
	Period Unit	Raw Counts
	> Output	
	> Input	
	▼ Interrupts	
	Callback	NULL
	Overflow/Crest Interrupt Priority	Disabled
	Capture A Interrupt Priority	Disabled
	Capture B Interrupt Priority	Disabled
	Underflow/Trough Interrupt Priority	Disabled
	> Extra Features	

Figure 2-13 FSP Configuration of GPT Driver for free run timer

g_poeg0 Port Output Enable for GPT (r_poeg)		
Settings	Property	Value
API Info	<ul style="list-style-type: none"> ▼ Common Parameter Checking ▼ Module g_poeg0 Port Output Enable for GPT (r_poeg) ▼ General ▼ Trigger GTETRГ Pin GPT Output Level Oscillation Stop ACMPHS0 ACMPHS1 ACMPHS2 ACMPHS3 Name Channel ▼ Input GTETRГ Polarity GTETRГ Noise Filter ▼ Interrupts Callback Interrupt Priority 	<ul style="list-style-type: none"> Default (BSP) <input checked="" type="checkbox"/> <input type="checkbox"/> <input type="checkbox"/> <input type="checkbox"/> <input type="checkbox"/> <input type="checkbox"/> <input type="checkbox"/> g_poeg0 3 Active Low PCLKB/32 g_poe_overcurrent Priority 0 (highest)

Figure 2-14 FSP Configuration of POEG Driver

2.2.3.2 RA4T1

(1) 12-bit A/D Converter (ADC12)

U-phase current (I_u), V-phase current (I_v), W-phase current (I_w), inverter bus voltage (V_{dc}), and speed command (VR) are measured in "Single scan mode" (use a hardware trigger).

A/D conversion is implemented to be synchronized with carrier synchronized interrupt as GPT underflow (PWM valley) by using GPT trigger function.

(2) Low Power Asynchronous General-Purpose Timer (AGT)

The AGT is used as 500 [μs] interval timer.

(3) General PWM Timer (GPT)

On the channel 1, 2, and 3, output with dead time is performed by using the complementary PWM Output Operating Mode.

(4) Phase Counting Timer (GPT)

Channel 3 is used as phase counting mode2 to measure the phase difference between encoder phase A and B signal and counts the encoder input.

(5) Free run timer (GPT)

Channel 1 is used as a free run timer for speed measurement.

(6) Port Output Enable for GPT (POEG)

The port executing PWM output are set to high impedance state when an overcurrent is detected (when a low level of the GTETRGB port is detected).

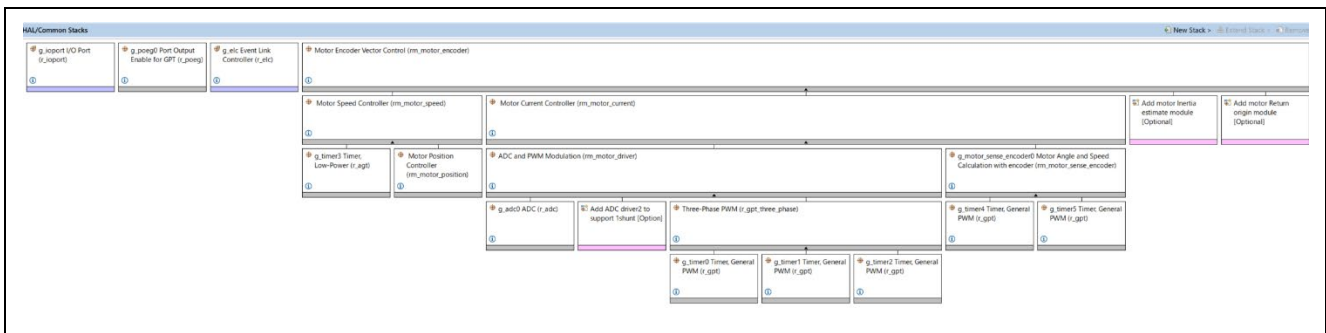

Figure 2-15 Overall FSP Stacks diagram

g_adc0 ADC (r_adc)		
Settings	Property	Value
API Info	▼ General	
	Name	g_adc0
	Unit	0
	Resolution	🔒 12-Bit
	Alignment	🔒 Right
	Clear after read	On
	Mode	Single Scan
	Double-trigger	Disabled
	> Input	
	▼ Interrupts	
	Normal/Group A Trigger	GPT1 COUNTER UNDERFLOW (Underflow)
	Group B Trigger	Disabled
	Group Priority (Valid only in Group Scan Mode)	Group A cannot interrupt Group B
	Callback	rm_motor_driver_cyclic
	Scan End Interrupt Priority	Priority 5
	Scan End Group B Interrupt Priority	Disabled
	Window Compare A Interrupt Priority	Disabled
	Window Compare B Interrupt Priority	Disabled
	> Extra	

Figure 2-16 FSP Configuration of ADC Driver [1/2]

g_adc0 ADC (r_adc)		
Settings	Property	Value
API Info	<ul style="list-style-type: none"> ▼ Module g_adc0 ADC (r_adc) <ul style="list-style-type: none"> > General <ul style="list-style-type: none"> ▼ Input <ul style="list-style-type: none"> ▼ Channel Scan Mask (channel availability varies by MCU) Channel 0 <input checked="" type="checkbox"/> Channel 1 <input checked="" type="checkbox"/> Channel 2 <input checked="" type="checkbox"/> Channel 3 <input type="checkbox"/> Channel 4 <input checked="" type="checkbox"/> Channel 5 <input checked="" type="checkbox"/> Channel 6 <input checked="" type="checkbox"/> Channel 7 <input type="checkbox"/> Channel 8 <input type="checkbox"/> Channel 9 <input type="checkbox"/> Channel 10 <input type="checkbox"/> Channel 11 <input type="checkbox"/> Channel 12 <input type="checkbox"/> Channel 13 <input type="checkbox"/> Channel 14 <input type="checkbox"/> Channel 15 <input type="checkbox"/> Channel 16 <input checked="" type="checkbox"/> Channel 17 <input type="checkbox"/> Channel 18 <input type="checkbox"/> Channel 19 <input type="checkbox"/> Channel 20 <input type="checkbox"/> Channel 21 <input type="checkbox"/> Channel 22 <input type="checkbox"/> Channel 23 <input type="checkbox"/> Channel 24 <input type="checkbox"/> Channel 25 <input type="checkbox"/> Channel 26 <input type="checkbox"/> Channel 27 <input type="checkbox"/> Temperature Sensor <input type="checkbox"/> Voltage Sensor <input type="checkbox"/> > Group B Scan Mask (channel availability varies by MCU) > Addition/Averaging Mask (channel availability varies by MCU and unit) ▼ Sample and Hold <ul style="list-style-type: none"> ▼ Sample and Hold Channels (Available only on selected MCUs) Channel 0 <input checked="" type="checkbox"/> Channel 1 <input checked="" type="checkbox"/> Channel 2 <input checked="" type="checkbox"/> Sample Hold States (Applies only to channels 0, 1, 2) 24 > Window Compare Add/Average Count <input type="checkbox"/> Disabled Reference Voltage control <input type="checkbox"/> VREFH0/VREFH > Interrupts > Extra 	

Figure 2-17 FSP Configuration of ADC Driver [2/2]

g_timer3 Timer, Low-Power (r_agt)		
Settings	Property	Value
API Info	▼ Common	
	Parameter Checking	Default (BSP)
	Pin Output Support	Disabled
	Pin Input Support	Disabled
	▼ Module g_timer3 Timer, Low-Power (r_agt)	
	▼ General	
	Name	g_timer3
	Channel	0
	Mode	🔒 Periodic
	Period	500
	Period Unit	Microseconds
	Count Source	PCLKB
	> Output	
	> Input	
	▼ Interrupts	
Callback	🔒 rm_motor_speed_cyclic	
Underflow Interrupt Priority	Priority 10	

Figure 2-18 FSP Configuration of AGT Driver

g_timer0 Timer, General PWM (r_gpt)		
Settings	Property	Value
API Info	Property	Value
	▼ Common	
	Parameter Checking	Default (BSP)
	Pin Output Support	Enabled with Extra Features
	Write Protect Enable	Disabled
	Clock Source	PCLKD
	▼ Module g_timer0 Timer, General PWM (r_gpt)	
	▼ General	
	Name	g_timer0
	Channel	1
	Mode	Triangle-Wave Symmetric PWM
	Period	50
	Period Unit	Microseconds
	▼ Output	
	> Custom Waveform	
	Duty Cycle Percent (only applicable in PWM mode)	50
	GTIOCA Output Enabled	True
	GTIOCA Stop Level	Pin Level Low
	GTIOCB Output Enabled	True
	GTIOCB Stop Level	Pin Level High
	> Input	
	> Interrupts	
	▼ Extra Features	
	▼ Output Disable	
	> Output Disable POEG Trigger	
	POEG Link	POEG Channel 1
	GTIOCA Disable Setting	Level Low
	GTIOCB Disable Setting	Level Low
	▼ ADC Trigger	
	▼ Start Event Trigger (Channels with GTINTAD only)	
	Trigger Event A/D Converter Start Request A During Up Counting	<input type="checkbox"/>
	Trigger Event A/D Converter Start Request A During Down Counting	<input type="checkbox"/>
Trigger Event A/D Converter Start Request B During Up Counting	<input type="checkbox"/>	
Trigger Event A/D Converter Start Request B During Down Counting	<input type="checkbox"/>	
▼ Dead Time		
Dead Time Count Up (Raw Counts)	200	
Dead Time Count Down (Raw Counts) (Channels with GTDVD only)	200	
▼ ADC Trigger (Channels with GTADTRA only)		
ADC A Compare Match (Raw Counts)	0	
▼ ADC Trigger (Channels with GTADTRB only)		
ADC B Compare Match (Raw Counts)	0	
▼ Interrupt Skipping (Channels with GTITC only)		
Interrupt to Count	Trough (triangle)	
Interrupt Skip Count	1	
Skip ADC Events	None	
Extra Features	Enabled	

Figure 2-19 FSP Configuration of GPT Driver for PWM output

g_timer4 Timer, General PWM (r_gpt)		
Settings	Property	Value
API Info	Property	Value
	▼ Common	
	Parameter Checking	Default (BSP)
	Pin Output Support	Enabled with Extra Features
	Write Protect Enable	Disabled
	Clock Source	PCLKD
	▼ Module g_timer4 Timer, General PWM (r_gpt)	
	▼ General	
	Name	g_timer4
	Channel	5
	Mode	🔒 Periodic
	Period	🔒 0xFFFFFFFF
	Period Unit	Raw Counts
	▼ Output	
	> Custom Waveform	
	Duty Cycle Percent (only applicable in PWM mode)	50
	GTIOCA Output Enabled	False
	GTIOCA Stop Level	Pin Level Low
	GTIOCB Output Enabled	False
	GTIOCB Stop Level	Pin Level Low
	> Input	
	> Interrupts	
	▼ Extra Features	
	▼ Output Disable	
	> Output Disable POEG Trigger	
	POEG Link	POEG Channel 0
	GTIOCA Disable Setting	Disable Prohibited
	GTIOCB Disable Setting	Disable Prohibited
	▼ ADC Trigger	
	▼ Start Event Trigger (Channels with GTINTAD only)	
	Trigger Event A/D Converter Start Request A During Up Counting	<input type="checkbox"/>
	Trigger Event A/D Converter Start Request A During Down Counting	<input type="checkbox"/>
	Trigger Event A/D Converter Start Request B During Up Counting	<input type="checkbox"/>
	Trigger Event A/D Converter Start Request B During Down Counting	<input type="checkbox"/>
	▼ Dead Time	
	Dead Time Count Up (Raw Counts)	0
	Dead Time Count Down (Raw Counts) (Channels with GTDVD only)	0
	▼ ADC Trigger (Channels with GTADTRA only)	
	ADC A Compare Match (Raw Counts)	0
	▼ ADC Trigger (Channels with GTADTRB only)	
	ADC B Compare Match (Raw Counts)	0
	▼ Interrupt Skipping (Channels with GTITC only)	
	Interrupt to Count	None
	Interrupt Skip Count	0
	Skip ADC Events	None
	Extra Features	Disabled

Figure 2-20 FSP Configuration of GPT Driver for phase counting timer [1/5]

g_timer4 Timer, General PWM (r_gpt)		
Settings	Property	Value
API Info	<ul style="list-style-type: none"> ▼ Input <ul style="list-style-type: none"> ▼ Count Up Source 	
	GTETRGA Rising Edge	<input type="checkbox"/>
	GTETRGA Falling Edge	<input type="checkbox"/>
	GTETRGB Rising Edge	<input type="checkbox"/>
	GTETRGB Falling Edge	<input type="checkbox"/>
	GTETRGC Rising Edge	<input type="checkbox"/>
	GTETRGC Falling Edge	<input type="checkbox"/>
	GTETRGD Rising Edge	<input type="checkbox"/>
	GTETRGD Falling Edge	<input type="checkbox"/>
	GTIOCA Rising Edge While GTIOCB Low	<input type="checkbox"/>
	GTIOCA Rising Edge While GTIOCB High	<input checked="" type="checkbox"/>
	GTIOCA Falling Edge While GTIOCB Low	<input checked="" type="checkbox"/>
	GTIOCA Falling Edge While GTIOCB High	<input type="checkbox"/>
	GTIOCB Rising Edge While GTIOCA Low	<input checked="" type="checkbox"/>
	GTIOCB Rising Edge While GTIOCA High	<input type="checkbox"/>
	GTIOCB Falling Edge While GTIOCA Low	<input type="checkbox"/>
	GTIOCB Falling Edge While GTIOCA High	<input checked="" type="checkbox"/>
	ADC0 COMPARE MATCH (Compare match)	<input type="checkbox"/>
	ADC0 COMPARE MISMATCH (Compare mismatch)	<input type="checkbox"/>
	ADC0 SCAN END (A/D scan end interrupt)	<input type="checkbox"/>
	AGT0 COMPARE A (Compare match A)	<input type="checkbox"/>
	AGT0 COMPARE B (Compare match B)	<input type="checkbox"/>
	AGT0 INT (AGT interrupt)	<input type="checkbox"/>
	ELC SOFTWARE EVENT 0 (Software event 0)	<input type="checkbox"/>
	ELC SOFTWARE EVENT 1 (Software event 1)	<input type="checkbox"/>
	GPT0 AD TRIG A (A/D converter start request A)	<input type="checkbox"/>
	GPT0 AD TRIG B (A/D converter start request B)	<input type="checkbox"/>
	GPT0 CAPTURE COMPARE A (Compare match A)	<input type="checkbox"/>
	GPT0 CAPTURE COMPARE B (Compare match B)	<input type="checkbox"/>
	GPT0 COMPARE C (Compare match C)	<input type="checkbox"/>
	GPT0 COMPARE D (Compare match D)	<input type="checkbox"/>
	GPT0 COMPARE E (Compare match E)	<input type="checkbox"/>
	GPT0 COMPARE F (Compare match F)	<input type="checkbox"/>
	GPT0 COUNTER OVERFLOW (Overflow)	<input type="checkbox"/>
	GPT0 COUNTER UNDERFLOW (Underflow)	<input type="checkbox"/>
	GPT1 AD TRIG A (A/D converter start request A)	<input type="checkbox"/>
	GPT1 AD TRIG B (A/D converter start request B)	<input type="checkbox"/>
	GPT1 CAPTURE COMPARE A (Compare match A)	<input type="checkbox"/>
	GPT1 CAPTURE COMPARE B (Compare match B)	<input type="checkbox"/>
	GPT1 COMPARE C (Compare match C)	<input type="checkbox"/>
	GPT1 COMPARE D (Compare match D)	<input type="checkbox"/>
	GPT1 COMPARE E (Compare match E)	<input type="checkbox"/>
	GPT1 COMPARE F (Compare match F)	<input type="checkbox"/>
	GPT1 COUNTER OVERFLOW (Overflow)	<input type="checkbox"/>
	GPT1 COUNTER UNDERFLOW (Underflow)	<input type="checkbox"/>
	GPT2 AD TRIG A (A/D converter start request A)	<input type="checkbox"/>

Figure 2-21 FSP Configuration of GPT Driver for phase counting timer [2/5]

Settings	Property	Value
API Info	▼ Count Down Source	
	GTETRGA Rising Edge	<input type="checkbox"/>
	GTETRGA Falling Edge	<input type="checkbox"/>
	GTETRGB Rising Edge	<input type="checkbox"/>
	GTETRGB Falling Edge	<input type="checkbox"/>
	GTETRGC Rising Edge	<input type="checkbox"/>
	GTETRGC Falling Edge	<input type="checkbox"/>
	GTETRGD Rising Edge	<input type="checkbox"/>
	GTETRGD Falling Edge	<input type="checkbox"/>
	GTIOCA Rising Edge While GTIOCB Low	<input checked="" type="checkbox"/>
	GTIOCA Rising Edge While GTIOCB High	<input type="checkbox"/>
	GTIOCA Falling Edge While GTIOCB Low	<input type="checkbox"/>
	GTIOCA Falling Edge While GTIOCB High	<input checked="" type="checkbox"/>
	GTIOCB Rising Edge While GTIOCA Low	<input type="checkbox"/>
	GTIOCB Rising Edge While GTIOCA High	<input checked="" type="checkbox"/>
	GTIOCB Falling Edge While GTIOCA Low	<input checked="" type="checkbox"/>
	GTIOCB Falling Edge While GTIOCA High	<input type="checkbox"/>
	ADC0 COMPARE MATCH (Compare match)	<input type="checkbox"/>
	ADC0 COMPARE MISMATCH (Compare mismatch)	<input type="checkbox"/>
	ADC0 SCAN END (A/D scan end interrupt)	<input type="checkbox"/>
	AGT0 COMPARE A (Compare match A)	<input type="checkbox"/>
	AGT0 COMPARE B (Compare match B)	<input type="checkbox"/>
	AGT0 INT (AGT interrupt)	<input type="checkbox"/>
	ELC SOFTWARE EVENT 0 (Software event 0)	<input type="checkbox"/>
	ELC SOFTWARE EVENT 1 (Software event 1)	<input type="checkbox"/>
	GPT0 AD TRIG A (A/D converter start request A)	<input type="checkbox"/>
	GPT0 AD TRIG B (A/D converter start request B)	<input type="checkbox"/>
	GPT0 CAPTURE COMPARE A (Compare match A)	<input type="checkbox"/>
	GPT0 CAPTURE COMPARE B (Compare match B)	<input type="checkbox"/>
	GPT0 COMPARE C (Compare match C)	<input type="checkbox"/>
	GPT0 COMPARE D (Compare match D)	<input type="checkbox"/>
	GPT0 COMPARE E (Compare match E)	<input type="checkbox"/>
	GPT0 COMPARE F (Compare match F)	<input type="checkbox"/>
	GPT0 COUNTER OVERFLOW (Overflow)	<input type="checkbox"/>
	GPT0 COUNTER UNDERFLOW (Underflow)	<input type="checkbox"/>
	GPT1 AD TRIG A (A/D converter start request A)	<input type="checkbox"/>
	GPT1 AD TRIG B (A/D converter start request B)	<input type="checkbox"/>
	GPT1 CAPTURE COMPARE A (Compare match A)	<input type="checkbox"/>
	GPT1 CAPTURE COMPARE B (Compare match B)	<input type="checkbox"/>
	GPT1 COMPARE C (Compare match C)	<input type="checkbox"/>
	GPT1 COMPARE D (Compare match D)	<input type="checkbox"/>
	GPT1 COMPARE E (Compare match E)	<input type="checkbox"/>
	GPT1 COMPARE F (Compare match F)	<input type="checkbox"/>
	GPT1 COUNTER OVERFLOW (Overflow)	<input type="checkbox"/>
	GPT1 COUNTER UNDERFLOW (Underflow)	<input type="checkbox"/>
	GPT2 AD TRIG A (A/D converter start request A)	<input type="checkbox"/>
	GPT2 AD TRIG B (A/D converter start request B)	<input type="checkbox"/>

Figure 2-22 FSP Configuration of GPT Driver for phase counting timer [3/5]

Settings	Property	Value
API Info	▼ Capture A Source	
	GTETRGA Rising Edge	<input type="checkbox"/>
	GTETRGA Falling Edge	<input type="checkbox"/>
	GTETRGB Rising Edge	<input type="checkbox"/>
	GTETRGB Falling Edge	<input type="checkbox"/>
	GTETRGC Rising Edge	<input type="checkbox"/>
	GTETRGC Falling Edge	<input type="checkbox"/>
	GTETRGD Rising Edge	<input type="checkbox"/>
	GTETRGD Falling Edge	<input type="checkbox"/>
	GTIOCA Rising Edge While GTIOCB Low	<input checked="" type="checkbox"/>
	GTIOCA Rising Edge While GTIOCB High	<input checked="" type="checkbox"/>
	GTIOCA Falling Edge While GTIOCB Low	<input checked="" type="checkbox"/>
	GTIOCA Falling Edge While GTIOCB High	<input checked="" type="checkbox"/>
	GTIOCB Rising Edge While GTIOCA Low	<input checked="" type="checkbox"/>
	GTIOCB Rising Edge While GTIOCA High	<input checked="" type="checkbox"/>
	GTIOCB Falling Edge While GTIOCA Low	<input checked="" type="checkbox"/>
	GTIOCB Falling Edge While GTIOCA High	<input checked="" type="checkbox"/>
	ADC0 COMPARE MATCH (Compare match)	<input type="checkbox"/>
	ADC0 COMPARE MISMATCH (Compare mismatch)	<input type="checkbox"/>
	ADC0 SCAN END (A/D scan end interrupt)	<input type="checkbox"/>
	AGT0 COMPARE A (Compare match A)	<input type="checkbox"/>
	AGT0 COMPARE B (Compare match B)	<input type="checkbox"/>
	AGT0 INT (AGT interrupt)	<input type="checkbox"/>
	ELC SOFTWARE EVENT 0 (Software event 0)	<input type="checkbox"/>
	ELC SOFTWARE EVENT 1 (Software event 1)	<input type="checkbox"/>
	GPT0 AD TRIG A (A/D converter start request A)	<input type="checkbox"/>
	GPT0 AD TRIG B (A/D converter start request B)	<input type="checkbox"/>
	GPT0 CAPTURE COMPARE A (Compare match A)	<input type="checkbox"/>
	GPT0 CAPTURE COMPARE B (Compare match B)	<input type="checkbox"/>
	GPT0 COMPARE C (Compare match C)	<input type="checkbox"/>
	GPT0 COMPARE D (Compare match D)	<input type="checkbox"/>
	GPT0 COMPARE E (Compare match E)	<input type="checkbox"/>
	GPT0 COMPARE F (Compare match F)	<input type="checkbox"/>
	GPT0 COUNTER OVERFLOW (Overflow)	<input type="checkbox"/>
	GPT0 COUNTER UNDERFLOW (Underflow)	<input type="checkbox"/>
	GPT1 AD TRIG A (A/D converter start request A)	<input type="checkbox"/>
	GPT1 AD TRIG B (A/D converter start request B)	<input type="checkbox"/>
	GPT1 CAPTURE COMPARE A (Compare match A)	<input type="checkbox"/>
	GPT1 CAPTURE COMPARE B (Compare match B)	<input type="checkbox"/>
	GPT1 COMPARE C (Compare match C)	<input type="checkbox"/>
	GPT1 COMPARE D (Compare match D)	<input type="checkbox"/>
	GPT1 COMPARE E (Compare match E)	<input type="checkbox"/>
	GPT1 COMPARE F (Compare match F)	<input type="checkbox"/>
	GPT1 COUNTER OVERFLOW (Overflow)	<input type="checkbox"/>
	GPT1 COUNTER UNDERFLOW (Underflow)	<input type="checkbox"/>
	GPT2 AD TRIG A (A/D converter start request A)	<input type="checkbox"/>
	GPT2 AD TRIG B (A/D converter start request B)	<input type="checkbox"/>

Figure 2-23 FSP Configuration of GPT Driver for phase counting timer [4/5]

g_timer4 Timer, General PWM (r_gpt)		
Settings	Property	Value
API Info	▼ Common	
	Parameter Checking	Default (BSP)
	Pin Output Support	Enabled with Extra Features
	Write Protect Enable	Disabled
	Clock Source	PCLKD
	▼ Module g_timer4 Timer, General PWM (r_gpt)	
	> General	
	> Output	
	▼ Input	
	> Count Up Source	
	> Count Down Source	
	> Start Source	
	> Stop Source	
	> Clear Source	
	> Capture A Source	
	> Capture B Source	
	Noise Filter A Sampling Clock Select	Filter PCLKD / 4
	Noise Filter B Sampling Clock Select	Filter PCLKD / 4
	▼ Interrupts	
	Callback	🔒 rm_motor_sense_encoder_interrupt
	Overflow/Crest Interrupt Priority	Disabled
	Capture A Interrupt Priority	Priority 3
	Capture B Interrupt Priority	Disabled
	Underflow/Trough Interrupt Priority	Disabled
	> Extra Features	

Figure 2-24 FSP Configuration of GPT Driver for phase counting timer [5/5]

g_timer5 Timer, General PWM (r_gpt)		
Settings	Property	Value
API Info	<ul style="list-style-type: none"> ▼ Common Parameter Checking Pin Output Support Write Protect Enable Clock Source ▼ Module g_timer5 Timer, General PWM (r_gpt) ▼ General Name Channel Mode Period Period Unit > Output > Input ▼ Interrupts Callback Overflow/Crest Interrupt Priority Capture A Interrupt Priority Capture B Interrupt Priority Underflow/Trough Interrupt Priority > Extra Features 	<ul style="list-style-type: none"> Default (BSP) Enabled with Extra Features Disabled PCLKD g_timer5 0 🔒 Periodic 🔒 0xFFFFFFFF Raw Counts NULL Disabled Disabled Disabled Disabled

Figure 2-25 FSP Configuration of GPT Driver for free run timer

g_poeg0 Port Output Enable for GPT (r_poeg)		
Settings	Property	Value
API Info	<ul style="list-style-type: none"> ▼ Common Parameter Checking ▼ Module g_poeg0 Port Output Enable for GPT (r_poeg) ▼ General ▼ Trigger GTETRG Pin GPT Output Level Oscillation Stop Name Channel ▼ Input GTETRG Polarity GTETRG Noise Filter ▼ Interrupts Callback Interrupt Priority 	<ul style="list-style-type: none"> Default (BSP) g_poeg0 1 Active Low PCLKB/32 g_poe_overcurrent Priority 0 (highest)

Figure 2-26 FSP Configuration of POEG Driver

2.2.3.3 RA6T3

(1) 12-bit A/D Converter (ADC12)

U-phase current (I_u), V-phase current (I_v), W-phase current (I_w), inverter bus voltage (V_{dc}), and speed command (VR) are measured in "Single scan mode" (use a hardware trigger).

A/D conversion is implemented to be synchronized with carrier synchronized interrupt as GPT underflow (PWM valley) by using GPT trigger function.

(2) Low Power Asynchronous General-Purpose Timer (AGT)

The AGT is used as 500 [μs] interval timer.

(3) General PWM Timer (GPT)

On the channel 1, 2, and 3, output with dead time is performed by using the complementary PWM Output Operating Mode.

(4) Phase Counting Timer (GPT)

Channel 3 is used as phase counting mode2 to measure the phase difference between encoder phase A and B signal and counts the encoder input.

(5) Free run timer (GPT)

Channel 1 is used as a free run timer for speed measurement.

(6) Port Output Enable for GPT (POEG)

The port executing PWM output are set to high impedance state when an overcurrent is detected (when a low level of the GTETRGB port is detected).

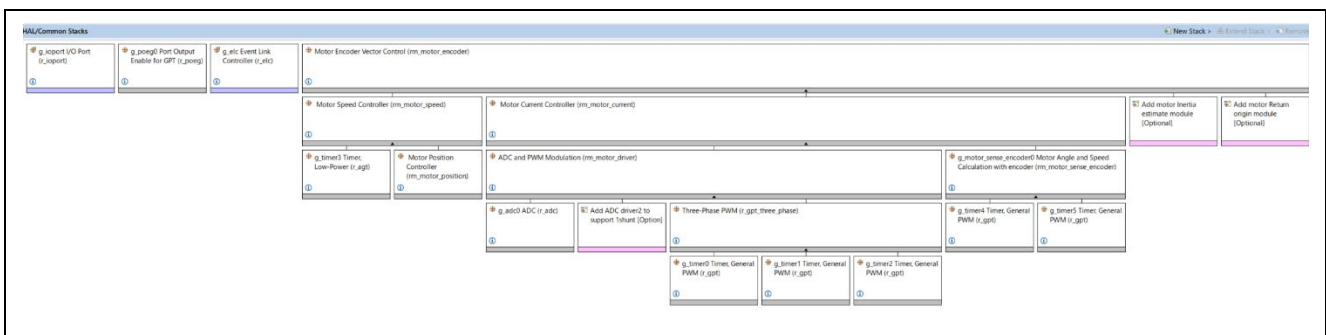

Figure 2-27 Overall FSP Stacks diagram

g_adc0 ADC (r_adc)		
Settings	Property	Value
API Info	▼ General	
	Name	g_adc0
	Unit	0
	Resolution	🔒 12-Bit
	Alignment	🔒 Right
	Clear after read	On
	Mode	Single Scan
	Double-trigger	Disabled
	> Input	
	▼ Interrupts	
	Normal/Group A Trigger	GPT1 COUNTER UNDERFLOW (Underflow)
	Group B Trigger	Disabled
	Group Priority (Valid only in Group Scan Mode)	Group A cannot interrupt Group B
	Callback	rm_motor_driver_cyclic
	Scan End Interrupt Priority	Priority 5
	Scan End Group B Interrupt Priority	Disabled
	Window Compare A Interrupt Priority	Disabled
	Window Compare B Interrupt Priority	Disabled
	> Extra	

Figure 2-28 FSP Configuration of ADC Driver [1/2]

g_adc0 ADC (r_adc)																																																																								
Settings	Property	Value																																																																						
API Info	<ul style="list-style-type: none"> ▼ Module g_adc0 ADC (r_adc) > General ▼ Input <ul style="list-style-type: none"> ▼ Channel Scan Mask (channel availability varies by MCU) <table border="0" style="width: 100%; border-collapse: collapse;"> <tr><td style="width: 80%;">Channel 0</td><td style="text-align: right;"><input checked="" type="checkbox"/></td></tr> <tr><td>Channel 1</td><td style="text-align: right;"><input checked="" type="checkbox"/></td></tr> <tr><td>Channel 2</td><td style="text-align: right;"><input checked="" type="checkbox"/></td></tr> <tr><td>Channel 3</td><td style="text-align: right;"><input type="checkbox"/></td></tr> <tr><td>Channel 4</td><td style="text-align: right;"><input checked="" type="checkbox"/></td></tr> <tr><td>Channel 5</td><td style="text-align: right;"><input checked="" type="checkbox"/></td></tr> <tr><td>Channel 6</td><td style="text-align: right;"><input checked="" type="checkbox"/></td></tr> <tr><td>Channel 7</td><td style="text-align: right;"><input type="checkbox"/></td></tr> <tr><td>Channel 8</td><td style="text-align: right;"><input type="checkbox"/></td></tr> <tr><td>Channel 9</td><td style="text-align: right;"><input type="checkbox"/></td></tr> <tr><td>Channel 10</td><td style="text-align: right;"><input type="checkbox"/></td></tr> <tr><td>Channel 11</td><td style="text-align: right;"><input type="checkbox"/></td></tr> <tr><td>Channel 12</td><td style="text-align: right;"><input type="checkbox"/></td></tr> <tr><td>Channel 13</td><td style="text-align: right;"><input type="checkbox"/></td></tr> <tr><td>Channel 14</td><td style="text-align: right;"><input type="checkbox"/></td></tr> <tr><td>Channel 15</td><td style="text-align: right;"><input type="checkbox"/></td></tr> <tr><td>Channel 16</td><td style="text-align: right;"><input checked="" type="checkbox"/></td></tr> <tr><td>Channel 17</td><td style="text-align: right;"><input type="checkbox"/></td></tr> <tr><td>Channel 18</td><td style="text-align: right;"><input type="checkbox"/></td></tr> <tr><td>Channel 19</td><td style="text-align: right;"><input type="checkbox"/></td></tr> <tr><td>Channel 20</td><td style="text-align: right;"><input type="checkbox"/></td></tr> <tr><td>Channel 21</td><td style="text-align: right;"><input type="checkbox"/></td></tr> <tr><td>Channel 22</td><td style="text-align: right;"><input type="checkbox"/></td></tr> <tr><td>Channel 23</td><td style="text-align: right;"><input type="checkbox"/></td></tr> <tr><td>Channel 24</td><td style="text-align: right;"><input type="checkbox"/></td></tr> <tr><td>Channel 25</td><td style="text-align: right;"><input type="checkbox"/></td></tr> <tr><td>Channel 26</td><td style="text-align: right;"><input type="checkbox"/></td></tr> <tr><td>Channel 27</td><td style="text-align: right;"><input type="checkbox"/></td></tr> <tr><td>Temperature Sensor</td><td style="text-align: right;"><input type="checkbox"/></td></tr> <tr><td>Voltage Sensor</td><td style="text-align: right;"><input type="checkbox"/></td></tr> </table> > Group B Scan Mask (channel availability varies by MCU) > Addition/Averaging Mask (channel availability varies by MCU and unit) ▼ Sample and Hold <ul style="list-style-type: none"> ▼ Sample and Hold Channels (Available only on selected MCUs) <table border="0" style="width: 100%; border-collapse: collapse;"> <tr><td style="width: 80%;">Channel 0</td><td style="text-align: right;"><input checked="" type="checkbox"/></td></tr> <tr><td>Channel 1</td><td style="text-align: right;"><input checked="" type="checkbox"/></td></tr> <tr><td>Channel 2</td><td style="text-align: right;"><input checked="" type="checkbox"/></td></tr> </table> Sample Hold States (Applies only to channels 0, 1, 2) 24 > Window Compare <table border="0" style="width: 100%; border-collapse: collapse;"> <tr><td>Add/Average Count</td><td style="text-align: right;">🔒 Disabled</td></tr> <tr><td>Reference Voltage control</td><td style="text-align: right;">🔒 VREFH0/VREFH</td></tr> </table> > Interrupts > Extra 	Channel 0	<input checked="" type="checkbox"/>	Channel 1	<input checked="" type="checkbox"/>	Channel 2	<input checked="" type="checkbox"/>	Channel 3	<input type="checkbox"/>	Channel 4	<input checked="" type="checkbox"/>	Channel 5	<input checked="" type="checkbox"/>	Channel 6	<input checked="" type="checkbox"/>	Channel 7	<input type="checkbox"/>	Channel 8	<input type="checkbox"/>	Channel 9	<input type="checkbox"/>	Channel 10	<input type="checkbox"/>	Channel 11	<input type="checkbox"/>	Channel 12	<input type="checkbox"/>	Channel 13	<input type="checkbox"/>	Channel 14	<input type="checkbox"/>	Channel 15	<input type="checkbox"/>	Channel 16	<input checked="" type="checkbox"/>	Channel 17	<input type="checkbox"/>	Channel 18	<input type="checkbox"/>	Channel 19	<input type="checkbox"/>	Channel 20	<input type="checkbox"/>	Channel 21	<input type="checkbox"/>	Channel 22	<input type="checkbox"/>	Channel 23	<input type="checkbox"/>	Channel 24	<input type="checkbox"/>	Channel 25	<input type="checkbox"/>	Channel 26	<input type="checkbox"/>	Channel 27	<input type="checkbox"/>	Temperature Sensor	<input type="checkbox"/>	Voltage Sensor	<input type="checkbox"/>	Channel 0	<input checked="" type="checkbox"/>	Channel 1	<input checked="" type="checkbox"/>	Channel 2	<input checked="" type="checkbox"/>	Add/Average Count	🔒 Disabled	Reference Voltage control	🔒 VREFH0/VREFH	
Channel 0	<input checked="" type="checkbox"/>																																																																							
Channel 1	<input checked="" type="checkbox"/>																																																																							
Channel 2	<input checked="" type="checkbox"/>																																																																							
Channel 3	<input type="checkbox"/>																																																																							
Channel 4	<input checked="" type="checkbox"/>																																																																							
Channel 5	<input checked="" type="checkbox"/>																																																																							
Channel 6	<input checked="" type="checkbox"/>																																																																							
Channel 7	<input type="checkbox"/>																																																																							
Channel 8	<input type="checkbox"/>																																																																							
Channel 9	<input type="checkbox"/>																																																																							
Channel 10	<input type="checkbox"/>																																																																							
Channel 11	<input type="checkbox"/>																																																																							
Channel 12	<input type="checkbox"/>																																																																							
Channel 13	<input type="checkbox"/>																																																																							
Channel 14	<input type="checkbox"/>																																																																							
Channel 15	<input type="checkbox"/>																																																																							
Channel 16	<input checked="" type="checkbox"/>																																																																							
Channel 17	<input type="checkbox"/>																																																																							
Channel 18	<input type="checkbox"/>																																																																							
Channel 19	<input type="checkbox"/>																																																																							
Channel 20	<input type="checkbox"/>																																																																							
Channel 21	<input type="checkbox"/>																																																																							
Channel 22	<input type="checkbox"/>																																																																							
Channel 23	<input type="checkbox"/>																																																																							
Channel 24	<input type="checkbox"/>																																																																							
Channel 25	<input type="checkbox"/>																																																																							
Channel 26	<input type="checkbox"/>																																																																							
Channel 27	<input type="checkbox"/>																																																																							
Temperature Sensor	<input type="checkbox"/>																																																																							
Voltage Sensor	<input type="checkbox"/>																																																																							
Channel 0	<input checked="" type="checkbox"/>																																																																							
Channel 1	<input checked="" type="checkbox"/>																																																																							
Channel 2	<input checked="" type="checkbox"/>																																																																							
Add/Average Count	🔒 Disabled																																																																							
Reference Voltage control	🔒 VREFH0/VREFH																																																																							

Figure 2-29 FSP Configuration of ADC Driver [2/2]

g_timer3 Timer, Low-Power (r_agt)		
Settings	Property	Value
API Info	▼ Common	
	Parameter Checking	Default (BSP)
	Pin Output Support	Disabled
	Pin Input Support	Disabled
	▼ Module g_timer3 Timer, Low-Power (r_agt)	
	▼ General	
	Name	g_timer3
	Channel	0
	Mode	🔒 Periodic
	Period	500
	Period Unit	Microseconds
	Count Source	PCLKB
	> Output	
	> Input	
▼ Interrupts		
Callback	🔒 rm_motor_speed_cyclic	
Underflow Interrupt Priority	Priority 10	

Figure 2-30 FSP Configuration of AGT Driver

g_timer0 Timer, General PWM (r_gpt)		
Settings	Property	Value
API Info	<ul style="list-style-type: none"> ▼ Common 	
	Parameter Checking	Default (BSP)
	Pin Output Support	Enabled with Extra Features
	Write Protect Enable	Disabled
	Clock Source	PCLKD
	▼ Module g_timer0 Timer, General PWM (r_gpt)	
	▼ General	
	Name	g_timer0
	Channel	1
	Mode	Triangle-Wave Symmetric PWM
	Period	50
	Period Unit	Microseconds
	▼ Output	
	> Custom Waveform	
	Duty Cycle Percent (only applicable in PWM mode)	50
	GTIOCA Output Enabled	True
	GTIOCA Stop Level	Pin Level Low
	GTIOCB Output Enabled	True
	GTIOCB Stop Level	Pin Level High
	> Input	
	> Interrupts	
	▼ Extra Features	
	▼ Output Disable	
	> Output Disable POEG Trigger	
	POEG Link	POEG Channel 1
	GTIOCA Disable Setting	Level Low
	GTIOCB Disable Setting	Level Low
	▼ ADC Trigger	
	> Start Event Trigger (Channels with GTINTAD only)	
	▼ Dead Time	
	Dead Time Count Up (Raw Counts)	200
	Dead Time Count Down (Raw Counts) (Channels with GTDVD only)	200
	▼ ADC Trigger (Channels with GTADTRA only)	
	ADC A Compare Match (Raw Counts)	0
	▼ ADC Trigger (Channels with GTADTRB only)	
	ADC B Compare Match (Raw Counts)	0
	▼ Interrupt Skipping (Channels with GTITC only)	
	Interrupt to Count	None
	Interrupt Skip Count	0
	Skip ADC Events	None
	Extra Features	Enabled

Figure 2-31 FSP Configuration of GPT Driver for PWM output

g_timer4 Timer, General PWM (r_gpt)		
Settings	Property	Value
API Info	Property	Value
	▼ Common	
	Parameter Checking	Default (BSP)
	Pin Output Support	Enabled with Extra Features
	Write Protect Enable	Disabled
	Clock Source	PCLKD
	▼ Module g_timer4 Timer, General PWM (r_gpt)	
	▼ General	
	Name	g_timer4
	Channel	5
	Mode	🔒 Periodic
	Period	🔒 0xFFFFFFFF
	Period Unit	Raw Counts
	▼ Output	
	> Custom Waveform	
	Duty Cycle Percent (only applicable in PWM mode)	50
	GTIOCA Output Enabled	False
	GTIOCA Stop Level	Pin Level Low
	GTIOCB Output Enabled	False
	GTIOCB Stop Level	Pin Level Low
	> Input	
	> Interrupts	
	▼ Extra Features	
	▼ Output Disable	
	> Output Disable POEG Trigger	
	POEG Link	POEG Channel 0
	GTIOCA Disable Setting	Disable Prohibited
	GTIOCB Disable Setting	Disable Prohibited
	▼ ADC Trigger	
	▼ Start Event Trigger (Channels with GTINTAD only)	
	Trigger Event A/D Converter Start Request A During Up Counting	<input type="checkbox"/>
	Trigger Event A/D Converter Start Request A During Down Counting	<input type="checkbox"/>
	Trigger Event A/D Converter Start Request B During Up Counting	<input type="checkbox"/>
	Trigger Event A/D Converter Start Request B During Down Counting	<input type="checkbox"/>
	▼ Dead Time	
	Dead Time Count Up (Raw Counts)	0
	Dead Time Count Down (Raw Counts) (Channels with GTDVD only)	0
	▼ ADC Trigger (Channels with GTADTRA only)	
	ADC A Compare Match (Raw Counts)	0
	▼ ADC Trigger (Channels with GTADTRB only)	
	ADC B Compare Match (Raw Counts)	0
	▼ Interrupt Skipping (Channels with GTITC only)	
	Interrupt to Count	None
	Interrupt Skip Count	0
	Skip ADC Events	None
	Extra Features	Disabled

Figure 2-32 FSP Configuration of GPT Driver for phase counting timer [1/5]

g_timer4 Timer, General PWM (r_gpt)		
Settings	Property	Value
API Info	▼ Input	
	▼ Count Up Source	
	GTETRGA Rising Edge	<input type="checkbox"/>
	GTETRGA Falling Edge	<input type="checkbox"/>
	GTETRGB Rising Edge	<input type="checkbox"/>
	GTETRGB Falling Edge	<input type="checkbox"/>
	GTETRGC Rising Edge	<input type="checkbox"/>
	GTETRGC Falling Edge	<input type="checkbox"/>
	GTETRGD Rising Edge	<input type="checkbox"/>
	GTETRGD Falling Edge	<input type="checkbox"/>
	GTIOCA Rising Edge While GTIOCB Low	<input type="checkbox"/>
	GTIOCA Rising Edge While GTIOCB High	<input checked="" type="checkbox"/>
	GTIOCA Falling Edge While GTIOCB Low	<input checked="" type="checkbox"/>
	GTIOCA Falling Edge While GTIOCB High	<input type="checkbox"/>
	GTIOCB Rising Edge While GTIOCA Low	<input checked="" type="checkbox"/>
	GTIOCB Rising Edge While GTIOCA High	<input type="checkbox"/>
	GTIOCB Falling Edge While GTIOCA Low	<input type="checkbox"/>
	GTIOCB Falling Edge While GTIOCA High	<input checked="" type="checkbox"/>
	ADC0 COMPARE MATCH (Compare match)	<input type="checkbox"/>
	ADC0 COMPARE MISMATCH (Compare mismatch)	<input type="checkbox"/>
	ADC0 SCAN END (A/D scan end interrupt)	<input type="checkbox"/>
	AGT0 COMPARE A (Compare match A)	<input type="checkbox"/>
	AGT0 COMPARE B (Compare match B)	<input type="checkbox"/>
	AGT0 INT (AGT interrupt)	<input type="checkbox"/>
	ELC SOFTWARE EVENT 0 (Software event 0)	<input type="checkbox"/>
	ELC SOFTWARE EVENT 1 (Software event 1)	<input type="checkbox"/>
	GPT0 AD TRIG A (A/D converter start request A)	<input type="checkbox"/>
	GPT0 AD TRIG B (A/D converter start request B)	<input type="checkbox"/>
	GPT0 CAPTURE COMPARE A (Compare match A)	<input type="checkbox"/>
	GPT0 CAPTURE COMPARE B (Compare match B)	<input type="checkbox"/>
	GPT0 COMPARE C (Compare match C)	<input type="checkbox"/>
	GPT0 COMPARE D (Compare match D)	<input type="checkbox"/>
	GPT0 COMPARE E (Compare match E)	<input type="checkbox"/>
	GPT0 COMPARE F (Compare match F)	<input type="checkbox"/>
	GPT0 COUNTER OVERFLOW (Overflow)	<input type="checkbox"/>
	GPT0 COUNTER UNDERFLOW (Underflow)	<input type="checkbox"/>
	GPT1 AD TRIG A (A/D converter start request A)	<input type="checkbox"/>
	GPT1 AD TRIG B (A/D converter start request B)	<input type="checkbox"/>
	GPT1 CAPTURE COMPARE A (Compare match A)	<input type="checkbox"/>
	GPT1 CAPTURE COMPARE B (Compare match B)	<input type="checkbox"/>
	GPT1 COMPARE C (Compare match C)	<input type="checkbox"/>
	GPT1 COMPARE D (Compare match D)	<input type="checkbox"/>
	GPT1 COMPARE E (Compare match E)	<input type="checkbox"/>
	GPT1 COMPARE F (Compare match F)	<input type="checkbox"/>
	GPT1 COUNTER OVERFLOW (Overflow)	<input type="checkbox"/>
	GPT1 COUNTER UNDERFLOW (Underflow)	<input type="checkbox"/>
	GPT2 AD TRIG A (A/D converter start request A)	<input type="checkbox"/>

Figure 2-33 FSP Configuration of GPT Driver for phase counting timer [2/5]

Settings	Property	Value
API Info	▼ Count Down Source	
	GTETRGA Rising Edge	<input type="checkbox"/>
	GTETRGA Falling Edge	<input type="checkbox"/>
	GTETRGB Rising Edge	<input type="checkbox"/>
	GTETRGB Falling Edge	<input type="checkbox"/>
	GTETRGC Rising Edge	<input type="checkbox"/>
	GTETRGC Falling Edge	<input type="checkbox"/>
	GTETRGD Rising Edge	<input type="checkbox"/>
	GTETRGD Falling Edge	<input type="checkbox"/>
	GTIOCA Rising Edge While GTIOCB Low	<input checked="" type="checkbox"/>
	GTIOCA Rising Edge While GTIOCB High	<input type="checkbox"/>
	GTIOCA Falling Edge While GTIOCB Low	<input type="checkbox"/>
	GTIOCA Falling Edge While GTIOCB High	<input checked="" type="checkbox"/>
	GTIOCB Rising Edge While GTIOCA Low	<input type="checkbox"/>
	GTIOCB Rising Edge While GTIOCA High	<input checked="" type="checkbox"/>
	GTIOCB Falling Edge While GTIOCA Low	<input checked="" type="checkbox"/>
	GTIOCB Falling Edge While GTIOCA High	<input type="checkbox"/>
	ADC0 COMPARE MATCH (Compare match)	<input type="checkbox"/>
	ADC0 COMPARE MISMATCH (Compare mismatch)	<input type="checkbox"/>
	ADC0 SCAN END (A/D scan end interrupt)	<input type="checkbox"/>
	AGT0 COMPARE A (Compare match A)	<input type="checkbox"/>
	AGT0 COMPARE B (Compare match B)	<input type="checkbox"/>
	AGT0 INT (AGT interrupt)	<input type="checkbox"/>
	ELC SOFTWARE EVENT 0 (Software event 0)	<input type="checkbox"/>
	ELC SOFTWARE EVENT 1 (Software event 1)	<input type="checkbox"/>
	GPT0 AD TRIG A (A/D converter start request A)	<input type="checkbox"/>
	GPT0 AD TRIG B (A/D converter start request B)	<input type="checkbox"/>
	GPT0 CAPTURE COMPARE A (Compare match A)	<input type="checkbox"/>
	GPT0 CAPTURE COMPARE B (Compare match B)	<input type="checkbox"/>
	GPT0 COMPARE C (Compare match C)	<input type="checkbox"/>
	GPT0 COMPARE D (Compare match D)	<input type="checkbox"/>
	GPT0 COMPARE E (Compare match E)	<input type="checkbox"/>
	GPT0 COMPARE F (Compare match F)	<input type="checkbox"/>
	GPT0 COUNTER OVERFLOW (Overflow)	<input type="checkbox"/>
	GPT0 COUNTER UNDERFLOW (Underflow)	<input type="checkbox"/>
	GPT1 AD TRIG A (A/D converter start request A)	<input type="checkbox"/>
	GPT1 AD TRIG B (A/D converter start request B)	<input type="checkbox"/>
	GPT1 CAPTURE COMPARE A (Compare match A)	<input type="checkbox"/>
	GPT1 CAPTURE COMPARE B (Compare match B)	<input type="checkbox"/>
	GPT1 COMPARE C (Compare match C)	<input type="checkbox"/>
	GPT1 COMPARE D (Compare match D)	<input type="checkbox"/>
	GPT1 COMPARE E (Compare match E)	<input type="checkbox"/>
	GPT1 COMPARE F (Compare match F)	<input type="checkbox"/>
	GPT1 COUNTER OVERFLOW (Overflow)	<input type="checkbox"/>
	GPT1 COUNTER UNDERFLOW (Underflow)	<input type="checkbox"/>
	GPT2 AD TRIG A (A/D converter start request A)	<input type="checkbox"/>
	GPT2 AD TRIG B (A/D converter start request B)	<input type="checkbox"/>

Figure 2-34 FSP Configuration of GPT Driver for phase counting timer [3/5]

Settings	Property	Value
API Info	▼ Capture A Source	
	GTETRGA Rising Edge	<input type="checkbox"/>
	GTETRGA Falling Edge	<input type="checkbox"/>
	GTETRGB Rising Edge	<input type="checkbox"/>
	GTETRGB Falling Edge	<input type="checkbox"/>
	GTETRGC Rising Edge	<input type="checkbox"/>
	GTETRGC Falling Edge	<input type="checkbox"/>
	GTETRGD Rising Edge	<input type="checkbox"/>
	GTETRGD Falling Edge	<input type="checkbox"/>
	GTIOCA Rising Edge While GTIOCB Low	<input checked="" type="checkbox"/>
	GTIOCA Rising Edge While GTIOCB High	<input checked="" type="checkbox"/>
	GTIOCA Falling Edge While GTIOCB Low	<input checked="" type="checkbox"/>
	GTIOCA Falling Edge While GTIOCB High	<input checked="" type="checkbox"/>
	GTIOCB Rising Edge While GTIOCA Low	<input checked="" type="checkbox"/>
	GTIOCB Rising Edge While GTIOCA High	<input checked="" type="checkbox"/>
	GTIOCB Falling Edge While GTIOCA Low	<input checked="" type="checkbox"/>
	GTIOCB Falling Edge While GTIOCA High	<input checked="" type="checkbox"/>
	ADC0 COMPARE MATCH (Compare match)	<input type="checkbox"/>
	ADC0 COMPARE MISMATCH (Compare mismatch)	<input type="checkbox"/>
	ADC0 SCAN END (A/D scan end interrupt)	<input type="checkbox"/>
	AGT0 COMPARE A (Compare match A)	<input type="checkbox"/>
	AGT0 COMPARE B (Compare match B)	<input type="checkbox"/>
	AGT0 INT (AGT interrupt)	<input type="checkbox"/>
	ELC SOFTWARE EVENT 0 (Software event 0)	<input type="checkbox"/>
	ELC SOFTWARE EVENT 1 (Software event 1)	<input type="checkbox"/>
	GPT0 AD TRIG A (A/D converter start request A)	<input type="checkbox"/>
	GPT0 AD TRIG B (A/D converter start request B)	<input type="checkbox"/>
	GPT0 CAPTURE COMPARE A (Compare match A)	<input type="checkbox"/>
	GPT0 CAPTURE COMPARE B (Compare match B)	<input type="checkbox"/>
	GPT0 COMPARE C (Compare match C)	<input type="checkbox"/>
	GPT0 COMPARE D (Compare match D)	<input type="checkbox"/>
	GPT0 COMPARE E (Compare match E)	<input type="checkbox"/>
	GPT0 COMPARE F (Compare match F)	<input type="checkbox"/>
	GPT0 COUNTER OVERFLOW (Overflow)	<input type="checkbox"/>
	GPT0 COUNTER UNDERFLOW (Underflow)	<input type="checkbox"/>
	GPT1 AD TRIG A (A/D converter start request A)	<input type="checkbox"/>
	GPT1 AD TRIG B (A/D converter start request B)	<input type="checkbox"/>
	GPT1 CAPTURE COMPARE A (Compare match A)	<input type="checkbox"/>
	GPT1 CAPTURE COMPARE B (Compare match B)	<input type="checkbox"/>
	GPT1 COMPARE C (Compare match C)	<input type="checkbox"/>
	GPT1 COMPARE D (Compare match D)	<input type="checkbox"/>
	GPT1 COMPARE E (Compare match E)	<input type="checkbox"/>
	GPT1 COMPARE F (Compare match F)	<input type="checkbox"/>
	GPT1 COUNTER OVERFLOW (Overflow)	<input type="checkbox"/>
	GPT1 COUNTER UNDERFLOW (Underflow)	<input type="checkbox"/>
	GPT2 AD TRIG A (A/D converter start request A)	<input type="checkbox"/>
	GPT2 AD TRIG B (A/D converter start request B)	<input type="checkbox"/>

Figure 2-35 FSP Configuration of GPT Driver for phase counting timer [4/5]

g_timer4 Timer, General PWM (r_gpt)		
Settings	Property	Value
API Info	▼ Common	
	Parameter Checking	Default (BSP)
	Pin Output Support	Enabled with Extra Features
	Write Protect Enable	Disabled
	Clock Source	PCLKD
	▼ Module g_timer4 Timer, General PWM (r_gpt)	
	> General	
	> Output	
	▼ Input	
	> Count Up Source	
	> Count Down Source	
	> Start Source	
	> Stop Source	
	> Clear Source	
	> Capture A Source	
	> Capture B Source	
	Noise Filter A Sampling Clock Select	Filter PCLKD / 4
	Noise Filter B Sampling Clock Select	Filter PCLKD / 4
	▼ Interrupts	
	Callback	🔒 rm_motor_sense_encoder_interrupt
	Overflow/Crest Interrupt Priority	Disabled
	Capture A Interrupt Priority	Priority 3
	Capture B Interrupt Priority	Disabled
	Underflow/Trough Interrupt Priority	Disabled
	> Extra Features	

Figure 2-36 FSP Configuration of GPT Driver for phase counting timer [5/5]

g_timer5 Timer, General PWM (r_gpt)		
Settings	Property	Value
API Info	<ul style="list-style-type: none"> Common <ul style="list-style-type: none"> Parameter Checking: Default (BSP) Pin Output Support: Enabled with Extra Features Write Protect Enable: Disabled Clock Source: PCLKD Module g_timer5 Timer, General PWM (r_gpt) <ul style="list-style-type: none"> General <ul style="list-style-type: none"> Name: g_timer5 Channel: 0 Mode: Periodic Period: 0xFFFFFFFF Period Unit: Raw Counts > Output > Input Interrupts <ul style="list-style-type: none"> Callback: NULL Overflow/Crest Interrupt Priority: Disabled Capture A Interrupt Priority: Disabled Capture B Interrupt Priority: Disabled Underflow/Trough Interrupt Priority: Disabled > Extra Features 	

Figure 2-37 FSP Configuration of GPT Driver for free run timer

g_poeg0 Port Output Enable for GPT (r_poeg)		
Settings	Property	Value
API Info	<ul style="list-style-type: none"> Common <ul style="list-style-type: none"> Parameter Checking: Default (BSP) Module g_poeg0 Port Output Enable for GPT (r_poeg) <ul style="list-style-type: none"> General <ul style="list-style-type: none"> Trigger <ul style="list-style-type: none"> GTETRG Pin: <input checked="" type="checkbox"/> GPT Output Level: <input type="checkbox"/> Oscillation Stop: <input type="checkbox"/> Name: g_poeg0 Channel: 1 Input <ul style="list-style-type: none"> GTETRG Polarity: Active Low GTETRG Noise Filter: PCLKB/32 Interrupts <ul style="list-style-type: none"> Callback: g_poe_overcurrent Interrupt Priority: Priority 0 (highest) 	

Figure 2-38 FSP Configuration of POEG Driver

2.2.3.4 RA8T1

(1) 12-bit A/D Converter (ADC12)

U-phase current (I_u), V-phase current (I_v), W-phase current (I_w), inverter bus voltage (V_{dc}), and speed command (VR) are measured in "Single scan mode" (use a hardware trigger).

A/D conversion is implemented to be synchronized with carrier synchronized interrupt as GPT underflow (PWM valley) by using GPT trigger function.

(2) Low Power Asynchronous General-Purpose Timer (AGT)

The AGT is used as 500 [μs] interval timer.

(3) General PWM Timer (GPT)

On the channel 5, 2, and 3, output with dead time is performed by using the complementary PWM Output Operating Mode.

(4) Phase Counting Timer (GPT)

Channel 11 is used as phase counting mode2 to measure the phase difference between encoder phase A and B signal and counts the encoder input.

(5) Free run timer (GPT)

Channel 0 is used as a free run timer for speed measurement.

(6) Port Output Enable for GPT (POEG)

The port executing PWM output are set to high impedance state when an overcurrent is detected (when a low level of the GTETRGA port is detected).

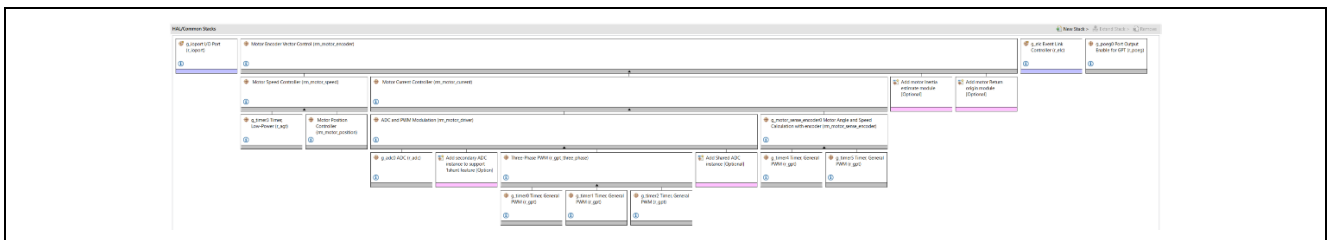

Figure 2-39 Overall FSP Stacks diagram

g_adc0 ADC (r_adc)		
Settings	プロパティ	値
API Info	▼ Common	
	Parameter Checking	Default (BSP)
API Info	▼ Module g_adc0 ADC (r_adc)	
	▼ General	
	Name	g_adc0
	Unit	0
	Resolution	🔒 12-Bit
	Alignment	🔒 Right
	Clear after read	On
	Mode	Single Scan
	Double-trigger	Disabled
	> Input	
	▼ Interrupts	
	Normal/Group A Trigger	Software
	Group B Trigger	Disabled
	Group Priority (Valid only in Group Scan Mode)	Group A cannot interrupt Group B
	Callback	rm_motor_driver_cyclic
	Scan End Interrupt Priority	Priority 5
	Scan End Group B Interrupt Priority	Disabled
	Window Compare A Interrupt Priority	Disabled
	Window Compare B Interrupt Priority	Disabled

Figure 2-40 FSP Configuration of ADC Driver [1/2]

g_adc0 ADC (r_adc)		
Settings	プロパティ	値
API Info	▼ Input	
	▼ Channel Scan Mask (channel availability varies by MCU)	
	Channel 0	<input checked="" type="checkbox"/>
	Channel 1	<input type="checkbox"/>
	Channel 2	<input checked="" type="checkbox"/>
	Channel 3	<input type="checkbox"/>
	Channel 4	<input type="checkbox"/>
	Channel 5	<input type="checkbox"/>
	Channel 6	<input type="checkbox"/>
	Channel 7	<input checked="" type="checkbox"/>
	Channel 8	<input checked="" type="checkbox"/>
	Channel 9	<input type="checkbox"/>
	Channel 10	<input type="checkbox"/>
	Channel 11	<input type="checkbox"/>
	Channel 12	<input type="checkbox"/>
	Channel 13	<input type="checkbox"/>
	Channel 14	<input type="checkbox"/>
	Channel 15	<input type="checkbox"/>
	Channel 16	<input type="checkbox"/>
	Channel 17	<input type="checkbox"/>
	Channel 18	<input type="checkbox"/>
	Channel 19	<input type="checkbox"/>
	Channel 20	<input type="checkbox"/>
	Channel 21	<input type="checkbox"/>
	Channel 22	<input type="checkbox"/>
	Channel 23	<input type="checkbox"/>
	Channel 24	<input type="checkbox"/>
	Channel 25	<input type="checkbox"/>
	Channel 26	<input type="checkbox"/>
	Channel 27	<input type="checkbox"/>
	Channel 28	<input type="checkbox"/>
	Temperature Sensor	<input type="checkbox"/>
	Internal Reference Voltage	<input type="checkbox"/>
	> Group B Scan Mask (channel availability varies by MCU)	
	> Addition/Averaging Mask (channel availability varies by MCU and unit)	
	▼ Sample and Hold	
	▼ Sample and Hold Channels (Available only on selected MCUs)	
	Channel 0	<input checked="" type="checkbox"/>
	Channel 1	<input type="checkbox"/>
	Channel 2	<input checked="" type="checkbox"/>
	Sample Hold States (Applies only to channels 0, 1, 2)	24
	> Window Compare	
	Add/Average Count	🔒 Disabled
	Reference Voltage control	🔒 VREFH0/VREFH

Figure 2-41 FSP Configuration of ADC Driver [2/2]

g_timer3 Timer, Low-Power (r_agt)		
Settings	プロパティ	値
API Info	▼ Common	
	Parameter Checking	Default (BSP)
	Pin Output Support	Disabled
	Pin Input Support	Disabled
	▼ Module g_timer3 Timer, Low-Power (r_agt)	
	▼ General	
	Name	g_timer3
	Counter Bit Width	AGT 16-bit
	Channel	0
	Mode	🔒 Periodic
	Period	500
	Period Unit	Microseconds
	Count Source	PCLKB
	> Output	
> Input		
▼ Interrupts		
Callback	🔒 rm_motor_speed_cyclic	
Underflow Interrupt Priority	Priority 10	

Figure 2-42 FSP Configuration of AGT Driver

g_timer0 Timer, General PWM (r_gpt)		
Settings	プロパティ	値
API Info	▼ Common	
	Parameter Checking	Default (BSP)
	Pin Output Support	Enabled with Extra Features
	Write Protect Enable	Disabled
	▼ Module g_timer0 Timer, General PWM (r_gpt)	
	▼ General	
	Name	g_timer0
	Channel	🔒 5
	Mode	🔒 Triangle-Wave Symmetric PWM
	Period	🔒 50.0
	Period Unit	🔒 Microseconds
	> Output	
	> Input	
	> Interrupts	
	▼ Extra Features	
	▼ Output Disable	
	> Output Disable POEG Trigger	
	POEG Link	POEG Channel 0
	GTIOCA Disable Setting	Set Hi Z
	GTIOCB Disable Setting	Set Hi Z
	▼ ADC Trigger	
	▼ Start Event Trigger (Channels with GTINTAD only)	
	Trigger Event A/D Converter Start Request A During Up Counting	<input type="checkbox"/>
	Trigger Event A/D Converter Start Request A During Down Counting	<input type="checkbox"/>
Trigger Event A/D Converter Start Request B During Up Counting	<input type="checkbox"/>	
Trigger Event A/D Converter Start Request B During Down Counting	<input type="checkbox"/>	
> Dead Time (Value range varies with Channel)		
> ADC Trigger (Channels with GTADTRA only)		
> ADC Trigger (Channels with GTADTRB only)		
> Interrupt Skipping (Channels with GTITC only)		
Extra Features	🔒 Enabled	

Figure 2-43 FSP Configuration of GPT Driver for PWM output

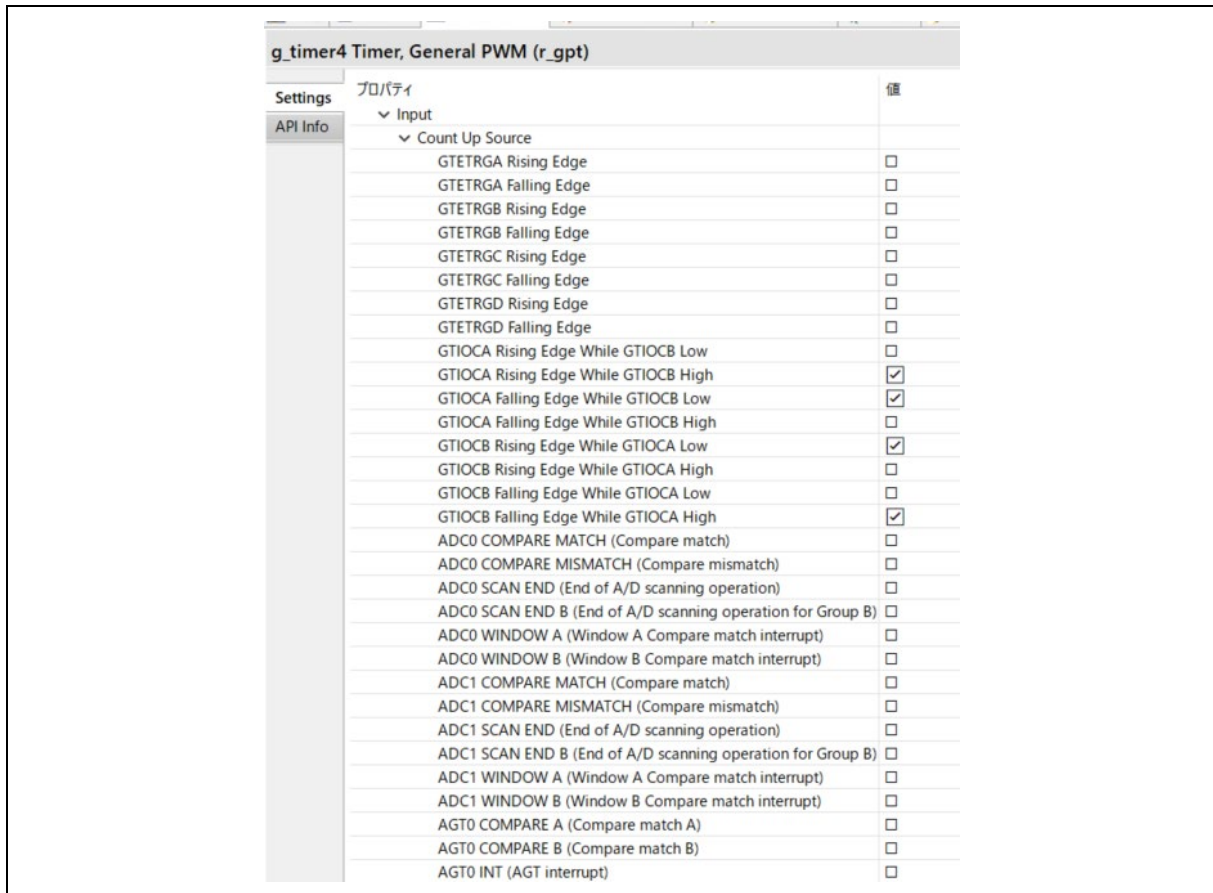

Figure 2-44 FSP Configuration of GPT Driver for phase counting timer [1/4]

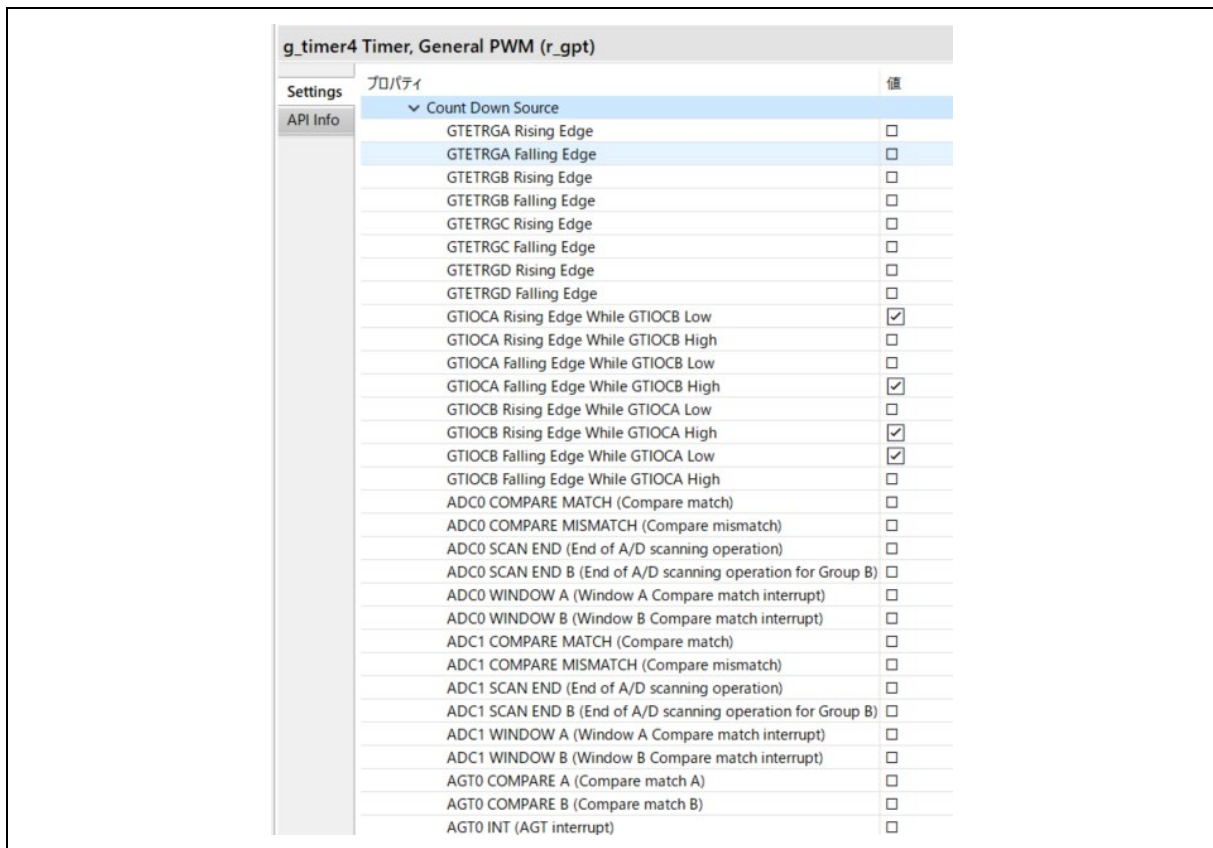

Figure 2-45 FSP Configuration of GPT Driver for phase counting timer [2/4]

g_timer4 Timer, General PWM (r_gpt)		
Settings	プロパティ	値
API Info	▼ Capture A Source	
	GTETRGA Rising Edge	<input type="checkbox"/>
	GTETRGA Falling Edge	<input type="checkbox"/>
	GTETRGB Rising Edge	<input type="checkbox"/>
	GTETRGB Falling Edge	<input type="checkbox"/>
	GTETRGC Rising Edge	<input type="checkbox"/>
	GTETRGC Falling Edge	<input type="checkbox"/>
	GTETRGD Rising Edge	<input type="checkbox"/>
	GTETRGD Falling Edge	<input type="checkbox"/>
	GTOCA Rising Edge While GTIOCB Low	<input checked="" type="checkbox"/>
	GTOCA Rising Edge While GTIOCB High	<input checked="" type="checkbox"/>
	GTOCA Falling Edge While GTIOCB Low	<input checked="" type="checkbox"/>
	GTOCA Falling Edge While GTIOCB High	<input checked="" type="checkbox"/>
	GTIOCB Rising Edge While GTOCA Low	<input checked="" type="checkbox"/>
	GTIOCB Rising Edge While GTOCA High	<input checked="" type="checkbox"/>
	GTIOCB Falling Edge While GTOCA Low	<input checked="" type="checkbox"/>
	GTIOCB Falling Edge While GTOCA High	<input checked="" type="checkbox"/>
	ADC0 COMPARE MATCH (Compare match)	<input type="checkbox"/>
	ADC0 COMPARE MISMATCH (Compare mismatch)	<input type="checkbox"/>
	ADC0 SCAN END (End of A/D scanning operation)	<input type="checkbox"/>
	ADC0 SCAN END B (End of A/D scanning operation for Group B)	<input type="checkbox"/>
	ADC0 WINDOW A (Window A Compare match interrupt)	<input type="checkbox"/>
	ADC0 WINDOW B (Window B Compare match interrupt)	<input type="checkbox"/>
	ADC1 COMPARE MATCH (Compare match)	<input type="checkbox"/>
	ADC1 COMPARE MISMATCH (Compare mismatch)	<input type="checkbox"/>
	ADC1 SCAN END (End of A/D scanning operation)	<input type="checkbox"/>
	ADC1 SCAN END B (End of A/D scanning operation for Group B)	<input type="checkbox"/>
	ADC1 WINDOW A (Window A Compare match interrupt)	<input type="checkbox"/>
	ADC1 WINDOW B (Window B Compare match interrupt)	<input type="checkbox"/>
	AGT0 COMPARE A (Compare match A)	<input type="checkbox"/>
	AGT0 COMPARE B (Compare match B)	<input type="checkbox"/>
	AGT0 INT (AGT interrupt)	<input type="checkbox"/>

Figure 2-46 FSP Configuration of GPT Driver for phase counting timer [3/4]

g_timer4 Timer, General PWM (r_gpt)		
Settings	プロパティ	値
API Info	▼ Common	
	Parameter Checking	Default (BSP)
	Pin Output Support	Enabled with Extra Features
	Write Protect Enable	Disabled
	▼ Module g_timer4 Timer, General PWM (r_gpt)	
	▼ General	
	Name	g_timer4
	Channel	11
	Mode	🔒 Periodic
	Period	0x10000
	Period Unit	Raw Counts
	> Output	
	> Input	
	▼ Interrupts	
	Callback	🔒 rm_motor_sense_encoder_interrupt
	Overflow/Crest Interrupt Priority	Disabled
	Capture A Interrupt Priority	Priority 3
Capture B Interrupt Priority	Disabled	
Underflow/Trough Interrupt Priority	Disabled	

Figure 2-47 FSP Configuration of GPT Driver for phase counting timer [4/4]

g_timer5 Timer, General PWM (r_gpt)		
Settings	プロパティ	値
API Info	▼ Common	
	Parameter Checking	Default (BSP)
	Pin Output Support	Enabled with Extra Features
	Write Protect Enable	Disabled
	▼ Module g_timer5 Timer, General PWM (r_gpt)	
	▼ General	
	Name	g_timer5
	Channel	0
	Mode	🔒 Periodic
	Period	0x100000000
	Period Unit	Raw Counts
	> Output	
	> Input	
	> Interrupts	
	> Extra Features	
	> Pins	

Figure 2-48 FSP Configuration of GPT Driver for free run timer

g_poeg0 Port Output Enable for GPT (r_poeg)		
Settings	プロパティ	値
API Info	▼ Common	
	Parameter Checking	Default (BSP)
	▼ Module g_poeg0 Port Output Enable for GPT (r_poeg)	
	▼ General	
	▼ Trigger	
	GTETRГ Pin	<input checked="" type="checkbox"/>
	GPT Output Level	<input type="checkbox"/>
	Oscillation Stop	<input type="checkbox"/>
	ACMPHS0	<input type="checkbox"/>
	ACMPHS1	<input type="checkbox"/>
	Name	g_poeg0
	Channel	0
	▼ Input	
	GTETRГ Polarity	Active Low
	GTETRГ Noise Filter	PCLKB/128
	▼ Interrupts	
	Callback	g_poe_overcurrent
	Interrupt Priority	Priority 0 (highest)

Figure 2-49 FSP Configuration of POEG Driver

2.3 Software configuration

2.3.1 Software file configuration

Folder and file configuration of the software is given below.

Table 2-7 File and folder configuration[1/2]

Folder	Subfolder	File	Remarks	
ra_cfg			Generated config header	
ra_gen			Generated register setting, main function etc	
ra	arm		CMSIS source code	
	board		Function definition for board	
	fsp/inc/api	bsp_api.h		BSP API definition
		r_adc_api.h		AD API definition
		r_elc_api.h		ELC API definition
		r_ioport_api.h		I/O API definition
		r_poeg_api.h		POEG API definition
		r_three_phase_api.h		3phase PWM API definition
		r_timer_api.h		Timer API definition
		r_transfer_api.h		Transfer API definition
		rm_motor_angle_api.h		Angle API definition
		rm_motor_api.h		Motor API definition
		rm_motor_current_api.h		Current API definition
		rm_motor_driver_api.h		Motor driver API definition
		rm_motor_inertia_estimate_api.h (Only RA4T1 and RA6T3)		Inertia estimate API definition
		rm_motor_position_api.h		Position API definition
		rm_motor_return_origin_api.h (Only RA4T1 and RA6T3)		Return origin API definition
		rm_motor_speed_api.h		Speed API definition
	fsp/inc/instances	r_adc_b.h(RA6T2) r_adc.h(RA4T1,RA6T3)		Function definition for AD
		r_agt.h		Function definition for AGT
		r_elc.h(Only RA4T1 and RA6T3)		Function definition for ELC
		r_gpt_three_phase.h		Function definition for 3 Phase PWM
		r_gpt.h		Function definition for GPT
		r_ioport.h		Function definition for I/O
		r_poeg.h		Function definition for POEG
		rm_motor_current.h		Function definition for current control
		rm_motor_driver.h		Function definition for motor driver
		rm_motor_encoder.h		Function definition for encoder control
		rm_motor_position_api.h		Function definition for position control
		rm_motor_sense_encoder.h		Function definition for encoder input process
		rm_motor_speed.h		Function definition for Speed

Table 2-8 File and folder configuration[2/2]

Folder	Subfolder	File	Remarks	
ra	fsp/lib		Library files	
	fsp/src	bsp		BSP driver
		r_adc_b/r_adc_b.c(RA6T2)		AD driver
		r_adc/r_adc.c(RA4T1,RA6T3)		
		r_agt/r_agt.c		AGT driver
		r_elc/r_elc.c(Only RA4T1 and RA6T3)		ELC driver
		r_gpt/r_gpt.c		GPT driver
		r_gpt_three_phase/ r_gpt_three_phase.c		3 phase PWM driver
		r_ioport/r_ioport.c		I/O driver
		r_poeg/r_poeg.c		POEG driver
		rm_motor_current/rm_motor_current.c		Current control driver
		rm_motor_current/rm_motor_current_library.h		Current control library API definition
		rm_motor_driver/rm_motor_driver.c		Motor driver
		rm_encoder/rm_motor_encoder.c		Encoder driver
		rm_position/rm_motor_position.c		Position control driver
		rm_position/rm_motor_position_library.h		Position control library API definition
		rm_sense_encoder/rm_motor_sense_encoder.c		Encoder input process driver
		rm_motor_speed/rm_motor_speed.c		Speed control driver
rm_motor_speed/rm_motor_speed_library.h		Speed control library API definition		
src	application/main	mtr_main.h , mtr_main.c	User main function	
		r_mtr_control_parameter.h	Control parameters definition	
		r_mtr_motor_parameter.h	Motor parameters definition	
	application/user_interface/ics	r_mtr_ics.h , r_mtr_ics.c	Function definition for Analyzer	
		ICS2_RA6T2.h , ICS2_RA4T1.h , ICS2_RA6T3.h	Function definition for GUI tool	
		ICS2_RA6T2.o , ICS2_RA4T1.o , ICS2_RA6T3.o	Communication library for GUI tool	

2.3.2 Module configuration

Module configuration of the software is described below.

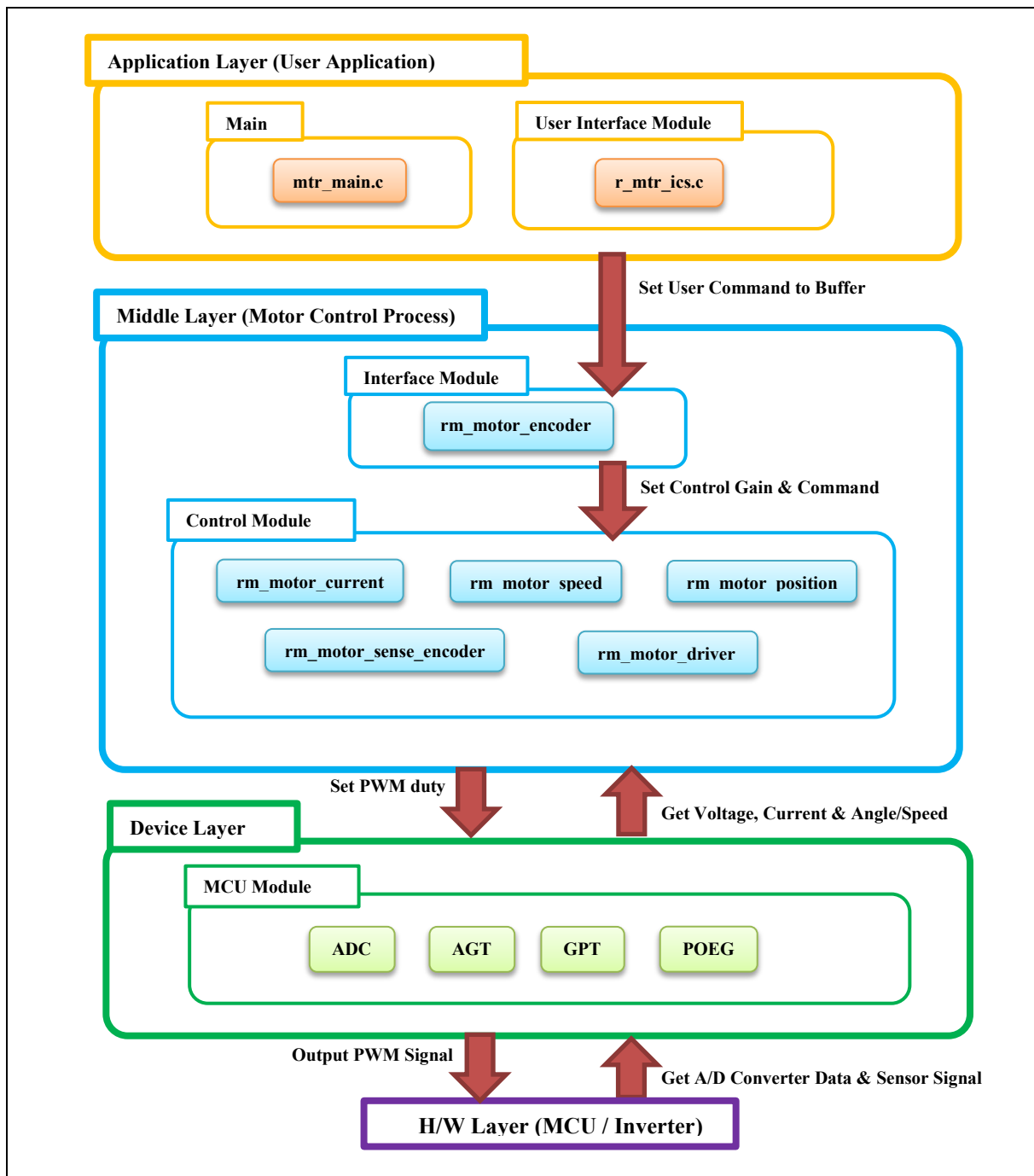

Figure 2-50 Module Configuration

2.4 Software specifications

Table 2-9 shows basic software specification of this system. For details of the vector control with encoder, refer to the application note 'Vector control with encoder for permanent magnet synchronous motor (Algorithm)' (R01AN3789).

Table 2-9 Basic Specifications of Vector Control with encoder Software

Item	Content	
Control method	Vector control	
Position detection method	Incremental encoder (A-B Phase)	
Motor rotation start/stop	SW1 input or input from 'Renesas Motor Workbench'	
Input voltage	DC 24 [V]	
Main clock frequency	RA6T2: 240 [MHz] RA6T3: 200 [MHz] RA4T1: 100 [MHz] RA8T1: 480[MHz]	
Carrier frequency (PWM)	20 [kHz] (Carrier period: 50 [μs])	
Dead time	2 [μs]	
Current control period	RA6T2: 50 [μs] RA6T3: 50 [μs] RA4T1: 100 [μs] RA8T1: 50 [μs]	
Speed control period	RA6T2: 500 [μs] RA6T3: 500 [μs] RA4T1: 1000 [μs] RA8T1: 500 [μs]	
Rotation speed control range	CW: 0 [rpm] to 4000 [rpm] CCW: 0 [rpm] to 4000 [rpm]	
Position control range	At board_ui	Position command generation: Voltage input divided by VR (input range) -180° to 180°
	At ics_ui	Position command generation: Position profile of trapezoidal curve for speed command value (input range) -32768° to 32767° (Max speed) CW / CCW: 4000[rpm]
Dead band of position*	Encoder count ±1 [cpr] (±0.09degree)	
Natural frequency of each control system	Current control system : 300 [Hz] Speed control system : 30 [Hz] Position estimation system : 5 [Hz]	
Optimization setting of compiler	Optimization level	Optimize more(-O2) (default setting)
Processing stop for protection	<p>Disables the motor control signal output (six outputs), under any of the following conditions.</p> <ol style="list-style-type: none"> 1. Instantaneous value of current of any phase exceeds $3.82(=1.8 \times \sqrt{2}) \times 1.5$ [A] (monitored every 50 [μs]) 2. Inverter bus voltage exceeds 60 [V] (monitored in current control period) 3. Inverter bus voltage is less than 8 [V] (monitored in current control period) 4. Rotation speed exceeds 4500 [rpm] (monitored in current control period) <p>When an external over current signal is detected (when a low level is detected), the PWM output ports are set to high impedance state.</p>	

* Dead band is provided to avoid hunting at the detection of target position.

2.5 Interrupt Priority

Table 2-10 shows the interrupt and priorities used in this system.

Table 2-10 Interrupt priority

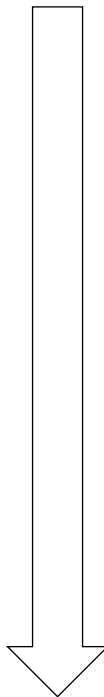
Interrupt level	Priority	function
15	Min  Max	
14		
13		
12		
11		
10		AGT0 INT Speed control Interrupt
9		
8		
7		
6		
5		ADC0 ADI0(RA6T2) ADC0 SCAN END(RA4T1,RA6T3,RA8T1) A/D conversion complete interrupt
4		
3		GPT3 CAPTURE COMPARE A(RA6T2) GPT5 CAPTURE COMPARE A(RA4T1,RA6T3) GPT11 CAPTURE COMPARE A(RA8T1) GPT capture compare A interrupt (Input capture of encoder input)
2		
1		
0		POEG3 EVENT(RA6T2) POEG1 EVENT(RA4T1,RA6T3) POEG0 EVENT(RA8T1) Over current error interrupt

Allocations		
Interrupt	Event	ISR
0	AGT0 INT (AGT interrupt)	agt_int_isr
1	ADC0 ADI0 (End of A/D scanning operation(Gr.0))	adc_b_adi0_isr
2	GPT3 CAPTURE COMPARE A (Compare match A)	gpt_capture_a_isr
3	POEG3 EVENT (Port Output disable interrupt D)	poeg_event_isr

Figure 2-51 RA6T2 FSP Interrupts Configuration

Allocations		
Interrupt	Event	ISR
0	POEG1 EVENT (Port Output disable interrupt B)	poeg_event_isr
1	AGT0 INT (AGT interrupt)	agt_int_isr
2	ADC0 SCAN END (A/D scan end interrupt)	adc_scan_end_isr
3	GPT5 CAPTURE COMPARE A (Compare match A)	gpt_capture_a_isr

Figure 2-52 RA4T1/RA6T3 FSP Interrupts Configuration

Allocations		
Interrupt	Event	ISR
0	AGT0 INT (AGT interrupt)	agt_int_isr
1	ADC0 SCAN END (End of A/D scanning operation)	adc_scan_end_isr
2	GPT11 CAPTURE COMPARE A (Compare match A)	gpt_capture_a_isr
3	POEG0 EVENT (Port Output disable interrupt A)	poeg_event_isr

Figure 2-53 RA8T1 FSP Interrupts Configuration

3. Descriptions of the control program

The target software of this application note is explained here.

3.1 Contents of control

3.1.1 Motor start/stop

Starting and stopping of the motor are controlled by input from 'Renesas Motor Workbench' or SW1.

A general-purpose port is assigned to SW1 and based upon its level the motor operation is controlled.

"High" level → Motor Start

"Low" level → Motor Stop

3.1.2 A/D Converter

(1) Motor rotation speed reference

The rotation speed and position command value of the motor is determined from the input from 'Renesas Motor Workbench' or the output value (analog value) of VR1. Rotation speed and position command value from VR1 is measured as shown in the table below.

Table 3-1 Conversion Ratio of the Rotation Speed Reference

Item	Conversion ratio (reference: A/D conversion value)	
Rotation speed reference	CW	0 rpm to 4000 rpm: 0800H to 0FFFH
	CCW	0 rpm to 4000 rpm: 07FFH to 0000H
Position reference	CW	0 rpm to 180 degrees: 0800H to 0FFFH
	CCW	0 rpm to 180 degrees: 07FFH to 0000H

(2) Inverter bus voltage

Inverter bus voltage is measured as shown in the table below. It is used for calculation of modulation rate and detection of overvoltage and low voltage (PWM stops in case of abnormality).

Table 3-2 Inverter Bus Voltage Conversion Ratio

Item	Conversion ratio (Inverter bus voltage: A/D conversion value)
Inverter bus voltage	0 [V] to 73.26 [V]: 0000H to 0FFFH

(3) U, W phase current

The U, V and W phase currents are measured as shown in Table 3-3 and used for vector control. User can select only U and W phase currents to use as 2shunt resistances detection.

Table 3-3 Conversion Ratio of U, V and W Phase Current

Item	Conversion ratio (U, V, W phase current: A/D conversion value)
U, W phase current	-8.25 [A] to 8.25 [A]: 0000H to 0FFFH ^(Note)
	Current = (3.3V-1.65V)/(0.01Ohm * 20) =8.25A

3.1.3 Modulation (current control module)

A modulated voltage can be output to improve the efficiency of voltage usage. The modulation operation is set from the API of the current control module.

3.1.3.1 Description of the functionality

With this module, you can select from two types of pulse width modulation drive methods.

(a) Sine wave modulation (MOD_METHOD_SPWM)

The modulation factor m is defined as follows.

$$m = \frac{V}{E}$$

m : Modulation ratio V : Reference voltage E : Inverter input voltage

(b) Space Vector Modulation (MOD_METHOD_SVPWM) *

In vector control of a permanent magnet synchronous motor, generally, the desired voltage command value of each phase is generated sinusoidally. However, if the generated value is used as-is for the modulation wave for PWM generation, voltage utilization as applied to the motor (in terms of line voltage) is limited to a maximum of 86.7% with respect to inverter bus voltage. As such, as shown in the following expression, the average of the maximum and minimum values is calculated for the voltage command value of each phase, and the value obtained by subtracting the average from the voltage command value of each phase is used as the modulation wave. As a result, the maximum amplitude of the modulation wave is multiplied by $\sqrt{3}/2$, while voltage utilization becomes 100% and line voltage is unchanged.

$$\begin{pmatrix} V'_u \\ V'_v \\ V'_w \end{pmatrix} = \begin{pmatrix} V_u \\ V_v \\ V_w \end{pmatrix} + \Delta V \begin{pmatrix} 1 \\ 1 \\ 1 \end{pmatrix}$$

$$\therefore \Delta V = -\frac{V_{max} + V_{min}}{2}, \quad V_{max} = \max\{V_u, V_v, V_w\}, \quad V_{min} = \min\{V_u, V_v, V_w\}$$

V_u, V_v, V_w : Command values of U-, V-, and W-phases
 V'_u, V'_v, V'_w : Command values of U-, V-, and W-phases for PWM generation (modulation wave)

The modulation factor m is defined as follows.

$$m = \frac{V'}{E}$$

m : Modulation ratio V' : Reference phase voltage for PWM
 E : Inverter input voltage

3.1.4 State transition

Figure 3-1 is a state transition diagram of the vector control with encoder software. In the target software of this application note, the software state is managed by “SYSTEM MODE”.

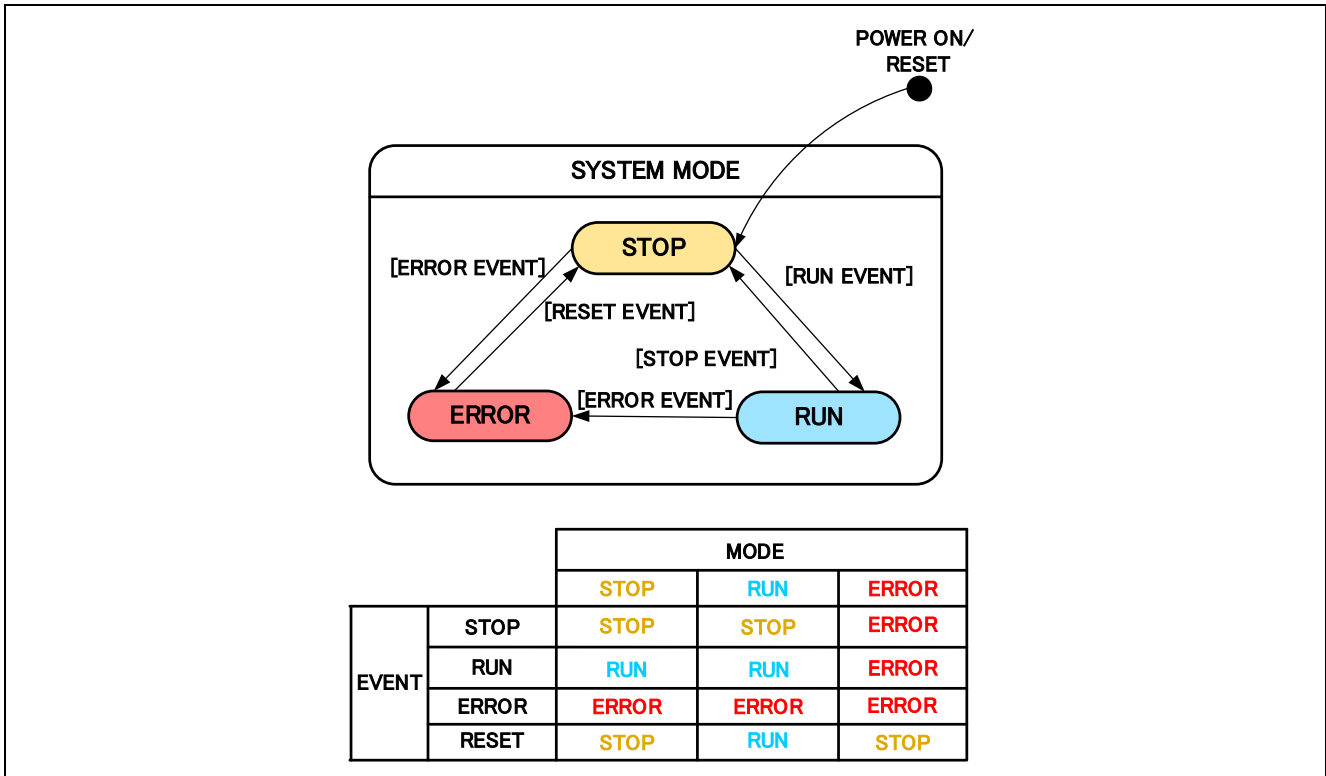

Figure 3-1 State Transition Diagram of Vector Control with encoder Software

(1). SYSTEM MODE

“SYSTEM MODE” indicates the operating states of the system. The state transits on occurrence of each event (EVENT). “SYSTEM MODE” has 3 states that are motor drive stop (INACTIVE), motor drive (ACTIVE), and abnormal condition (ERROR).

(2). EVENT

When “EVENT” occurs in each “SYSTEM MODE”, “SYSTEM MODE” changes as shown the table in Figure 3-1, according to that “EVENT”. The occurrence factors of each event are shown below.

Table 3-4 List of EVENT

EVENT name	occurrence factor
STOP	by user operation
RUN	by user operation
ERROR	when the system detects an error
RESET	by user operation

3.1.5 Start-up method

Figure 3-2 and Figure 3-3 show the software implementation of d-axis and encoder alignment method. The d-axis alignment method used as startup control of position control method, in initialization mode (MTR_MODE_INIT) and Boot mode (MTR_MODE_BOOT). In drive mode (MTR_MODE_DRIVE) vector control is implemented for PMSM with encoder. Each reference value setting of d-axis current, q-axis current and speed is managed by respective status.

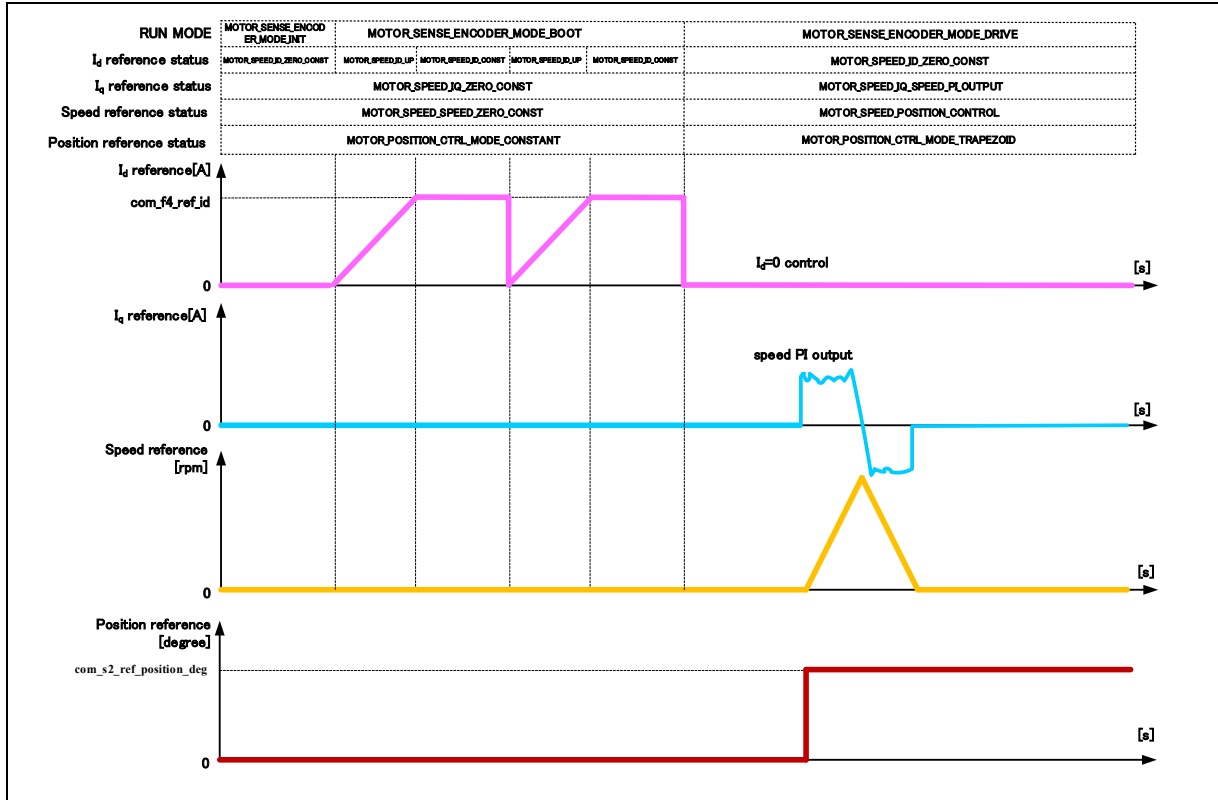

Figure 3-2 Startup Control of Vector Control with encoder Software (at position control)

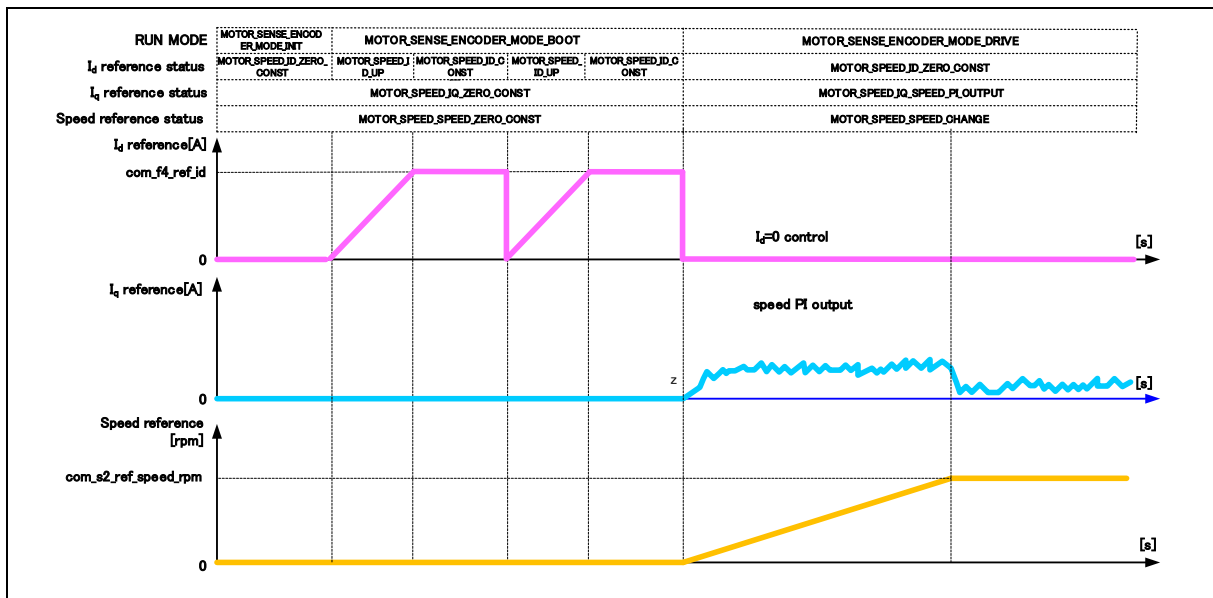

Figure 3-3 Startup Control of Vector Control with encoder Software (at speed control)

3.1.6 Position Profile Generation (Position Profile of Trapezoidal Curve for Speed Command Value)

In vector control software for PMSM with encoder, the position profile generation is used to create command value (input position value). The implementation of command value is each control cycle is used as method of managing acceleration and the maximum speed value with respect to target position value.

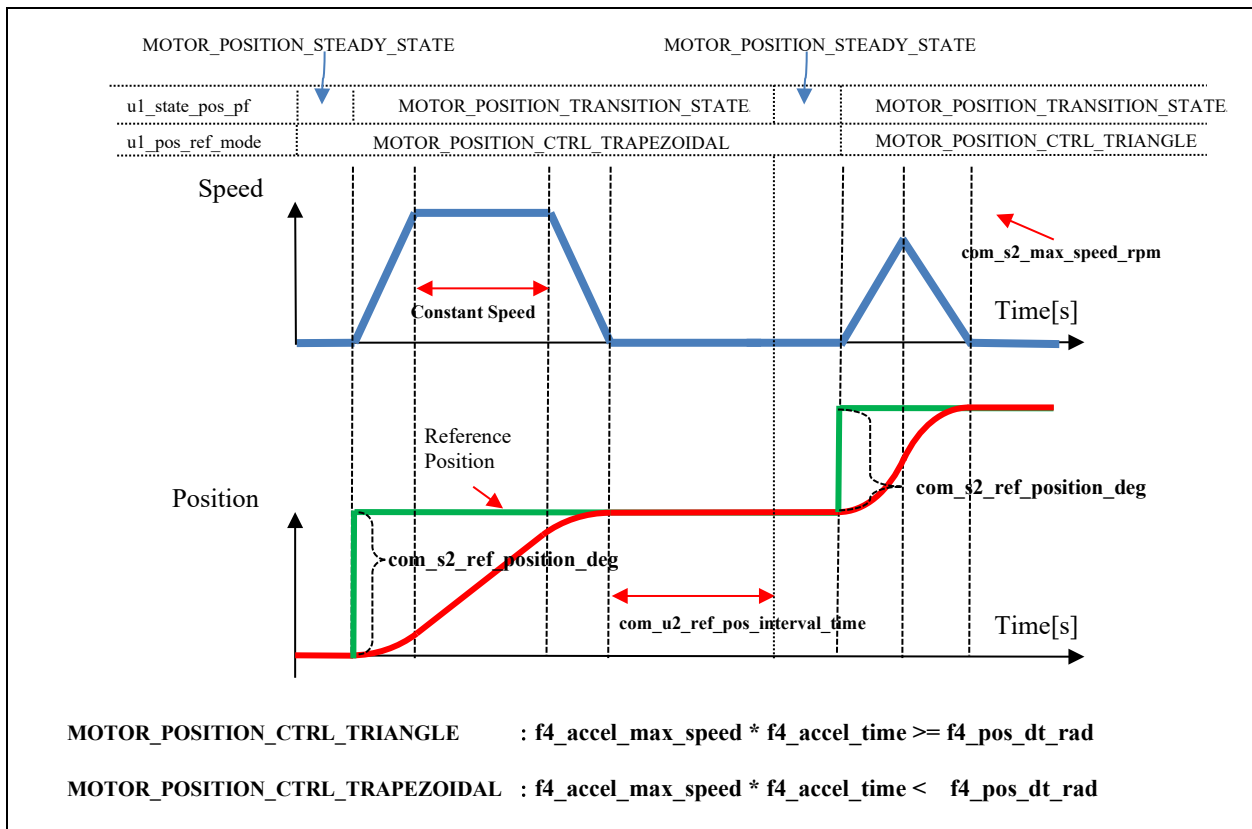

Figure 3-4 Position Profile Generation

Following variables are required to create a command value.

- Acceleration time ($com_f4_accel_time$)
- Maximum speed command value ($com_f4_max_speed_rpm$)
- Position stabilization wait time ($com_u2_ref_pos_interval_time$)

3.1.7 Speed Measurement

3.1.7.1 Speed calculation using encoder at low speed

The sample software calculates the speed from the encoder count (A, B phase signal edge) intervals for higher real-time and slow speed resolution. The speed is calculated from the count between the rising and falling edges of the A and B phases as shown in the figure.

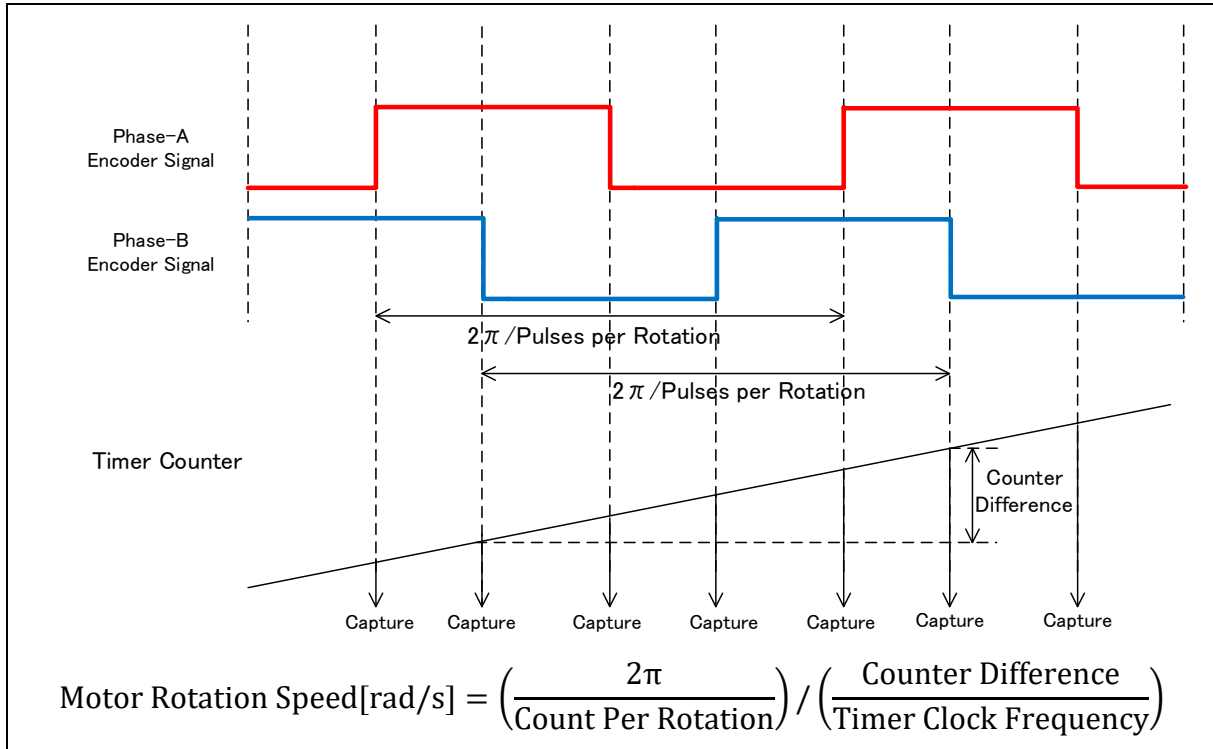

Figure 3-5 Speed calculation using encoder at low speed

3.1.7.2 Speed calculation using encoder at high speed

When using the encoder during high-speed rotation, the speed is calculated from the number of input pulses in the control cycle.

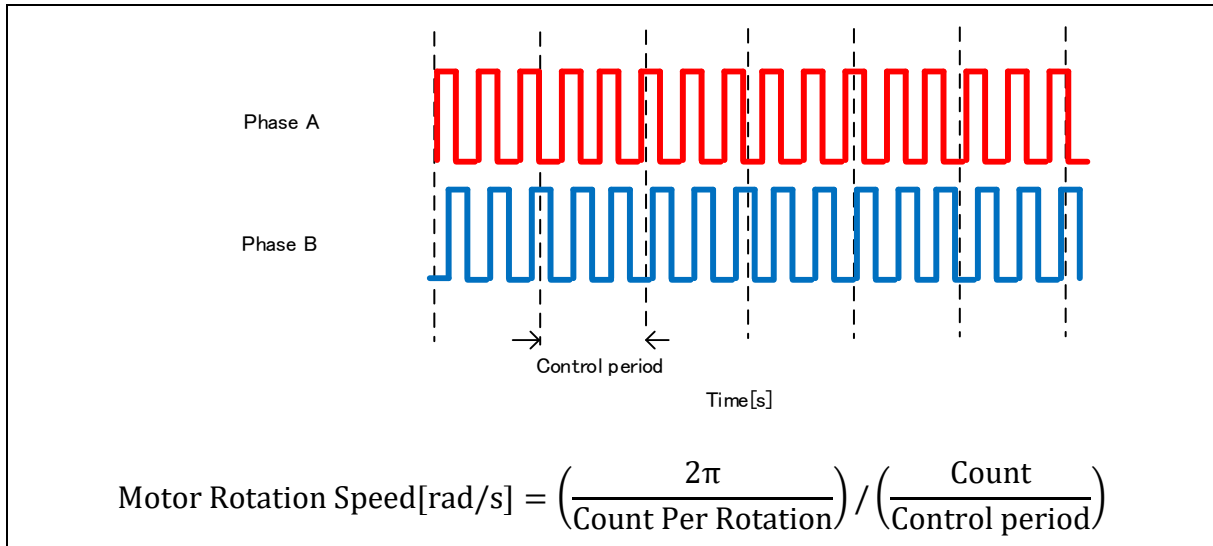

Figure 3-6 Speed calculation using encoder at high speed

3.1.8 System protection function

This control software has the following error status and executes emergency stop functions in case of occurrence of respective errors. Table 3-5 shows each software threshold for the system protection function.

- Over current error

There are two kind of overcurrent protection.

Hardware OCP: When emergency stop signal from the hardware is detected, PWM output ports are automatically set to high impedance output (without software intervention).

Software OCP: U, V, and W phase currents are monitored in over current monitoring cycle. When an over current is detected, the CPU executes emergency stop.

- Over voltage error

The inverter bus voltage is monitored in over voltage monitoring cycle. When an over voltage is detected (when the voltage exceeds the over voltage limit), the CPU performs emergency stop. Here, the over voltage limit is set in consideration of the error of resistance value of the detect circuit. When this error occurs, the CPU performs emergency stop in the side of the motor in which the error occurred.

- Low voltage error

The inverter bus voltage is monitored in low-voltage monitoring cycle. The CPU performs emergency stop when low voltage (when voltage falls below the limit) is detected. Here, the low voltage limit is set in consideration of the error of resistance value of the detect circuit. When this error occurs, the CPU performs emergency stop in the side of the motor in which the error occurred.

- Over speed error

The rotation speed is monitored in rotation speed monitoring cycle. The CPU performs emergency stop when the speed is over the limit. When this error occurs, the CPU performs emergency stop in the side of the motor in which the error occurred.

Table 3-5 Setting Values of the System Protection Function

Error name	Threshold		Monitoring cycle
Over current error	Over current limit [A]	3.82	Current control period
Over voltage error	Over voltage limit [V]	60	Current control period
Low voltage error	Low voltage limit [V]	8	Current control period
Over speed error	Speed limit [rpm]	4500	Current control period

3.1.9 AD triggers

Shows the timing of AD triggers and scan groups.

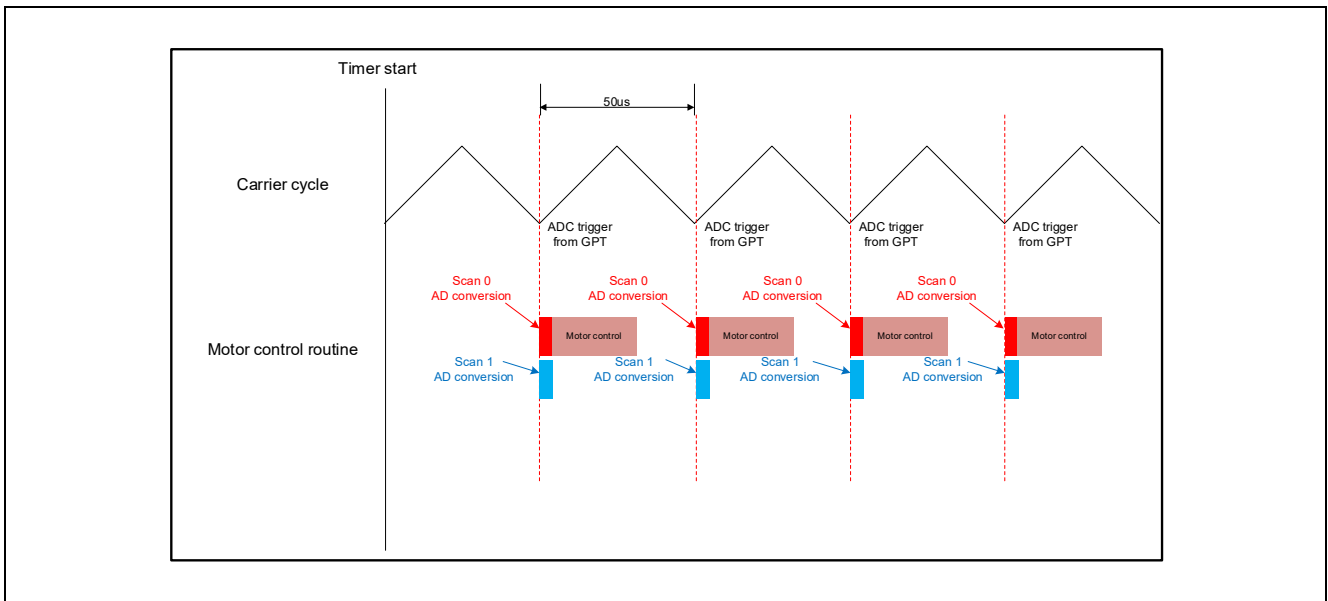

Figure 3-7 AD trigger timing

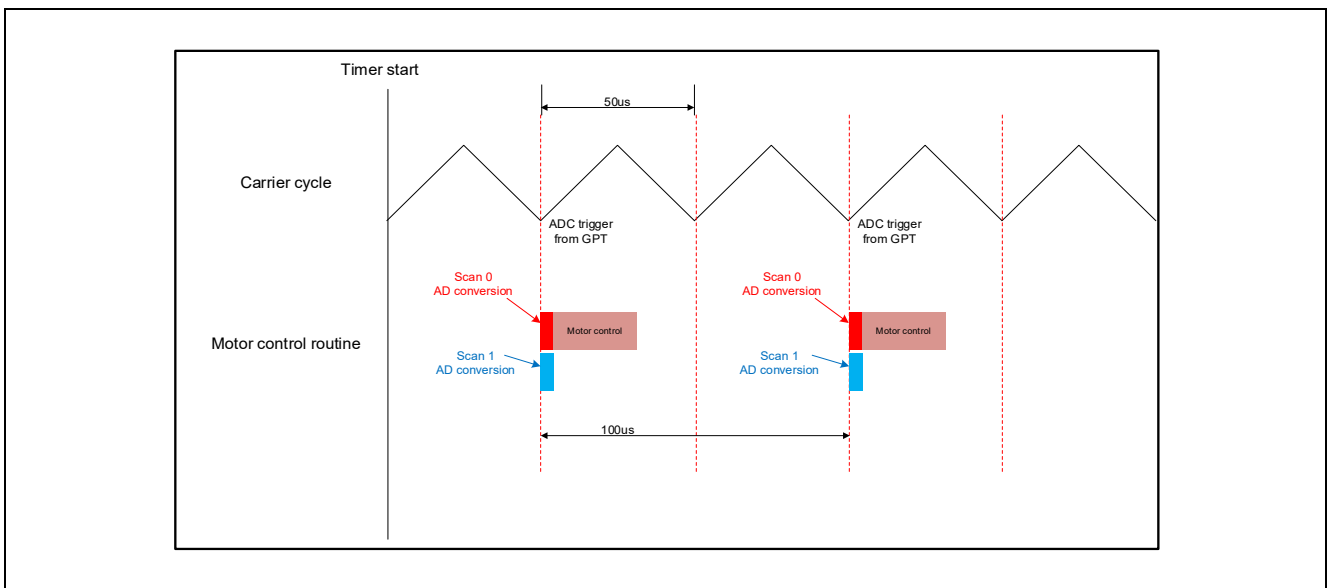

Figure 3-8 AD trigger timing (one time decimation)

3.2 Function specifications of vector control with encoder software

The block diagram of the vector control with encoder is shown below.

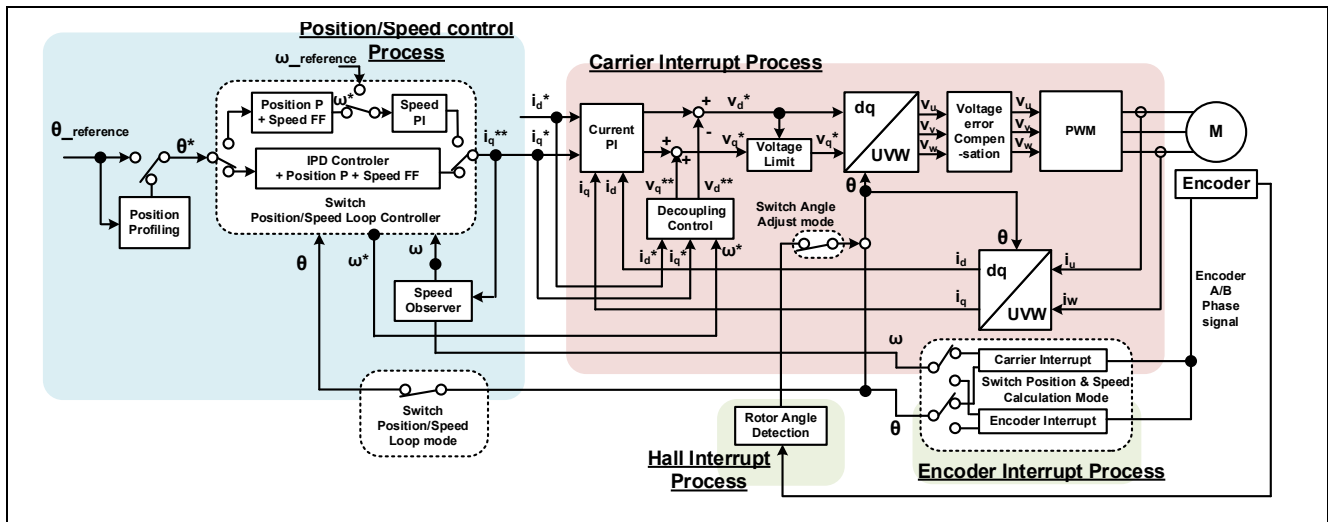

Figure 3-9 Block Diagram of Vector Control with encoder

Table 3-6 List of Functions Executed in Current Control Period Interrupt (1/4)

File name	Function name	Process overview
mtr_main.c	mtr_callback_event Input : (motor_callback_args_t *) p_args / Callback argument Output : None	Encoder control callback function
rm_motor_encoder.c	rm_motor_encoder_current_callback Input : (motor_current_callback_args_t *) p_args / Callback argument Output :None	Set the speed control output to the current control input
	RM_MOTOR_ENCODER_ErrorCheck Input : (motor_ctrl_t * const) p_ctrl / Pointer to control structure. (uint16_t * const) p_error / Pointer to get occurred error Output : fsp_err_t / Execution result	Check the occurrence of Error.
	rm_motor_encoder_copy_speed_current Input : (motor_speed_output_t *) p_output / Pointer to the structure of Speed Control output (motor_current_input_t *) p_input / Pointer to the structure of Current Control input Output :None	Copy speed output data to current input data
rm_motor_driver.c	rm_motor_driver_cyclic Input : (adc_callback_args_t *) p_args / Callback argument Output :None	Motor driver callback function
	rm_motor_driver_current_get Input : (motor_driver_instance_ctrl_t *) p_ctrl / The pointer to the motor driver module instance Output :None	Get A/D converted data (Phase Current & Main Line Voltage)
	RM_MOTOR_DRIVER_FlagCurrentOffsetGet Input : (motor_driver_ctrl_t * const) p_ctrl / Pointer to control structure (uint8_t * const) p_flag_offset / Flag of finish current offset detection Output : fsp_err_t / Execution result	Measure current offset values
	RM_MOTOR_DRIVER_PhaseVoltageSet Input : (motor_driver_ctrl_t * const) p_ctrl / Pointer to control structure (float const) u_voltage / U phase voltage (float const) v_voltage / V phase voltage (float const) w_voltage / W phase voltage Output : fsp_err_t / Execution result	Set Phase Voltage Data to calculate PWM duty.
	rm_motor_driver_modulation Input : (motor_driver_instance_ctrl_t *) p_ctrl / The pointer to the motor driver module instance Output :None	Perform PWM modulation

Table 3-7 List of Functions Executed in Current Control Period Interrupt (2/4)

File name	Function name	Process overview
rm_motor_driver.c	rm_motor_driver_mod_run Input : (motor_driver_instance_ctrl_t *) p_ctrl / Pointer to Motor Driver instance (const float *) p_f4_v_in / Pointer to the 3-phase input voltage (float *) p_f4_duty_out / Where to store the 3-phase output duty cycle Output :None	Calculates duty cycle from input 3-phase voltage (bipolar)
	rm_motor_driver_set_uvw_duty Input : (motor_driver_instance_ctrl_t *) p_ctrl / Pointer to Motor Driver instance (float) f_duty_u / The duty cycle of Phase-U (float) f_duty_v / The duty cycle of Phase-V (float) f_duty_w / The duty cycle of Phase-W Output : fsp_err_t / Execution result	PWM duty setting
	RM_MOTOR_DRIVER_CurrentGet Input : (motor_driver_ctrl_t * const) p_ctrl / Pointer to control structure (motor_driver_current_get_t * const) p_current_get / Pointer to get data structure Output : fsp_err_t / Execution result	Get calculated phase Current, Vdc & Va_max data
rm_motor_current.c	rm_motor_current_cyclic Input : (motor_driver_callback_args_t *) p_args / Callback argument Output :None	Current control cycle operation
	RM_MOTOR_CURRENT_ParameterSet Input : (motor_current_ctrl_t * const) p_ctrl / Pointer to control structure (motor_current_input_t const * const) p_st_input / Pointer to input data structure Output : fsp_err_t / Execution result	Set (Input) Parameter Data.
	RM_MOTOR_CURRENT_CurrentSet Input : (motor_current_ctrl_t * const) p_ctrl / Pointer to control structure (motor_current_input_current_t const * const) p_st_current / Pointer to input current structure (motor_current_input_voltage_t const * const) p_st_voltage / Pointer to input voltage structure Output : fsp_err_t / Execution result	Set d/q-axis Current & Voltage Data.
	RM_MOTOR_CURRENT_CurrentGet Input : (motor_current_ctrl_t * const) p_ctrl / Pointer to control structure (float * const) p_id / Pointer to get d-axis current (float * const) p_iq / Pointer to get q-axis current Output : fsp_err_t / Execution result	Get d/q-axis Current.
	motor_current_transform_uvw_dq_abs Input : (const float) f_angle / rotor angle (const float *) f_uvw / the pointer to the UVW-phase array in [U,V,W] format (float *) f_dq / where to store the [d,q] formatted array on dq coordinates Output :None	Coordinate transform UVW to dq (absolute transform)

Table 3-8 List of Functions Executed in Current Control Period Interrupt (3/4)

File name	Function name	Process overview
rm_motor_current.c	motor_current_angle_cyclic Input : (motor_current_instance_t *) p_instance / The pointer to current control module control instance Output :None	Angle/Speed Process in Cyclic Process of Current Control
	RM_MOTOR_CURRENT_SpeedPhaseSet Input : (motor_current_ctrl_t * const) p_ctrl / Pointer to control structure (float const) speed/ Rotational speed (float const) phase / Rotor phase Output : fsp_err_t / Execution result	Set Current Speed & rotor phase Data.
	RM_MOTOR_CURRENT_CurrentReferenceSet Input : (motor_current_ctrl_t * const) p_ctrl / Pointer to control structure (float const) id_reference / D-axis current Reference (float const) iq_reference / Q-axis current Reference Output : fsp_err_t / Execution result	Set Current Reference Data
	RM_MOTOR_CURRENT_PhaseVoltageGet Input : (motor_current_ctrl_t * const) p_ctrl / Pointer to control structure (motor_current_get_voltage_t * const) p_voltage / Pointer to get Voltages Output : fsp_err_t / Execution result	Gets the set phase voltage.
	motor_current_pi_calculation Input : (motor_current_instance_ctrl_t *) p_ctrl / The pointer to the FOC current control structure Output :None	Calculates the output voltage vector from current vector command and actual current vector
	motor_current_pi_control Input : (motor_current_pi_params_t *) pi_ctrl / The pointer to the PI control structure Output : float / PI control output value	PI control
	motor_current_limit_abs Input : (float) f4_value / Target value (float) f4_limit_value / Limit Output : float / Limited value	Limit with absolute value
	motor_current_decoupling Input : (motor_current_instance_ctrl_t *) p_ctrl / The pointer to the FOC current control instance (float) f_speed_rad / The electrical speed (const motor_current_motor_parameter_t *) p_mtr / The pointer to the motor parameter data structure Output :None	Decoupling control
	motor_current_voltage_limit Input : (motor_current_instance_ctrl_t *) p_ctrl / The pointer to the FOC current control structure Output :None	Limit voltage vector

Table 3-9 List of Functions Executed in Current Control Period Interrupt (4/4)

File name	Function name	Process overview
rm_motor_current.c	<p>motor_current_transform_dq_uvw_abs Input : (const float) f_angle / Rotor angle (const float *) f_uvw / Where to store the [U,V,W] formatted 3-phase quantities array (float *) f_dq / The pointer to the dq-axis value array in [D,Q] format</p> <p>Output :None</p>	Coordinate transform dq to UVW 3-phase (absolute transform)
librm_motor_current.a	<p>rm_motor_voltage_error_compensation_main Input : (motor_currnt_voltage_compensation_t *) st_volt_comp / Voltage error compensation data (float *) p_f4_v_array / Reference voltage (float *) p_f4_i_array / Reference current (float) f4_vdc / Bus voltage</p> <p>Output :None</p>	Voltage error compensation
rm_motor_sense_encoder.c	<p>RM_MOTOR_SENSE_ENCODER_InternalCalculate Input : (motor_angle_ctrl_t * const) p_ctrl / Pointer to control structure Output : fsp_err_t / Execution result</p>	Calculation of angle and speed according to measured encoder signal.
	<p>RM_MOTOR_SENSE_ENCODER_AngleSpeedGet Input : (motor_angle_ctrl_t * const) p_ctrl / Pointer to control structure (float * const) p_angle / Pointer to get angle data (float * const) p_seed / Pointer to get speed data (float * const) p_phase_err / Pointer to get phase error data Output : fsp_err_t / Execution result</p>	Get angle, speed and phase error data about the roter.
r_gpt_three_phase.c	<p>R_GPT_THREE_PHASE_DutyCycleSet Input : (three_phase_ctrl_t * const) p_ctrl / Control block set in @ref three_phase_api_t::open call for this timer (three_phase_duty_cycle_t * const) p_duty_cycle / Duty cycle values for all three timer channels</p> <p>Output : fsp_err_t / Execution result</p>	Sets duty cycle for all three timers.

Table 3-10 List of Functions Executed in Speed Control Interrupt (1/2)

File name	Function name	Process overview
mtr_main.c	mtr_callback_encoder Input : (motor_callback_args_t *) p_args / Callback argument Output :None	Encoder control callback function
	get_vr1 Input :None Output : uint16_t / conversion value	Get VR1 A/D conversion value
rm_motor_current.c	RM_MOTOR_CURRENT_ParameterGet Input : (motor_current_ctrl_t * const) p_ctrl / Pointer to control structure (motor_current_output_t * const) p_st_output / Pointer to output data structure Output : fsp_err_t / Execution result	Get speed control input data from current control
rm_motor_encoder.c	rm_motor_encoder_speed_callback Input : (motor_speed_callback_args_t *) p_args / Callback argument Output :None	Speed control callback function
	rm_motor_encoder_copy_current_speed Input : (motor_current_output_t *) p_output / Pointer to the structure of Current Control output (motor_speed_input_t *) p_input / Pointer to the structure of Speed Control input Output :None	Copy current output data to speed input data
rm_motor_speed.c	rm_motor_speed_cyclic Input : (timer_callback_args_t *) p_args/ Callback argument Output :None	Cyclic process of Speed Control (Call at timer interrupt)
	RM_MOTOR_SPEED_ParameterSet Input : (motor_speed_ctrl_t * const) p_ctrl / Pointer to control structure (motor_speed_input_t const * const) p_st_input / Pointer to structure to input parameters Output : fsp_err_t / Execution result	Set speed Input parameters
	RM_MOTOR_SPEED_SpeedControl Input : (motor_speed_ctrl_t * const) p_ctrl / Pointer to control structure Output : fsp_err_t / Execution result	Calculates the d/q-axis current reference.(Main process of Speed Control)
	rm_motor_speed_set_speed_ref_encoder Input : (motor_speed_instance_ctrl_t *) p_ctrl / The pointer to the FOC data instance Output : float / Speed reference	Updates the speed reference
	rm_motor_speed_set_iq_ref_encoder Input : (motor_speed_instance_ctrl_t *) p_ctrl / The pointer to the ctrl instance Output : float / Iq reference	Updates the q-axis current reference
	rm_motor_speed_set_id_ref_encoder Input : (motor_speed_instance_ctrl_t *) p_ctrl / The pointer to the ctrl instance Output : float / Id reference	Updates the d-axis current reference
	RM_MOTOR_SPEED_ParameterGet Input : (motor_speed_ctrl_t * const) p_ctrl / The pointer to the ctrl instance (motor_speed_output_t * const) p_st_output / Pointer to get speed control parameters Output : fsp_err_t / Execution result	Get speed control output parameters

Table 3-11 List of Functions Executed in Speed Control Interrupt (2/2)

File name	Function name	Process overview
librm_motor_speed.a	rm_motor_speed_first_order_lpf Input : (motor_speed_lpf_t *) p_lpf / First order LPF structure (float) f4_omega / Natural frequency (float) f4_ctrl_period / Control period Output : None	First Order LPF
	rm_motor_speed_fluxwkn_set_vamax Input : (motor_speed_flux_weakening_t *) p_fluxwkn / The pointer to flux weakening structure (float) f4_va_max / maximum magnitude of voltage vector Output :None	Sets the maximum magnitude of voltage vector
	rm_motor_speed_fluxwkn_run Input : (motor_speed_flux_weakening_t *) p_fluxwkn / The pointer to flux weakening structure (float) f4_speed_rad / The electrical speed of motor (const float *) p_f4_idq / The pointer to the measured current vector in format d/q (float *) p_f4_idq_ref / The pointer to the reference current vector in format d/q Output :None	Executes the flux-weakening module

3.3 Contents of control

3.3.1 Configuration Options

The configuration options of the vector control with encoder module for motor can be configured using the RA Configurator. The changed options are automatically reflected to the `hal_data.c` when generating code. The option names and setting values are listed in the Table 3-12 shown as follows.

Table 3-12 Configuration Options for encoder module

Configuration Options (rm_motor_encoder.h)	
Options	Description
Limit of over current (A)	When a phase current exceeds this value, PWM output ports are set to off.
Limit of over voltage (V)	When an inverter voltage exceeds this value, PWM output ports are set to off.
Limit of over speed (rpm)	When a rotation speed exceeds this value, PWM output ports are set to off.
Limit of low voltage (V)	When an inverter voltage becomes below this value, PWM output ports are set to off.

Table 3-13 Configuration Options Initial Value(rm_motor_encoder.h)

Options	RA6T2	RA4T1	RA6T3	RA8T1
Limit of over current (A)	1.8	1.8	1.8	1.8
Limit of over voltage (V)	60.0	60.0	60.0	60.0
Limit of over speed (rpm)	4500.0	4500.0	4500.0	4500.0
Limit of low voltage (V)	8.0	8.0	8.0	8.0

3.3.2 Configuration Options for included modules

The vector control with encoder module for motor includes below modules.

- Current Module
- Speed Module
- Position Module
- Angle Module
- Driver Module

And also these included modules have each configuration parameters as same as the vector control with encoder module. The option names and setting values are listed in the tables shown as follows.

Table 3-14 Configuration Options for Current Control

Configuration Options (rm_motor_current.h)	
Options	Description
General Shunt type	Selects how many shunt resistances to use current detection.
General Current control decimation	Counts of decimation about carrier interrupt
General PWM carrier frequency (kHz)	PWM carrier frequency [kHz]
General Input voltage (V)	Input voltage [V]
General Sample delay compensation	Selects whether to “enable” or “disable” sample delay compensation
General Period magnification value	Period magnification value for sampling delay compensation.
General Voltage error compensation	Selects whether to “enable” or “disable” voltage error compensation.
General Voltage error compensation table of voltage 1	Table of voltage error compensation about voltage #1
General Voltage error compensation table of voltage 2	Table of voltage error compensation about voltage #2
General Voltage error compensation table of voltage 3	Table of voltage error compensation about voltage #3
General Voltage error compensation table of voltage 4	Table of voltage error compensation about voltage #4
General Voltage error compensation table of voltage 5	Table of voltage error compensation about voltage #5
General Voltage error compensation table of current 1	Table of voltage error compensation about current #1
General Voltage error compensation table of current 2	Table of voltage error compensation about current #2
General Voltage error compensation table of current 3	Table of voltage error compensation about current #3
General Voltage error compensation table of current 4	Table of voltage error compensation about current #4
General Voltage error compensation table of current 5	Table of voltage error compensation about current #5
Design Parameter Current PI loop omega	Current PI control omega parameter [Hz].
Design Parameter Current PI loop zeta	Current PI control zeta parameter.
Motor Parameter Pole pairs	Pole pairs of target motor.
Motor Parameter Resistance (ohm)	Resistance of motor [ohm].
Motor Parameter Inductance of d-axis (H)	D-axis inductance [H].
Motor Parameter Inductance of q-axis (H)	Q-axis inductance [H].
Motor Parameter Permanent magnetic flux (Wb)	Magnetic flux [Wb].
Motor Parameter Rotor inertia (kgm ²)	Rotor inertia [kgm ²].

Table 3-15 Configuration Options Initial Value(rm_motor_current.h)

Options	RA6T2	RA4T1	RA6T3	RA8T1
General Shunt type	2shunt	2shunt	2shunt	2shunt
General Current control decimation	0	1	0	0
General PWM carrier frequency (kHz)	20.0	20.0	20.0	20.0
General Input voltage (V)	24.0	24.0	24.0	24.0
General Sample delay compensation	Enable	Enable	Enable	Enable
General Period magnification value	1.5	1.5	1.5	1.5
General Voltage error compensation	Enable	Enable	Enable	Enable
General Voltage error compensation table of voltage 1	0.477	0.477	0.477	0.477
General Voltage error compensation table of voltage 2	0.742	0.742	0.742	0.742
General Voltage error compensation table of voltage 3	0.892	0.892	0.892	0.892
General Voltage error compensation table of voltage 4	0.979	0.979	0.979	0.979
General Voltage error compensation table of voltage 5	1.009	1.009	1.009	1.009
General Voltage error compensation table of current 1	0.021	0.021	0.021	0.021
General Voltage error compensation table of current 2	0.034	0.034	0.034	0.034
General Voltage error compensation table of current 3	0.064	0.064	0.064	0.064
General Voltage error compensation table of current 4	0.158	0.158	0.158	0.158
General Voltage error compensation table of current 5	0.400	0.400	0.400	0.400
Design Parameter Current PI loop omega	300.0	300.0	300.0	300.0
Design Parameter Current PI loop zeta	1.0	1.0	1.0	1.0
Motor Parameter Pole pairs	4	4	4	4
Motor Parameter Resistance (ohm)	0.84	0.84	0.84	0.84
Motor Parameter Inductance of d-axis (H)	0.0011	0.0011	0.0011	0.0011
Motor Parameter Inductance of q-axis (H)	0.0011	0.0011	0.0011	0.0011
Motor Parameter Permanent magnetic flux (Wb)	0.00623	0.00623	0.00623	0.00623
Motor Parameter Rotor inertia (kgm ²)	0.0000041	0.0000041	0.0000041	0.0000041

Table 3-16 Configuration Options for Speed Control

Configuration Options (rm_motor_speed.h)	
Options	Description
Common Position support	Support position control
General Speed control period (sec)	The period of speed control process [sec].
General Step of speed climbing (rpm)	The step of speed fluctuation [rpm]. Program controls speed by this step at acceleration and deceleration.
General Maximum rotational speed (rpm)	Maximum rotational speed [rpm]
General Speed LPF omega	Speed LPF parameter omega [Hz].
General Limit of q-axis current (A)	Limit of q-axis current [A].
General Step of speed feedback at open-loop	Rate of reference speed for feedback speed limiter at Open-Loop.
General Natural frequency	Natural frequency for disturbance speed observer.
General Open-loop damping	Select enable/disable of damping control at Open-Loop.
General Flux weakening	Select enable/disable of flux weakening control at high speed.
General Torque compensation for sensorless transition	Select enable/disable of soft switching at the transition from Open-Loop to PI control.
General Speed observer	Select enable/disable of speed observer process
General Selection of speed observer	Select the method of speed observer
General Control method	Select the position control method.
Open-Loop Step of d-axis current climbing	The d-axis current reference ramping up rate [A/msec].
Open-Loop Step of d-axis current descending	The d-axis current reference ramping down rate [A/msec].
Open-Loop Step of q-axis current descending ratio	The q-axis current reference ramping down proportion to reference before open-loop [A/msec].
Open-Loop Reference of d-axis current	The d-axis current reference in open-loop drive [A].
Open-Loop Threshold of speed control descending	The speed threshold [rad/s] to ramp down the d-axis current [rpm].
Open-Loop Threshold of speed control climbing	The speed threshold [rad/s] to ramp up the d-axis current [rpm].
Open-Loop Period between open-loop to BEMF (sec)	Time to switch open-loop to sensor-less [sec].
Open-Loop Phase error(degree) to decide sensor-less switch timing	Phase error to decide sensor-less switch timing (electrical angle) [degree].
Design parameter Speed PI loop omega	Speed PI Control parameter omega.
Design parameter Speed PI loop zeta	Speed PI Control parameter zeta.
Design parameter Estimated d-axis HPF omega	Natural frequency [Hz] for HPF in open-loop damping gain design.
Design parameter Open-loop damping zeta	Damping ratio for open-loop damping gain design.
Design parameter Cutoff frequency of phase error LPF	The cut-off frequency [Hz] of phase error LPF gain design.
Design parameter Speed observer omega	Speed observer omega.
Design parameter Speed observer zeta	Speed observer zeta.
Motor Parameter Pole pairs	Pole pairs of target motor.
Motor Parameter Resistance (ohm)	Resistance of motor [ohm].
Motor Parameter Inductance of d-axis (H)	D-axis inductance [H].
Motor Parameter Inductance of q-axis (H)	Q-axis inductance [H].
Motor Parameter Permanent magnetic flux (Wb)	Magnetic flux [Wb].
Motor Parameter Rotor inertia (kgm ²)	Rotor inertia [kgm ²].

Table 3-17 Configuration Options Initial Value(rm_motor_speed.h)

Options	RA6T2	RA4T1	RA6T3	RA8T1
Common Position support	Enabled	Enabled	Enabled	Enabled
General Speed control period (sec)	0.0005	0.001	0.0005	0.0005
General Step of speed climbing (rpm)	0.5	1.0	0.5	0.5
General Maximum rotational speed (rpm)	4000.0	4000.0	4000.0	4000.0
General Speed LPF omega	250.0	250.0	250.0	10.0
General Limit of q-axis current (A)	1.8	1.8	1.8	1.8
General Step of speed feedback at open-loop	0.2	0.2	0.2	0.2
General Natural frequency	100.0	100.0	100.0	100.0
General Open-loop damping	Disable	Disable	Disable	Disable
General Flux weakening	Disable	Disable	Disable	Disable
General Torque compensation for sensorless transition	Disable	Disable	Disable	Disable
General Speed observer	Enable	Enable	Enable	Enable
General Selection of speed observer	Disturbance	Disturbance	Disturbance	Disturbance
General Control method	IPD	IPD	IPD	IPD
Open-Loop Step of d-axis current climbing	1.0	2.0	1.0	1.0
Open-Loop Step of d-axis current descending	0.3	0.3	0.3	0.3
Open-Loop Step of q-axis current descending ratio	1.0	1.0	1.0	1.0
Open-Loop Reference of d-axis current	1.0	1.0	1.0	1.0
Open-Loop Threshold of speed control descending	600	600	600	600
Open-Loop Threshold of speed control climbing	500	500	500	500
Open-Loop Period between open-loop to BEMF (sec)	0.025	0.025	0.025	0.025
Open-Loop Phase error(degree) to decide sensor-less switch timing	10	10	10	10
Design parameter Speed PI loop omega	12.0	12.0	12.0	30.0
Design parameter Speed PI loop zeta	1.0	1.0	1.0	1.0
Design parameter Estimated d-axis HPF omega	2.5	2.5	2.5	2.5
Design parameter Open-loop damping zeta	-	-	-	-
Design parameter Cutoff frequency of phase error LPF	10.0	10.0	10.0	10.0
Design parameter Speed observer omega	100.0	100.0	100.0	200.0
Design parameter Speed observer zeta	1.0	1.0	1.0	1.0
Motor Parameter Pole pairs	4	4	4	4
Motor Parameter Resistance (ohm)	0.84	0.84	0.84	0.84
Motor Parameter Inductance of d-axis (H)	0.0011	0.0011	0.0011	0.0011
Motor Parameter Inductance of q-axis (H)	0.0011	0.0011	0.0011	0.0011
Motor Parameter Permanent magnetic flux (Wb)	0.00623	0.00623	0.00623	0.00623
Motor Parameter Rotor inertia (kgm ²)	0.0000041	0.0000041	0.0000041	0.0000041

Table 3-18 Configuration Options for Position control module

Configuration Options (rm_motor_position.h)	
Options	Description
General Position dead band	Position dead band
General Position band limit	Zero position error range
General Speed feedforward ratio	Speed feedforward ratio
General Encoder counts per one rotation	Encoder count per revolution
General Position omega	Position control omega parameter [Hz].
General Period of speed control (sec)	Speed control execution cycle
IPD IPD LPF	IPD LPF process enable or disable
IPD Position Kp ratio	Position Kp ratio.
IPD Position feedforward ratio	Position feedforward ratio.
IPD Speed K ratio	Speed K ratio
IPD Error Limit #1	Error limitation #1
IPD Error limit #2	Error limitation #2
IPD LPF omega	LPF omega.
IPD LPF zeta	LPF zeta.
Position Profiling Interval time	Position response steady-state waiting time
Position Profiling Accel time	Acceleration time
Position Profiling Maximum accel time	Maximum acceleration time calculation parameter
Position Profiling Acceleration maximum speed	Position profile maximum rotation speed
Position Profiling Update step of timer	Position profile update cycle
Motor Parameter Pole pairs	Pole pairs of target motor.
Motor Parameter Resistance (ohm)	Resistance of motor [ohm].
Motor Parameter Inductance of d-axis (H)	D-axis inductance [H].
Motor Parameter Inductance of q-axis (H)	Q-axis inductance [H].
Motor Parameter Permanent magnetic flux (Wb)	Magnetic flux [Wb].
Motor Parameter Rotor inertia (kgm ²)	Rotor inertia [kgm ²].

Table 3-19 Configuration Options Initial Value(rm_motor_position.h)

Options	RA6T2	RA4T1	RA6T3	RA8T1
General Position dead band	1	1	1	1
General Position band limit	3	3	3	3
General Speed feedforward ratio	0.8	0.8	0.8	0.8
General Encoder counts per one rotation	4000.0	4000.0	4000.0	4000.0
General Position omega	10.0	4.0	4.0	10.0
General Period of speed control (sec)	0.0005	0.0005	0.0005	0.0005
IPD IPD LPF	Disable	Disable	Disable	Disable
IPD Position Kp ratio	0.3	0.3	0.3	0.3
IPD Position feedforward ratio	0.0	0.9	0.9	0.0
IPD Speed K ratio	2.0	2.5	2.5	2.0
IPD Error Limit #1	10.0	10.0	10.0	10.0
IPD Error limit #2	0.2	0.2	0.2	0.2
IPD LPF omega	500.0	200.0	200.0	500.0
IPD LPF zeta	1.0	1.0	1.0	1.0
Position Profiling Interval time	400	800	800	400
Position Profiling Accel time	0.3	0.3	0.3	0.3
Position Profiling Maximum accel time	11077.904	11077.904	11077.904	11077.904
Position Profiling Acceleration maximum speed	4000.0	4000.0	4000.0	4000.0
Position Profiling Update step of timer	0.0005	0.001	0.0005	0.0005
Motor Parameter Pole pairs	4	4	4	4
Motor Parameter Resistance (ohm)	0.84	0.84	0.84	0.84
Motor Parameter Inductance of d-axis (H)	0.0011	0.0011	0.0011	0.0011
Motor Parameter Inductance of q-axis (H)	0.0011	0.0011	0.0011	0.0011
Motor Parameter Permanent magnetic flux (Wb)	0.00623	0.00623	0.00623	0.00623
Motor Parameter Rotor inertia (kgm ²)	0.0000041	0.0000041	0.0000041	0.0000041

Table 3-20 Configuration Options for Encoder sensing module

Configuration Options (rm_motor_sense_encoder.h)	
Options	Description
Motor Parameter Pole pairs	Pole pairs of target motor.
Motor Parameter Resistance (ohm)	Resistance of motor [ohm].
Motor Parameter Inductance of d-axis (H)	D-axis inductance [H].
Motor Parameter Inductance of q-axis (H)	Q-axis inductance [H].
Motor Parameter Permanent magnetic flux (Wb)	Magnetic flux [Wb].
Motor Parameter Rotor inertia (kgm ²)	Rotor inertia [kgm ²].
Control type	Selection of speed or position control
Period of current control (kHz)	Period of current control [kHz]
Period of speed control (sec)	Period of speed control [sec]
PWM carrier frequency (kHz)	PWM carrier frequency [kHz]
Decimation of interrupt	Decimation counts of interrupt
Counts per rotation	Encoder counts per one rotation
Counts for angle adjust	Counts for adjustment of angle initialization
Zero speed counts	Encoder counts to judge zero speed
Occupancy time	Current control occupancy time
Carrier time	Current control time
Process time	Encoder count capture processing time
High speed change margin (rpm)	Margin rotational speed to change high speed mode [rpm]
LPF parameter for highspped filter	LPF parameter for highspped filter
Counts to change speed	Speed calculation mode change count

Table 3-21 Configuration Options Initial Value(rm_motor_sense_encoder.h)

Options	RA6T2	RA4T1	RA6T3	RA8T1
Motor Parameter Pole pairs	4	4	4	4
Motor Parameter Resistance (ohm)	0.84	0.84	0.84	0.84
Motor Parameter Inductance of d-axis (H)	0.0011	0.0011	0.0011	0.0011
Motor Parameter Inductance of q-axis (H)	0.0011	0.0011	0.0011	0.0011
Motor Parameter Permanent magnetic flux (Wb)	0.00623	0.00623	0.00623	0.00623
Motor Parameter Rotor inertia (kgm ²)	0.0000041	0.0000041	0.0000041	0.0000041
Control type	Position	Position	Position	Position
Period of current control (kHz)	20.0	10.0	20.0	20.0
Period of speed control (sec)	0.0005	0.001	0.0005	0.0005
PWM carrier frequency (kHz)	20.0	20.0	20.0	20.0
Decimation of interrupt	0	1	0	0
Counts per rotation	4000	4000	4000	4000
Counts for angle adjust	512	512	512	512
Zero speed counts	20000000	20000000	20000000	20000000
Occupancy time	0.8	0.6	0.6	0.4
Carrier time	0.00004	0.000063	0.000041	0.00002
Process time	0.000004	0.0000043	0.0000012	0.000002
High speed change margin (rpm)	150	150	150	150
LPF parameter for highspped filter	0.1	0.1	0.1	0.1
Counts to change speed	8	8	8	8

Table 3-22 Configuration Options for Driver Access

Configuration Options (rm_motor_driver.h)	
Options	Description
Common ADC_B Support	ADC_B module support
Common Shared ADC support	Selection of using shared ADC module
Common Supported Motor Number	Number of driven motors
General Shunt type	Current detection method selection
General Modulation method	Selection of the method of modulation
General PWM output port UP	Port setting of U phase upper arm
General PWM output port UN	Port setting of U phase lower arm
General PWM output port VP	Port setting of V phase upper arm
General PWM output port VN	Port setting of V phase lower arm
General PWM output port WP	Port setting of W phase upper arm
General PWM output port WN	Port setting of W phase lower arm
General PWM Timer Frequency (MHz)	PWM Timer Clock Frequency [MHz]
General PWM Carrier Period (Microseconds)	PWM Carrier Period [Micro seconds]
General Dead Time (Raw Counts)	PWM Dead time [raw counts]
General Current Range (A)	Measurement Range of Electric current [A]
General Voltage Range (V)	Measurement Range of Inverter Voltage [V]
General Counts for current offset measurement	Counts of measurement the offset of A/D Conversion at electric current input.
General A/D conversion channel for U Phase current	A/D channel for U-phase current
General A/D conversion channel for W Phase current	A/D channel for W-phase current
General A/D conversion channel for Main Line Voltage	A/D channel for main line voltage
General A/D conversion channel for V Phase current	A/D channel for V-phase current
General A/D conversion channel for sin signal	A/D channel for sin signal
General A/D conversion channel for cos signal	A/D channel for cos signal
General Using ADC scan group	Set ADC scan group according to ADC module setting.
General A/D conversion unit for U Phase current	Select the A/D conversion module for U phase current
General A/D conversion unit for W Phase current	Select the A/D conversion module for W phase current
General A/D conversion unit for main line voltage	Select the A/D conversion module for main line voltage
General A/D conversion unit for V Phase current	Select the A/D conversion module for V phase current
General A/D conversion unit for sin signal	Select the A/D conversion module for sin signal
General A/D conversion unit for cos signal	Select the A/D conversion module for cos signal
General ADC interrupt module	Select from which module ADC interrupt happens
General Adjustment value to current A/D	Current A/D timing adjustment (for 1shunt)
General Minimum difference of PWM duty	Minimum difference of PWM duty setting (for 1shunt)
General Adjustment delay of A/D conversion	A/D conversion delay timing adjustment (for 1shunt)
General 1shunt interrupt phase	Which phase is used to detect 1shunt current (for 1shunt)
General Input Voltage (V)	Range of input for main line voltage
General Resolution of A/D conversion	Resolution of A/D conversion Please set same value with ADC module setting.
General Offset of A/D conversion for current	Offset level of A/D conversion input for current Please set according to the circuit.
General Conversion level of A/D conversion for voltage	Conversion level of A/D conversion for voltage Please set when the CPU main voltage is different.
General GTIOCA stop level	Output level of upper arm at stop status
General GTIOCB stop level	Output level of lower arm at stop status

Modulation Maximum duty	Maximum duty of PWM Maximum duty except dead time.
---------------------------	---

Table 3-23 Configuration Options Initial Value(rm_motor_driver.h)

Options	RA6T2	RA4T1	RA6T3	RA8T1
Common ADC_B Support	Enabled	-	-	-
Common Shared ADC support	Disabled	Disabled	Disabled	Disabled
Common Supported Motor Number	1	1	1	1
General Shunt type	2shunt	2shunt	2shunt	2shunt
General Modulation method	SVPWM	SVPWM	SVPWM	SVPWM
General PWM output port UP	BSP_IO_PORT _11_PIN_04	BSP_IO_PORT _04_PIN_09	BSP_IO_PORT _04_PIN_09	BSP_IO_PORT _01_PIN_15
General PWM output port UN	BSP_IO_PORT _11_PIN_05	BSP_IO_PORT _04_PIN_08	BSP_IO_PORT _04_PIN_08	BSP_IO_PORT _06_PIN_09
General PWM output port VP	BSP_IO_PORT _11_PIN_06	BSP_IO_PORT _01_PIN_03	BSP_IO_PORT _01_PIN_03	BSP_IO_PORT _01_PIN_13
General PWM output port VN	BSP_IO_PORT _11_PIN_07	BSP_IO_PORT _01_PIN_02	BSP_IO_PORT _01_PIN_02	BSP_IO_PORT _01_PIN_14
General PWM output port WP	BSP_IO_PORT _11_PIN_08	BSP_IO_PORT _01_PIN_11	BSP_IO_PORT _01_PIN_11	BSP_IO_PORT _03_PIN_00
General PWM output port WN	BSP_IO_PORT _11_PIN_09	BSP_IO_PORT _01_PIN_12	BSP_IO_PORT _01_PIN_12	BSP_IO_PORT _01_PIN_12
General PWM Timer Frequency (MHz)	120.0	100.0	100.0	120.0
General PWM Carrier Period (Microseconds)	50.0	50.0	50.0	50.0
General Dead Time (Raw Counts)	240	200	200	240
General Current Range (A)	16.5	16.5	16.5	16.5
General Voltage Range (V)	73.26	73.26	73.26	73.26
General Counts for current offset measurement	500	500	500	500
General A/D conversion channel for U Phase current	4	0	0	0
General A/D conversion channel for W Phase current	0	2	2	2
General A/D conversion channel for Main Line Voltage	6	4	4	8
General A/D conversion channel for V Phase current	-	-	-	-
General A/D conversion channel for sin signal	-	-	-	-
General A/D conversion channel for cos signal	-	-	-	-
General Using ADC scan group	0	-	-	-

Table 3-24 Configuration Options Initial Value(rm_motor_driver.h)

Options	RA6T2	RA4T1	RA6T3	RA8T1
General A/D conversion unit for U Phase current	-	0	0	0
General A/D conversion unit for W Phase current	-	0	0	0
General A/D conversion unit for main line voltage	-	0	0	0
General A/D conversion unit for V Phase current	-	-	-	-
General A/D conversion unit for sin signal	-	-	-	-
General A/D conversion unit for cos signal	-	-	-	-
General ADC interrupt module	-	1st	1st	1st
General Adjustment value to current A/D	-	-	-	-
General Minimum difference of PWM duty	-	-	-	-
General Adjustment delay of A/D conversion	-	-	-	-
General 1shunt interrupt phase	-	-	-	-
General Input Voltage (V)	24.0	24.0	24.0	24.0
General Resolution of A/D conversion	0xFFF	0xFFF	0xFFF	0xFFF
General Offset of A/D conversion for current	0x7FF	0x7FF	0x7FF	0x7FF
General Conversion level of A/D conversion for voltage	1.0	1.0	1.0	1.0
General GTIOCA stop level	Pin Level Low	Pin Level Low	Pin Level Low	Pin Level Low
General GTIOCB stop level	Pin Level High	Pin Level High	Pin Level High	Pin Level High
Modulation Maximum duty	0.9375	0.9375	0.9375	0.9375

3.4 Control flowcharts

3.4.1 Main process

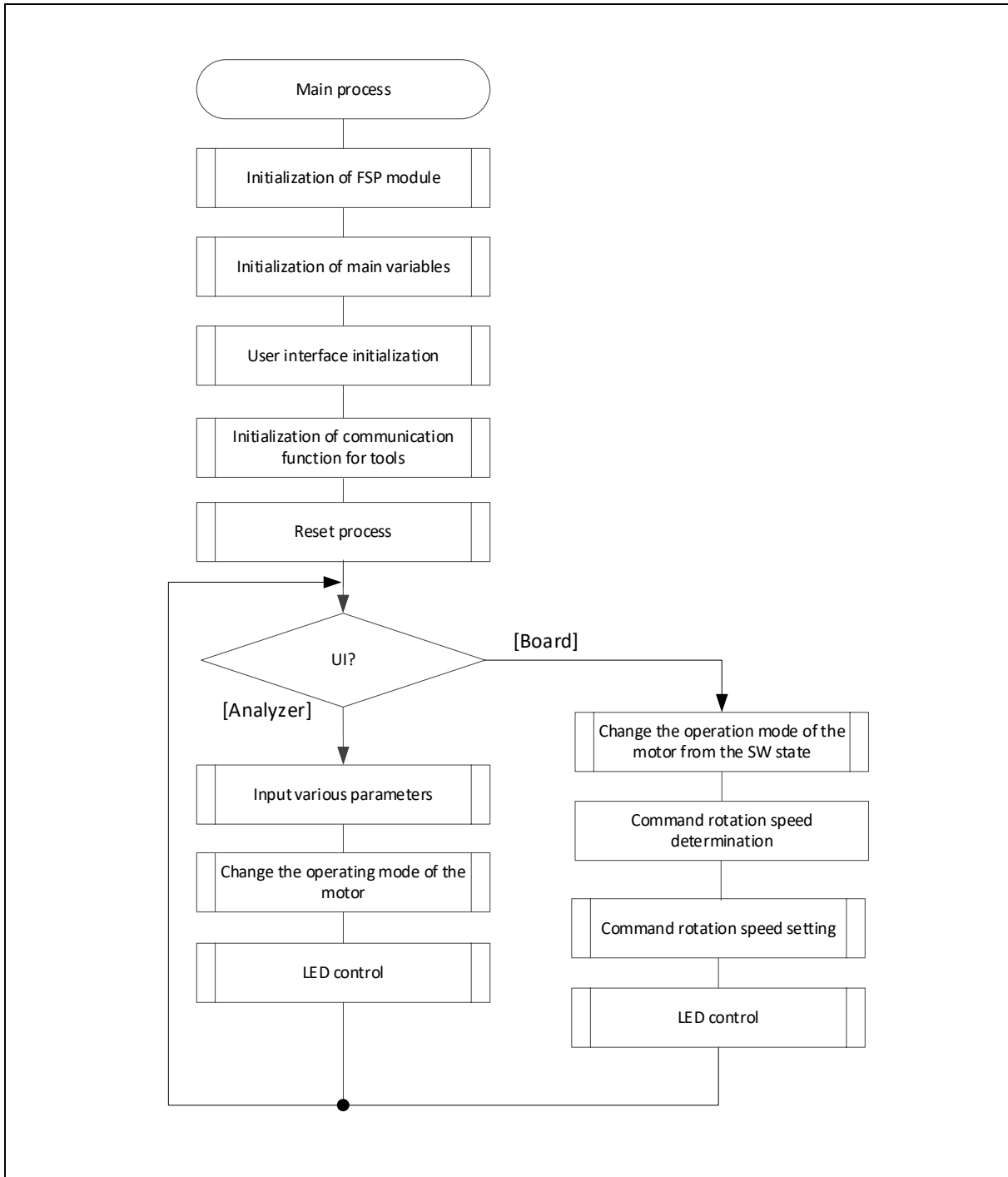

Figure 3-10 Main Process Flowchart

3.4.2 Current Control Period Interrupt (Carrier synchronized Interrupt) Process

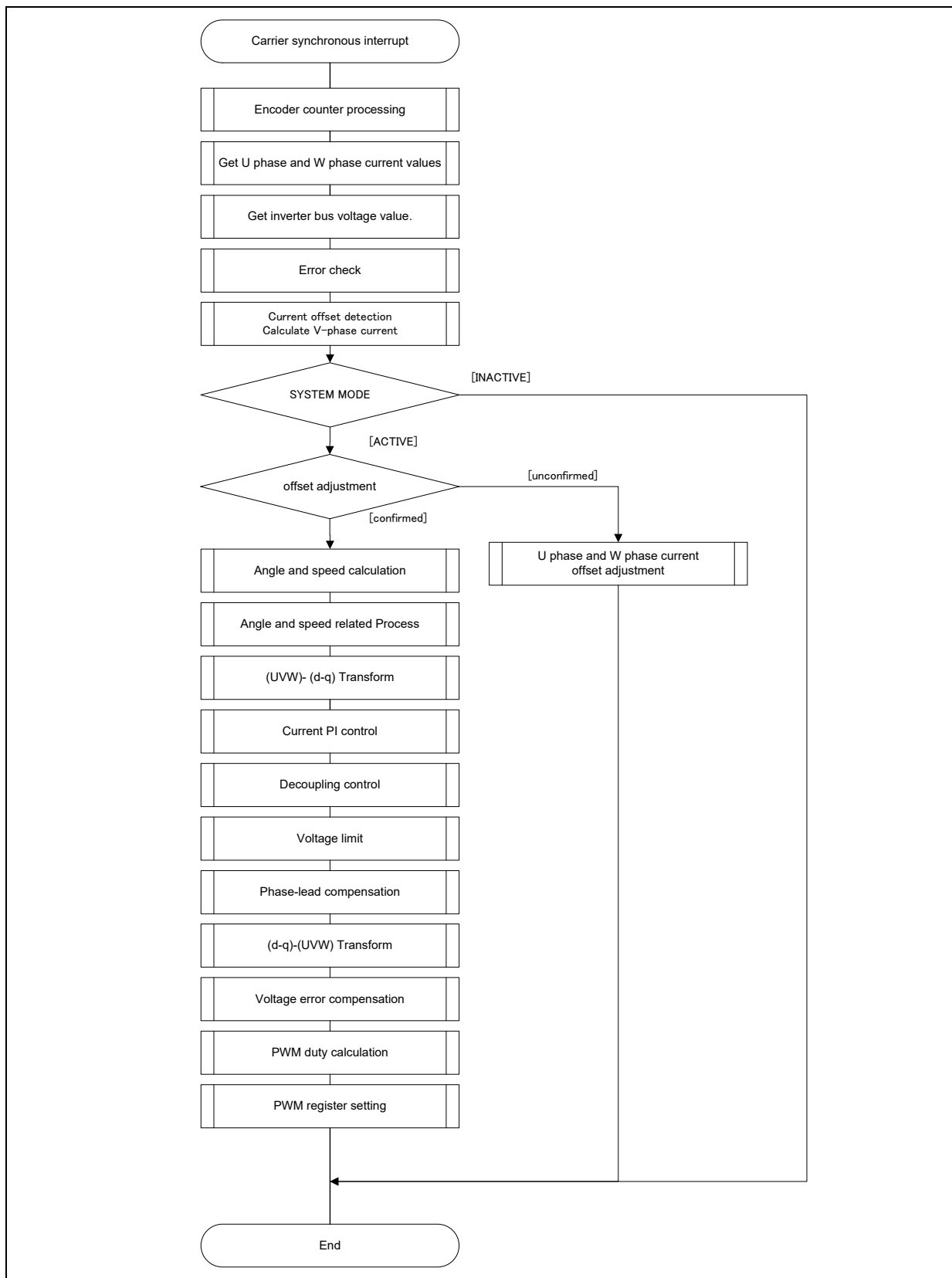

Figure 3-11 Current Control Period Interrupt (Carrier Interrupt) Process Flowchart

3.4.3 Speed Control Period Interrupt Process

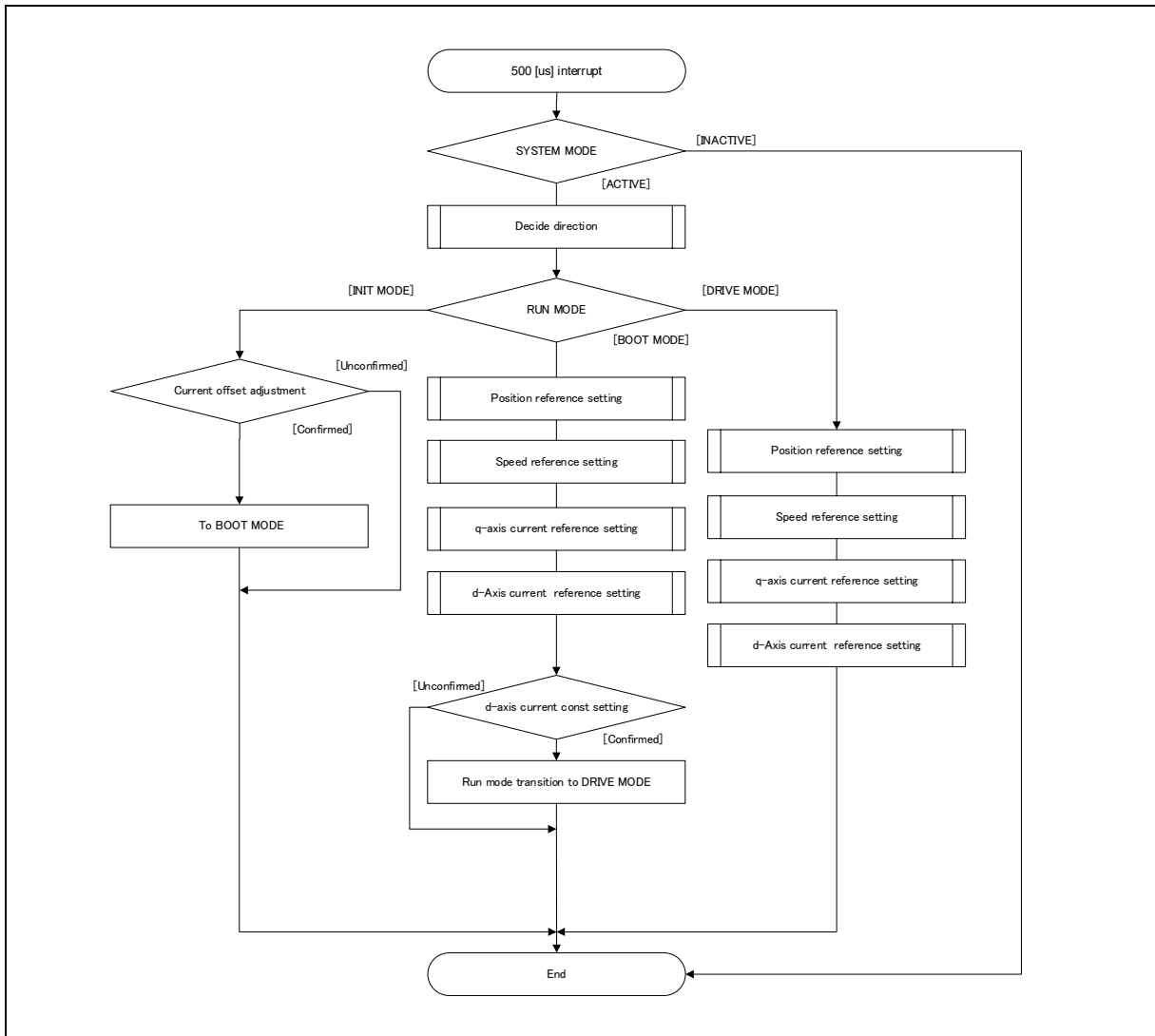

Figure 3-12 Speed Control Period Interrupt Process Flowchart

Flux weakening control can be activated by FSP setting.

3.4.4 Over Current Detection Interrupt Process

The overcurrent detection interrupt is an interrupt that occurs when an external overcurrent detection signal is input. The PWM output terminal are put in the high impedance state. Therefore, at the start of execution of this interrupt processing, the PWM output terminal is already in the high impedance state and the output to the motor had been stopped.

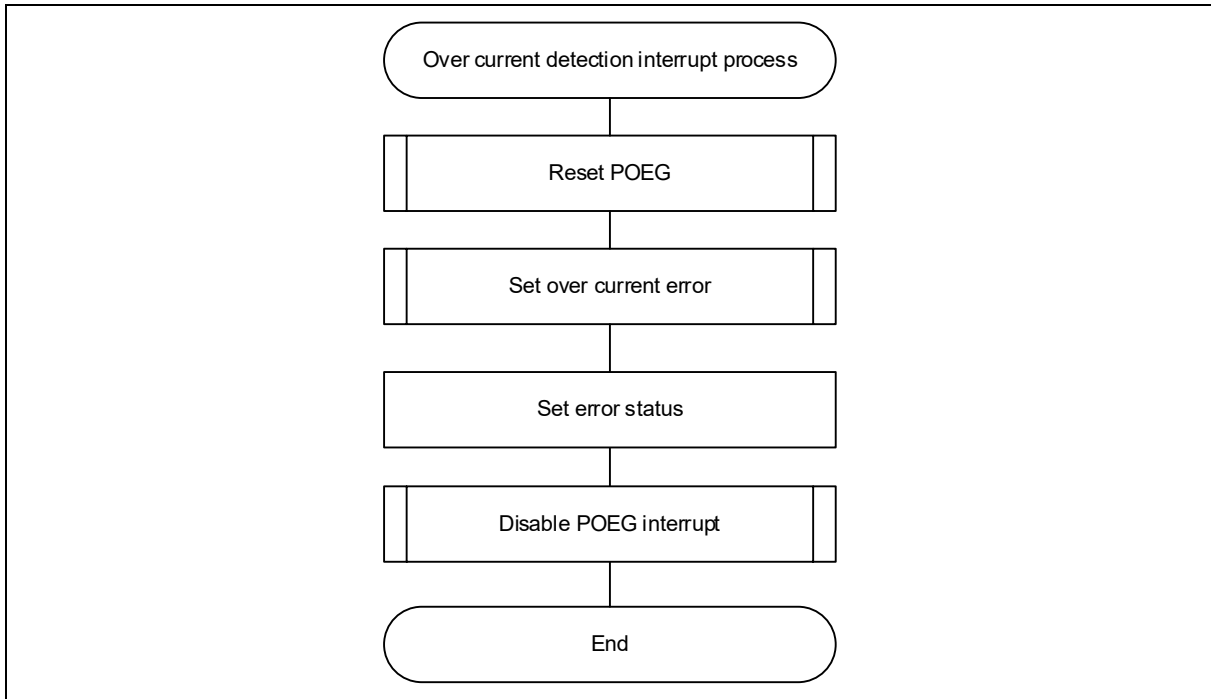

Figure 3-13 Over Current Detection Interrupt Process Flowchart

3.4.5 Encoder signal interrupt processing

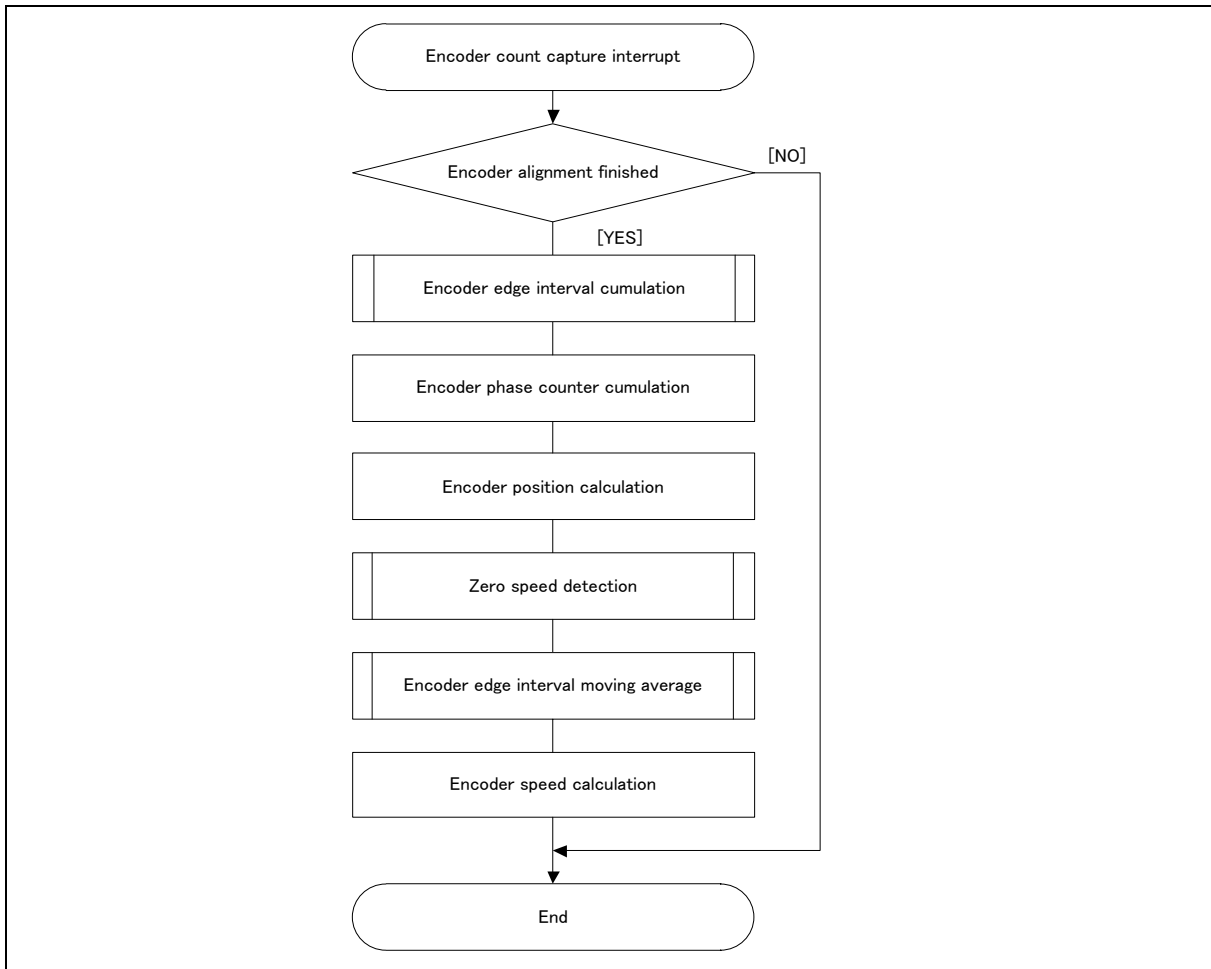

Figure 3-14 Encoder signal interrupt process Flowchart

4. Evaluation environment explanation

4.1 Importing the Demo Project

The sample application provided with this document may be imported into e²studio using the steps in this section.

1. Select File → Import.

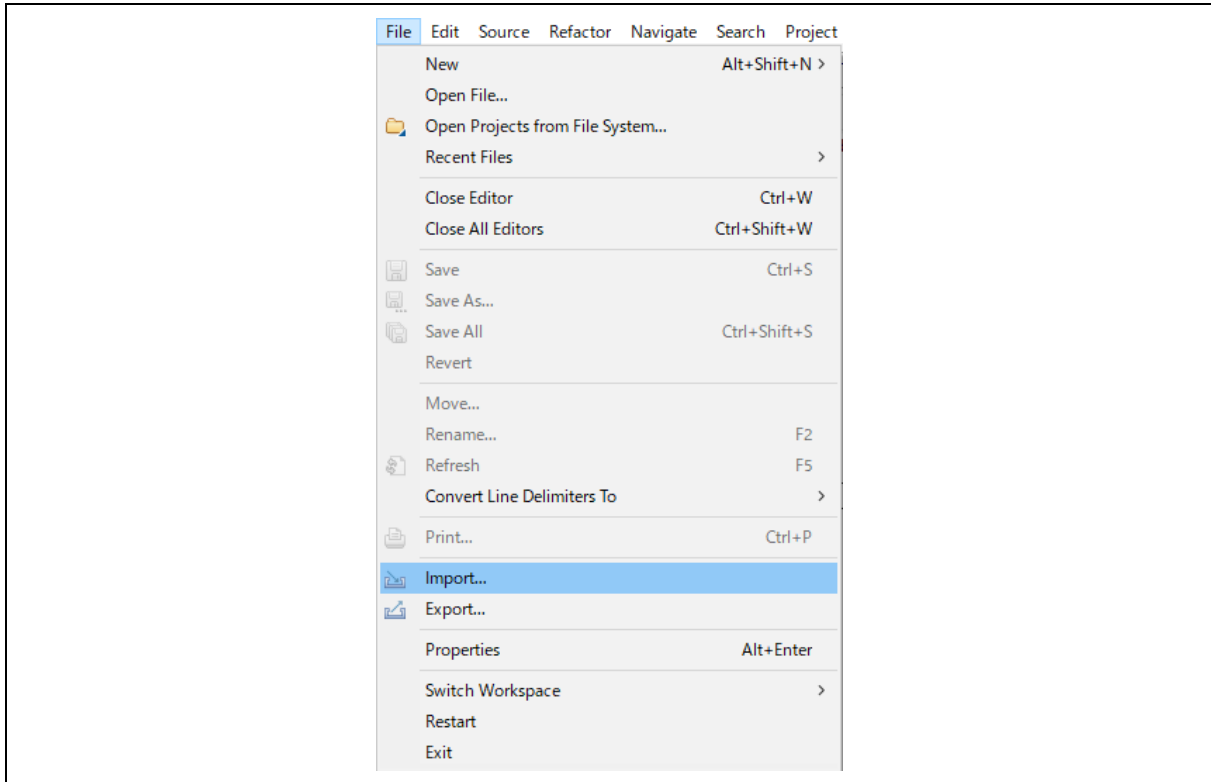

Figure 4-1 File Menu

2. Select “Existing Projects into Workspace”.

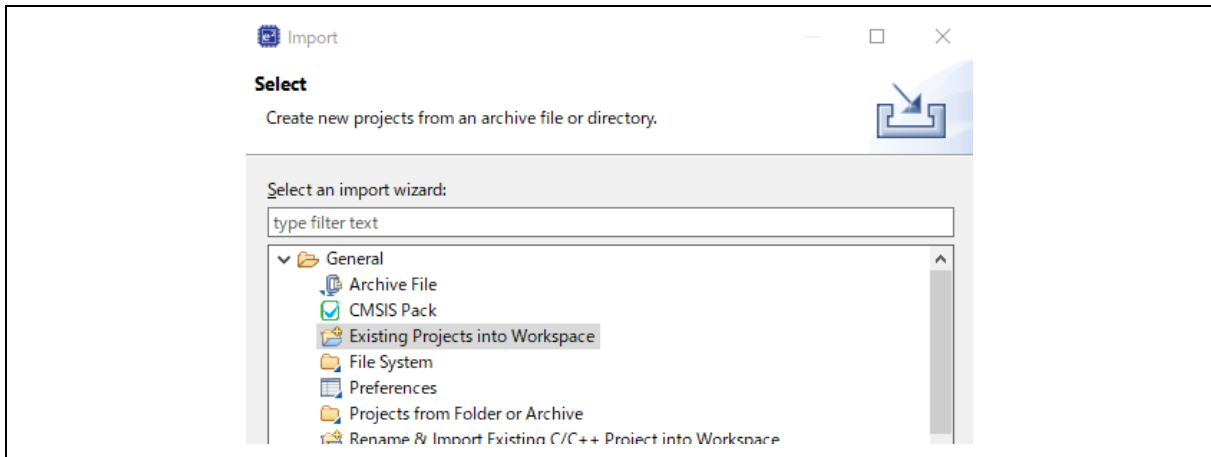

Figure 4-2 Import Wizard Selection

3. Click “Browse...” button and select the demo project. Click Finish button and the demo project is imported.

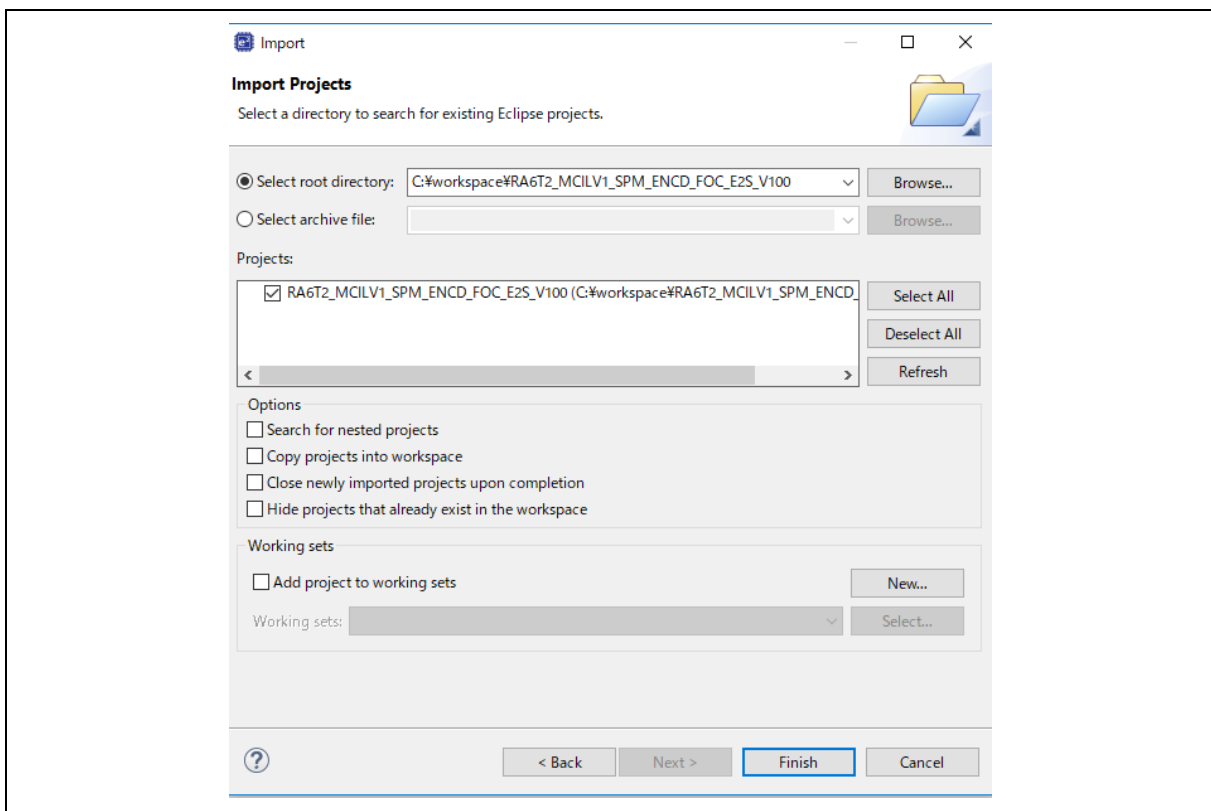

Figure 4-3 Import Projects

4.2 Building and Debugging

Refer to the "e2studio Getting Started Guide (R20UT4204)".

4.3 Quick Start

When executing the sample code only in the evaluation environment without using Renesas motor workbench, the Quick Start Sample Project can be executed with the following procedure.

- (1) After turning on stabilized power supply or executing reset, LED1, and LED2 on the inverter board are both off and the motor stops.
- (2) IF the toggle switch (SW1) on the inverter board is turned on, the motor starts to rotate. Every time the toggle switch (SW1) is changed, motor rotation starts/stops alternately. If the motor rotates normally, LED1 is on. However, if LED2 on the inverter board is also on, error is occurring.
- (3) In order to change the direction of the motor rotation, adjust it with the variable resistor (VR) on the inverter board.
 - Turn the variable resistor (VR) right: Motor rotates clockwise
 - Turn the variable resistor (VR) left: Motor rotates counterclockwise
- (4) If error occurs, LED2 on the inverter board lightens, and the motor rotation stops. To restore, the toggle switch (SW1) on the inverter board needs to be turned off, then the switch (SW2) to be pushed and released.
- (5) In order to stop the operation check, turn off the output of the stabilized power supply after making sure that the motor rotation has already stopped

4.4 Motor Control Development Support Tool ‘Renesas Motor Workbench’

4.4.1 Overview

In the target software of this application note, the motor control development support tool “Renesas Motor Workbench” is used as a user interface (rotating/stop motor, set rotation speed reference, etc). Please refer to ‘Renesas Motor Workbench User’s Manual’ for usage and more details.

You can find ‘Renesas Motor Workbench’ on Renesas Electronics Corporation website.

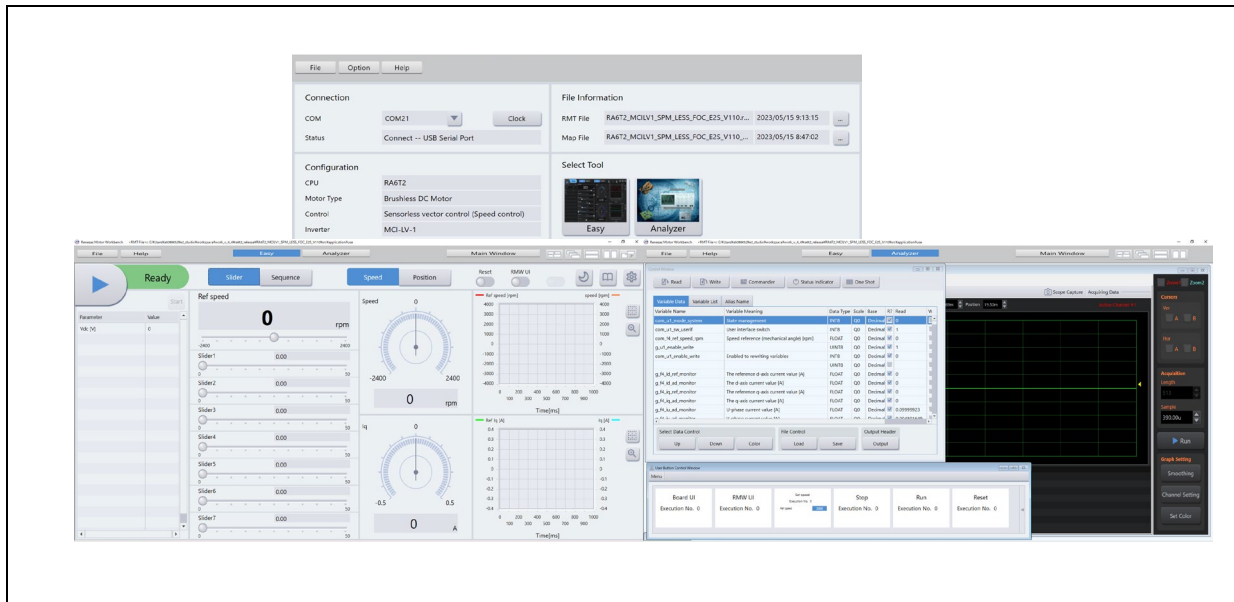

Figure 4-4 Renesas Motor Workbench – Appearance

Set up for “Renesas Motor Workbench”



- (1) Start ‘Renesas Motor Workbench’ by clicking this icon.
- (2) Drop down menu [File] → [Open RMT File(O)].
And select RMT file in ‘[Project Folder]/src/application/user_interface/ics/’.
- (3) Use the ‘Connection’ [COM] select menu to choose the COM port.
- (4) Click the Analyzer button of Select Tool to activate Analyzer function.
- (5) Please refer to ‘4.5.2 Easy function operation example’ or ‘4.5.4 Operation Example for Analyzer’ for motor driving operation.

4.4.2 Easy function operation example

The following is an example of operating the motor using the Easy function.

4.4.2.1 Position control

- Set the control mode to Position

- (1) Select the Position tab.
- (2) Turn on "Position".

If it has already been turned on, turn it off and then turn it on again.

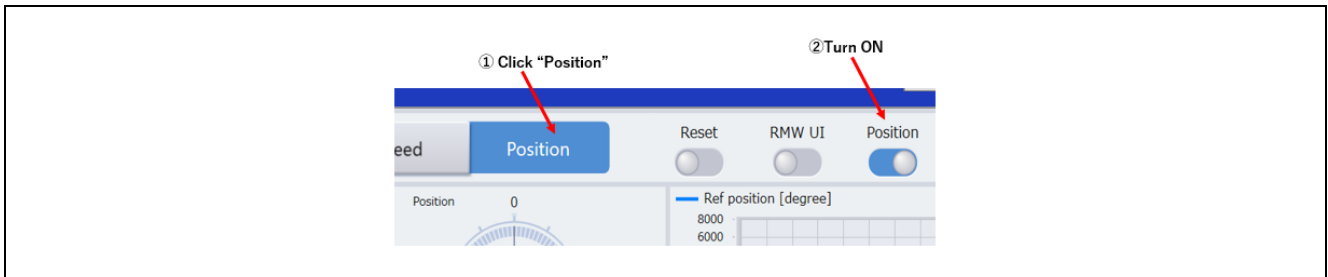

Figure 4-5 Procedure for setting the control mode to Position

- Change the user interface to use Renesas Motor Workbench

- (1) Turn on "RMW UI".

If it has already been turned on, turn it off and then turn it on again.

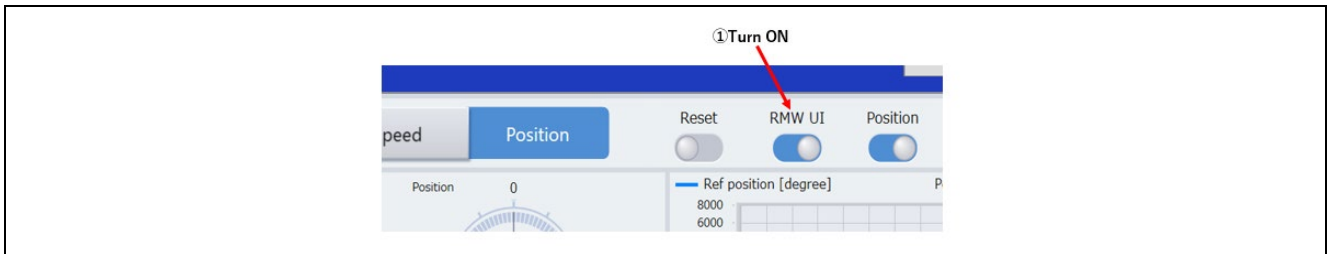

Figure 4-6 Procedure for changing to use Renesas Motor Workbench

- Run the motor

- (1) Press the "Run" button
- (2) Enter the command position with the "Ref position" slider.

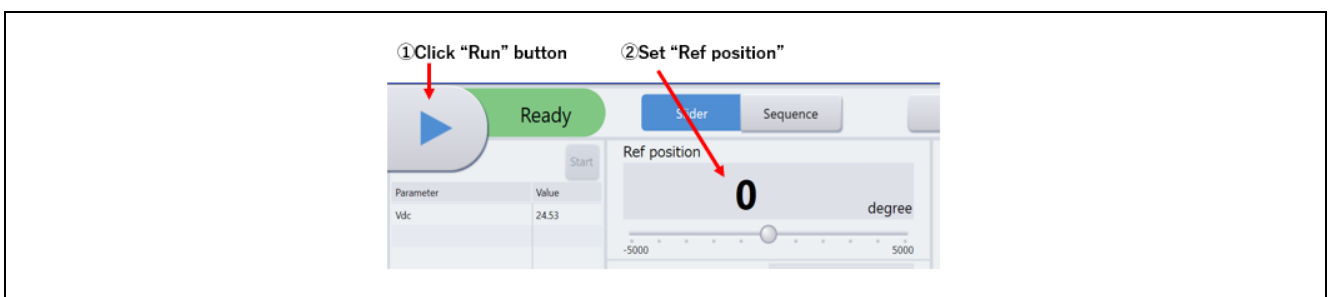

Figure 4-7 Motor rotation procedure

- Stop the motor
 - (1) Press the "Stop" button

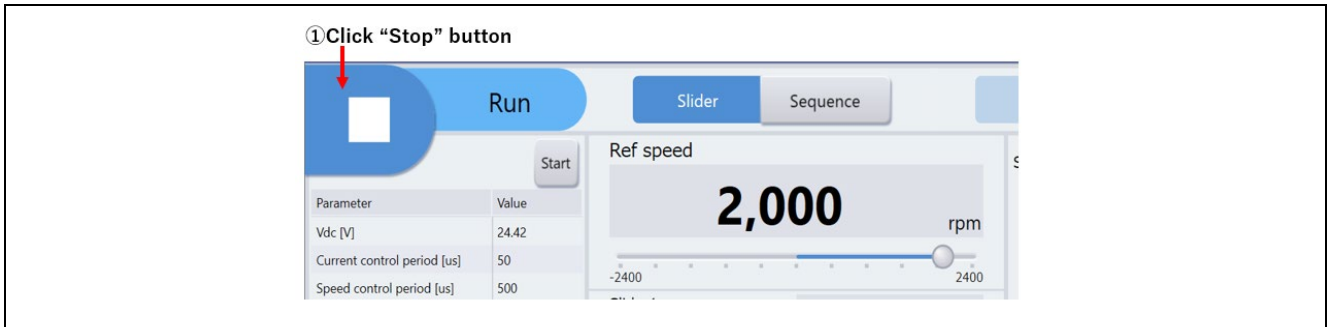

Figure 4-8 Motor stop procedure

- Processing when it stops (error)
 - (1) Turn on "Reset" button.
 - (2) Turn off "Reset" button

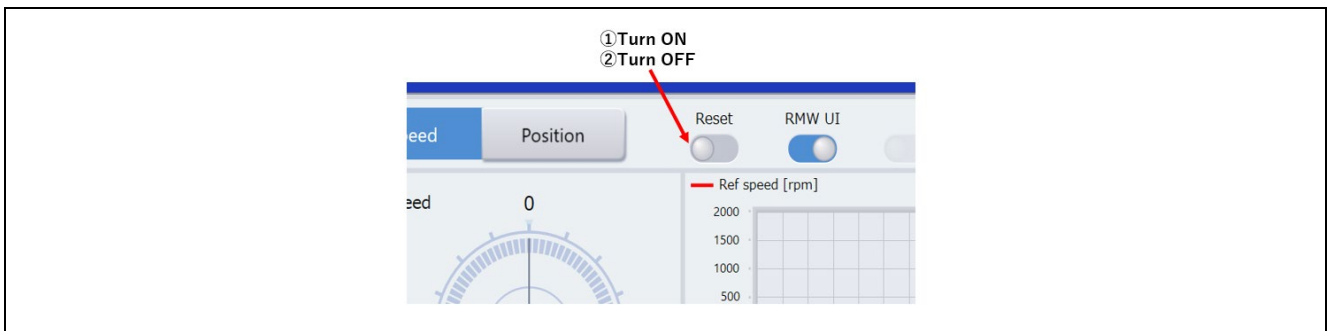

Figure 4-9 Error clearing procedure

4.4.2.2 Speed control

- Set the control mode to Speed

- (1) Select the Speed tab.
- (2) Turn on "Speed".

If it has already been turned on, turn it off and then turn it on again.

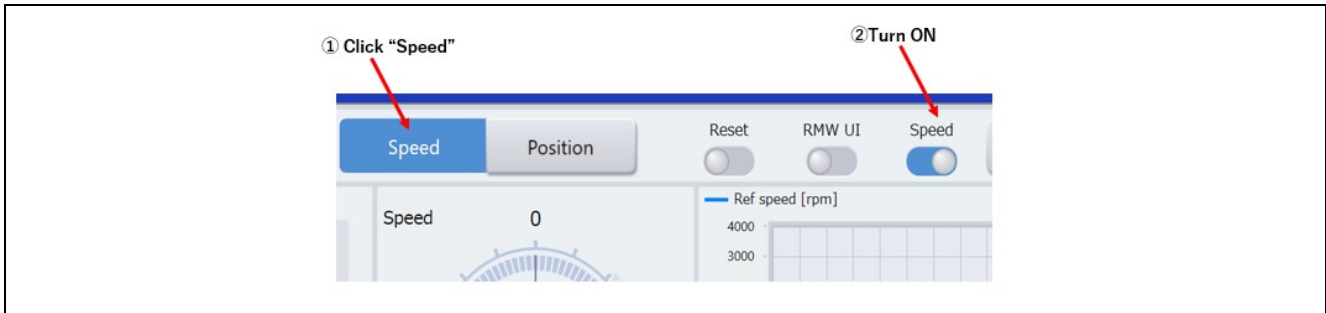

Figure 4-10 Procedure for setting the control mode to Speed

- Change the user interface to use Renesas Motor Workbench

- (1) Turn on "RMW UI".

If it has already been turned on, turn it off and then turn it on again.

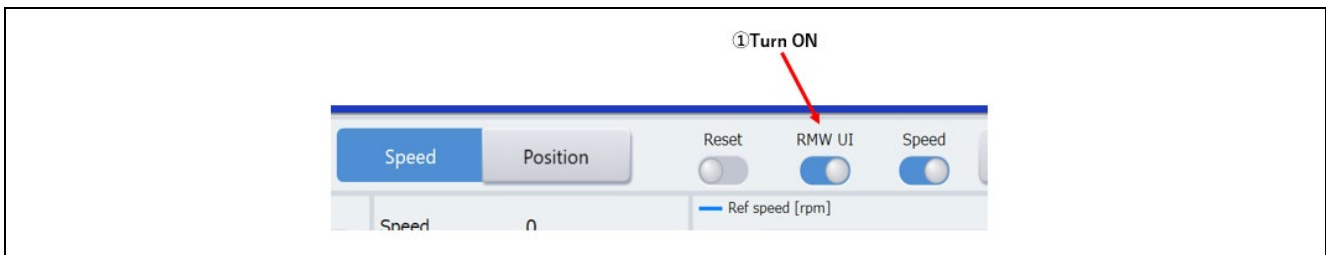

Figure 4-11 Procedure for changing to use Renesas Motor Workbench

- Run the motor

- (1) Press the "Run" button
- (2) Enter the command speed with the "Ref speed" slider.

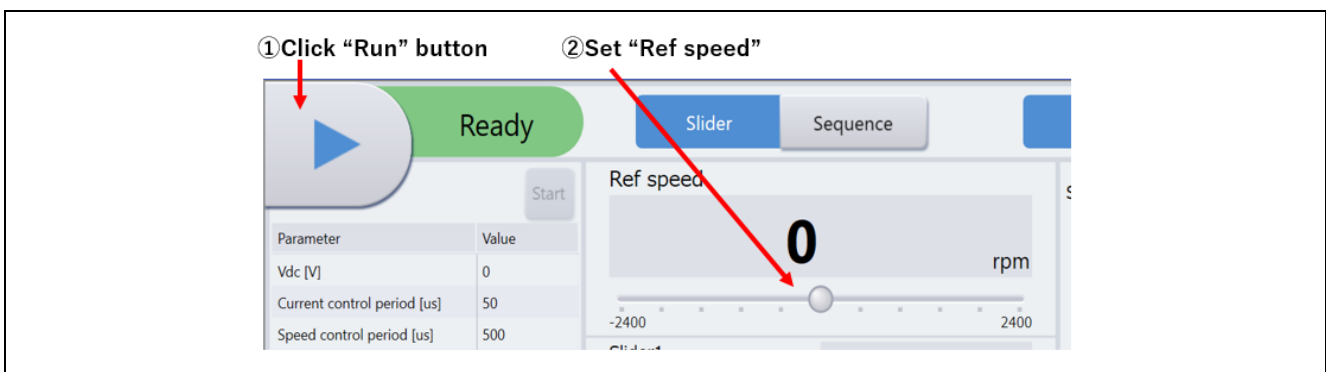

Figure 4-12 Motor rotation procedure

- Stop the motor
 - (1) Press the "Stop" button

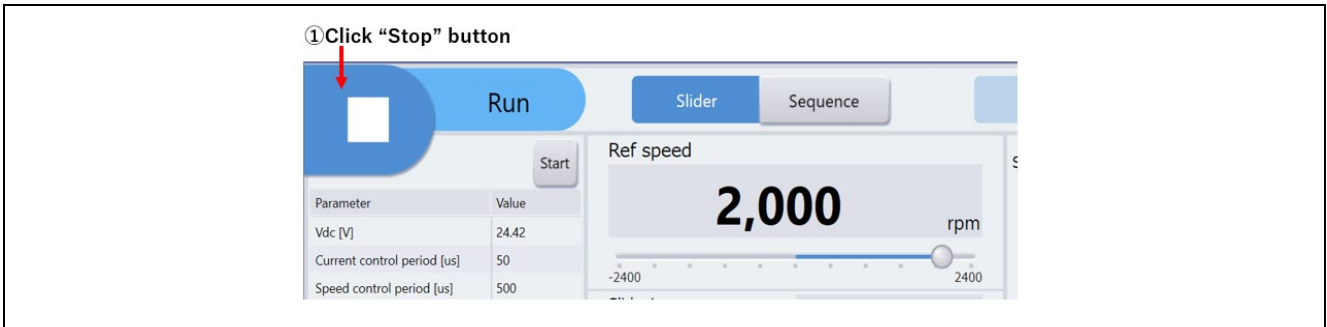

Figure 4-13 Motor stop procedure

- Processing when it stops (error)
 - (1) Turn on "Reset" button.
 - (2) Turn off "Reset" button

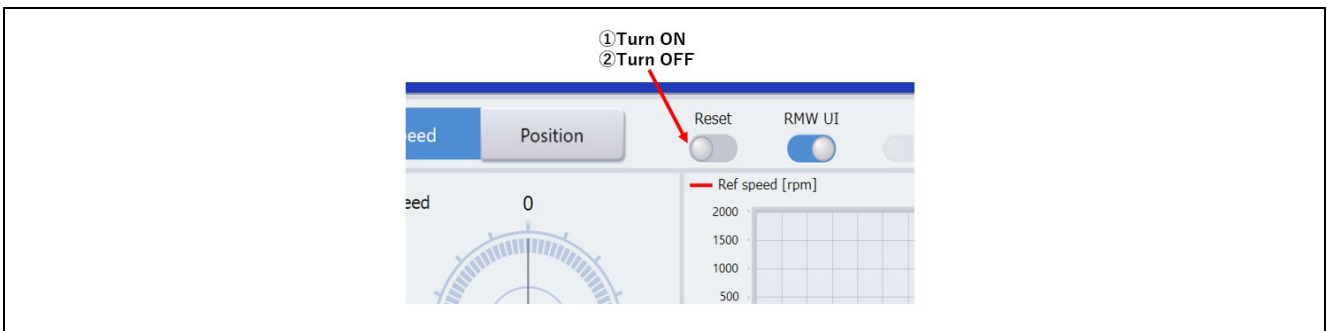

Figure 4-14 Error clearing procedure

4.4.3 List of variables for Analyzer function

Table 4-1 is a list of variables for Analyzer. These variables are reflected to the corresponding variables when the same values as g_u1_enable_write are written to com_u1_enable_write. However, note that variables with (*) do not depend on com_u1_enable_write.

Table 4-1 List of Variables for Analyzer

Variable name	Type	Content
com_u1_sw_userif (*)	uint8_t	User interface switch 0: GUI use 1: Board user interface use (default)
com_u1_mode_system (*)	uint8_t	State management 0: Stop mode 1: Run mode 3: Reset
com_u1_ctrl_loop_mode	uint8_t	Control loop mode switch 0: Speed control 1: Position control (default)
com_f4_ref_speed_rpm	float	Speed reference (Mechanical) [rpm]
com_s2_ref_position_deg	int16_t	Position command value [degree]
com_u2_mtr_pp	uint16_t	Number of pole pairs
com_f4_mtr_r	float	Resistance [Ω]
com_f4_mtr_ld	float	d-axis Inductance [H]
com_f4_mtr_lq	float	q-axis Inductance [H]
com_f4_mtr_m	float	Flux [Wb]
com_f4_mtr_j	float	Inertia [kgm^2]
com_f4_pos_omega	float	Natural frequency of current control system [Hz]
com_f4_sob_omega	float	Damping ratio of current control system
com_f4_sob_zeta	float	Natural frequency of speed control system [Hz]
com_f4_speed_omega	float	Damping ratio of speed control system
com_f4_speed_zeta	float	Natural frequency of the position loop[Hz]
com_f4_current_omega	float	Natural frequency of the speed observer [Hz]
com_f4_current_zeta	float	Damping ratio of the speed observer
com_f4_ol_ref_id	float	d-axis current reference in open loop mode [A]
com_f4_id_up_time	float	d-axis current command value addition time [ms]
com_f4_max_speed_rpm	float	Maximum speed
com_f4_speed_limit_rpm	float	Over speed limit
com_u2_pos_dead_band	uint16_t	Dead band of position
com_u2_pos_band_limit	uint16_t	Positioning complete range
com_u2_encd_cpr	uint16_t	Encoder pulse count (4 for multiplying)
com_u2_interval_time	uint16_t	Time interval of the position command changes
com_f4_accel_time	float	Acceleration time [s] (for position control)
com_f4_speed_rate_limit	float	Acceleration limit [s] (for speed control)
com_f4_overcurrent_limit	float	Over current limit
com_f4_iq_limit	float	q-axis current limit
com_u1_enable_write	uint8_t	Enable to rewriting variables

4.4.4 Operation Example for Analyzer

Following example shows motor driving operation using Analyzer. Operation is using “Control Window” as shown in Figure 4-4. Regarding specification of “Control Window”, refer to ‘Renesas Motor Workbench User’s Manual’.

- Change the user interface to Analyzer

- (1) Confirm the check-boxes of column [W?] for ‘com_u1_sw_userif’ marks.
- (2) Input ‘0’ in the [Write] box of ‘com_u1_sw_userif’.
- (3) Click the ‘Write’ button.

- Driving the motor

- (1) The [W?] check boxes contain checkmarks for “com_u1_mode_system1”, “com_s2_ref_position_deg”, “com_u1_enable_write”
- (2) Type a reference position value in the [Write] box of “com_s2_ref_position_deg”.
- (3) Click the “Write” button.
- (4) Click the “Read” button. Confirm the [Read] box of “com_s2_ref_position_deg”, “g_u1_enable_write”.
- (5) Enter the same value of “g_u1_enable_write” in the [Write] box of “com_u1_enable_write”.
- (6) Enter “1” in the [Write] box of “com_u1_mode_system”.
- (7) Click the “Write” button.

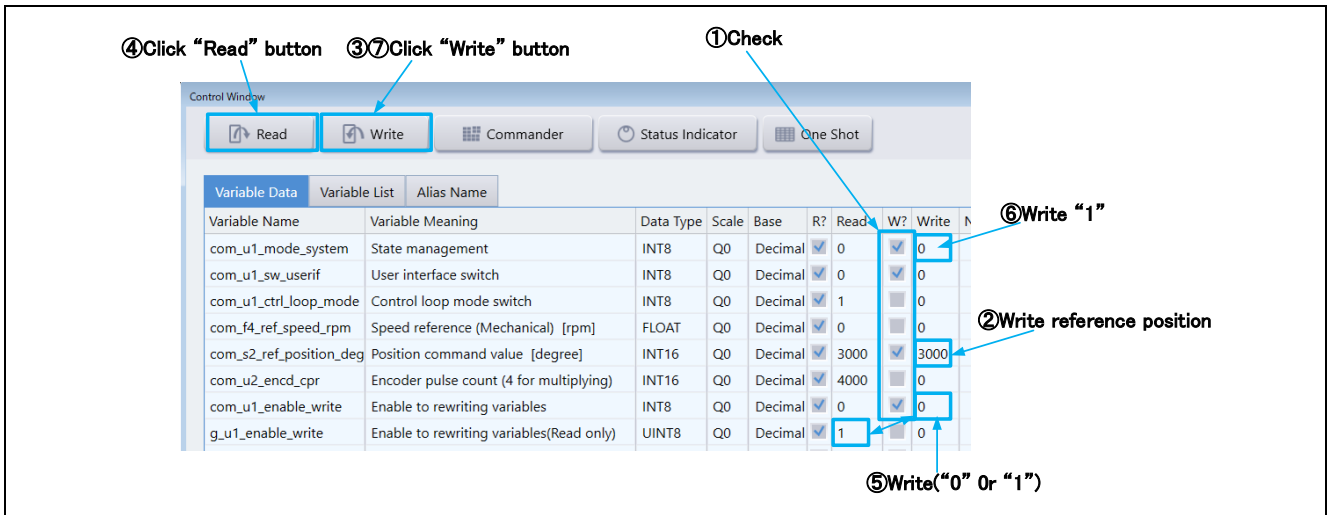

Figure 4-15 Procedure - Driving the motor

- Stop the motor

- (1) Enter “0” in the [Write] box of “com_u1_mode_system”.
- (2) Click the “Write” button.

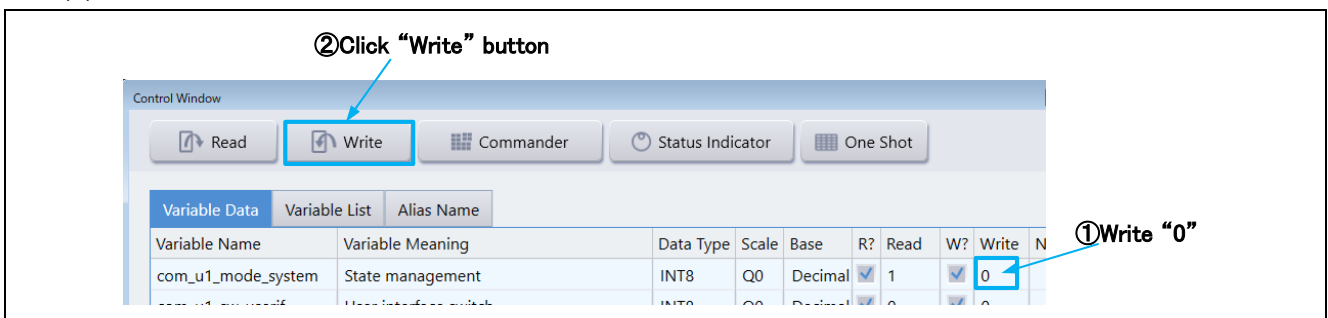

Figure 4-16 Procedure - Stop the motor

- Error cancel operation

- (1) Enter "3" in the [Write] box of "com_u1_mode_system".
- (2) Click the "Write" button.

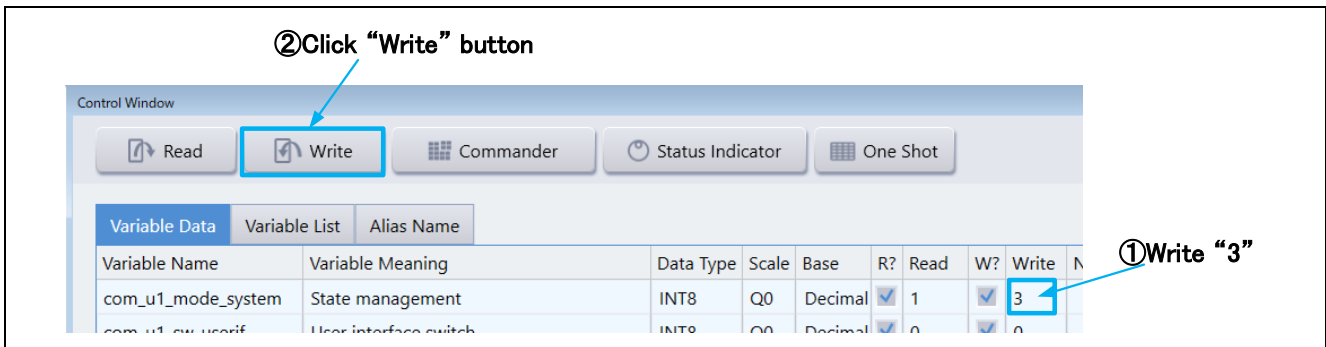

Figure 4-17 Procedure - Error cancel operation

4.4.5 Tuner function

To use the Tuner function, use the executable file provided by Renesas Motor Workbench or "RA6T2(RA8T1,RA6T3,RA4T1)_MCILV1_SPM_ENCD_FOC_TUNER_E2S_Vxxx" included in the sample software.

For details on how to use the Tuner function, refer to the Renesas Motor Workbench User's Manual.

4.4.6 Example of changing communication speed

The procedure for changing the communication speed of Renesas Motor Workbench with the sample software is shown below. See the Renesas Motor Workbench User's Manual for the values to change.

- Change the communication speed setting of the sample software (when the required communication rate is 10 Mbps)
 - (1) Change the value of ICS_BRR in r_mtr_ics.h to 1.
 - (2) Change the value of MTR_ICS_DECIMATION in r_mtr_ics.h to 1.

```
#define MTR_ICS_DECIMATION (1)

/* For ICS */
#define ICS_BRR (1)
#define ICS_INT_MODE (1)
" " "
```

Figure 4-18 Modification of r_mtr_ics.h

- Change the communication speed setting of Renesas Motor Workbench to connect
 - (1) Press the Clock button on the Main Window to change the value to 80,000,000
This value was calculated by multiplying the default 8,000,000 by 10
because the UART communication baud rate was changed from 1Mbps to 10Mbps.
 - (2) Select the COM of the connected kit in the COM of Connection

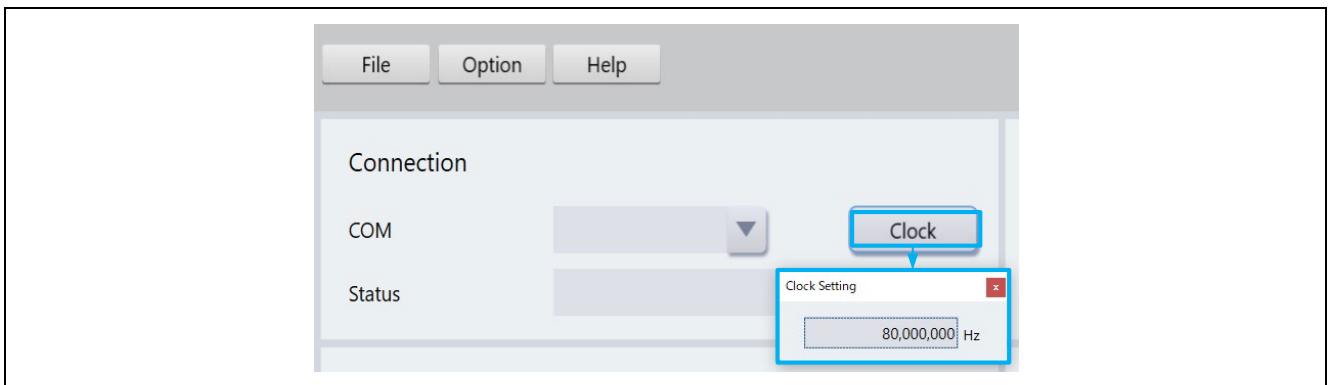

Figure 4-19 Clock frequency setting

If the connection fails, repeat the procedure for reconnecting after resetting the communication board.

4.4.7 How to use the built-in communication library

The procedure for connecting to Renesas Motor Workbench using the built-in communication library without using the communication board with the sample software is shown below.

- Connection between PC and CPU board
 - (1) Connect the CPU board and PC via a USB / serial conversion board, etc.

- Preparing a project for built-in communication (example of RA6T2 921600bps)
 - (1) Cancel the registration of ICS2_RA6T2.o

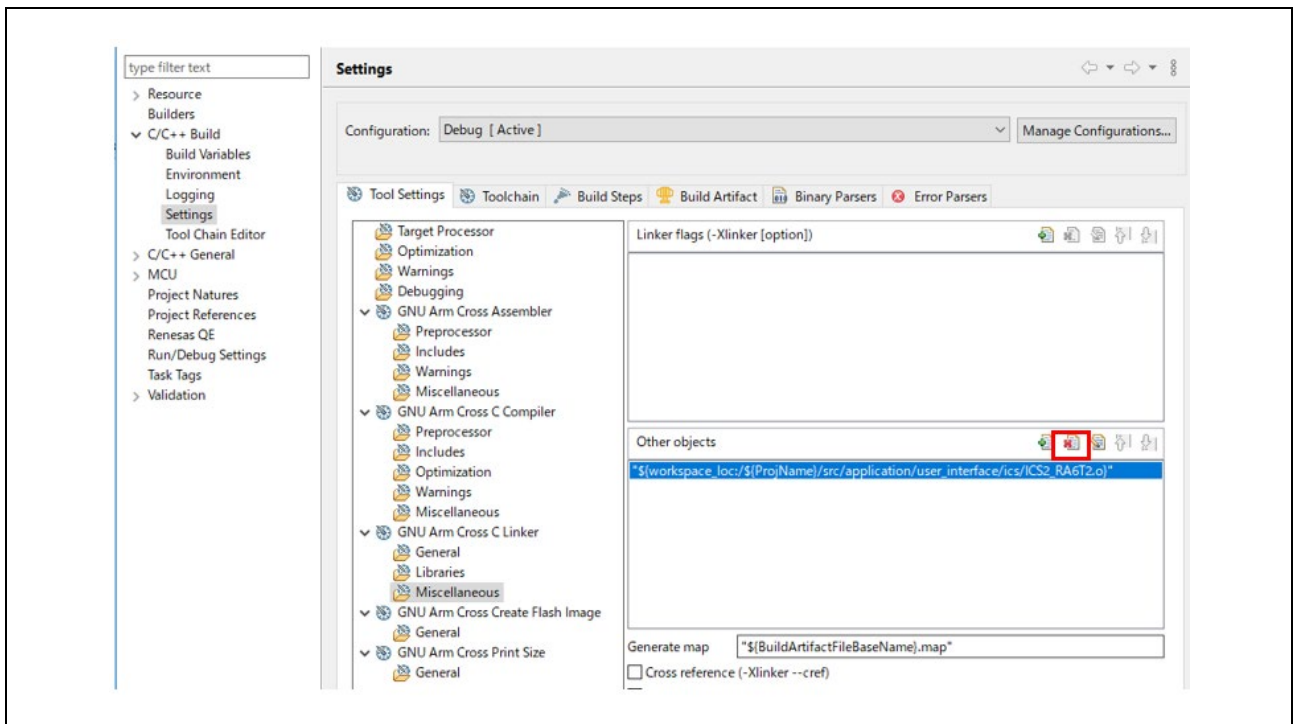

Figure 4-20 Unregister ICS2_RA6T2.o

(2) Register ICS2_RA6T2_Built_in.o

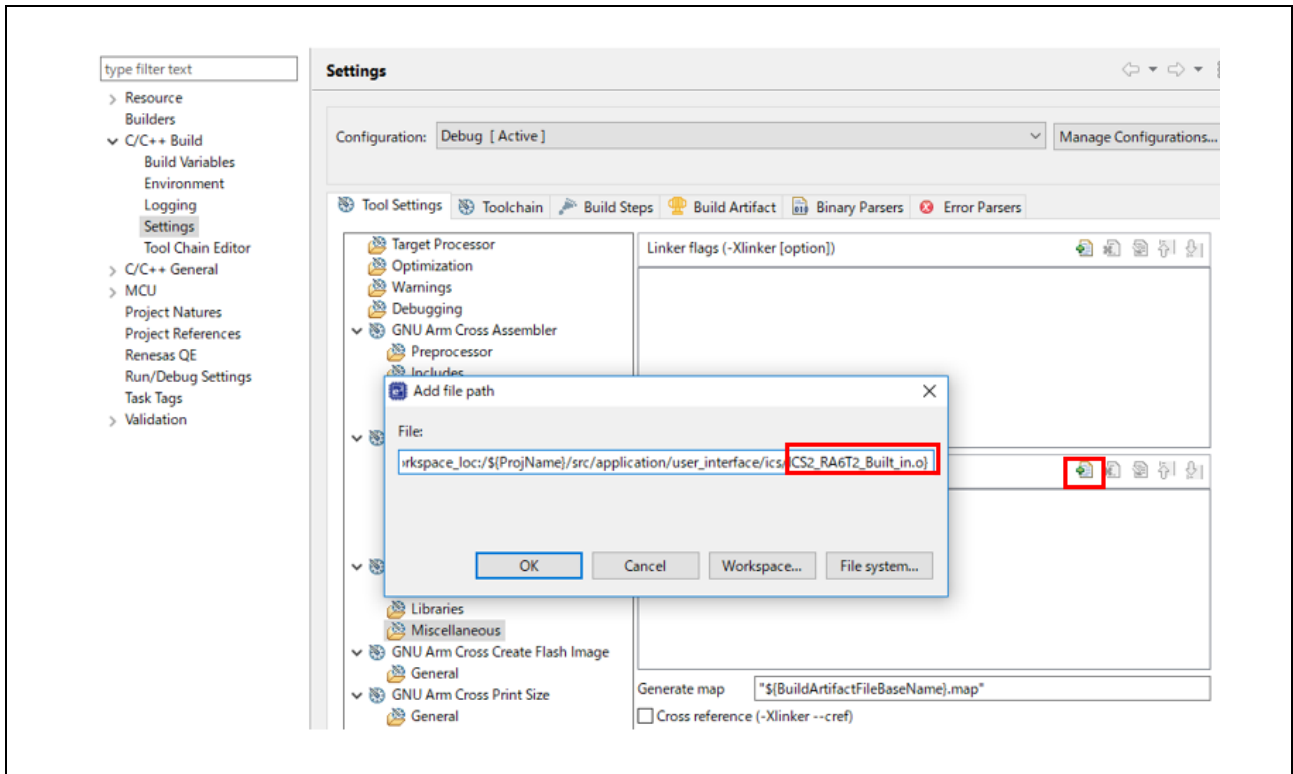

Figure 4-21 Register ICS2_RA6T2.o

(3) Change the value of USE_BUILT_IN in r_mtr_ics.h to 1.

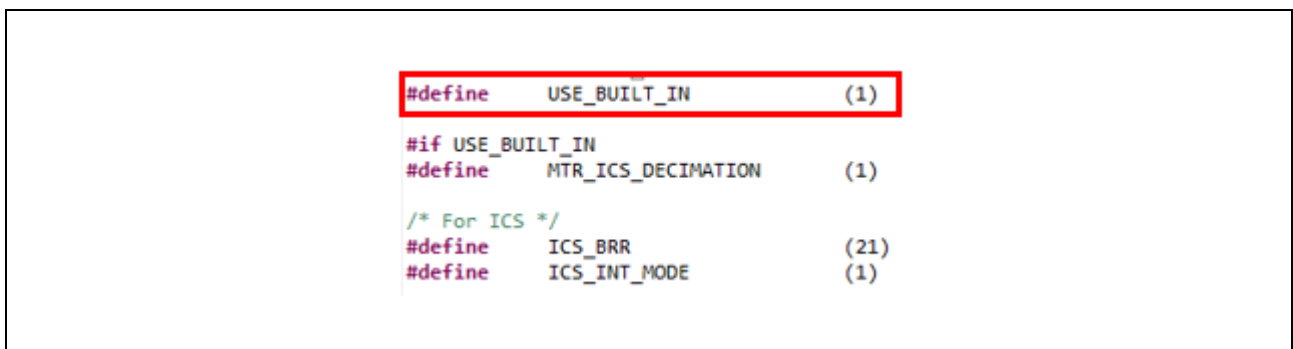

Figure 4-22 Modification of r_mtr_ics.h

- Change the communication baud rate setting of Renesas Motor Workbench to connect
 - (1) Change the value to 921,600 with Baud rate Dialog from the Option menu of the Main Window.
 - (2) Select the COM port of the connected kit in the COM of Connection.

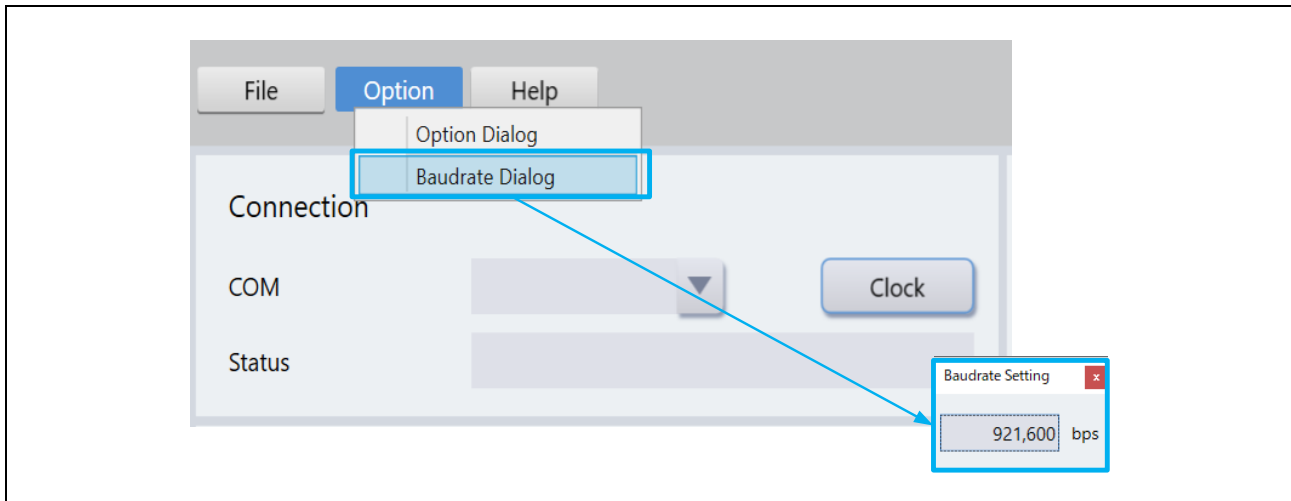

Figure 4-23 Baud rate setting

5. Reference Documents

RA6T2 Group User's Manual: Hardware (R01UH0951)

RA4T1 Group User's Manual: Hardware (R01UH0998)

RA6T3 Group User's Manual: Hardware (R01UH0999)

RA8T1 Group User's Manual: Hardware (R01UH1016)

RA Flexible Software Package Documentation

Application note: 'Encoder vector control for permanent magnet synchronous motor (Algorithm)'
(R01AN3789)

Renesas Motor Workbench User's Manual (R21UZ0004)

Renesas Motor Workbench Quick start guide (R21QS0011)

MCK-RA6T2 User's Manual (R12UZ0091)

MCK-RA4T1 User's Manual (R12UZ0114)

MCK-RA6T3 User's Manual (R12UZ0115)

MCK-RA8T1 User's Manual (R12UZ0133)

Revision History

Rev.	Date	Description	
		Page	Summary
1.00	May 23, 2023	-	First edition issued
1.10	Jan 23, 2024	-	Added description related to RA8T1
1.11	Dec 23, 2024	-	Update target software

General Precautions in the Handling of Microprocessing Unit and Microcontroller Unit Products

The following usage notes are applicable to all Microprocessing unit and Microcontroller unit products from Renesas. For detailed usage notes on the products covered by this document, refer to the relevant sections of the document as well as any technical updates that have been issued for the products.

1. Precaution against Electrostatic Discharge (ESD)

A strong electrical field, when exposed to a CMOS device, can cause destruction of the gate oxide and ultimately degrade the device operation. Steps must be taken to stop the generation of static electricity as much as possible, and quickly dissipate it when it occurs. Environmental control must be adequate. When it is dry, a humidifier should be used. This is recommended to avoid using insulators that can easily build up static electricity.

Semiconductor devices must be stored and transported in an anti-static container, static shielding bag or conductive material. All test and measurement tools including work benches and floors must be grounded. The operator must also be grounded using a wrist strap. Semiconductor devices must not be touched with bare hands. Similar precautions must be taken for printed circuit boards with mounted semiconductor devices.

2. Processing at power-on

The state of the product is undefined at the time when power is supplied. The states of internal circuits in the LSI are indeterminate and the states of register settings and pins are undefined at the time when power is supplied. In a finished product where the reset signal is applied to the external reset pin, the states of pins are not guaranteed from the time when power is supplied until the reset process is completed. In a similar way, the states of pins in a product that is reset by an on-chip power-on reset function are not guaranteed from the time when power is supplied until the power reaches the level at which resetting is specified.

3. Input of signal during power-off state

Do not input signals or an I/O pull-up power supply while the device is powered off. The current injection that results from input of such a signal or I/O pull-up power supply may cause malfunction and the abnormal current that passes in the device at this time may cause degradation of internal elements. Follow the guideline for input signal during power-off state as described in your product documentation.

4. Handling of unused pins

Handle unused pins in accordance with the directions given under handling of unused pins in the manual. The input pins of CMOS products are generally in the high-impedance state. In operation with an unused pin in the open-circuit state, extra electromagnetic noise is induced in the vicinity of the LSI, an associated shoot-through current flows internally, and malfunctions occur due to the false recognition of the pin state as an input signal become possible.

5. Clock signals

After applying a reset, only release the reset line after the operating clock signal becomes stable. When switching the clock signal during program execution, wait until the target clock signal is stabilized. When the clock signal is generated with an external resonator or from an external oscillator during a reset, ensure that the reset line is only released after full stabilization of the clock signal. Additionally, when switching to a clock signal produced with an external resonator or by an external oscillator while program execution is in progress, wait until the target clock signal is stable.

6. Voltage application waveform at input pin

Waveform distortion due to input noise or a reflected wave may cause malfunction. If the input of the CMOS device stays in the area between V_{IL} (Max.) and V_{IH} (Min.) due to noise, for example, the device may malfunction. Take care to prevent chattering noise from entering the device when the input level is fixed, and also in the transition period when the input level passes through the area between V_{IL} (Max.) and V_{IH} (Min.).

7. Prohibition of access to reserved addresses

Access to reserved addresses is prohibited. The reserved addresses are provided for possible future expansion of functions. Do not access these addresses as the correct operation of the LSI is not guaranteed.

8. Differences between products

Before changing from one product to another, for example to a product with a different part number, confirm that the change will not lead to problems. The characteristics of a microprocessing unit or microcontroller unit products in the same group but having a different part number might differ in terms of internal memory capacity, layout pattern, and other factors, which can affect the ranges of electrical characteristics, such as characteristic values, operating margins, immunity to noise, and amount of radiated noise. When changing to a product with a different part number, implement a system-evaluation test for the given product.

Notice

1. Descriptions of circuits, software and other related information in this document are provided only to illustrate the operation of semiconductor products and application examples. You are fully responsible for the incorporation or any other use of the circuits, software, and information in the design of your product or system. Renesas Electronics disclaims any and all liability for any losses and damages incurred by you or third parties arising from the use of these circuits, software, or information.
2. Renesas Electronics hereby expressly disclaims any warranties against and liability for infringement or any other claims involving patents, copyrights, or other intellectual property rights of third parties, by or arising from the use of Renesas Electronics products or technical information described in this document, including but not limited to, the product data, drawings, charts, programs, algorithms, and application examples.
3. No license, express, implied or otherwise, is granted hereby under any patents, copyrights or other intellectual property rights of Renesas Electronics or others.
4. You shall be responsible for determining what licenses are required from any third parties, and obtaining such licenses for the lawful import, export, manufacture, sales, utilization, distribution or other disposal of any products incorporating Renesas Electronics products, if required.
5. You shall not alter, modify, copy, or reverse engineer any Renesas Electronics product, whether in whole or in part. Renesas Electronics disclaims any and all liability for any losses or damages incurred by you or third parties arising from such alteration, modification, copying or reverse engineering.
6. Renesas Electronics products are classified according to the following two quality grades: "Standard" and "High Quality". The intended applications for each Renesas Electronics product depends on the product's quality grade, as indicated below.
 - "Standard": Computers; office equipment; communications equipment; test and measurement equipment; audio and visual equipment; home electronic appliances; machine tools; personal electronic equipment; industrial robots; etc.
 - "High Quality": Transportation equipment (automobiles, trains, ships, etc.); traffic control (traffic lights); large-scale communication equipment; key financial terminal systems; safety control equipment; etc.

Unless expressly designated as a high reliability product or a product for harsh environments in a Renesas Electronics data sheet or other Renesas Electronics document, Renesas Electronics products are not intended or authorized for use in products or systems that may pose a direct threat to human life or bodily injury (artificial life support devices or systems; surgical implantations; etc.), or may cause serious property damage (space system; undersea repeaters; nuclear power control systems; aircraft control systems; key plant systems; military equipment; etc.). Renesas Electronics disclaims any and all liability for any damages or losses incurred by you or any third parties arising from the use of any Renesas Electronics product that is inconsistent with any Renesas Electronics data sheet, user's manual or other Renesas Electronics document.
7. No semiconductor product is absolutely secure. Notwithstanding any security measures or features that may be implemented in Renesas Electronics hardware or software products, Renesas Electronics shall have absolutely no liability arising out of any vulnerability or security breach, including but not limited to any unauthorized access to or use of a Renesas Electronics product or a system that uses a Renesas Electronics product. RENESAS ELECTRONICS DOES NOT WARRANT OR GUARANTEE THAT RENESAS ELECTRONICS PRODUCTS, OR ANY SYSTEMS CREATED USING RENESAS ELECTRONICS PRODUCTS WILL BE INVULNERABLE OR FREE FROM CORRUPTION, ATTACK, VIRUSES, INTERFERENCE, HACKING, DATA LOSS OR THEFT, OR OTHER SECURITY INTRUSION ("Vulnerability Issues"). RENESAS ELECTRONICS DISCLAIMS ANY AND ALL RESPONSIBILITY OR LIABILITY ARISING FROM OR RELATED TO ANY VULNERABILITY ISSUES. FURTHERMORE, TO THE EXTENT PERMITTED BY APPLICABLE LAW, RENESAS ELECTRONICS DISCLAIMS ANY AND ALL WARRANTIES, EXPRESS OR IMPLIED, WITH RESPECT TO THIS DOCUMENT AND ANY RELATED OR ACCOMPANYING SOFTWARE OR HARDWARE, INCLUDING BUT NOT LIMITED TO THE IMPLIED WARRANTIES OF MERCHANTABILITY, OR FITNESS FOR A PARTICULAR PURPOSE.
8. When using Renesas Electronics products, refer to the latest product information (data sheets, user's manuals, application notes, "General Notes for Handling and Using Semiconductor Devices" in the reliability handbook, etc.), and ensure that usage conditions are within the ranges specified by Renesas Electronics with respect to maximum ratings, operating power supply voltage range, heat dissipation characteristics, installation, etc. Renesas Electronics disclaims any and all liability for any malfunctions, failure or accident arising out of the use of Renesas Electronics products outside of such specified ranges.
9. Although Renesas Electronics endeavors to improve the quality and reliability of Renesas Electronics products, semiconductor products have specific characteristics, such as the occurrence of failure at a certain rate and malfunctions under certain use conditions. Unless designated as a high reliability product or a product for harsh environments in a Renesas Electronics data sheet or other Renesas Electronics document, Renesas Electronics products are not subject to radiation resistance design. You are responsible for implementing safety measures to guard against the possibility of bodily injury, injury or damage caused by fire, and/or danger to the public in the event of a failure or malfunction of Renesas Electronics products, such as safety design for hardware and software, including but not limited to redundancy, fire control and malfunction prevention, appropriate treatment for aging degradation or any other appropriate measures. Because the evaluation of microcomputer software alone is very difficult and impractical, you are responsible for evaluating the safety of the final products or systems manufactured by you.
10. Please contact a Renesas Electronics sales office for details as to environmental matters such as the environmental compatibility of each Renesas Electronics product. You are responsible for carefully and sufficiently investigating applicable laws and regulations that regulate the inclusion or use of controlled substances, including without limitation, the EU RoHS Directive, and using Renesas Electronics products in compliance with all these applicable laws and regulations. Renesas Electronics disclaims any and all liability for damages or losses occurring as a result of your noncompliance with applicable laws and regulations.
11. Renesas Electronics products and technologies shall not be used for or incorporated into any products or systems whose manufacture, use, or sale is prohibited under any applicable domestic or foreign laws or regulations. You shall comply with any applicable export control laws and regulations promulgated and administered by the governments of any countries asserting jurisdiction over the parties or transactions.
12. It is the responsibility of the buyer or distributor of Renesas Electronics products, or any other party who distributes, disposes of, or otherwise sells or transfers the product to a third party, to notify such third party in advance of the contents and conditions set forth in this document.
13. This document shall not be reprinted, reproduced or duplicated in any form, in whole or in part, without prior written consent of Renesas Electronics.
14. Please contact a Renesas Electronics sales office if you have any questions regarding the information contained in this document or Renesas Electronics products.

(Note1) "Renesas Electronics" as used in this document means Renesas Electronics Corporation and also includes its directly or indirectly controlled subsidiaries.

(Note2) "Renesas Electronics product(s)" means any product developed or manufactured by or for Renesas Electronics.

(Rev.5.0-1 October 2020)

Corporate Headquarters

TOYOSU FORESIA, 3-2-24 Toyosu,
Koto-ku, Tokyo 135-0061, Japan
www.renesas.com

Trademarks

Renesas and the Renesas logo are trademarks of Renesas Electronics Corporation. All trademarks and registered trademarks are the property of their respective owners.

Contact information

For further information on a product, technology, the most up-to-date version of a document, or your nearest sales office, please visit:
www.renesas.com/contact/.