

## Renesas RL78 Family

**Y-DK-IAQ-SENSE-RL78G23**
**Introduction**

This application note provides a thorough overview of the RL78/G23 Indoor Air Quality Demonstration project. We'll start with a concise hardware overview, then transition into an in-depth analysis of the software components.

The discussion will encompass key aspects such as software architecture, peripheral utilization, low-power strategies, and essential software components, including the custom task scheduler and display middleware.

Furthermore, we'll offer insights into the project's structure, power consumption and resource utilization.

**Contents**

1. Overview .....	3
1.1 Requirements .....	3
2. Importing and Debugging Project.....	4
2.1 Import .....	4
2.2 Build.....	6
2.3 Debug .....	8
2.4 Troubleshooting.....	11
2.4.1 Error: Program “make” Not Found in Path .....	11
2.4.2 Undefined External Symbol / Missing Components SC .....	12
3. Hardware.....	18
3.1 Powering the Board.....	20
3.2 Programming and Debugging the Board.....	21
3.3 Capacitive Proximity Electrode.....	22
4. Software .....	22
4.1 Startup .....	22
4.2 Architecture .....	23
4.2.1 Structure .....	23
4.2.2 Event Handling .....	23
4.2.3 Task Scheduling .....	23
4.2.3.1 GUI Thread.....	24
4.2.3.2 Event Thread.....	25
4.2.3.3 IPC.....	25
4.3 State Machine.....	26
4.4 Peripherals .....	27
4.4.1 Rotary Encoder.....	28
5. Power Consumption .....	29

---

6. Important Source Modifications .....33

Revision History.....35

### 1. Overview

The RL78/G23 Indoor Air Quality Demonstrator is a compact, credit-card-sized PCB designed to periodically monitor air quality, temperature, and humidity. Data is displayed to the user upon activation through a capacitive proximity detection system. The system also boasts user-interaction capabilities, allowing for the customization of alarm thresholds based on deteriorating air quality levels.

This demonstrator not only showcases the RL78/G23's exemplary performance in real-world, low-power applications but also leverages its innovative features to minimize software complexity and the overall component count in a system's Bill of Materials (BoM).

Key to these enhancements is the integration of various peripherals and software techniques. The Event Link Controller with Logic (ELCL) streamlines both BoM and software logic, enabling automatic rotary decoding and direction detection. The Current Controlled IO (CCIO) optimizes the BoM and timer usage by driving the LED backlight and bi-colour LED. By pairing the Data Transfer Controller (DTC) with the Capacitive Touch Sensing Unit (CTSU), the system can perform capacitive proximity detection scans while in a low power "snooze" mode, eliminating the need for CPU intervention.

The system diagram shown in Figure 1 represents the demonstrators fundamental working.

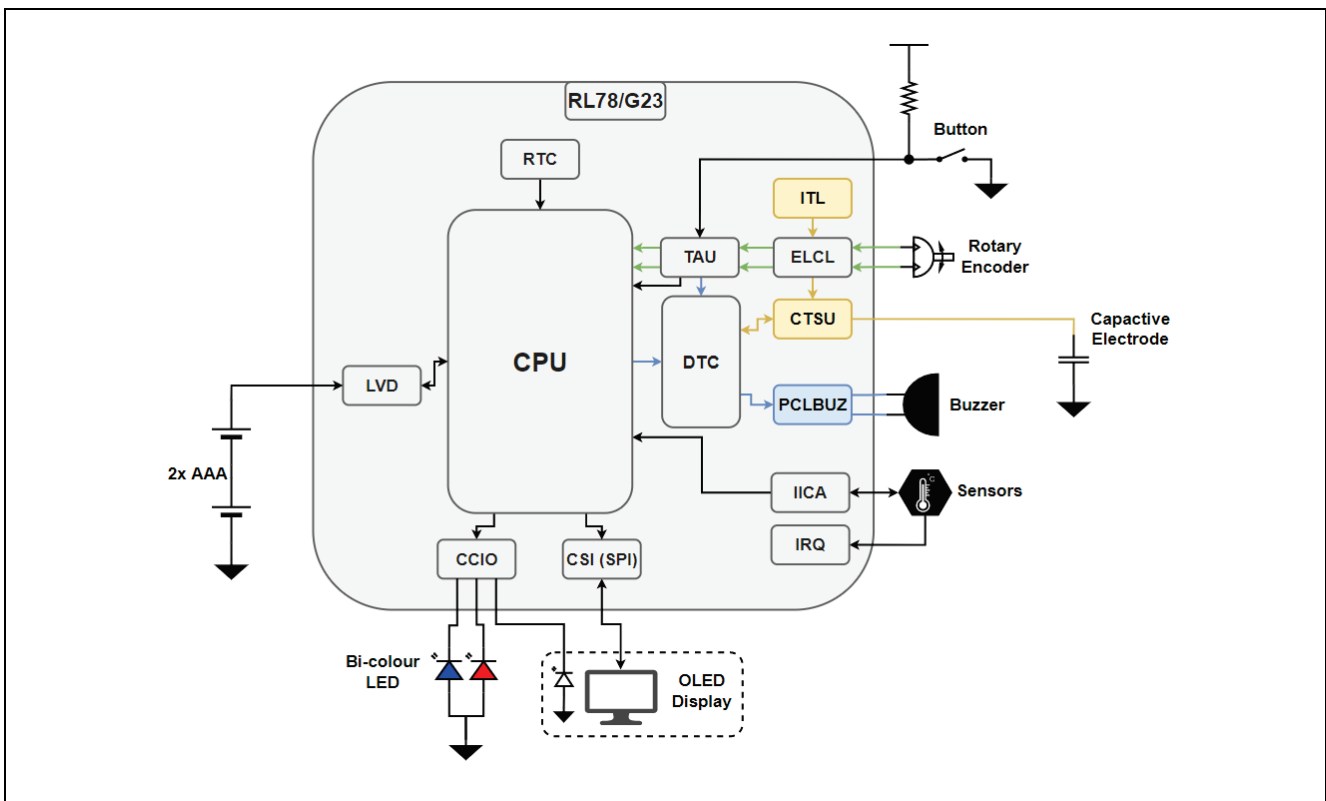

Figure 1. System Diagram

### 1.1 Requirements

**Hardware**

- 1x Y-DK-IAQ-SENSE-RL78G23
- 1x E2 Lite

**Software**

- e<sup>2</sup> studio v2023-04 minimum
- CCRL v1.12.00 minimum

## 2. Importing and Debugging Project

The source code for debugging the project is available on [GitHub](#).

### 2.1 Import

To download a copy of the code, open e<sup>2</sup> studio and create a workspace in an appropriate location.

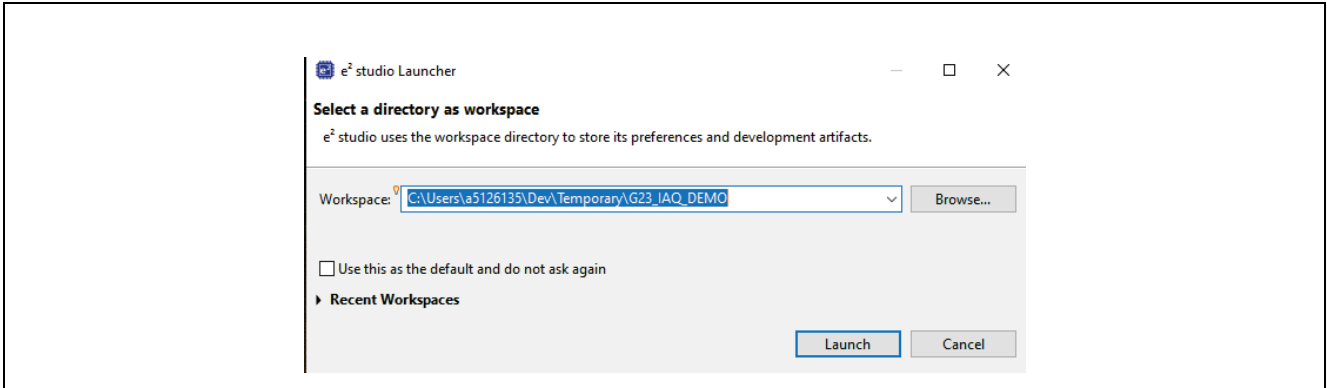

Figure 2. e<sup>2</sup> studio workspace

Then, open a PowerShell window anywhere on your machine and clone the repository by entering the following command in the PowerShell window.

```
>> git clone https://github.com/lwray-renesas/r178-g23-aq-demo.git
```

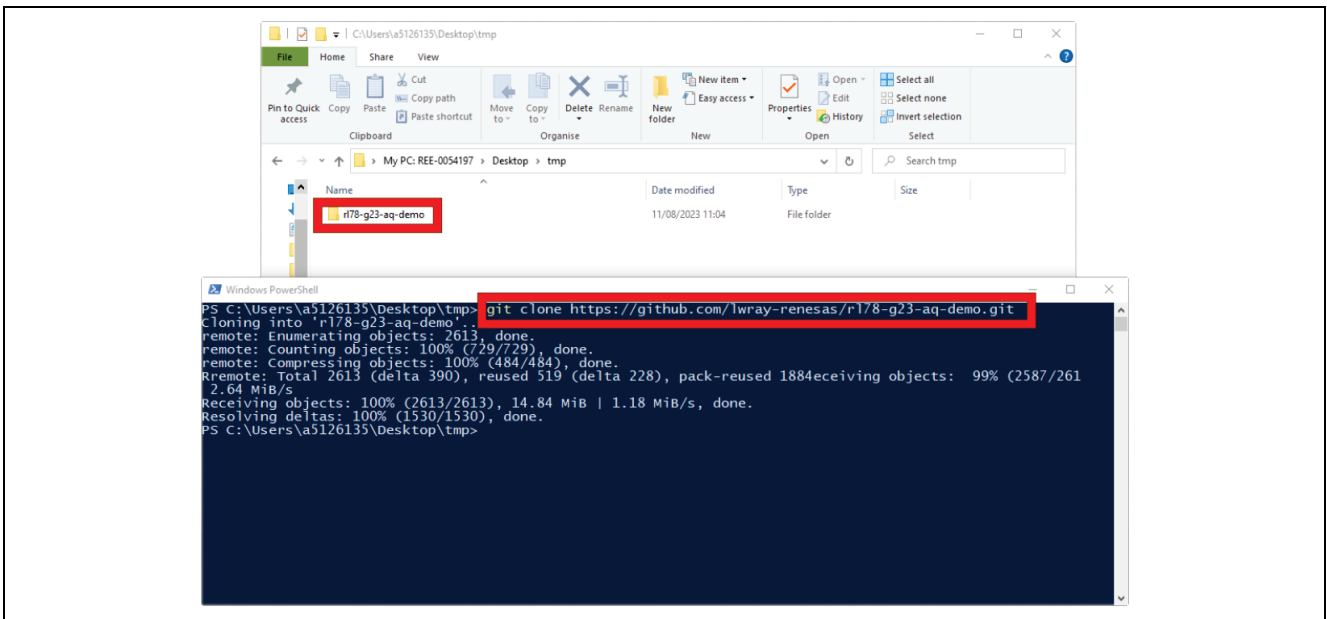
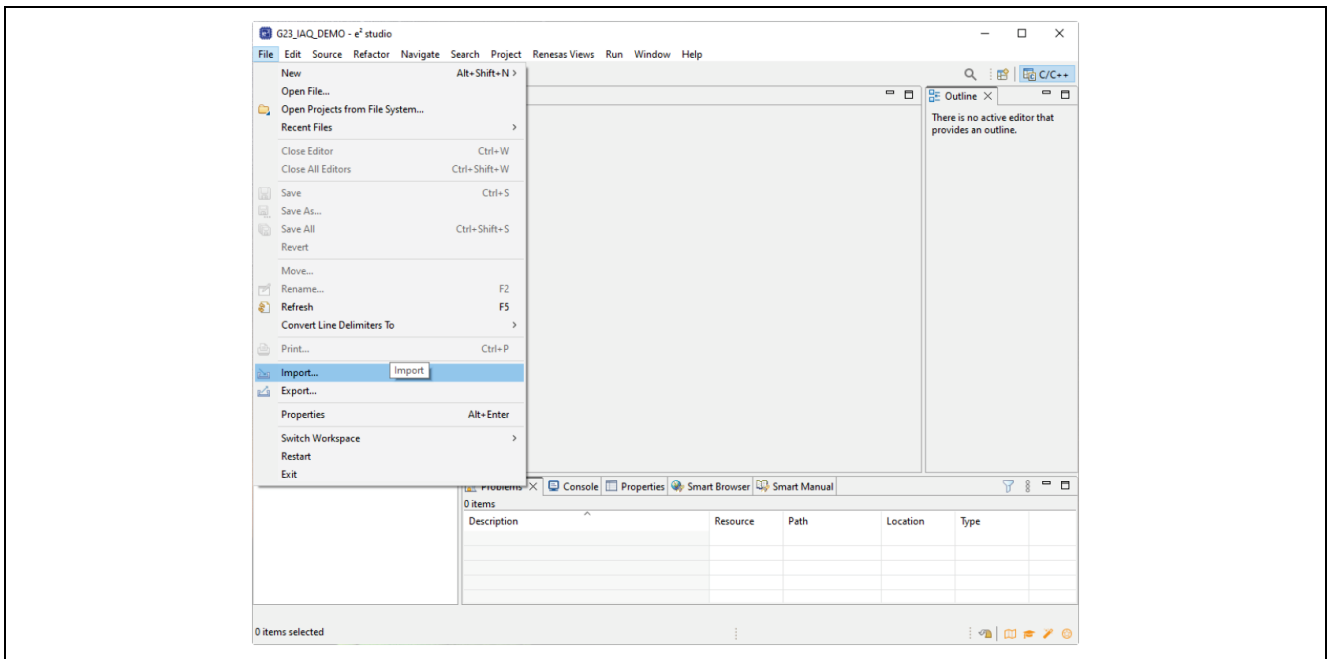

Figure 3. Project Clone



Now, import the project into your workspace using e<sup>2</sup> studio.

**[File] → [Import...]**



**Figure 4. Project Clone**

**[Existing Projects into Workspace] → [Next >]**

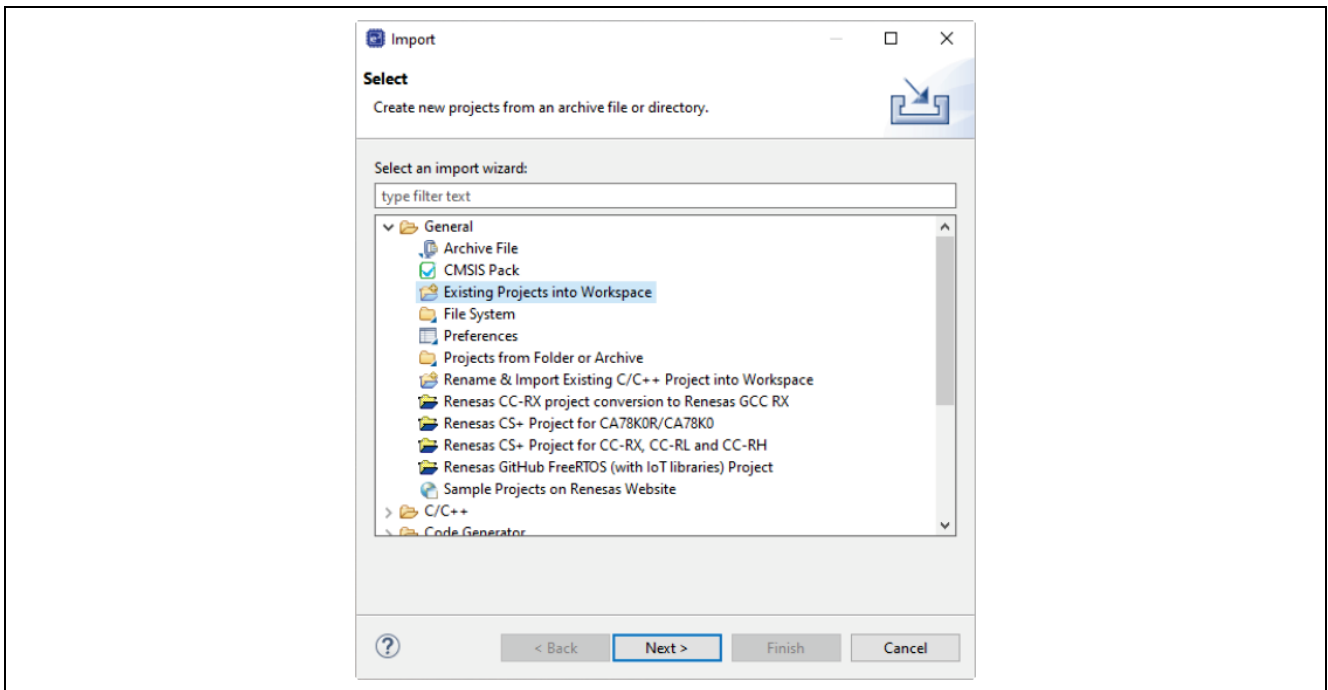

**Figure 5. Existing Projects into Workspace**

Navigate to the top-level project folder, select the project in the check box and enable **[Copy projects into workspace]** and click **[Finish]**.

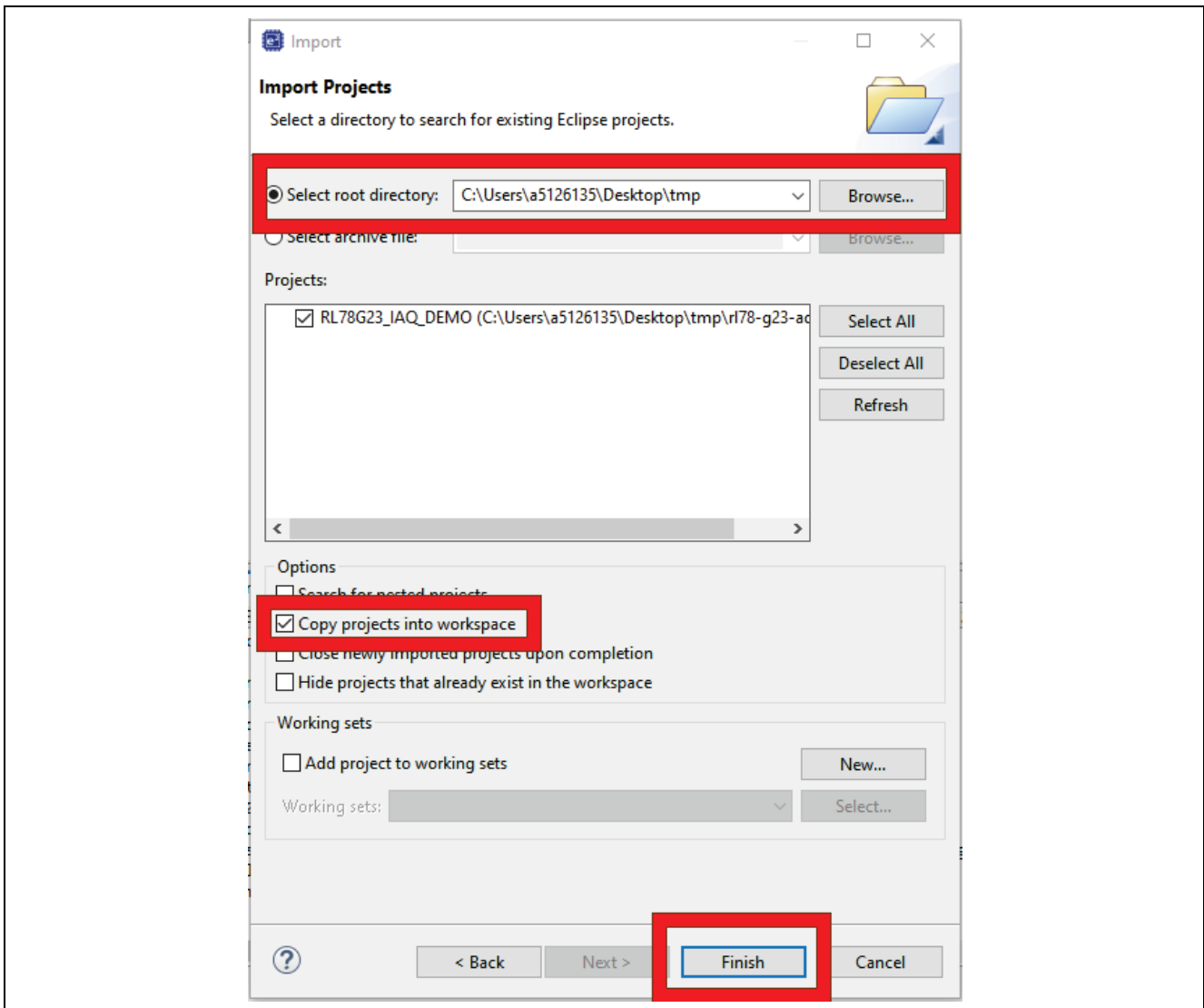



Figure 6. Import Dialog

## 2.2 Build

There are several ways to build a project.

- **[Right-click]** the project in the project explorer and select **[Build Project]** (Figure 7)
- **[Left-click]** the project to select it and press **[Ctrl + B]**
- **[Left-click]** the project and click  (Figure 8)

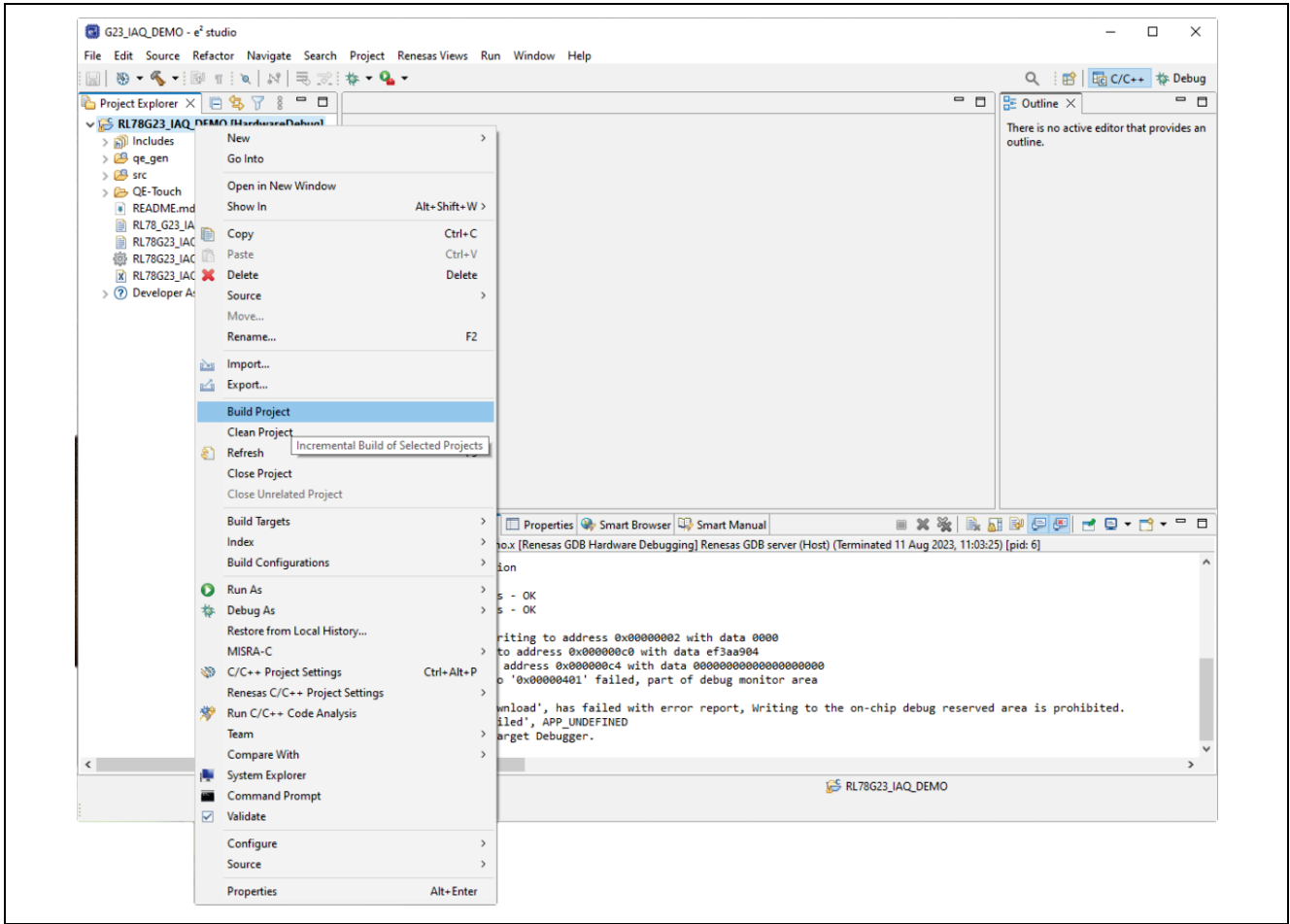

Figure 7. Build Method 1

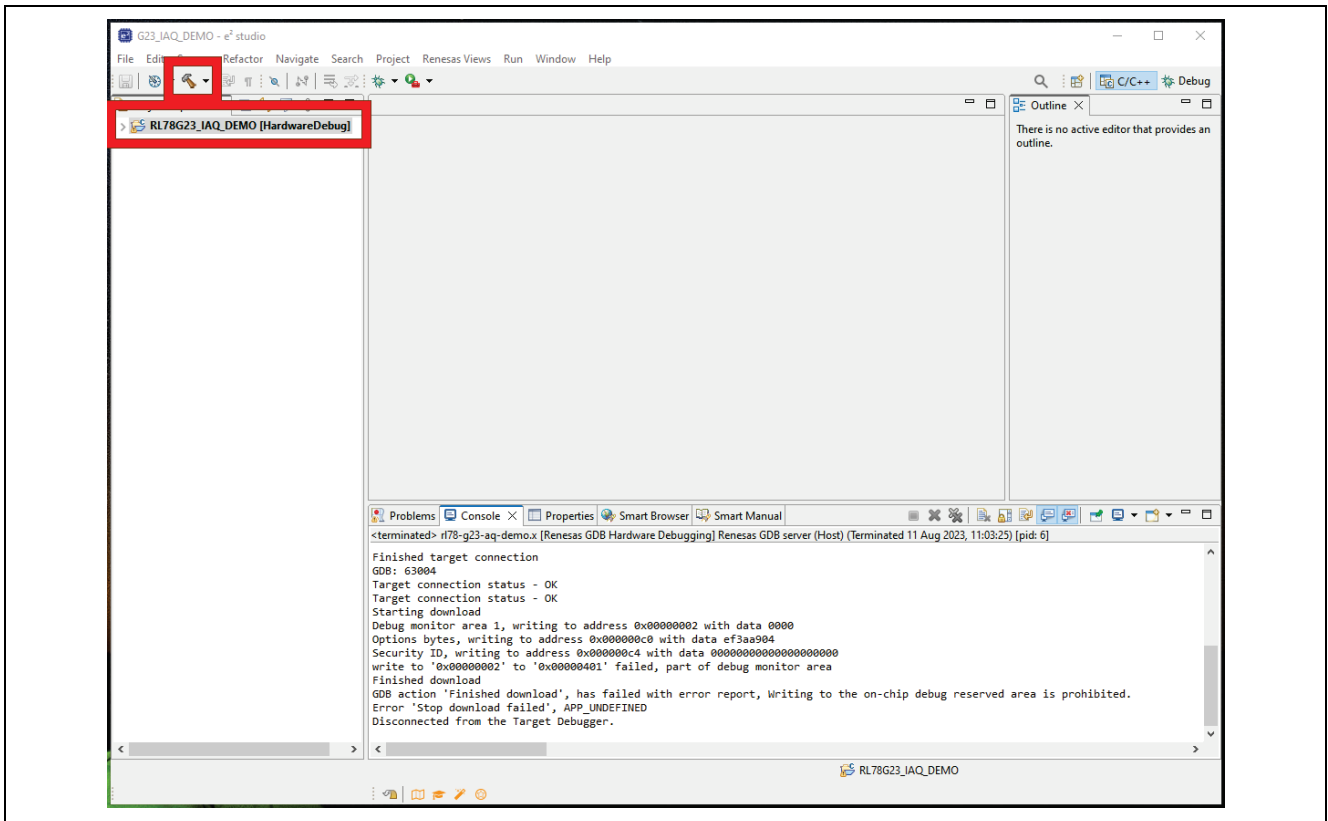

Figure 8. Build Method 3

These methods are functionally equivalent, the build output should then be as shown in Figure 9.

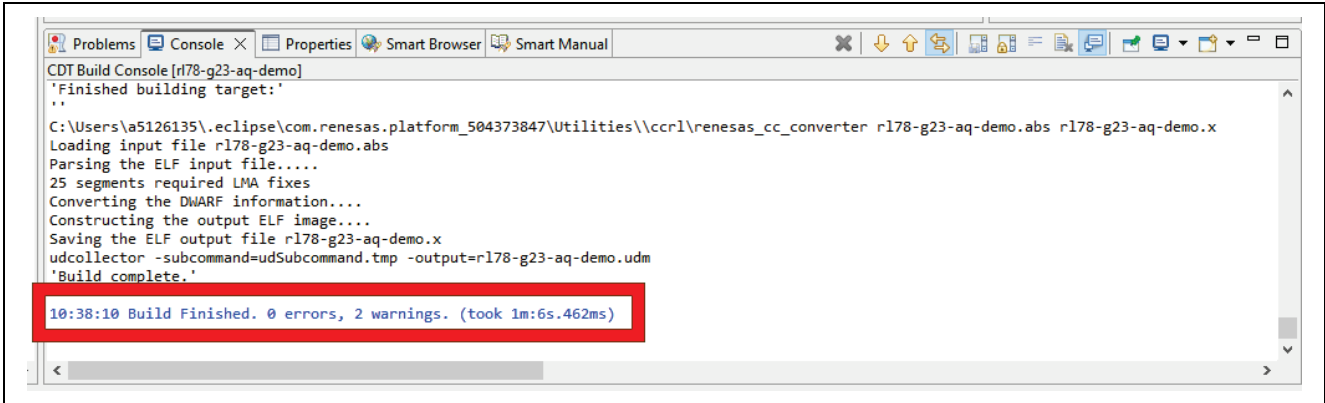

Figure 9. Build Output Console

### 2.3 Debug

To debug the project, the first time one launches you must do the following.

- Open the smart configurator file.
- Navigate to the system tab.
- Enable debug via E2 Lite
- Disable Trace function.
- Generate Code
- Build project.

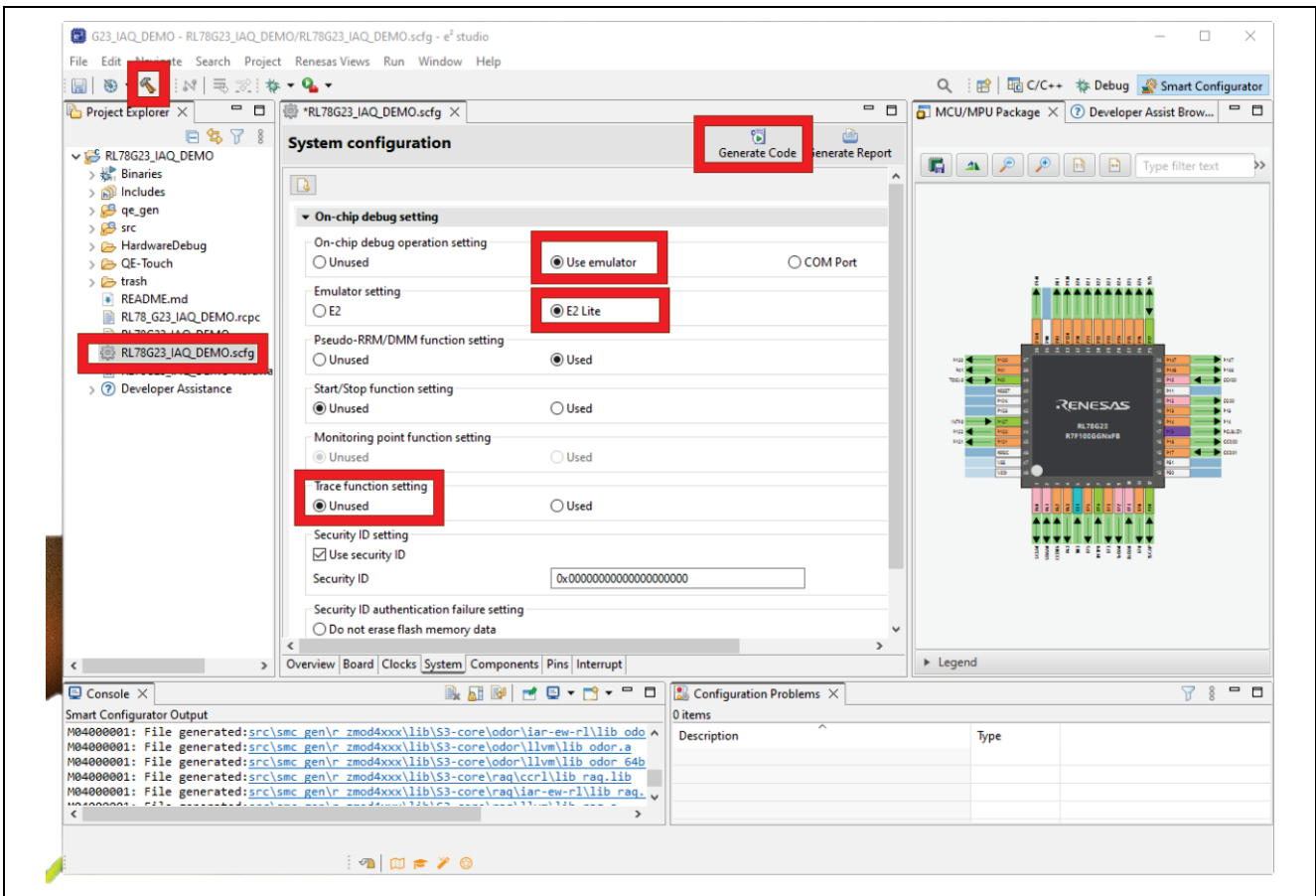

Figure 10. Enable On-chip Debug

Then follow the connection outline in section 3.2 Board. Then **[Right-click] the project → [Debug As] → [4 Renesas GDB Hardware Debugging]**

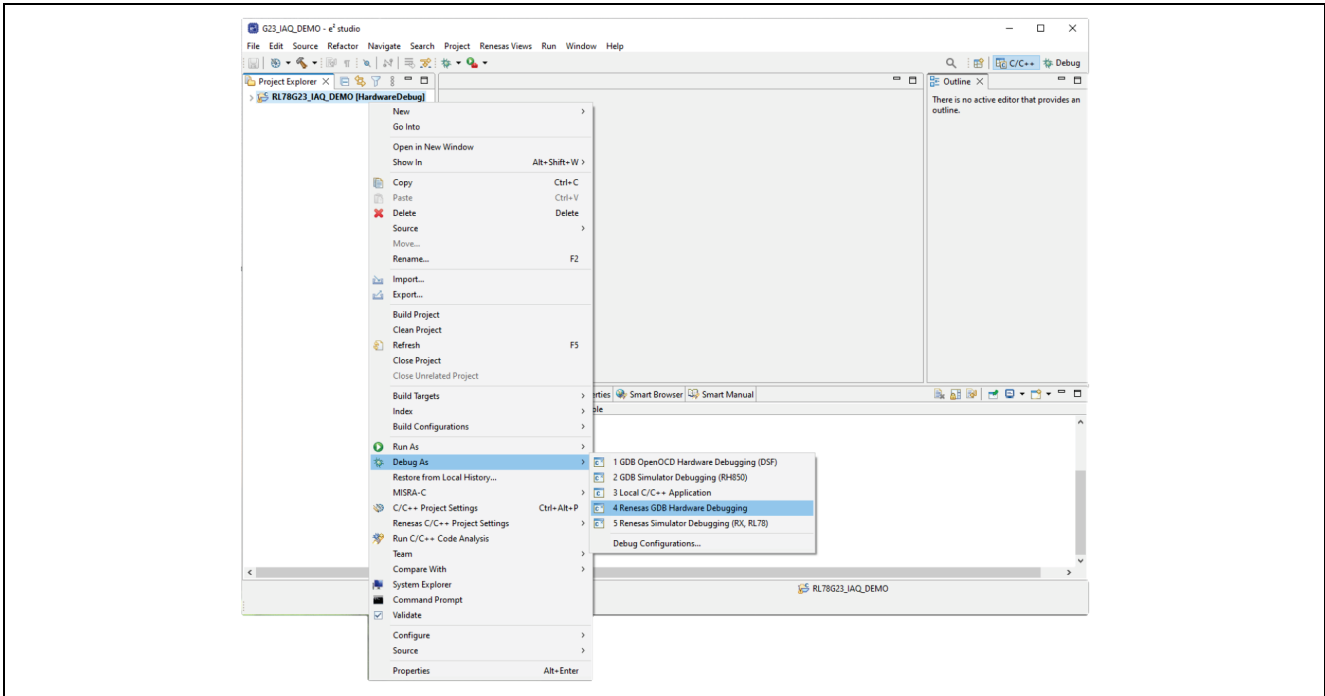

Figure 11. Start Debug First Time

Then select **E2 Lite (RL78)**.

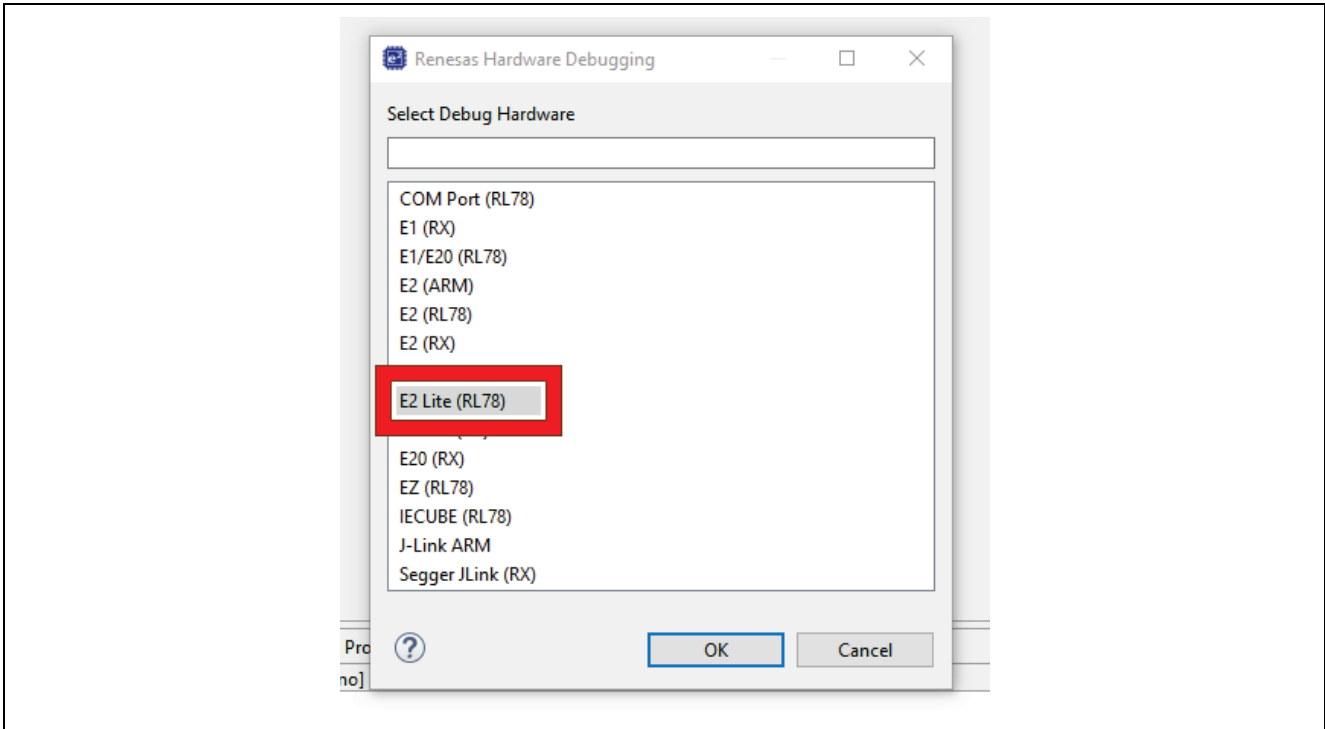
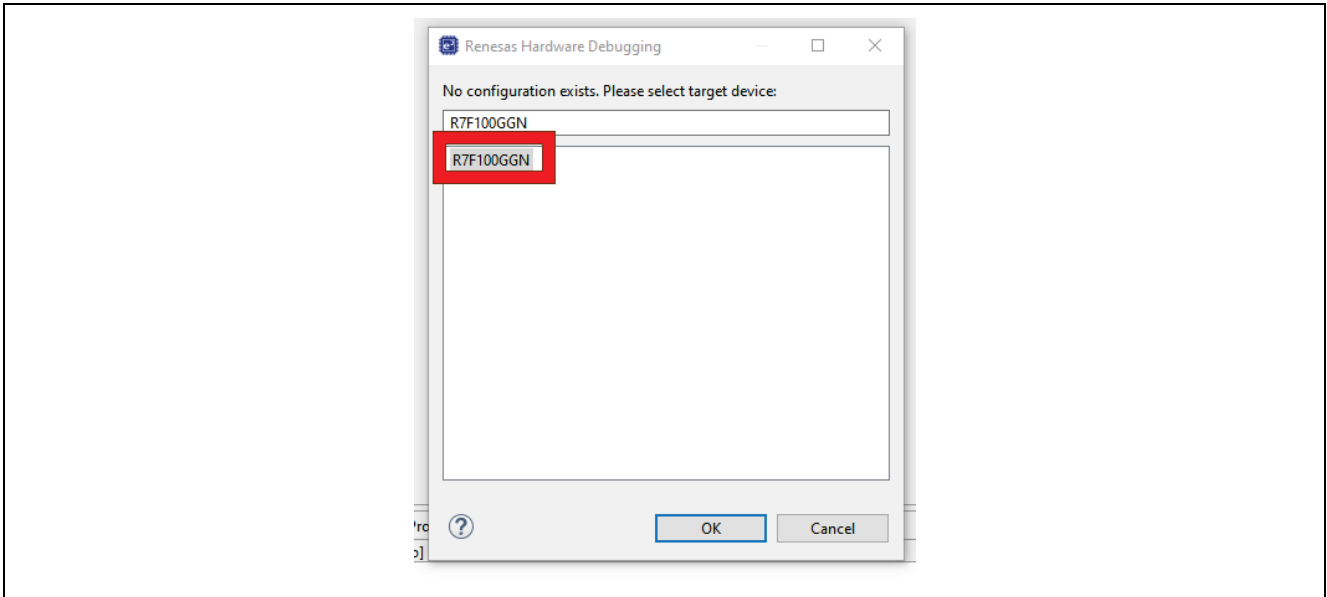



Figure 12. Select Debugger



Now select **R7F100GGN** as the device.

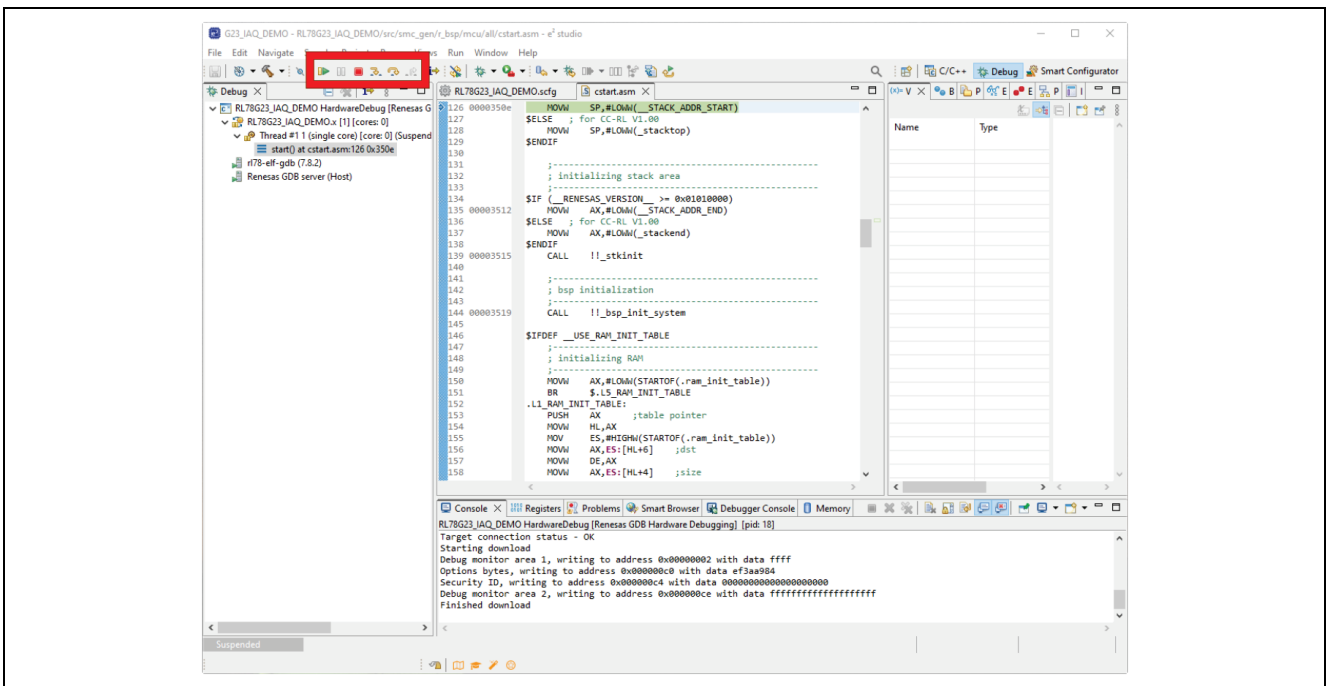

**Figure 13. Select Device**

Please note that after this first launch, you can simply [Left-click] the project to select it and click the debug icon .

After loading the binary onto the device e<sup>2</sup> studio will eventually pause execution on the reset vector, you can now debug the project as usual.

Run the application by clicking , the application will then run to main at which point you can click  again.



**Figure 14. Debug**

## 2.4 Troubleshooting

The following sub-sections outline the solutions to common issues found on the build and import of this project.

### 2.4.1 Error: Program “make” Not Found in Path

When this issue arises, the error message above it typically goes unnoticed – there is no toolchain configured for the project – this is shown in Figure 15.

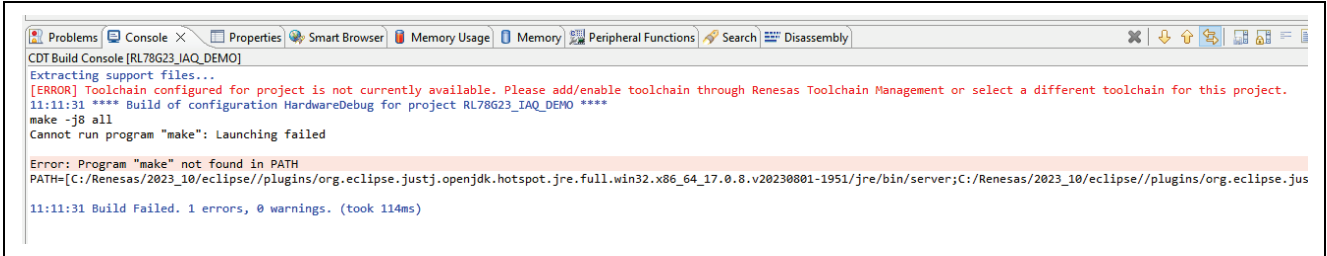

Figure 15. Toolchain Unavailable

To solve this [Right-Click] Project → Properties.

Select C/C++ Build → Settings and navigate to the Toolchain tab – here you will see the toolchain dropdowns are empty as shown in Figure 16.

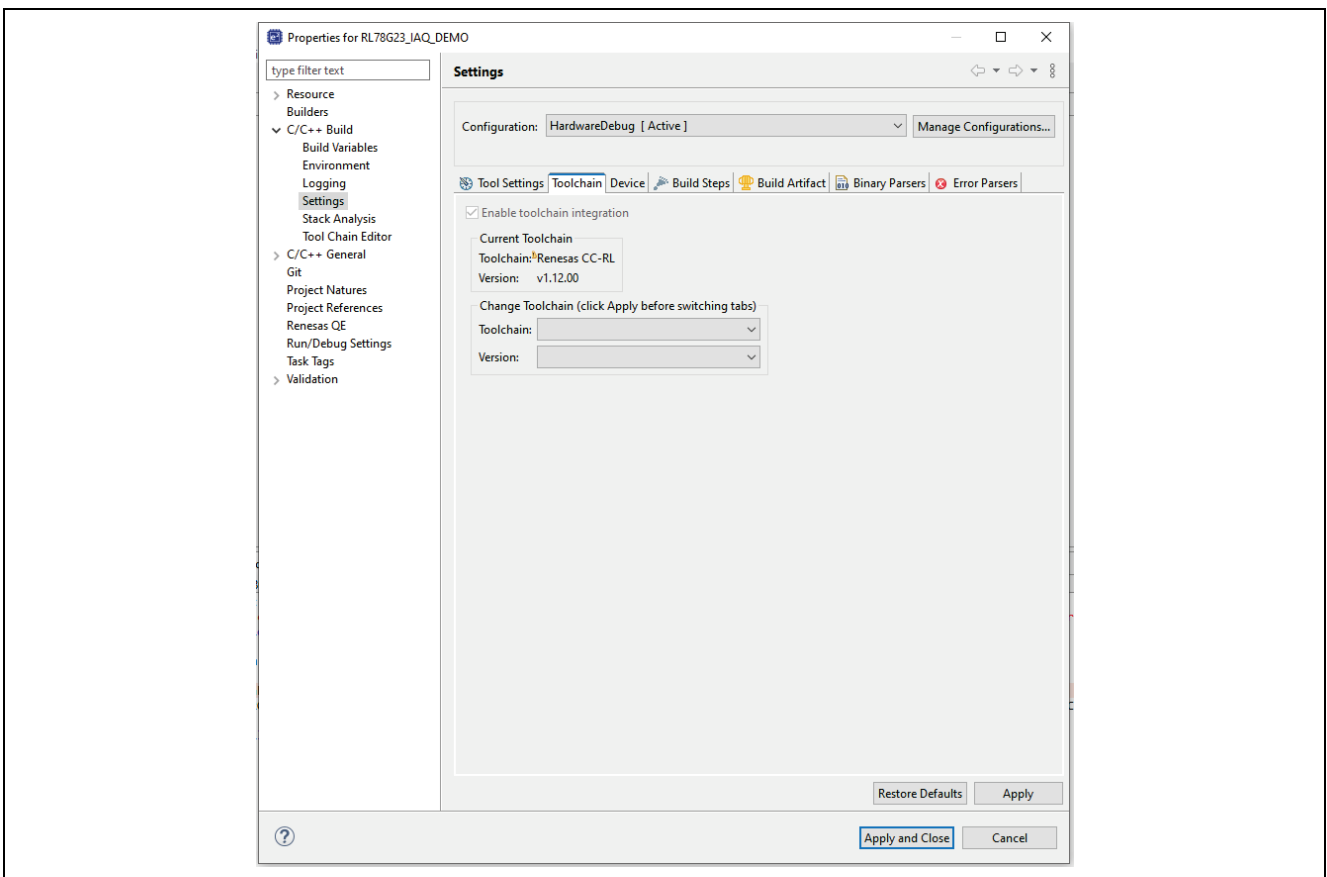

Figure 16. Empty Toolchain

To fix this problem, one should select Renesas CC-RL and the latest version of the compiler available in the respective drop downs, this is shown below in Figure 17.

Then click “Apply and Close”.

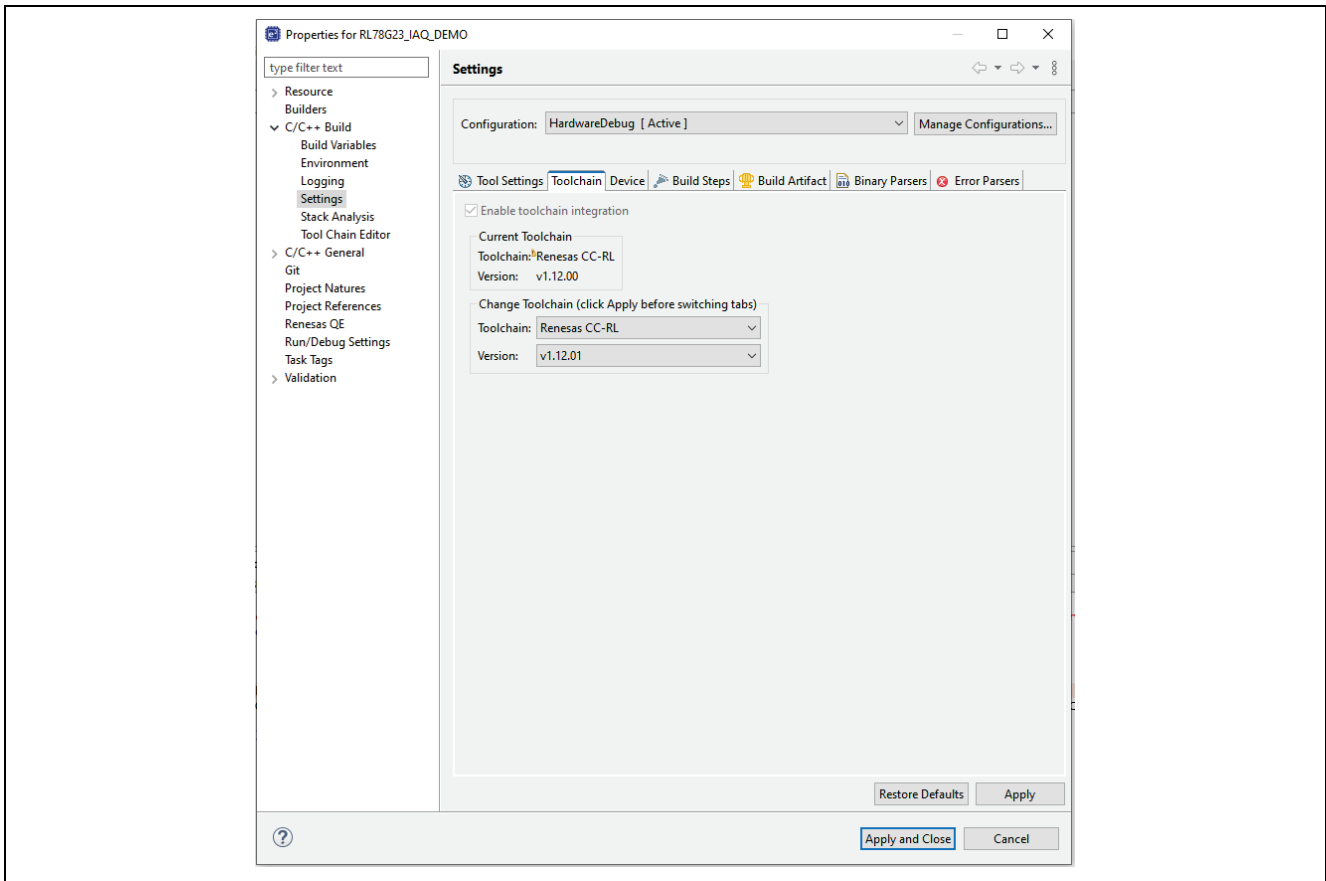

Figure 17. Populated toolchains

Now you can build the project successfully.

### 2.4.2 Undefined External Symbol / Missing Components SC

There are extra components required outside of the default e<sup>2</sup> studio installed components for the smart configurator which need to be included. This can be found when seeing the message “E0562310: Undefined external symbol” in the console as shown below.

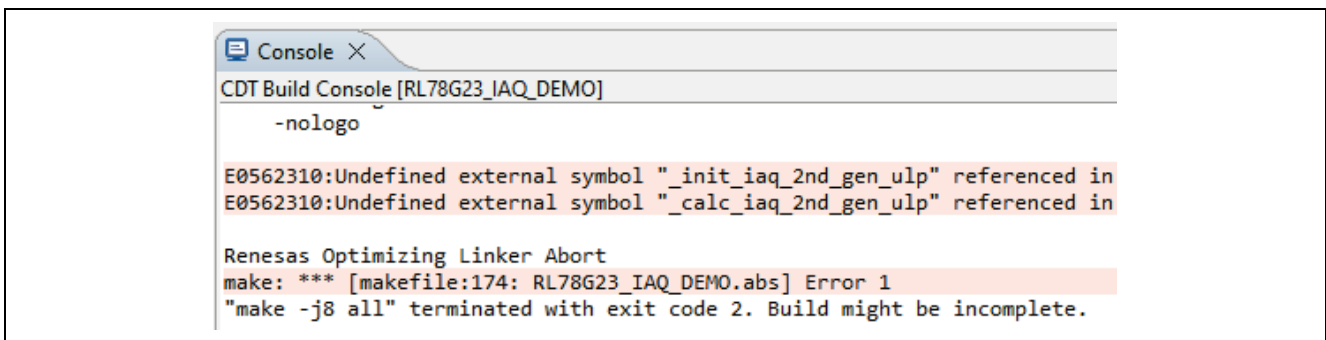

Figure 18. Undefined ZMOD Symbols

It can also be seen when observing the “greyed out” components in the **Components** tab of the smart configurator, shown below.



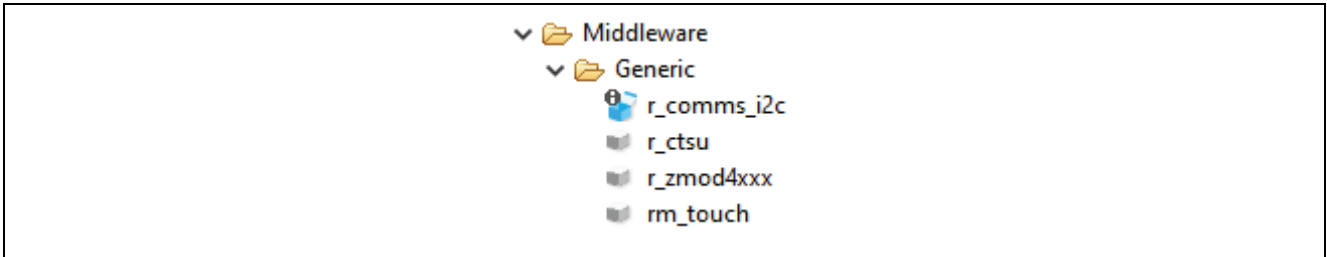

Figure 19. Greyed / Missing Components

To solve this problem, open the smart configurator and go to the **Components** tab, from here, select “Add Components”, shown in the figure below.

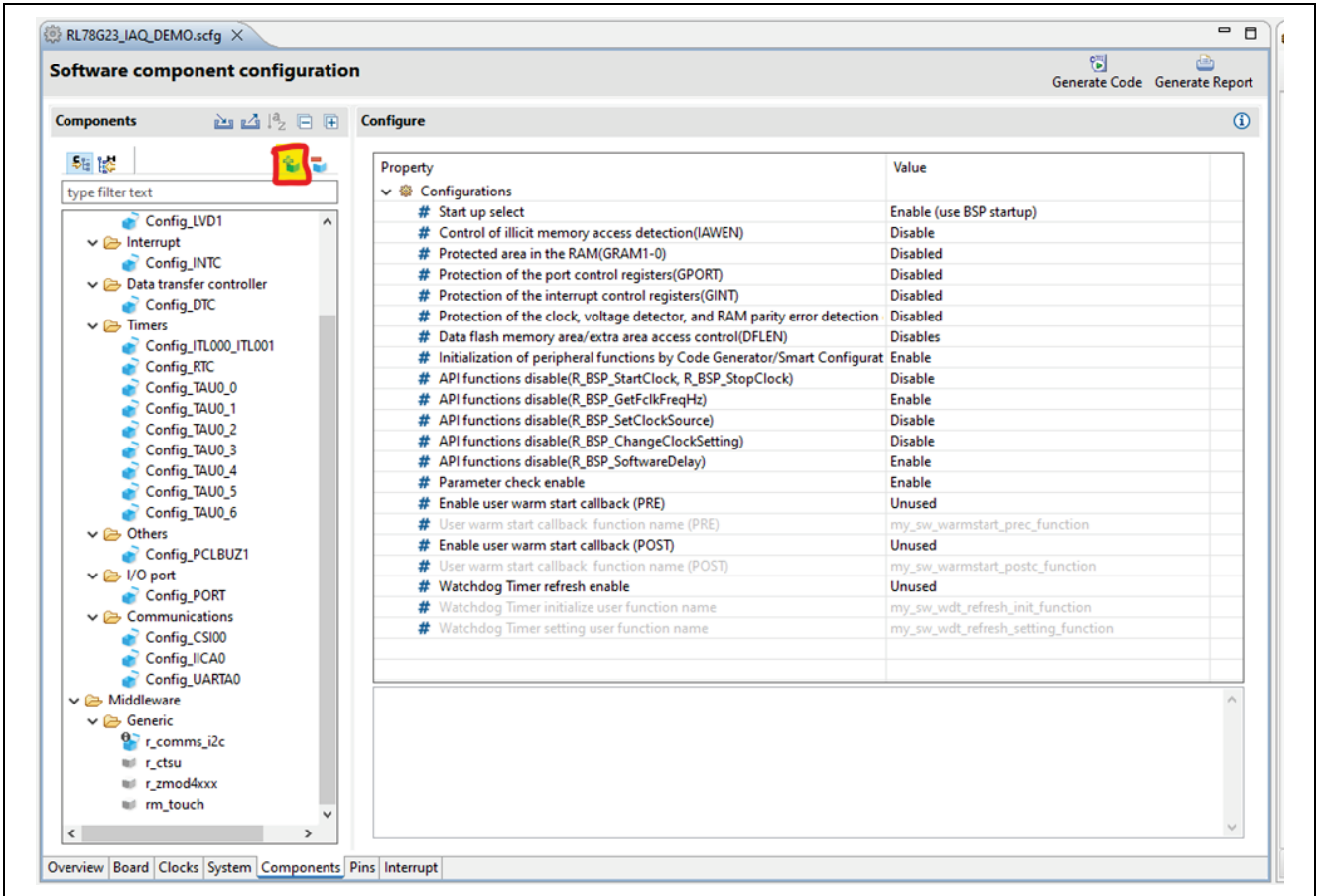

Figure 20. Add Component

From here, select “Download RL78 Software Integration System Modules” from the links as shown in the following figure.

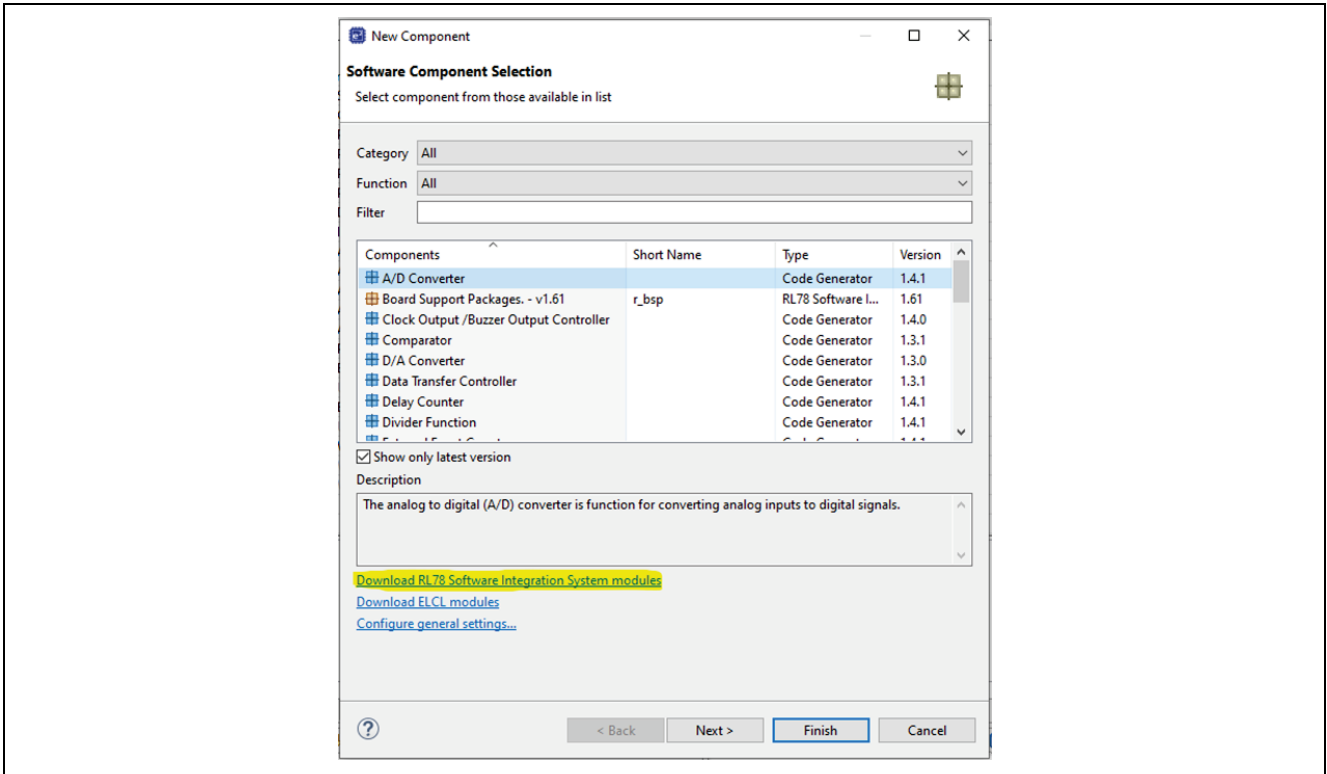

Figure 21. Download SIS Modules

Now Click **Select All** and **Download**.

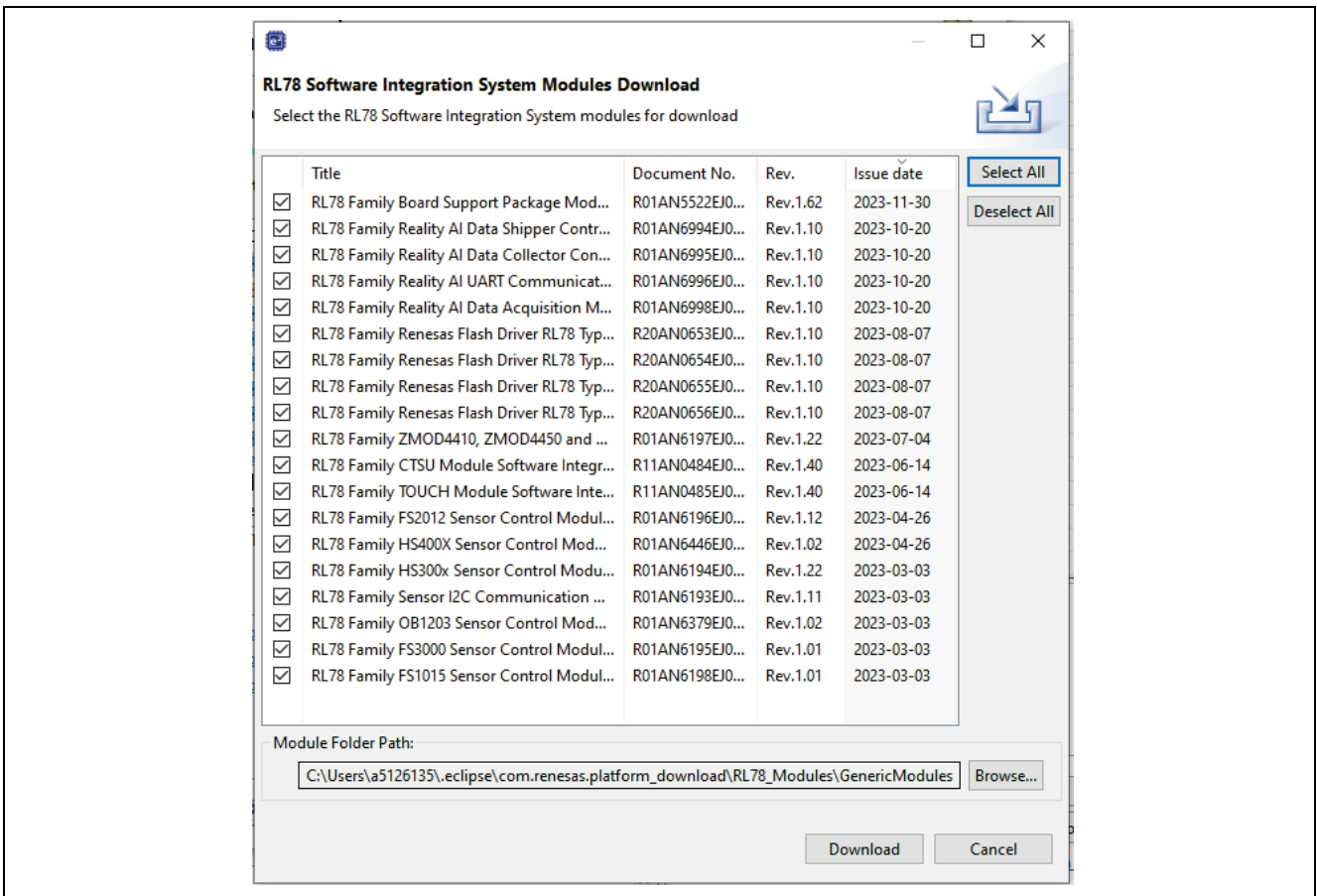

Figure 22. Select All and Download SIS Modules

Once the downloads are completed click **Cancel** on the Software Component Selection Dialog to exit.

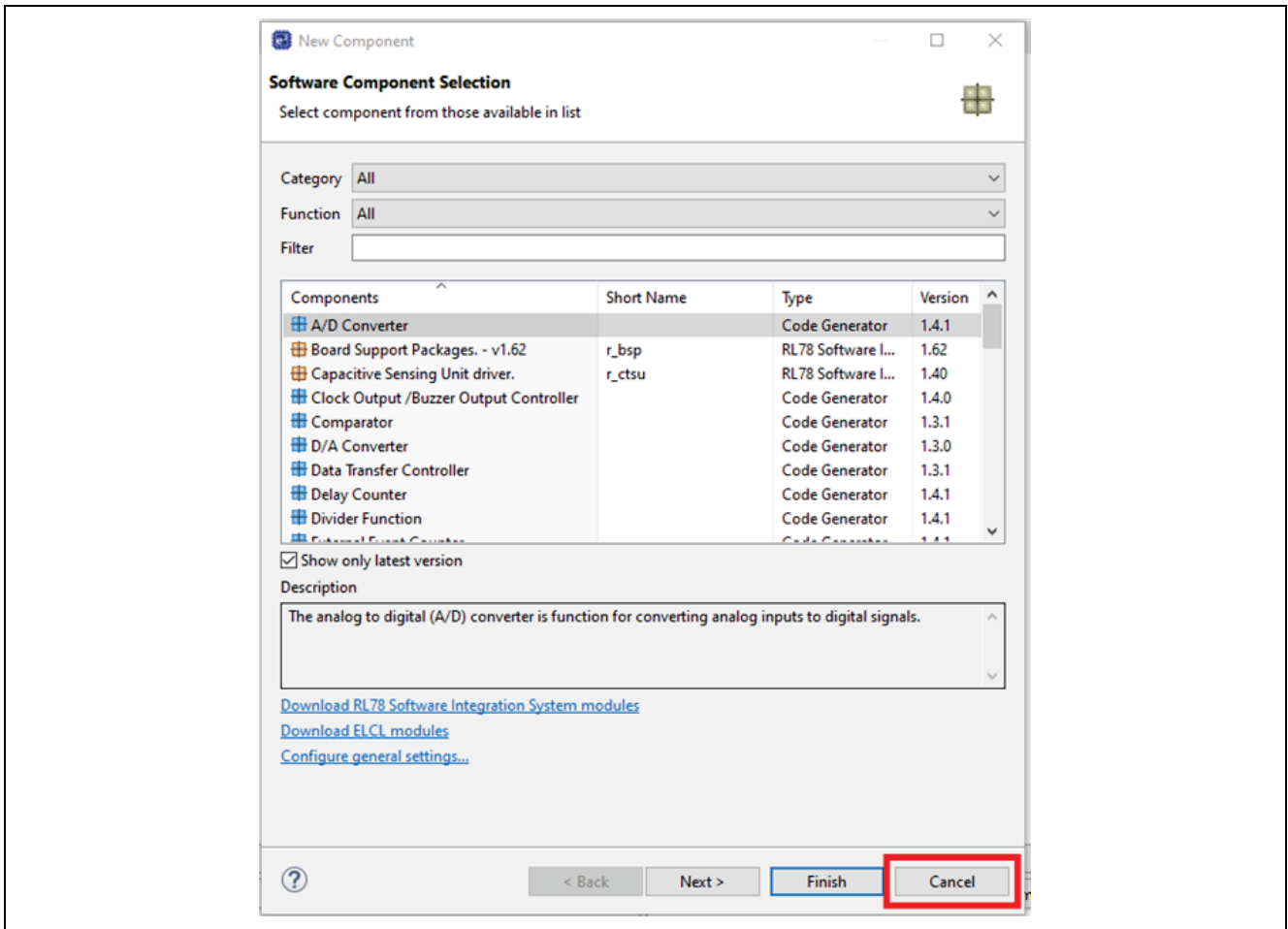

Figure 23. Exit Add Component

There may still be modules greyed out – this indicates you have obtained a newer version than the one used to write the original software – this is OK, we can simply update the modules to use the newest software. [Right-Click] each of the greyed-out modules and select the latest version as shown in the image below.

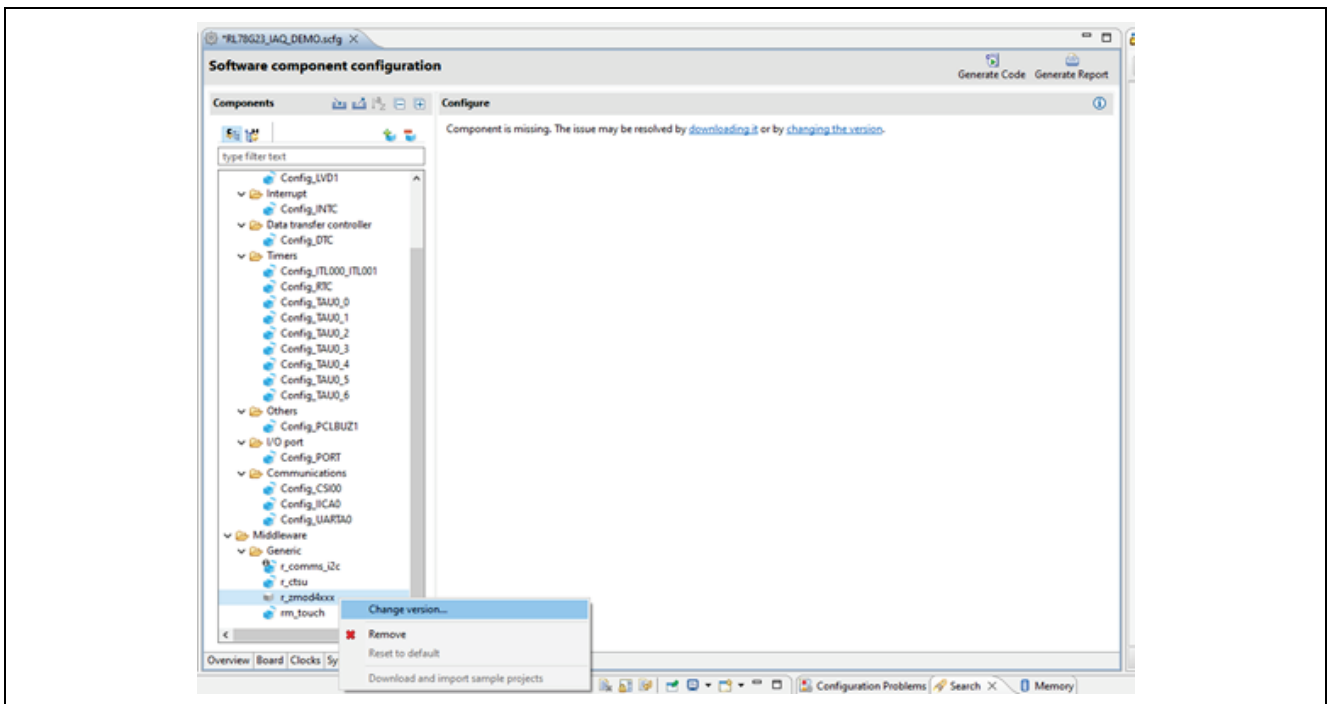

Figure 24. Update Versions

The dialogs simply explain the versions available as well as the differences between versions. Accept these changes by clicking **Next** and **Finish** in the dialog shown in Figure 25 and Figure 26.

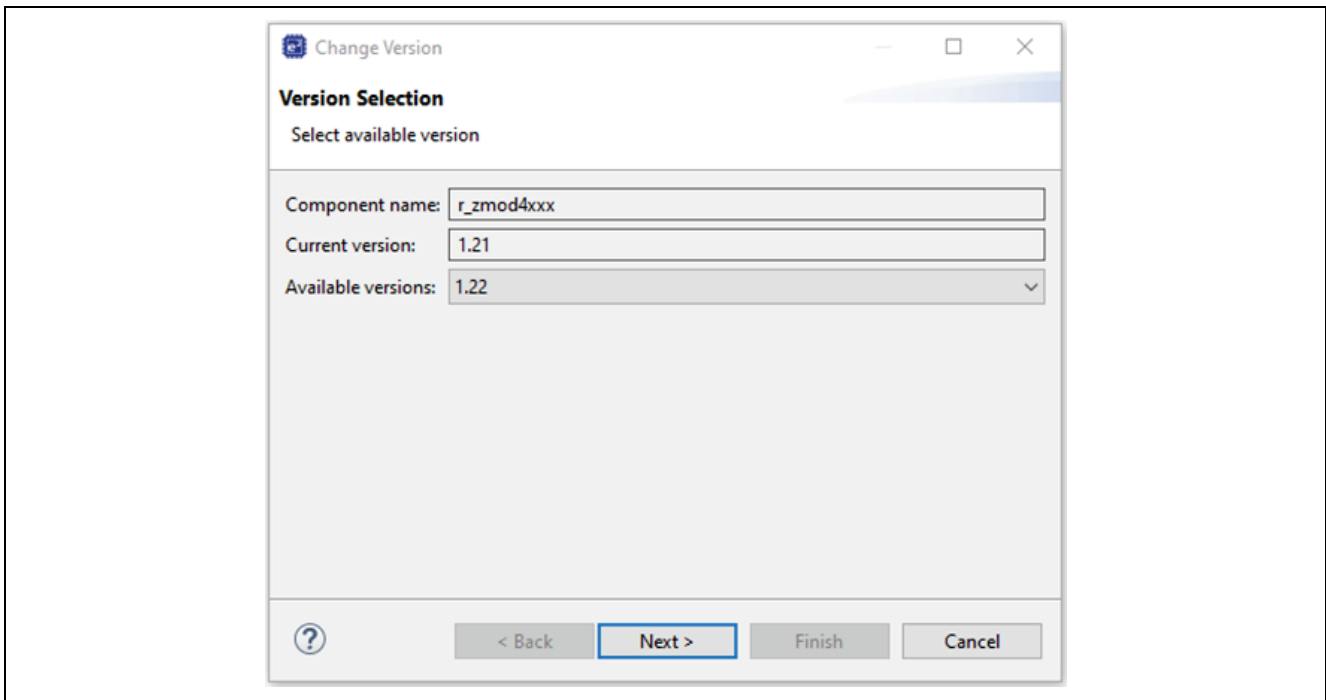

Figure 25. Version Select

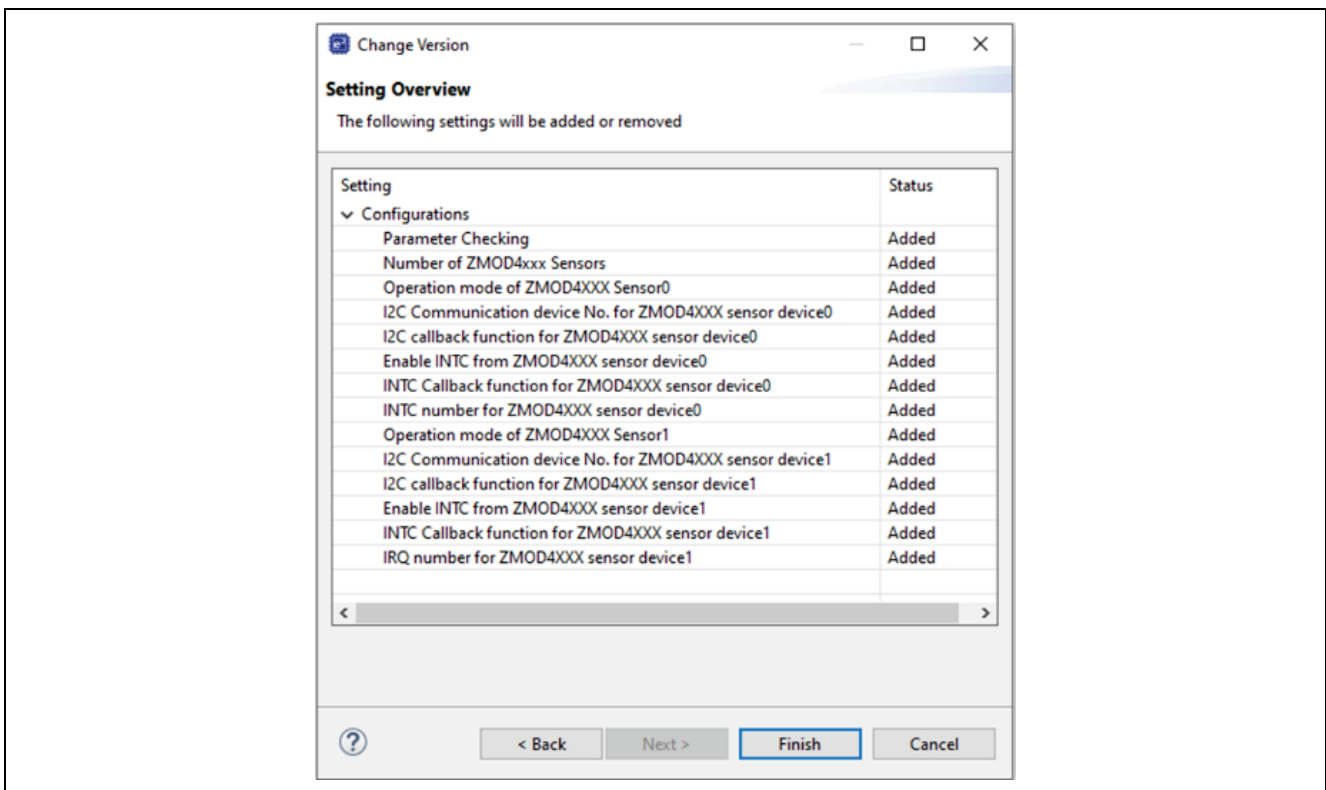

Figure 26. Change Overview

Now, click **Generate Code** in the top right of the smart configurator view shown in Figure 27.

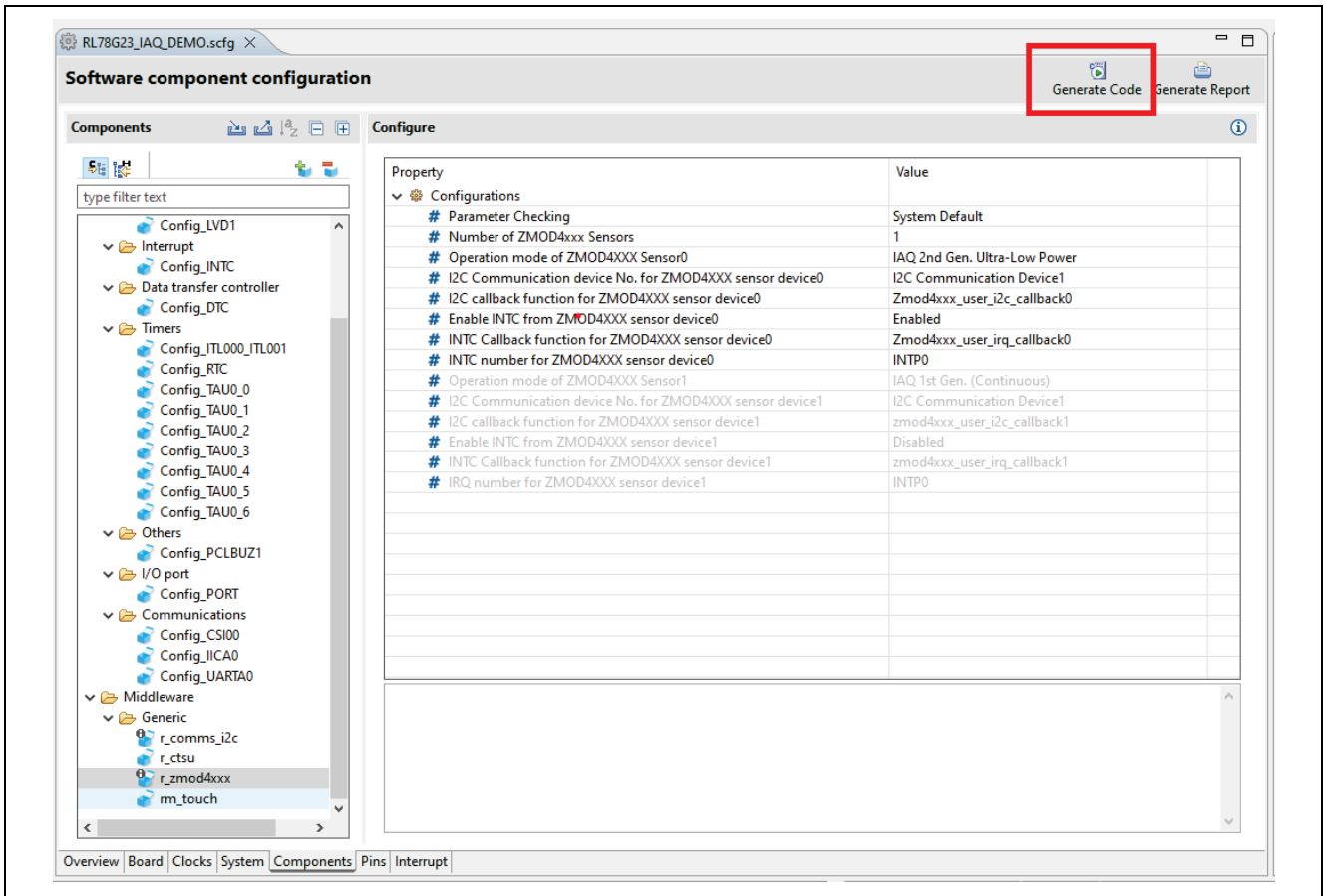

Figure 27. Generate Code

The application builds successfully as shown in the console image below.

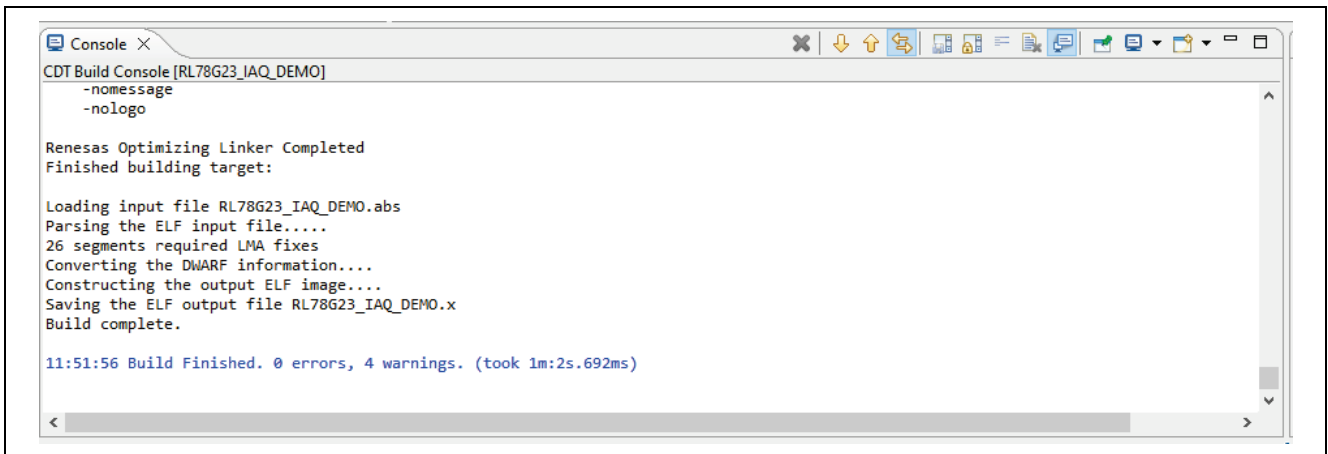

Figure 28. Successful Build

### 3. Hardware

The board consists of the following features, displayed in both Figure 29 and Figure 30.

**Table 1. Board Features**

Feature	Description
<b>RL78/G23</b>	A 16-bit microcontroller optimized for low-power applications and efficient performance. Part of the RL78 family, this MCU is equipped with versatile features suitable for a wide range of applications, from industrial to consumer electronics. It offers integrated peripherals, low power modes, and is recognized for its energy efficiency and compact design
<b>Capacitive Proximity Electrode</b>	A sense electrode connected to the CTSU2L peripheral of the RL78/G23 that detects the presence or absence of an object based on capacitive changes. Here, it is used for detecting proximity of user hand.
<b>Rotary Encoder</b>	An input device that provides rotational feedback in the form of two out-of-phase pulse trains, with included push switch function – here it is connected to the ELCL of the RL78/G23 which decodes the quadrature output and its direction.
<b>SPI LCD</b>	A small liquid crystal display with a resolution of 80x160 pixels, capable of displaying 16-bit RGB colour. Communicates with devices through the Serial Peripheral Interface (SPI) protocol. Ideal for compact graphical interfaces.
<b>RB LED</b>	A Light Emitting Diode that emits both red and blue colors.
<b>Buzzer</b>	An audio signalling device, driven by the RL78/G23 PCLBUZ output.
<b>HS4001</b>	A sensor module designed to measure both relative humidity and temperature in an environment. Provides digital output and is often integrated into HVAC systems, weather stations, or smart home devices to monitor and adjust environmental conditions.
<b>ZMOD4410</b>	A compact module designed to measure a range of volatile organic compounds (VOCs) and offer indications of indoor air quality. Commonly integrated into smart home systems, air purifiers, and HVAC to monitor and improve indoor air conditions.
<b>12 Pin PMOD UART</b>	Standardised 12-pin interface (Digilent) designed for peripheral module connections, here intended for use with the DA16200 Wi-Fi PMOD (US159-DA16200MEVZ).
<b>E2 lite Debug Connector</b>	A proprietary connector used for debugging and programming purposes, specifically designed for compatibility with the E2 lite debugger.
<b>Current Measurement Header</b>	A dedicated connector that allows for the easy connection of current measurement devices such as ammeters or multimeters.
<b>2x AAA Battery Holder</b>	A holder or compartment designed to securely fit two AAA batteries.

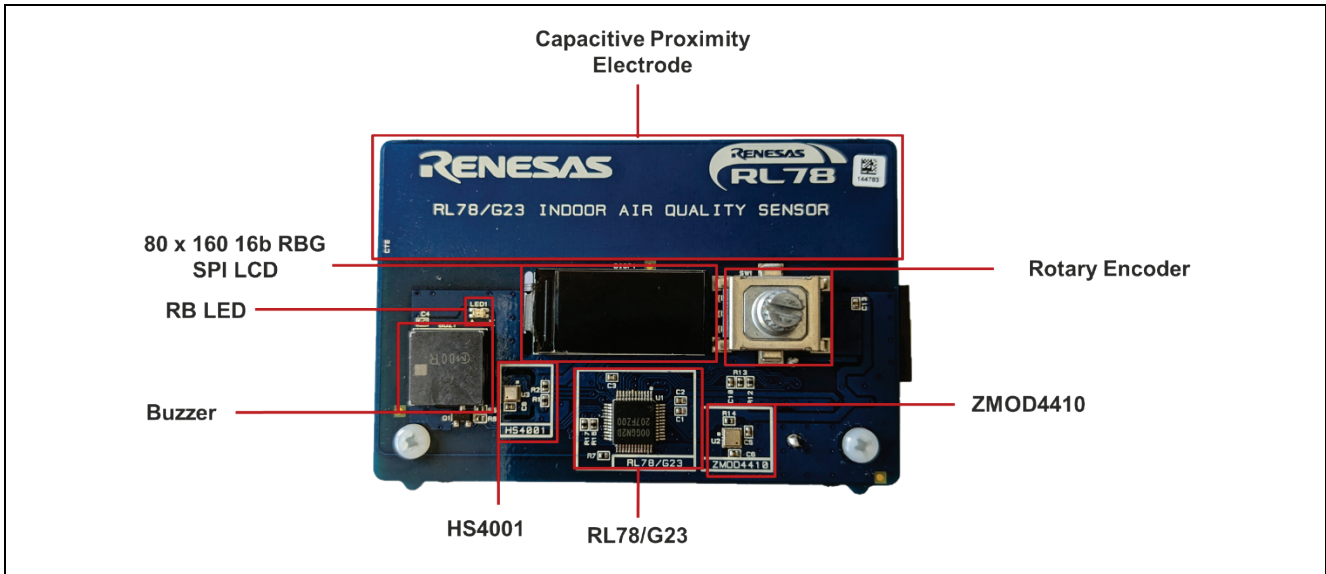

Figure 29. RL78/G23 Indoor Air Quality Demo PCB – Front

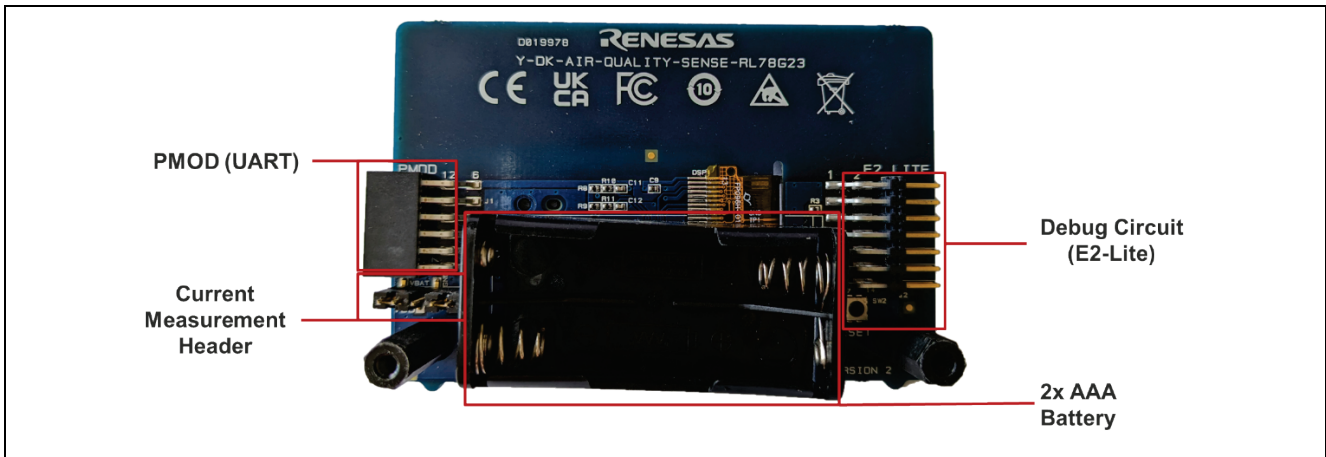

Figure 30. RL78/G23 Indoor Air Quality Demo PCB – Back



### 3.1 Powering the Board

The system is powered directly from two AAA batteries. There is no need for on-board regulation due to the wide operating voltage of the RL78/G23. Power is separated into three nets:

- VBATT – battery voltage.
- VDD – system supply rail.
- VDD\_RL78 – MCU supply rail.

Using H1 (shown below), current/power measurement equipment can be connected to monitor system or MCU current/power consumption.

To power the device in demonstration application, configure the jumpers as follows:

- Short positions 1-2.
- Short positions 4-5.

This is shown in Figure 31.

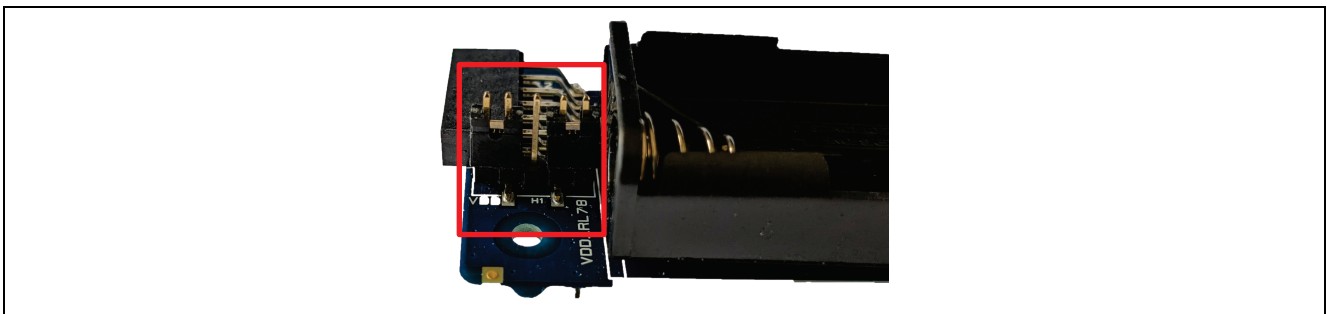

Figure 31. H1 Settings

The pinout for H1 is designed as follows:

- Pins 1 and 2 are connected to VBATT and VDD respectively.
- Pin 3 is designated for ground.
- Pins 4 and 5 are connected to VDD\_RL78 and VDD respectively.

This configuration facilitates the shorting of pins 1 and 2, as well as pins 4 and 5, allowing the batteries to power the entire system, including the microcontroller. Alternatively, pins 1 and 2 or pins 4 and 5 can be opened and linked to monitoring tools (ammeter, multimeter and so forth) – this also enables external power supplies for connection, enabling power monitoring circuitry to be connected in source mode.

This can be seen in Figure 32.

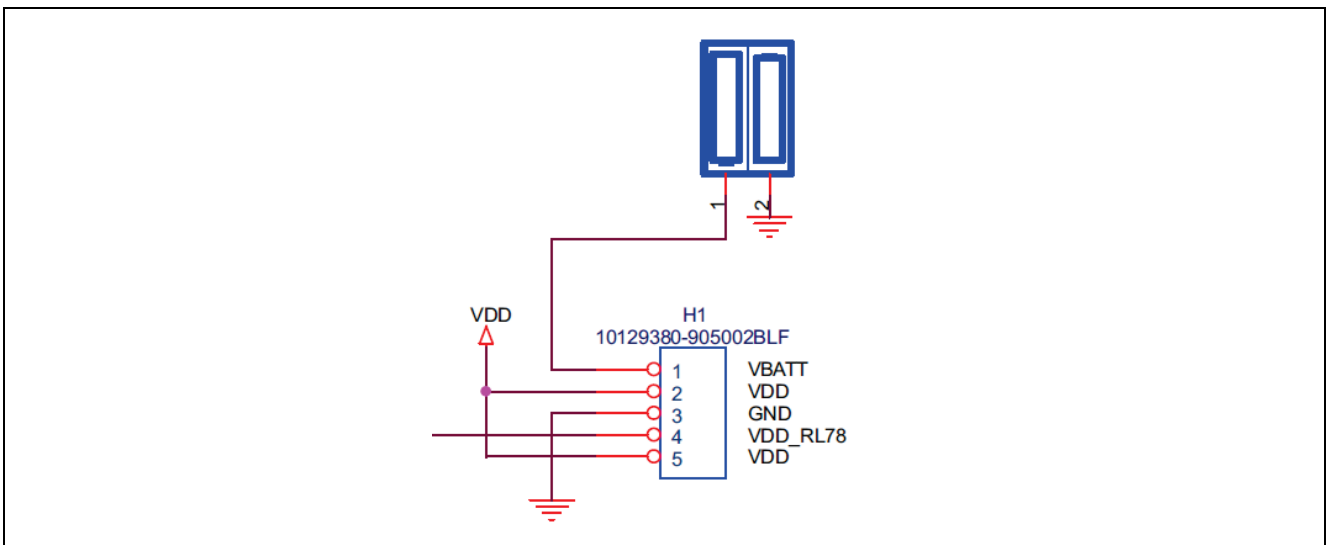

Figure 32. H1 Schematic



Figure 33 shows the insertion of the two AAA batteries required to power the system standalone.



Figure 33. Batteries

### 3.2 Programming and Debugging the Board

Programming and debugging functions are provided through the E2-Lite interface. The connection is shown in Figure 34.

Power can be supplied by the emulator, batteries or through H1.

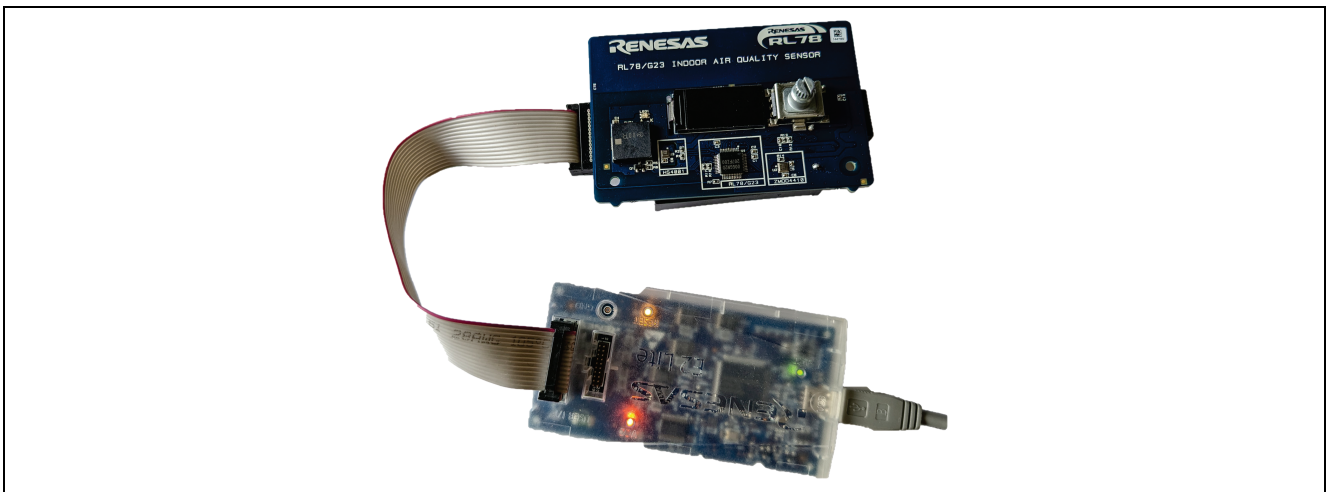

Figure 34. E2-Lite Connection

### 3.3 Capacitive Proximity Electrode

The capacitive proximity electrode is approximately 83 mm x 19 mm copper electrode. It is surrounded by a keep-out area of approximately 5 mm. When designing proximity electrodes for sensing objects at short to medium distances from the electrode's surface, the electrode's size plays a pivotal role. Specifically, increasing the surface area of the electrode enhances the system's sensitivity distance. This principle is showcased in this design, where every effort has been made to maximize the use of available PCB real estate to increase the electrode's surface area.

Figure 35 shows the electrode, along with the trace connecting it to the MCU, having the designated 'keep-out' area of 5 millimeters, isolating it from other active signals. Astute observers may see fiducial copper located both at the center of the PCB and footprint of the rotary encoder. The latter is used for mechanical stability of the rotary encoder but is not associated with any active electrical signals. Although these areas are within the 5 millimetre clearance, the decision to permit these intrusions was taken to maintain a compact PCB design. Ideally, such areas would not be present; however, since they are not electrically active, they present a minimal risk to signal integrity.

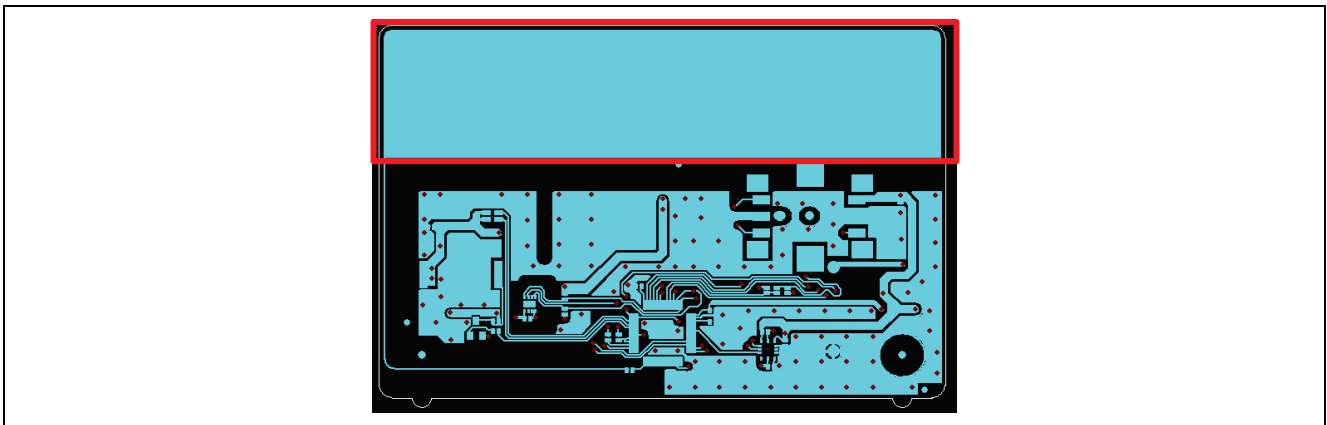

Figure 35. Electrode Design

## 4. Software

This section provides a deep dive into the pre-loaded demonstration software.

### 4.1 Startup

The startup sequence is divided into two portions. First the C runtime setup and peripheral initialization, second the application initialization and peripheral startup. Figure 36 shows these two separate startup sequences.

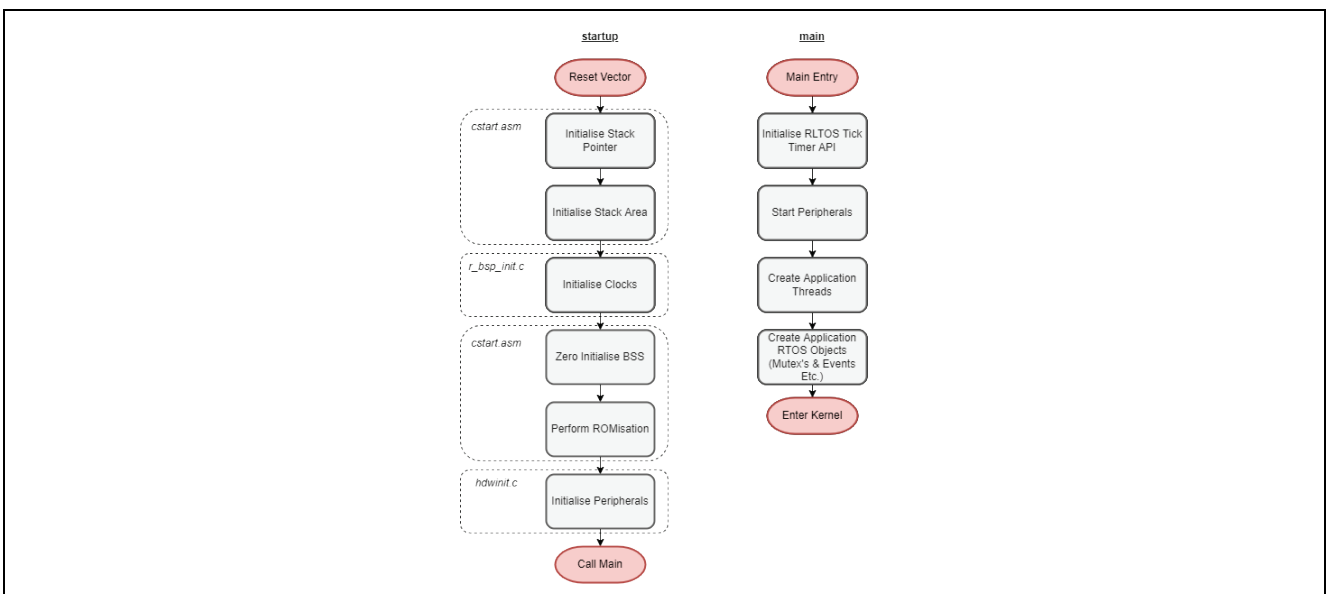

Figure 36. Device Startup Sequence

## 4.2 Architecture

The architecture covers the structure of the project, event handling and propagation and task scheduling.

### 4.2.1 Structure

The project structure can be seen in Figure 37.

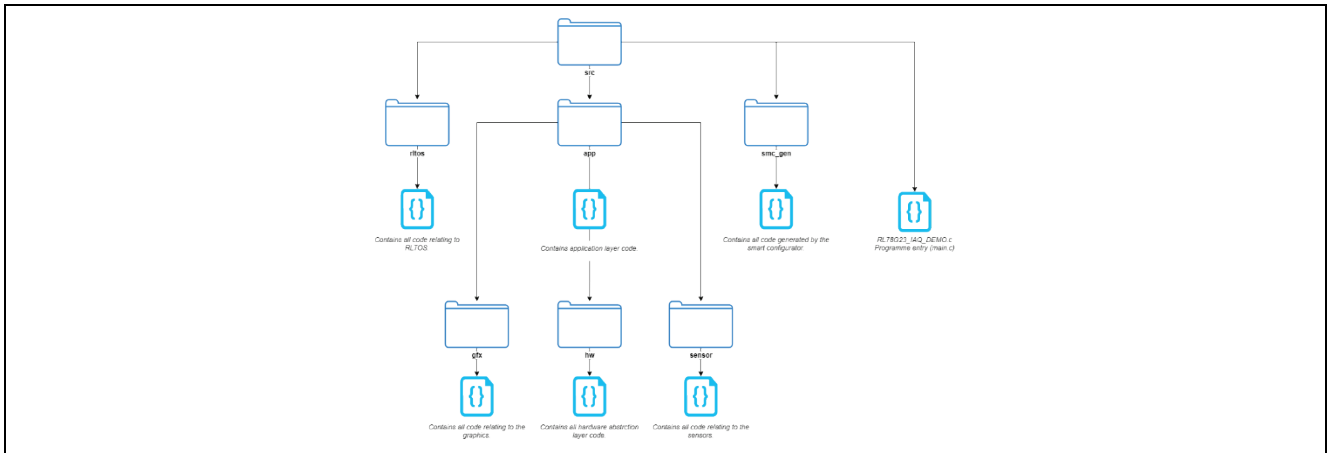

Figure 37. Project Folder Structure

### 4.2.2 Event Handling

The demonstration software is wholly event driven – all events originate from hardware, that is, peripherals and I/O. These events then propagate to the event thread.

The event thread subsequently manages the system state and instructs (messages) the GUI thread to control what is displayed. This is illustrated in Figure 38.

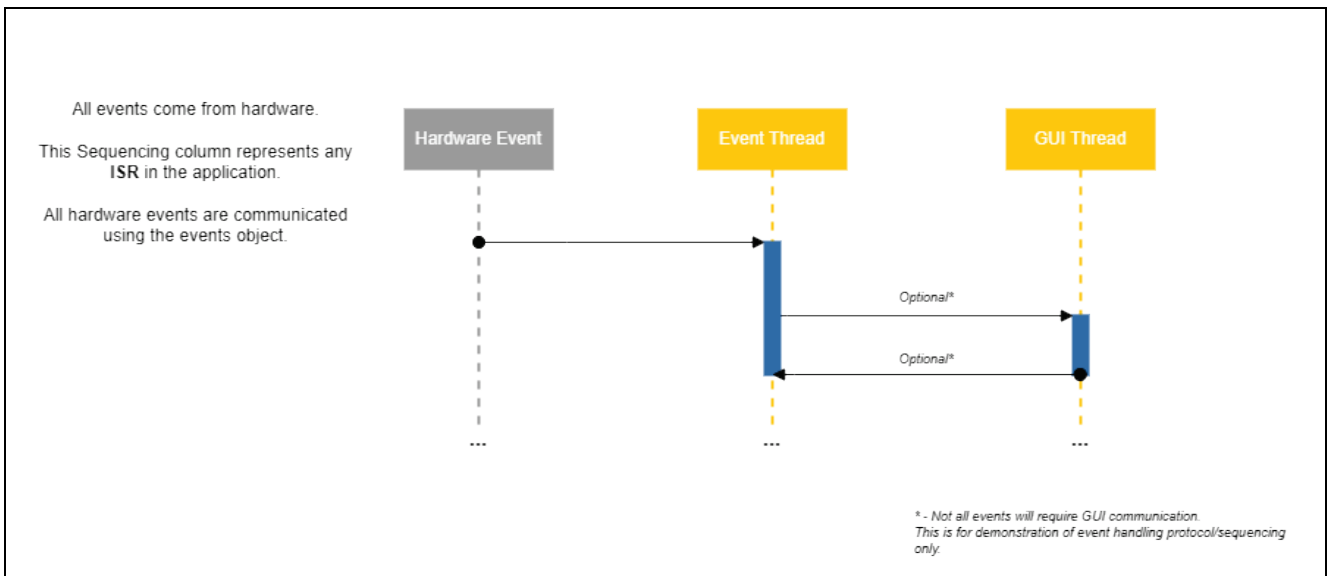

Figure 38. Event Propagation

### 4.2.3 Task Scheduling

The demonstration software uses a custom preemptive task scheduler called rtos. A tick period of 50 ms is defined and this is driven by TAU02 – there are two threads and several IPC (Inter Process Communications) objects used, all of which will be covered in this sub section.

The task scheduler is available and documented separately on [GitHub](#).

4.2.3.1 GUI Thread

The GUI thread handles all display drawing and the display state (asleep vs awake).

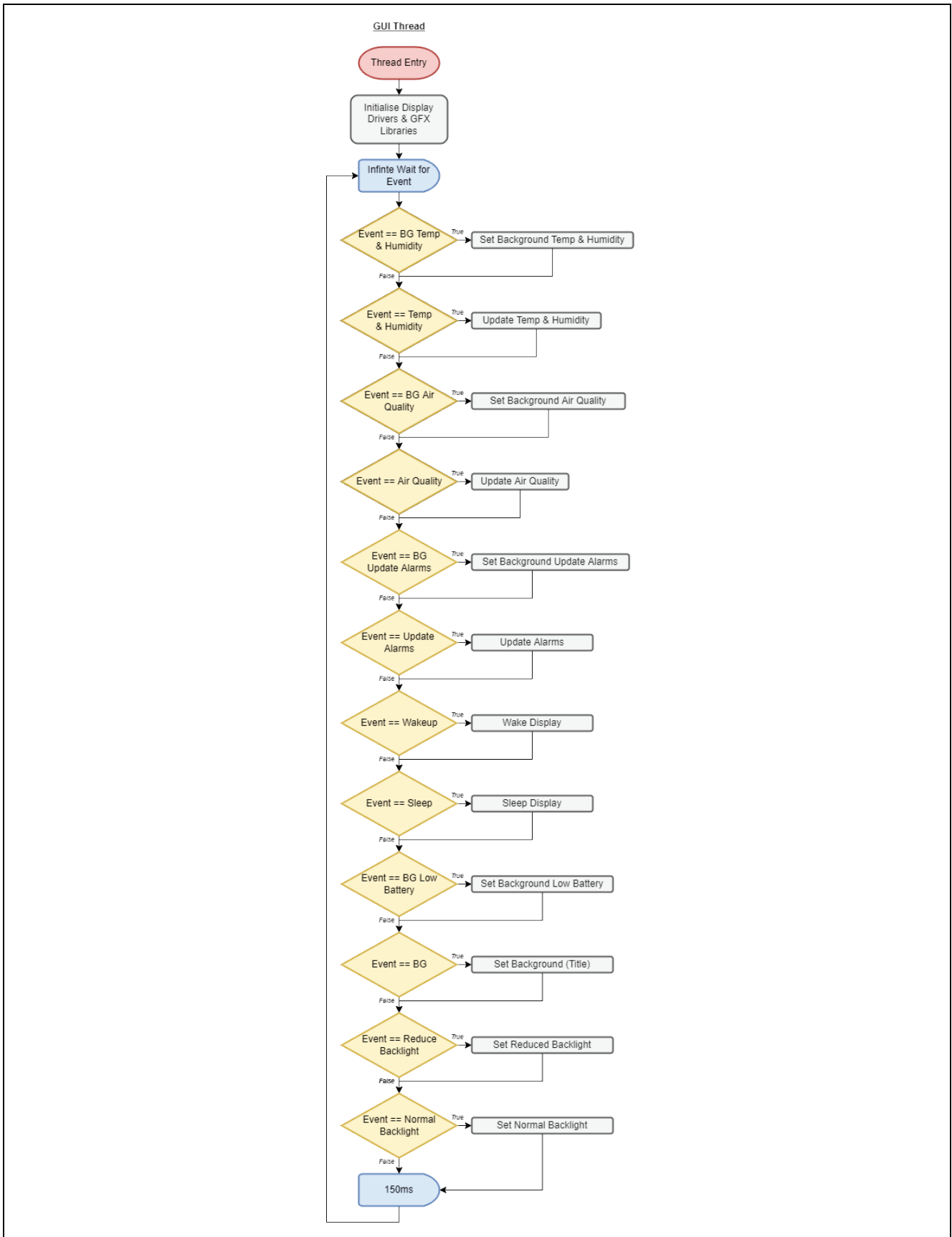

Figure 39. GUI Thread

### 4.2.3.2 Event Thread

The event thread handles all hardware events and state management within the application. It is responsible for interpreting events and dispatching instructions/messages to the GUI thread.

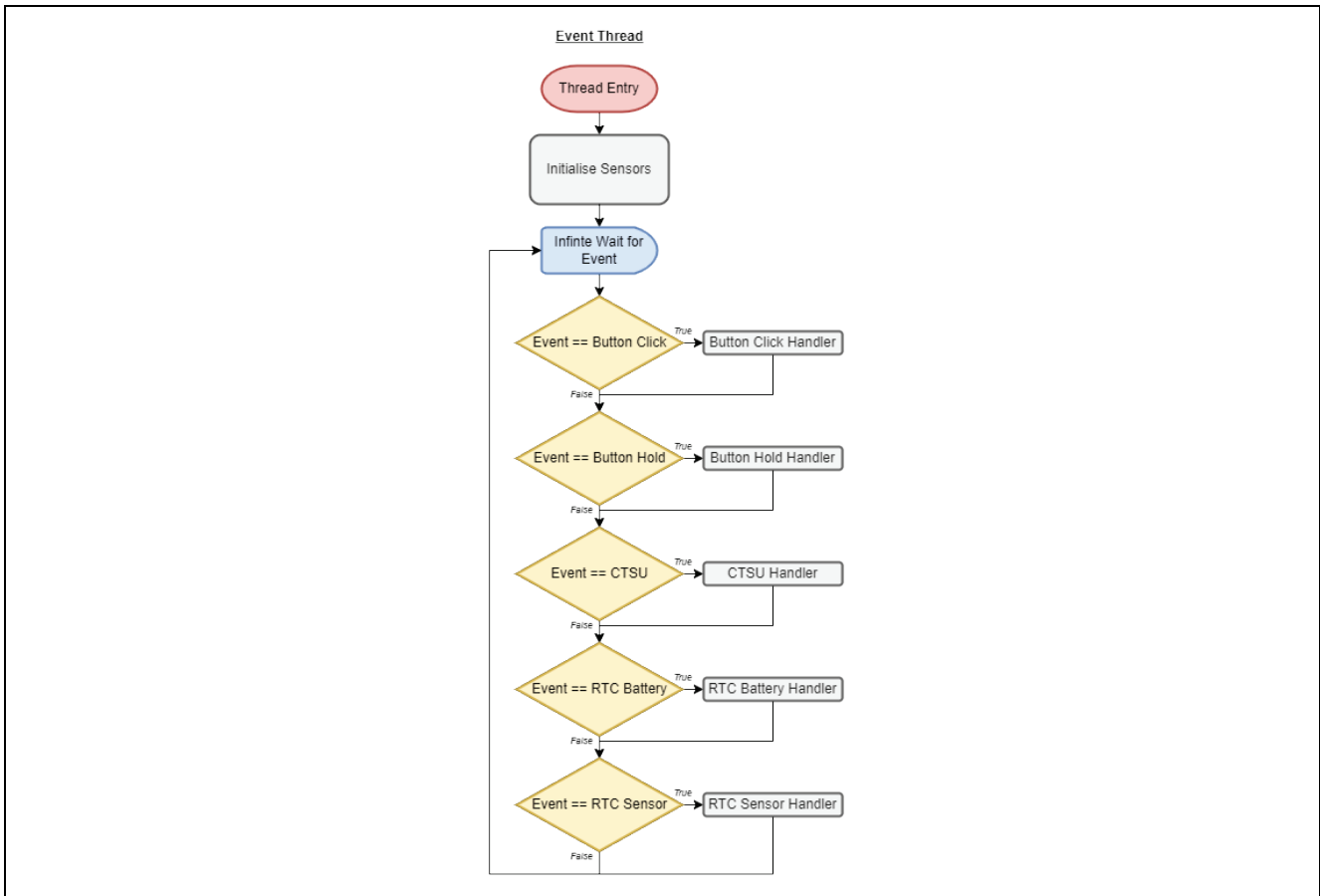

Figure 40. Event Thread

### 4.2.3.3 IPC

For effective communication between the event thread and GUI thread IPC (Inter Process Communication) objects must be used. Mutexes are used for locking access to sensor data, alarm threshold data and event flags are used to communicate requests between the threads.

This is illustrated in Figure 38 and Figure 41. These objects are provided by the rltos scheduler.

The **red** below indicates the mutex wrapping around a shared resource, the **blue** below indicates to the GUI thread an event has occurred.

```

Rltos_mutex_lock(&alarm_sensor_mutex, RLTOS_UINT_MAX);
alarm_sensor_data.eco2.integer_part += 1_rot_count;

if(alarm_sensor_data.eco2.integer_part < 0)
{
    alarm_sensor_data.eco2.integer_part = 0;
}

Rltos_mutex_release(&alarm_sensor_mutex);
Rltos_events_set(&gui_events, UPDATE_ALARM_ECO2);
    
```

Figure 41. IPC

### 4.3 State Machine

Figure 42 shows the state machine of the demonstration software and can be used as a reference point for navigating the software and user interface.

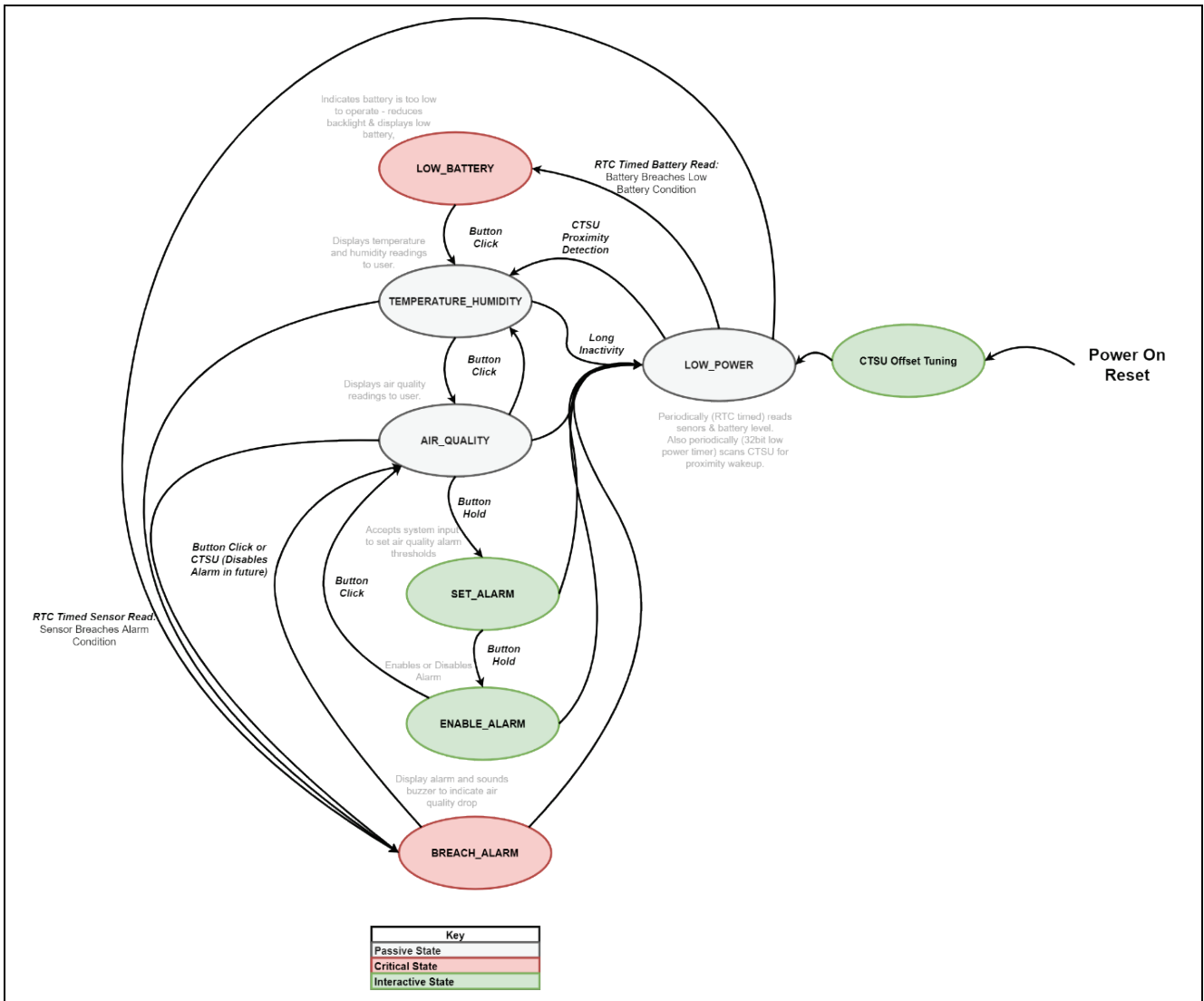

Figure 42. Application Software State Machine

## 4.4 Peripherals

The following table outlines all peripherals used and the subsequent sections go into further detail where required.

Peripheral	Port (pin)	Description
<b>LVD1</b>	N/A	Measures supply voltage and indicates when voltage has dipped.
<b>INTP0</b>	P137(43)	ZMOD4410 interrupt pin.
<b>INTP8</b>	P74(7)	HS4001 alarm pin.
<b>DTC0</b>	N/A	Triggered by TAU06 for tone generation on the buzzer PCLBUZ1.
<b>DTC1</b>	N/A	DTC to automate transfers for SPI display (TX only)
<b>DTC22</b>	N/A	CTSURD
<b>DTC23</b>	N/A	CTSUWR
<b>ITL</b>	N/A	Low power interval timer – 16bit mode, channel 0 & 1, triggers CTSU 100ms
<b>RTC</b>	N/A	System timer to measure intervals between sensor reads. 1sec
<b>TAU00</b>	P00(35), P51(14)	Connected by ELCL, rotary encoder increment.
<b>TAU01</b>	P00(35), P51(14)	Connected by ELCL, rotary encoder decrement.
<b>TAU02</b>	N/A	Scheduler timer (65ms)
<b>TAU03</b>	P31(5)	Switch
<b>TAU04</b>	N/A	Display delay function, provides 1ms resolution delay function to display driver.
<b>TAU05</b>	N/A	One-shot timer to delay time taken for HS4001 to measure T+RH
<b>TAU06</b>	N/A	Used in combination with DTC and PCLBUZ1 to generate a tone.
<b>PCLBUZ1</b>	P15(17)	Buzzer drive circuit
<b>CSI00 (SPI)</b>	P12(20), P11(21), P10(22), P146(23), P13(19), P73(8)	Display interface: (8Mbps) P12, P11 – SDIO P10 – SCK P146 – D/C P13 – CS P73 – Display Reset
<b>IICA0</b>	P60(1), P61(2)	Sensors IIC – 400kHz P60 – SCL P61 – SDA
<b>UARTA0</b>	P72(9), P71(10)	UART for tuning the capacitive touch (or PMOD) (153600 bps 8N1) P72 – TX P71 – RX
<b>CCIO</b>	P62(3), P17(15), P16(16)	Current controlled I/O P16 – Red channel control on RB LED P17 – Blue channel control on RB LED P62 – Display backlight control

Peripheral	Port (pin)	Description
CTSU	P27(25), P30(12)	Capacitive touch sensor for proximity scanning P27 – TS25 capacitive proximity electrode P30 – TSCAP capacitor for CTSU power supply
GPIO	P70(11), P50(13)	P70 – RES_N output, ZMOD4410 reset. P50 – PMOD IRQ
UARTA1	P120(37), P41(38)	Auxiliary UART on PMOD P120 – TX P41 – RX

### 4.4.1 Rotary Encoder

The rotary encoder signals A and B are placed into the ELCL via pins P00 and P51 respectively – from here the logic in Figure 43 is applied.

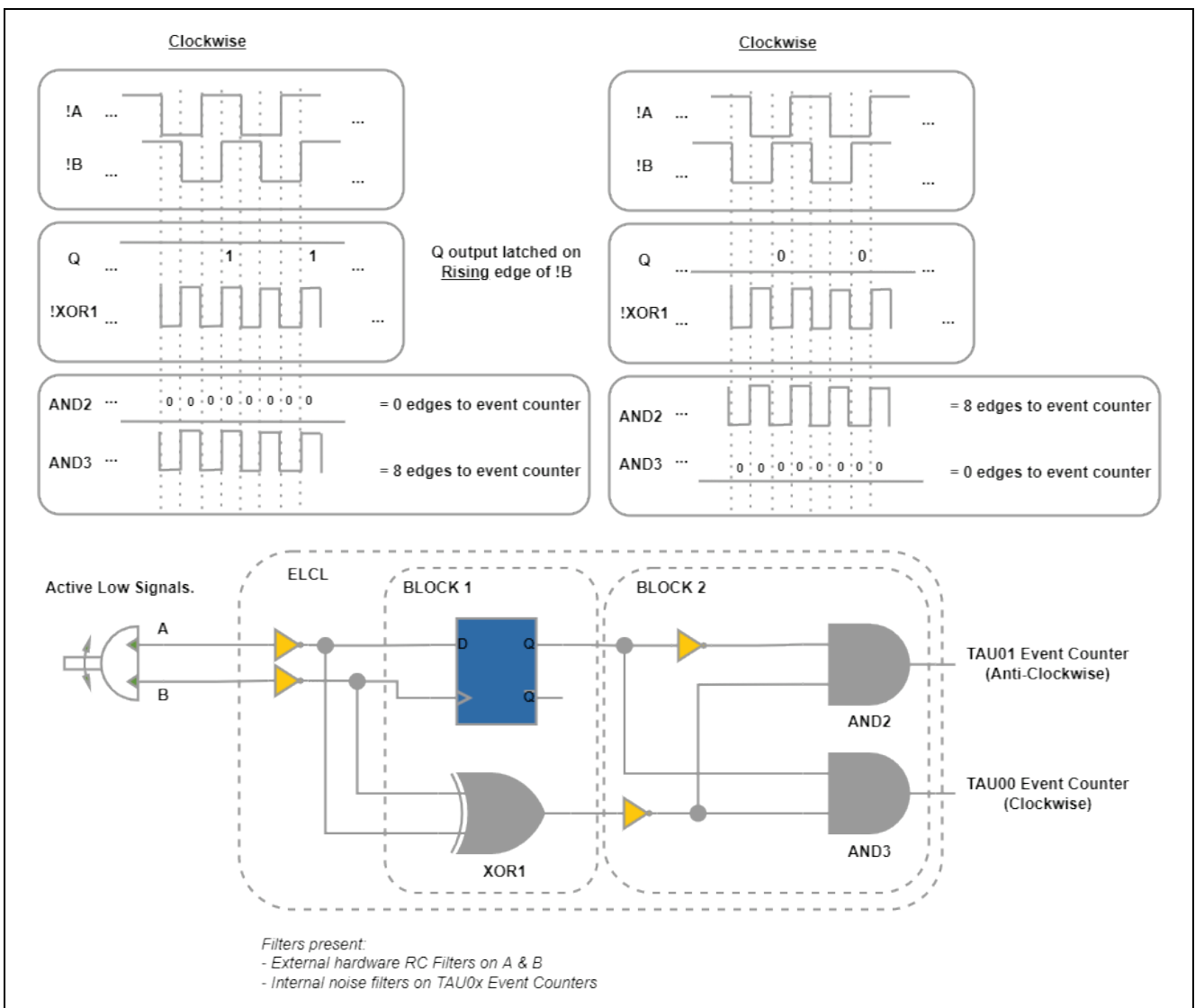

Figure 43. Rotary Decoding Mechanism



### 5. Power Consumption

The following power current consumption data has been retrieved at a battery voltage of 2.66 V.

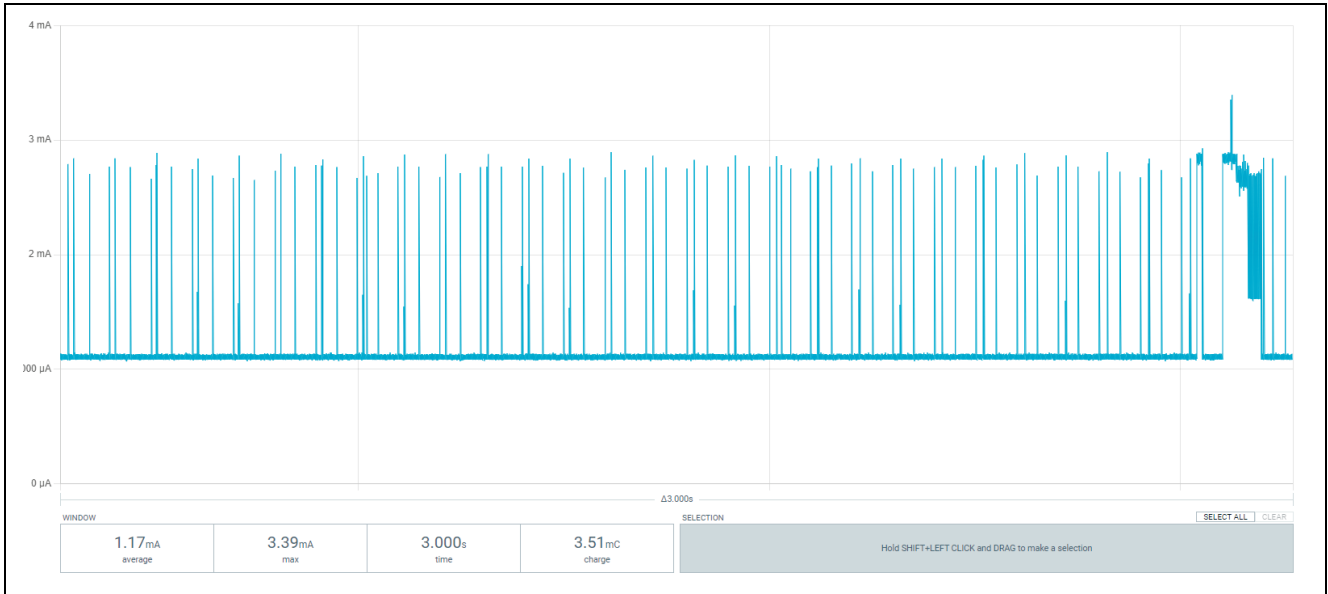

Figure 44. MCU Average Current

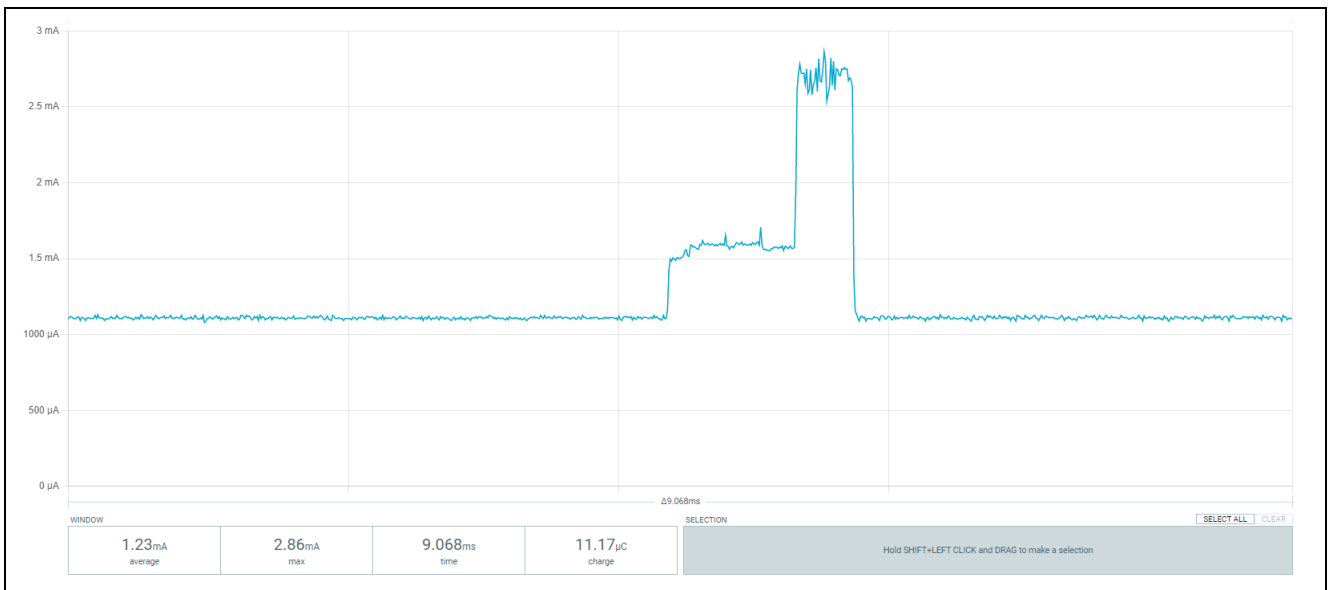

Figure 45. MCU CTSU2L Scan Current

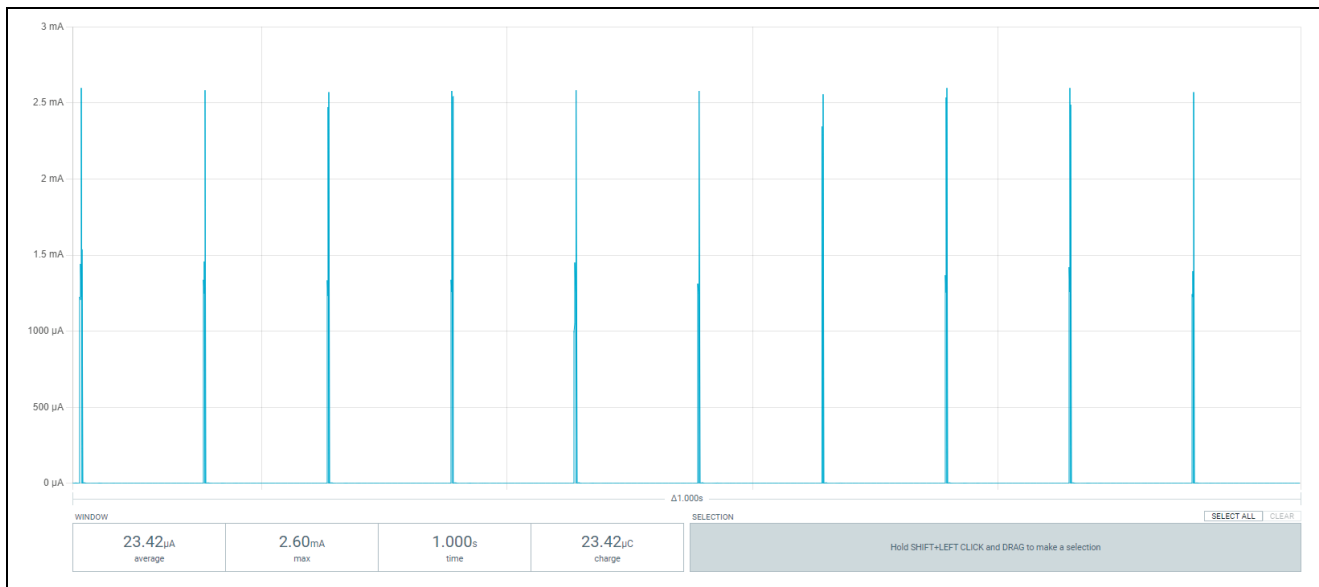

Figure 46. MCU Average Idle Current

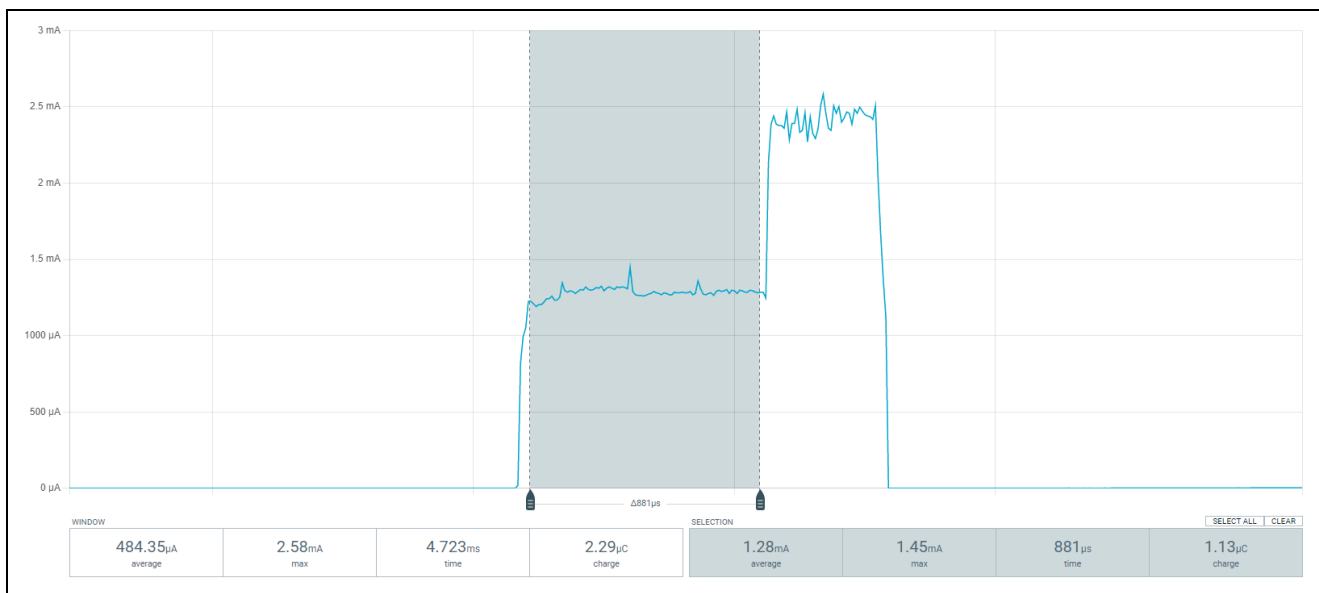

Figure 47. MCU CTSU2L Snooze Current

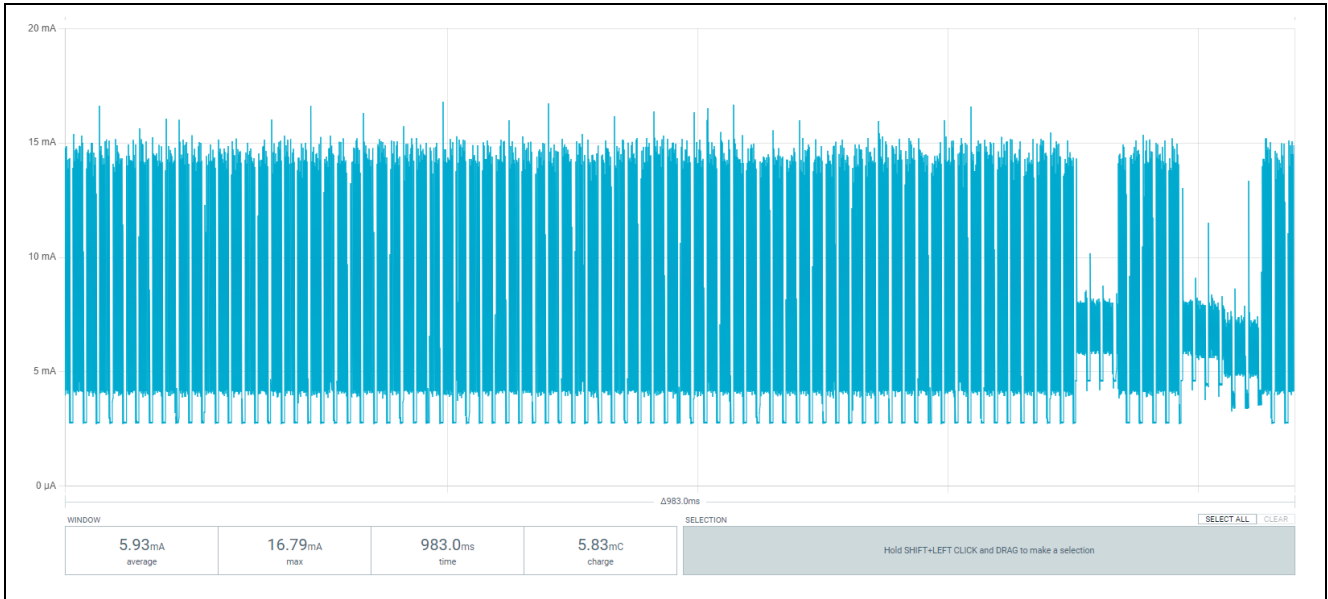

Figure 48. System Average Current

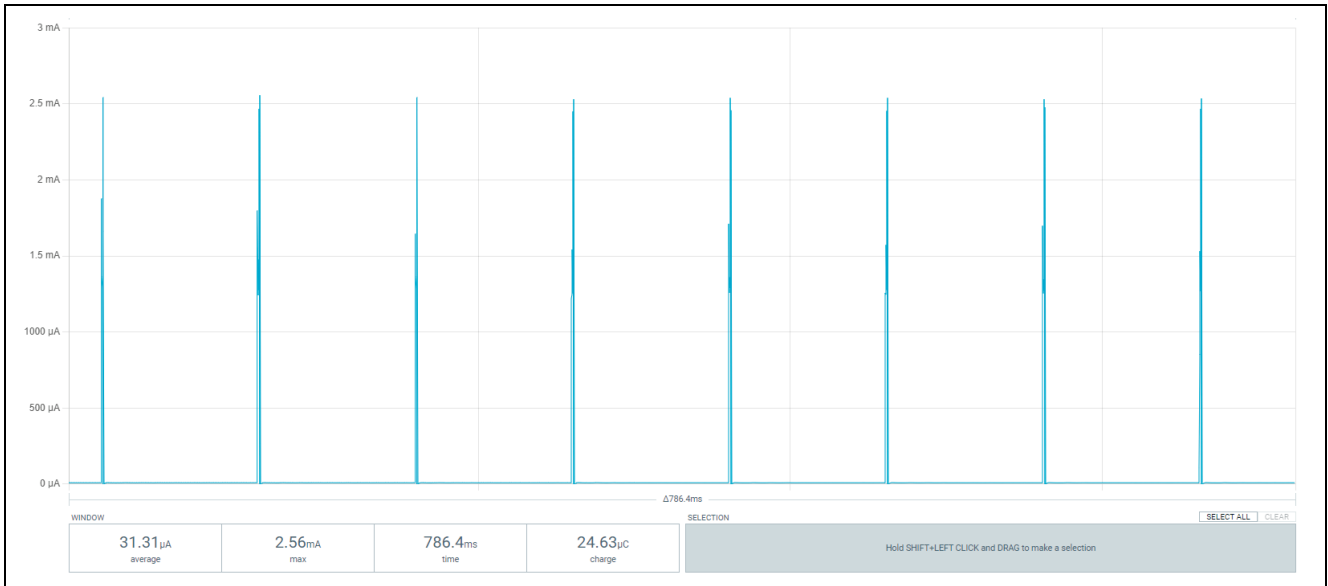

Figure 49. System Average Idle Current

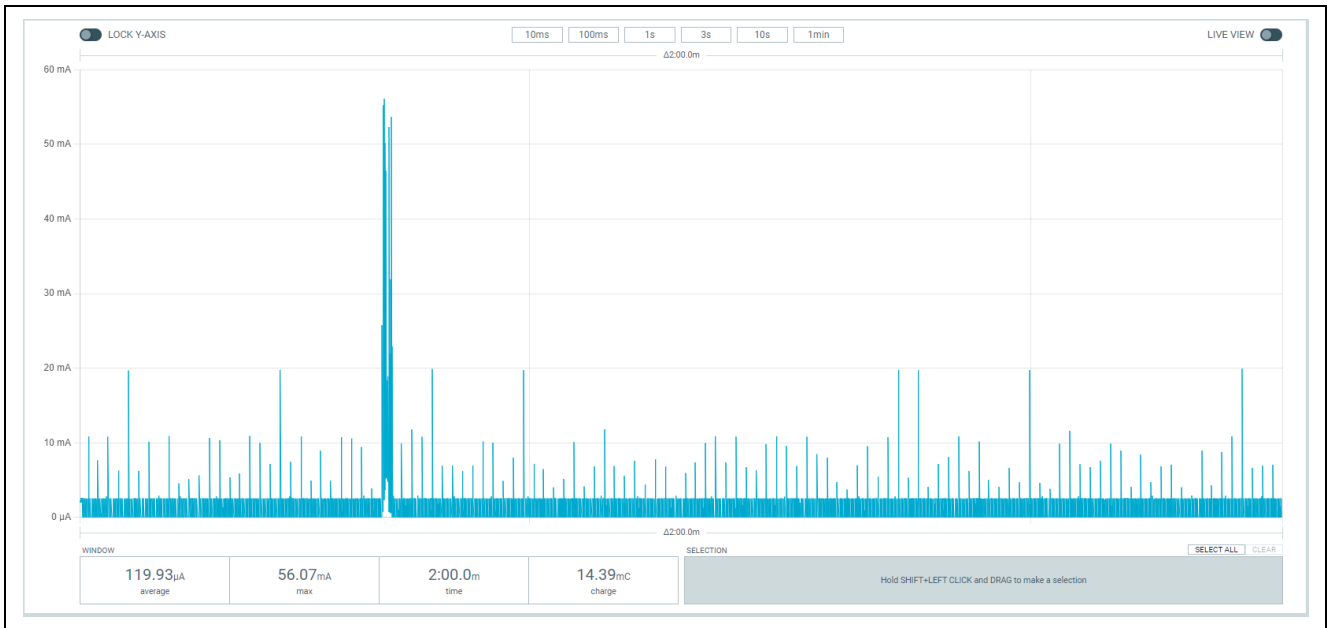

Figure 50. System Average Idle Current with Sensor Read

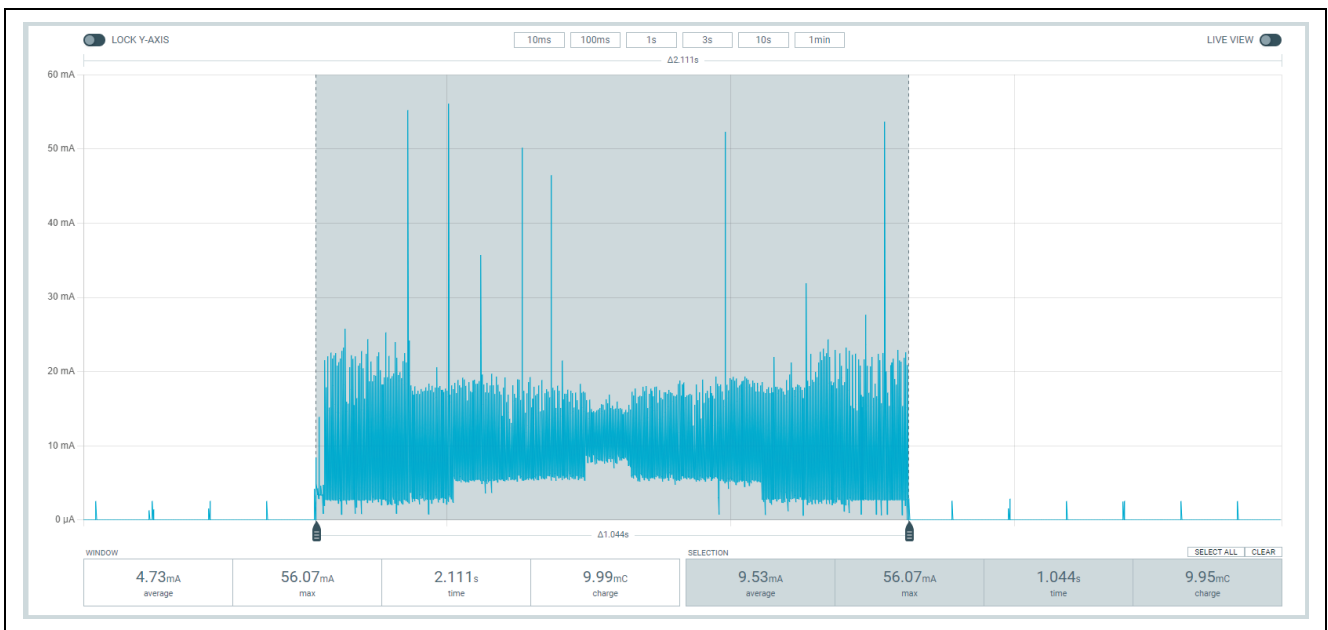

Figure 51. Sensor Read Current

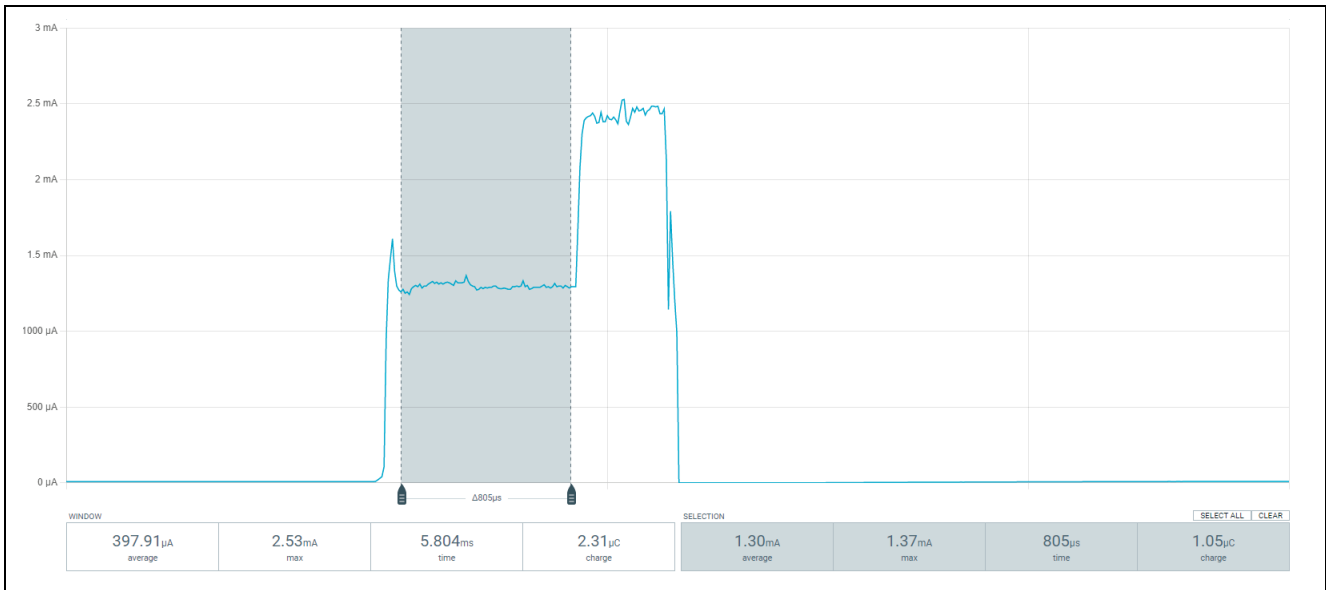

Figure 52. System Idle Current CTSU2L Scan

### 6. Important Source Modifications

To achieve low power, the `mcu_clocks.c` file at line 657 had to be modified as shown in the following figure.

```
657 | cmc_tmp = 0x10U;
```

Figure 53. CMC

This places the pins P123 and P124 into XT1 oscillation mode – but elsewhere the XTSTOP bit is set which disables the circuit. This is the lowest power configuration for these pins according to section 2.3 of the RL78/G23 hardware user manual (R01UK896EJ0121).

**Website and Support**

Visit the following vanity URLs to learn about key elements of the RL78 family, download components and related documentation, and get support.

RL78 Product Information

[www.renesas.com/rl78](http://www.renesas.com/rl78)

Renesas Support

[www.renesas.com/support](http://www.renesas.com/support)

**Revision History**

Rev.	Date	Description	
		Page	Summary
1.00	Feb.20.24	—	First release document

# General Precautions in the Handling of Microprocessing Unit and Microcontroller Unit Products

The following usage notes are applicable to all Microprocessing unit and Microcontroller unit products from Renesas. For detailed usage notes on the products covered by this document, refer to the relevant sections of the document as well as any technical updates that have been issued for the products.

## 1. Precaution against Electrostatic Discharge (ESD)

A strong electrical field, when exposed to a CMOS device, can cause destruction of the gate oxide and ultimately degrade the device operation. Steps must be taken to stop the generation of static electricity as much as possible, and quickly dissipate it when it occurs. Environmental control must be adequate. When it is dry, a humidifier should be used. This is recommended to avoid using insulators that can easily build up static electricity.

Semiconductor devices must be stored and transported in an anti-static container, static shielding bag or conductive material. All test and measurement tools including work benches and floors must be grounded. The operator must also be grounded using a wrist strap. Semiconductor devices must not be touched with bare hands. Similar precautions must be taken for printed circuit boards with mounted semiconductor devices.

## 2. Processing at power-on

The state of the product is undefined at the time when power is supplied. The states of internal circuits in the LSI are indeterminate and the states of register settings and pins are undefined at the time when power is supplied. In a finished product where the reset signal is applied to the external reset pin, the states of pins are not guaranteed from the time when power is supplied until the reset process is completed. In a similar way, the states of pins in a product that is reset by an on-chip power-on reset function are not guaranteed from the time when power is supplied until the power reaches the level at which resetting is specified.

## 3. Input of signal during power-off state

Do not input signals or an I/O pull-up power supply while the device is powered off. The current injection that results from input of such a signal or I/O pull-up power supply may cause malfunction and the abnormal current that passes in the device at this time may cause degradation of internal elements. Follow the guideline for input signal during power-off state as described in your product documentation.

## 4. Handling of unused pins

Handle unused pins in accordance with the directions given under handling of unused pins in the manual. The input pins of CMOS products are generally in the high-impedance state. In operation with an unused pin in the open-circuit state, extra electromagnetic noise is induced in the vicinity of the LSI, an associated shoot-through current flows internally, and malfunctions occur due to the false recognition of the pin state as an input signal become possible.

## 5. Clock signals

After applying a reset, only release the reset line after the operating clock signal becomes stable. When switching the clock signal during program execution, wait until the target clock signal is stabilized. When the clock signal is generated with an external resonator or from an external oscillator during a reset, ensure that the reset line is only released after full stabilization of the clock signal. Additionally, when switching to a clock signal produced with an external resonator or by an external oscillator while program execution is in progress, wait until the target clock signal is stable.

## 6. Voltage application waveform at input pin

Waveform distortion due to input noise or a reflected wave may cause malfunction. If the input of the CMOS device stays in the area between  $V_{IL}$  (Max.) and  $V_{IH}$  (Min.) due to noise, for example, the device may malfunction. Take care to prevent chattering noise from entering the device when the input level is fixed, and also in the transition period when the input level passes through the area between  $V_{IL}$  (Max.) and  $V_{IH}$  (Min.).

## 7. Prohibition of access to reserved addresses

Access to reserved addresses is prohibited. The reserved addresses are provided for possible future expansion of functions. Do not access these addresses as the correct operation of the LSI is not guaranteed.

## 8. Differences between products

Before changing from one product to another, for example to a product with a different part number, confirm that the change will not lead to problems. The characteristics of a microprocessing unit or microcontroller unit products in the same group but having a different part number might differ in terms of internal memory capacity, layout pattern, and other factors, which can affect the ranges of electrical characteristics, such as characteristic values, operating margins, immunity to noise, and amount of radiated noise. When changing to a product with a different part number, implement a system-evaluation test for the given product.



## Notice

1. Descriptions of circuits, software and other related information in this document are provided only to illustrate the operation of semiconductor products and application examples. You are fully responsible for the incorporation or any other use of the circuits, software, and information in the design of your product or system. Renesas Electronics disclaims any and all liability for any losses and damages incurred by you or third parties arising from the use of these circuits, software, or information.
2. Renesas Electronics hereby expressly disclaims any warranties against and liability for infringement or any other claims involving patents, copyrights, or other intellectual property rights of third parties, by or arising from the use of Renesas Electronics products or technical information described in this document, including but not limited to, the product data, drawings, charts, programs, algorithms, and application examples.
3. No license, express, implied or otherwise, is granted hereby under any patents, copyrights or other intellectual property rights of Renesas Electronics or others.
4. You shall be responsible for determining what licenses are required from any third parties, and obtaining such licenses for the lawful import, export, manufacture, sales, utilization, distribution or other disposal of any products incorporating Renesas Electronics products, if required.
5. You shall not alter, modify, copy, or reverse engineer any Renesas Electronics product, whether in whole or in part. Renesas Electronics disclaims any and all liability for any losses or damages incurred by you or third parties arising from such alteration, modification, copying or reverse engineering.
6. Renesas Electronics products are classified according to the following two quality grades: "Standard" and "High Quality". The intended applications for each Renesas Electronics product depends on the product's quality grade, as indicated below.
  - "Standard": Computers; office equipment; communications equipment; test and measurement equipment; audio and visual equipment; home electronic appliances; machine tools; personal electronic equipment; industrial robots; etc.
  - "High Quality": Transportation equipment (automobiles, trains, ships, etc.); traffic control (traffic lights); large-scale communication equipment; key financial terminal systems; safety control equipment; etc.

Unless expressly designated as a high reliability product or a product for harsh environments in a Renesas Electronics data sheet or other Renesas Electronics document, Renesas Electronics products are not intended or authorized for use in products or systems that may pose a direct threat to human life or bodily injury (artificial life support devices or systems; surgical implantations; etc.), or may cause serious property damage (space system; undersea repeaters; nuclear power control systems; aircraft control systems; key plant systems; military equipment; etc.). Renesas Electronics disclaims any and all liability for any damages or losses incurred by you or any third parties arising from the use of any Renesas Electronics product that is inconsistent with any Renesas Electronics data sheet, user's manual or other Renesas Electronics document.
7. No semiconductor product is absolutely secure. Notwithstanding any security measures or features that may be implemented in Renesas Electronics hardware or software products, Renesas Electronics shall have absolutely no liability arising out of any vulnerability or security breach, including but not limited to any unauthorized access to or use of a Renesas Electronics product or a system that uses a Renesas Electronics product. RENESAS ELECTRONICS DOES NOT WARRANT OR GUARANTEE THAT RENESAS ELECTRONICS PRODUCTS, OR ANY SYSTEMS CREATED USING RENESAS ELECTRONICS PRODUCTS WILL BE INVULNERABLE OR FREE FROM CORRUPTION, ATTACK, VIRUSES, INTERFERENCE, HACKING, DATA LOSS OR THEFT, OR OTHER SECURITY INTRUSION ("Vulnerability Issues"). RENESAS ELECTRONICS DISCLAIMS ANY AND ALL RESPONSIBILITY OR LIABILITY ARISING FROM OR RELATED TO ANY VULNERABILITY ISSUES. FURTHERMORE, TO THE EXTENT PERMITTED BY APPLICABLE LAW, RENESAS ELECTRONICS DISCLAIMS ANY AND ALL WARRANTIES, EXPRESS OR IMPLIED, WITH RESPECT TO THIS DOCUMENT AND ANY RELATED OR ACCOMPANYING SOFTWARE OR HARDWARE, INCLUDING BUT NOT LIMITED TO THE IMPLIED WARRANTIES OF MERCHANTABILITY, OR FITNESS FOR A PARTICULAR PURPOSE.
8. When using Renesas Electronics products, refer to the latest product information (data sheets, user's manuals, application notes, "General Notes for Handling and Using Semiconductor Devices" in the reliability handbook, etc.), and ensure that usage conditions are within the ranges specified by Renesas Electronics with respect to maximum ratings, operating power supply voltage range, heat dissipation characteristics, installation, etc. Renesas Electronics disclaims any and all liability for any malfunctions, failure or accident arising out of the use of Renesas Electronics products outside of such specified ranges.
9. Although Renesas Electronics endeavors to improve the quality and reliability of Renesas Electronics products, semiconductor products have specific characteristics, such as the occurrence of failure at a certain rate and malfunctions under certain use conditions. Unless designated as a high reliability product or a product for harsh environments in a Renesas Electronics data sheet or other Renesas Electronics document, Renesas Electronics products are not subject to radiation resistance design. You are responsible for implementing safety measures to guard against the possibility of bodily injury, injury or damage caused by fire, and/or danger to the public in the event of a failure or malfunction of Renesas Electronics products, such as safety design for hardware and software, including but not limited to redundancy, fire control and malfunction prevention, appropriate treatment for aging degradation or any other appropriate measures. Because the evaluation of microcomputer software alone is very difficult and impractical, you are responsible for evaluating the safety of the final products or systems manufactured by you.
10. Please contact a Renesas Electronics sales office for details as to environmental matters such as the environmental compatibility of each Renesas Electronics product. You are responsible for carefully and sufficiently investigating applicable laws and regulations that regulate the inclusion or use of controlled substances, including without limitation, the EU RoHS Directive, and using Renesas Electronics products in compliance with all these applicable laws and regulations. Renesas Electronics disclaims any and all liability for damages or losses occurring as a result of your noncompliance with applicable laws and regulations.
11. Renesas Electronics products and technologies shall not be used for or incorporated into any products or systems whose manufacture, use, or sale is prohibited under any applicable domestic or foreign laws or regulations. You shall comply with any applicable export control laws and regulations promulgated and administered by the governments of any countries asserting jurisdiction over the parties or transactions.
12. It is the responsibility of the buyer or distributor of Renesas Electronics products, or any other party who distributes, disposes of, or otherwise sells or transfers the product to a third party, to notify such third party in advance of the contents and conditions set forth in this document.
13. This document shall not be reprinted, reproduced or duplicated in any form, in whole or in part, without prior written consent of Renesas Electronics.
14. Please contact a Renesas Electronics sales office if you have any questions regarding the information contained in this document or Renesas Electronics products.

(Note1) "Renesas Electronics" as used in this document means Renesas Electronics Corporation and also includes its directly or indirectly controlled subsidiaries.

(Note2) "Renesas Electronics product(s)" means any product developed or manufactured by or for Renesas Electronics.

(Rev.5.0-1 October 2020)

## Corporate Headquarters

TOYOSU FORESIA, 3-2-24 Toyosu,  
Koto-ku, Tokyo 135-0061, Japan

[www.renesas.com](http://www.renesas.com)

## Trademarks

Renesas and the Renesas logo are trademarks of Renesas Electronics Corporation. All trademarks and registered trademarks are the property of their respective owners.

## Contact information

For further information on a product, technology, the most up-to-date version of a document, or your nearest sales office, please visit:

[www.renesas.com/contact/](http://www.renesas.com/contact/).