

STEERING THE FUTURE OF INNOVATION

Automotive Semiconductor Solutions
for a safe and secure driving experience

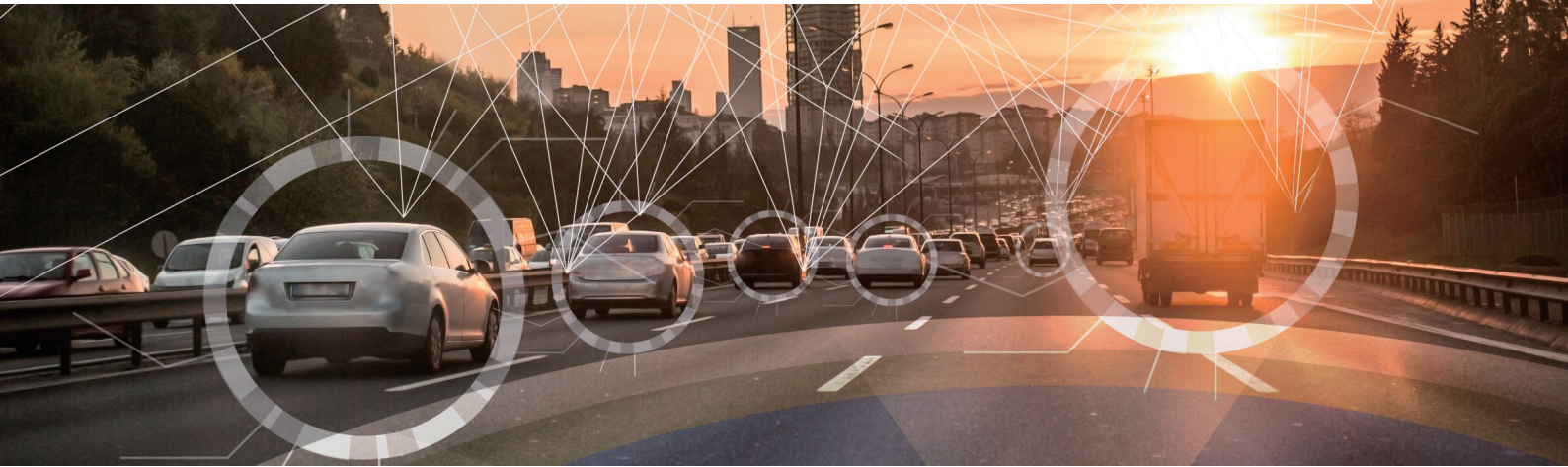

BIG IDEAS FOR EVERY SPACE



Engineers in the world face significant challenges when working on innovations to shape a better future.

Innovations need ideas.

Renesas is at the core of the technological innovation. Customers trust in our quality, reliability and market leadership.

Our leading-edge embedded solutions allow customers to focus their resources on innovation.

When it comes to realizing ideas, we want the engineers to remember Renesas first. Because Renesas is the enabler of Big Ideas.

CONTENTS

Renesas Profile _____	page 3-4
Renesas Focus Areas & Product Portfolio _____	page 5
Application Solutions _____	page 6-7
ADAS & Automated Driving _____	page 8
Integrated Cockpit & Connected Car _____	page 9-10
Connected Gateway / Car Server _____	page 11
Body, Chassis & Safety Systems _____	page 12-13
Powertrain, EV/HEV _____	page 14-15
Product Portfolio _____	page 16
Microcontroller (MCU) _____	page 17-18
System-on-Chip (SoC) _____	page 19-22
Analog & Power products _____	page 23-27

THE WORLD LEADING EMBEDDED SOLUTION PROVIDER

WHO WE ARE

Renesas is a global semiconductor company delivering trusted embedded design innovation with complete semiconductor solutions that enable billions of connected, intelligent devices to enhance the way people work and live—securely and safely. A global leader in microcontrollers, analog, power, SoC products and integrated platforms, Renesas provides expertise, quality, and comprehensive solutions for a broad range of Automotive, Industrial, Home Electronics, Office Automation and Information Communication Technology applications to help shape a limitless future.

- **Global leader in Microcontrollers, Analog, Power and SoC products**
- **Supports a broad range of Automotive, Industrial, Home Electronics, Office Automation, and Information Communication Technology applications**
- **715.7 billion yen revenue in 2020**
- **21,000 employees worldwide**
- **Headquartered in Tokyo, Japan with a strong global footprint**

OUR HISTORY

Renesas is built on a strong historical foundation of technological innovation originating from Hitachi, Mitsubishi and NEC. Fueled by integrations with Intersil, IDT, Dialog, and Celeno, Renesas is now poised to extend its share in fast-growing data economy markets such as infrastructure and data center, and strengthen its presence in the industrial and automotive segments.

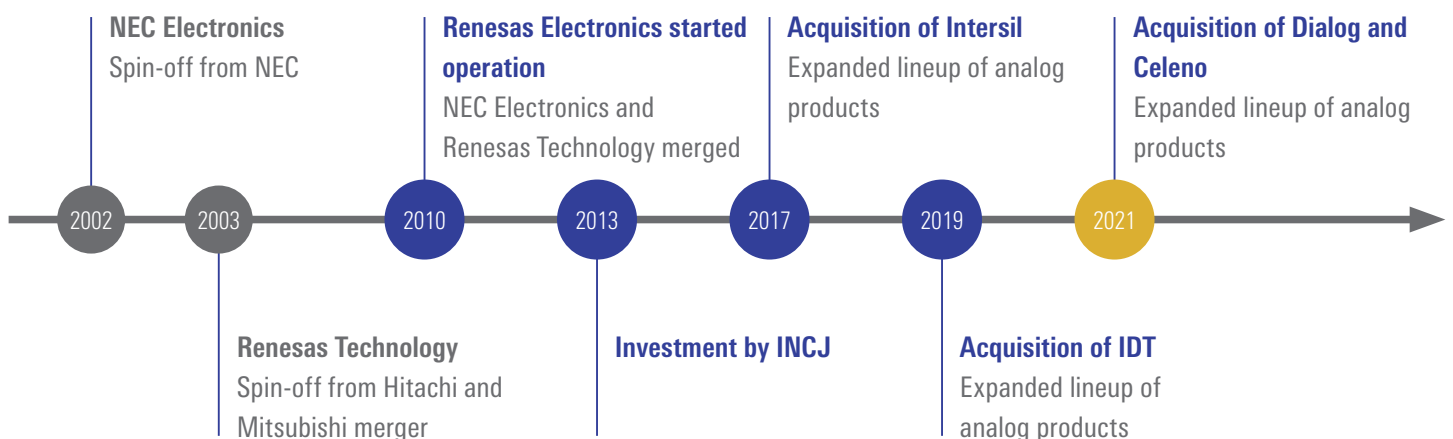

OUR MISSION IS TO MAKE CARS SAFER, MORE COMFORTABLE &
ENVIRONMENTALLY FRIENDLY

RENESAS & AUTOMOTIVE

The Renesas Automotive Solutions Business Unit addresses the specific requirements of the automotive industry. Thanks to the combination of leading-edge technologies and the company's deep understanding of customer's requirements, Renesas offers a wide range of innovative solutions. Embracing customer needs, i.e zero accidents, zero stress, and zero emissions, we design our solutions to make cars safer, more comfortable and environmentally friendly. With Renesas' scalable MCU and SoC platforms, supplemented by efficient power and MSIG product and ever-growing software offers, we deliver all ingredients to cover groundbreaking applications shaping the future of mobility. Being at the edge of technological innovation Renesas offers its solutions to support the mega trends that drive the industry: Connected, Automated, Shared, and Electrified with enabling E/E architecture changes.

Automotive Competence

Renesas

... is a **leading MCU/SoC supplier**

W/W shipments reached over 1,4b units in 2020

... offers **advanced process technologies**

16nm FinFET for SoC and 28nm for MCU

... is **best in quality**

Extremely low failure rate at 0.1ppm

... is **dedicated to support** on both local and global levels

... is a committed **long-term partner**

... is the **preferred supplier** to almost all system suppliers and car manufacturers

... provides of an **Open Solution Platform** accelerating time to market

With our partners we offer a robust ecosystem increasing development efficiency

CASE: CONNECTED - AUTOMATED - SHARED & SERVICES - ELECTRIFIED

WE FOLLOW THE MEGATRENDS THAT DRIVE THE CHANGE

CONNECTED CAR

With Renesas' solutions cars are connected safe & secure from vehicle to cloud.

ADAS/AUTOMATED DRIVE

Renesas offers solutions for sensing, analyzing and controlling for a safe, secure and comfortable driving experience.

xEV

Renesas' robust, reliable and safe powertrain solutions help to manage efficient use of energy.

GATEWAY/CAR SERVER

With its rich product portfolio, Renesas supports automakers' vision of driving toward the mobility society of the future. We are committed to supporting a system chipset solution for Connected Gateway/Car server applications beyond just providing silicon.



Product Portfolio

Microcontrollers



16-bit ultra low power MCU
Sensing and motor control



32-bit high-performance MCU
Rich functional safety and security features

System-on-Chip Solutions



64-bit ARM-based high-end SoC
High performance, low power consumption, graphics and machine learning accelerators

Analog & Power Products

- Bluetooth Low Energy (BLE)
- Haptics Driver
- LED Driver
- Clocks and Timing Solutions
- Sensor Solutions
- Power Management IC (PMIC)
- Battery Management IC (BMIC)
- Video Signal Processing (VSP)
- Wireless Power Charging IC
- Automotive HD Link (AHL)
- Gate Driver Unit (GDU)
- PowerMOSFETs
- IGBT
- Intelligent Power Devices (IPD)

COMPLETE SOLUTIONS AT YOUR FINGERTIPS

APPLICATION SOLUTIONS



To showcase how our complementary products work together to deliver comprehensive solutions, we've developed many "Winning Combinations", compelling Renesas-plus-Intersil-plus-IDT-plus-Dialog product combinations that capture and highlight the technological advantages Renesas and the 3 acquired companies can provide as a combined company. Our complementary product portfolios of Analog + Power + Embedded Processing work together to deliver comprehensive solutions that help our customers accelerate their designs and get to market faster.

To learn more about our Winning Combinations, visit <https://www.renesas.com/eu/en/solutions/automotive.html>

Automotive Battery Management System

System Benefits

- Best BMS accuracy and long-term drift (LTD), which extend driving range and battery life performance, with superior accuracy of $<\pm 2.5\text{mV}$ and $<\pm 6\text{mV}@6\sigma$ LTD
- Lowest BOM cost and best FuSa/EMC/hot-plug solution, which alleviates R&D effort and is easy to use with Renesas' RH850 MCU Family (with dedicated drivers and software for BMS)
- MCU line-up supporting functional safety features up to ASIL D as well as required security
- Intelligent power device (IPD) for external load control
- Full system deliverables committed to automotive quality and support, which is optimized to be used high voltage Battery Management applications

Recommended Devices

RH850/P1M	32bit Microcontroller (MCU)
ISL78714	14ch Battery Management IC (BMIC)
RV1S2752Q*1	Photo Coupler for Isolation
uPD166031A-34*1	Intelligent Power Device (IPD)
RAJ2800024/34/44*1	Intelligent Power Device (IPD)

*1 Not contained in the reference board, please verify on customer board

Optional Devices

RAA270005	Power Management IC (PMIC)
-----------	----------------------------

Block Diagram

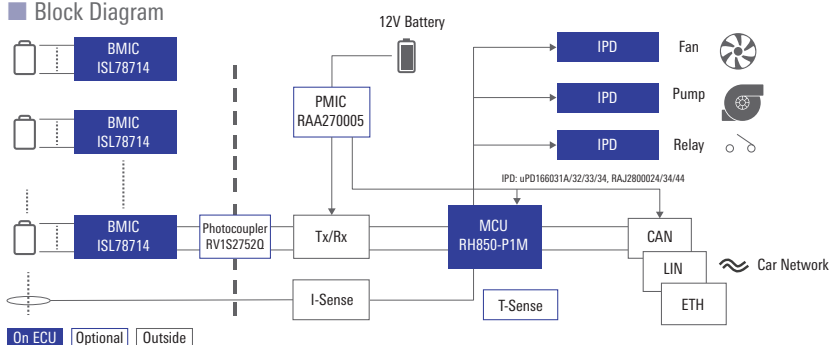

Reference Board

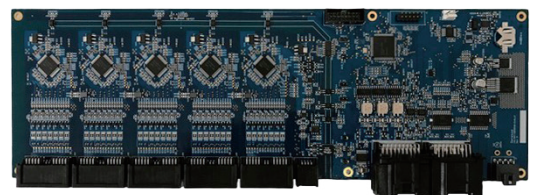

BLDC Motor Control Using Inductive Position Sensor

System Benefits

- High precision motor control based on inductive position sensing technology.
- Effective torque control under all load conditions. Low noise and vibration. High precision during brake&hold functions.
- Cost effective – no additional magnet or sensor cost. Shielding is not required. Immune to stray magnetic fields.
- Wide array of MCU line-up supporting functional safety features (FuSa) as well as security features (various ICU classes supported via integrated HW) and AUTOSAR (MCAL).

Block Diagram

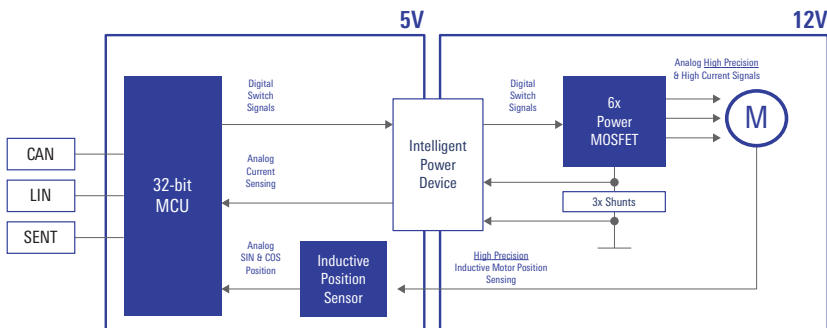

BOM List

RH850/F1KM-S1	32bit Microcontroller
IPS2550	Inductive Position Sensor
NP50N04YUK	Power MOSFET

Y-BLDC-SK-RH850F1KM-S1-V2

The kit includes:

Y-BLDC-SK-RH850F1KM-S1	Starter Kit with BLDC Motor
IPS2550	Inductive Position Sensor
NP50N04YUK	Power MOSFET

Starter Kit

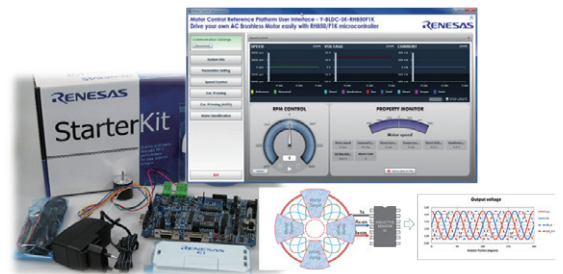

Low-Cost Digital Instrument Cluster Reference Design

System Benefits

- Low Cost Digital Instrument Cluster reference design using MCU + VSP scaler
- Less software work to support multiple display resolutions with a single design
- Generate cluster graphics in one resolution with the RH850 MCU, then easily scale to different resolutions using the RAA278840 LCD controller
- Uses the RAA278840 LCD controller to upscale the graphics to 1920x720 to support an upgrade option to a 12.3-inch panel for premium trim vehicle models
- Utilizes the RAA278840 LCD controller for "fast boot" to display tell-tale lamps at ignition (<500ms to display OSD through the RAA278840), allowing the MCU software time to boot up properly
- Optimized power management ICs for the camera and ECU

Recommended Devices

RH850/D1M1A	32bit Microcontroller with 2D GPU
RAA278840	VSP LCD Controller
ISL78264	Primary Regulators
ISL78171	LED Backlight Controller
ISL78419	TFT PMIC

Optional Devices

ISL78206	Primary Regulator
ISL76683	Light-to-Digital Output Sensor

Block Diagram

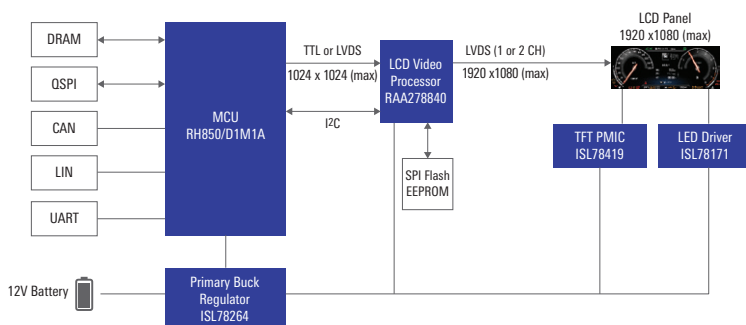

Reference Board



DESTINATION ADAS AND AUTOMATED DRIVING

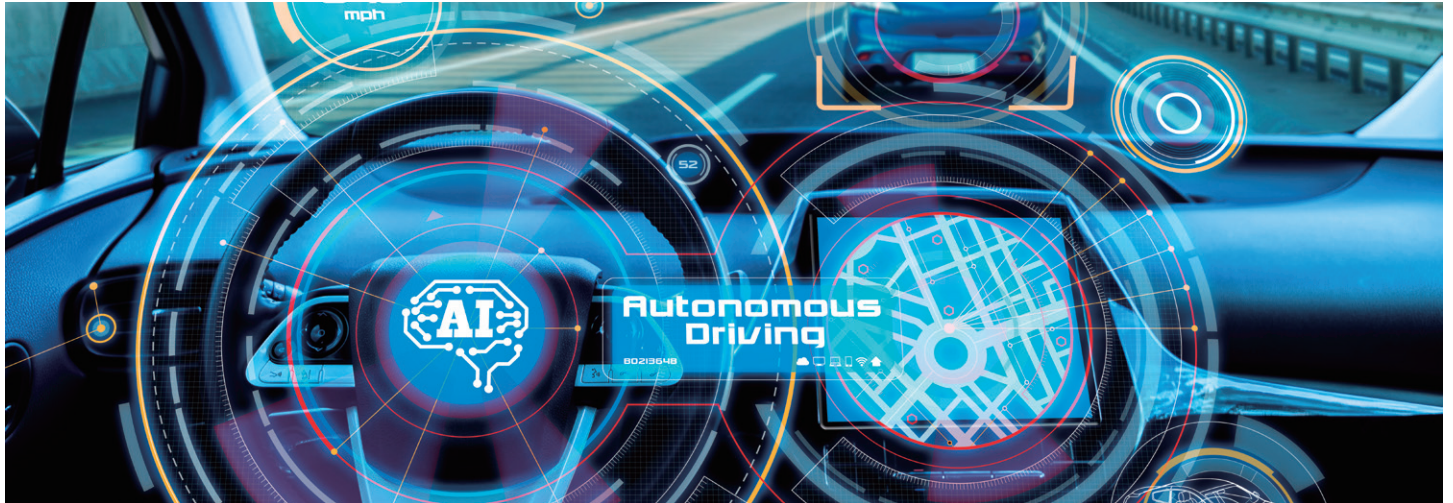

Renesas Solution Platform for ADAS & Automated driving

Renesas provides cutting edge chip solutions for the quickly evolving and complex ADAS and Autonomous driving market. Our goal is to enable customers with high compute chips that are designed with focus on Functional Safety and Low Power consumption, two necessary requirements for in-vehicle deployment. Our highly scalable lineup allows flexibility to the customer to develop platform solutions with re-usable design and SW leading to lowered development costs and fast time to market.

Trusted	Innovative	Open
Automotive proven	Most efficient Deep Learning IP	Most scalable ADAS/AD platform

Best In Class ASIL SoC with Deep Learning technology at low power

Renesas R-Car family provides an impressive scalable suite of SoCs to cater to perception, fusion and cognitive Function from NCAP to automated driving. Our Suite offers ASIL B to ASIL D SoCs with high TOPS performance along with industry best TOPS/W capability. The R-Car family allows essential functions from AEB, lane change, auto park to Traffic Jam Pilot/Highway Pilot functions with high compute and high safety implementation of obstacle detection, lane detection, traffic sign recognition, HD maps, sensor/data fusion, control functions and more.

	2019	2020	2021	2022	2023	2024	2025	2026+
AD Centralized ECU L3 & above (parking, driving)				R-Car Gen 4				
AD Centralized ECU L2/L2+ (parking, driving)			R-Car V3U 66 TOPS, R-Car Gen 4 Pre-development					
ADAS Sensors Front Camera, DMS, SV, Radar ...								
Fusion		R-Car H3		R-Car Gen 4				R-Car Gen 5
NCAP 2020 ~ 23		R-Car V3H		R-Car V3H2		R-Car Gen 4		
NCAP2024 / GSR mandate								
						Available	Under Development	Under planning

R-Car SDK Accelerates Deep Learning Development for ADAS and Automated Driving Applications

To take all the HW benefits and to consider the HW constraint like Power, deterministic real-time SW, Renesas has developed an open and Integrated development environment based on enabling fast time-to-market for Computer Vision and Deep learning solutions. Easy to use debugging and tuning tools for heterogeneous multi-core hardware will enable efficient SW development while a comprehensive set of example applications and online help supporting self-education will enable a quick ramp-up to beginner.

Qualified compilers and code generators for compliance with functional safety and cyber security requirements ensure Safe and secure SW development.

R-Car SDK for ADAS & AD

PC Development platform		Embedded Platform		
Windows	4 studio	RT-OS	Green Edge	MCOS
Simulation Platform Modeling	SW Development Deep learning Tools	Libraries Sample code Trainings	All R-Car Vxx SoC Devices	Starter Kit 6 evaluation board

Effortless installation of the development environment for ALL R-Car Vxx Device

TURN CAR INFORMATION SYSTEMS IN A REWARDING EXPERIENCE INTEGRATED COCKPIT



The integrated cockpit will evolve into a connected HMI by introducing new services through cloud connectivity in addition to the conventional cockpit. Renesas offers optimized, highly integrated cockpit solutions with safety, software portability, and performance scalability as key differentiators.

R-Car Gen3e

The R-Car Gen3e offers a scalable line-up for entry to mid-range automotive applications that require high-quality graphics rendering, such as integrated cockpit domain controllers, in-vehicle infotainment (IVI), digital instrument cluster, driver monitoring systems, and LED matrix light.

R-Car Cockpit Trend

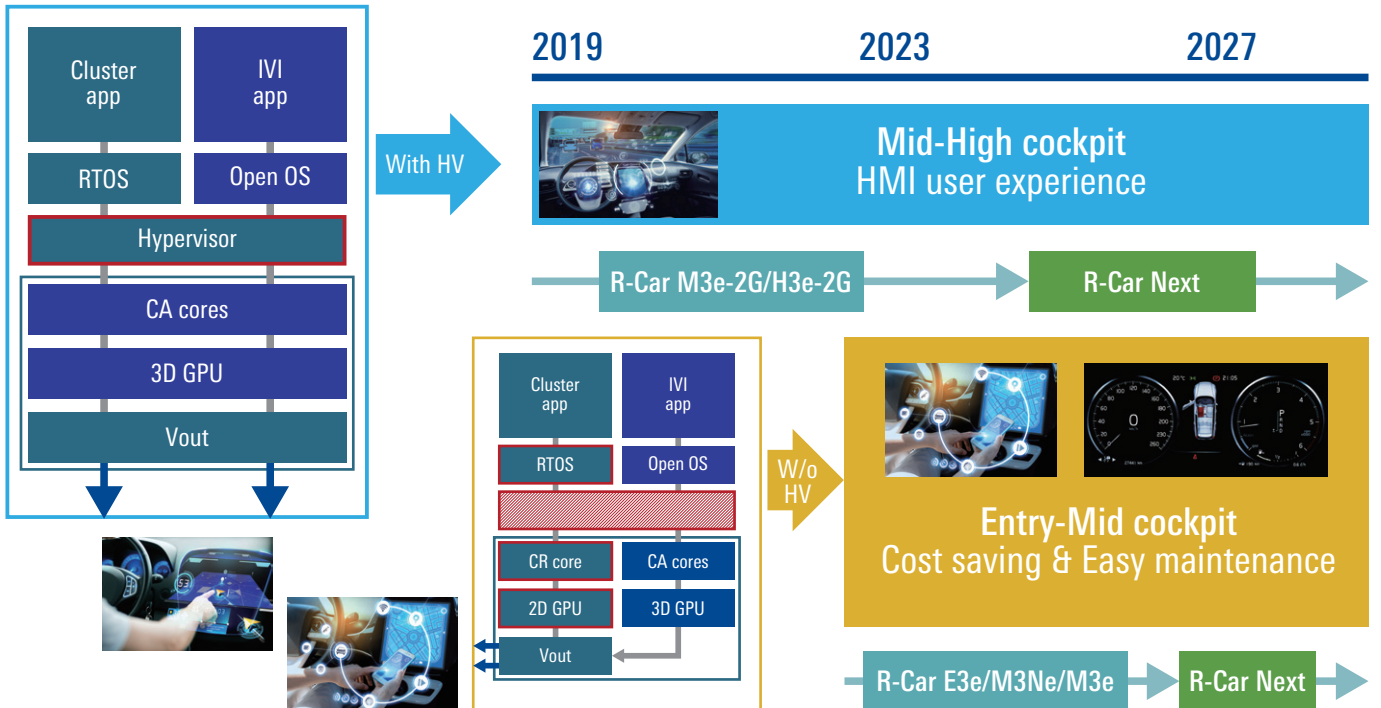

SAFE & SECURE INTO THE CLOUD

CONNECTED CAR



Digital transformation is accelerating. After changing from the "hardware fixed" world, incorporation of CI/CD on the premise of software download and agile development methods for automotive are required. Arbitration work with cloud computing is the key to design a in-vehicle computing architecture. In addition to conventional in-vehicle technology, the implementation of cloud technology into the vehicle and software DevOps become extremely important in automotive world as well as mobile phones.

Renesas Connected Car Platform

Renesas offers a cloud-native execution environment that utilizes virtualization technology to realize aka "Kubernetes for vehicles", which includes the cloud-sync framework such as microservice deployment and container orchestration. It enables your engineers to focus on application development and system designing, even without embedded technology skills.

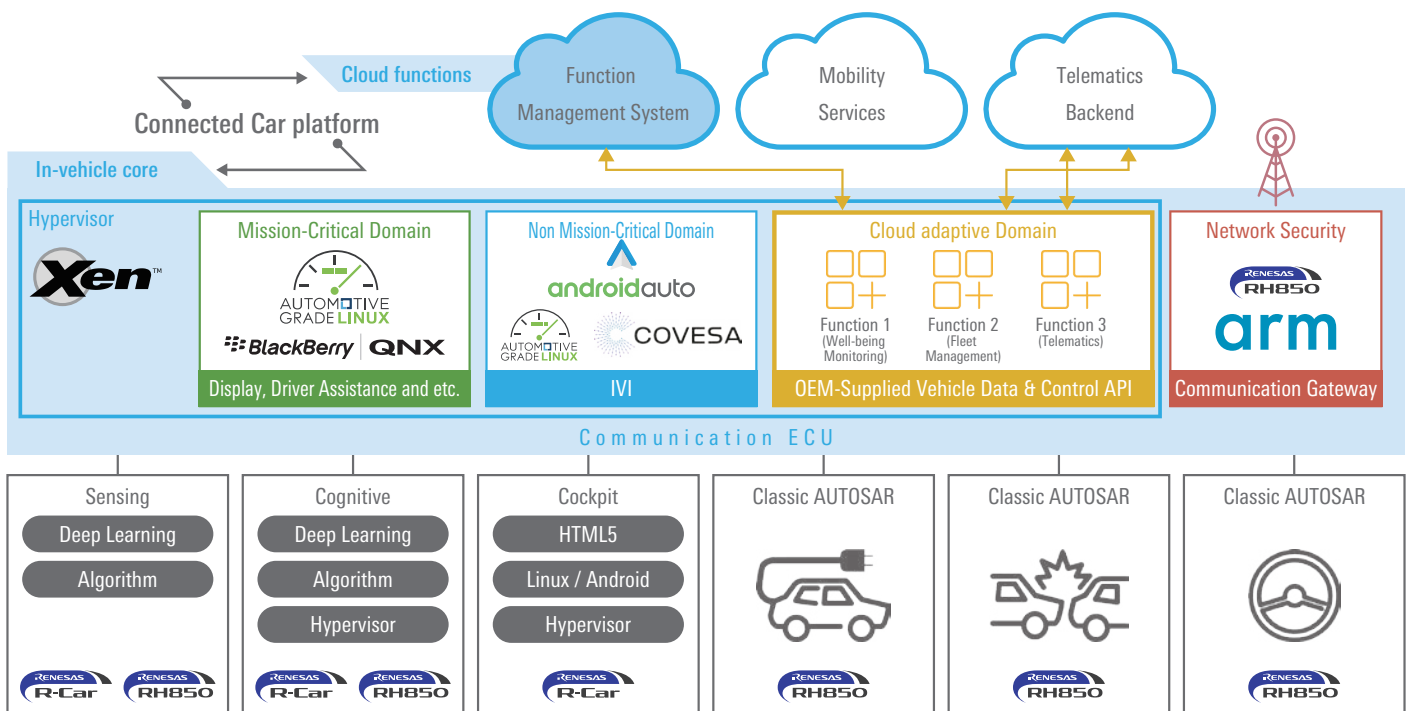

CI/CD: Continuous Integration/Continuous Delivery, DevOps: software development (Dev) and IT operations (Ops)

MEGATREND ARCHITECTURE TRANSFORMATION

CONNECTED GATEWAY / CAR SERVER

MCU Feature	Multi-protocol Gateway	Network Security	OTA Update	Application Server
<ul style="list-style-type: none"> Low power scheme: cyclic wake-up, deep standby mode Classic AUTOSAR 	<ul style="list-style-type: none"> CAN / Ethernet routing Gbit Ethernet CAN-Ethernet conversion 	<ul style="list-style-type: none"> Firewall, IPS Message Authentication Encryption 	<ul style="list-style-type: none"> Update agent OTA orchestration Enhanced Security, FuSa 	<ul style="list-style-type: none"> Domain integrated application, Hypervisor Cloud-related service

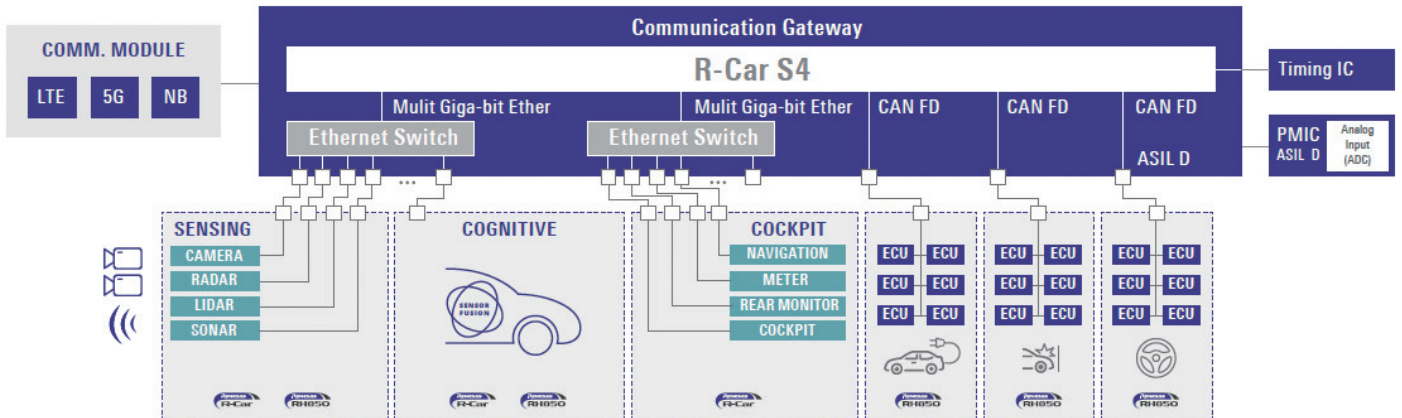

Introduction

With its rich product portfolio, Renesas supports automakers' vision of driving toward the mobility society of the future. The challenges this vision creates are the exponential growth in data bandwidth together with the required service-oriented architecture (SOA). On top of that, advanced functional safety and security features are needed to enable secure data connection between the connected car and cloud services. This mega trend we address with our digital and analog chipset dedicated for Connected Gateway/Car Server applications - a smart chipset solution reducing ECU size and BOM cost.

Key Features R-Car S4 + PMIC + AutoClock™ Timing IC

The Renesas R-Car S4 SoC includes multiple ARM® Cortex® A55, Cortex R52 and is the first SoC offering a full RH850 MCU with multiple cores to control the domain and zone segment. R-Car S4 SoCs support a huge number of automotive interfaces such as 16x CAN FD, 16x LIN, 8x SENT, 1x FlexRay, 4x PCIe V4.0 and an integrated high-bandwidth 3 x 2.5Gbit Ethernet Switch TSN to enable rich communication and connectivity options both inside and outside of the vehicle. Multiple hardware security modules (HSM) provide enhanced security protection against cyber attacks. The entire chipset is being developed in compliance to ISO-26262 to be capable of supporting system safety requirements up to ASIL D.

Benefits

Renesas offer a complete and scalable chipset solution including a tailored PMIC and the new AutoClock™ timing IC and allows an optimized ratio of computing performance versus low power consumption.

By adopting this next generation R-Car S4 customers are able to re-use up to 80% of software code developed for 3rd generation (Gen3) R-Car SoCs and RH850 MCU applications – a clear benefit because it reduces overall project development time/ cost/ risk and allows a better time-to-market. The software package supports real-time cores with various drivers and basic software such as Linux BSP and hypervisors. In addition, a virtual platform (VPF) is available from a partner company, enabling early software development and evaluation.

Samples and evaluation boards are now available for selected customers.

INCREASE COMFORT WITH LESS ENERGY

BODY SYSTEMS



Car body and convenience applications are ever evolving to increase the comfort of both drivers and passengers. Car maker need scalable solutions to have the flexibility to cover a wide range of car models and a broad range of options.

E/E Architecture Evolution and RENESAS Coverage with RL78 and RH850

The updated E/E architecture of todays cars require semiconductor devices to cover

Improved Cybersecurity

- Enhanced Functional Safety
- Handle increasing amounts of data
- Energy efficient operation modes
- Over the air SW updates as the main trends.

Renesas provides cost effective solutions for those challenges by offering scalable roadmaps.

Product range starts at actuator MCU with low pin count (20pin) and extreme low power operation to super high end Zone/Domain controller with 4 times 400MHz CPU operation in a 516BGA package.

Because of that you can find our MCU's in nearly all Body applications like

Zone/Domain ECU, BCM, Lighting, Car access, Wiper, HVAC, Seat, Door, Roof Modules to name only a few.

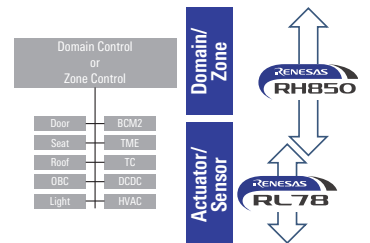

Benefit of RENESAS RL78 MCU

- Scalable line-up from 20pin to 144pin QFP and 16KB to 512KB Flash Memory
- Best-in-class power consumption, and high compute performance, are both possible at low frequency
- High Temperature support Ta=150°C
- Hard- & Software Compatibly within the line-up
- Built-in optimal high-precision / speed on-chip oscillator, power-on reset, etc.

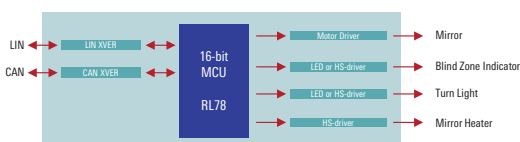

Benefit of RENESAS RH850 MCU

- Scalable Line-ups from 48pin QFP to 516pin BGA and 1MB to 16MB FLASH memory
- Performance up to 7000 DMIPS real-time performance
- ASIL B/D Support
- Hard- & Software Compatibly across the line-ups
- Evita Full/Medium/Light Security Standard
- Expanded Network I/F: Gbit ETH, 16xCAN-FD, ...
- Hypervisor Support
- Full OTA Swap A/B

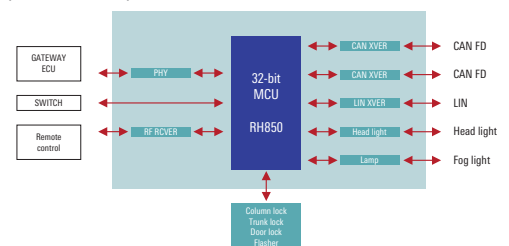

HIGHEST FUNCTIONAL SAFETY CHASSIS & SAFETY SYSTEMS



For chassis systems, the volume of information from sensors is increasing due to the need to coordinate with advanced driver assistance systems (ADAS). Thus, high-speed communication functions as well as high information processing capabilities are needed.

Electric Power Steering

As part of efforts to make their vehicles more environmentally friendly, carmakers have increasingly been switching from hydraulic steering assist systems to electric power steering (EPS) using electric motors in order to reduce weight and boost fuel efficiency. In recent years, there has been a trend toward linking functions that assist the driver in operating the vehicle to the EPS system, for example by providing continuously variable steering gear ratio adjustment according to the running speed and steering angle, in addition to simple power steering functionality.

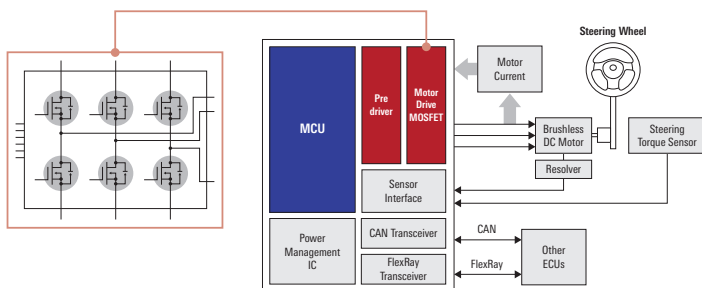

Brake System

There are many types of brake systems, including ABS*, antiskid functions for maintaining vehicle stability, regenerative braking and brake control systems for hybrid and electric vehicles, and central vehicle control systems supporting interoperability with other systems such as the engine. As a result, there is demand for MCUs with a variety of functions and performance levels. As with steering systems, the very highest level of functional safety is essential.

*ABS: Anti-lock Brake System

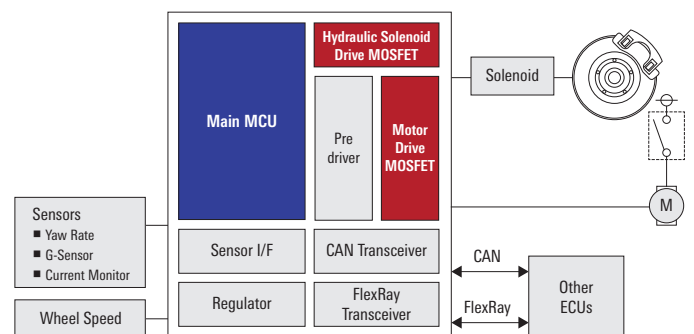

Benefits for chassis & safety application in Renesas Electronics

- ✓ Dedicated motor control timer units
- ✓ High-performance CPU core with lock step
- ✓ High-precision A/D converters
- ✓ Interfaces for communicating with other control units.
- ✓ Variable safety mechanism for supporting ASIL D*

*ASIL: Automotive Safety Integrity Level. ASIL D is the highest Automotive Safety Integrity Level.

THE DRIVING FORCE OF EFFICIENCY

POWERTRAIN

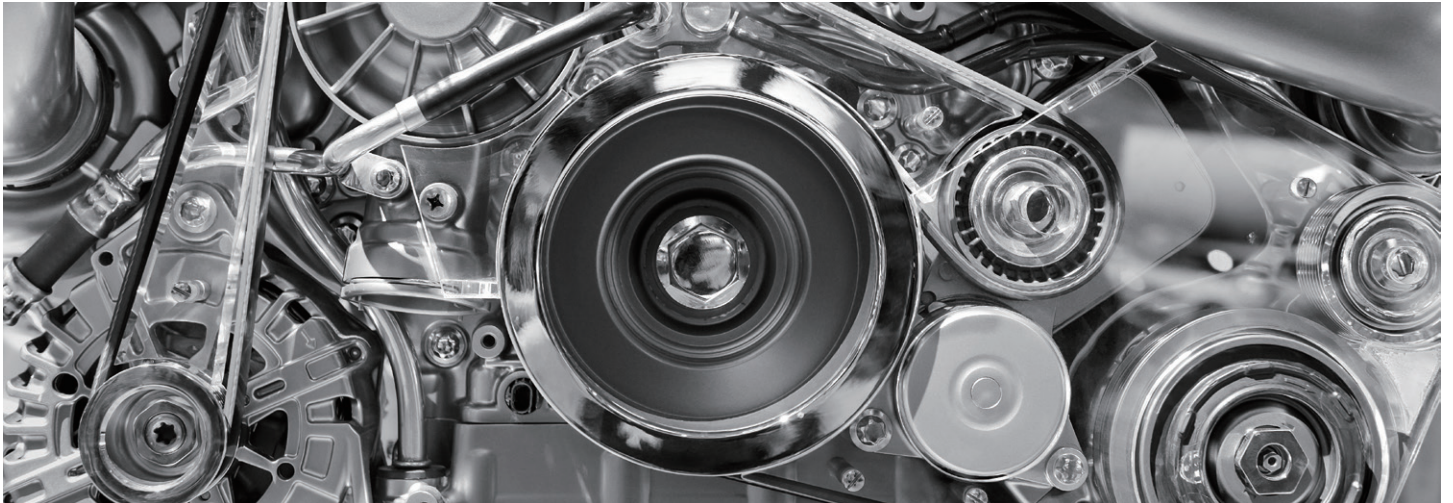

The powertrain segment remains focused on further reduction of emissions and fuel consumption through optimization of traditional ICE engine control concepts.

Domain Controller is becoming a common approach to manage the overall driving strategy between ICE and Electric drive as well as the charging of the car. Renesas' comprehensive product portfolio is committed to automotive quality and ready to cover a wide range of applications, including Diesel- or Gasoline direct /MPI injection, transmission control, powertrain DCU or powertrain Integration concepts:

- **RH850 MCU family** with dedicated products for ICE, including IP's for combustion engine control like GTM, MSC and DS-ADC to reduce the CPU load significantly.
- A full line-up for **analog powertrain components** including gate driver, bridge driver, solenoid as well as tailor-sized power management ICs and discrete MOSFET components.
- Broad product portfolio for **sensor ICs** for manifold air pressure, High temperature sensing, differential pressure (particle filters), air mass flow, position and angle sensing.

■ Block Diagram

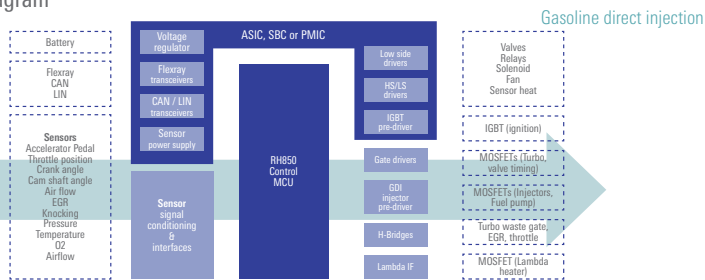

■ Part List/BOM

RH850

32bit Microcontroller → RH850 E2x Series

- Multi-core, ~400MHz
- Integrated IP's for engine control Quality → AECQ100
- Safety → ASIL D
- Security → EVITA Medium

Analog

Sensor Signal Conditioners → SSC family

- ZSSC31xx & ZSSC41xx
- LIN, PWM, SENT, analog & switch out
- Up to ASIL C support.

Power Supply PMIC → RAA27xx family

- Fault diagnosis, ASIL

Inductive Position Sensors → IPS2550

Smart Actuator → RAA family

- Integrated H-Bridge for Throttle, ETC
- Solenoid & BLDC driver
- Gate pre-driver

Intelligent Power Devices → RAJ28000x

- Single Channel High Side Switch
- Full Diagnosis & Protection

■ Block Diagram

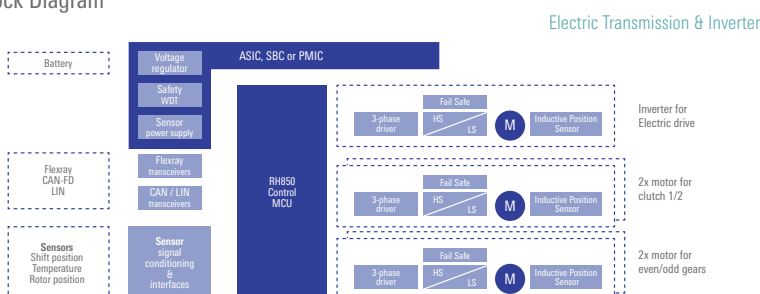

Power

Power Stage → ANL, ANM series

- 12v and 48v PMOS
- Discrete MOSFETs

TOWARDS A SAFER, GREENER AND SMARTER WORLD

EV/HEV



The electrification of the powertrain is mandatory to comply with emission regulation. In addition to mild and full hybrids vehicles, the share of pure electric cars is increasing. Renesas' robust, reliable and safe powertrain solutions help to manage efficient use of energy for the applications mentioned above. Renesas offers many xEV inverter reference solutions:

Reference Solution – System Benefits

- Practical inverter specification for xEV 100kW class motor
- Reference solution kit including Inverter reference design, software, model based design and calibration tool
- Function and performance verified on Renesas dynamometer test bench
- 3.9L compact volume by highly integrated products and temperature management
- Superior power efficiency, Achieved 99% maximum inverter efficiency
- Function proven in real car demo

BOM List for Reference Design

RH850/C1M-A2	32bit Microcontroller embedded Resolver I/F and Motor Control IP
RAA270000	Power management IC (PMIC)
R2A25110	Gate driver IC
RJQ7031/RJU7032	IGBT and FRD
RV1S2752Q	Photo coupler

Block Diagram and Reference Board

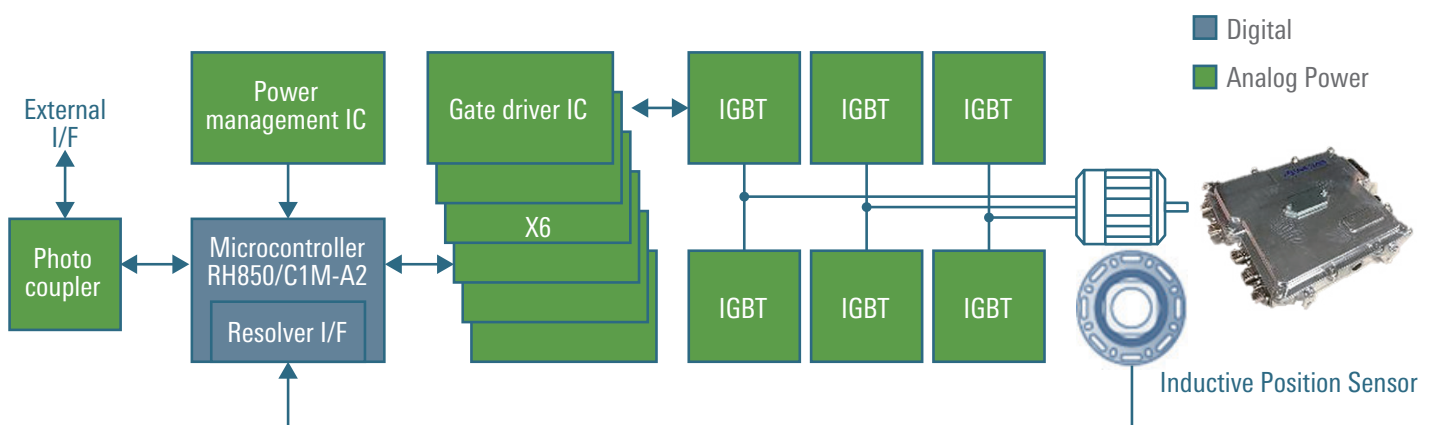

COMPREHENSIVE SOLUTIONS FOR AUTOMOTIVE PRODUCT PORTFOLIO

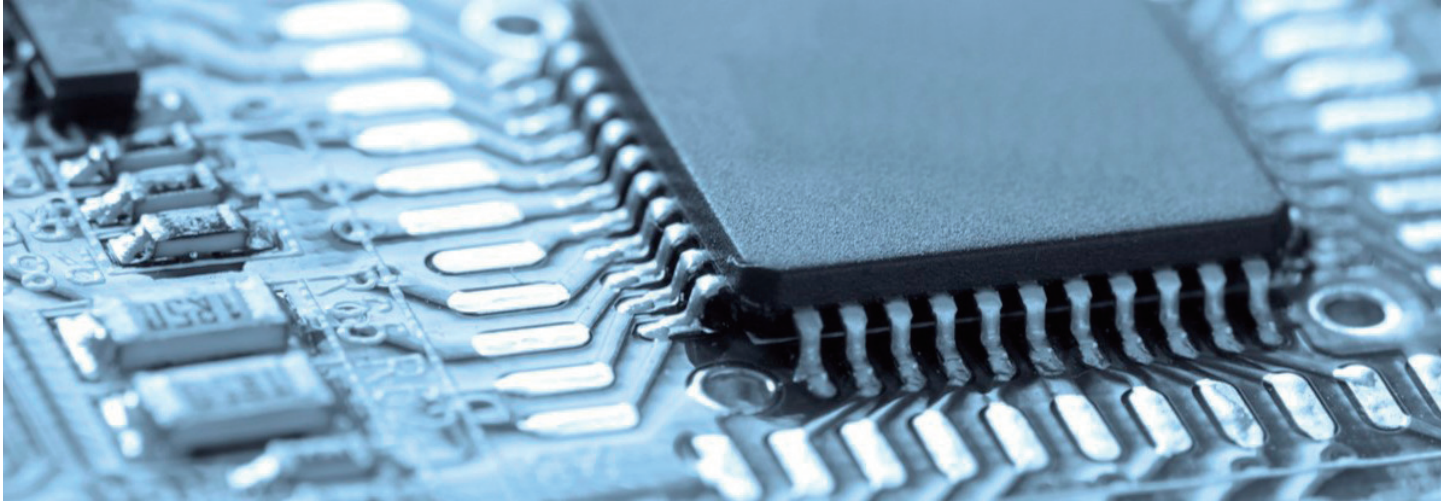

Microcontroller

- 16-/32-bit MCUs (RL78 & RH850)
- Functional Safety
- Security
- AUTOSAR

System-on-Chip Solutions

- R-Car 64-bit SoC Family
- Software Support
- R-Car Consortium

Analog & Power Products

- Bluetooth Low Energy (BLE)
- Haptics Driver
- LED Driver
- Clocks and Timing Solutions
- Sensor Solutions
- Power Management IC (PMIC)
- Battery Management IC (BMIC)
- Video Signal Processing (VSP)
- Wireless Charging IC
- Automotive HD Link (AHL)
- Gate Driver Unit (GDU)
- PowerMOSFETs
- IGBT
- Intelligent Power Devices (IPD)

FACILITATING FLEXIBILITY

MICROCONTROLLER



In response to user requirements that are rapidly expanding in scope, Renesas offers microcontroller products that provide excellent expandability while allowing customers to make full use of existing resources.

Available in a wide array of memory and package options, Renesas MCUs are fast, highly reliable, low in cost and deliver eco-friendly performance. Incorporating the latest process technology, which enables integration of large-capacity flash memory, Renesas MCUs are used in a wide array of applications – meeting the high quality and high reliability standards of the automotive industry.



■ 32-bit high-performance MCUs

- All range applicaiton covered at Automotive
- Multi-core technology
- Scalability of hardware and software
- High performance and low power consumption
- Embedded security features
- Guaranteed high-temperature operation
- AUTOSAR support
- Functional safety support



■ 16-bit ultra-low power MCUs

- All Actuator/Sensor application covered at Automotive
- Wide package and memory scalability
- Industry's lowest level of consumption current
- Guaranteed high-temperature operation
- Hardware safety features
- Built-in a variety of functions for system cost and size reduction

RENESAS SAFETY & SECURITY SUPPORT PROGRAM EASING DESIGN COMPLEXITY



Functional Safety

Together with our customers around the world, and as the holder of a premiere global share in the automotive semiconductor business, Renesas has been investigating state-of-the-art functional safety technologies. We have been participating in ISO Working Group for ISO 26262 and other standardization activities to lead the development of functional safety technologies globally. Leveraging our core competencies of the vast experience gained through these activities and our proven track record recognized by our many customers, we propose new system solutions that are optimized to our customers' systems and that can easily satisfy functional safety requirements.

ISO 26262 is the functional safety related standard of electrical and/or electronic system within automotive industry. Although not legally binding, Renesas is fully committed to comply with this standard, developing MCUs, SoCs, analog and power products used in safety-critical applications according to ISO 26262, thus achieving the required automotive safety integrity level: ASIL A to D.

Renesas functional safety products are well recognized by industry leading customers and partners providing well-thought-out and reliable Safety Element out of Context (SEooC) solutions satisfying a very broad range of applications like safety relevant Motor Control or advanced Automated Driving applications.

Renesas created internal development processes for HW and SW product developments targeting ISO 26262:2011 compliance. Since January 2020 Renesas revised the internal development processes to ISO 26262:2018 edition, to head for product developments according to latest release of the standard.

Customer centricity and time to market are the key success factors for Renesas, to make it easier for you to implement functional safety solutions, Renesas offers the „Functional Safety Support Program for Automotive“ for MCUs and SoCs. It includes, in addition to ISO 26262 work products, a sophisticated FMEDA (Failure Modes, Effects and Diagnostic Analysis) tool named „CAR“ (Customizable Analysis Report, <https://www.renesas.com/products/automotive-products/car-tool>), technical support for functional safety work products, those explanation sessions and versatile software solutions like software test libraries which are developed according to ISO 26262.

Security

The automotive industry is transforming due to the Connected, Automated, Shared & Services, and Electrified (CASE) megatrends; recent years the importance of vehicle security has taken on a new meaning. Renesas is utilizing our expertise in advanced functional safety in building a robust security culture through industry participation and cybersecurity technology development. Renesas is a contributing member to several national and international security standards such as ISO/SAE 21434, and SAEJ3101. Renesas uses these as a foundation for the Renesas Security Design Lifecycle (SDL) to promote best practices throughout the product lifecycle. Concerning specific technology, Renesas device has an important role as the provider of the Root of Trust within an ECU. Through our innovative portfolio of Hardware Security Modules (HSM), cryptographic accelerators, and security software, Renesas offers security solutions to meet customer requirements across product domains. Furthermore, Renesas strives to meet the State of the Art for advanced cybersecurity features such as cryptographic algorithms, logical/physical attacks mitigation and data latencies concerns; we are constantly monitoring the market to make sure our IP will meet or exceed the current industry demand while anticipating future cybersecurity needs through a holistic approach to our next generation SoCs and MCUs.

COMPUTING POWER MEETS VISION PERFORMANCE R-CAR SYSTEM-ON-CHIP SOLUTIONS



Renesas' system-on-chip (SoC) family, R-Car, is designed for advanced driver assistance systems (ADAS), autonomous drive (AD), car information systems, and connected gateways. Renesas offers end-to-end total solutions from cloud services to sensing and vehicle control that contribute to an autonomous driving society.

R-Car in The Future Car Architecture

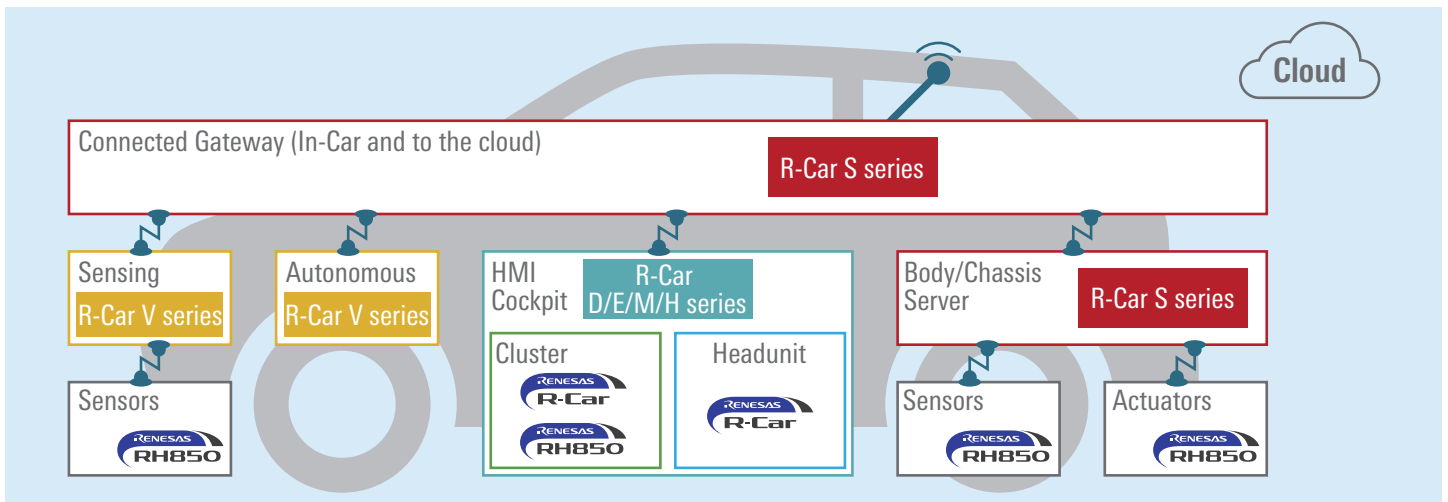

R-Car Key Features

- ✓ Scalable line-up up from Gen3 to Gen4
- ✓ Common HW architecture on major in-vehicle functions
- ✓ Functional Safety support (ISO26262)
- ✓ Integration of in-vehicle peripheral functions (e.g. CAN-FD, FlexRay) and real-time core
- ✓ Advanced function support with dedicated HW engine and scalable performance

Benefits

- ✓ Enable high coverage of ADAS/AD, GW, Cockpit/IVI, and Cluster applications
- ✓ High re-usability of customer assets within R-Car line-up and between generations
- ✓ Contribution to ASIL B~D support of customer systems
- ✓ Contribution to BOM cost reduction
- ✓ Combination of CNN and image recognition engines realizes advanced computer vision processing



REDUCE DEVELOPMENT LOAD THROUGH ECOSYSTEM THE R-CAR CONSORTIUM

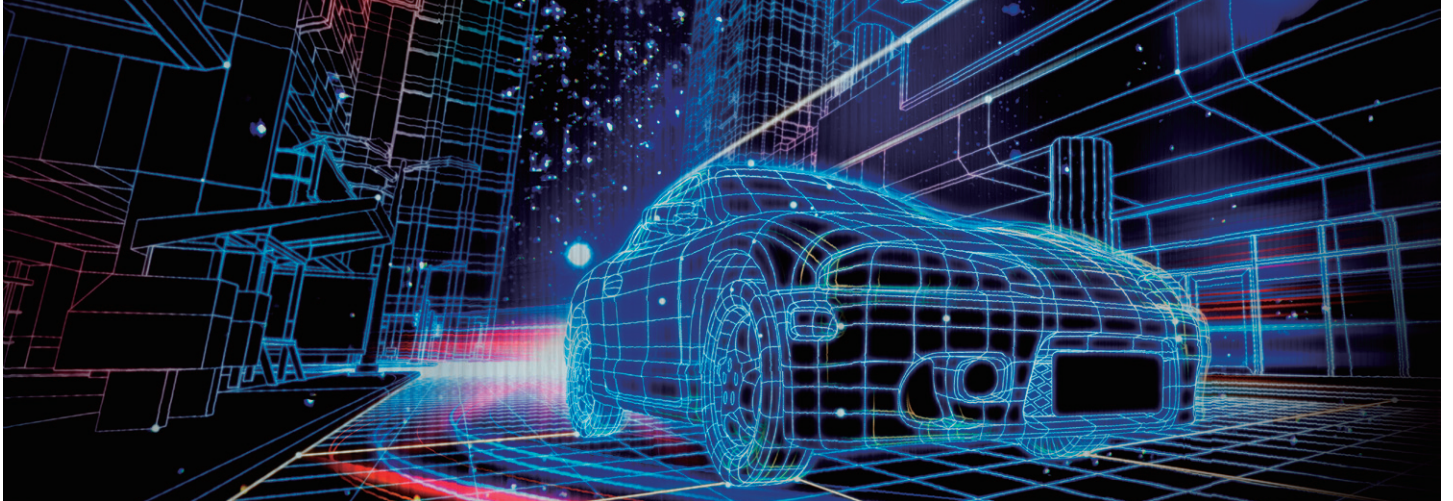

The **R-Car Consortium** brings together system integrators, middleware/application developers, and operating system and tools vendors who are developing solutions for the Connected Car & ADAS market. With highly reliable and technically advanced SoCs from Renesas, and end-to-end development support, customers can get optimal solutions for their requirements. Members of the Consortium receive evaluation boards and software to help co-develop advanced Connected Car & ADAS solutions.

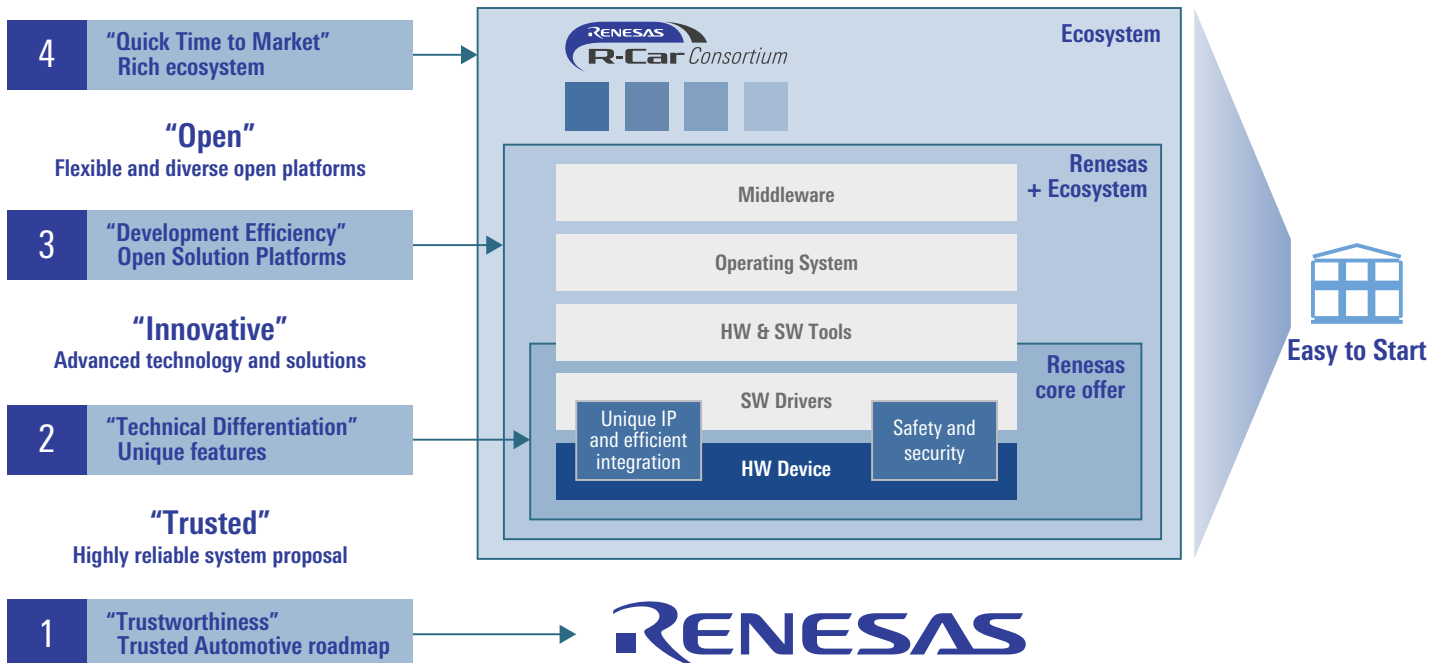

R-Car Consortium: <https://www.renesaspartners.com/>

PROVIDE EASY-TO-USE, EASY-TO-START DEVELOPMENT ENVIRONMENT

R-CAR MARKET PLACE

Online Market Place for R-Car

Renesas launched online Market Place, which offers a one-stop source of solutions that help accelerate technical innovation for the future mobility market. Developers can download various solutions designed for Renesas' R-Car automotive system-on-chips (SoCs) directly from the Market Place. Developers can also use the Market Place as a portal to obtain reference evaluation software from R-Car Consortium Proactive Partners or contact Proactive Partner companies directly, allowing for timely support to match customer requirements. Through the Market Place, developers can quickly and easily access R-Car evaluation software, documentation such as hardware manuals, technical updates, application notes, and basic software such as Linux and Android board support packages (BSPs).

Proactive Partners



[Market place press release](#)

Proactive Partners 2021



STANDARDIZED SOFTWARE FRAMEWORK **AUTOSAR SUPPORT**



AUTOSAR is a worldwide development partnership of car manufacturers, suppliers and other companies from the electronics, semiconductor and software industry targeting software architecture standardization of Electronic Control Units (ECUs).

Renesas, registered as Premium member of the AUTOSAR partnership, is deeply involved in standardization activities resulting in developing and releasing of MCAL (Microcontroller Abstraction Layer) software optimized for their RH850 and R-Car product series.

AUTOSAR BSW packages for Renesas MCU's and SoC's are available by major 3rd party cooperation partner.

NEW CAPABILITIES BY JOINING FORCES

ANALOG & POWER PRODUCTS

By joining forces, Renesas, Intersil, IDT and Dialog, have created the leading embedded solutions and analog mixed-signal products company, uniquely positioned to help customers succeed in developing innovative applications in the automotive segment.

Our combined portfolio will contribute to accelerating your development and enabling differentiation, while bringing predictability to your application.

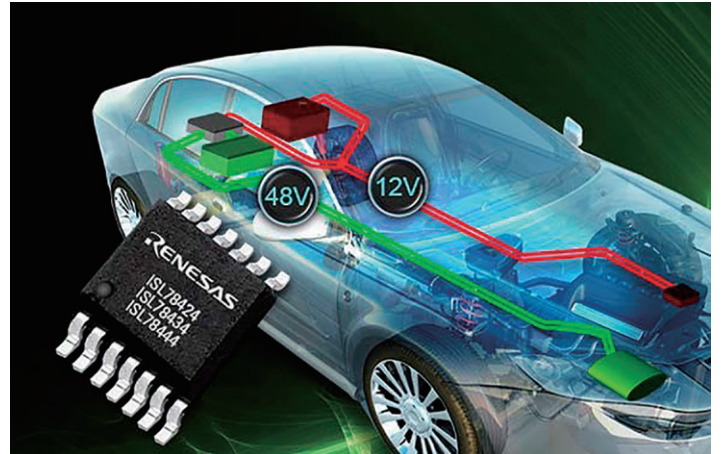

Analog & Power Product Line Up

Rich analog and power products to cover growing application fields

		Application Domains					
		ADAS	Cockpit	E/E Architecture	Powertrain	xEV	Chassis & Body
RENEASIS	Power Management IC (PMIC)						
	Configurable Mixed-Signal IC (CMIC)						
		LED backlight driver					
		Haptics driver				Connectivity (BLE)	
		Video Signal Processor				Battery Management IC	
	Analog HD Link						
	Timing IC			Sensor Conditioner			
	LiDAR	Wireless Charging				Position Sensor	
	RADAR					Gate Driver	
						IGBT	
						MOSFET	
	Intelligent Power Device						

NEW CAPABILITIES BY JOINING FORCES

ANALOG & POWER PRODUCTS

Clocks and Timing Solutions

Renesas offers the broadest and deepest silicon timing portfolio in the industry. In addition to our wide selection of buffers and clock synthesizer products, we deliver leading-edge system timing solutions to resolve timing challenges in virtually any application.

■ Features

- Lowest phase noise and highest performance <500fs and PCIe Gen5 clock on 5P49V60A
- Industry's broadest and deepest portfolio
- Proven expertise in both analog and digital timing
- Advanced timing technology
- Offer flexibility for diversified timing Requirement (Any frequency support on 5P49V60A)

■ Benefits

- Extensive online tools library
- Deep knowledge base / FAQ
- Complimentary clock tree design and review services
- Expert engineering support

■ VersaClock Auto Application Block Diagram

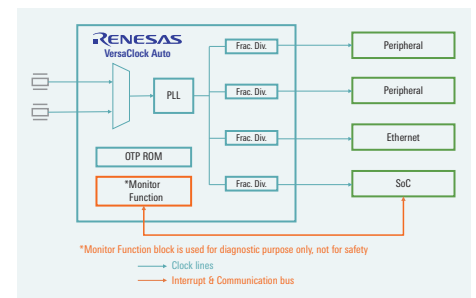

Sensor Solutions

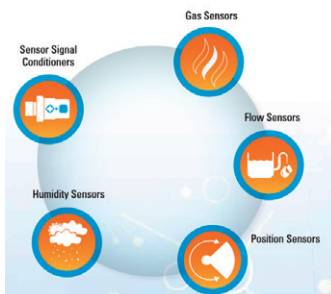

With more than 20 years of industry experience, Renesas is an expert in providing sensor technologies that enable our customers to design and build best-in-class sensor solutions. As we expand the breadth of our sensor technologies, Renesas will create unique and differentiated sensor solutions

Automotive Solutions with "Single-pass" Calibration

Renesas' automotive sensor signal conditioning ICs are all-in-one, energy efficient products that are easy-to use. Our single-pass operation calibration lowers costs by reducing test time without compromising precision, enabling design of cost-effective, accurate sensing systems. These SSCs also offer best-in-class performance with highly integrated operations and support for ISO26262, Automotive EMC, and reliability

Inductive Position Sensor

Inductive Position Sensor is a product, which has a broad customer base with various applications. This system does not use a magnet. Inductive sensor is robust against environmental contaminants and provides excellent stray field immunity.

■ Features

- Contactless position sensor with Sin/cos output differential output signals
- Automotive qualified AECQ100 grade 0 with temperature range from -40°C up to +160°C
- ISO26262 supports up to ASIL C requirements
- Maximum rotational speed up to 600,000 rpm
- Totally stray field immune

■ Benefits

- Superior accuracy and resolution by thinner, lighter and much more cost effective than resolvers
- Allows through- and side-shaft sensor design
- Superior accuracy by matching the sensor sectors to the number of pole pair of the motor

■ Application Examples

- Electric Power Steering (EPS) - BLDC
- Traction Motors
- xSG - Belt or Integrated Starter Generator
- Electric Park Brake
- Oil Pump Motors

NEW CAPABILITIES BY JOINING FORCES

ANALOG & POWER PRODUCTS

Power Management IC

Renesas power management IC's are designed as the complimentary power solutions for Renesas MCU's and SoC's. Their optimized performance helps to reduce system BOM cost, PCB area and system design development time.

■ Features

- Ideal power solution for Renesas MCU and SoC. (e.g. RH850/E1x/C1x/P1x, R-Car Gen3, Gen4)
- Integrated fault diagnosis and monitor functions for ASIL applications

■ Benefits

- Optimized specifications help reduce system BOM cost and PCB area
- Closely aligned MCU/SoC and PMIC Solutions offer optimized development times

■ Application Example Connected to RH850/E1x/C1x

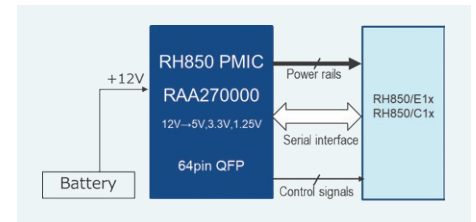

Battery Management IC

Battery management IC's have the best voltage measurement accuracy (Initial accuracy $< \pm 2.0\text{mV}$) and Long-Term Drift ($< \pm 6\text{mV}@6\sigma$ after 15 years on board). ASIL D Battery Management System (BMS) Design Solution available in combination with RH850/P1M.

■ Features

- Class leading on-board accuracy
* $\pm 2.5\text{mV} \pm 3\sigma$ post solder
- ISO26262 ASIL D support
- $\pm 5\text{V}$ cell input measurement range
*For Fuel Cells & Bus Bars
- Low power, high security Daisy Chain
*Capacitor or Transformer coupling
- System level S/W Drivers/Support
*ASIL D Complex Device Drivers

■ Benefits

- BMS Reference Design with ISL78714 (BMIC) & RH850/P1M (MCU)
*Available Complex S/W Drivers
*Reduce R&D Effort
- Lowest BOM Cost
- Excellent Hot-Plug performance
- Best Long-Term Drift measurement accuracy
- Balance All Cells Simultaneously

■ BMS Reference Design

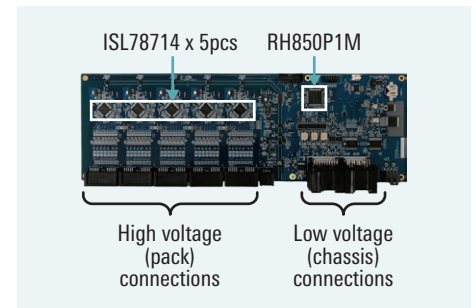

Video Signal Processing (VSP)

Renesas VSP products include basic Analog Video Decoders and Advanced LCD Controllers. Optimized for Automotive video & display applications, providing best-in-class video quality, system robustness & flexibility.

■ Features

- 1 & 4 Channel Analog Video Decoders
*Supports BT.656 or MIPI-CSI2 output
*Built-in diagnostics (short detection)
- Highly Integrated LCD Controllers
*Supports Digital & Analog inputs up to 1080p/60
*Integrated Image Diagnostics with Frozen & Corrupt Image Detection
*Drives most automotive LCD panels
*H/W based Fast Boot ($< 500\text{ms}$)

■ Benefits

- Video Decoders provide superior video quality with low power consumption
- LCD Controllers add versatility and reliability to Automotive Display Systems
*Arbitrary horizontal & vertical video scaling for any resolution up to Full HD 1080p
*Flexible I/O's: MIPI-CSI2, LVDS, TTL, Analog

■ VSP Product Categories

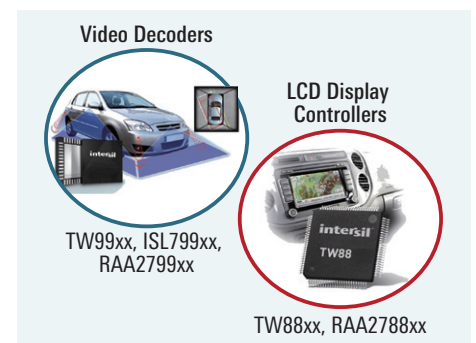

NEW CAPABILITIES BY JOINING FORCES

ANALOG & POWER PRODUCTS

Wireless Charging IC

Qi compatible wireless charging ICs for Automotive deliver charging speeds that rival traditional plug-in charging

Features

- Industry first, flexible ARM® Cortex®-M0-based SoC architecture
- Industry-leading efficiency
 - ✓ >75% end-to-end
 - ✓ As fast as wired
 - ✓ Cool operation temperature
- Very low EMI
- Unique and proven hardware / algorithm implementation

Benefits

- Significant reduction of charging time by up to 20W wireless solutions
- Design support:
 - ✓ reference design kits enable fast prototyping and time to market
 - ✓ Extensive documentation library



Automotive HD Link (AHL)

Automotive High-Definition Link (AHL) is a new video transmission technology designed to reduce the cost of transporting high resolution video from the camera to the ECU. Optimized for parking assistance applications.

Features

- HD Video Transmission Link
 - *RAA279971 AHL video encoder
 - *RAA279972 AHL 1ch video decoder
- No Latency
- Independent Control Channel
 - *Works without active video
- Robust against interference
- Supports non-standard resolutions
- Up to 30m transmission distance

Benefits

- Reduce HD camera system costs by utilizing lower cost cables (UTP) and connectors.
- Re-use existing NTSC camera cable infrastructure with HD camera resolutions
- Initialize camera from the ECU with built-in bi-directional control channel (I2C)



Gate Driver Unit (GDU)

Renesas GDU is a product designed for xEV inverter. The performance has been proven by Renesas reference board and it contributes the reduction of BOM cost and engineering development workload.

Features

- Low Ron (1 ohm max.), IGBT gate driver with 2.5k Vrms isolation
- Support IGBT parallel connection
- Built-in analog I/F can help to monitor the operation condition of secondary side (IGBT side)

Benefits

- Provides cost-effective solution (20% BOM Cost reduction expected)
- Contributes to reduced engineering development workload

Solution Example

Inverter reference design with GDU

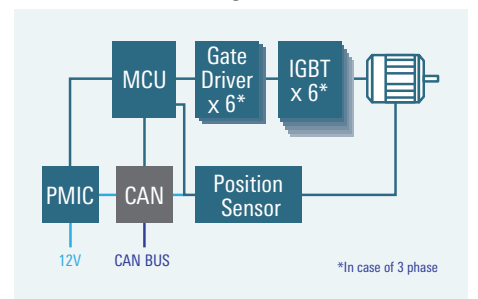

NEW CAPABILITIES BY JOINING FORCES

ANALOG & POWER PRODUCTS

AUTOMOTIVE SENSOR SIGNAL CONDITIONER (SSC)

Renesas' best-in-class automotive sensor signal conditioning (SSC) ICs are optimized to withstand harsh automotive environments, requiring low supply current to reduce power consumption (critical for PHEV, BEV and FCEV vehicles), offering excellent EMC and ESD protection to ensure safety and reliability.

■ Features

- Capable of measuring resistive bridge sensor signals
- Temperature measurement using external diode/PTC/TCR or internal (PTAT) sensor
- Ability to cover large sensor span & high accuracy over the entire temp. range (-40°C to 150°C)
- Over-voltage and reverse polarity protection, robust EMC performance, and multiple diagnostic features
- Output signal as ratio-metric analog or digital SENT

■ Benefits

- Flexible adoption of the bridge sensor technology, offering offset compensation and high analog gain
- Best-in-class signal processing technology delivering highly accurate and enhanced output signal
- Minimal EOL (end-of-line) production costs during mass production using digital calibration
- Minimum amount of external components to design of sensor modules with best-in-class form factor

Renesas' Highly Accurate, Cost-Effective Pressure Sensing Solution for Automotive



GreenPAK™ CONFIGURABLE MIXED-SIGNAL ICs (CMICs)

Configurable solutions enable flexible electronic designs while reducing BoM count, cost, and sourcing issues

■ Features

- Cost effective NVM programmable IC containing digital and analog resources which can be implemented into 100s of different functions
- With GreenPAK designer software/development kit, quickly respond to changing design requirements and increase productivity at the design and prototype verification stages

■ Benefits

- Reduce solution size, cost & power consumption
- Dramatically reduce reliability issues
- Configurability allows fast cost-effective differentiation

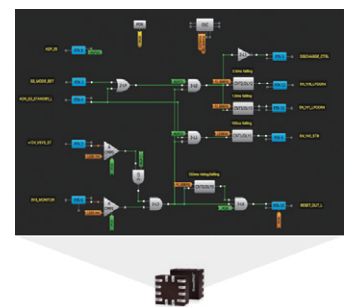

BLUETOOTH LE (BLE)

Ultra low power, ultra compact Bluetooth LE IC for wireless sensor applications

■ Features

- Lowest power consumption
- 2-way communication
- Removes need for dedicated control unit

■ Benefits

- Low-cost manufacturing on 2L PCB
- Minimum BOM
- Space optimized PCB trace antenna reference designs available

■ Application Example

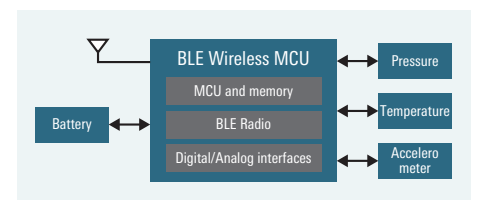

NEW CAPABILITIES BY JOINING FORCES

ANALOG & POWER PRODUCTS

HAPTICS DRIVER

Low-power, wide-bandwidth haptic driver for vibrations and clicks using ERM (eccentric rotating mass motor) and LRA (linear resonant actuator) applications

■ Features

- Dynamic display control panels in the cabin that utilize haptics to provide immediate feedback to the driver – gives tactile feedback
- Provides multiple feedback states – not just a simple click
- Applications : Button replacement, Rotary Encoding, Steering wheel fingertip feedback, etc

■ Benefits

- 80% lower idle current than the competition
- AEC-Q100 Grade 2, 3x3mm WFQFN package



LED BACKLIGHT DRIVER

Advanced technology solutions enable local dimming, high-contrast, high-quality, large displays

■ Features

- 32 channels
- Integrated current sink MOSFETs
- External current sense resistors for flexibility and accuracy in broad range of LED applications
- Comprehensive protection features

■ Benefits

- Patented BroadLED™ adaptive switch technology
- Reduces power dissipation in the driver
- Maintains operation during LED short with minimal temperature increase
- Enables use of less costly, loosely binned LED arrays for lower BOM cost
- AnyMode™ technology reduces video motion blur
- 13-bit PWM dimming and 11-bit analog dimming improve dynamic range



NEW CAPABILITIES BY JOINING FORCES

ANALOG & POWER PRODUCTS

Renesas offers an extensive lineup of power MOSFET products covering a wide range of voltage and current ratings as well as different package types to enable customers building various types of electric equipment to select the optimal device for their specific application. We also supply bare-die IGBT products that enable customers to achieve an ideal match with the modules they design as well as IPDs (intelligent power devices).

Power MOSFETs

Focusing performance driven application to contribute to system innovation. (high efficiency, down-sizing, robust design)

Features

- WW Top class Low Ron with Super junction structure
- Extensive lineup for 12V / 48V battery application
- Excellent quality
- Customized Bare Die support for pad layout & shipment form

Benefits

- High efficiency based on excellent Ron and switching performance
- Down-sizing by selecting optimized package from product line-up and bare die support options
- Robust design with high withstanding capability and sensing option

Low Ron package Tape & Reel

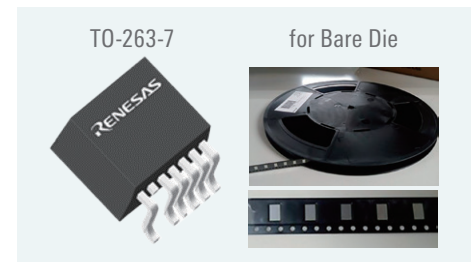

IGBT

Renesas supplies bare-die IGBT products that enable customers to achieve an ideal matching with the system and modules they design.

Features

- High performance & high quality IGBT bare die for HEV/PHV/EV
- WW Top level performance achieved with low Vce (sat) and faster switching
- Voltage rating variations from 650V to 1200V
- Current and Temp sensing (optional)

Benefits

- High efficiency and low heat generation based on low power consumption
- Enable to adopt various mounting method with top metal options
- High quality based on various testing options and qualification test

Thin Wafer Technology

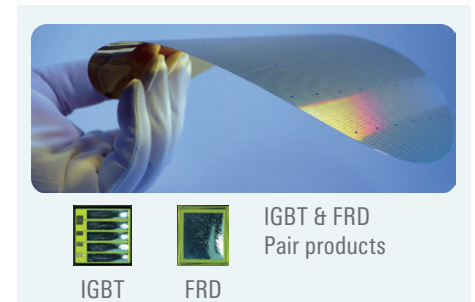

Intelligent Power Device (IPD)

Replaces mechanical relays for longer lifetime, smaller size, lighter weight, and extended functionality.

Features

- Proven MOSFET and Control-Chip Technology in a single package
- Low ON-Resistance and wide SOA
- Self-protection against short circuit, overcurrent and overtemperature
- Self-diagnostic and monitoring functions
- High max operating temperature
- AEC-Q100 qualified and RoHS compliant

Benefits

- Mechanical relay replacement offering better lifetime, size, weight and functionality
- Switching of high currents of more than 30A
- Easy control by MCU with reduced power consumption
- Contributing to high system reliability by integrated smart protections
- Efficient drive of resistive, inductive or capacitive loads

Solution Example

IPD outputs power supply and protects itself & loads

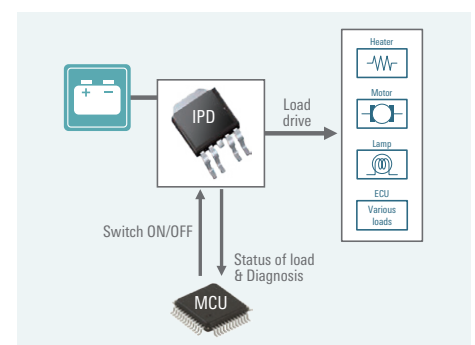

Notice

1. Descriptions of circuits, software and other related information in this document are provided only to illustrate the operation of semiconductor products and application examples. You are fully responsible for the incorporation or any other use of the circuits, software, and information in the design of your product or system. Renesas Electronics disclaims any and all liability for any losses and damages incurred by you or third parties arising from the use of these circuits, software, or information.
 2. Renesas Electronics hereby expressly disclaims any warranties against and liability for infringement or any other claims involving patents, copyrights, or other intellectual property rights of third parties, by or arising from the use of Renesas Electronics products or technical information described in this document, including but not limited to, the product data, drawings, charts, programs, algorithms, and application examples.
 3. No license, express, implied or otherwise, is granted hereby under any patents, copyrights or other intellectual property rights of Renesas Electronics or others.
 4. You shall be responsible for determining what licenses are required from any third parties, and obtaining such licenses for the lawful import, export, manufacture, sales, utilization, distribution or other disposal of any products incorporating Renesas Electronics products, if required.
 5. You shall not alter, modify, copy, or reverse engineer any Renesas Electronics product, whether in whole or in part. Renesas Electronics disclaims any and all liability for any losses or damages incurred by you or third parties arising from such alteration, modification, copying or reverse engineering.
 6. Renesas Electronics products are classified according to the following two quality grades: "Standard" and "High Quality". The intended applications for each Renesas Electronics product depends on the product's quality grade, as indicated below.
 - "Standard": Computers; office equipment; communications equipment; test and measurement equipment; audio and visual equipment; home electronic appliances; machine tools; personal electronic equipment; industrial robots; etc.
 - "High Quality": Transportation equipment (automobiles, trains, ships, etc.); traffic control (traffic lights); large-scale communication equipment; key financial terminal systems; safety control equipment; etc.
 Unless expressly designated as a high reliability product or a product for harsh environments in a Renesas Electronics data sheet or other Renesas Electronics document, Renesas Electronics products are not intended or authorized for use in products or systems that may pose a direct threat to human life or bodily injury (artificial life support devices or systems; surgical implantations; etc.), or may cause serious property damage (space system; undersea repeaters; nuclear power control systems; aircraft control systems; key plant systems; military equipment; etc.). Renesas Electronics disclaims any and all liability for any damages or losses incurred by you or any third parties arising from the use of any Renesas Electronics product that is inconsistent with any Renesas Electronics data sheet, user's manual or other Renesas Electronics document.
 7. No semiconductor product is absolutely secure. Notwithstanding any security measures or features that may be implemented in Renesas Electronics hardware or software products, Renesas Electronics shall have absolutely no liability arising out of any vulnerability or security breach, including but not limited to any unauthorized access to or use of a Renesas Electronics product or a system that uses a Renesas Electronics product. RENESAS ELECTRONICS DOES NOT WARRANT OR GUARANTEE THAT RENESAS ELECTRONICS PRODUCTS, OR ANY SYSTEMS CREATED USING RENESAS ELECTRONICS PRODUCTS WILL BE INVULNERABLE OR FREE FROM CORRUPTION, ATTACK, VIRUSES, INTERFERENCE, HACKING, DATA LOSS OR THEFT, OR OTHER SECURITY INTRUSION ("Vulnerability Issues"). RENESAS ELECTRONICS DISCLAIMS ANY AND ALL RESPONSIBILITY OR LIABILITY ARISING FROM OR RELATED TO ANY VULNERABILITY ISSUES. FURTHERMORE, TO THE EXTENT PERMITTED BY APPLICABLE LAW, RENESAS ELECTRONICS DISCLAIMS ANY AND ALL WARRANTIES, EXPRESS OR IMPLIED, WITH RESPECT TO THIS DOCUMENT AND ANY RELATED OR ACCOMPANYING SOFTWARE OR HARDWARE, INCLUDING BUT NOT LIMITED TO THE IMPLIED WARRANTIES OF MERCHANTABILITY, OR FITNESS FOR A PARTICULAR PURPOSE.
 8. When using Renesas Electronics products, refer to the latest product information (data sheets, user's manuals, application notes, "General Notes for Handling and Using Semiconductor Devices" in the reliability handbook, etc.), and ensure that usage conditions are within the ranges specified by Renesas Electronics with respect to maximum ratings, operating power supply voltage range, heat dissipation characteristics, installation, etc. Renesas Electronics disclaims any and all liability for any malfunctions, failure or accident arising out of the use of Renesas Electronics products outside of such specified ranges.
 9. Although Renesas Electronics endeavors to improve the quality and reliability of Renesas Electronics products, semiconductor products have specific characteristics, such as the occurrence of failure at a certain rate and malfunctions under certain use conditions. Unless designated as a high reliability product or a product for harsh environments in a Renesas Electronics data sheet or other Renesas Electronics document, Renesas Electronics products are not subject to radiation resistance design. You are responsible for implementing safety measures to guard against the possibility of bodily injury, injury or damage caused by fire, and/or danger to the public in the event of a failure or malfunction of Renesas Electronics products, such as safety design for hardware and software, including but not limited to redundancy, fire control and malfunction prevention, appropriate treatment for aging degradation or any other appropriate measures. Because the evaluation of microcomputer software alone is very difficult and impractical, you are responsible for evaluating the safety of the final products or systems manufactured by you.
 10. Please contact a Renesas Electronics sales office for details as to environmental matters such as the environmental compatibility of each Renesas Electronics product. You are responsible for carefully and sufficiently investigating applicable laws and regulations that regulate the inclusion or use of controlled substances, including without limitation, the EU RoHS Directive, and using Renesas Electronics products in compliance with all these applicable laws and regulations. Renesas Electronics disclaims any and all liability for damages or losses occurring as a result of your noncompliance with applicable laws and regulations.
 11. Renesas Electronics products and technologies shall not be used for or incorporated into any products or systems whose manufacture, use, or sale is prohibited under any applicable domestic or foreign laws or regulations. You shall comply with any applicable export control laws and regulations promulgated and administered by the governments of any countries asserting jurisdiction over the parties or transactions.
 12. It is the responsibility of the buyer or distributor of Renesas Electronics products, or any other party who distributes, disposes of, or otherwise sells or transfers the product to a third party, to notify such third party in advance of the contents and conditions set forth in this document.
 13. This document shall not be reprinted, reproduced or duplicated in any form, in whole or in part, without prior written consent of Renesas Electronics.
 14. Please contact a Renesas Electronics sales office if you have any questions regarding the information contained in this document or Renesas Electronics products.
- (Note 1) "Renesas Electronics" as used in this document means Renesas Electronics Corporation and also includes its directly or indirectly controlled subsidiaries.
 (Note 2) "Renesas Electronics product(s)" means any product developed or manufactured by or for Renesas Electronics.

(Rev.5.0-1 October 2020)

SALES OFFICES

Refer to "<http://www.renesas.com/>" for the latest and detailed information.

Renesas Electronics Corporation

TOYOSU FORESIA, 3-2-24 Toyosu, Koto-ku, Tokyo 135-0061, Japan

Renesas Electronics America Inc. Milpitas Campus

1001 Murphy Ranch Road, Milpitas, CA 95035, U.S.A.
 Tel: +1-408-432-8888, Fax: +1-408-434-5351

Renesas Electronics America Inc. San Jose Campus

6024 Silver Creek Valley Road, San Jose, CA 95138, USA
 Tel: +1-408-284-8200, Fax: +1-408-284-2775

Renesas Electronics Canada Limited

603 March Road, Ottawa, ON K2K 2M5, Canada
 Tel: +1-613-595-6300, Fax: +1-613-595-6329

Renesas Electronics Europe GmbH

Arcadiastrasse 10, 40472 Düsseldorf, Germany
 Tel: +49-211-6503-0, Fax: +49-211-6503-1327

Renesas Electronics (China) Co., Ltd.

Room 101-T01, Floor 1, Building 7, Yard No. 7, 8th Street, Shangdi, Haidian District, Beijing 100085, China
 Tel: +86-10-8235-1155, Fax: +86-10-8235-7679

Renesas Electronics (Shanghai) Co., Ltd.

Unit 301, Tower A, Central Towers, 555 Langao Road, Putuo District, Shanghai 200333, China
 Tel: +86-21-2226-0888, Fax: +86-21-2226-0999

Renesas Electronics Hong Kong Limited

Unit 3501-03, 35/F, One Kowloon, 1 Wang Yuen Street, Kowloon Bay, Hong Kong
 Tel: +852-2265-6688, Fax: +852-2886-9022

Renesas Electronics Taiwan Co., Ltd.

13F, No. 363, Fu Shing North Road, Taipei 10543, Taiwan
 Tel: +886-2-8175-9600, Fax: +886-2-8175-9670

Renesas Electronics Singapore Pte. Ltd.

80 Bendemeer Road, #06-02 Singapore 339949
 Tel: +65-6213-0200, Fax: +65-6213-0300

Renesas Electronics Malaysia Sdn.Bhd.

Unit No 3A-1 Level 3A Tower 8 UOA Business Park, No 1 Jalan Pengaturcara U1/51A, Seksyen U1, 40150 Shah Alam, Selangor, Malaysia
 Tel: +60-3-5022-1288, Fax: +60-3-5022-1290

Renesas Electronics India Pvt. Ltd.

Bagmane Tech Park, Municipal No. 66/1-4, Lakeview Block, Block B, Ground Floor, Krishnappa Garden, CV Raman Nagar, Bengaluru, Karnataka 560 093, India
 Tel: +91-80-67208700

Renesas Electronics Korea Co. Ltd.

7F, Hae-seong 2nd building, 508, Teheran-ro, Gangnam-gu, Seoul, Korea 06178
 Tel: +82-2-558-3737, Fax: +82-2-558-5338