

MOTOR SOLUTIONS

User-Friendly Motor Control Development Environment to Shorten Time to Market



RENESAS MOTOR SOLUTIONS FOR A GREENER SOCIETY

Renesas offers semiconductor products with low environmental impact throughout their life cycle in the interest of coexistence with the planet and harmony between humankind and the environment.



As the scope of motor applications has broadened in recent years, Renesas semiconductor devices for motors have come to be used in a wide variety of fields. Renesas provides customers with optimal motor solutions to help realize a greener society.

CONTENT

Motor Solution of Renesas _____	03	Whole Speed Range Sensorless Vector Control Solution for IPM Motors _____	18
Motor Types and Features _____	04	Digital Control Solution for 3-Level Inverter Power Supplies _____	19
Motor Control Method _____	05	Motor Control Development Support Tool _____	20
Position Sensor of Motor _____	05	RAA227063 3-Phase Smart Gate Drivers _____	26
Renesas Solutions for Motor Types and Control Methods _____	06	RAA306012 3-Phase Smart Gate Drivers _____	27
Solutions for Permanent Magnet Synchronous Motor (BLDC Motor) _____	07	HVPAK™ _____	28
Solutions for 9-axis Motor Control (BLDC Motor) _____	12	Solutions for DC / Stepper Motors, Solenoid, LED, and DC-DC _____	29
Solutions for AC Synchronous Motors _____	13	Recommended Products: MCUs and MPUs _____	30
Solutions for Stepping Motor _____	14	Recommended Products: Motor Sensor Processing IC, Motor Control IC _____	31
Solutions for AC Induction Motor _____	16	Recommended Products: Power Management _____	32
Solutions Using Magnetic Sensors _____	16	Recommended Products: Gate Driver, MOSFET, Peripheral IC _____	33
Solutions Using Inductive Position Sensors _____	17	Winning Combinations _____	38

Powerful Support for Customers' Development Efforts

Motor Solutions

Basic Motor Control Configuration

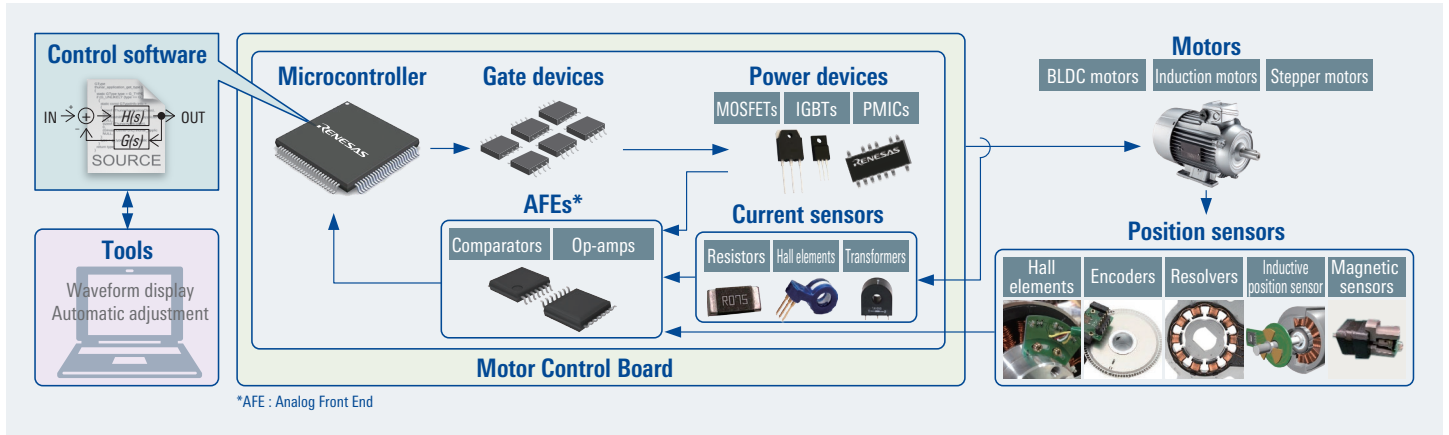

Motor Solution Classification

Renesas motor solutions are comprised of devices, hardware, software, and tools.

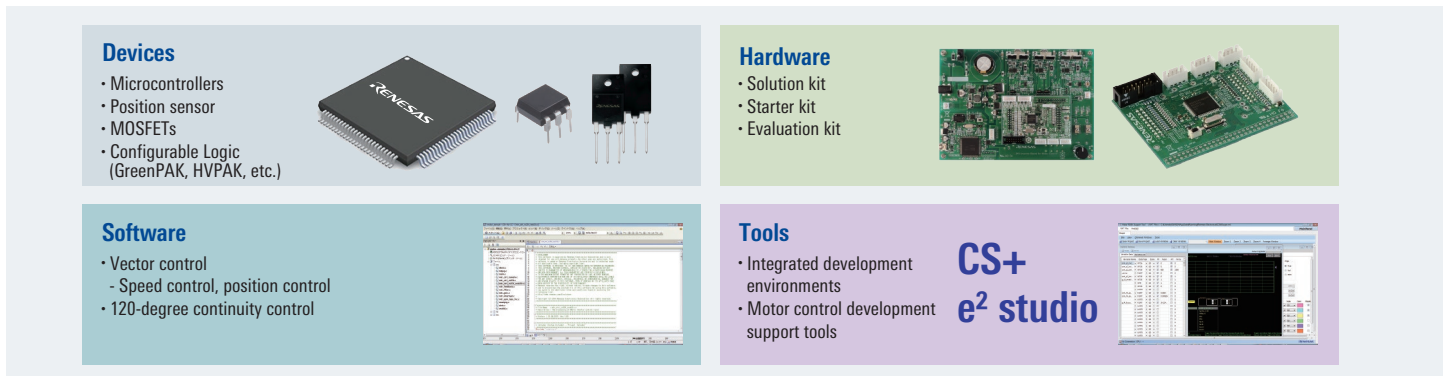

High Availability and Easy Operation

- ▶ Tools and software can be downloaded free of charge from the web, and anyone can feel free to use them.
- ▶ The solution kit can be purchased from an online shop, and you can easily control the motor by using the support tool downloaded from the web.



<https://www.renesas.com/key-technologies/motor-control>

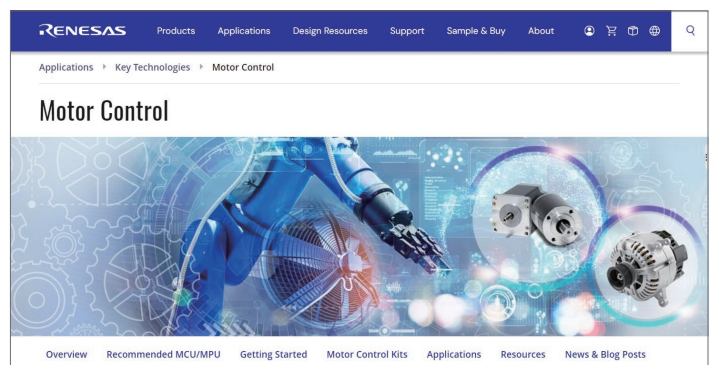

Motor Types and Features

There are various types of motors and the applications used differ according to their features. Renesas offers solutions for permanent magnet synchronous motors (brushless DC motors), stepping motors and induction motors.

Motor Types

The classification of motors is an example, and various other motors exist.

DC Motor

- Brushed motor
- Brushless DC motor (BLDC)

Stepper Motor (Stepping motor)

- Permanent magnet stepper (PM type)
- Variable reactance stepper (VR type)
- Hybrid synchronous stepper (HB type)

AC Motor

- Induction motor (Single phase/Three phases)
- Synchronous motor (SPM, IPM, SynRM)
- Commutator motor

Other Motor

- Ultrasonic motor
- Switched reluctance motor

Motor Features

Brushless DC Motor (BLDC)

A motor that can rotate without using mechanical contacts (brushes) by using an inverter circuit. A permanent magnet is used for the rotor, and the position of the rotor is detected by a position sensor or sensorless position estimation to control the motor drive. Thanks to its features of small size, high output, high rotation speed and long life, it is used in various applications such as home appliances, OA equipment, automobiles and medical equipment.

⇒ Renesas offers a variety of brushless DC motor solutions.

Stepper Motor

A motor that rotates based on the pulse signal input to the drive circuit and is mainly used in industrial robots and printers that require position control. There are PM type that uses a permanent magnet for the rotor, VR type that uses a gear-shaped iron core for the rotor, and HB type that has the characteristics of both PM type and VR type. Generally, open loop control which does not require feedback is used, but an increasing number of more advanced applications use sensor output as feedback.

⇒ Renesas offers solutions for stepping motors employing resolver sensors.

Induction Motor

It is a motor that rotates by magnetic induction. By directly inputting AC power to the motor, it can rotate without a special drive unit. Vector control using a drive unit such as an inverter enables variable speed operation and high-efficiency operation according to the load. Mainly used in industrial machines such as fans, pumps, conveyors and trains.

⇒ Renesas offers induction motor solutions for applications such as fans and pumps.

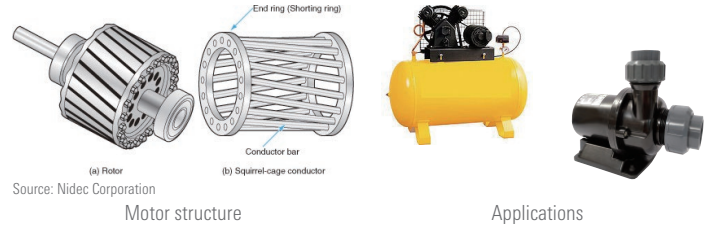
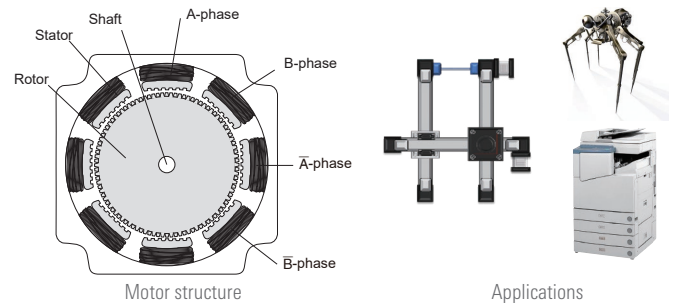
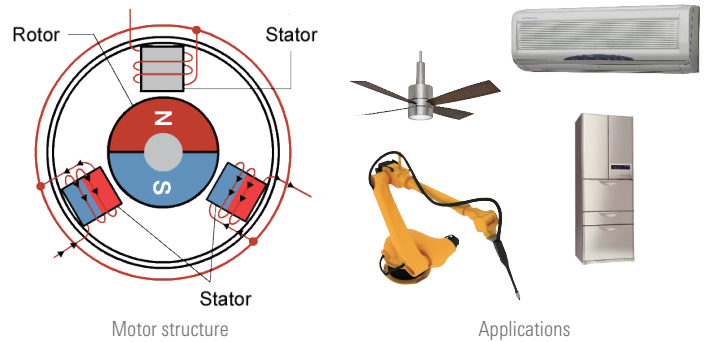

Source: Nidec Corporation

Motor Control Method

Methods for driving motors are introduced below. Renesas provides sample code for 120-degree conducting control (trapezoidal control) and vector control applications. Each sample provides specific features and utilizes a control method suited to a particular application. They can be downloaded from the Renesas website and used as reference when developing your own programs.

120-Degree Conducting Control (Square Wave Control)

Features

- Simple control method with low software load
- It is susceptible to load fluctuation due to the control method that does not detect current
- Precision and efficiency are inferior to vector control

In this control, two of the three coils of the BLDC motor are energized, and six energizing patterns are switched.

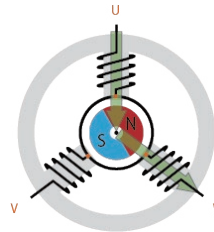

Energizing Mode	Energized Phase	Resultant Flux
1	U → W	
2	U → V	
3	W → V	
4	W → U	
5	V → U	
6	V → W	

Image of energization pattern for 120-degree conducting control

Vector Control

Features

- Advanced control method that detects current and performs fine control
- Highly accurate and efficient control can be realized
- Complex processing is required, and software load is high

In this control, by energizing all three coils and finely controlling the rotating magnetic field, smoother driving is possible compared to 120-degree conducting control. A feature of vector control is that the three-phase AC values are coordinate-converted into two-phase DC values to facilitate control.

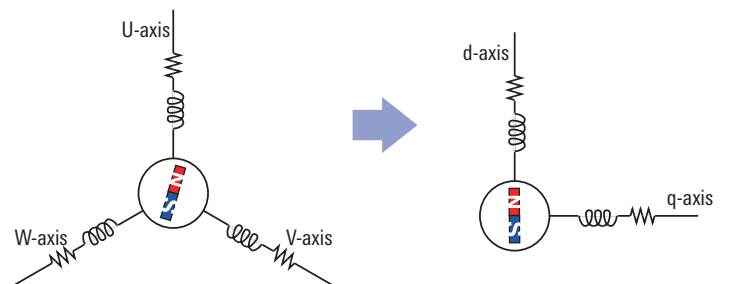

Image of coordinate conversion by vector control (3-phase motor)

Position Sensor of Motor

The required sensor is different between when controlling the “motor speed” like a fan and when controlling the “motor position” like a robot. Each sensor has its own features, and the appropriate sensor is used according to the application. Renesas offers sample code that uses typical types of motor control position sensors, such as Hall sensors, encoders, resolvers, inductive sensors, and magnetic sensors. We also provide sample code for “position sensor-less” control that does not use position sensors.

Hall Sensor

- It is mainly used as an output for switching of energization of 120-degree conducting control with three hall sensors.
- It is also possible to control the motor speed based on the output of hall sensor.
- Because of its low cost, the output may be used for purposes such as functional safety.

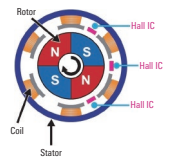

Motor with hall sensor

Encoders and Magnetic Sensors

- There are optical encoders that use light emitting and receiving elements and slits, and magnetic sensors that use a custom IC and a magnet for sensing. Among magnetic sensors, the type of angular information output, such as analog output, digital output, or SPI output, differs depending on the product.
- Wide lineup from inexpensive low resolution to expensive high resolution.
- High resolution encoders are used in robots and AC servos.
- There is also an absolute type that can detect the absolute position.

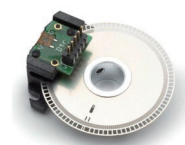

Encoder

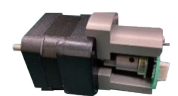

Magnetic sensor

Resolver

- A sensor that detects the position based on the magnetic fluctuation between the rotor and stator.
- It is highly resistant to external factors such as dust, heat, and vibration, and is mainly used in the automotive and industrial fields.
- A resolver digital converter is used to obtain the analog signal at the output of the resolver and use it for control.
- High accuracy is possible by correcting/removing resolver winding error and output signal noise.



Motor with resolver

Inductive Position Sensors

- The position is detected by means of electromagnetic induction by using a position sensor employing a coil.
- Resistant to external factors such as dust, heat and vibration.
- There are products that do not use magnets for detection, and products that are made smaller by supplementing the coil with a board pattern.

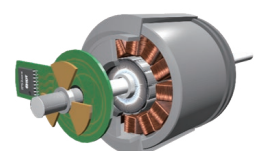

Induction sensor image

Renesas Solutions for Motor Types and Control Methods

Renesas provides kits and motor control sample code for different types of motors and MCUs. Since the sample code available for each kit differs, refer to the appropriate solution in the correspondence table below.

Renesas Kit by Motor Type

Motor Type	Name of Kit Used	Reference Page	Vector Control					120-Degree Conducting Control		Open-Loop Mode
			Sensorless		Encoder	Magnetic Sensor Inductive Sensor	Resolver	Sensorless	Hall	
			Speed Control	Position Control	Speed Control/Position Control	Speed Control/Position Control	Speed Control/Position Control	Speed Control	Speed Control	
BLDC motor	Evaluation System for BLDC Motor + CPU card (P/N: RTK0EMX270S00020BJ) ↗	7	✓	–	–	–	–	✓	✓	–
	Motor Control Evaluation System for RA Family - RA6T1 Group (P/N: RTK0EMA170S00020BJ) ↗	–	✓	–	✓	–	–	✓	✓	–
	MCK-RA6T2 (P/N: RTK0EMA270S00020BJ) ↗	8	✓	–	–	–	–	✓	✓	–
	MCK-RA6T3 (P/N: RTK0EMA330S00020BJ) ↗	8	✓	–	–	–	–	✓	✓	–
	MCK-RA4T1 (P/N: RTK0EMA430S00020BJ) ↗	8	✓	–	–	–	–	✓	✓	–
	MCK-RA8T1 (P/N: RTK0EMA5K0S00020BJ) ↗	8	✓	–	–	–	–	✓	✓	–
	MCK-RX26T (P/N: RTK0EMXE70S00020BJ) ↗	8	✓	✓	–	–	–	✓	✓	–
	RL78/G24 Motor Control Evaluation Kit (P/N: RTK0EMG24SS00000BJ) ↗	10	✓	–	–	–	–	✓	✓	–
	RZ/T2M Motor Solution Kit ↗	11	–	–	✓	–	–	–	–	–
	MCI-HV-1 (P/N: RTK0EM0000B14030BJ) ↗	9	–	✓	✓	–	–	–	–	–
	RZ/T Series Inverter board (P/N: RTK0EM0000B15010BJ) ↗	12	–	–	✓	–	–	–	–	–
AC synchronous motor	RZ/T2M, RZ/T2L, and RZ/N2L Motor Solution Kits (AC 220V Version) ↗	13	–	–	✓	–	–	–	–	–
Stepping motor	Evaluation System for Stepping Motor with Resolver (P/N: RTK0EMX270S01020BJ) ↗	15	–	–	–	–	✓	–	–	–
	HVPAK™ SLG47105 DC/Stepper Motor and LED Control Demonstration Board ↗	29	–	–	–	–	–	–	–	✓
	HVPAK SLG47105 Evaluation Board ↗	29	–	–	–	–	–	–	–	✓

Renesas Kit + Motor with Sensor

It is necessary for the customer to prepare a motor with sensor.

Motor Type	Name of Kit Used	Reference Page	Vector Control				120-Degree Conducting Control	
			Sensorless	Encoder	Magnetic Sensor Inductive Sensor	Resolver	Sensorless	Hall
			Speed Control	Speed Control/Position Control	Speed Control/Position Control	Speed Control/Position Control	Speed Control	Speed Control
BLDC	Evaluation System for BLDC Motor + CPU card (P/N: RTK0EMX270S00020BJ) ↗	7	–	✓	✓	–	–	–
	MCK-RA6T2 (P/N: RTK0EMA270S00020BJ) ↗	8	–	✓	✓	–	–	–
	MCK-RA6T3 (P/N: RTK0EMA330S00020BJ) ↗	8	–	✓	✓	–	–	–
	MCK-RA4T1 (P/N: RTK0EMA430S00020BJ) ↗	8	–	✓	✓	–	–	–
	MCK-RA8T1 (P/N: RTK0EMA5K0S00020BJ) ↗	8	–	✓	✓	–	–	–
	MCK-RX26T (P/N: RTK0EMXE70S00020BJ) ↗	8	–	✓	–	–	–	–

Sample Software/Application Note Provided by Renesas

It is necessary for the customer to prepare a motor and an inverter board.

Motor Type	Name of Kit Used	Reference Page	Vector Control				120-Degree Conducting Control	
			Sensorless	Encoder	Magnetic Sensor Inductive Sensor	Resolver	Sensorless	Hall
			Speed Control	Speed Control/Position Control	Speed Control/Position Control	Speed Control/Position Control	Speed Control	Speed Control
Induction motor	Evaluation System for ACIM	16	✓	–	–	–	–	–

Solutions for Permanent Magnet Synchronous Motor (BLDC Motor)

Renesas offers permanent magnet synchronous motor solutions to support customers' evaluation and development. Supported devices differ, so please select a solution that uses the product you are considering.

Evaluation System for BLDC Motor [↗](#)

Compatible CPU cards, sample code, and a development support tool are provided so you can get started with motor control immediately after purchase.

Features

- Motor control kit that supports up to DC48V input.
- Supports Renesas Motor Workbench for easy debugging.
- Equipped with overcurrent protection function.
- Various motor control MCUs can be evaluated in combination with an optional CPU card.



Evaluation System for BLDC Motor + CPU card

Kit specifications

Item	Specification
Kit name	Evaluation System for BLDC Motor ↗
Kit model No.	RTK0EMX270S00020BJ
Structure	48V 5A Inverter board for BLDC motor BLDC motor (TG-55L-KA)
Inverter specification	<ul style="list-style-type: none"> Rated voltage: 48V Rated current: 5A (continuous) Protect function: Overcurrent detection, others

Available Sample Code for Evaluation

Item	Supported MCUs								
	RL78 Family	RX Family							RA Family
	RL78/G1F	RX13T	RX23T	RX24T	RX24U	RX66T	RX72T	RX72M	RA6T1
120-degree conducting control + speed control (Hall sensor, sensorless)	✓	✓	✓	✓	–	–	–	–	✓
Vector control + speed control	Sensorless	✓	✓	✓	✓	✓	✓	✓	✓
	Encoder (A/B)	–	✓	✓	✓	✓	✓	✓	✓
	Magnetic sensor	–	✓	✓	✓	✓	✓	✓	–
	Inductive sensor	–	✓	✓	✓	✓	✓	✓	–
	Resolver	–	–	✓	✓	–	✓	✓	✓
Vector control + position control	Encoder (A/B)	–	✓	✓	✓	✓	✓	✓	✓
	Magnetic sensor	–	✓	✓	✓	✓	✓	✓	–
	Inductive sensor	–	✓	✓	✓	✓	✓	✓	–
	Resolver	–	–	✓	✓	–	✓	✓	–
Multiple motor control	–	–	–	–	–	✓ (2 motors: sensorless)	✓ (3 motors: encoder) (4 motors: sensorless)	–	✓ (2 motors: sensorless)

Overall Structure

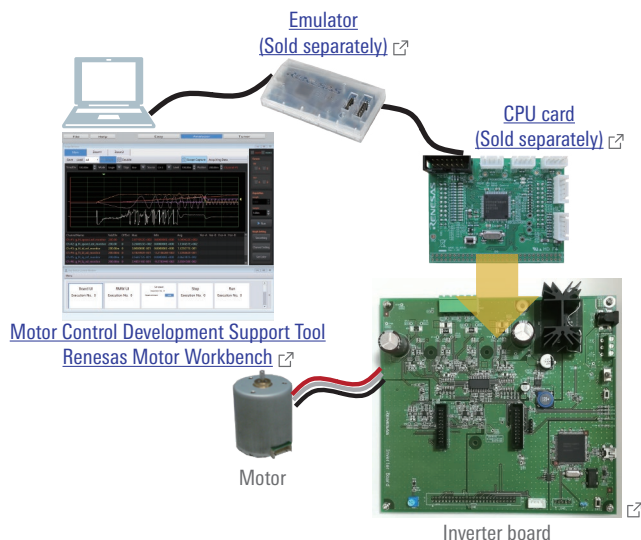

Optional CPU Card for Evaluation System for BLDC Motor [↗](#)

	CPU Card for Motor Control	Part No.
RL78 Family	RL78/G1F	RTK0EML240C03000BJ
RX Family	RX13T	RTK0EMXA10C00000BJ
	RX23T	RTK0EM0003C01202BJ
	RX24T	RTK0EM0009C03402BJ
	RX24U	RTK0EMX590C02000BJ
	RX66T	RTK0EMX870C00000BJ
	RX72T	RTK0EMX990C00000BJ
	RX72M	RTK0EMXDE0C00000BJ
RA Family	RA6T1	RTK0EMA170C00000BJ

* A kit that includes the RA6T1 CPU card in this inverter board is also available. "Motor Control Evaluation System for RA Family - RA6T1 Group"

Solutions for Permanent Magnet Synchronous Motor (BLDC Motor)

MCK-XXXXX Note: XXXXX designates the group name of the MCU mounted on the CPU board.

This motor solution includes a CPU board(*), inverter board, and communication board. Sample code and a development support tool are provided so you can get started with motor control immediately after purchase.

Features

- Equipped with onboard debugger for MCU flash programming.
- Supports 1-shunt and 3-shunt current detection.
- Overcurrent detection function.
- Supports the motor control development support tool "Renesas Motor Workbench" for easy debugging.
- Use of a communication board(*) provides electrical isolation from the PC for safe evaluation and debugging of motor control applications.



Kit specifications

Kit name	MCK-RA6T2	MCK-RA8T1	MCK-RA6T3	MCK-RA4T1	MCK-RX26T
Kit model No.	RTK0EMA270S00020BJ	RTK0EMA5K0S00020BJ	RTK0EMA330S00020BJ	RTK0EMA430S00020BJ	RTK0EMXE70S00020BJ
Structure	48V 10A inverter board for BLDC motor (MCI-LV-1)	←	←	←	←
	RA6T2 CPU board (MCB-RA6T2)	RA8T1 CPU board (MCB-RA8T1)	RA6T3 CPU board (MCB-RA6T3)	RA4T1 CPU board (MCB-RA4T1)	RX26T CPU board (MCB-RX26T Type A)
	Communication board (MC-COM)	←	–	–	Communication board (MC-COM)
	BLDC motor (R42BLD30L3 manufactured by Moons' Industries)	←	←	←	←
Inverter specification	<ul style="list-style-type: none"> Rated voltage: 48V Rated current: 10A (continuous) Protect functions: Overcurrent detection, etc. 	←	←	←	←

Note: Some products do not include a communication board.

In order to safely implement motor control evaluation, either obtain a communication board separately or use a commercially available USB isolator.

Overall Structure

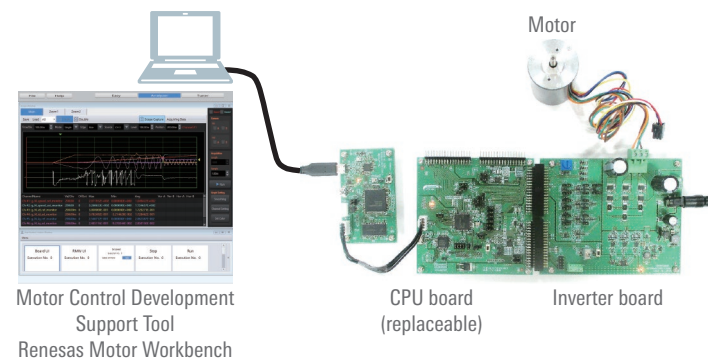

Available Sample Code for Evaluation

Item	Supported MCUs				
	RA Family				RX Family
	RA6T2	RA8T1	RA6T3	RA4T1	RX26T
120-degree conducting control + speed control (Hall sensor, sensorless)	✓	✓	✓	✓	–
Vector control + speed control	Sensorless	✓	✓	✓	✓
	Encoder (A/B)	✓	✓	✓	✓
	Inductive sensor	✓	✓	✓	–
	Hall	✓	✓	–	–
Vector control + position control	Sensorless	–	–	–	✓
	Encoder (A/B)	✓	✓	✓	✓
	Inductive sensor	✓	✓	✓	–
Multiple motor control	✓ (2 motors: sensorless)	✓ (2 motors: sensorless)	–	–	–

Solutions for Permanent Magnet Synchronous Motor (BLDC Motor)

MCB-XXXXX

Note: XXXXX designates the group name of the MCU mounted on the CPU board.

This CPU board can be used in combination with an inverter board (sold separately) to evaluate BLDC motor control applications employing a Renesas MCU.

Features

- Equipped with onboard debugger for MCU flash programming.
- Supports signal input from Hall sensors, encoders, and inductive position sensors.



Kit specifications

Kit name	MCB-RA6T2	MCB-RA8T1	MCB-RA6T3	MCB-RA4T1	MCB-RX26T Type A ^{*2}	MCB-RX26T Type B ^{*2}	MCB-RX26T Type C ^{*2}
Kit model No.	RTK0EMA270C00000BJ	RTK0EMA5K0C00000BJ	RTK0EMA330C00000BJ	RTK0EMA430C00000BJ	RTK0EMXE70C00000BJ	RTK0EMXE70C01000BJ	RTK0EMXE30C00000BJ
MCU	R7FA6T2BD3CFP	R7FA8T1AHECBD	R7FA6T3BB3CFM	R7FA4T1BB3CFM	R5F526TFCDFP	R5F526TFDDFP	R5F526TACDFM
2-motor control support ^{*1}	✓	✓	–	–	✓	✓	✓
Compatible inverter board	MCI-LV-1 (RTK0EM0000S04020BJ) MCI-HV-1 (RTK0EM0000B14030BJ)	MCI-LV-1 (RTK0EM0000S04020BJ)	←	←	←	←	←

^{*1}: A compatible program is required.

^{*2}: Please refer to the MCB-RX26T Type A/B/C comparison table on the right.

MCB-RX26T Type A/B/C difference

MCB-RX26T	Type A	Type B	Type C
Trusted Secure IP (TSIP-Lite)	–	✓	–
ROM/RAM	64KB/512KB	64KB/512KB	48KB/256KB

MCI-LV-1



When combined with separately available CPU boards, this BLDC motor drive inverter board kit can be used to evaluate a variety of motor control MCUs.

Features

- Supports 1-shunt and 3-shunt current detection.
- Overcurrent detection function.
- Includes BLDC motor.



Kit specifications

Item	Specification
Kit name	MCI-LV-1
Kit model No.	RTK0EM0000S04020BJ
Structure	48V 10A BLDC motor inverter board BLDC motor (R42BLD30L3 manufactured by Moons' Industries)
Inverter specification	<ul style="list-style-type: none"> Rated voltage: 48V Rated current: 10A (continuous) Safety functions: Overcurrent detection, etc.

MC-COM



The communication board for serial communication with a Renesas MCU. It provides an electrically isolated environment to enable safe evaluation and debugging of motor control applications.

Features

- Supports the motor control development support tool "Renesas Motor Workbench".
- CPU board by manufacturers other than Renesas can be used by embedding code from libraries supported by Renesas Motor Workbench in the user's motor control software.



Kit specifications

Item	Specification
Kit name	MC-COM
Kit model No.	RTK0EMXC90S00000BJ
Isolation device used	Si8622BC-B-IS (Skyworks Solutions Inc.) or ISO7421FED (Texas Instruments)
Compatible CPU boards	RX13T/23T/24T/24U/66T/72T/72M CPU Card RA6T1 CPU Card MCB-RA6T2/RA6T3/RA4T1/RA8T1 MCB-RX26T Type A/Type B/Type C

MCI-HV-1



This inverter board allows for easy evaluation of motor control using high-voltage (100/200V) BLDC/Induction motors by combining with a compatible CPU board.

Features

- Support input supply voltage range (AC100-240V 50/60Hz or DC141-390V)
- Equipped with PFC control circuit
- Supports 1-shunt and 3-shunt current detection
- Overcurrent detection, overvoltage protection and overtemperature detection



Specifications

Item	Specification
Name	MCI-HV-1
Part No.	RTK0EM0000B14030BJ
Structure	100-240V 50/60Hz 10A BLDC motor inverter board Connectors and cables
Compatible CPU board	MCB-RA6T2
Inverter specification	<ul style="list-style-type: none"> Rated Input: AC100-200V, 50/60Hz 10A DC141-390V, 10A Rated Output: 500W (AC100V) 1kW (AC200-240V) 2kW (DC390V) Detection Function: Phase voltage, Phase current, Bus voltage, Input voltage, PFC current, temperature PFC: Max output 1kW, Single/Interleave control Current detection: 1-/3-Shunt Protection function: Overcurrent detection, Short circuit prevention, Overheat detection, Over voltage prevention, Inrush current prevention Support sensor: Hall sensor, Encoder Isolation: Sensor I/F, Comm I/F (Both are Reinforced insulation)
Sample code	<ul style="list-style-type: none"> RA6T2 Sensorless Vector Control of PM Motor by High-Voltage Inverter RA6T2 Sensorless Vector Control for IPMSM over the Whole Speed Range

Solutions for Permanent Magnet Synchronous Motor (BLDC Motor)

RL78/G24 Motor Control Evaluation Kit [↗](#)

The RL78/G24 Motor Control Evaluation Kit is a permanent magnet synchronous motor (brushless DC motor) control evaluation kit that is equipped with an RL78/G24 microcontroller, which allows easy evaluation of motor control.

Features

- Equipped with 16-bit RL78/G24 microcontroller
- Controlled by Hall sensor and Encoder with BLDC motor, or Sensorless control by phase voltage or sensing current
- Supports 1-shunt 2-shunt and 3-shunt current detection
- Zero-crossing detection with built-in compiler
- Supports the motor control development support tool "Renesas Motor Workbench" for easy debugging
- By replacing it with a compatible CPU card, you can evaluate motor control with other MCUs



Kit specifications

Item	Specification	
Kit name	RL78/G24 Motor Control Evaluation Kit ↗	
Kit model No.	RTK0EMG24SS00000BJ	
Structure	<ul style="list-style-type: none"> • Inverter Board (RTK0EMGPLVB00000BJ) • RL78/G24 CPU Card (RTK0EMG240C00000BJ) • Communication Board (RTK0EMXC90Z00000BJ) • Permanent Magnet Synchronous Motor (TG-55L-KA) • Various cables, screws, spacers 	
Inverter specifications	Rated voltage	48V
	Rated current	10A (continuous)
	Protect functions	Overcurrent detection, etc.
Target Devices	<ul style="list-style-type: none"> • MCU: R7F101GLG2DFB • Gate Driver: HIP2101BZ • MOSFET: RJK0703DPP-A0 • Regulator: ISL8560IRZ, ISL85003FRZ • Operational amplifiers: READ2302GSP 	

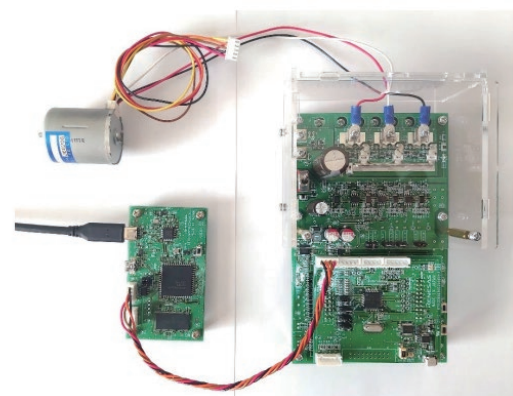

Compatible CPU Board

RL78 Family	Part No.
RL78/G24	RTK0EMG240C00000BJ
RL78/G1F	RTK0EML240C03000BJ

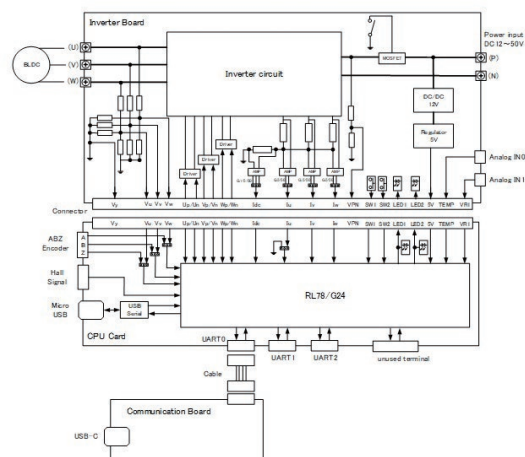

Solutions for Permanent Magnet Synchronous Motor (BLDC Motor)

RZ/T2M Motor Solution Kit

- ✓ Motor position and speed control software is available to enable initial evaluation when developing equipment incorporating industrial motors.
- ✓ Circuit diagrams are available in addition to software that runs on-board and PC software to help reduce the time required for development.

Features

- Ability to combine RZ/T2M $\Delta\Sigma$ interface and Renesas $\Delta\Sigma$ modulator for high-precision current sensing.
- A current sensing reference circuit for the motor's U-, V-, and W-phase lines and a sample program are available.
- Supports incremental and absolute encoders. (Supported encoder interfaces: BiSS® C, HIPERFACE DSL®, EnDat® 2.2, FA-CODER® and A-format®).
- A servo control sample program that operates via an industrial Ethernet link (EtherCAT, CiA402) is available.
- The board is populated with the RX72N and a monitoring IC, and a reference circuit and sample program* are provided for a functional safety system implementing redundant monitoring functionality using the RZ/T2M and RX72N.

Kit specifications

Item	Specification	
Kit name	RZ/T2M Motor Solution Kit 	
Structure	RZ/T2M motor solution board	
	<ul style="list-style-type: none"> • RZ/T2M controller board • Low-voltage single-shaft drive inverter board 	
Board specifications	Brushless DC motor (FH6S20E-X81) (with incremental encoder)	
	Rated voltage	24V DC
	Rated current	2A (effective value)
	Current detection	Current transducer, $\Sigma\Delta$ modulator (RV1S9353A)
	Safety functions	Overcurrent detection, bus voltage detection, overvoltage detection, undervoltage detection, external switch detection
	Position detection	Incremental/absolute encoder
Communication functions	2 Ethernet ports, CAN, UART, USB	

General Configuration

Hardware	Controller board
	Inverter board
	BLDC motor (with incremental encoder)
Software	Permanent magnet synchronous motor vector control software with current sensor and encoder functions (and EtherCAT and functional safety platform software)
	PC software (Motion Control Utility)
Documentation	Startup Manual
	Firmware manual
	Motor Solution Board Hardware Manual
	Circuit diagrams, Gerber data, BOM list

Supported Devices

Category	Part No.	Key Features
MPU/MCU	RZ/T2M	Arm®-based High-end 32-bit MPU, Real-time control + Industrial Ethernet, FuSa
	RX72N	32-bit MCU with Enhanced DSP, FPU and TFU
Analog	RV1S9207A	0.6A Output Current, High CMR, IGBT Gate Drive, Photocoupler
	RV1S9353A	Optically Isolated $\Delta\Sigma$ Modulator
	ISL3178	High ESD Protected RS-485/RS-422 Transceivers
Power	ISL80030	2.7V to 5Vin, 3A Sync Buck
	ISL8117	Synchronous Step-Down PWM Controller

Link for RZ/T2M Motor Solution Kit: <https://www.renesas.com/rzt2m-motor-solution-kit>

* For functional safety system evaluation, it is necessary to download the SIL3 System Software Kit and FSoE Solution Kit via the inquiry form on the Renesas website at the link below.

URL: [Industrial Functional Safety — Technical Information Request Form | Renesas Electronics \(renesas.com\)](#)

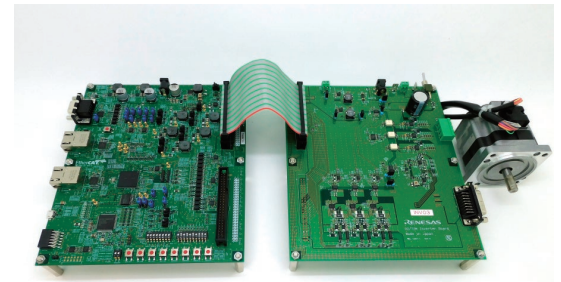

Available for loan free of charge. Please contact a Renesas Electronics distributor or sales office for details.

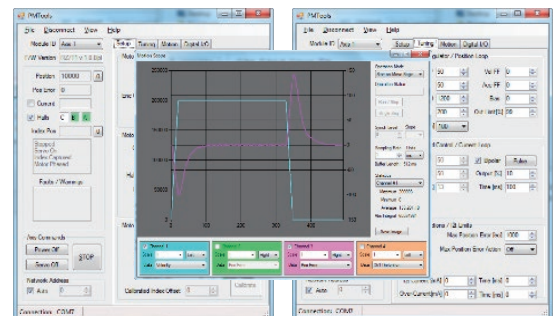

Motion Control Utility

Solutions for 9-axis Motor Control (BLDC Motor)

RZ/T2H 9-axis Motor Control Demonstration

If you want to control up to 9motors simultaneously, this is the best solution.

Features

- Up to 9 axis motor control by RZ/T2H
- Enable to control each axis as speed/position control
- Support FA-CODER as encoder I/F
- Inverter board supports absolute/incremental type encoder
- Enable to operate each axis individually using Motion Control Utility that is motor control development support tool by Renesas
- Offering 9 axis motor control sample code and app note from Renesas website



Demo set up

Kit specifications

Item	Specification	
Kit name	RZ/T2H 9-axis Motor Control Demonstration	
Structure	<ul style="list-style-type: none"> RZ/T2H Evaluation Board Bus Board for RZ/T2H RZ/T Series Inverter Board BLDC Motor with Encoder (FA-CODER®) 	
Inverter specifications	Rated voltage	24V DC
	Rated current	4A (effective value)
	Current detection	3-shunt delta-sigma modulator
	Safety functions	Overcurrent detection
	Position detection	Incremental Encoder x1, Absolute encoder x2
Software	Sample Code: RZ/T2H 9-axis Motor Control Program	
	Support RZ Smart Configuration	
	PC software (Motion Control Utility)	

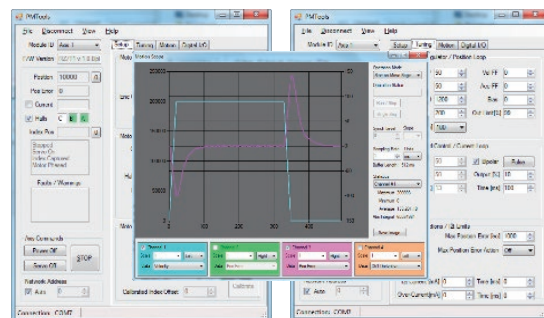

Motion Control Utility



Link for resources

Evaluation Board Kit for RZ/T2H: renesas.com/rzt2h-evkit

Bus Board for RZ/T2H: renesas.com/busb-rzt2h-b

RZ/T Series Inverter Board: renesas.com/invb-lv-rzt-i

From left: Evaluation Board Kit for RZ/T2H, Bus Board for RZ/T2H and RZ/T Series, Inverter Board

Supported Devices

Category	Part No.	Key Features
MPU/MCU	RZ/T2H	1200MHz Arm® Quad Cortex®-A55 and Arm® Dual Cortex®-R52, Real-time control + Industrial Ethernet
Analog	RV1S9061A	15Mbps IPM Drive Photocouplers
	RV1S9355A	Optically Isolated $\Delta\Sigma$ Modulator
	ISL3172EIBZ	RS-485/RS-422 Transceivers
	ISL32179EFRZ	RS-422 Transmitters
	ISL32177EFRZ	RS-485/RS-422 Receivers
	RV1S9213ACCSP-10YV#	OPTO COUPLER IN 5PIN SSOP
	PS2733-1-A	OPTOISOLATOR 2.5KV DARL 4SMD
	PS2561DL-1	OPTOISOLATOR 5KV TRANS 4SMD
	PS8101-AX	OPTOISO 3.75KV PUSH PULL 6SO
PS2761B-1	OPTOISOLATOR 3.75KV TRANS 4SOP	
Power	DA9061-16AM1	PMIC for Applications Requiring up to 6 A
	RAA211450GSP#HA0	4.5V to 42V, 5A, DC/DC Synchronous Step-Down Regulator
Memory	AT25SF128A-SHB-T	IC FLASH 128MBIT SPI/QUAD 8SOIC
	R1EX24016ASAS	IC EEPROM 16KBIT I2C 400KHZ 8SOP

Solutions for AC Synchronous Motors

RZ/T2M, RZ/T2L, and RZ/N2L Motor Solution Kits (AC 220V Version)

These solution kits simplify the initial and ongoing development of servo systems and motion controllers employing the RZ/T2M, RZ/T2L, and RZ/N2L. Each comprises a control board populated with the RZ/T2M, RZ/T2L, or RZ/N2L, an inverter board capable of driving a 220V AC synchronous motor, a motor for use in evaluation, a utility tool for adjusting motor parameters and motion control operation, control software, and more. The utility tool runs on a PC and allows operation of the motor with position and speed control by means of control commands sent via UART or RS-485. Alternatively, the motor can be operated via EtherCAT using CiA 402 profiles.

Features

- Compatible with power supplies from 100 to 250V AC.
- Compatible with absolute encoders from Tamagawa Seiki.
- A Renesas delta-sigma ($\Delta\Sigma$) modulator can be connected to the delta-sigma ($\Delta\Sigma$) interface for highly precise current sensing.
- Either UART or RS-485 can be used for data transfer with the utility tool.
- A sample program is provided for servo control via industrial Ethernet (EtherCAT or CiA 402).*1
- Motor control using CiA 402 profiles (pp, csp, and csv*2) is supported.

*1: An EtherCAT master such as TwinCAT® 3 must be provided by the customer.

*2: pp: position profile, csp: cyclic synchronous position, csv: cyclic synchronous velocity

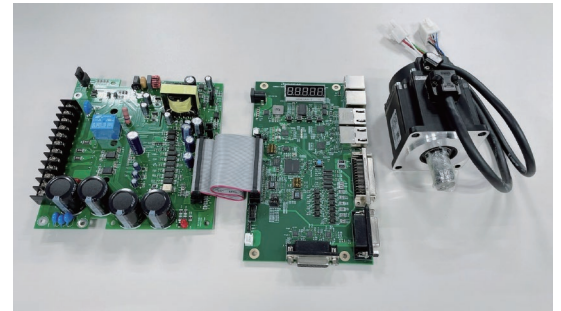

Available for loan free of charge. Please contact a Renesas Electronics distributor or sales office for details.

Kit specifications

Item	Specification	
Kit name	AC Servo Solution Kit 	
Structure	<ul style="list-style-type: none"> Controller board (populated with RZ/T2M, RZ/N2L, or RZ/T2L) Single-axis drive inverter board AC synchronous motor (BM0602B1PD-A02) (with Tamagawa Seiki absolute encoder)	
Board specifications	Rated voltage	100 to 250V AC
	Rated current	1.5A (effective value)
	Current detection	$\Sigma\Delta$ Modulator (RV1S9353A)
	Safety functions	Overcurrent detection, bus voltage detection
Board specifications	Position detection	Absolute encoder
	Communication functions	EtherCAT ports x2, CAN, UART, USB, RS485
Software	AC synchronous motor vector control software with encoder function (and EtherCAT communication functionality)	
	PC software (Motion Control Utility)	
Documentation	Startup Manual (Motion Control Utility and EtherCAT)	
	Firmware manual	
	Hardware manual	
	Circuit diagrams, Gerber data, BOM list	

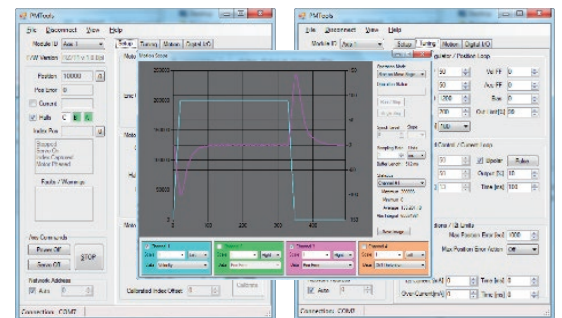

Motion Control Utility

Supported Devices

Category	Part No.	Key Features
MPU/MCU	RZ/T2M	800MHz dual core Arm®-based High-end 32-bit MPU, Real-time control + Industrial Ethernet
	RZ/T2L	800MHz single core Arm®-based High-end 32-bit MPU, Real-time control + Industrial Ethernet
	RZ/N2L	400MHz single core Arm®-based High-end 32-bit MPU, Real-time control + Industrial Ethernet
Analog	RV1S9061A	15Mbps IPM Drive Photocouplers
	RV1S9353A	Optically Isolated $\Delta\Sigma$ Modulator
	ISL3172EIBZ	RS-485/RS-422 Transceivers
	ISL32179EFRZ	RS-422 Transmitters
	ISL32177EFRZ	RS-485/RS-422 Receivers
	RV1S9213ACCS-10YV#	OPTO COUPLER IN 5PIN SSOP
	PS2733-1-A	OPTOISOLATOR 2.5KV DARL 4SMD
	PS2561DL-1	OPTOISOLATOR 5KV TRANS 4SMD
Power	DA9061-16AM1	PMIC for Applications Requiring up to 6 A
	RAA211450GSP#HA0	4.5V to 42V, 5A, DC/DC Synchronous Step-Down Regulator
Memory	AT25SF128A-SHB-T	IC FLASH 128MBIT SPI/QUAD 8SOIC
	R1EX24016ASAS	IC EEPROM 16KBIT I2C 400KHZ 8SOP

Link for RZ/T2M, RZ/T2L, and RZ/N2L Motor Solution Kits (AC 220V Version): <https://www.renesas.com/ac-servo-solution-kit>

Solutions for Stepping Motor

Resolver motor control solutions featuring superlative cost performance

Resolver Motor Control Solutions

These resolver-based motor control solutions are motor control systems for industrial and consumer applications realized by combining resolver-to-digital converter (RDC) ICs and RX Family microcontrollers (MCUs). It is possible to easily control a resolver-based stepping motor or brushless DC motor using the driver software of the microcontroller. Solution kits, sample code, development support tools, and application notes for motors with resolvers are provided, so motor control using resolvers can be started immediately.

- Features
- High-precision motor control is possible even in the harsh environments with heat, dust, or vibration.
 - Realize high-precision control at low cost using a new type of resolver control with higher cost performance.
 - Resolver signal gain, phase, and angle error are automatically corrected through the driver API that can be used in combination with an RX MCU to achieve high precision.

System configuration

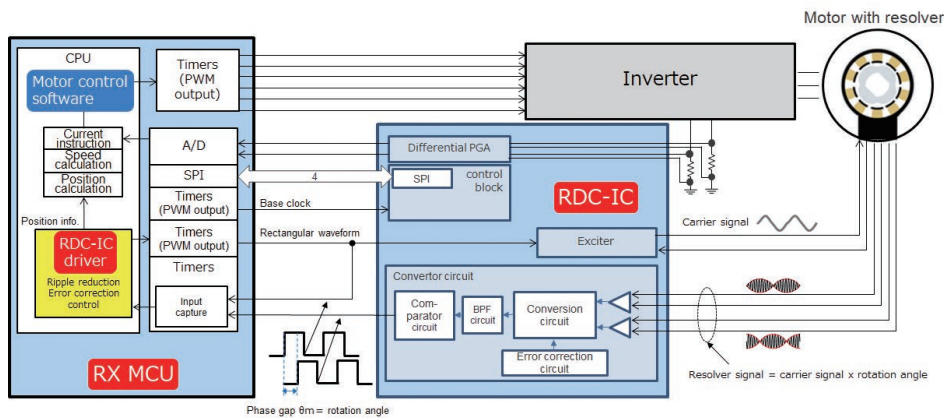

- In resolver-based motor control solutions, the RDC IC and RX MCU process signals from the resolver as angle information, and the RX MCU controls the motor. A dedicated driver for the RDC IC is provided on the RX MCU, and resolver processing can be easily performed using the API.
- Using a portion of the MCU functions makes it possible to simplify the RDC IC and thereby lower its cost.

Motor Control Solutions for Stepping Motors with Resolvers

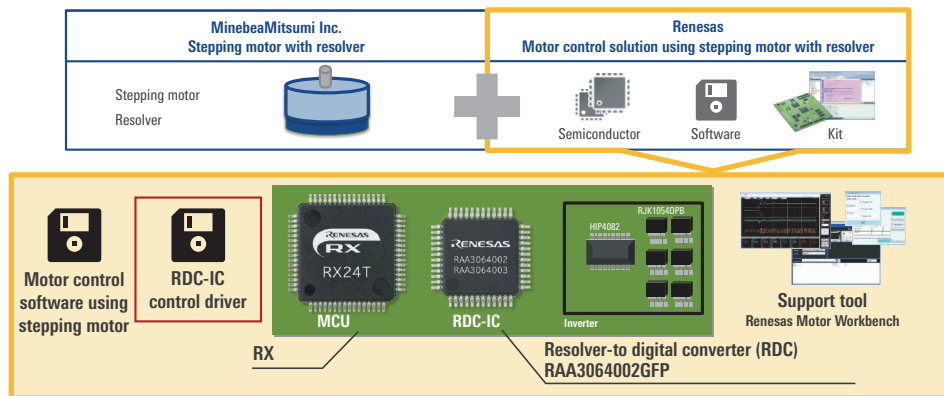

- Stepping motors with resolvers and resolver motor control solutions developed by collaboration between MinebeaMitsumi Inc. and Renesas make it possible to servo control the stepping motor which is normally controlled by the open loop.
- This solution realizes many advantages such as low noise, low vibration, low power consumption and maximization of motor torque.
- ICs, software, development kits, and development support tools for resolver control and motor control are available.

Solution Contents

Stepping motor with resolver: New motor manufactured by MinebeaMitsumi Inc.
 RX24T/RX66T/RX72T/RX72M: MCU for motor control
 Resolver-to-digital converter: IC that converts resolver output into digital signal
 Solution kit: All items necessary for controlling a stepping motor with resolver are provided
 Support tool: Development support tool essential for motor control debugging

For simple, highly integrated open-loop stepper motors- info can be found at pages 28-29.

Solutions for Stepping Motor

Evaluation System for Stepping Motor with Resolver [↗](#)



Evaluation System for Stepping Motor with Resolver

Kit specifications

Item	Specification
Kit name	Evaluation System for Stepping Motor with Resolver ↗
Kit model No.	RTK0EMX270S01020BJ
Structure	48V 2A Inverter board for stepping motor
	RX24T with RDC IC CPU card
	Stepping motor with Resolver (Minebea Mitsumi)
Inverter specification	<ul style="list-style-type: none"> ■ Rated voltage: 48V ■ Rated current: 2A (RMS) ■ Detect function: Phase current, Bus voltage ■ Protect function: Overcurrent protection

Sample Code	Supported MCUs
Vector control + Speed control (Resolver)	RX24T, RX66T, RX72T, RX72M
Vector control + Position control (Resolver)	RX24T, RX66T, RX72T, RX72M

- Supports RS485, CAN, pulse train command, general-purpose input/output for external device communication as the I/F specification of the kit.
- Equipped with on-board emulator circuit (flash programming circuit).

Supported Devices

MCUs

Part No.	Operating Frequency	Key Features
RX24T	80MHz	32-bit MCU, FPU*1, 5V operation, PGA*2, 2 motor control
RX66T	160MHz	32-bit MCU, FPU*1, 5V operation, PGA*2,3, 4 motor control, Security module
RX72T	200MHz	32bit MCU, FPU*1, 5V operation, PGA*2,3, Built-in TFU*4, 4 motor control, Security module
RX72M	240MHz	32-bit MCU, Double precision FPU*1, Built-in TFU*4, Security module, EtherCAT® compatible

*1: Floating Point Unit

*2: Programmable Gain Amplifier

*3: Pseudo-Differential PGA

*4: Arithmetic Unit for Trigonometric Functions

Analog, Power devices

Category	Part No.	Key Features
RDC-IC	RAA3064002GFP (85°C)	Single-phase induced/Two phase output Excitation frequency: 5/10/20kHz, 2.5Vp-p
	RAA3064003GFP (105°C)	
Motor Driver	HIP4082IBZT	80V, 1.25A Peak Driver
MOSFET	RJK0854DPB	Nch Power MOSFET, 80V/25A, $R_{DS(on)} = 13 \text{ m}\Omega$ max, surface-mount device (LFPAK)
	RJK1054DPB	Nch Power MOSFET, 100V/20A, $R_{DS(on)} = 22 \text{ m}\Omega$ max, surface-mount device (LFPAK)
RS-485/RS-422	ISL3156E	RS-485/RS-422 transceiver, 4.5 to 5.5V operation, fail-safe

Recommended Devices

HVPAK

Category	Part No.	Key Features
Motor Driver	SLG47105, SLG47115	Configurable H-/Half Bridge with up to 3 A/ 26.4 V with additional programmable mixed signal functionality and I ² C

Solutions for AC Induction Motor

Three-phase induction motor solution provides inverter control software to be embedded in a motor control MCU. By providing an inverter control software with a high level of development difficulty, you can easily and reasonably develop a customer-specific inverter.

* This solution uses an inverter board made by a partner and does not provide a kit from Renesas.



Evaluation System for ACIM

Renesas can provide CPU cards, sample code, application notes, development support tools, and can control induction motors in combination with partner-made inverter boards.

Features

- Equipped with speed sensorless vector control function can remove speed sensor to reduce BOM cost and improve reliability.
- Compatible with Renesas Motor Workbench (motor control development support tool), for easy debugging.
- Built-in over current/over voltage/over temperature protection function, enables safe evaluation.
- Various motor control MCUs can be evaluated in combination with an optional CPU card.
- High voltage inverter board is compatible with AC85 to 265Vrms input (Need to be purchased separately from Desk Top Lab Co.,Ltd).

Evaluation Environment Specifications

Item	Specification
Structure	T1102 (Inverter board made by Desk Top Laboratories Inc. )
	RX13T CPU card , RX66T CPU card 
Inverter specification	Rated voltage: AC 85 to 265V
	Rated current: 15A (RMS)
	Protect function: Overcurrent protection, others
Sample Software	
Vector control + Speed control (Sensorless)	Supported MCUs RX13T, RX66T

Overall Structure

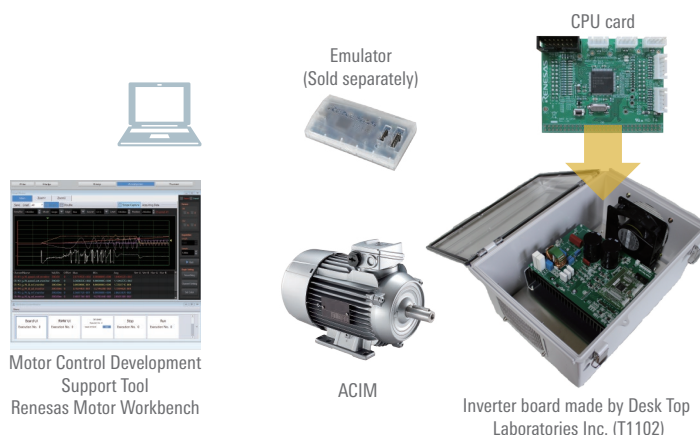

Solutions Using Magnetic Sensors

Motor Control with Magnetic Sensor

A motor control solution for applications using a BLDC motor with a magnetic sensor.

Renesas have released sample software and application notes that can correct the sensor output, which can be used as a reference for motor control using magnetic sensors.

Renesas does not supply the BLDC motor with magnetic sensor used in this solution.

Features



- Sample code and application notes supporting magnetic sensors with analog output, digital output, and SPI output are provided.
- The sample code implements an error correction function for analog output signals.
- Compatible with Renesas Motor Workbench, a motor control development support tool, for easy debugging.
- Equipped with protection functions such as overcurrent and overvoltage detection for safe evaluation.

* The TAD2141 and TAS2143 magnetic sensors manufactured by TDK Corporation were used to confirm the operation of the sample code.

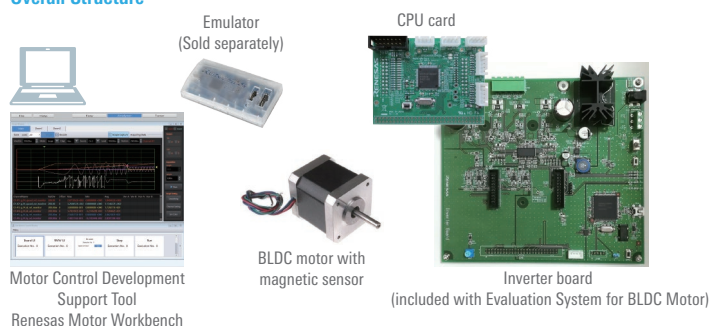
Overall Structure



Evaluation Environment Specifications

Item	Specification
Structure	Evaluation System for BLDC Motor 
	RX13T/23T/24T/24U/66T/72T/72M CPU card 
	BLDC motor with magnetic sensor
Inverter specification	Rated voltage: 48V
	Rated current: 5A (RMS)
	Protect function: Overcurrent detection, others

Sample Software	Supported MCUs
Vector control + Speed control (Magnetic sensor)	RX13T ^{*1} , RX23T ^{*2} , RX24T, RX24U, RX66T, RX72T, RX72M
Vector control + Position control (Magnetic sensor)	RX13T ^{*1} , RX23T ^{*2} , RX24T, RX24U, RX66T, RX72T, RX72M

*1: Digital output only

*2: Digital or SPI output only

Solutions Using Inductive Position Sensors

IPS2200 (Inductive Position Sensor)

This is thin, lightweight and cost effective with stray magnetic field immunity and contributes to the design for industrial motor. This is ideal for industrial and medical motor commutation and robot application.

Features

- For control of electrical motor (especially BLDC motor)
- Power-supply voltage: 3.3V or 5V
- Support up to 250,000 rpm, low latency (<10µs)
- Magnet-free, thin, lightweight and low-cost solution
- High stray magnetic field immunity
- Sine/cosine (analog) output
- Support multiple pole pairs
- Operating temperature: -40°C to +125°C
- TSSOP-16

- This is a sensor detecting the position of the target metal based on the electromagnetic induction of the coil.
- The sensing element of IPS2200 enables to match the number of target sectors to pole pairs of the motor to maximize accuracy. Sectors can be mounted both to shaft axis (on-axis) and shaft side (off-axis) of the motor, which increases the degree of freedom of the design.
- This is thin and lightweight with one-tenth thickness and one-hundredth weight of the existing resolvers at maximum.

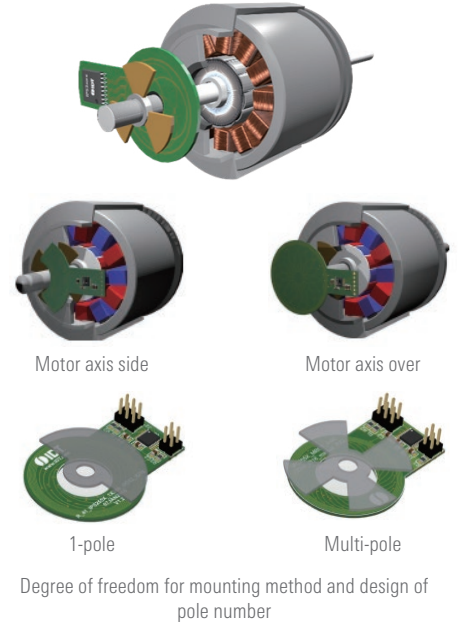

IPS2550STKIT

This is the kit for IPS2550, which includes the detection part of the position sensor and the interface board with PC. By combining with the dedicated GUI, you can easily visualize the angle.

* This kit does not include a motor.
This kit is not designed to perform motor control but to check the output information from the position sensor.

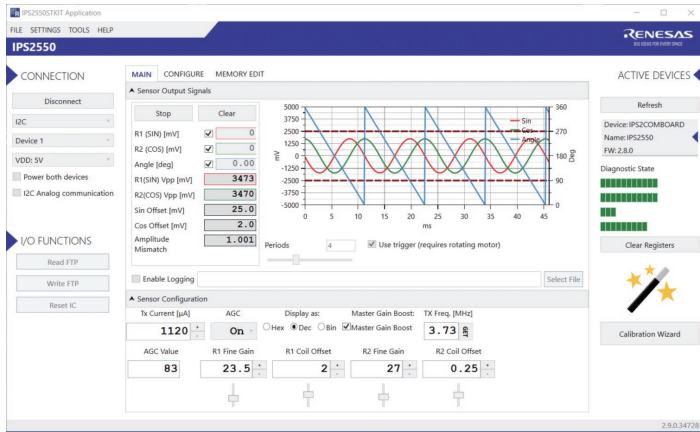

IPS2550 Dedicated GUI

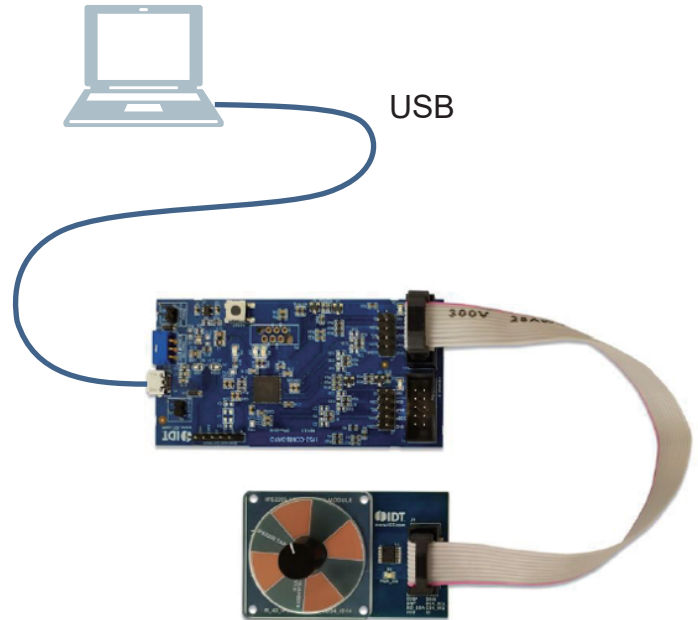

Inductive Sensor Processing IC (IPS2550 Series)

Part No.	Operation Voltage	Operation Temperature	Rated Speed	Output Type	Safety Function	Package	Provide
IPS2550DE1R	3.0V to 3.6V or 4.5V to 5.5V	Ta = -40°C to +160°C	Max. 600,000 rpm (Electric angle)	sin/cos (Differential or single ended)	Overvoltage detection, reverse polarity detection, short circuit protection	TSSOP-16 Pin (4.4mm × 5.0mm)	13" reel - 4000 IC/reel

Whole Speed Range Sensorless Vector Control Solution for IPM Motors

This solution implements sensorless vector control of a salient IPM motor (IPMSM) from zero speed at the rated torque.

This solution includes Inverter board, CPU cards, sample code, application notes as well as development support tool. This solution is ideal for applications involving load torque at zero speed (start) or low speed and applications requiring energy efficiency in the low-speed range, such as Home appliance, E-bike, Electric Wheelchair, or Power tools.

Features

- Supports IPM motors. (Ordinary SPM motors and non-salient motors are not supported.)
- Eliminates need for magnetic pole position sensor for reduced BOM cost and better reliability.
- The sensorless algorithm enables output of the rated torque from zero speed or low speed.
- Compatible with Motor Control Development Support Tool Renesas Motor Workbench.
- Overcurrent, overvoltage, and overheating protection functions enable safety evaluation.
- Three inverter board options for High Voltage and Low Voltage motor control as below table.
- Sample Code available: implementing high-voltage motor control (PFC control, Vibration suppression function, etc.) and control method (vector control, etc.) along with application note that describe control method explanation and how to implement to MCU *.
- Can be used for IPM motor control when used in combination with the DC 311V input high-voltage inverter board (which must be purchased separately from Desk Top Laboratories Inc.).

* Please make sure to confirm sample program and application note are targeting MCI-HV-1 (RTK0EM0000B14030BJ) and MCB-RA6T2 before use.

Operation Overview

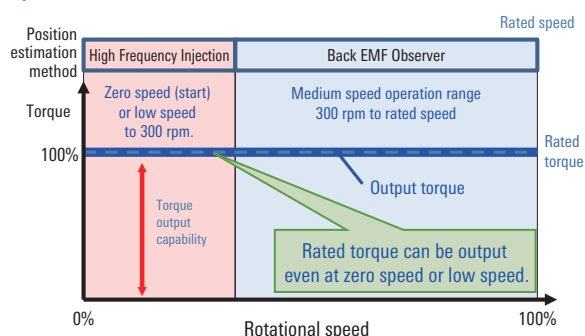

Evaluation Environment Specifications

Item		Specification		
Structure	Inverter Board	MCI-LV-1*	MCI-HV-1	T1102 (Inverter board made by Desk Top Laboratories Inc.)
	CPU Board	MCB-RX26T TypeA*	MCB-R6T2	RX66T CPU card
	Communication Board	MC-COM*	MC-COM	←
Inverter specification	Rated Voltage	DC24V	AC240V, DC390V	AC220V DC311V
	Rated Current	AC10A	AC10A	AC15A
	Protect Function	Overcurrent detection	Overcurrent detection, Overheat detection, Overvoltage protection, Short-circuit prevention, Inrush current prevention	Overcurrent detection, others
Sample code	Sensorless Vector Control for IPMSM over the Whole Speed Range for MCK	RA6T2 Sensorless Vector Control for IPMSM over the Whole Speed Range	RX Family Sensorless Vector Control for IPMSM over the Whole Speed Range Rev.1.00	

* MCI-LV-1, MCB-RX26T TypeA and MC-COM are included in [MCK-RX26T](#).

System Configuration

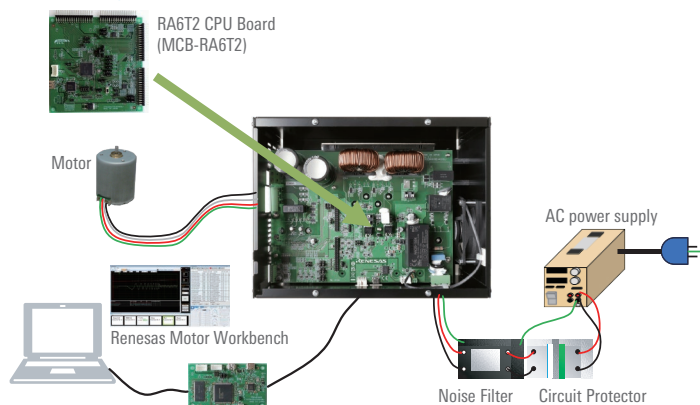

Digital Control Solution for 3-Level Inverter Power Supplies

This solution implements digital control for 3-phase DC/AC inverter power supplies for solar power conditioners, uninterruptible power supplies, and industrial applications. The inverter circuit employs low-loss silicon carbide (SiC) power elements and a 3-Level (T-type) circuit topology, making possible more compact and lightweight filter reactors that improve system efficiency and eliminate unwanted harmonic components.

Features

- Supports both 2-Level and 3-Level PWM operating modes.
- Supports switching frequencies from 20 to 50kHz, making possible higher power density and more compact and lightweight filter reactors (magnetic components).
- Simultaneous output of the 12 PWM gate signals required for 3-Level inverter operation is generated by synchronous operation of 6 channels of the RX66T's on-chip GPT timer.
- Application notes, sample code,* a development tool, and circuit data* are available so you can get started right away with application development.

* Provided separately.

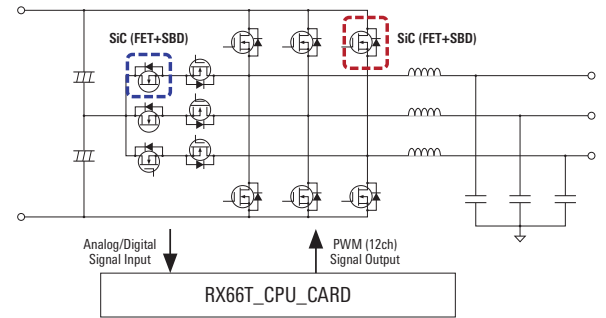

Circuit configuration of 3-Level (T-type) inverter

Evaluation Environment Specifications

Item	Specification
Structure	T-type 3-Level DC/AC Inverter demo board RX66T CPU card ↗
Inverter specification	<ul style="list-style-type: none"> ■ Input voltage: 600 to 850Vdc ■ Output voltage: 400Vrms, 3-phase, 50/60Hz ■ Output capacity: 10kW ■ Power factor: 0.8 ■ Inverter switching frequency: 20 to 50kHz ■ Cooling method: natural or forced air cooling ■ PWM type: 2-Level or 3-Level

Overall Structure

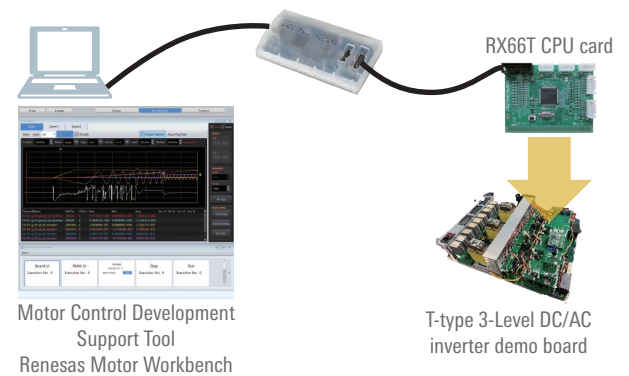

Motor Control Development Support Tool

Renesas Motor Workbench

When developing motor control software, if operation of the program is halted for debugging while the MCU is connected, control of the inverter circuit stops. This poses the danger of a large current flow occurring. Renesas provides a development support tool to deal with such situations.

Product Summary

- Analyzer function: Dynamic reading/writing of variables and waveform display while operating the motor.
- Tuner function: Automatic identification of motor parameters and control gains required for vector control.
- Easy GUI function: Makes it quick and easy for anyone to implement motor speed and position control by means of intuitive operations.
- Servo function: Implements an adjustment function for the motor's embedded position control system. (Supports adjustment of position control parameters, inertia estimation, origin return operation, and point-to-point control.)
- RMW-DLL: Functions needed for debugging are provided as APIs, allowing connection to a GUI developed to the user's specifications.
- Built-in communication library: In addition to the standard library, a communication library for simple debugging using a commercially available serial-USB conversion cable or the like is provided.

Renesas Motor Workbench provides powerful support for developers of motor control applications, allowing operation of motor control programs from a PC and extraction of data within programs.

Example usage scenario

Evaluation System for BLDC Motor / for Stepping Motor with Resolver

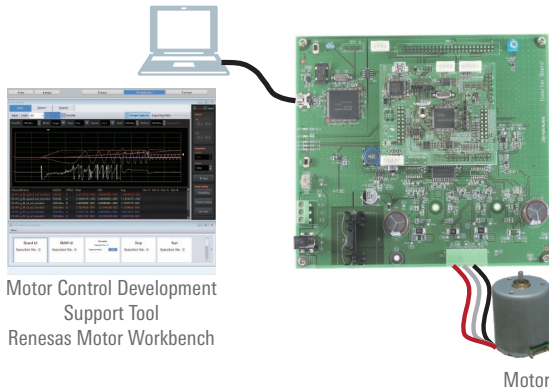

MCK-XXX

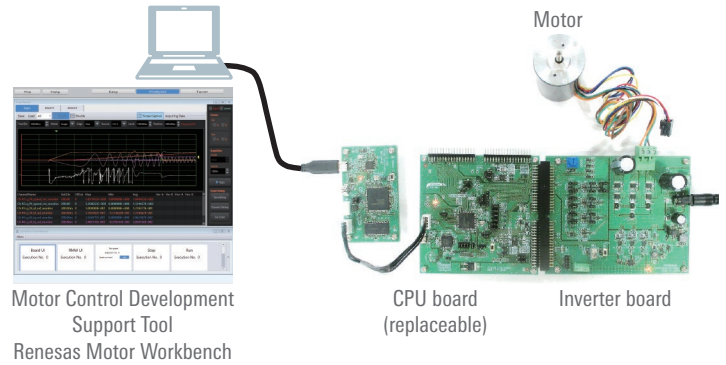

Renesas Motor Workbench Functions

Analyzer

Extensive functions include trigger, zoom, and commander transmission etc., useful for debugging and evaluation. Also usable as user I/F.

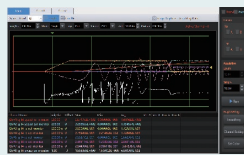

Tuner

Vector control at ease without know-how. Fine adjustment at ease with manual adjustment function, as well as quick result check.

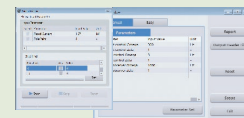

Easy GUI

Meters and waveform displays allow you to confirm the motor's operating status at a glance, greatly simplifying the debugging process.



Servo

Provides a custom GUI for adjusting position control parameters, inertia estimation, and operation of the actual system.

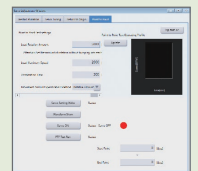

DLL

Makes it possible to use the functions of Renesas Motor Workbench via a GUI matching the user's specifications.

Excel VBA

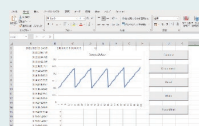

Net applications

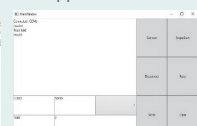

Motor Control Development Support Tool

Analyzer

Functions

- Dynamically write/read variables while driving a motor
- Dynamically display waveform while driving a motor
- Specify trigger and each display settings with the waveform display
- The commander function allows creation and transmission of sequences for changing variables of your choice.
- The user button function lets you change a user-defined group of variables with a single click.

User's voice

- Very useful, you can observe variables inside MCU.
- Amazed at the debugging function without the need to stop CPU. The tool to enable safe analysis operation.

Easy analysis with trigger/zoom functions

Step response evaluation at ease with commander (command value creation & transmission)



Display variables for 8 channels (can specify scale and off-set settings etc. per channel)

Tuner

Functions

- Automatically measure motor-unique parameters (resistance, inductance, induced voltage constant variable, and inertia)
- Automatically adjust the PI control gain of current/speed/position
- Automatically adjust the expected gain for sensorless vector control
- Manual tuning to finely adjust each PI control
- Output results in pdf and motor-driver header files

Finely adjust the PI gain of current/speed/position

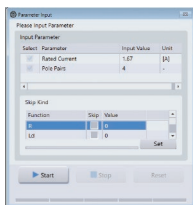
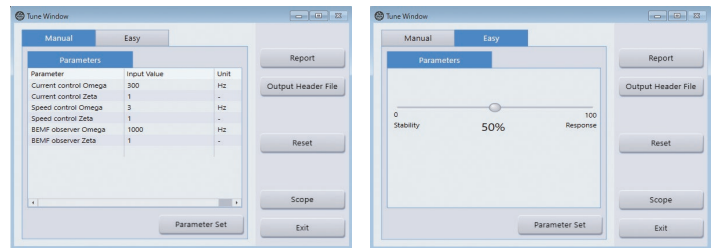

Input information are only rated current and pole pairs.

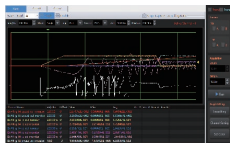

User's voice

- Great help, as I had much trouble in adjusting parameters.
- I could start motor right away after purchase.
- Convenient enough just to be able to use motor parameter.

Check adjustment results right away with the analyzer

Output adjustment results in pdf and motor header files available on the Web

Tuner Implementation Using Non-Renesas Kit

Using the tuner project included with the sample code, you can implement a tuner using a kit from a manufacturer other than Renesas.

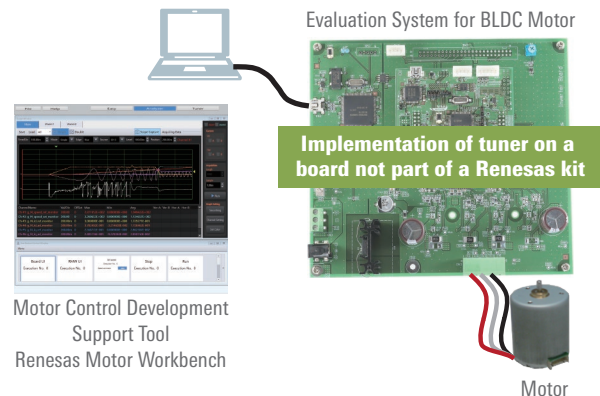

Motor Control Development Support Tool
Renesas Motor Workbench

Motor

Motor Control Development Support Tool

Easy GUI

Implements a GUI that allows more intuitive operation of the motor.

- Ability to set instruction values by manipulating sliders.
- Ability to configure instruction value profiles.
- Display of rotation speed, current values, etc., on meters.
- Switches for function switching.
- Waveform display of changes in values of variables.
- Ability to display a variety of parameters.

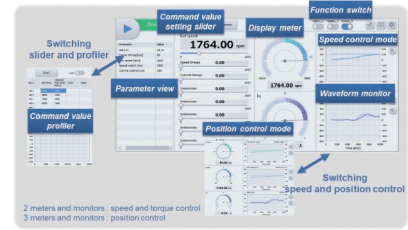

DLL

Variable read and write functions executed by the RMW (GUI) are provided in a DLL, making it possible to create tools using Excel VBA or as .NET applications.

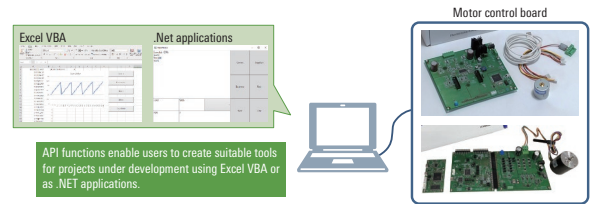

Built-In Communication Library

The download package contains both a standard communication library and a built-in communication library. Embedding the built-in communication library in the motor control program allows you to perform simple debugging using a USB-serial conversion board instead of a communication board compatible with Renesas Motor Workbench. Supported MCUs are the RA6T2, RA6T3, and RA4T1 (with support for additional MCUs planned for future release.).

Note: The number of points of waveform display data that can be displayed using the Analyzer module is limited.

Using MC-COM communication board: 100,000 data points

Using built-in communication library: 1,000 data points (RA6T2),

500 data points (RA6T3 and RA4T1)

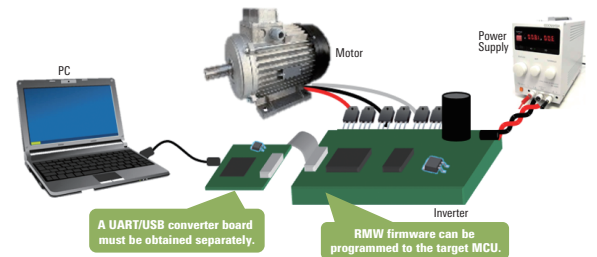

Servo

GUI for servo control

- Motor axis connected load inertia estimation function.
- Servo setting configuration function covering position control type, fixed frequencies, etc.
- Function for configuring the origin return method, return speed, etc.
- Function for point-to-point (PTP) single-axis operation.

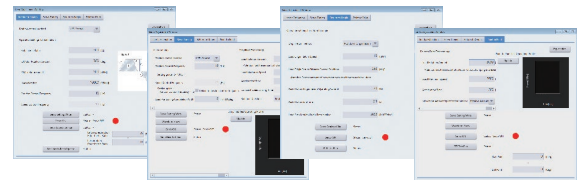

Other

- Function for displaying variable uses.
- Function for outputting variables adjusted using the Analyzer module to a folder of your choice in sample code header file format.
- Navigation function with GUI support.
- Improved variable search function.



New Functions of Renesas Motor Workbench 3.2

Tuner for RL78

Tuner support RL78 device (Target is BLDC motor).

All tuner functions are available with RL78/G24 Motor Control Evaluation Kit.



RL78/G24 Motor Control Evaluation Kit

Tuner support MCI-HV-1

Tuner support Renesas Flexible Motor Control Inverter Board for 100V/200V Three-Phase BLDC/ Induction Motor.

All tuner functions are available with MCI-HV-1.



MCI-HV-1

Remove authentication function

Authentication function was removed from Renesas Motor workbench 3.2.

You don't need to import the latest authentication file.

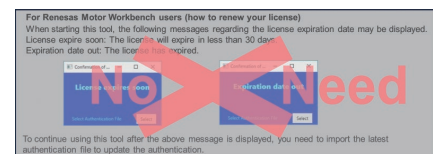

Motor Control Development Support Tool

Specification

Item		Specification
All	Supported MCU	RX13T, RX23T, RX24T, RX24U, RX26T, RX66T, RX72T, RX72M, RA6T1, RA6T2, RA6T3, RA4T1, RA8T1, RL78/G24. RL78/G1F, RL78/G14 supports the analyzer function only.
	Usage environment (OS)	Windows 10 or Windows 11
Communication	Peripherals, port	UART 1 ch, DMA (DTC) Port: TXD, RXD
	Communication I/F	USB2.0 (Communication Device Class)
	Communication board	The following kits have communication circuits. <ul style="list-style-type: none"> • Evaluation System for BLDC Motor • Evaluation System for Stepping Motor with Resolver For MCK-XXXXX or user board <ul style="list-style-type: none"> • MC-COM • W2002 (Desk Top Laboratories Inc.*)
Analyzer	Waveform display	8 channels (scale and off-set setting per channel), zoom function (2 windows), Trigger mode selectable from Single/Auto/Normal, save waveform data in a csv format
	Write/ Read variable	Ability to select up to 255 variables simultaneously, useful functions that simplify debugging (user buttons, commander function, rename function)
	Number of waveform display data points	100,000 data points (using standard library)
Tuner	Input information	Rated voltage and number of pole pairs of motor to be measured
	Output information	Motor-unique parameter (Resistance, Inductance, Magnet flux, Rotor inertia) and Control gain output Output file format: pdf file, header file*1
Servo	Supported functions	Inertia estimation function (rotor + load), servo adjustment function, origin return processing, PTP control

*1: Corresponds to sample files for motor control sample code released by Renesas. Refer to the user's manual of Renesas Motor Workbench for details..

Item		Specification
DLL	Usage environment	Windows 10 only, .NET Framework 4.6.1 or later
	Development environment	Visual Studio 2015 or later, Excel
	Supported functions	Serial data connection, reading and writing variables, scope function

Item		Specification
Built-in communication library	Supported MCUs	RA6T2, RA6T3, RA4T1
	Communication board	Commercially available USB-serial conversion cable or board
	Number of analyzer waveform display data points	RA6T2: 1,000 data points RA6T3/RA4T1: 500 data points

Environment Used

- Evaluation System for BLDC Motor
- Evaluation System for Stepping Motor with Resolver
- MCK-XXXXX (Bundled MC-COM is used.)
- MCI-HV-1 + MCB-RA6T2



Simply connect the kit with the sample code programmed to it to a PC using a USB cable, then launch Renesas Motor Workbench to get started.

Communication boards

Renesas Electronics
MC-COM

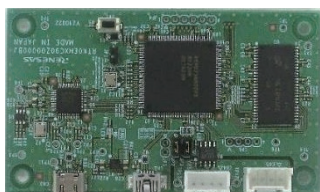

Desk Top Laboratories
W2002

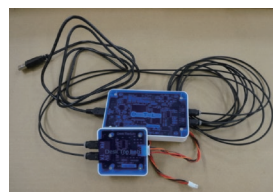

- Evaluation system for XXXXX

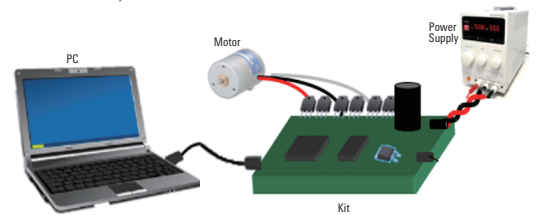

- MCK-XXXXX, MCH-HV-1 or user environment

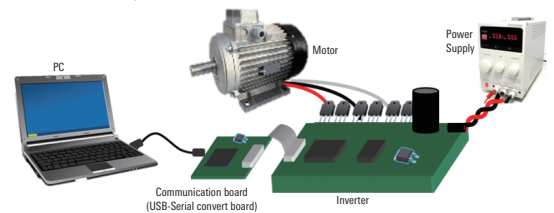

Note: A communication board is required when using a user environment.

Motor Control Development Support Tool

QE for Motor

QE for Motor is a motor control software development support tool that enables users to develop motor control software by performing operations arranged into a workflow. It is an extension to the e² studio integrated development environment e² studio that can be downloaded at no charge.

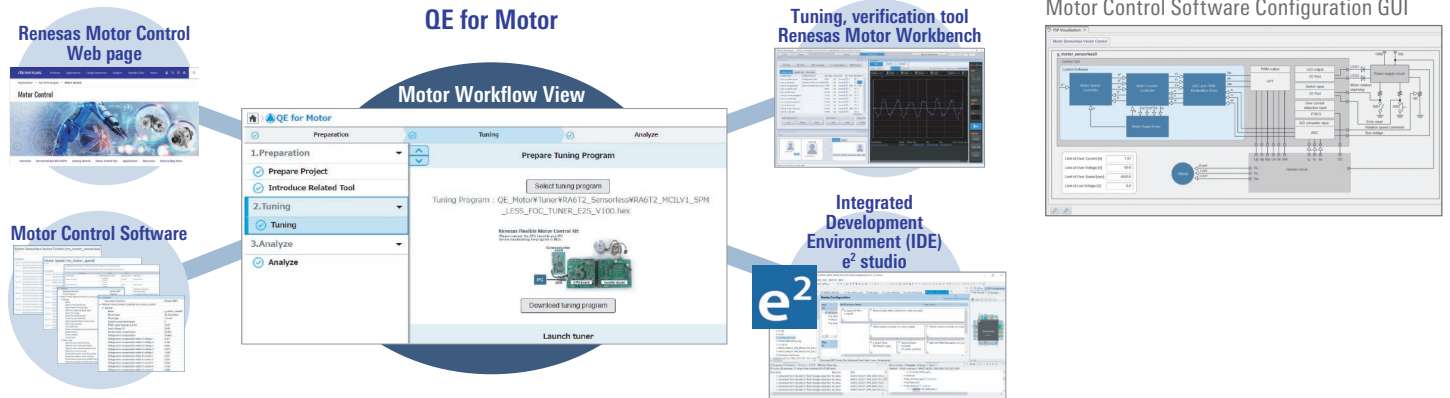

- Features**
- Simply follow a workflow in QE for Motor to seamlessly implement the steps required to evaluate motor control software.
 - Information on motor control solutions is available on the Renesas website.
 - You can configure settings of sample code middleware and drivers used for motor control via a GUI displaying a motor control block diagram.
 - You can launch the Tuner and Analyzer modules of Renesas Motor Workbench from QE for Motor with a single click to easily generate parameter files and evaluate software.
 - Supported MCUs
 - RA Family: RA4T1, RA6T1, RA6T2, RA6T3, RA8T1
 - RX Family: RX26T
 - RL78 Family: RL78/G1F, RL78/G24

Motor Driver Generator Function of Smart Configurator for RX

The Motor component of Smart Configurator for the RX Family can generate drivers suitable for motor control for peripheral functions such as the multi-function timer pulse unit and A/D converter module, and you can use it without needing to be aware of the minute details of peripheral settings. This function is available in the e² studio integrated development environment and in RX Smart Configurator (standalone version).

Timer (MTU/GPT) Settings

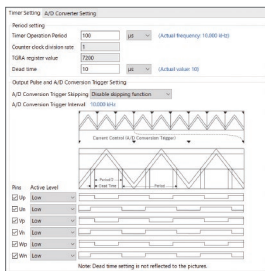

- Configurable Settings**
- Complementary PWM mode (MTU3 or GPT) or triangle-wave PWM mode (GPT)
 - Switching frequency
 - Dead time duration
 - A/D conversion start trigger settings
 - PWM signal output polarity
 - Motor connection pin selection

12-Bit A/D Converter (S12AD) Settings

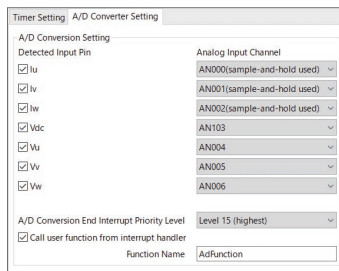

- Configurable Settings**
- A/D converter pin selection for motor control
 - Interrupt priority level selection

Sensor Settings

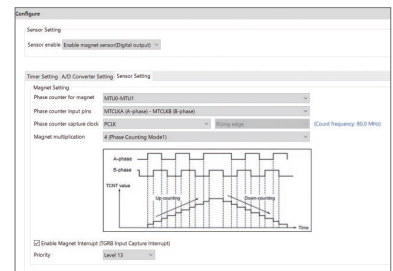

- Configurable Settings**
- Motor component setting support Encoder and Hall sensor
 - Motor component setting support Magnetic sensor (digital output) for RX24T

- Features**
- By configuring settings in a simple GUI, you can generate driver source code for the timer (multi-function timer pulse unit (MTU) or general PWM timer (GPT)) and 12-bit A/D converter (S12AD) peripheral modules that perform pulse output and current measurement essential for motor control. Complex settings such as timer pulse output settings (complementary PWM mode settings) and settings to trigger A/D conversion by timer events are configured automatically by the generated drivers.
 - It is easy to change settings for the peripheral function channels or pins used for motor control from within Smart Configurator.

Supported MCUs: RX13T, RX23T, RX24T, RX24U, RX26T, RX66T, RX72T, and RX72M
Supported motors: 3-phase brushless DC motors and 2-phase stepping motors

Motor Control Development Support Tool

Motor Driver Generation Function of RZ Flexible Software Package (FSP)

Using the FSP versions available for the RZ/T2M, RZ/T2L, and RZ/N2L, you can generate drivers suitable for motor control for peripheral functions such as timers, A/D converters, and the delta-sigma ($\Delta\Sigma$) interface, all without needing to think about detailed peripheral settings. This function is available in the e2 studio integrated development environment and in the version of Smart Configurator (standalone product) with support for software from IAR Systems.

The FSP can generate the following types of motor drivers.

- 3-phase PWM output timer for GPT
- 3-phase PWM output timer for MTU3
- A/D converter
- Delta-sigma ($\Delta\Sigma$) interface
- Phase counting mode using GPT
- Phase counting mode using MTU3

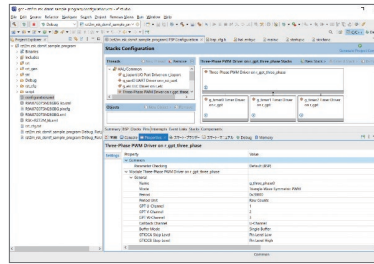

Settings

- Left-right symmetric/asymmetric triangle-wave PWM settings
- Carrier period
- Dead time
- A/D conversion start trigger settings
- PWM signal output polarity
- Motor connection pin selection
- Single- or double-buffer selection

Features

- By configuring settings in a simple GUI, you can generate driver source code for the multi-function timer pulse unit 3 (MTU3) and general PWM timer (GPT) that generate PWM output, and for the 12-bit A/D converter (ADC12) and delta-sigma ($\Delta\Sigma$) interface (DSMIF) that perform current measurement, both of which are necessary for motor control.
- Smart Configurator lets you easily change settings to configure items such as the peripheral function channels and pins used for motor control.

Supported MPUs: RZ/T2M, RZ/T2L, and RZ/N2L

Flexible Software Package (RA Family)

The Renesas Flexible Software Package (FSP) is an enhanced software package designed to provide easy-to-use, scalable, high-quality software for embedded system designs using Renesas RA Family Microcontrollers. With the support of Arm® TrustZone® and other advanced security features, FSP provides a quick and versatile way to build secure, connected IoT devices using production-ready drivers, Azure® RTOS, FreeRTOS™, and other middleware stacks.

FSP uses an open software ecosystem and provides flexibility in using bare-metal programming, included Azure RTOS or FreeRTOS, your preferred RTOS, legacy code, and third-party ecosystem solutions.

The combination of the flexible open architecture of the FSP plus the wide choice of 3rd party solutions as part of the Arm ecosystem increases the range of choice for application development. This means that developers can choose the software model that best suits their needs while utilizing Renesas's excellent Arm-based silicon solutions as well as speed up the implementation time of complex areas like connectivity and security.

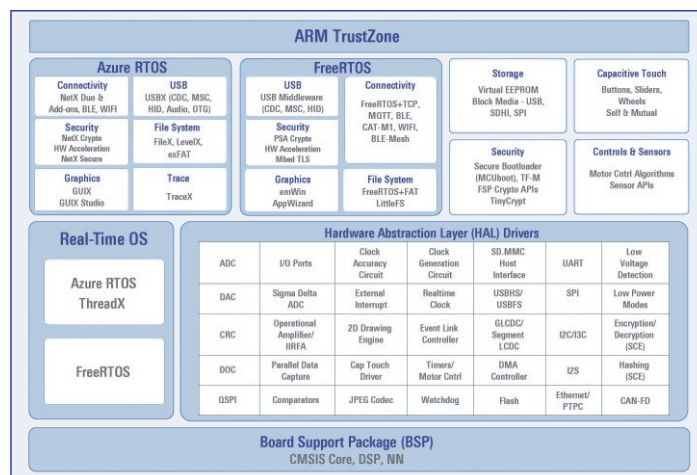

Benefits

- Provides an easy-to-use, scalable, high-quality software for embedded system designs using the Renesas RA Family of Arm microcontrollers
- Includes best-in-class HAL drivers with high performance and low memory footprint
- Middleware stacks with Azure RTOS and FreeRTOS integration are included to ease the implementation of complex modules like communication and security
- The e² studio IDE provides support with intuitive configurators and intelligent code generation to make programming and debugging easier and faster
- Uses an open software ecosystem and provides flexibility in using bare-metal programming, included Azure RTOS or FreeRTOS, your preferred RTOS, legacy code, and third-party ecosystem solutions
- Integrated package with all required components for easy setup and starting development (single installer with e² studio, CMSIS packs, tool chain and SEGGER J-Link drivers)
- Complete source code available through GitHub

RAA227063 3-Phase Smart Gate Drivers

RAA227063 Smart 3-Phase

System Integration (Smart Gate Driver with Built-in Power Supply for System and High Accuracy Amp for 3-Shunt)

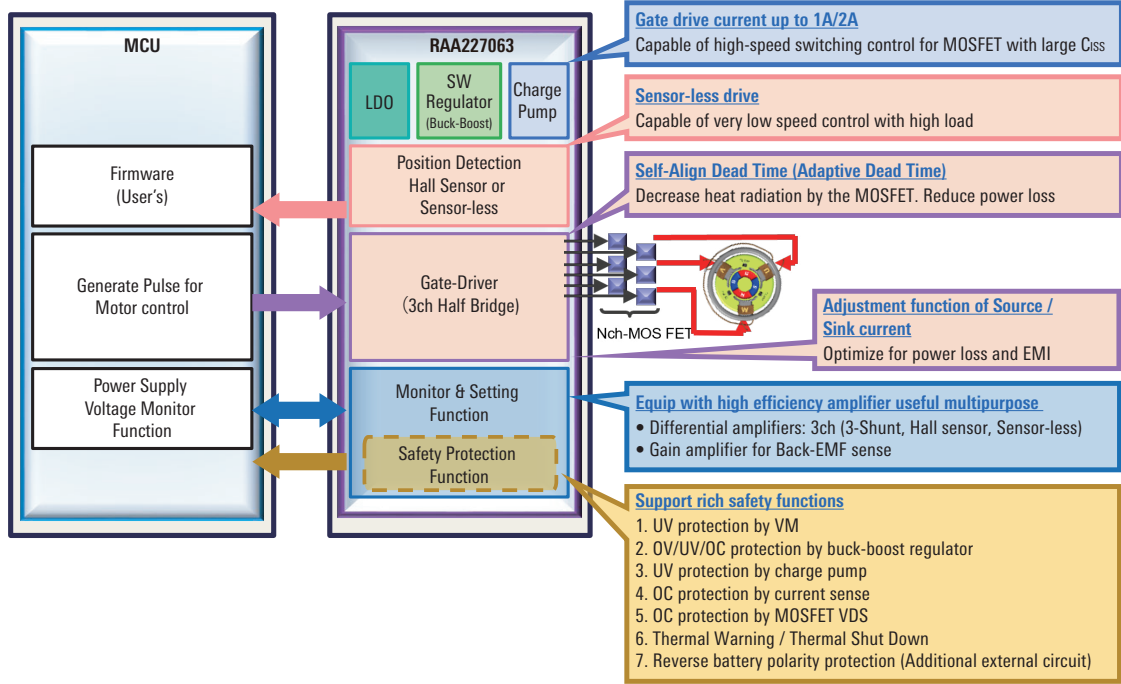

Development Tool

Easy to Connect with Renesas CPU Card, Start to Evaluate by Sample Firmware of Renesas MCU

- PCB size: 14.1cm x 16.0cm
- Power input: 4.5V to 60V, motor driving MOSFETs are rated at 80V 132A.
- MCU connectors are compatible to Renesas RL78/G1F, RX23T, and RA6T1 CPU card interface. (Has interface to MCU for motor current & voltage sensing, PWM signals, fault condition, enable IC, SPI connection, etc.)

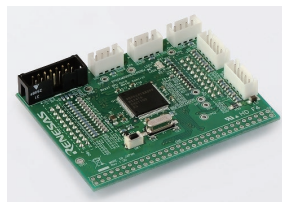

CPU Card
(RL78/G1F, RX23T, RA6T1)

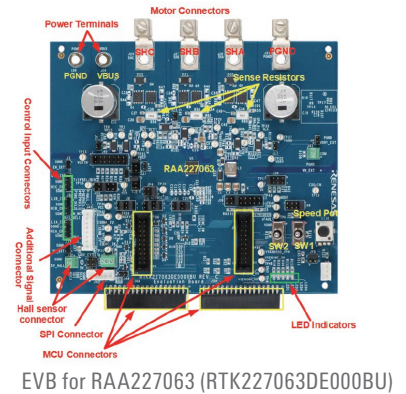

EVB for RAA227063 (RTK227063DE000BU)

Product	PKG	Operating Voltage (V)	Applications
RAA227063*1	48 Ld QFN (7mm × 7mm)	4.5 to 60V	Power tool, Gardening tool, Cord-less vacuum cleaner, Cooling-fan, Water pump, Air pump, AGV, Robotics, etc.

*1: RAA2270634GNP#MAD: Reel 250pcs Ta= -40 to 125 °C
RAA2270634GNP#HAD: Reel 4k pcs Ta= -40 to 125 °C

Inquiry window

Please contact customer support via the website for further information. <https://www.renesas.com>

RAA306012 3-Phase Smart Gate Drivers

RAA306012 3-Phase Smart Gate Driver

System Integration (Smart Gate Driver with Built-in Power Supply for System and High Accuracy Amp for 3-Shunt)

Features

- Wide VIN range: 4.5V to 65V (78V abs max)
- Switching frequency range up to 200kHz
- 3-Phase drive for BLDC application
 - Peak current 0.64A/1.28A (source/sink) with adjustable drive strength
 - Supports up to 16 adjustable levels of drive strength through SPI
- Adjustable and adaptive dead-time control
- Low power consumption sleep mode with less than 28uA quiescent current to maximize battery life in portable applications.
- Includes complete system power supply with efficient architecture
- Support back-EMF sensing to support BLDC motor sensor-less operation
- Extensive fault protection: UV/OV, VDS OCP, Current sense OCP, etc.
- Package: 48 Ld QFN (7mm x 7mm, 0.5mm pitch)

Benefits

- Allows to Scale the MCU to Address the Application Specifications
 - Renesas MCU: RL78, RX32T, RA6T1, RA2L1, etc.
- Integration of Analog Power Components Saves Board Space and Allows for Easy Tuning

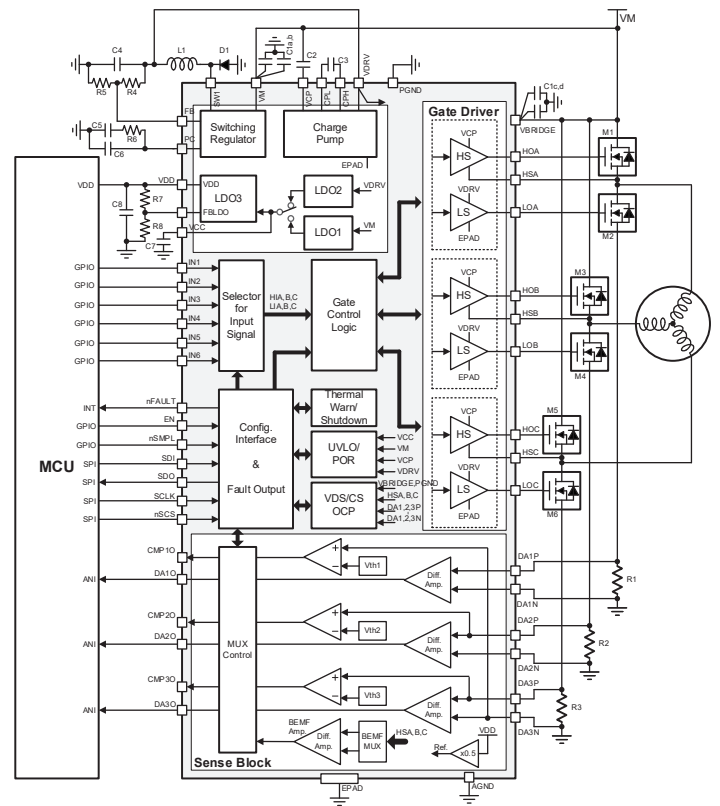

Development Tool

- Starter Kit is used to evaluate a BLDC motor system using the RAA306012 and RX13T&RL78/G1F(MCUs).
- Easy to start motor control evaluation with the RAA306012
- The reference firmware is written to the control board of the set. By connecting the attached small motor to the board and supplying power, evaluation can be started immediately.
- Board with high expandability and operability (size: 160mm × 210mm)
- The board is easy to operate, and switches, potentiometers, LEDs, and thermistors are mounted, their functions can be used by using the user program.

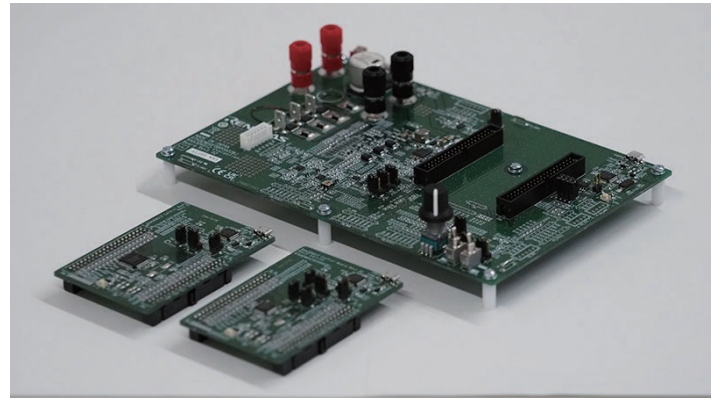

Part No.	Package	Operating Voltage (V)	Applications
RAA306012	48Ld QFN (7mm × 7mm)	4.5 to 65V	Power tool, Gardening tool, Cord-less vacuum cleaner, Cooling-fan, Water pump, Air pump, AGV, Robotics, etc.

Inquiry window





Please contact customer support via the website for further information. <https://www.renesas.com>

HVPAK™



Programmable Mixed-Signal Matrix with High Voltage Features (up to 26.4 V and up to 3 A per output)

The HVPAK SLG47105 and SLG47115 combine GreenPAK™ mixed-signal logic and H-/Half-bridge functionality. The HVPAK advanced PWM macrocells allow driving multiple motors or inductive loads with different PWM frequencies and duty cycles. Low (70 nA) current consumption in the standby mode together with a compact 2 mm x 3 mm size provide even more benefits. This highly versatile device allows a wide variety of mixed-signal functions to be designed alongside high-voltage capabilities.

HVPAK Capabilities

<p>Brushed DC</p>  <ul style="list-style-type: none"> ▪ Programmable Current Limiting ▪ PWM frequency up to 200 kHz 	<p>Stepper Motor</p>  <ul style="list-style-type: none"> ▪ Full step mode ▪ Microstep mode ▪ Changing motor rotation direction 	
<p>Solenoid/Relay/Valve</p>  <ul style="list-style-type: none"> ▪ Rising current curve control ▪ Multi-drivers ▪ No need an external diode for relay coil ▪ Zero-Crossing Detection 	<p>Multiple Functions</p>  <ul style="list-style-type: none"> ▪ Programmed constant motor speed ▪ Programmable undervoltage and overcurrent protection ▪ LEDs indicator 	<p>Buck / Boost / Buck-Boost</p>  <ul style="list-style-type: none"> ▪ No external switches or diodes ▪ Minimum external components ▪ Internal selectable Vref ▪ Overcurrent/short circuit protection ▪ Highly customizable design

HVPAK Value

<p>Integrate</p>  <p>Reduce</p> <ul style="list-style-type: none"> ✓ Solution price ✓ BOM ✓ PCB size ✓ Power consumption 	<p>Differentiate</p>  <p>Add</p> <ul style="list-style-type: none"> ✓ New features ✓ More custom protections ✓ Unique control signals <p>Create a custom motor driver solution</p> <p>Protect the design from being copied by competitor</p>	<p>Offload MCU</p>  <p>Offload MCU with motor driving control moved to HVPAK</p> <p>Monitor sensor signals and make a decision based on these signals</p> <p>Get standalone solution without MCU in simple applications</p>
---	--	--

Development and Evaluation Tools

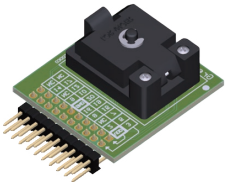

HVPAK Socket Adapters
([SLG47105V-SKT](#) and [SLG47115V-SKT](#))
* works together with SLG4DVKADV

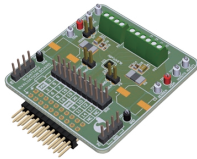

HVPAK Evaluation Board
([SLG47105V-EVB](#) and [SLG47115V-EVB](#))
* works together with SLG4DVKADV

Download [Go Configure™ Software Hub](#) | [Renesas](#) to create your HVPAK designs. This is free GUI-based software.
Useful Resources: [Documentation & Downloads Search](#) | [Renesas](#)

Solutions for DC / Stepper Motors, Solenoid, LED, and DC-DC

HVPAK SLG47105 Demo Board

The HVPAK Demo Board allows to get acquainted with SLG47105's functionality, especially the H-Bridge and Half-Bridge functions, and demonstrates the power part of the chip. This board is designed for hands-on and visually shows the SLG47105 chip's capability to handle both DC and Stepper Motors, as well as LEDs. The chip on the Board is already programmed with a versatile project, allowing to control different loads and switch between modes.

To launch the board, it is necessary just to connect it to any power source using a USB cable. Additionally, it is possible to emulate any custom project on this board using [Go Configure™ Software Hub](#).

Overall Structure

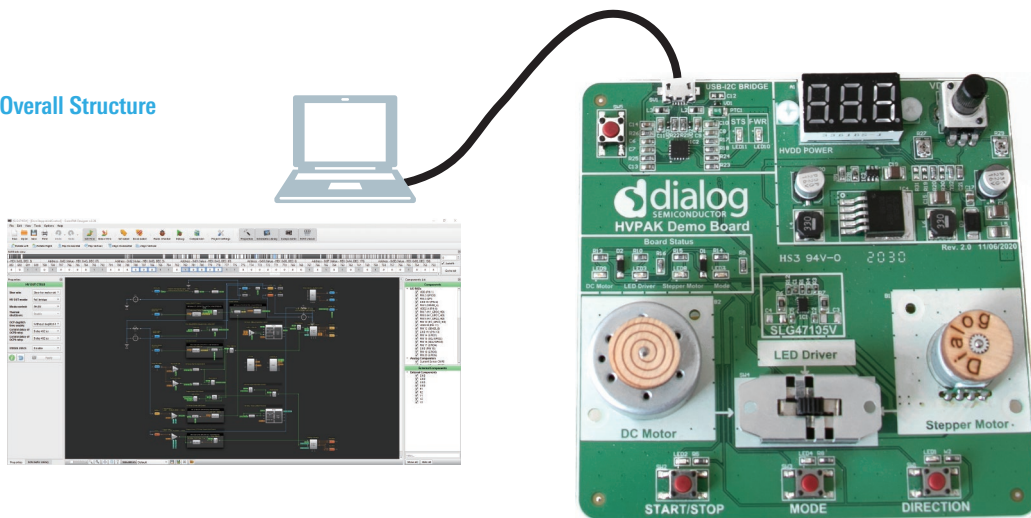

HVPAK Evaluation Boards

SLG47105V-EVB and SLG47115V-EVB

The HVPAK evaluation boards have been developed for testing designs with all features and high current loads. You can emulate/program the HVPAK chip using this evaluation board with the GreenPAK Advanced Development Board. Just connect the evaluation board to the Advanced Development Board and use a USB cable to power them.

The [Go Configure™ Software Hub](#) will identify the boards and let you emulate/program the part. To start the evaluation, you need to separately power the HV part. Then, you can test your design using the measuring equipment.

Overall Structure

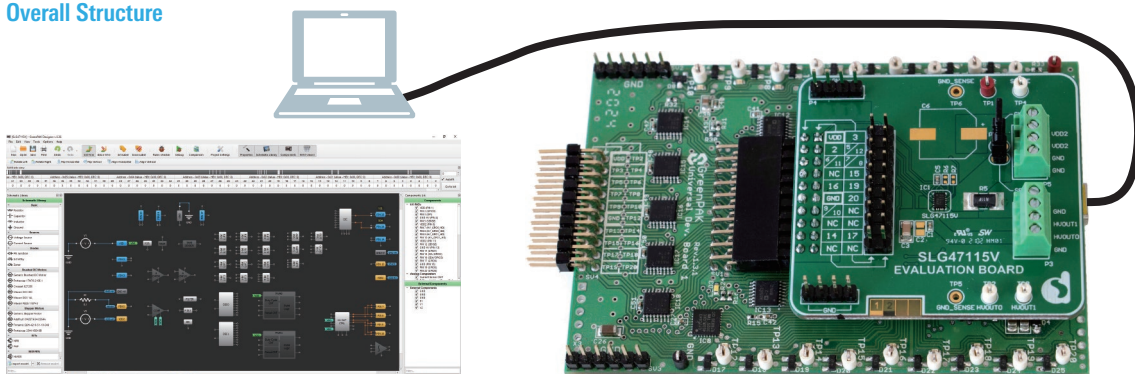

Recommended Products: MCUs and MPUs

RL78 Family

Part No.	Pin Number	ROM (KB)	RAM (KB)	Operating Frequency	Power-supply Voltage
RL78/G14	30 to 64	16 to 64	2.5 to 5.5	32MHz	1.6 to 5.5V
	80 to 100	96 to 512	12 to 48		
RL78/G1F	24 to 64	32/64	5.5	32MHz	1.6 to 5.5V
RL78/G1G	30 to 44	8/16	1.5	24MHz	2.7 to 5.5V
RL78/G1M	20	4/8	0.512/1	20MHz	2.0 to 5.5V
RL78/G24	20 to 64	64/128	12	48MHz	1.6 to 5.5V

RX Family

Part No.	Pin Number	ROM (KB)	RAM (KB)	Operating Frequency	Power-supply Voltage
RX13T	32 to 48	64 to 128	12	32MHz	2.7 to 5.5V
RX23T	48 to 64	64 to 128	12	40MHz	2.7 to 5.5V
RX24T	64 to 100	128 to 512	16 to 32	80MHz	2.7 to 5.5V
RX24U	100 to 144	256 to 512	32	80MHz	2.7 to 5.5V
RX26T	48 to 100	128 to 512	48 to 64	120MHz	2.7 to 5.5V
RX66T	48 to 144	256 to 1024	64 to 128	160MHz	2.7 to 5.5V
RX72T	100 to 144	512 to 1024	128	200MHz	2.7 to 5.5V
RX72M	176/224	2048 to 4096	1024	240MHz	2.7 to 3.6V

RZ Family

Part No.	Pin Number	ROM (KB)	RAM (KB)	Operating Frequency	Power-supply Voltage
RZ/T2M	128/176/225/320	0	576 to 2624	800MHz	3.0 to 3.6V
RZ/T2L	196	0	1600	800MHz	3.0 to 3.6V
RZ/T1	176/320	0	544 to 1568	600MHz	3.0 to 3.6V
RZ/T1-M	112	0	544 to 1568	450MHz	3.0 to 3.6V
RZ/T2H	729	0	2048	1200MHz	3.135 to 3.465V

RA Family

Part No.	Pin Number	ROM (KB)	RAM (KB)	Operating Frequency	Power-supply Voltage
RA4T1	32/48/64	128/256	40	100MHz	2.7 to 3.6V
RA6T1	64/100	256/512	64	120MHz	2.7 to 3.6V
RA6T2	48/64/100	256/512	64	240MHz	2.7 to 3.6V
RA6T3	32/48/64	256	40	200MHz	2.7 to 3.6V
RA8T1	100/144/176/224	1024/2048	1024	480MHz	1.68 to 3.6V

Recommended Products: Motor Sensor Processing IC, Motor Control IC

RDC IC (Resolver to Digital Converter)

Part No.	Resolver Driving Block			Converter Block			Amplifier Circuit Block	Control Block		Conversion Error	Power-supply Voltage	Power-supply Current	Operating Ambient Temperature	Package
	Input	Excitation Signal Output	Over Temperature Detection Circuit	Differential Amplifier Circuit	Signal Conversion Circuit	Disconnection Detection Circuit	Differential Amplifier Circuit	Communication Function	Operating Frequency					
RAA3064002GFP	Square wave: 5/10/20 kHz	Alternating current: 35mA _{p-p} (Max.)	Built-in	Gain Variable: 2, 4, 8, 16.5 times	Angle error correction function, Internal circuit error correction function	Detect disconnection from signal amplitude	2 ch (Support differential input), Gain variable: 10, 25 times	SPI interface (Max. 1MHz)	4MHz	±0.2°	VDD = 4.5-5.5V, IOVDD = AVDD	Maximum operating current: 20 mA (Typ.)	-40 to +85°C	LQFP-48pin (7mm × 7mm)
RAA3064003GFP													-40°C +105°C	

Inductive Sensor Processing IC (IPS2550 Series)

Part No.	Operation Voltage	Operation Temperature	Rated Speed	Output Type	Safety Function	Package	Provide
IPS2550DE1R	3.0V to 3.6V or 4.5V to 5.5V	T _a = -40°C to +160°C	Max. 600.000 rpm (Electric angle)	sin/cos (Differential or single ended)	Overvoltage detection, reverse polarity detection, short circuit protection	TSSOP-16 Pin (4.4mm × 5.0mm)	13" reel - 4000 IC/reel

HVPAK™

Programmable Mixed-Signal Matrix with High Voltage Features - DC/Stepper Motor, Solenoid, Valve, LED Control, DC-DC

Part No.	SLG47105V	SLG47115V
# of Pins / # of GPIO	20/8 + 4 x HD	20/8 + 2 x HD
Operating Voltage, VDD (V)	2.3 to 5.5	2.3 to 5.5
Dual Supply, VDD2 (V)	3.0 to 13.2	4.5 to 26.4
ACMPs	4	3
Voltage Reference	Trimmed	Trimmed
Combo Function Macro-cells	12 Total	12 Total
Multi-Function Macro-cells	5 Total	5 Total
PWMs	2	2
Counters/Delays	5	5
DFF / Latch	15	15
3-Output Pipe Delay	16-stage	16-stage
Programmable Delay	Yes	Yes
Internal Oscillator (Hz)	2k/25M	2k/25M
Temp Sensor	Yes	Yes
Communication Interface	I ² C	I ² C
STQFN Package Size (mm)	2.0×3.0	2.0×3.0

Recommended Products: Power Management

ISOLATED non-ISOLATED

* Used for Step-down from 200V to 24V and so on.

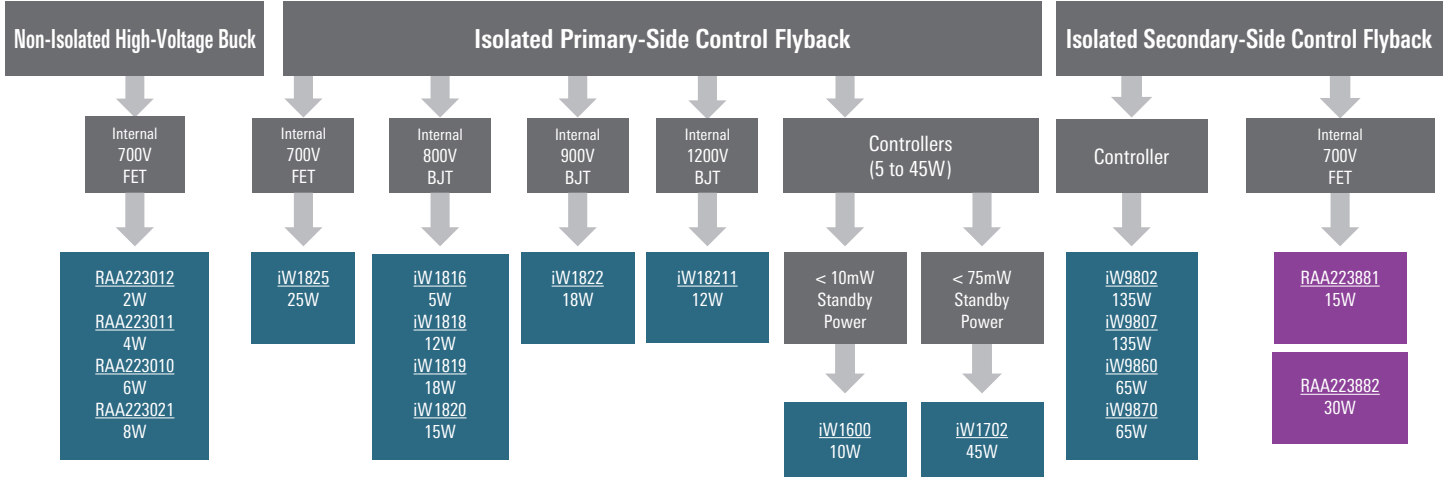

PWM Controller

Part No.	Description	Control Mode	UVLO Rising (V)	UVLO Falling (V)	Vbias max (V)	No Load Operating Current (mA)	PWM Output Number	Error Amplifier	FET Driver Iout max (A)	Switching Frequency (Hz)	Maximum Duty Cycle (%)	Package
ISL6840	Industry standard single end	Peak current mode	7	6.6	20	3.3	1	Built-in	1	4k to 2M	96	8Ld MSOP, 8Ld DFN
ISL6726	Active clamp - forward	Current mode	7.65	6.23	22	10	1	–	2	10k to 1M	80	20Ld QSOP
ISL8840A to ISL8845A	High performance - Industry standard single end	Peak current mode	7, 8.4, 14.3	6.6 to 8.8	30	2.9	1	Built-in	1	2k to 2M	48, 96	8Ld SOIC, 8Ld MSOP

DC/DC

Part No.	Vin (V)	Vout (V)	Iout (A)	Fsw (Hz)	PWM/PFM	Efficiency (%)	On Resistance typ (mΩ)	Operating Temperature Range	Package
ISL85009	3.8 to 18V	0.8 to Vin*92%	9	300k/600k	Yes	Max. 95	High: 17 Low: 8.5	-40 to 125°C	15-TQFN
ISL85014	3.8 to 18V	0.8 to Vin*92%	14	300k/600k	Yes	Max. 95	High: 15 Low: 6.5	-55 to 150°C	15-TQFN
ISL85412	3.5 to 40V	0.6 to 34	0.15	700k	Yes	Max. 92	High: 900 Low: 500	-40 to 125°C	12-DFN
ISL85413	3.5 to 40V	0.6 to 34	0.3	700k	Yes	Max. 92	High: 900 Low: 500	-40 to 125°C	12-DFN
ISL85415	3 to 36V	0.6 to 34	0.5	300k to 2M	Yes	Max. 94	High: 450 Low: 250	-40 to 125°C	12-DFN
ISL85418	3 to 40V	0.6 to 34	0.8	300k to 2M	Yes	Max. 96	High: 250 Low: 90	-40 to 125°C	12-DFN
ISL85410	3 to 40V	0.6 to 34	1.0	300k to 2M	Yes	Max. 96	High: 250 Low: 90	-40 to 125°C	12-DFN
ISL854102	3 to 40V	0.6 to 34	1.2	300k to 2M	Yes	Max. 93	High: 250 Low: 90	-40 to 125°C	12-DFN
RAA211412	5.8 to 45V	0.8 and up	1.0	630k	–	Max. 90	High: 600	-40 to 125°C	6-TSOT23
RAA211605	4.5 to 60V	0.8 and up	0.5	450k	–	Max. 93	High: 600	-40 to 125°C	6-TSOT23
RAA211650	4.5 to 60V	0.8 and up	5.0	200k to 2.5M	–	Max. 90	High: 90 Low: 37	-40 to 125°C	28-QFN
RAA211651	4.5 to 60V	0.8 and up	5.0	565k	–	Max. 93	High: 90 Low: 37	-40 to 125°C	28-QFN

Recommended Products: Power Management

LDO

Part No.	Description	V _{in} (V)	V _{out} (V)	Reference Voltage Accuracy (%) Full Temperature Range	Current Limit I _{out} (typ) (mA)	Dropout Voltage typ (mV)	PSRR@ 1kHz (dB)	I _q (μA) typ	Output Noise (μV/rms)	Package
RAA214220	150mA, 20V, low I _q	2.5 to 20	ADJ	+2.0/-2.0	220	225@150mA	92@100Hz	38	150@10mA	3-SOT23
ISL80136	50mA, 40V, low I _q	6 to 40	ADJ	1.223V +/-1.0	118	120@50mA	58@100Hz	18	26@10mA	8-EPSON
ISL80138	150mA, 40V, low I _q	6 to 40	ADJ	1.223V +/-1.0	410	295@150mA	66@100Hz	18	26@10mA	14-HTSSOP
ISL80410	150mA, 40V, low I _q	6 to 40	ADJ	1.223V +/-1.0	410	295@150mA	66@100Hz	90	26@10mA	8-EPSON
RAA214401	150mA, 40V, low I _q	4.5 to 40	3.3	+2.7/-3.1	150min	1370@150mA	52	3.6	237@10mA	3-SOT23

Recommended Products: Gate Driver, MOSFET, Peripheral IC

GreenPAK™

Programmable Mixes-Signal Matrix (fully customizable solution, low power, compact size, cost-optimized, programmed at factory)

GreenPAK™ with Low Drop Out Regulators (LDO)

Item	SLG51000	SLG51001	SLG51002	SLG51003	SLG46580	SLG46582	SLG46583	SLG46585
General Parameters								
Memory Type	OTP	OTP	OTP	OTP	OTP	OTP	OTP	OTP
# of Pins / # of GPIOs	20 / 6	16 / 4	25 / 6	14 / 5	20 / 9	20 / 9	20 / 9	29 / 7
Operating Voltage (V)	2.8 - 5.0	2.8 - 5.0	2.8 - 5.0	2.8 - 5.0	2.3 - 5.5	2.3 - 5.5	2.3 - 5.5	2.5 - 5.5
Communication Interface Type	I ² C	I ² C	I ² C	I ² C	I ² C	I ² C	I ² C	I ² C
Communication Interface Voltage	1.2V - 1.8V	1.2V - 1.8V	1.2V - 1.8V	1.2V - 5.0V	1.2V - 5.5V	1.2V - 5.5V	1.2V - 5.5V	1.2V - 5.5V
GPIO Voltage	1.2V - 1.8V	1.2V - 1.8V	1.2V - 5.0V	1.2V - 5.0V	1.2V - 5.5V	1.2V - 5.5V	1.2V - 5.5V	1.2V - 5.5V
Package Type	WLCSP	WLCSP	WLCSP	TQFN	TQFN	TQFN	TQFN	TQFN
Package Size (mm)	1.675 x 2.075 x 0.465, 0.4 pitch	1.675 x 1.675 x 0.465, 0.4 pitch	1.992 x 1.992 x 0.44, 0.35 pitch	2.0 x 2.2 x 0.55, 0.4 pitch	2 x 3 x 0.55, 0.4 pitch	2 x 3 x 0.55, 0.4 pitch	2 x 3 x 0.55, 0.4 pitch	3 x 3 x 0.55, 0.4 pitch
Operating temperature (°C)	-40 to +85	-40 to +85	-40 to +85	-40 to +85	-40 to +85	-40 to +85	-40 to +85	-40 to +85
Combinatorial Logic								
Analog Comparators	–	–	–	–	4	4	4	4
Max. Look Up Tables (LUTs) / DFF	12 / –	12 / –	8 / 8	8 / 8	15 / 9	15 / 9	15 / 9	16 / 9
Pipe Delay	–	–	–	–	16 - stage	16 - stage	16 - stage	16 - stage
Internal Oscillator (Hz)	8M	8M	8M	8M	1.73k / 25k / 2M	25k / 2M	25k / 2M	25k / 2M
Max. Counters/Delays	–	–	1 / 4	1 / 4	5	5	5	5
Combination Function Macro-cells	–	–	8	7	4	15	15	15
State Machine	Power Sequencer	Power Sequencer	Power Sequencer	–	8-state ASM	8-state ASM	8-state ASM	8-state ASM
Flexible Timing & Event-Triggered Sequencer	Yes	Yes	Yes	Yes	Yes	Yes	Yes	Yes
Power Parameters								
# LDOs	7	6	8	3	4	2	2	4
V _{IN} total range	0.8V - 5.0V	0.8V - 5.0V	0.8V - 5.0V	0.8V - 5.0V	2.3V - 5.5V	2.3V - 5.5V	2.3V - 5.5V	2.5V - 5.5V
V _{OUT} total range	0.5V - 3.75V	0.5V - 3.75V	0.5V - 3.75V	0.5V - 3.75V	0.9V to 4.35V	0.9V to 4.35V	0.9V to 4.35V	0.9V to 4.2V
Output Current Max (A)	0.8	1	1.3	0.8	0.15	0.3	0.6	0.15
Max I _{out_LDO1} (mA)	475 (High PSRR)	475 (High PSRR)	500	475 (High PSRR)	150	300	600	150
Max I _{out_LDO2} (mA)	475 (High PSRR)	500	500	500	150	300	–	150
Max I _{out_LDO3} (mA)	500	500	500	800	150	–	–	150
Max I _{out_LDO4} (mA)	500	500	500	–	150	–	–	150
Max I _{out_LDO5} (mA)	800	500	500	–	–	–	–	–
Max I _{out_LDO6} (mA)	800	1000	1 A	–	–	–	–	–
Max I _{out_LDO7} (mA)	500	–	1 A	–	–	–	–	–
Max I _{out_LDO8} (mA)	–	–	1.3 A	–	–	–	–	–
# of Load Switches	2	1	5	1	R	2	1	1
V _{dropout}	80mV @ 0.8A (LV LDO)	100mV @ 1A (LV LDO)	130mV @ 1.3A (LV LDO)	100mV @ 0.8A (LV LDO)	250mV	250mV	250mV	250mV
PSRR	87dB @ 100kHz (HP LDO)	87dB @ 100kHz (HP LDO)	65dB @ 100kHz (HV LDO)	87dB @ 100kHz (HP LDO)	50dB @ 100Hz to 100kHz	50dB @ 100Hz to 100kHz	50dB @ 100Hz to 100kHz	50dB @ 100Hz to 100kHz
Output Noise	13μV @ 10Hz to 100kHz (HP LDO)	13μV @ 10Hz to 100kHz (HP LDO)	152μV @ 10Hz to 100kHz (HV LDO)	18μV @ 10Hz to 100kHz (HP LDO)	75μV @ 10Hz to 100kHz	75μV @ 10Hz to 100kHz	75μV @ 10Hz to 100kHz	75μV @ 10Hz to 100kHz
Current limit	Startup & Functional (Programmable)	Startup & Functional (Programmable)	Startup & Functional (Programmable)	Startup & Functional (Programmable)	Over-current & Short-Circuit Detection Current Limit	Over-current & Short-Circuit Detection Current Limit	Over-current & Short-Circuit Detection Current Limit	Over-current & Short-Circuit Detection Current Limit
Protection Features	ESD, OCL, OTP, UVLO	ESD, OCL, OTP, UVLO	ESD, OCL, OTP, UVLO	ESD, OCL, OTP, UVLO	ESD, OCL, SCD, OTP, Read Lock	ESD, OCL, SCD, OTP, Read Lock	ESD, OCL, SCD, OTP, Read Lock	ESD, OCL, SCD, OTP, Read Lock

Recommended Products: Gate Driver, MOSFET, Peripheral IC

Power GreenPAK™

User-programmable ASICs (Also available programmed at the factory.)

Power GreenPAK™ with Load Switches

Item	SLG51000	SLG51001	SLG51002	SLG51003	SLG46116/7	SLG46127	SLG46517	SLG46867
General Parameters								
Memory Type	OTP	OTP	OTP	OTP	OTP	OTP	OTP	OTP
# of Pins / # of GPIOs	20 / 6	16 / 4	25 / 6	14 / 5	14 / 7	16 / 6	28 / 16	20 / 12
Operating Voltage (V)	2.8 - 5.0	2.8 - 5.0	2.8 - 5.0	2.8 - 5.0	1.71 - 5.5	1.71 - 5.5	1.71 - 5.5	2.3 - 5.5
Communication Interface Type	I ² C	I ² C	I ² C	I ² C	–	–	I ² C	I ² C
Communication Interface Voltage	1.2V - 1.8V	1.2V - 1.8V	1.2V - 1.8V	1.2V - 5.0V	–	–	1.2V - 5.0V	1.2V - 5.0V
GPIO Voltage	1.2V - 1.8V	1.2V - 1.8V	1.2V - 5.0V	1.2V - 5.0V	1.71 - 5.5 V	1.2V - 5.0V	1.2V - 5.0V	1.2V - 5.0V
Package Type	WLCSP	WLCSP	WLCSP	TQFN	TQFN	TQFN	TQFN	TQFN
Package Size (mm)	1.675 x 2.075 x 0.465, 0.4 pitch	1.675 x 1.675 x 0.465, 0.4 pitch	1.992 x 1.992 x 0.44, 0.35 pitch	2.0 x 2.2 x 0.55, 0.4 pitch	1.6 x 2.5 x 0.55, 0.4 pitch	1.6 x 2.0 x 0.55, 0.4 pitch	2.0 x 3.0 x 0.55, 0.4 pitch	1.6 x 3.0 x 0.4, 0.4 pitch
Operating temperature (°C)	-40 to +85	-40 to +85	-40 to +85	-40 to +85	-40 to +85	-40 to +85	-40 to +85	-40 to +85
Combinatorial Logic								
Analog Comparators	–	–	–	–	2	2	4	4
Max. Look Up Tables (LUTs) / DFF	12 / –	12 / –	8 / 8	8 / 8	10 / 4	10 / 4	17 / 8	23 / 21
Pipe Delay	–	–	–	–	8-stage	8-stage	16-stage	16-stage
Internal Oscillator (Hz)	8M	8M	8M	8M	25k / 2M	25k / 2M	25k / 2M / 25M	25k / 2M / 25M
Max. Counters/Delays	–	–	1 / 4	1 / 4	4	4	7	8
Combination Function Macro-cells	–	–	7	7	6	6	17	15
State Machine	Power Sequencer	Power Sequencer	Power Sequencer	–	–	–	8-state ASM	–
Power Parameters								
# of Load Switches	2	1	5	1	1 Total	2 Total	2 Total	2 x PFET
Load Switch Type (PMOS / NMOS)	2 x NMOS	1 x NMOS	3 x NMOS, 2 x PMOS	1 x NMOS	1 x PMOS	2 x PMOS	2 x PMOS	2 x PMOS
Max Iout	0.8A	1A	1.3A	0.8A	1.25A	2A	2A	2A
RON	40mΩ	40mΩ	40mΩ	40mΩ	28.5mΩ	44mΩ	44mΩ	44mΩ
Programmable Current Limit	Yes	Yes	Yes	Yes	–	–	–	–
Slew Rate	Yes	Yes	Yes	Yes	Fixed	–	–	–
# of LDOs	7	6	8	3	–	–	–	–
Protection Features	ESD, OCP, OTP, UVLO	ESD, OCP, OTP, UVLO	ESD, OCP, OTP, UVLO	ESD, OCP, OTP, UVLO	ESD, Read Lock	ESD, Read Lock	ESD, Read Lock	ESD, Read Lock
Discharge Resistance	Fixed	Fixed	Programmable	Programmable	W/O Fixed	–	–	–

High-Voltage GreenFET Load Switch

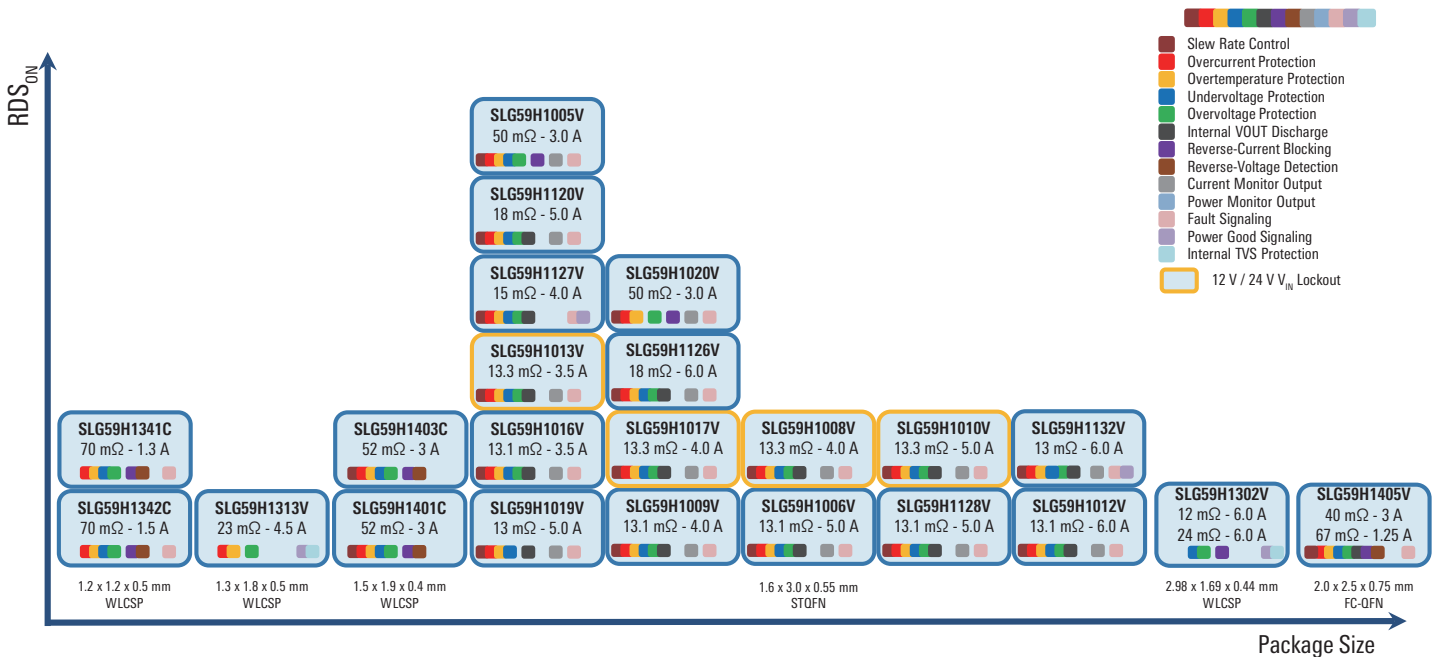

Recommended Products: Gate Driver, MOSFET, Peripheral IC

Single-Channel GreenFET Load Switch

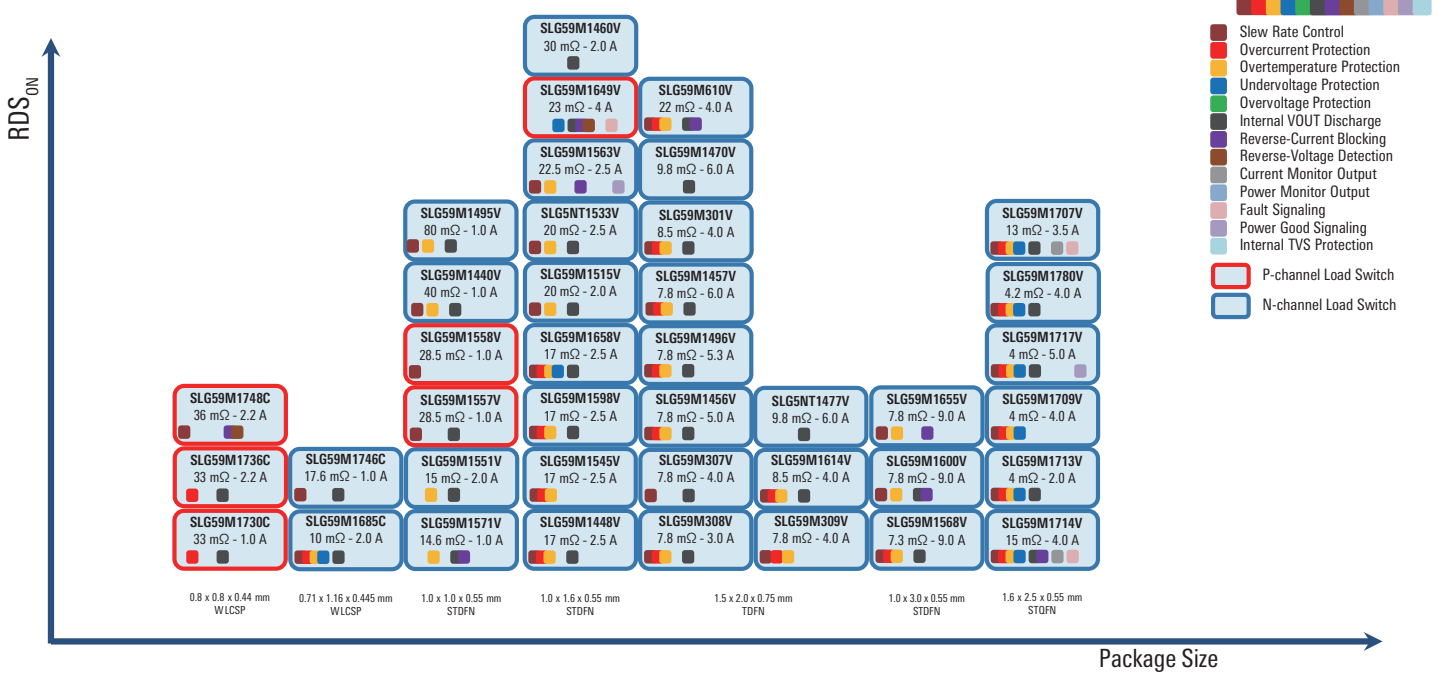

Dual-Channel GreenFET Load Switch

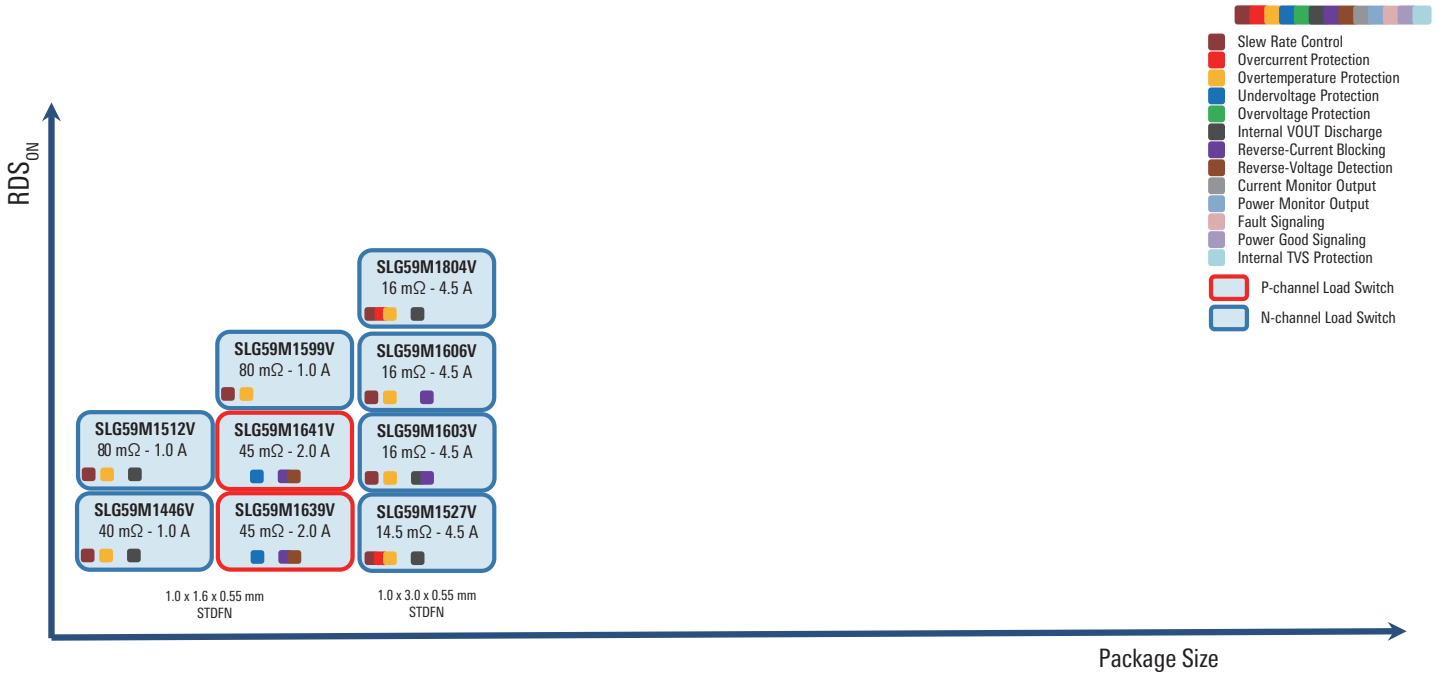

Recommended Products: Gate Driver, MOSFET, Peripheral IC

Gate Driver: 3-Phase Product Family

Part No.	Description	Maximum Boot Strap Voltage (V)	Maximum Bias Voltage (V)	Input Lines/ Output Lines	Peak Pull-Up/ Pull-Down Current (A)	Turn On/Off Propagation Delay (nS)	Rise/Fall Time (nS)	Input Logic	Package	Remarks
RAA227063	60V smart 3-phase gate driver	74	14	6/6	1/2	40/40	Programmable drive control	TTL (VIL / VIH 1.21 / 1.57)	QFN-48	Buck Boost 500mA LDO (5V or 3.3V) 200mA
RAA306012	65V smart 3-phase gate driver	78	17	6/6	0.64/1.28	40/40	Programmable drive control	TTL (VIL / VIH 1.21 / 1.57)	QFN-48	Buck Boost 500mA LDO (5V or 3.3V) 100mA
HIP4083	80V, 300mA peak, for 3-phase	95	15	3/3	0.24/0.3	60/65	35/30	TTL/CMOS	SOC-16P DIP-16	Integrated output level shift circuit
HIP4086/A	80V, 500mA peak, for 3-phase	95	15	6/6	0.5	45/30	20/10	TTL/CMOS	SOC-24 PDIP-24	Part No. without A: Integrated charge pump.

Gate Driver: Full-Bridge Product Family

Part No.	Description	Maximum Boot Strap Voltage (V)	Maximum Bias Voltage (V)	Input Lines/ Output Lines	Peak Pull-Up/ Pull-Down Current (A)	Turn On/Off Propagation Delay (nS)	Rise/Fall Time (nS)	Input Logic	Package	
									PDIP	SOIC
HIP4080A	80V, 2.5A peak, high-frequency dead time control, built-in input comparator	95	15	1/4	2.6/2.4	40/50	10/10	Logic Thresholds Compatible with 5V to 15V Logic level	20-pin	20-pin
HIP4081A	80V, 2.5A peak, high-frequency dead time control	95	15	4/4	2.6/2.4	35/45	10/10	Logic Thresholds Compatible with 5V to 15V Logic level	20-pin	20-pin
ISL83202	55V, 1A peak	70	15	4/4	1/1	75/55	9/9	Logic Thresholds Compatible with 5V to 15V Logic level	16-pin	16-pin

Gate Driver: Half-Bridge Product Family

Part No.	Maximum Boot Strap Voltage (V)	Maximum Bias Voltage (V)	Input Lines/ Output Lines	Peak Pull-Up/ Pull-Down Current (A)	Turn On/Off Propagation Delay (nS)	Rise/Fall Time (nS)	Input Logic	Package	Remarks
HIP2210	115	18	1/2	3/4	30/30	20/20	Tri state	10-TDFN	Tri-state, adjustable input threshold, adjustable dead time
HIP2211	115	18	2/2	3/4	15/15	20/20	CMOS	8-SOIC, 10-TDFN, 8-DFN	-
HIP2100	114	14	2/2	2/2	20/20	10/10	CMOS	8-EPSOIC, 8-SOIC, 16-QFN	-
HIP2101	114	14	2/2	2/2	25/25	10/10	TTL/CMOS	8-EPSOIC, 8-SOIC 16-QFN, 12-DFN	-
ISL2100A	114	14	2/2	2/2	39/31	10/10	CMOS	8-SOIC, 9-DFN	Equivalent to HIP2100 with input hysteresis added.
ISL2101A	114	14	2/2	2/2	39/31	10/10	TTL	8-SOIC, 9-DFN	Equivalent to HIP2101, but with ability to swing input up to the bias voltage
ISL2110A	114	14	2/2	3/4	38/32	9/7.5	CMOS	8-SOIC, 12-DFN	-
ISL2111A/B	114	14	2/2	3/4	38/32	9/7.5	TTL	8-SOIC, 10-TDFN 12-DFN, 8-DFN	-
HIP2103	66	16	2/2	1/2	28/30	20/17	CMOS	8-DFN	-
HIP2104	66	-	2/2	1/2	23/27	21/17	CMOS	12-DFN	VBAT = 60V, 75mA, built-in LDO

Other Drivers and Detectors

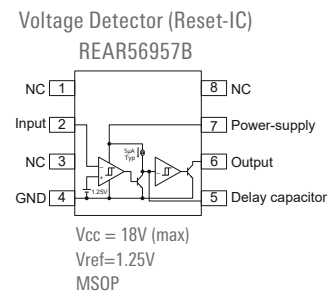
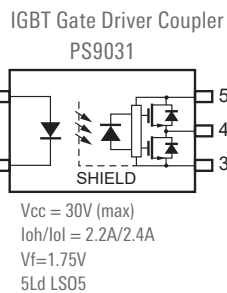
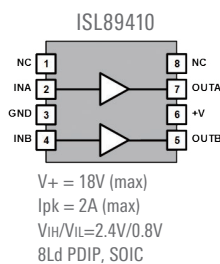
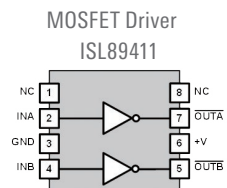

Recommended Products: Gate Driver, MOSFET, Peripheral IC

Gate Driver: Low-Side Product Family

Part No.	V _{in} (max) (V)	Input Lines/ Output Lines	Peak Current (A)	Turn On/Off Propagation Delay (nS)	Rise/Fall Time (nS)	Input Logic	Package	Remarks
ISL89163	16	2/2	6	25/25	25/25	TTL/CMOS	8-EPSOIC, 8-TDFN	Non-inverting/non-inverting driver
ISL89164	16	2/2	6	25/25	25/25	TTL/CMOS	8-EPSOIC, 8-TDFN	Inverting/inverting driver
ISL89165	16	2/2	6	25/25	25/25	TTL/CMOS	8-EPSOIC, 8-TDFN	Inverting/non-inverting driver
ISL89410	18	2/2	4	18/20	10/13	CMOS	8-PDIP, 8-SOIC	Non-inverting/non-inverting driver High-voltage-tolerance version of EL7202
ISL89411	18	2/2	4	18/20	10/13	CMOS	8-PDIP, 8-SOIC	Inverting/inverting driver High-voltage-tolerance version of EL7212
ISL89412	18	2/2	4	18/20	10/13	CMOS	8-PDIP, 8-SOIC	Inverting/non-inverting driver High-voltage-tolerance version of EL7222
RAA226110	18	1/1	0.3/0.75/2	20/20	2/2	–	16-QFN	For GaN FETs

Power MOSFETs

Part No.	Nch/Pch	Resisting Pressure	Current	ON Resistance (max)	Package
RJK2075DPA	Nch Single	200V	20A	69mΩ	WPAK
RJK2076DPA	Nch Single	200V	20A	85mΩ	WPAK
RJK1054DPB	Nch Single	100V	20A	22mΩ	LFPAK
RJK0854DPB	Nch Single	80V	25A	13mΩ	LFPAK
UPA3753GR	Nch Dual	60V	5A	72mΩ	SOP-8
RJK0454DPB	Nch Single	40V	40A	4.9mΩ	LFPAK
RJK0455DPB	Nch Single	40V	45A	3.8mΩ	LFPAK
RJK0456DPB	Nch Single	40V	50A	3.2mΩ	LFPAK
RJK0349DSP-01	Nch Single	30V	20A	5.0mΩ	SOP-8
UPA2736GR	Pch Single	-30V	-14A	13.5mΩ	SOP-8
UPA2814T1S	Pch Single	-30V	-24A	14.5mΩ	HWSON-8

Peripheral IC: RS-485 Transceiver

Device	Duplex	VCC (V)	Data Rate (Mbps)	Fail-Safe	Fractional Unit Load	Tx V _{oo} (V)	Tx Out / Rx In			Hot Plug	Temp (°C)	Package
							HBM	IEC61000-4-2 ESD Contact	IEC61000-4-4 EFT			
ISL3159E	Half	4.5 to 5.5	40	Open, Short, Idle	160	Min. 2.1	±16.5kV	±8kV	Y	-40 to 85 -40 to 125	8L SOIC/MSOP 10L DFN	
ISL3179E		3.0 to 3.6				Min. 1.5	±16.5kV	±9kV				
ISL3160E	4.5 to 5.5	Min. 2.1				±10kV	±5kV	-40 to 125				
ISL3180E	3.0 to 3.6	Min. 1.5				±12kV	±5kV					-40 to 85
RAA788152 / 55 / 58	Half	4.5 to 5.5	0.115 / 1 / 20	Open, Short, Idle	256	Min. 2.4	±16.5kV	±9kV	Y	-40 to 85	8L SOIC/MSOP 10L MSOP 14L SOIC	
RAA788172 / 75 / 78		3.0 to 3.6	0.25 / 0.5 / 20			Min. 1.5	±15kV	±8kV				±3kV
RAA788150 / 53 / 56	Full	4.5 to 5.5	0.115 / 1 / 20			Min. 2.4	±16.5kV	±9kV				±5kV
RAA788170 / 72 / 76		3.0 to 3.6	0.25 / 0.5 / 20			Min. 1.5	±15kV	±8kV				±3kV

Device	Duplex	VCC (V)	Data Rate (Mbps)	Fail-Safe	Devices on Bus	Wide VCM (V)	Protection Tx Out/Rx In	Hot Plug	Temp (°C)	Package
ISL32452E/55E/58E	Half	3.0 to 5.5	0.25 / 1 / 20	Open, Short, Idle	128	±20	±60V Fault Protected ±15k or 16.5kV HBM ESD	N	-40 to 85	8L SOIC / 8L MSOP
ISL32457E			0.25 / 20							8L SOIC
ISL32459E			0.25 / 1 / 15							10L MSOP / 14L SOIC
ISL32496E	Full	4.5 to 5.5	0.25 / 1 / 15							±25

Winning Combinations

36V/144W BLDC Motor Controller

This design features a 32-bit MCU optimized for field-oriented control (FOC) of a single BLDC motor. The MCU includes a best-in-class floating point unit (FPU) and built-in peripherals for motor control, allowing for a compact and cost-effective motor controller. The system is powered off a standard 24VDC input and receives precise position feedback from an inductive position sensor.

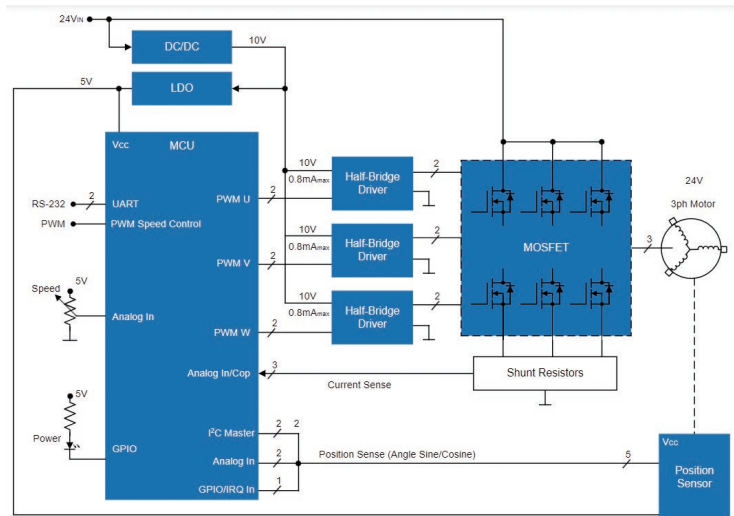

EU068

BLDC Traction Motor Drive

The combination of a high-performance MCU and a 3-phase smart driver delivers optimal processing speed and power efficiency, catering to traction motors with small form factor limitations and varied power requirements. The integrated power management allows the driver and MCU to be powered directly from the battery, reducing overall circuitry. Programmability enables customers to optimize the inverter power stage for different power levels by adjusting MOSFETs and tuning slew rate, dead time, and gate drive via software. By using two inductive position sensors, customers can replace large, costly optical encoders. These sensors provide absolute position information and incremental position sensing with up to 17 bits of resolution, utilizing the MCU's advanced ADC capabilities.

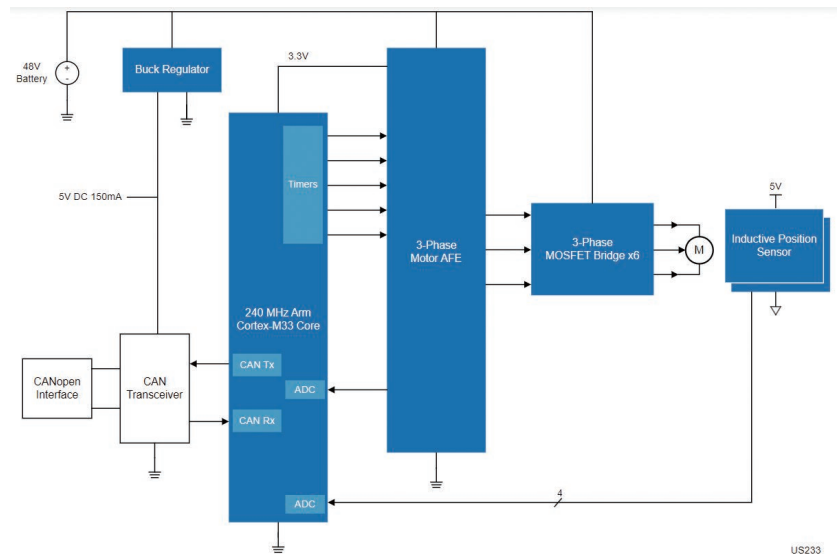

US233

High Power, Compact BLDC Motor Control

The smart gate driver IC is designed for 3-phase sensorless Brushless DC (BLDC) motor applications. It integrates three half-bridge smart gate drivers capable of powering N-channel MOSFET bridges with voltages ranging from 4.5V to a maximum of 60V, featuring 1A drive and 2A sinking current capability. This setup enables control of high-current GaN MOSFETs. The IC includes a buck-boost converter to supply power to the MCU and incorporates three differential amplifiers with adjustable gain for precise ground-side shunt current sensing, feeding data to the MCU's ADC input. The MCU enhances data communication through CAN FD and I3C protocols for motor control, supporting calculation-intensive algorithms for smoother motor tuning. The use of GaN high voltage MOSFETs allows for high current switching without bulky heatsinks, optimizing the system for compact, high-efficiency applications.

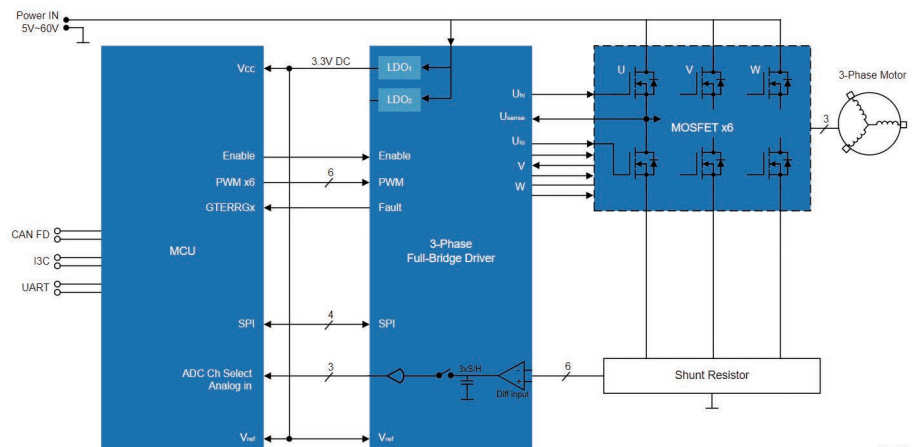

EU105

Winning Combinations

Motor Control with Resolver

In this design, Renesas provides a stepping motor solution with resolver position control and an alternate BLDC motor solution. The stepping motor solution realizes a high-performance motor drive unit for office automation and industrial applications such as scanners, multi-function printers and automated cash deposit machines. While the BLDC motor solution realizes a high-performance motor drive unit for Automatic Guided Vehicle (AGV), small vehicle, service robot, and assisted bicycle applications.

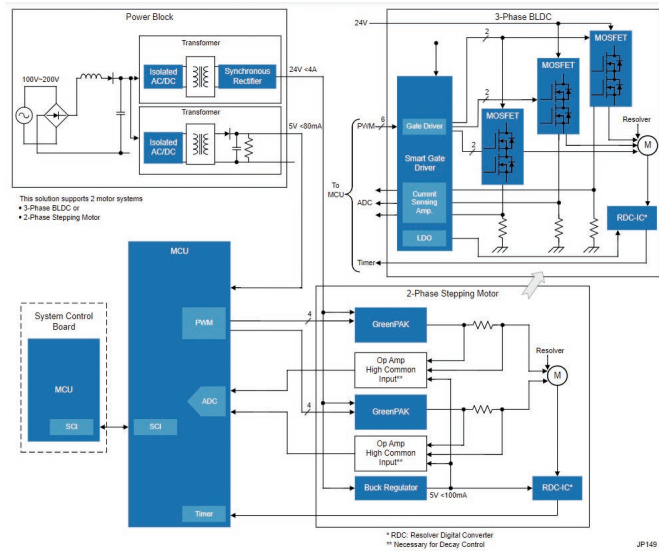

Motor Control System with Industrial Network and Functional Safety

Renesas provides a comprehensive system for industrial motor control, integrating an MPU and MCU for mutual monitoring, along with power supply ICs, delta-sigma ($\Delta\Sigma$) modulators, and other essential devices. This combination of components enables a streamlined and high-performance approach to motor control, industrial networking, and functional safety, ensuring efficient and reliable operations in industrial environments.

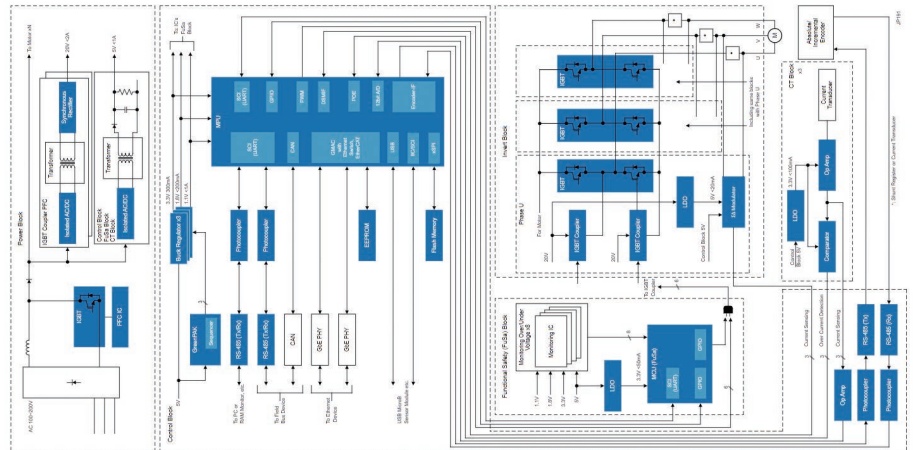

AC Drive & General Purpose Inverter System

This system provides a basic configuration and essential components for AC drives and general purpose (GP) inverters, serving as a variable-speed controller to precisely regulate shaft rotation speed in induction and synchronous motors. It is widely used in industrial machinery such as conveyors, cranes, elevators, fans, pumps, and compressors. Due to its versatile application scenarios, the system supports multiple optional functions to meet diverse industrial requirements, ensuring adaptability and efficiency in various settings.

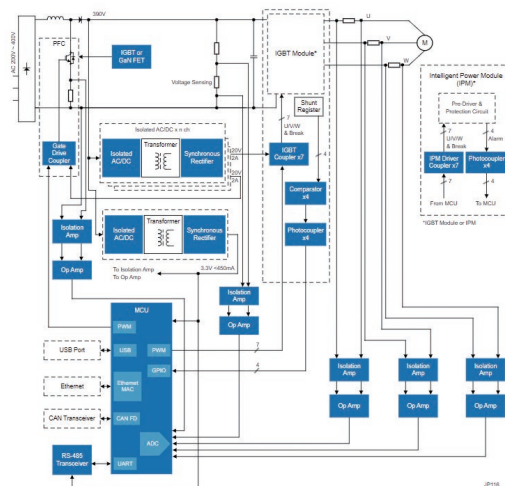

Winning Combinations

Absolute Inductive Position Sensor

This simple and cost-effective design utilizes off-the-shelf components like a standard PCB, a Renesas' position sensor, passive components, and a metal piece as a target. The sensing element consists of a set of coils on the PCB rather than inside the Renesas IC, allowing the sensor system to be tailored to specific customer applications. This flexibility enables the sensor system to be customized to the customer's needs. It uses dual inductive position sensors (IPS) for absolute position detection, optimizes coil size, and aligns with market trends such as 35mm motors.

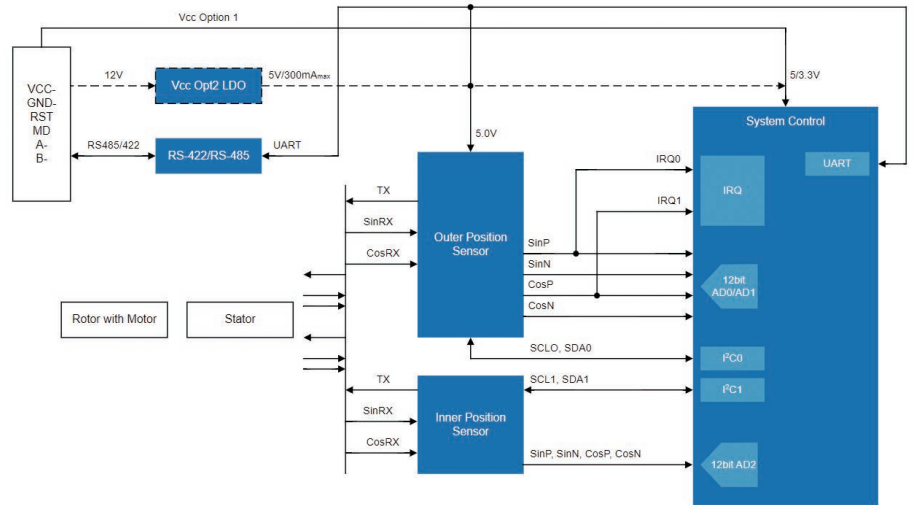

CN317

AC Servo

This Renesas AC servo solution integrates motor control and EtherCAT design to support high-speed and high-precision motor control through synchronizing time-sensitive industrial Ethernet communications. This solution is composed of three blocks: system control, power drive and motor encoder, which are physically isolated while maintaining a high degree of interconnect. By utilizing the high-performance RZ/T2L, RZ/T2M or RZ/N2L microprocessor, this monolithic solution outperforms traditional two-chip platforms on performance and cost.

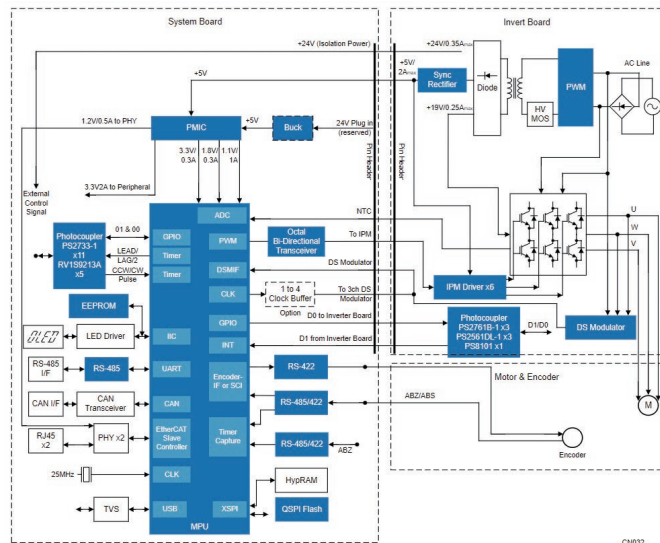

CN032

240V AC-Input BLDC Motor Controller

This design features an MCU optimized for single motor field-oriented control (FOC) of a BLDC motor. The MCU has a best-in-class built-in floating point unit (FPU) and various peripheral functions, allowing for a compact, low BOM cost motor controller board. This design is intended for an un-isolated environment where the user cannot make direct contact with the controller. The system offers remote control via an ultra-low power Wi-Fi + Bluetooth® Low Energy (LE) module, providing flexibility and advanced connectivity for modern industrial applications.

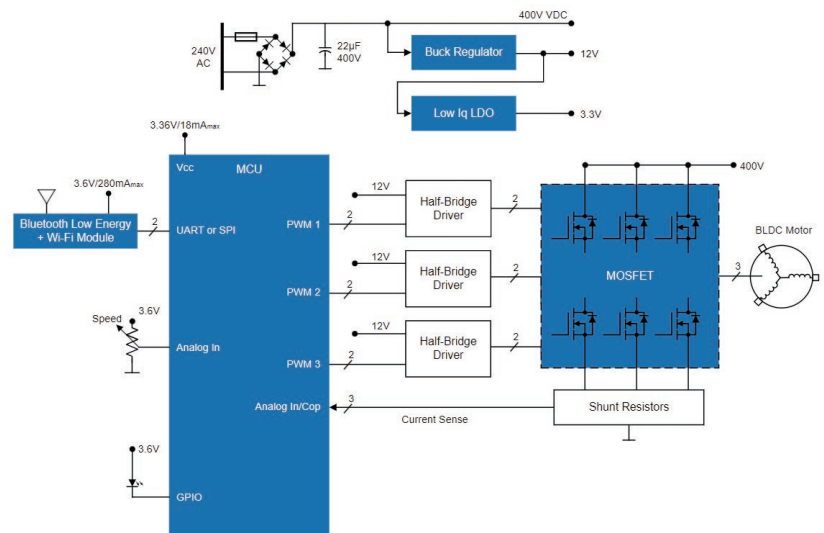

EU094

Winning Combinations

3-Phase RISC-V Motor Controller

This simplified 3-phase motor control system features a cost-optimized RISC-V 32MHz 32-bit ASSP, with rich analog IP and support for temperatures up to 125°C. The ASSP is a pre-programmed motor control solution, allowing users to store specific motor characteristics in device flash via a GUI interface. Additional input channels accommodate signals from a motor position encoder and Hall sensors. A Pmod™ interface with I²C and serial ports enables connection to external environmental sensors or wireless connectivity modules.

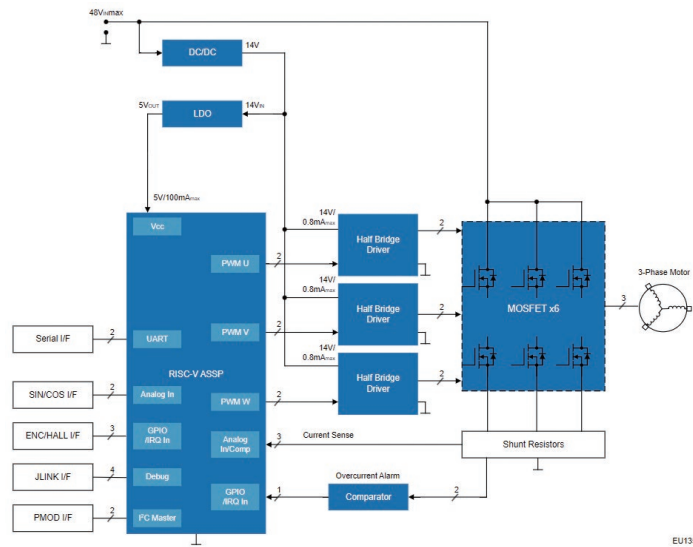

EU135

Servo Motor Control for Robot Limbs

This system enables motor control for angular motion with adequate torque and speed. It also monitors the status of multiple motors via 1-wire through UART from the host MCU, which allows users to reduce the harness in a system and to control robot limbs such as for service robots, manipulators and Automatic Guided Vehicles (AGV). The SLG47115 HVPAK™ programmable mixed-signal matrix has high-voltage H-bridge functionality in a tiny 2mm x 3mm QFN package which contributes to minimizing the size of the servo motor.

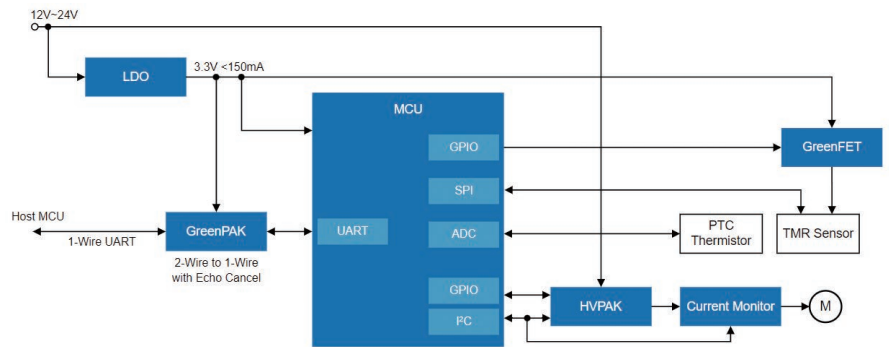

JF200

DC Motor Driver Pmod

This implementation of the HVPAK™ programmable mixed-signal matrix over Pmod™ provides flexibility for users to control and configure the HVPAK motor drive using any MCU/MPU. There are multiple protection sections implemented to use it as a standalone motor drive as well. The motors, the DC motor with direction and speed control as well as the stepper motor with micro-steps are easily configurable. This will reduce the development and turnaround time of any customer.

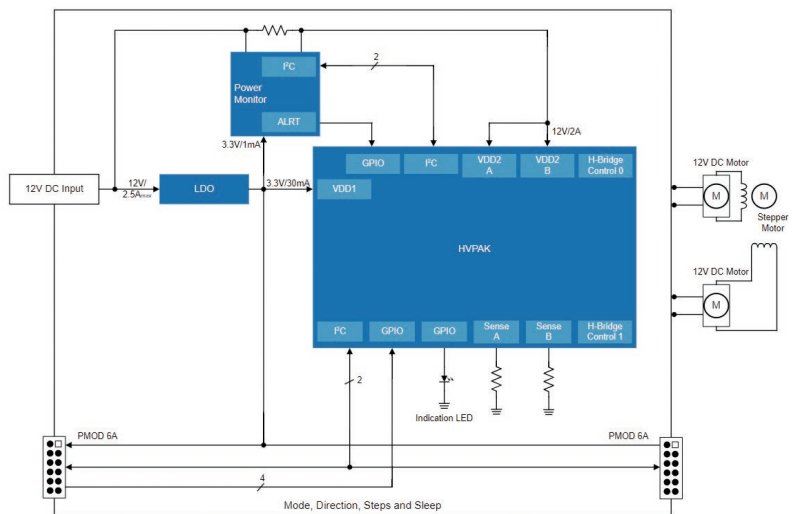

AS025

Renesas Electronics Corporation TOYOSU FORESIA, 3-2-24 Toyosu, Koto-ku, Tokyo 135-0061, Japan

Notice

1. Descriptions of circuits, software and other related information in this document are provided only to illustrate the operation of semiconductor products and application examples. You are fully responsible for the incorporation or any other use of the circuits, software, and information in the design of your product or system. Renesas Electronics disclaims any and all liability for any losses and damages incurred by you or third parties arising from the use of these circuits, software, or information.
 2. Renesas Electronics hereby expressly disclaims any warranties against and liability for infringement or any other claims involving patents, copyrights, or other intellectual property rights of third parties, by or arising from the use of Renesas Electronics products or technical information described in this document, including but not limited to, the product data, drawings, charts, programs, algorithms, and application examples.
 3. No license, express, implied or otherwise, is granted hereby under any patents, copyrights or other intellectual property rights of Renesas Electronics or others.
 4. You shall be responsible for determining what licenses are required from any third parties, and obtaining such licenses for the lawful import, export, manufacture, sales, utilization, distribution or other disposal of any products incorporating Renesas Electronics products, if required.
 5. You shall not alter, modify, copy, or reverse engineer any Renesas Electronics product, whether in whole or in part. Renesas Electronics disclaims any and all liability for any losses or damages incurred by you or third parties arising from such alteration, modification, copying or reverse engineering.
 6. Renesas Electronics products are classified according to the following two quality grades: "Standard" and "High Quality". The intended applications for each Renesas Electronics product depends on the product's quality grade, as indicated below.
 "Standard": Computers; office equipment; communications equipment; test and measurement equipment; audio and visual equipment; home electronic appliances; machine tools; personal electronic equipment; industrial robots; etc.
 "High Quality": Transportation equipment (automobiles, trains, ships, etc.); traffic control (traffic lights); large-scale communication equipment; key financial terminal systems; safety control equipment, etc.
 Unless expressly designated as a high reliability product or a product for harsh environments in a Renesas Electronics data sheet or other Renesas Electronics document, Renesas Electronics products are not intended or authorized for use in products or systems that may pose a direct threat to human life or bodily injury (artificial life support devices or systems; surgical implantations; etc.), or may cause serious property damage (space system; undersea repeaters; nuclear power control systems; aircraft control systems; key plant systems; military equipment, etc.). Renesas Electronics disclaims any and all liability for any damages or losses incurred by you or any third parties arising from the use of any Renesas Electronics product that is inconsistent with any Renesas Electronics data sheet, user's manual or other Renesas Electronics document.
 7. No semiconductor product is absolutely secure. Notwithstanding any security measures or features that may be implemented in Renesas Electronics hardware or software products, RENESAS ELECTRONICS SHALL HAVE ABSOLUTELY NO LIABILITY ARISING OUT OF ANY VULNERABILITY OR SECURITY BREACH, INCLUDING BUT NOT LIMITED TO ANY UNAUTHORIZED ACCESS TO OR USE OF A RENESAS ELECTRONICS PRODUCT OR A SYSTEM THAT USES A RENESAS ELECTRONICS PRODUCT. RENESAS ELECTRONICS DOES NOT WARRANT OR GUARANTEE THAT RENESAS ELECTRONICS PRODUCTS, OR ANY SYSTEMS CREATED USING RENESAS ELECTRONICS PRODUCTS WILL BE INVULNERABLE OR FREE FROM CORRUPTION, ATTACK, VIRUSES, INTERFERENCE, HACKING, DATA LOSS OR THEFT, OR OTHER SECURITY INTRUSION ("Vulnerability Issues"). RENESAS ELECTRONICS DISCLAIMS ANY AND ALL RESPONSIBILITY OR LIABILITY ARISING FROM OR RELATED TO ANY VULNERABILITY ISSUES. FURTHERMORE, TO THE EXTENT PERMITTED BY APPLICABLE LAW, RENESAS ELECTRONICS DISCLAIMS ANY AND ALL WARRANTIES, EXPRESS OR IMPLIED, WITH RESPECT TO THIS DOCUMENT AND ANY RELATED OR ACCOMPANYING SOFTWARE OR HARDWARE, INCLUDING BUT NOT LIMITED TO THE IMPLIED WARRANTIES OF MERCHANTABILITY, OR FITNESS FOR A PARTICULAR PURPOSE.
 8. When using Renesas Electronics products, refer to the latest product information (data sheets, user's manuals, application notes, "General Notes for Handling and Using Semiconductor Devices" in the reliability handbook, etc.), and ensure that usage conditions are within the ranges specified by Renesas Electronics with respect to maximum ratings, operating power supply voltage range, heat dissipation characteristics, installation, etc. Renesas Electronics disclaims any and all liability for any malfunctions, failure or accident arising out of the use of Renesas Electronics products outside of such specified ranges.
 9. Although Renesas Electronics endeavors to improve the quality and reliability of Renesas Electronics products, semiconductor products have specific characteristics, such as the occurrence of failure at a certain rate and malfunctions under certain use conditions. Unless designated as a high reliability product or a product for harsh environments in a Renesas Electronics data sheet or other Renesas Electronics document, Renesas Electronics products are not subject to radiation resistance design. You are responsible for implementing safety measures to guard against the possibility of bodily injury, injury or damage caused by fire, and/or danger to the public in the event of a failure or malfunction of Renesas Electronics products, such as safety design for hardware and software, including but not limited to redundancy, fire control and malfunction prevention, appropriate treatment for aging degradation or any other appropriate measures. Because the evaluation of microcomputer software alone is very difficult and impractical, you are responsible for evaluating the safety of the final products or systems manufactured by you.
 10. Please contact a Renesas Electronics sales office for details as to environmental matters such as the environmental compatibility of each Renesas Electronics product. You are responsible for carefully and sufficiently investigating applicable laws and regulations that regulate the inclusion or use of controlled substances, including without limitation, the EU RoHS Directive, and using Renesas Electronics products in compliance with all these applicable laws and regulations. Renesas Electronics disclaims any and all liability for damages or losses occurring as a result of your noncompliance with applicable laws and regulations.
 11. Renesas Electronics products and technologies shall not be used for or incorporated into any products or systems whose manufacture, use, or sale is prohibited under any applicable domestic or foreign laws or regulations. You shall comply with any applicable export control laws and regulations promulgated and administered by the governments of any countries asserting jurisdiction over the parties or transactions.
 12. It is the responsibility of the buyer or distributor of Renesas Electronics products, or any other party who distributes, disposes of, or otherwise sells or transfers the product to a third party, to notify such third party in advance of the contents and conditions set forth in this document.
 13. This document shall not be reprinted, reproduced or duplicated in any form, in whole or in part, without prior written consent of Renesas Electronics.
 14. Please contact a Renesas Electronics sales office if you have any questions regarding the information contained in this document or Renesas Electronics products.
- (Note 1) "Renesas Electronics" as used in this document means Renesas Electronics Corporation and also includes its directly or indirectly controlled subsidiaries.
 (Note 2) "Renesas Electronics product(s)" means any product developed or manufactured by or for Renesas Electronics.

(Rev.5.0-1 2020.10)

Contact Us

<https://www.renesas.com/contact-us>



Renesas Electronics Corporation

www.renesas.com