

RENESAS RL78 FAMILY MICROCONTROLLERS

The True Low Power Microcontroller Platform



RL78 – TRUE LOW POWER MICROCONTROLLER FAMILY

It enables customers to build compact and energy-efficient systems at lower cost.

The Renesas RL78 contributes to greatly improve power efficiency, BOM cost reduction, and equipment miniaturization with industry-leading low power consumption and various built-in high-performance peripheral functions.

Comprehensive Development Tools

- Improve development efficiency with code generation tool/integrated development environment
- Support for powerful tools from Renesas partners
- Open source (compiler/IDE) environment are available
- Immediately realize Rapid Prototyping in Arduino compatible environment

Low Power Consumption

- 37.5 μ A/MHz operation*¹
 - 0.355 μ A (RTC + LVD)
 - SNOOZE mode
- Note: 1. Power supply current value during basic RL78/G22 operation

Broad Scalability

- 8 to 144 pins/1 to 768 KB
- Extensive product lineup to meet a broad range of requirements
- Pin compatibility
- Ability to reassign peripheral function pins

Reliable Safety Functions

- Memory with ECC
- Compliant with Safety Standard for Household Appliances (IEC 60730)
- Support for high operating temperatures (up to 150°C)
- Abnormal operation detection/avoidance function
- True Random Number Generator (TRNG)

Reduced System Cost

- High precision \pm 1% high-speed on-chip oscillator
- On-chip power-on reset, low-voltage detection circuit, temperature sensor, data flash memory, etc.
- Built-in logic function (ELCL), AMP, DAC, comparator (some products)

High Performance

- High processing performance of 1.6 DMIPS/MHz
- Support for power supply voltages from 1.6 to 5.5 V
- Max. 48 MHz operation

* Specifications vary depending on the application. Please refer to each product page for details.

RL: Renesas Low power

RL78 FAMILY PORTFOLIO

General Purpose								
Standard	RL78/G22 Touch, Small ROM PIN: 16-48 pins ROM: 32-264 KB	RL78/G23 New standard PIN: 30-128 pins ROM: 64-768 KB						
	RL78/G12 Small Package PIN: 20-30 pins ROM: 2-16 KB	RL78/G13 Standard PIN: 20-128 pins ROM: 16-512 KB	RL78/G13A Standard PIN: 44-100 pins ROM: 384-512 KB	RL78/G1A 12-bit A/D PIN: 25-64 pins ROM: 16-64 KB	RL78/G1P 12-bit A/D, 10-bit D/A PIN: 24-32 pins ROM: 16 KB			
	RL78/G10 Low Pin Count PIN: 10-16 pins ROM: 1-4 KB	RL78/G11 CMP, PGA PIN: 10-25 pins ROM: 16 KB	RL78/G15 Low Pin Count PIN: 8-20 pins ROM: 4-8 KB	RL78/G16 Touch, Low Pin Count PIN: 10-32 pins ROM: 16-32 KB	RL78/G1N High Current Out PIN: 20 pins ROM: 4-8 KB	For Small Systems		
Communications	RL78/G1C USB PIN: 32-48 pins ROM: 32 KB	RL78/G1D Bluetooth LE PIN: 48 pins ROM: 128-256 KB	RL78/G1H Sub-GHz PIN: 64 pins ROM: 256-512 KB	For Wireless Solutions				
Motor	RL78/G14 Enhanced timer PIN: 30-100 pins ROM: 16-512 KB	RL78/G1F BLDC Motor PIN: 24-64 pins ROM: 32-64 KB	RL78/G1G Small Motor PIN: 30-44 pins ROM: 8-16 KB	RL78/G1M Realtime Output PIN: 20 pins ROM: 4-8 KB	RL78/G24 High Performance PIN: 20-64 pins ROM: 64-128 KB			
LCD			ASSP					
Standard	RL78/L12 Small Package Up to 35 seg x 8 com Up to 39 seg x 4 com PIN: 32-64 pins ROM: 8-32 KB	RL78/L13 Standard Up to 47 seg x 8 com Up to 51 seg x 4 com PIN: 64-80 pins ROM: 16-128 KB	RL78/L1A 12-bit A/D, 12-bit D/A Up to 41 seg x 8 com Up to 45 seg x 4 com PIN: 60-100 pins ROM: 48-128 KB	Lighting, Power Source	RL78/11A High-Resolution PWM PIN: 20-38 pins ROM: 32-64 KB 2.7-5.5 V	Electricity Meter	RL78/11B 24-bit Δ Σ A/D, LCD PIN: 60-100 pins ROM: 64-128 KB 1.8-5.5 V	RL78/11C 24-bit Δ Σ A/D, AES PIN: 64-100 pins ROM: 64-512 KB 1.8-5.5 V
	Communications	RL78/L1C USB Up to 52 seg x 8 com Up to 56 seg x 4 com PIN: 80-100 pins ROM: 64-256 KB		Measurement	RL78/11D 12-bit A/D, AMP PIN: 20-48 pins ROM: 8-32 KB 1.8-3.6 V	RL78/11E 24-bit Δ Σ A/D, AMP 12-bit D/A, AFE PIN: 32-36 pins ROM: 32 KB 2.4-5.5 V	RL78/H1D 24-bit Δ Σ A/D, AMP 12-bit D/A, AFE, LCD PIN: 48-80 pins ROM: 64-128 KB 1.8-5.5 V	
Automotive								
Standard	RL78/F23 New standard for 40MHz operation LIN, Security, Safety, Motor, High temp. PIN: 32-80 pins ROM: 128 KB	RL78/F24 New standard for 40MHz operation CAN FD/LIN, Security, Safety, Motor, High temp. PIN: 32-100 pins ROM: 256 KB	RL78/F12 LIN, Safety PIN: 20-64 pins ROM: 8-64 KB	RL78/F13 CAN/LIN, Safety, High temp. PIN: 20-80 pins ROM: 16-128 KB	RL78/F14 CAN/LIN, Motor, Safety, High temp. PIN: 30-100 pins ROM: 48-256 KB	RL78/F15 CAN/LIN/IEBus, Motor, Safety PIN: 48-144 pins ROM: 128-512 KB		
	LCD	RL78/D1A Sound generator, Stepper, LCD PIN: 48-128 pins ROM: 24-512 KB						

RL78 FAMILY APPLICATIONS

The RL78 Family is utilized in a wide variety of applications.



Industrial Automation

G24 G23 G22 G16 G15 G14 G11
I1A I1E

- Lineup of microcontrollers for industrial applications requiring high reliability
- Broad array of compact packages
- Operating temperature range of -40°C to $+105^{\circ}\text{C}$, and support available for higher temperatures



Automotive

F24 F23 F15 F14 F13

- Lineup of highly reliable microcontrollers for automotive applications
- Support for high operating temperatures (up to $+150^{\circ}\text{C}$)
- CAN communication, safety functions, etc., for automotive applications



Consumer Electronics

G23 G22 G16 G15 G13 G13A G12
G10 G1P G1N

- Calendar function (RTC) as standard feature
- Serial communication, timers, and on-chip high-speed oscillator as standard features



White Goods

G23 G22 G16 G15 G13 G13A G12
L13

- Hardware support for European safety standard for household appliances (IEC60730)
- Standard temperature range of -40°C to $+85^{\circ}\text{C}$, and support available for higher temperatures (-40°C to $+105^{\circ}\text{C}$ or $+125^{\circ}\text{C}$)
- On-chip high-speed on-chip oscillator, power-on reset, etc., ideal for cost-sensitive electric household appliances



Lighting, Power Supply

I1A G24 G11

- High-resolution PWM output for lighting and power supply control applications
- Easy-to-use Applilet software (free of charge) supporting program development for lighting applications
- Support for DALI, DMX512, PMBus, and SMBus communication



Detector

I1D G11

- Improved analog functions necessary for detecting very small sensor signals
- Support for power-efficient detection when returning to high-speed operation from STOP mode



Home Automation

G23 G22 G16 G15 G13 G13A G1D
G1H

- Power efficiency among the best in the industry for extended battery life
- Support for low-voltage operation (1.6 V to (G1H: 1.8 V and above))
- Standby function with newly added SNOOZE mode for low power consumption during intermittent operation



Power Tools

G24 G1F G14 G11

- Proven track record supplying consistently high-quality microcontrollers over the long term
- Ideal microcontroller platform for system development with lineup covering wide range of memory capacities, pin counts, and package options



Medical/Healthcare

L1A L13 I1E G1D H1D

- Lineup of compact packages
- Proven track record supplying major medical equipment manufacturers
- Active member of Continua Health Alliance



Metering

I1B I1C L13 L1C G11 G1H H1D

- Standby function that is ideal for low-power applications such as meters and measuring devices
- On-chip analog functions for smartmeters



Motor Control

G24 G14 G1F G1G G1M

- On-chip advanced-functionality timers for motor control
- High-speed on-chip oscillator with accuracy of $\pm 1\%$, ideal for low-cost, high-precision solutions

LOW POWER CONSUMPTION

SNOOZE mode for more power savings

In SNOOZE mode the CPU is halted while A/D conversion and data reception are enabled. By transitioning from STOP mode (clock stopped) to SNOOZE mode, it is possible to start the on-chip oscillator and operate peripheral functions while the CPU remains inactive.

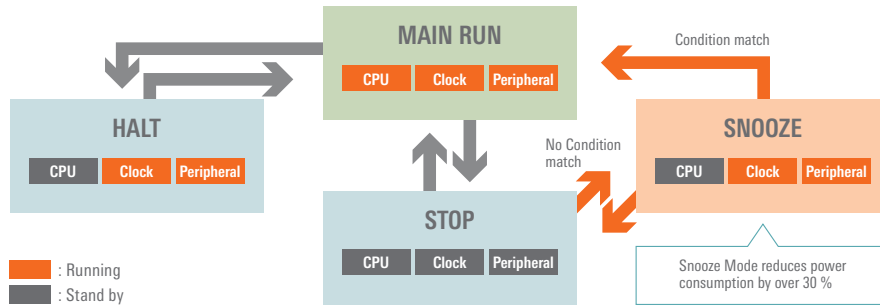

SNOOZE mode

- It is not necessary to activate the CPU for data reception.
- Using the exclusive SNOOZE mode, peripheral functions such as the ADC, UART or CSI can operate when CPU is in standby mode.
- Power consumption is one-tenth of normal operation.
SNOOZE mode: 0.5 mA, RUN mode (ADC): 5 mA

HALT and STOP modes

- The standby function stops CPU operation, reducing overall microcontroller current consumption by 80%.
- The STOP mode disables the microcontroller's on-chip functions, reducing power consumption to the lowest level possible.

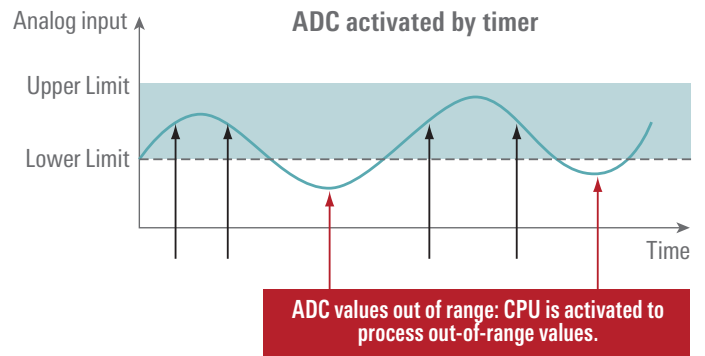

SNOOZE mode sequencer

- RL78 is the first MCU family equipped with this function.
- RL78/G23 and RL78/G22 have this function. (as of 2023/Mar.)
- By this function, even lower power consumption than the conventional SNOOZE mode is possible.
- Details are described on page 09.

Low-power, high-performance products for lower system power consumption overall

In the most common operating modes, the RL78 Family delivers an operating current of 37.5 $\mu\text{A}/\text{MHz}$ (while operating at 32 MHz) and a clock operation current of 0.355 μA . Also, a developed SNOOZE mode has been added to the previously implemented HALT and STOP low-power operation modes. In SNOOZE mode the CPU is in the standby state while A/D conversion and serial communication are enabled, and the CPU is activated only when required. This mode is excellent for battery-powered systems as it greatly increases battery life.

Operating current ($\mu\text{A}/\text{MHz}$)

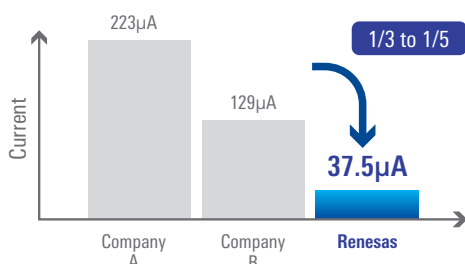

Clock operating current (32kHz, LVD)

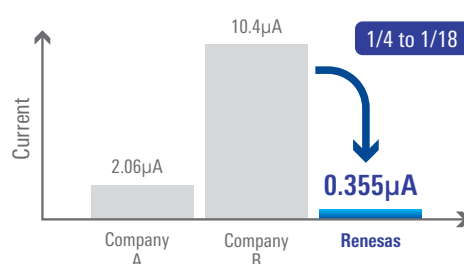

STOP mode current (standby, WDT + LVD)

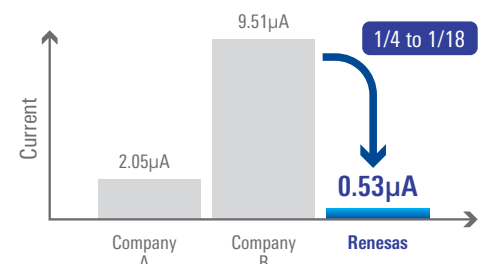

BROAD SCALABILITY

Extensive memory size and package options

- The extensive lineup includes more than 1500 product versions, with memory sizes from 1 KB to 768 KB and package pin counts from 8 pins to 144 pins. This extensive selection provides support for a broad range of application fields, including consumer, automotive, industrial, and communications.
- The wide range of options means a lot to developers if there are changes made to the specifications or more ROM capacity becomes necessary than originally estimated in the middle of the development process.
- Customers can rely on the same microcontroller series when developing product models ranging from the low-end to the high-end. Total development man-hours are reduced.

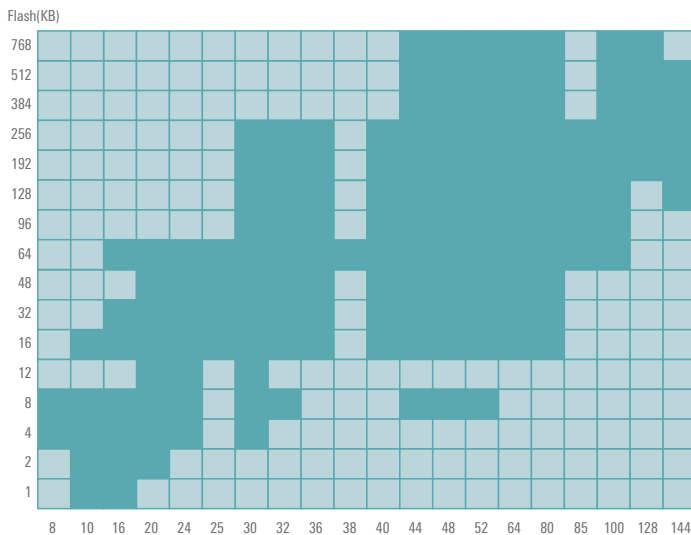

Excellent pin compatibility

- Scalability is maintained because the general location of peripheral function pins and input/output pins remains the same even when the pin count changes. Customers can continue to use the RL78 Family of microcontrollers with confidence in the future.
- Customers can use standardized boards for product models ranging from the low-end to the high-end and boost the efficiency of the verification process.

Example of I/O port assignments on RL78/G1x

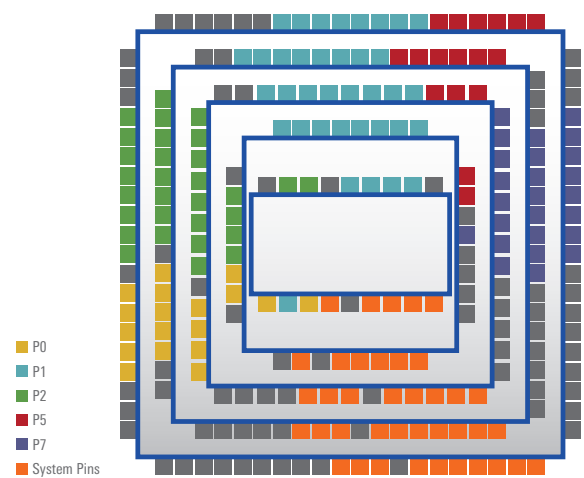

Ability to reassign pin functions with PIOR* register settings

Pin assignments can be changed for added board layout flexibility. The locations of peripheral function pins can be optimized.

Note: * PIOR: Peripheral I/O Redirection

Not all pins can be reassigned.

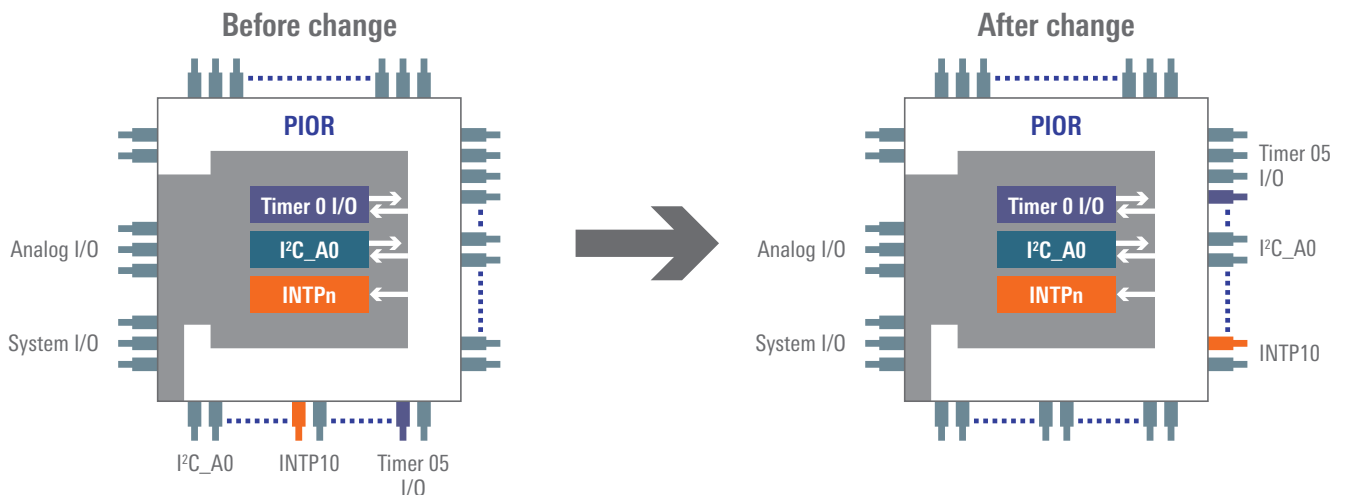

HIGH PERFORMANCE

RL78 microcontrollers with CPU core employing three-stage pipeline and Harvard architecture

RL78 CPU processing performance is overwhelming other MCU vendors' CPU cores.

- 16-bit CPU Core with Pipelining
- Efficient Instruction Execution -> 86% in 1-2 Cycles
- Single Cycle Multiplication (HW Math Assist)
- DMA Engine (up to 4 channels)

RL78 Instruction Execution Cycles:



HW Assist for Math	Operation	Clock Cycles
16bit Barrel Shifter for Shift and Rotate	16bit n Shift/Rotate (n = 1 to 15)	1
Multiply Signed & Unsigned	16 × 16 = 32 Bit Result	1
Multiply/Accumulate Signed & Unsigned	16 × 16 + 32 = 32 Bit Result	2

REDUCED SYSTEM COST

Helping customers reduce system size and cost

On-chip peripheral functions include a high precision ($\pm 1\%$) high-speed on-chip oscillator, background operation data flash supporting 1 million erase/program cycles, a temperature sensor, and multiple power supply interface ports. The RL78 Family is fabricated that enables customers to achieve reduced system cost and smaller overall system size.

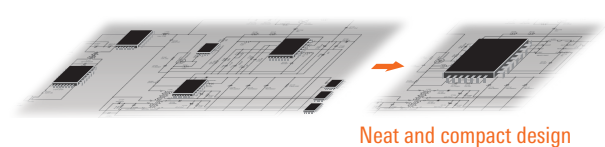

Data flash with advanced functionality (background operation) for substantially reduced programming time

- Data access unit: 1 byte
- Data flash size: 4 KB (erasure unit: 1 KB)
- Number of overwrites: 1 million (typ.)
- Dedicated library: Simplifies operations

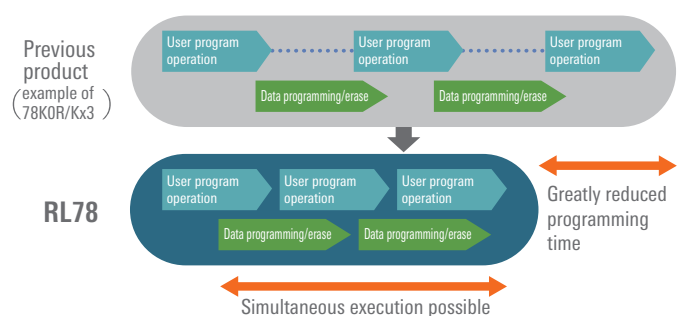

RELIABLE SAFETY FUNCTIONS

Safety functions built into the microcontroller that enhance system reliability

Generally speaking a microcontroller is expected to operate normally even when exposed to noise. The RL78 Family of microcontrollers have a number of safety functions that allow confirmation of normal operation. Customers can use these functions to easily perform self-diagnostics on microcontrollers.

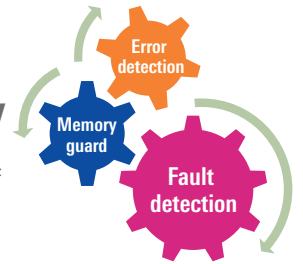

The self-diagnostic functions of the RL78 Family contribute to enhanced system reliability.

■ Error detection

These functions check to make sure that the microcontroller's internal CPU and memory are operating properly. When an error is detected, measures such as an internal reset of the microcontroller can help to prevent the system from malfunctioning.

- Watchdog timer (WDT) as standard feature
- Flash memory CRC calculation
- RAM ECC function*¹
- Illegal memory access detection function*¹
- RAM parity error detection
- CPU stack pointer monitoring function*¹

■ Memory guard

This function disables writing to selected addresses in the RAM and SFRs*². It makes it possible to protect settings in RAM and the SFRs, contributing to improved reliability for the customer's system.

- RAM write protection
- SFR write protection

■ Fault detection

This function is for checking the operation of the microcontroller's clock generator circuit, A/D converter, and I/O pins. It simplifies the task of verifying microcontroller operation and makes it easier for customers to ensure safe and reliable operation of their systems.

- Frequency detection
- I/O port output level detection
- A/D self-check test
- Clock monitoring function*¹

Notes:

1. Available on the RL78/F13, RL78/F14 and RL78/F15.
2. SFR (special function register): Registers that store settings related to special functions such as clock control, the low-voltage detection circuit, port control, and interrupts.

■ Security function

RL78/G23 and RL78/G22 can prevent spoofing by the AES library. This function is installed in RL78/G23 and RL78/G22. Details are described on page 09.

COMPREHENSIVE DEVELOPMENT TOOLS

A full lineup of tools that provides powerful support for efficient development

Renesas provides support for all stages of RL78 application development. The Renesas (CS+, e² studio) and IAR integrated development environments are easy to use and learn, helping shorten development cycles. A variety of debugging and programming environments are available to meet specific customer needs. Finally, Renesas partner vendors offer a rich array of tools and services covering a broad range of requirements.

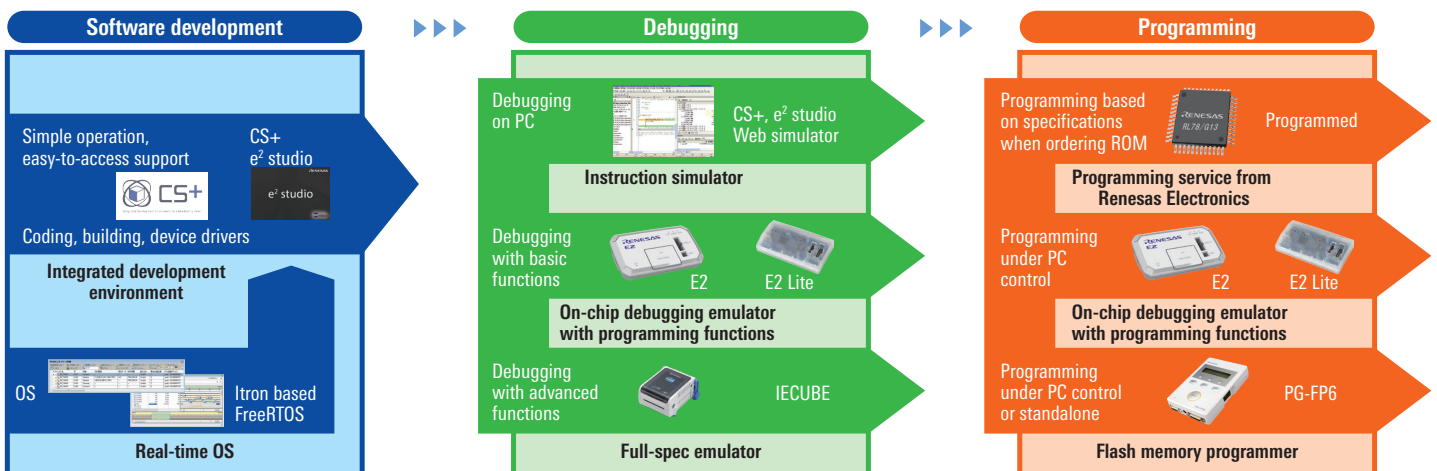

GENERAL-PURPOSE, STANDARD

RL78/G23

RL78/G23 specifications

- **RL78 CPU Core**
 - Three-stage pipeline CISC architecture
 - Max. operating frequency: 32 MHz
- **Memory**
 - Support for 1.6 V flash programming and boot swap
 - Program flash: 96 KB–768 KB
 - SRAM: 12 KB–48 KB
 - Data flash: 8 KB/None
- **System**
 - High-speed on-chip oscillator: 32 MHz ±1%
 - Middle-speed on-chip oscillator: 4 MHz ±12%
 - Library support for multiply/divide and multiply-accumulate operation unit
 - SNOOZE mode sequencer(SMS)
 - Logic & Event link controller
- **Power management**
 - Operating current 41µA/MHz *1
 - HALT current 0.355 µA (RTC+LVD) *1
 - STOP current 210 nA (only 4 KB SRAM data retained) *1
 - Snooze current 700 µA (UART), 1.2 mA (ADC)
- **Safety**
 - Compliant with European safety standard for household appliances (IEC/UL 60730)
 - Illegal memory access detection
- **Security**
 - Unique ID
 - Customer ID
 - Random number generator
- **Timers**
 - Advanced-functionality timer array unit (TAU)
 - 32-bit interval timer
 - Watchdog timer, real-time clock
- **Analog**
 - 1.6 V (VDD) operation
 - On-chip ADC, 12-bit × 26 channels, conversion time: 2.0 µs
 - On-chip DAC, 8-bit × 2 channels, comparator × 2 channels
 - Internal reference voltage (1.48 V)
- **Human Machine Interface**
 - Capacitive sensing unit × 32 channels
 - Controlled current drive output × 8channels
- **Communication**
 - CSI, UART, I²C, Simple I²C
 - Remote control receiver
- **Package**
 - 30-pin–128-pin

Note: 1. Power supply current RL78/G23 Group product with 64 pins and 128 KB of ROM.

RL78/G22

RL78/G22 specifications

- **RL78 CPU Core**
 - Three-stage pipeline CISC architecture
 - Max. operating frequency: 32 MHz
- **Memory**
 - Support for 1.8 V flash programming and boot swap
 - Program Flash: 32 KB–64 KB
 - SRAM: 4 KB
 - Data Flash: 2 KB
- **System**
 - High-speed on-chip oscillator: 32 MHz ±1%
 - Middle-speed on-chip oscillator: 4 MHz ±12%
 - Library support for multiply/divide and multiply-accumulate operation unit
 - SNOOZE mode sequencer (SMS)
 - Event link controller
- **Power management**
 - Operating current 37.5 µA/MHz *2
 - HALT current 0.33 µA (RTC+LVD) *2
 - STOP current 200 nA (only 4 KB SRAM data retained) *2
 - Snooze current 600 µA (UART), 0.9 mA (ADC)
- **Safety**
 - Compliant with European safety standard for household appliances (IEC/UL 60730)
 - Illegal memory access detection
- **Security**
 - Unique ID
 - Customer ID
 - Random number generator
- **Timers**
 - Advanced-functionality timer array unit (TAU)
 - 32-bit interval timer
 - Watchdog timer, real-time clock
- **Analog**
 - 1.6 V (VDD) operation
 - On-chip ADC, 10-bit × 10 channels, conversion time: 2.125 µs
 - Internal reference voltage (1.48 V)
- **Human Machine Interface**
 - Capacitive sensing unit × 29 channels
- **Communication**
 - CSI, UART, I²C, Simple I²C
- **Package**
 - 16-pin–48-pin

Note: 2. Power supply current RL78/G22 Group product with 48 pins and 64 KB of ROM.

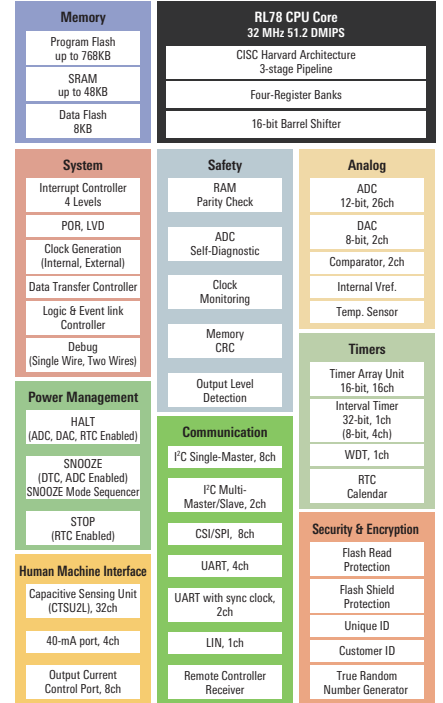

Note: The block diagram of G23

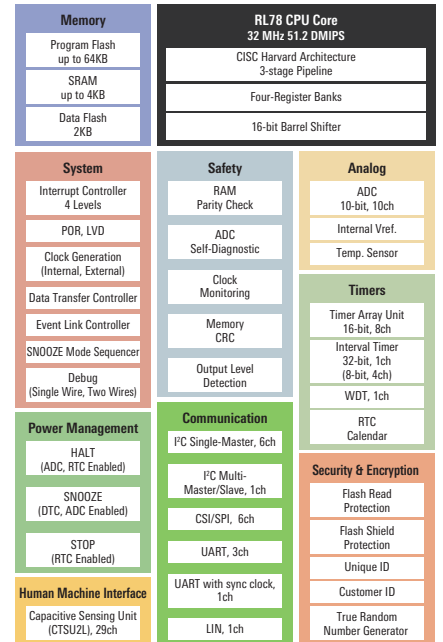

Note: The block diagram of G22

Memory/Pin lineup: RL78/G23, G22

RL78/G23, G22 has compatibility with conventional products.

Pins	16	20	24	25	30	32	36	40	44	48	52	64	80	100	128
Code Flash									48 / 8	48 / 8	48 / 8	48 / 8	48 / 8	48 / 8	48 / 8
768 KB									48 / 8	48 / 8	48 / 8	48 / 8	48 / 8	48 / 8	48 / 8
512 KB									48 / 8	48 / 8	48 / 8	48 / 8	48 / 8	48 / 8	48 / 8
384 KB									32 / 8	32 / 8	32 / 8	32 / 8	32 / 8	32 / 8	32 / 8
256 KB					24 / 8	24 / 8	24 / 8	24 / 8	24 / 8	24 / 8	24 / 8	24 / 8	24 / 8	24 / 8	24 / 8
192 KB					20 / 8	20 / 8	20 / 8	20 / 8	20 / 8	20 / 8	20 / 8	20 / 8	20 / 8	20 / 8	20 / 8
128 KB					16 / 8	16 / 8	16 / 8	16 / 8	16 / 8	16 / 8	16 / 8	16 / 8	16 / 8	16 / 8	16 / 8
96 KB					12 / 8	12 / 8	12 / 8	12 / 8	12 / 8	12 / 8	12 / 8	12 / 8			
64 KB	4 / 2	4 / 2	4 / 2	4 / 2	4 / 2	4 / 2	4 / 2	4 / 2	4 / 2	4 / 2	4 / 2				
32 KB	4 / 2	4 / 2	4 / 2	4 / 2	4 / 2	4 / 2	4 / 2	4 / 2	4 / 2	4 / 2	4 / 2				

Legend: ● : G23 Lineup ● : G22 Lineup ● : G13 Lineup

SNOOZE mode sequencer

The RL78/G23 and RL78/G22 have the new sequencer which can operate most of peripheral functions while in SNOOZE mode.

The SNOOZE mode sequencer realizes even lower power consumption for applications.

Operation in RL78/G13 SNOOZE mode

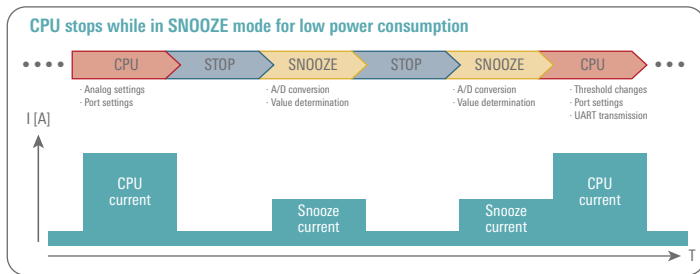

RL78/G23 SNOOZE mode sequencer

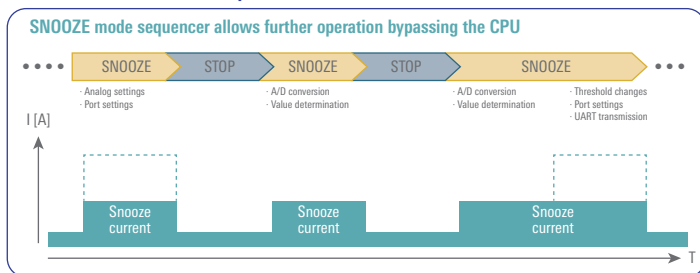

Logic and event link controller (Only RL78/G23)

- Directly link event signals from up to 94 types of peripheral functions to a specified peripheral function
- Link 8 outputs to peripheral functions, ports, interrupts, or the DTC
- Change the conditions for linking event signals from peripheral functions by passing the signals through logic cells (AND, OR, or EX-OR circuits)
- Start a specified peripheral function by inputting event signals from other peripheral functions to a selector
- Connect event signals from peripheral functions to a specified peripheral function in synchronization with a clock by inputting the signals to a flip-flop

Capacitive touch sensing unit

- 2 to 32 touch sensor channels are available.
- Compatible with self-capacitance and mutual capacitance methods. Up to 64 keys are supported when using mutual capacitance.
- Supports keys such as switches, wheels, and sliders. Can also be used as a proximity sensor.
- Supports SNOOZE mode for low-power sensing.

Switch

Wheel

Slider

Proximity

Secure update and secure boot

The RL78/G23 and RL78/G22 can prevent spoofing by using an AES library.

Furthermore, the RL78/G23 and RL78/G22 enable safe flash programming using a boot swap and flash shield window function, as well as program startup from a secured area using a boot cluster 0 rewrite prohibition function.

This provides support for secure update and secure boot to prevent spoofing.

In addition, using the AES-GCM library also prevents eavesdropping on communications between the RL78/G23, RL78/G22 and the main MCU.

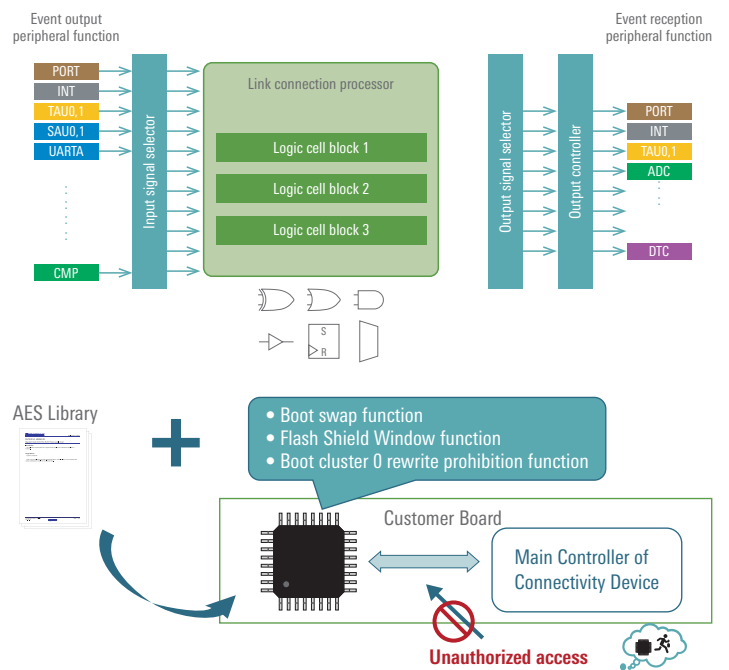

GENERAL-PURPOSE, LOW-PIN-COUNT

RL78/G10

RL78/G10 features

Ultra-low power consumption

- CPU operation: 45.5 μ A /MHz
- STOP mode: 560 nA

Lineup of low-pin-count products

- 10 pin: LSSOP (4.4 \times 3.6 mm)
- 16 pin: SSOP (4.4 \times 5 mm)

High-speed on-chip oscillator

- Max. 20 MHz, oscillation accuracy \pm 2%

Other on-chip functions

- ADC
- Comparator
- Timer
- Serial communication
- Selectable power-on reset

ROM	Pins	
	10	16
4 KB	512	512
2 KB	256	256
1 KB	128	128

■ RAM size (B)

RL78/G10 specifications

■ RL78 CPU Core

- Three-stage pipeline CISC architecture
- Max. operating frequency: 20 MHz

■ Memory

- Program flash: 1 KB–4 KB
- SRAM: 128 B–512 B

■ System

- High-speed on-chip oscillator: 20 MHz \pm 2%
- Selectable POR

■ Power management

- Operating current: 45.5 μ A/MHz
- HALT current: 290 μ A
- STOP current: 560 nA (SRAM data retained)

■ Safety

- Internal reset at illegal instruction execution

■ Timers

- Advanced-functionality timer array unit (TAU)
- Watchdog timer

■ Analog

- On-chip ADC, 10-bit \times 7 channels, conversion time: 3.4 μ s
- On-chip comparator

■ Communication

- CSI, UART, I²C, Simple I²C

■ Package

- 10-pin/16-pin

(Reference) The power supply voltage range during flash memory programming is 4.5 V to 5.5 V. A low-voltage OCD board is required for debugging at less than 4.5 V.

https://www.renesas.com/en-us/doc/products/tool/doc/003/r20ut2451ej0100_e510y16lvb.pdf

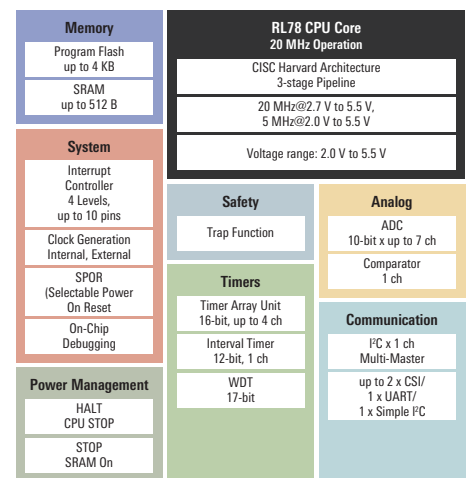

Note: The SPOR detection voltage (VSPOR) must be between 2.25 V and 5.5 V. (Reference) RL78: Block diagram of G10 Group 16-pin product.

Lower system cost: Replacement for general-purpose logic ICs

Using general-purpose logic components complicates the design, manufacturing, and testing processes and can lead to malfunctions. Reducing the number of components is a key issue when developing new products.

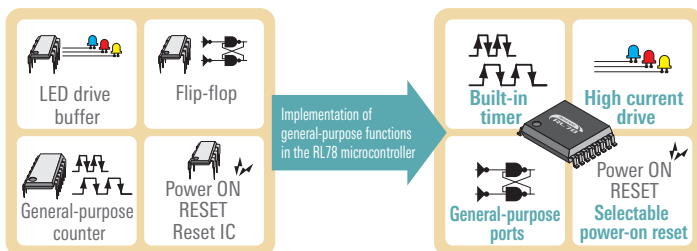

RL78 microcontrollers help simplify the design, manufacturing, and testing processes; reduce malfunctions; and provide numerous other advantages.

- More compact circuit board
- Reduced system cost

RL78/G10 vs. competing products: Operating voltage/frequency range

Covers the voltage range required by compact electric household appliance applications.

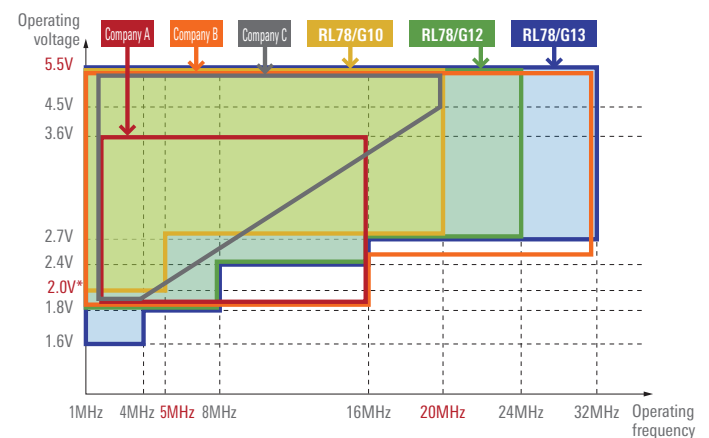

Note: The RL78/G10 includes a SPOR circuit detection voltage (VSPOR), so it should be used within a voltage range of 2.25 V to 5.5 V.

GENERAL-PURPOSE, ADVANCED FUNCTIONALITY

RL78/G11

RL78/G11 features

Ultralow power consumption for extended battery life

- Continues the low power consumption of the RL78 Family.
- Current consumption can be minimized by using the appropriate operating mode setting (HS, LS, LV, or LP).
- Fast wakeup makes intermittent operation more efficient.
- Reduced current consumption contributes to extended battery life.

Advanced-functionality timers supporting PWM forced shutoff

- Advanced-functionality timers (timer KB, TAU)
- Support for forced shutoff of PWM output (timer KB + external interrupts/ CMP)
- Interval timer (8-/12-/16-bit) supporting intermittent operation with long periods

Ability to check battery voltage at low power supply voltages ($V_{DD} = 1.8\text{ V}$ and above) and with no analog wiring

ADC + internal constant voltage (1.45 V)

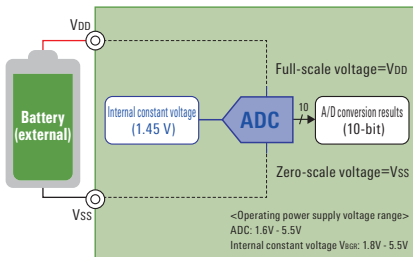

Quantitative measurement of minute analog signals using only a single pin (PGAI)

PGA + ADC (+ internal constant voltage)

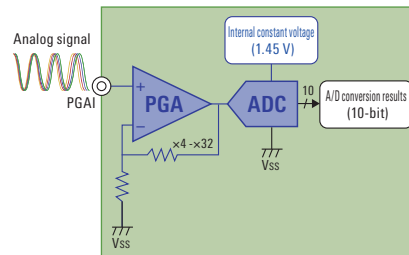

Detection of minute voltages using a single pin and setting of detection threshold using microcontroller's on-chip DAC

PGA + CMPO + DAC

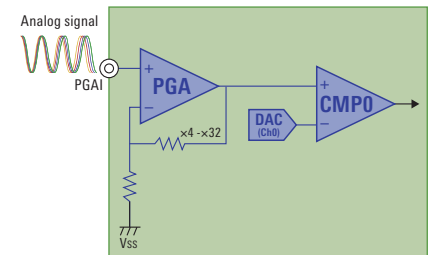

RL78/G11 specifications

- RL78 CPU Core**
 - Three-stage pipeline CISC architecture
 - Support for multiply, divide, and multiply-and-accumulate instructions
- Memory**
 - Support for 1.8 V flash programming and boot swapping
 - Code Flash: 16KB
 - SRAM: 1.5KB
 - Data Flash: 2KB
 - Support for shipment of pre-programmed microcontrollers
- System**
 - Operating voltage range: 1.6 V to 5.5 V
 - Operation state control (flash operating mode transition)
 - High-speed on-chip oscillator: 24 MHz $\pm 1\%$
 - Medium-speed on-chip oscillator: 4 MHz $\pm 12\%$
 - DTC, ELC, DOC, INTFO
 - Support for POR, LVD, different-potential communication
- Power management**
 - Normal operation: 58.3 $\mu\text{A}/\text{MHz}$
 - Halt mode: 0.65 μA (LVD)
- Stop mode: 0.25 μA (data retained)
- SNOOZE mode: 0.7mA (UART), 0.67mA (ADC)
- Safety**
 - Support for household safety standards (IEC/UL 60730)
- Timers**
 - Timer array unit (TAU) $\times 4$ channels
 - Timer KB $\times 1$ channel (max. 48 MHz operation), support for PWM forced stop
 - Interval timer (8-bit, 12-bit, or 16-bit)
 - Watchdog timer (WDT)
- Analog**
 - ADC 10-bit $\times 11$ channels, conversion time: 2.1 μs
 - DAC 8-bit $\times 2$ channels
 - Comparator $\times 2$ channels
 - PGA $\times 1$ channel
 - Internal reference voltage V_{BGR} (operation at $1.8\text{ V} \leq V_{DD} \leq 5.5\text{ V}$)
- Communication**
 - CSI, UART, I²C, Simple I²C
- Package**
 - 10-pin/16-pin/20-pin/24-pin/25-pin
- Operating temperature range**
 - 40°C to +85°C / +105°C

Analog functions connected to the microcontroller internally

- Organic internal connections eliminate the need for external analog wiring (PGA + ADC + VBGR, PGA + CMP + DAC/VBGR, etc.).
- Analog functions operate at low voltages, supporting voltage monitoring at 1.8 V and above (ADC = 1.6 V and above, VBGR = 1.8 V and above, CMP1 = 1.6 V and above, DAC = 1.6 V and above)

Pins	10		16		20		24		25	
	ROM		ROM		ROM		ROM		ROM	
16 KB	1.5 K	2 K	1.5 K	2 K	1.5 K	2 K	1.5 K	2 K	1.5 K	2 K

RAM size (B) DATA flash size (B)

Memory	RL78 16-bit CPU 24 MHz 38.4 DMIPS	
Program Flash 16 KB	MUL/DIV/MAC Instruction	
SRAM 1.5 KB	Four Register Banks	
Data Flash 2 KB	16-bit Barrel Shifter	
System	Safety	Analog
DTC 24 sources	RAM Parity Check	ADC 10-bit, 11 ch
ELC 18 Events	ADC Self-diagnostic	DAC 8-bit, 2 ch
Interrupt Controller 4 Levels	Clock Monitoring	Comparator 2 ch
Clock Generation Internal, External	Memory CRC	PGA
POR, LVD		Internal Vref.
Debug Single-Wire		Temp. Sensor
Power Management	Timers	Communication
HALT DTC Enabled	Timer Array Unit 16-bit, 4 ch	2 x I ² C Multi-Master
SNOOZE Serial, ADC Enabled	Timer KB 16-bit, 1 ch	CSI $\times 2$ / UART $\times 1$ / Simple I ² C $\times 2$
STOP SRAM On	Interval Timer 8-bit, 2 ch	CSI $\times 2$ / UART $\times 1$ / Simple I ² C $\times 2$
	Interval Timer 12-bit, 1 ch	
	WDT 17-bit, 1 ch	

(Reference) RL78: Block diagram of G11 Group 25-pin product.

GENERAL-PURPOSE, STANDARD

RL78/G12, G13, G13A

RL78/G12, G13, G13A specifications

- RL78 CPU Core**
 - Three-stage pipeline CISC architecture
 - Max. operating frequency: 32 MHz
- Memory**
 - Support for 1.8 V flash programming and boot swap
 - Program flash: 2 KB–512 KB
 - SRAM: 256 B–32 KB
 - Data flash: 2 KB/4 KB/8 KB/None
- System**
 - High-speed on-chip oscillator: 32 MHz \pm 1%
 - Library support for multiply/divide and multiply-accumulate operation unit
- Power management**
 - Operating current: 66 μ A/MHz*1
 - HALT current: 0.57 μ A (RTC + LVD)*1
 - STOP current: 230 nA (SRAM data retained)*1
 - SNOOZE current: 700 μ A (UART), 1.2 mA (ADC)
- Safety**
 - Compliant with European safety standard for household appliances (IEC/UL 60730)
 - Illegal memory access detection
- Timers**
 - Advanced-functionality timer array unit (TAU)
 - Watchdog timer, real-time clock
- Analog**
 - 1.6 V (VDD) operation
 - On-chip ADC, 10-bit \times 26 channels, conversion time: 2.1 μ s
 - Internal reference voltage (1.45 V)
- Communication**
 - CSI, UART, I2C, Simple I2C
- Package**
 - 20-pin–128-pin

Note: 1. Power supply current RL78/G13 Group product with 64 pins and 64 KB of ROM.

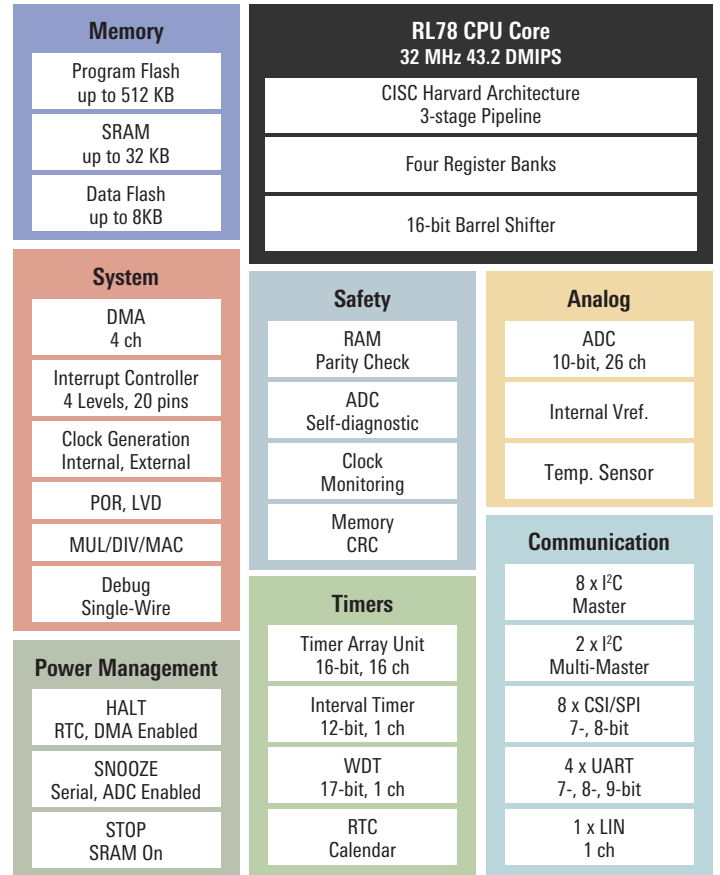

Note: The block diagram of G13

RL78/G13A lineup

ROM	Pins		40		48		64		100	
512 KB	32 KB	8 KB	32 KB	8 KB	32 KB	8 KB	32 KB	8 KB	32 KB	8 KB
384 KB	24 KB	8 KB	24 KB	8 KB	24 KB	8 KB	24 KB	8 KB	24 KB	8 KB

RAM size DATA flash size

Extensive lineup: RL78/G12, G13, G13A

Choose with confidence. Extensive lineup of 284 products.

ROM	Pins															
	20	24	25	30	32	36	40	44	48	52	64	80	100	128		
512 KB								32 K	32 K	32 K	32 K	32 K	32 K	32 K	32 K	
384 KB								24 K	24 K	24 K	24 K	24 K	24 K	24 K	24 K	
256 KB								20 K	20 K	20 K	20 K	20 K	20 K	20 K	20 K	
192 KB							16 K	16 K	16 K	16 K	16 K	16 K	16 K	16 K	16 K	
128 KB				12 K	12 K	12 K	12 K	12 K	12 K	12 K	12 K	12 K	12 K	12 K	12 K	
96 KB				8 K	8 K	8 K	8 K	8 K	8 K	8 K	8 K	8 K	8 K	8 K	8 K	
64 KB	4 K	4 K	4 K	4 K	4 K	4 K	4 K	4 K	4 K	4 K	4 K	4 K	4 K	4 K	4 K	
48 KB	3 K	3 K	3 K	3 K	3 K	3 K	3 K	3 K	3 K	3 K	3 K	3 K	3 K	3 K	3 K	
32 KB	2 K	2 K	2 K	2 K	2 K	2 K	2 K	2 K	2 K	2 K	2 K	2 K	2 K	2 K	2 K	
16 KB	2 K	2 K	2 K	2 K	2 K	2 K	2 K	2 K	2 K	2 K	2 K	2 K	2 K	2 K	2 K	
12 KB	1.5 K	1.5 K	1.5 K	1.5 K	2 K	2 K										
8 KB	1 K	1 K	1 K	1 K	1 K	1 K										
8 KB	768	768	768	768	768	768										
4 KB	512	512	512	512	512	512										
2 KB	256	256														

RAM No data flash RAM Equipped with data flash

1. For 20-pin packages, the pin spacing of the RL78/G12 is 225 mil and that of the RL78/G13 is 300 mil.
2. For the 64-pin BGA (4 \times 4) package products, the ROM capacity ranges from 32 KB to 256 KB.

Extensive lineup: Compact packages

Available compact package options are ideal for miniaturized products.

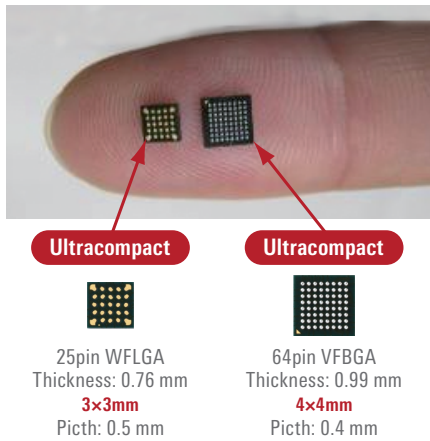

High performance: Low-voltage operation

Expanded operating range compared with previous products and support for A/D conversion at voltages from 1.6 V

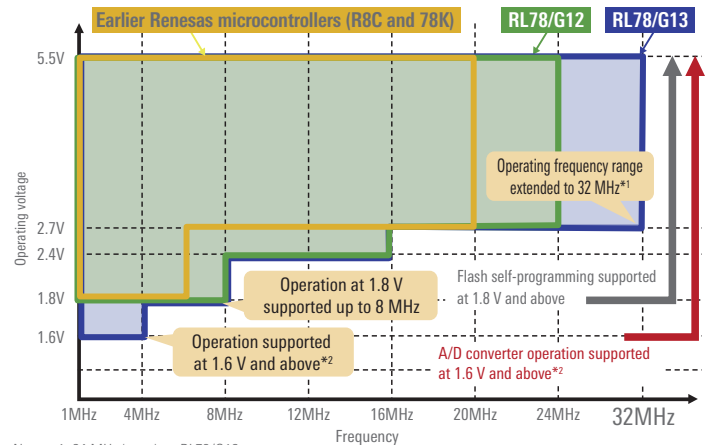

Notes: 1. 24 MHz (max.) on RL78/G12
2. Operation supported at 1.8 V and above on RL78/G12

High performance: Multiply and divide/multiply-accumulate operation unit

On-chip multiply-accumulate operation unit for reduced operation load on CPU

- Completion interrupt generated for divide operations only.
- Multiply-accumulate operation overflow/underflow interrupt generated when the cumulative result of multiply-accumulate operations causes an overflow or underflow.
- Combined-use divide completion interrupt and multiply-accumulate operation overflow/underflow interrupt.
- Whether an overflow or underflow occurred can be determined by referencing a status flag.
- Since the C lacks multiply-accumulate operation instructions, library functions are provided.

Multiply and divide circuit with support for multiply-accumulate operations

operation	exec cycle
Signed multiply	16 bits×16 bits=32 bits 1 clock
Unsigned multiply	16 bits×16 bits=32 bits 1 clock
Unsigned divide	32 bits/32 bits=32 bits ... 32 bits 16 clock
Signed multiply-accumulate	16 bits×16 bits+32 bits=32 bits 2 clock
Unsigned multiply-accumulate	16 bits×16 bits+32 bits=32 bits 2 clock

Reduced system cost: On-chip high-precision, high-speed oscillator

On-chip high-precision, high-speed oscillator to support UART communication

- On-chip high-speed clock generator circuit with precision of ±1%*1
- Selectable frequencies: 32 MHz*2, 24 MHz, 16 MHz, 12 MHz, 8 MHz, 6 MHz, 4 MHz, 3 MHz, 2 MHz, and 1 MHz
- Oscillation accuracy correction register for even higher precision

Notes: 1. ±5% on R5F103x 2. RL78/G13 only

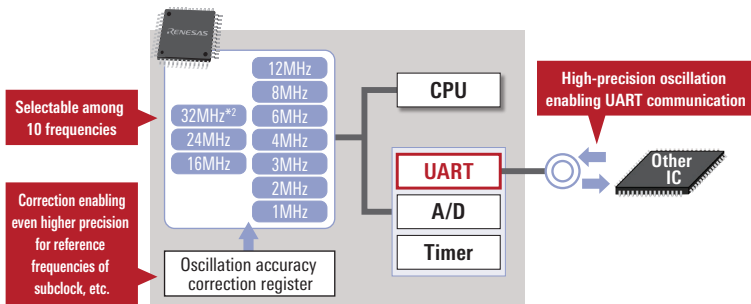

HOCO oscillation frequency accuracy

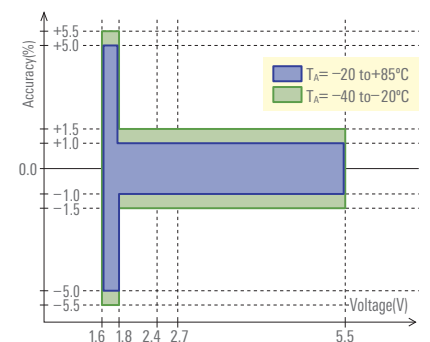

GENERAL-PURPOSE, ADVANCED FUNCTIONALITY

RL78/G24

RL78/G24 specifications

RL78 CPU Core

- Three-stage pipeline CISC architecture
- Max. operating frequency: 48 MHz
- Flexible Application Accelerator (FAA)

Memory

- Code Flash: 64 KB/128 KB
- SRAM: 12 KB
- Data flash: 4 KB

System

- Operating voltage range: 1.6 V to 5.5 V
- Operation state control (Flash operating mode transition)
- High-speed on-chip oscillator: 64 MHz \pm 1%
- Low-speed on-chip oscillator: 32.768 kHz \pm 15%
- DTC, ELC, POR, LVD, different-potential Communication

Timers

- Timer array unit (TAU) \times 4 channels
- Timer RJ \times 1 channel
- Timer RD2 \times 2 channels
- Timer RX \times 1 channel
- Timer RG2 \times 1 channel
- Interval timer (32-bit)
- Watchdog timer (WDT)

Analog

- ADC 12-bit/10-bit/8-bit selectable \times 23 channels
- DAC 10-bit/8-bit selectable \times 3 channels
- Comparator \times 4 channels

Communication

- CSI, UART, I²C, Simple I²C, DALI

Package

- 20-pin/24-pin/25-pin/30-pin/32-pin/40-pin/44-pin/48-pin/52-pin/64-pin
- Operating temperature range: -40°C to +85°C/+105°C/+125°C

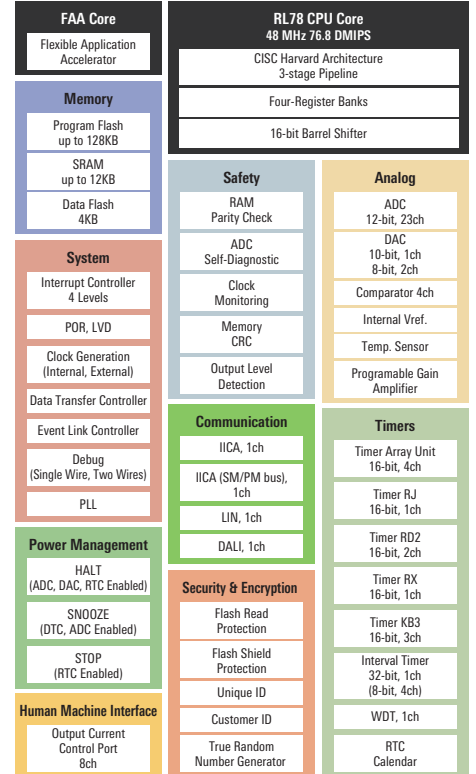

Note: The block diagram of G24

RL78/G24 lineup

ROM	Pins	20	24	25	30	32	36	40	44	48	52	64	80	100	128
512 KB															
384 KB			RAM [KB] / Data Flash [KB]												
256 KB															
192 KB															
128 KB		12 / 4	12 / 4	12 / 4	12 / 4	12 / 4		12 / 4	12 / 4	12 / 4	12 / 4	12 / 4			
96 KB															
64 KB		12 / 4	12 / 4	12 / 4	12 / 4	12 / 4		12 / 4	12 / 4	12 / 4	12 / 4	12 / 4			
48 KB															
32 KB															
16 KB															

Legend: : G14 Lineup

RL78/G14

RL78/G14 specifications

RL78 CPU Core

- Three-stage pipeline CISC architecture
- Max. operating frequency: 32 MHz

Memory

- Code Flash: 16 KB-512 KB
- SRAM: 2.5 KB-48 KB
- Data Flash: 4 KB, 8 KB
- Support for shipment of pre-programmed Microcontrollers

System

- Operating voltage range: 1.6 V to 5.5 V
- Operation state control (Flash operating mode Transition)
- High-speed on-chip oscillator: 64 MHz ±1%
- Low-speed on-chip oscillator: 15 kHz ±15%
- DTC, ELC, POR, LVD, different-potential Communication

Timers

- Timer array unit (TAU) × 8 channels
- Timer RJ × 1 channel
- Timer RD × 2 channels
- Timer RG × 1 channel
- Interval timer (12-bit)
- Watchdog timer (WDT)

Analog

- ADC 10-bit/8-bit selectable × 20 channels
- DAC 8-bit × 2 channels
- Comparator × 2 channels

Communication

- CSI, UART, I²C, Simple I²C

Package

- 30-pin/32-pin/36-pin/40-pin/44-pin / 48-pin/52-pin/64-pin /80-pin/100-pin
- Operating temperature range: -40°C to +85°C/ +105°C

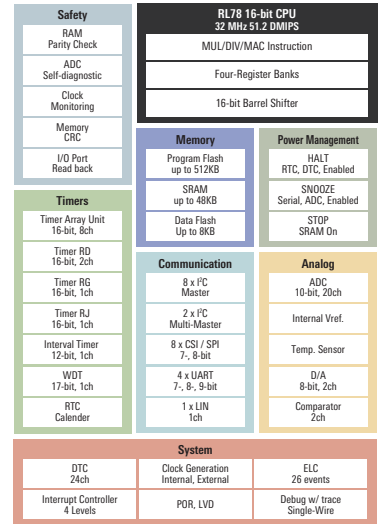

(Reference) RL78: Block diagram of G14 Group 100-pin product.

CPU core supporting multiply and divide/multiply-accumulate instructions

Added multiply, divide, and multiply-accumulate instructions that enable high-speed operation by direct execution without needing to utilize library functions

Overview of multiply, divide, and multiply-accumulate instructions

	operation	exec cycle
Multiply	8 bits×8 bits=16 bits	1 clock
	16 bits×16 bits=32 bits	2 clock
Divide	16 bits / 16 bits=16 bits ... 16 bits	9 clock
	32 bits / 32 bits=32 bits ... 32 bits	17 clock
Multiply-accumulate	16 bits×16 bits+32 bits=32 bits	3 clock

Points of difference from multiply and divide/multiply-accumulate operation unit on RL78/G12 and RL78/G13

- No interrupts are generated.
- A carry flag is set when the cumulative result of multiply-accumulate operations causes an overflow or underflow.

Featured function: Timer RG (phase counting mode)

This function counts (increments or decrements a counter) at both edges when two pulse signals with different phases are input to pins TRGCLKA and TRGCLKB. It is ideal for counting in a two-phase encoder.

TRGCLKB pin		"H"		"L"	"H"		"L"	
TRGCLKA pin	"L"		"H"			"L"		"H"
Bits CNTEN7 to CNTEN0 in TRGCNTC register	CNTEN 7	CNTEN 6	CNTEN 5	CNTEN 4	CNTEN 3	CNTEN 2	CNTEN 1	CNTEN 0
Setting value of TRGCNTC register	1	1	1	1	1	1	1	1
Increment/decrement counter	+1	+1	+1	+1	-1	-1	-1	-1

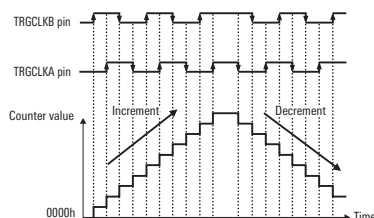

In combination with the TRGCNTC register value, this function performs phase counting by incrementing or decrementing a counter when a user-defined input state occurs.

Featured function: Timer RD (complementary PWM mode)

High-resolution three-phase complementary PWM output ideal for driving DC brushless motors

- Ability to output three sets of PWM waveforms with no overlap between the forward and reverse phases
- Use of on-chip high-speed oscillator (64 MHz or 48 MHz) as count source supported
- Ability to operate using multiples of the CPU clock frequency for reduced power consumption

Complementary PWM mode operation example

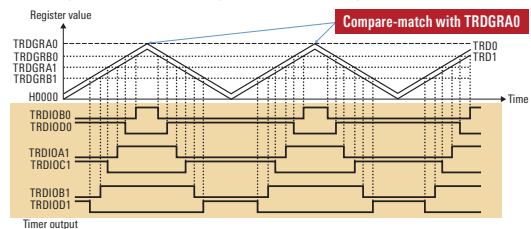

Featured function: Data transfer controller (DTC)

The DTC provides functionality to transfer data from one memory location to another, bypassing the CPU.

- Increased number of transfer channels and activation sources for improved flexibility
 - Support for data transfers among SFRs, on-chip RAM, and flash memory*1
- Note: 1. The DTC can only read data from flash memory.

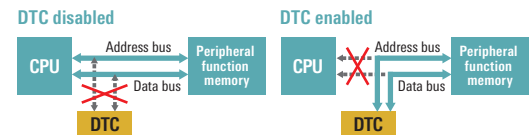

Comparison of DMA and DTC

	DMA(G13 100pin)	DTC(G14 100pin)
Number of channels	4 channels	24 channels
Transfer address space	4 KB	64 KB
Max. transfer count/block size	1024/1024 bytes	256/512 bytes
Transfer target	SFR ↔ RAM	SFR ↔ RAM Flash memory → SFR, RAM
Number of activation sources	21	39
Other	—	Repeat and chain transfers supported

Featured function: Flexible Application Accelerator (RL78/G24)

Flexible Application Accelerator (FAA) which is built in RL78/G24 can accelerate various processing speed such kind of Inverter, Encryption, Sensing and math processing.



■ Improve characteristics

Improving characteristic of conventional RL78 system by high speed processing of Flexible Application Accelerator. In addition, the calculation accuracy is improved by using a 32-bit arithmetic unit.

■ BOM cost down

New processing can be added to free tasks by parallel processing of Flexible Application Accelerator and CPU. As a result, a system that previously required two chips (system control and inverter control) can be configured as a single chip.

■ Easy to Use

A library for Flexible Application Accelerators prepared in advance enables easy development and reduction of evaluation man-hours.

Comparison of processing time of PI calculations for inverter control

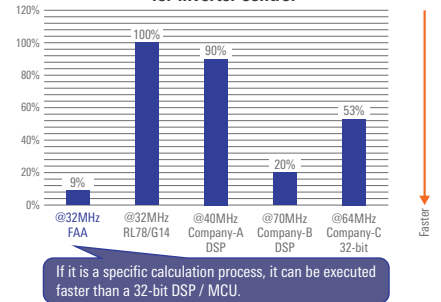

Featured function: Event link controller (ELC)

Direct links between hardware modules

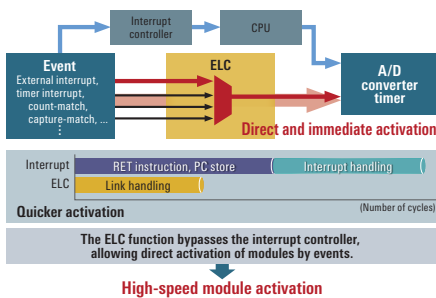

No CPU operation needed

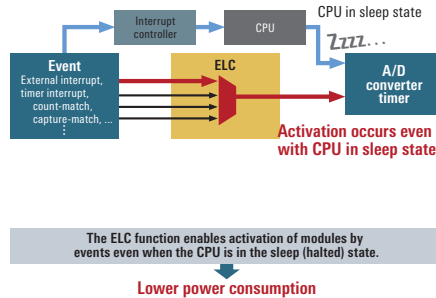

Featured function: D/A converter (G14 is only for products with ROM 96 KB or more)

On-chip 8-bit D/A converter (2 channels) that simplifies control of analog output for applications such as audio playback or power supply control

D/A converter operation

1. Normal mode
D/A conversion is started by a write operation to the DACSn (n = 0 or 1) register.
2. Real-time output mode
D/A conversion is started using the real-time output signal input by the ELC as the activation trigger.

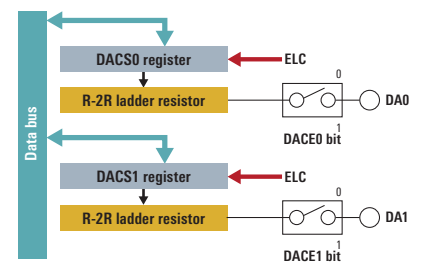

Featured function: Comparator (G14 is only for products with ROM 96 KB or more)

Comparator with two channels and support for switching between high-speed and low-speed modes (one channel on 30-pin SOP products)

High-speed mode: Support for high-speed operation for motor control feedback, etc.

Low-speed mode: Support for low power consumption during battery monitoring, etc.

Ability to use as a window function by combining channels

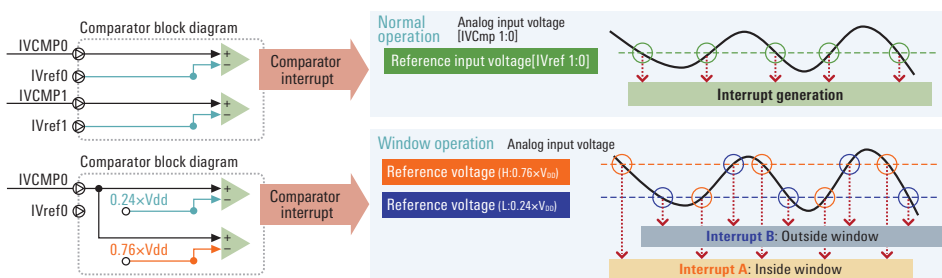

GENERAL-PURPOSE, STANDARD

RL78/G15

RL78/G15 specifications

- **RL78 CPU Core**
 - Three-stage pipeline CISC architecture
 - Max. operating frequency: 16 MHz
- **Memory**
 - Program flash: 4 KB / 8 KB
 - SRAM: 1 KB
 - Data flash: 1 KB
- **System**
 - High-speed on-chip oscillator: 16 MHz ±1%
 - Selectable POR
- **Power management**
 - Operating current: 54.4 µA/MHz
 - HALT current: 371 µA
 - STOP current: 620 nA (SRAM data retained)
- **Timers**
 - Timer array unit (TAU) × 8 channels
 - Interval Timer (12-bit)
 - Watchdog timer
- **Analog**
 - ADC 10-bit × 11 channels
 - Comparator × 2 channels
 - Internal Reference Voltage (0.815 V)
- **Communication**
 - CSI, UART, I²C, Simple I²C
- **Package**
 - 8-pin/10-pin/16-pin/20-pin
- **Operating temperature range**
 - -40 to 125°C

RL78/G16

RL78/G16 specifications

- **RL78 CPU Core**
 - Three-stage pipeline CISC architecture
 - Max. operating frequency: 16 MHz
- **Memory**
 - Program flash: 16 KB / 32 KB
 - SRAM: 2 KB
 - Data flash: 1 KB
- **System**
 - High-speed on-chip oscillator: 16 MHz ±1%
 - Selectable POR
- **Power management**
 - Operating current: 60.6 µA/MHz
 - HALT current: 385 µA
 - STOP current: 620 nA (SRAM data retained)
- **Timers**
 - Timer array unit (TAU) × 8 channels
 - Interval Timer (12-bit)
 - Watchdog timer
- **Analog**
 - ADC 10-bit × 11 channels
 - Comparator × 2 channels
 - Internal Reference Voltage (0.815 V)
- **Communication**
 - CSI, UART, I²C, Simple I²C
- **Package**
 - 8-pin/10-pin/16-pin/20-pin/32-pin
- **Operating temperature range**
 - -40 to 125°C

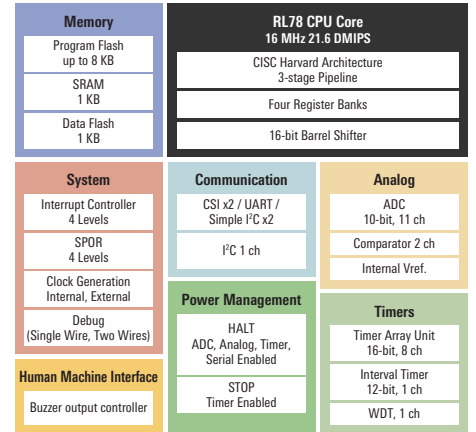

Note: The block diagram of G15

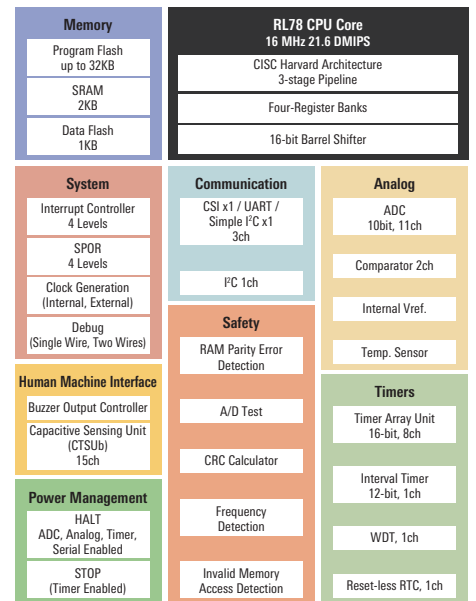

Note: The block diagram of G16

Memory/Pin lineup:

Enhancing Low-Pin-Count/Small package with 8-pin.
Compatible pin functions with the existing products.

ROM	Pins	RAM [KB] / Data Flash [KB]						
		8	10	16	16	20	24	32
32 KB			2 / 1	2 / 1	2 / 1	2 / 1	2 / 1	2 / 1
16 KB			2 / 1	2 / 1	2 / 1	2 / 1	2 / 1	2 / 1
8 KB		1 / 1	1 / 1	1 / 1	1 / 1	1 / 1		RL78/G16
4 KB		1 / 1	1 / 1	1 / 1	1 / 1	1 / 1		
2 KB							RL78/G15	
1 KB								

Legend: ■ G22 Lineup (Dark Blue), ■ G12 Lineup (Medium Blue), ■ G10 Lineup (Light Blue)

High-speed on-chip oscillator with high accuracy

The accuracy of ±1% over a wide temperature range *1

*Note: 1. G-version, M-version

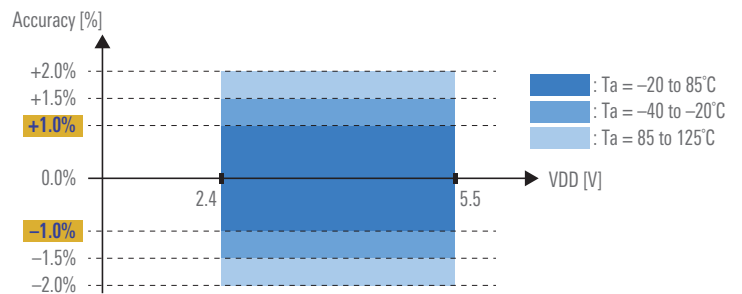

GENERAL-PURPOSE, ANALOG

RL78/G1A

RL78/G1A features

High-precision A/D converter

- 12-bit A/D converter
 - Total error: ± 1.7 LSB (typ.)
 - Conversion time: 3.375 μ s
- Multi-channel analog input
 - 28 analog input channels (max.) to support input from multiple sensors

Low power consumption/standby mode

- Low power consumption
 - Carries on the low power consumption of the RL78 Family
 - Operating current: 66 μ A/MHz
 - STOP current: 0.23 μ A
- Standby mode
 - Three modes: HALT, SNOOZE, and STOP
 - Reduced average current during intermittent operation

Compact package/extensive peripheral functions

- Compact package
 - 3 \times 3 mm square : 25-pin LGA package
 - 4 \times 4 mm square : 64-pin BGA package
- Extensive peripheral functions
 - Timer (16-bit \times 8 channels)
 - Data flash (nonvolatile memory for data)
 - Serial communication (CSI, UART, I²C, etc.)
 - Fault detection (safety functions)

RL78/G1A specifications

RL78 CPU Core

- Three-stage pipeline CISC architecture
- Max. operating frequency: 32 MHz

Memory

- Support for 1.8 V flash programming and boot swap
- Program flash: 16 KB–64 KB
- SRAM: 2 KB–4 KB
- Data flash: 4 KB

System

- High-speed on-chip oscillator: 32 MHz $\pm 1\%$
- Library support for multiply/divide and multiply-accumulate operation unit

Power management

- Operating current: 66 μ A/MHz
- HALT current: 0.57 μ A (SUB + RTC + LVD)
- STOP current: 0.23 μ A (SRAM data retained)
- SNOOZE current: 700 μ A (UART), 1020 μ A (ADC)

Safety

- Compliant with European safety standard for household appliances (IEC/UL 60730)
- Illegal memory access detection

Timers

- Advanced-functionality timer array unit (TAU)
- Watchdog timer, real-time clock

Analog

- 1.6 V (VDD) operation
- On-chip ADC, 12-bit \times 28 channels, conversion time: 3.375 μ s
- Internal reference voltage (1.45 V)

Communication

- CSI, UART(LIN) I²C, Simple I²C

Package

- 25-pin LGA (3 \times 3 mm square)
- 32-pin QFN (5 \times 5 mm square)
- 48-pin QFP (7 \times 7 mm square)
- 64-pin QFN (7 \times 7 mm square)
- 64-pin QFP (10 \times 10 mm square)
- 64-pin BGA (4 \times 4 mm square)

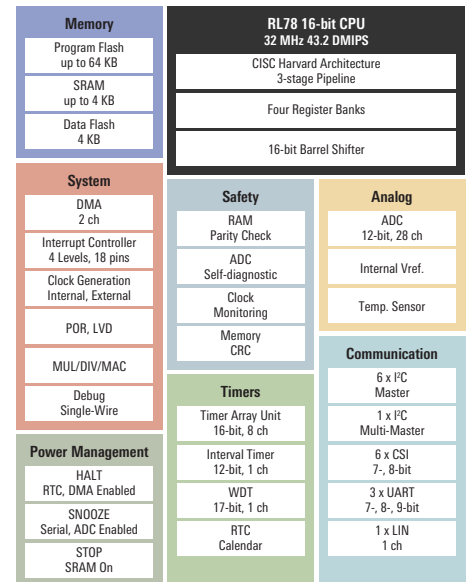

(Reference) RL78: Block diagram of G1A Group 64-pin product.

RL78/G1A overview

Lineup of RL78 Family products with enhanced analog functions

Features

- RL78 CPU core
 - High-performance 16-bit CPU High-speed 32 MHz operation
 - Low power consumption 66 μ A/MHz when running 0.57 μ A/MHz during standby (SUB + RTC + LVD)
- High performance peripheral functions
 - High-resolution 12-bit A/D converter Improved sensing precision, max. 28 channels
 - On-chip high-precision high-speed clock generator circuit Precision: $\pm 1\%$
 - Data flash: 4 KB Support for background operation
 - Multiply and divide/multiply-accumulate operation unit Reduced CPU load

Memory lineup

Compact packages and extensive memory capacity options

ROM	Pins	25		32		48		64	
		RAM	DATA	RAM	DATA	RAM	DATA	RAM	DATA
64K		4K	4K	4K	4K	4K	4K	4K	4K
48K		3K	4K	3K	4K	3K	4K	3K	4K
32K		2K	4K	2K	4K	2K	4K	2K	4K
16K		2K	4K	2K	4K	2K	4K		

RAM size (B) DATA flash size (B)

Support for multiple sensors of various types

Multi-channel analog input support among the best in the industry with 12-bit A/D converter

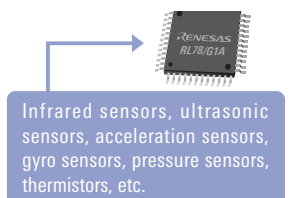

GENERAL-PURPOSE, WIRELESS

RL78/G1H

RL78/G1H features

Power-efficient microcontroller with sub-GHz band transceiver compliant with IEEE 802.15.4g standard

Integration of RF peripheral circuits

- RF peripheral balun and filter functions are integrated into the chip. This contributes to a substantial reduction in the design workload and system cost.

Ultralow current consumption during reception, among the lowest in the industry

- RF reception: 6.3 mA*1, RF reception standby: 5.8 mA*1
- Reception sensitivity: -105 dBm*2

Notes: 1. Typ., VDD = 3.3 V 2. 2GFSK, 100 kbps, BER < 0.1%

IEEE 802.15.4e/g-compliant hardware for reduced CPU load

- Generates in hardware wireless frames compliant with IEEE 802.15.4g.
- Provides integrated functionality to automatically distinguish two systems of communication addresses. This reduces the development load, since software it not needed for this processing.
- Supports ACK reply/receive functionality, including the enhanced format required under the Wi-SUN specification, and CSMA-CA functionality in hardware. This reduces the need to implement complicated timing control processing in software.

ROM	Pins	
	64	
512 KB	48 KB	8 KB
384 KB	32 KB	8 KB
256 KB	24 KB	8 KB

RAM size DATA flash size

RL78/G1H specifications

RL78 CPU Core

- Three-stage pipeline CISC architecture
- Max. operating frequency: 32MHz
- Support for multiply, divide, and multiply-and-accumulate instructions

Memory

- Support for 1.8 V flash programming and boot swapping
- Program Flash: 256 KB, 384 KB, 512 KB
- SRAM: 24 KB, 32 KB, 48 KB
- Data Flash: 8 KB

IEEE802.15.4e/g

- IEEE 802.15.4g compliant sub-GHz band transceiver

System

- High-speed on-chip oscillator: 32 MHz/24 MHz/16 MHz/12 MHz/8 MHz/6 MHz/4 MHz/3 MHz/2 MHz/1 MHz

- Data transfer controller
- Event link controller
- Power management
 - Power-on reset
 - Voltage detection circuit
- Safety
 - Compliant with European household safety standard (IEC/UL 60730)
- Timers
 - Advanced-functionality timer array unit (TAU)
 - Interval timer
 - Watchdog timer, real-time clock
- Analog
 - On-chip ADC, 10-bit x 6 channels
- Communication
 - CSIx3, UARTx2, I²Cx2
- Package
 - HVQFN 9x9mm 64pin, 0.5mm pitch

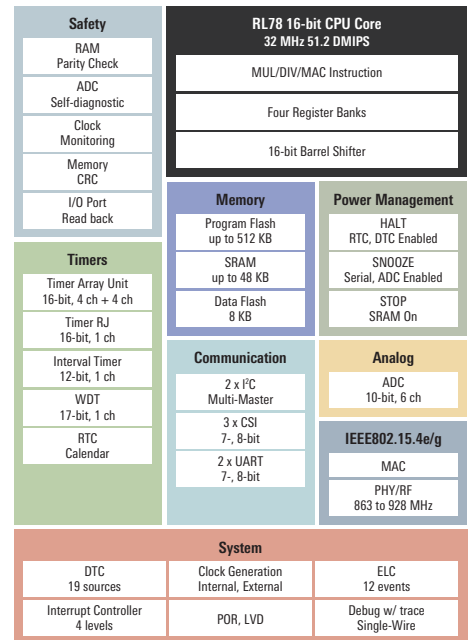

Sub-GHz band transceiver

- Compliant with IEEE 802.15.4g specification
- RF frequency range: 863 to 928 MHz
- Modulation method: 2FSK/GFSK, 4FSK/GFSK
- Data rate: 10 to 300 kbps for 2FSK/GFSK, 200/400 kbps for 4FSK/GFSK
- Forward error correction (FEC) function
- RF reception current: 6.9 mA (typ.) at 3.0 V, 100 Kbps, 2FSK/MCU block stop mode
- RF transmission current: 21 mA (typ.) at 3.0 V, 100 Kbps, 2FSK, +10 dBm/MCU block stop mode; 36 mA (typ.) at 3.0 V, 100 Kbps, 2FSK, +13 dBm/MCU block stop mode

2-system address filtering

- Provides integrated hardware functionality to automatically distinguish two systems of communication addresses. This makes it simple to use a single chip to process communications for two networks. It also reduces the development load, since software it not needed for this processing.

- Pass-through data can be selected conditionally based of the following information in receive frames: transmission destination PAN identifier (PAN ID), transmission destination short address, or transmission extended address.

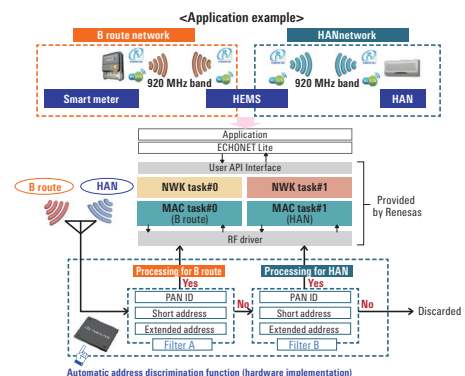

GENERAL-PURPOSE, WIRELESS

RL78/G1D

RL78/G1D features

Power-efficient low-end microcontrollers with Bluetooth® low energy

- RF with ultra-low current consumption
 - 4.3 mA during RF transmission, 3.5 mA during RF reception (using on-chip DC-DC converter, 3 V operation)
 - Average current: 9.1 µA (1-second intervals, connection maintained CC-RL compiler)
- Contributes to reduced system cost and more compact mounting board
 - Integrates circuit components necessary for antenna connection.
 - Simplifies circuit design and reduces number of external components required. Contributes to smaller mounting area and reduced product cost.
- Adaptable RF technology
 - Automatic adjustment of transmission output (transmission operating current) to match the communication distance
 - Optimization that prioritizes low current consumption at short distances and prioritizes the communication distance at long distances

Applications employing Bluetooth® low energy

Applications utilizing Bluetooth® low energy to connect wirelessly with devices such as smartphones while using little power are proliferating rapidly, and include products incorporating wireless tags, such as healthcare and fitness devices, home appliances, and beacons. Renesas provides solutions that support Bluetooth® low energy and enable reliable connections with current consumption levels among the lowest in the industry.

RL78/G1D lineup

ROM	Pins	48	
256 KB		20 K	8 K
192 KB		16 K	8 K
128 KB		12 K	8 K

■ RAM size ■ DATA flash size

2.4 GHz RF transceiver

- Compliant with Bluetooth® v4.2 low energy (Master/Slave) specification
- Reception sensitivity: -90 dBm
- Max. transmission output power: 0 dBm
- Support for wireless updates
- Software protocol stack provided at no charge

RF transmit and receive currents among the world's smallest

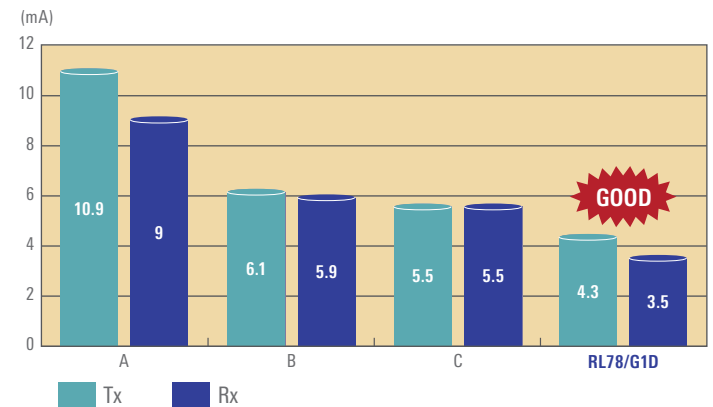

RL78/G1D specifications

- **RL78 CPU Core**
 - Three-stage pipeline CISC architecture
 - Max. operating frequency: 32MHz
- **Memory**
 - Support for 1.8 V flash programming and boot swap
 - Program Flash: 128 KB, 192 KB, 256 KB
 - SRAM: 2 KB, 6 KB, 20 KB
 - Data Flash: 8 KB
- **System**
 - High-speed on-chip oscillator: 32 MHz
 - Library support for multiply/divide and multiply-accumulate operation unit
- **RF**
 - Bluetooth® v4.2 low energy Master/Slave
 - RF unit power management
 - On-chip oscillator circuit for RF: 32.768 kHz
- **Power management**
 - Transmission current (MCU: STOP): 4.3 mA at 3 V
 - Reception current (MCU: STOP): 3.5 mA at 3 V
 - Sleep current (MCU: STOP, RF: DEEP_SLEEP): 1.4 µA
 - Stop current (MCU: STOP, RF: POWER_DOWN): 0.3 µA
- **Safety**
 - Compliant with European safety standard for household appliances (IEC/UL 60730)
 - Illegal memory access detection
- **Timers**
 - Advanced-functionality timer array unit (TAU)
 - Watchdog timer, real-time clock
- **Analog**
 - On-chip ADC, 10-bit × 8 channels, conversion time: 2.1 µs
 - Internal reference voltage (1.45 V)
- **Communication**
 - CSI × 2, UART × 2, I²C × 1, Simple I²C × 2
- **Package**
 - WQFN 6 × 6 mm 48-pin, 0.4 mm pitch

Memory Program Flash 128 KB to 256 KB SRAM 12 KB to 20 KB Data Flash 8 KB	RL78 16-bit CPU 32 MHz 43.2 DMIPS CISC Harvard Architecture 3-stage Pipeline Four Register Banks 16-bit Barrel Shifter
System DMA 4 ch Interrupt Controller 4 Levels Clock Generation OCO, External POR, LVD MUL/DIV/MAC Debug Single-Wire	Safety RAM Parity Check ADC Self-diagnostic Clock Monitoring Memory CRC
Power Management HALT RTC, DMA Enabled SNOOZE Serial, ADC Enabled STOP SRAM On	Timers Timer Array Unit 16-bit, 8 ch Interval Timer 12-bit, 1 ch WDT 17-bit RTC Calendar
Communication CSI/UART /Simplified I ² C x 1 ch CSI/ /Simplified I ² C x 1 ch UART x 1 ch 1 x I ² C Multi-Master	RF Bluetooth 4.2 Single mode Master/Slave AES Engine RF unit Power Management Resonator clock: 32 MHz Sub clock OCO: 32.768 kHz
Analog ADC 10-bit, 8 ch Internal Vref. Temp. Sensor	

RL78/G1D usage configuration examples

- It is possible to develop a modem configuration in which the RL78/G1D is controlled by the host microcontroller via a serial connection. This provides flexible support for adding wireless capabilities to applications.
- Renesas microcontroller host samples are available. By making use of a host sample, the customer can reduce the development workload.
- It is possible to develop a combined configuration that makes use of the many peripheral functions of the RL78/G1D. Power-efficient applications can be realized using the RL78/G1D alone.

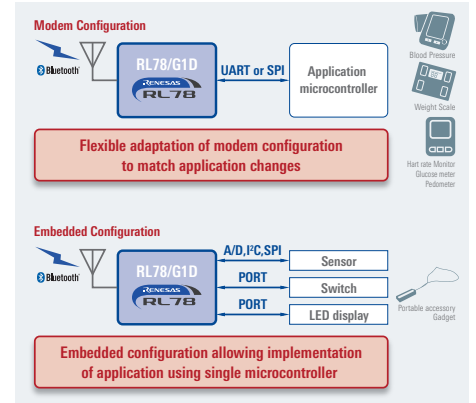

RL78/G1D module

RL78/G1D module features

Retains the many function pins of the RL78/G1D. Module is compliant with radio laws and Bluetooth® SIG.

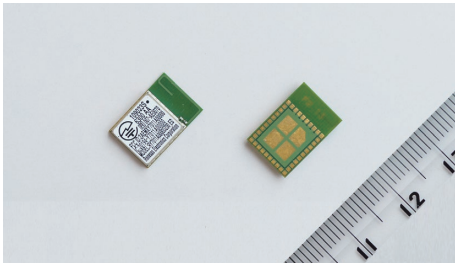

- RL78/G1D (ROM: 256 KB, RAM: 20 KB)
 - Convenient compact size (8.95 × 13.35 × 1.7)
 - 24 GPIO output pins can be used as microcontroller peripheral function pins.
 - Current consumption among the lowest in the industry
 - Certified compliant with radio laws of Japan (MIC), Europe (CE), and North America (FCC/IC)
 - Bluetooth® SIG certified*1 QD ID: 82194
- Operating voltage: 1.6 to 3.6 V*2
 Operating temperature: -25 to +75°C
 Pin count: 42 pins

Notes:

1. It is only necessary to register the final product.
2. 1.8 to 3.6 V when using on-chip DC/DC converter.

RL78/G1D module lineup

ROM	Pins	48
256 KB	20 K	8 K

■ RAM size ■ DATA flash size

Block diagram of RL78/G1D module functions

- On-chip antenna, LC for DC/DC converter, and 32 MHz crystal oscillator are ready for immediate use.
- 32.768 kHz supplied as default by on-chip oscillator.
- Lower power consumption can be achieved by using an external 32.768 kHz clock.
 - Supplied by host microcontroller
 - Supplied by an external crystal resonator (XT1 or XT2)

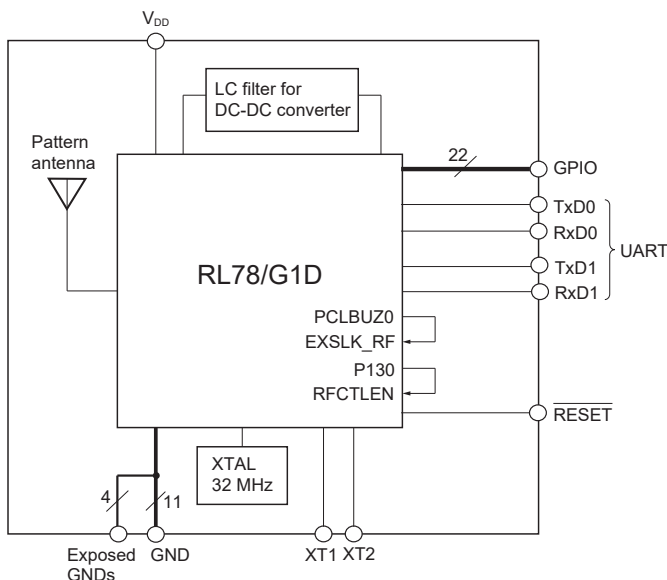

Software for checking operation

- Software is provided to check the operation of the modem configuration used for control by the host microcontroller via the UART. Multiple profiles are supported. Customers can also use Renesas custom profiles.
- The RL78/G1D module can be used in a combined configuration that makes use of the many peripheral functions of the RL78/G1D. The module provides a good balance between size and the number of function pins, making it easy to use in a combined configuration.

Supported profiles

- ◆ Bluetooth® SIG standard profiles
 - Proximity
 - Heart Rate
 - Alert Notification
 - Health Thermometer
 - Glucose
 - Find Me
 - Time
 - Running Speed and Cadence
 - Blood Pressure
 - Phone Alert Status
- ◆ Custom profiles
 - General-purpose bidirectional communication
 - Firmware Update

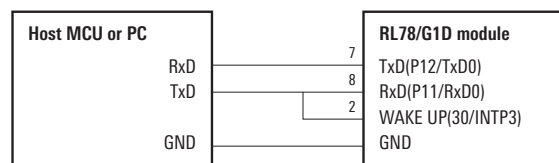

Connections to the host microcontroller use UART 2-wire branch connection.

GENERAL-PURPOSE, MOTOR

RL78/G1F

RL78/G1F features

Peripheral functions and flexibility have been improved while retaining the same ROM sizes as the RL78/G14. In particular, analog functions have been strengthened, and the on-chip functions are ideal for motor control.

- Main improvements to peripheral functions compared with RL78/G14
 - Rotor position detection for high torque
 - Programmable-gain amplifier (PGA)
 - High slew rate of 3.0 V/μs (min.) (VDD ≥ 4.0 V)
 - 2-channel comparator (CMP0 and CMP1)
 - Fast response time of 70 ns (typ.) (1/8 that of RL78/G14)
 - D/A converter (1 or 2 channels)
 - IrDA communication function
 - Debug functions including real-time trace

Safety		RL78 16-bit CPU Core 32 MHz 51.2 DMIPS	
RAM Parity Check	ADC Self-diagnostic	MUL/DIV/MAC Instruction	
Clock Monitoring	Memory CRC	Four Register Banks	
I/O Port Read back		16-bit Barrel Shifter	
Timers		Memory	Power Management
Timer Array Unit 16-bit, 4 ch	Timer RD 16-bit, 2 ch	Program Flash up to 64 KB	HALT RTC, DTC Enabled
Timer RG 16-bit, 1 ch	Timer RJ 16-bit, 1 ch	SRAM 5.5 KB	SNOOZE Serial, ADC Enabled
Interval Timer 12-bit, 1 ch	WDT 17-bit, 1 ch	Data Flash 4 KB	STOP SRAM On
RTC Calendar	Timer RX 16-bit, 1 ch		
Communication		Analog	
6 x I ² C Master	1 x I ² C Multi-Master	ADC 10-bit, 17 ch	Internal Vref
6 x CSI/SPI 7-, 8-bit	3 x UART 7-, 8-, 9-bit	Temp. Sensor	DAC 8-bit, 2 ch
1 x LIN 1 ch	IrDA	Comparator	Input Selectable Comparator
			PGA
System			
DTC 33 sources	Clock Generation Internal, External Sub-clock	ELC 22 events	
Interrupt Controller 4 levels	POR, LVD	Debug w/ trace Single-Wire	

Motor control functions of the RL78/G1F

- 120-degree conducting control for sensor-less brushless DC motors
 - On-chip 4-input-selectable high-speed comparator (CMP1) and timer RX for rotor position detection without the use of sensors
 - Enables detection of the rotor position when stopped and during high-speed rotation.
- Overcurrent detection and forced cutoff of PWM output
 - On-chip high-speed PGA for overcurrent detection + high-speed comparator (CMP0) and control output signal forced cutoff function (PWMOPA)
 - Supports quick detection of overcurrent conditions and immediate cutoff of PWM output.

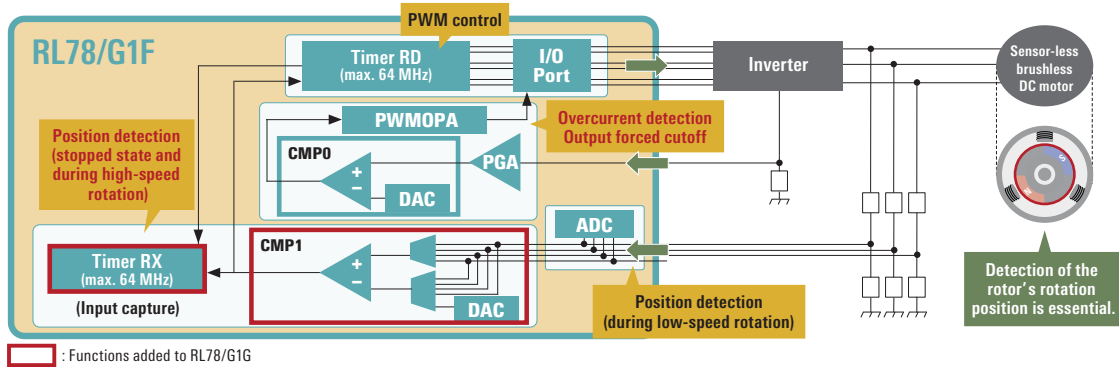

Programmable-gain amplifier (PGA) for boosting sensor signals

The amplification factor for boosting very small signals is selectable among ×4, ×8, ×16, and ×32. The slew rate ranges from a minimum of 3.0 V/μsec. (3.5 V/μsec. (min.) at other than ×32 V (VDD ≥ 4.0 V)). The dedicated GND input (PGAGND pin) ensures that amplification is not affected by internal noise.

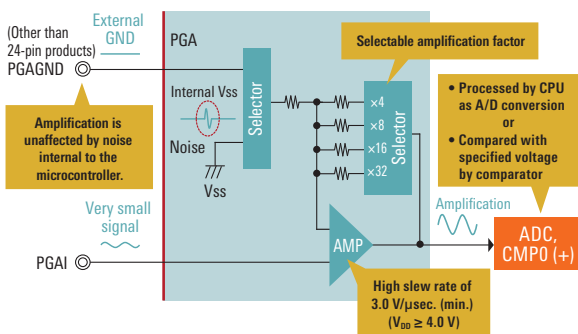

36-pin LGA package (4 × 4 mm) suitable for mobile devices

- Some functions support separate power supplies on 36-pin and 64-pin products. By providing separate power supplies (VDD and EVDD) it is possible to perform communication with an SoC, etc., at low voltage with running the CPU at high speed.
- The 36-pin products allow use of a 32.768 kHz subsystem clock oscillator (XT1) despite low pin count.

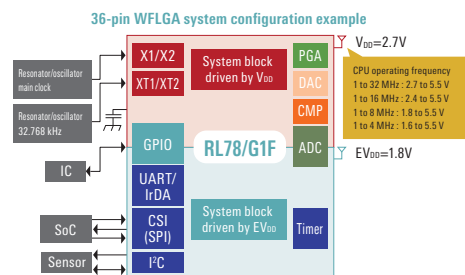

RL78/G1G Consumer applications only

Ideal for DC brushless motor applications

Support for power-efficient maintenance-free motor operation



		RL78/G1G
Motor control timer	Three-phase complementary PWM	6 channels (48 MHz operation supported)
	Forced shutoff	Supported (Hi-Z, H/L output settings supported)
Overcurrent detection	Programmable-gain amplifier	1 channel (on-chip amplifying resistor)
	Comparator	2 channels (response time: 0.15 μs [max.])
	Comparator reference voltage	8-bit DAC or internal reference voltage of 1.45 V

Application example: Three-phase synchronous PWM support and overcurrent detection circuit for reduced system cost

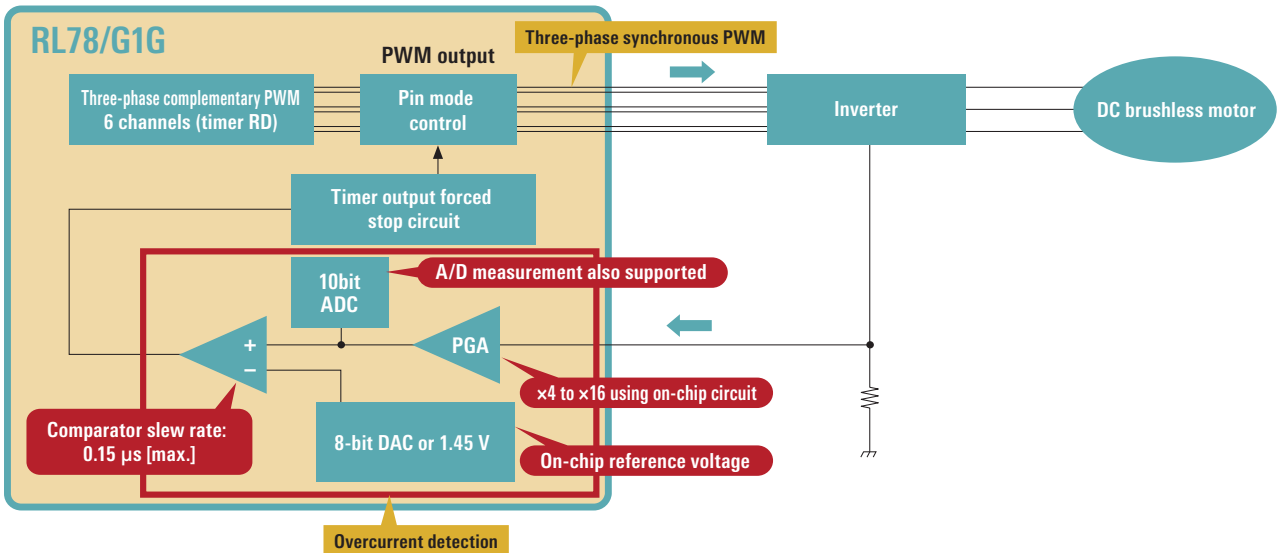

Lineup of products with low pin count and small ROM capacity

LQFP with 0.8 mm pin pitch for easy mounting using flow soldering

ROM \ Pins	30	32	44
16 K	1.5 KB	1.5 KB	1.5 KB
8 K	1.5 KB	1.5 KB	1.5 KB

RAM size Note: The RL/G1G is not equipped with data flash.

Other functions

- Operating current : 75 μA/MHz
- STOP current : 240 nA (SRAM contents retained)
- On-chip oscillator : 24 MHz ±2% (Ta = -40 to +85°C) (48 MHz supply by timer RD for motor control supported)
- Compliant with European safety standard for household appliances (IEC/UL 60730)

Memory Program Flash 8 KB / 16 KB SRAM 1.5 KB	RL78 16-bit CPU 24 MHz 38.4 DMIPS CISC Harvard Architecture 3-stage Pipeline Four Register Banks 16-bit Barrel Shifter
System Event Link Controller Interrupt Controller 4 Levels Clock Generation Internal, External POR, LVD Debug Single-Wire	Safety RAM Parity Check ADC Self-diagnostic Clock Monitoring Memory CRC
Power Management HALT SNOOZE Serial, ADC Enabled STOP SRAM On	Analog ADC 10-bit, 8 ch/12 ch Internal Vref. Comparator 2 ch PGA 1 ch
Timers Timer Array Unit 16-bit, 4 ch Timer RD 16-bit, 2 ch Timer RJ 16-bit, 1 ch Interval Timer 12-bit, 1 ch WDT 17-bit, 1 ch	Communication 2 x UART 1 x CSI (slave select) 1 x Simple PC

GENERAL-PURPOSE, USB

Common to RL78/G1C and RL78/L1C

Low-end USB microcontroller roadmap

RL78 Series next-generation low-end USB microcontrollers

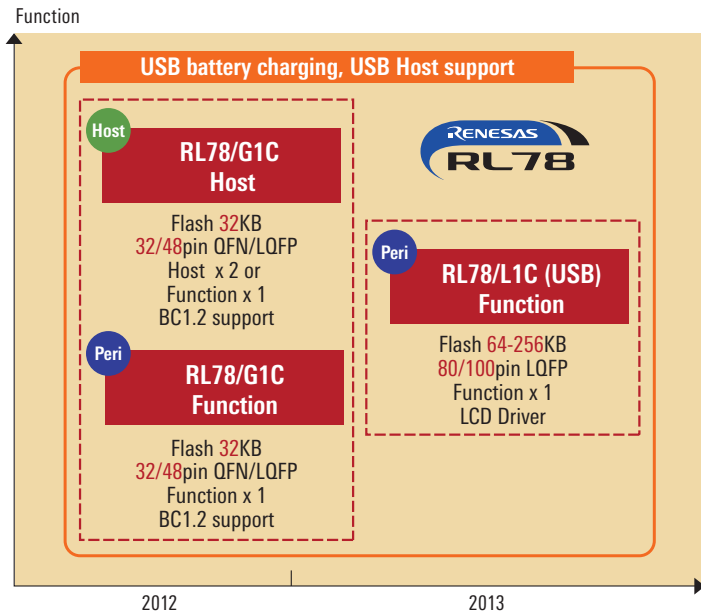

Product lineup

ROM	Pins		32	48	80	100
256 KB					16 K	16 K
192 KB					16 K	16 K
128 KB					12 K	12 K
96 KB					10 K	10 K
64 KB					8 K	8 K
32 KB	5.5 K	5.5 K	5.5 K	5.5 K		

RL78/G1C : ■ 1 x only Function ■ 2 x Host or 1 x Function

RL78/L1C : ■ 1 x only Function

USB features (low power consumption)

Operating current among world's lowest

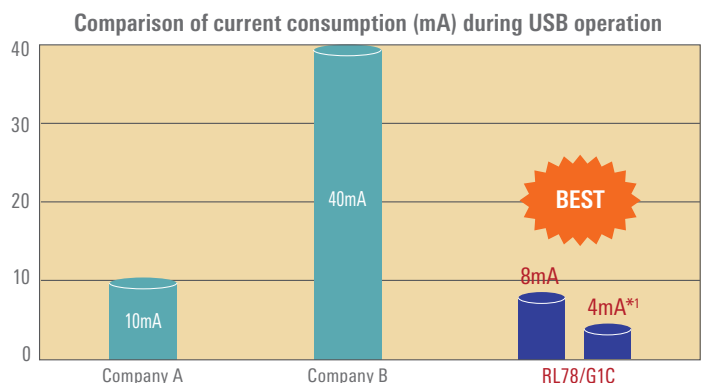

RL78/G1C

RL78/G1C (USB)

World's first low-end microcontroller with support for USB Battery Charging Specification, Revision 1.2 (BC1.2)

- Support for fast charging and power supply control in addition to USB communication
Ability to charge up to 1.5 A using BC1.2 (0.5 A for USB 2.0)
- Low power consumption during USB operation
Approx. 65% reduction compared with 78K0R, approx. 20% reduction compared with R8C
- Host × 2 channels, Function × 1 channel
Suitable for a broad range of applications

Necessary Functions	Target Applications
BC function	Mobile batteries USB chargers
Host functionality	Vending machines
	Printer
	DVD player
	Smartphone peripheral accessories
Function functionality	Health devices
	Measuring devices
	USB memory
	Mouse / keyboard
	Handheld terminals
	Barcode readers
	UPS



RL78/L1C

RL78/L1C features

- 100-pin LCD microcontroller with large-capacity ROM
 - ROM: 256 KB, RAM: 16 KB (max.)
→ Suitable for applications with advanced functionality
- Low-power LCD microcontroller retaining the features of the RL78 microcontroller family
High-performance 16-bit CPU
Low power consumption (particularly low LCD drive current due to divided allocation of LCD capacity)
Safety functions (compliant with European safety standard for household appliances)
- High-resolution ADC
 - 12-bit ADC to support high-precision sensing
→ Suitable for sensor measuring devices for consumer and industrial applications
- Full complement of communication functions
 - Compliant with Battery Charging Specification, Revision 1.2 (BC1.2) for USB peripherals
→ Ability to rapidly charge secondary batteries
 - Variety of serial interface functions
CSI/UART/Simple I²C × 4
I²C(Multi-Master) × 1
USB Peripheral × 1

RL78/G1C

Overview of USB controller specifications

USB Host and USB BC1.2 support

		RL78/G1C	Reference
USB2.0	Function	1 channel	
	Host	2 channels	Host version only
Transfer speed	LS(1.5Mbps)	○	Host/Function
	FS(12Mbps)	○	Host/Function
	HS(480Mbps)	—	Not supported
Transfer mode	Control	○	FIFO 64 bytes
	Bulk	○	FIFO 64 × 2 bytes, double buffering
	Interrupt	○	FIFO 64 bytes
	Isochronous	—	
On-chip resistors		○	D+ and D– lines, pull-up and pull-down resistors
Supported battery charging classes		○	Support for Host and Function
On-chip PLL		○	External resonator → 48 MHz generation

USB sample firmware

USB sample firmware is available free of charge. This simplifies system development and reduces the amount of time required.

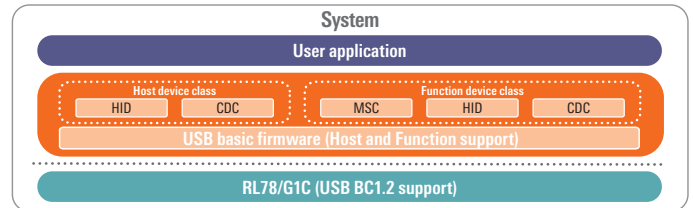

Free sample software (firmware)

Note: BC1.2 detection control functionality is implemented for all device classes.

All application notes are available for download on the Renesas website

USB sample firmware

USB function	Title	Rev	Memory size[kByte]	
			ROM*1	RAM*2
Host	Basic firmware	2.15	15.0 KB	2.7 KB
	HID (Human Interface Device Class)		14.7 KB	1.9 KB
	CDC (Communication Device Class)		16.1 KB	1.8 KB
Peripheral	Basic firmware		10.9 KB	1.4 KB
	HID (Human Interface Device Class)		10.5 KB	0.8 KB
	CDC (Communication Device Class)		10.5 KB	1.0 KB
AOA	MSC (Mass Storage Class)*2		13.7 KB	2.4 KB
	USB Host Android Open Accessory		15.7 KB	1.6 KB
Downloader	USB Peripheral Firmware Update		5.8 KB	0.5 KB

Notes: 1. ROM and RAM sizes for CC-RL (V2.05) environment, and ROM and RAM sizes for all Device Classes include size of Basic driver. 2. EEPROM devices used as media.

RL78/L1C

Overview of USB battery charging standards

Standards designed to enable rapid battery charging

Current max. value

USB 2.0 standard → 500mA

BC1.2 standard → 1500mA

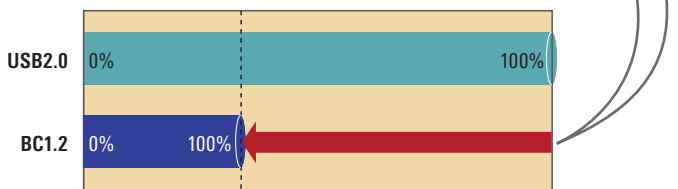

Note: Calculated value

USB battery charging application example

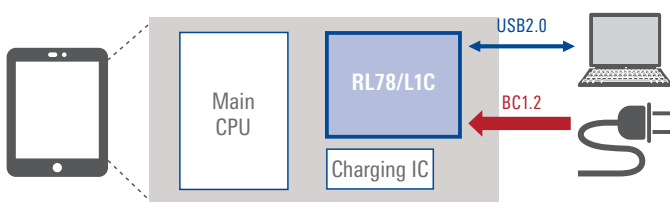

Data communication possible during USB battery charging

USB sample firmware

USB sample firmware is available free of charge. This simplifies system development and reduces the amount of time required.

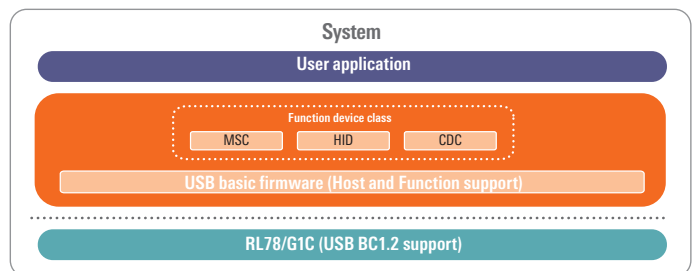

Free sample software (firmware)

Note: BC1.2 detection control functionality is implemented for all device classes.

All application notes are available for download on the Renesas website

USB sample firmware

USB function	Title	Rev	Memory size[kByte]	
			ROM*1	RAM*2
Peripheral	Basic firmware	2.15	10.9 KB	1.4 KB
	HID (Human Interface Device Class)		10.5 KB	0.8 KB
	CDC (Communication Device Class)		10.5 KB	1.0 KB
	MSC (Mass Storage Class)*2		13.7 KB	2.4 KB
Downloader	USB Peripheral Firmware Update	5.8 KB	0.5 KB	

Notes: 1. ROM and RAM sizes for CC-RL (V2.05) environment, and ROM and RAM sizes for all Device Classes include size of Basic driver. 2. EEPROM devices used as media.

GENERAL-PURPOSE, 8-bit

RL78/G1M

RL78/G1M features

- 8-bit Core
- Max. Operating Freq. 5 MHz@2.0~5.5 V/ 20 MHz@2.7~5.5 V
- Small Pin Count (20pin TSSOP), Small ROM(4 KB or 8 KB)
- Realtime Output for Motor Control
- 120-degree energization control (can drive BLDC Motor)

RL78/G1M lineup

ROM	Pins	20
8 K		1 KB
4 K		512 B

RAM size

Memory	RL78 CPU 20 MHz Operation
Program Flash 4 KB, 8 KB	CISC Harvard Architecture 3-stage Pipeline
SRAM 512 B, 1 KB	20 MHz@2.7 V to 5.5 V, 5 MHz@2.0 V* to 5.5 V
	Voltage range: 2.0 V* to 5.5 V
System	
Interrupt Controller 4 Levels	
Clock Generation Internal	
SPOR (Selectable Power On Reset)	
On-Chip Debugging	
Power Management	
HALT	
STOP SRAM On	
Safety	
TRAP function	
Analog	
ADC 8/10-bit, 8 ch	
Timers	
Timer Array Unit 16-bit, 4 ch	
Interval Timer 12-bit, 1 ch	
WDT	
Real Time Output 8 ch	
Communication	
UART 1 ch	
CSI 1 ch	

* Use this product within the voltage range from 2.25 to 5.5 V because the detection voltage (VSPOR) of the selectable power-on-reset (SPOR) circuit should also be considered.

GENERAL-PURPOSE, 8-bit

RL78/G1N

RL78/G1N features

- 8-bit Core
- Max. Operating Freq. 5 MHz@2.0~5.5 V/ 20 MHz@2.7~5.5 V
- Small Pin Count (20pin TSSOP), Small ROM(4 KB or 8 KB)
- High Current Output for LED Display
(COM 6 ch; 120 mA (duty; 45%), SEG 8 ch; 15 mA)
(can directly drive super luminosity LED, 8-seg × 6-digit)

RL78/G1N lineup

ROM	Pins	20
8 K		1 KB
4 K		512 B

RAM size

Memory	RL78 CPU 20 MHz Operation
Program Flash 4 KB, 8 KB	CISC Harvard Architecture 3-stage Pipeline
SRAM 512 B, 1 KB	20 MHz@2.7 V to 5.5 V, 5 MHz@2.0 V* to 5.5 V
	Voltage range: 2.0 V* to 5.5 V
System	
Interrupt Controller 4 Levels	
Clock Generation Internal	
SPOR (Selectable Power On Reset)	
On-Chip Debugging	
Power Management	
HALT	
STOP SRAM On	
Safety	
TRAP function	
Analog	
ADC 8/10-bit, 8 ch	
High Current Output for LED Display	
COM: 6 ch SEG: 8 ch	
Timers	
Timer Array Unit 16-bit, 4 ch	
Interval Timer 12-bit, 1 ch	
WDT	
Communication	
UART 1 ch	
CSI 1 ch	

* Use this product within the voltage range from 2.25 to 5.5 V because the detection voltage (VSPOR) of the selectable power-on-reset (SPOR) circuit should also be considered.

LOW-PIN-COUNT, ANALOG

RL78/G1P

RL78/G1P features

- Max. Operation Freq. 32 MHz@2.7~3.6 V
- Small Pin Count (24pin QFN, 32pin QFP)
- Small ROM (16 KB)
- High-Function Analog (12-bit A/D, 10-bit D/A*)

* Only among General RL78

RL78/G1P lineup

ROM	Pins	24	32
16 K		1.5 K	2 KB
		2 KB	1.5 K
			2 KB

RAM size DATA flash size

Memory	RL78 16-bit CPU 32 MHz 43.2DMIPS
Program Flash 16 KB	CISC Harvard Architecture 3-stage Pipeline
SRAM 1.5 KB	Four Register Banks
Data Flash 2 KB	16-bit Barrel Shifter
System	
DMA 2 ch	
Interrupt Controller 4 Levels	
Clock Generation Internal, External	
POR, LVD	
MUL / DIV / MAC	
Debug Single-Wire	
Power Management	
HALT DMA Enabled	
SNOOZE Serial, ADC Enabled	
STOP SRAM On	
Safety	
RAM Parity Check	
ADC Self-diagnostic	
Clock Monitoring	
Memory CRC	
Analog	
ADC 12-bit, 6 ch/8 ch	
Internal Vref.	
DAC 10-bit, 2 ch	
Timers	
Timer Array Unit 16-bit, 16 ch	
WDT 17-bit, 1 ch	
Communication	
UART 1 ch	
CSI 1 ch	
IIC 1 ch (2 slave address)	

LCD

RL78/L12, L13, L1C

LCD microcontroller product roadmap

New successor products combining the features of earlier LCD microcontrollers

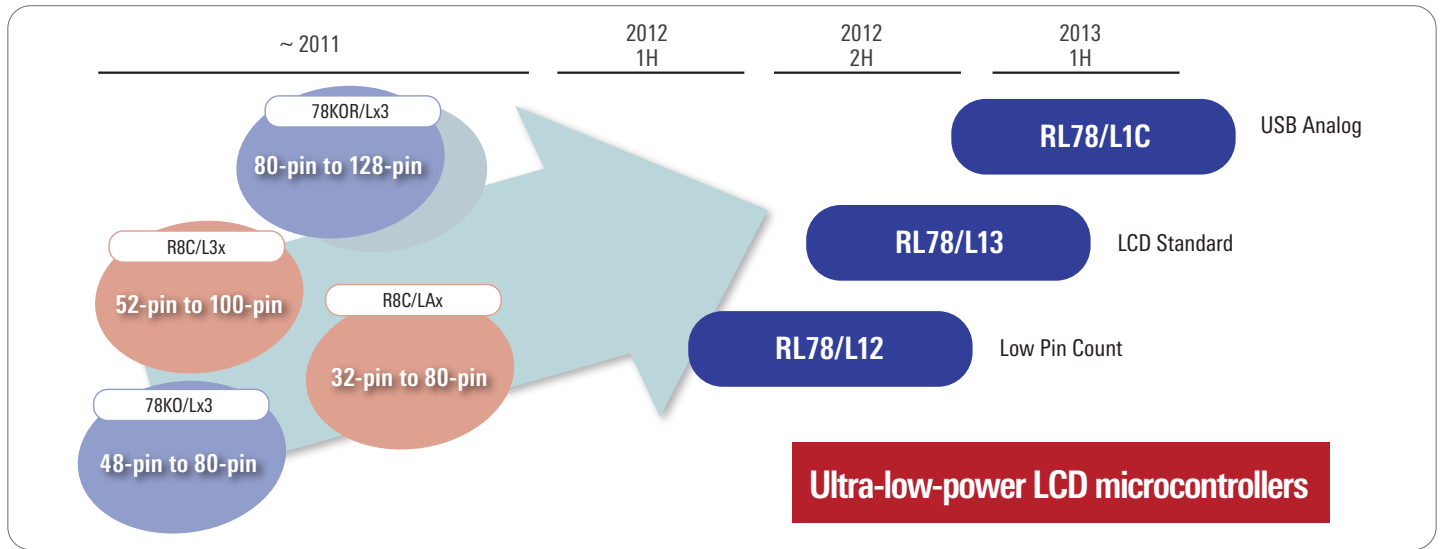

RL78/L12, RL78/L13, and RL78/L1C product concept

Low-power LCD driver

- Capacitor split type for generating LCD drive voltage
- **89% reduction** in current consumption compared with previous product
Particularly large reduction in LCD drive current

Support for many segment LCD panel types

- **Resistance division type** suitable for large panels
- **Voltage boost type** suitable for battery powered systems
- **Capacitor split type** suitable for very small currents

Return of panels with very large segment counts

- Max. display segment count: 416

		L12	L13	L1C
Healthcare	Blood pressure meters	✓	✓	✓
	Composition meters		✓	✓
	Blood glucose meter			✓
	Pedometers	✓	✓	✓
	Thermometers	✓		
Electric household appliances	Rice cookers		✓	
	Microwave ovens	✓	✓	✓
	Hot water pots		✓	
Compact electric household appliances	LCD remote controls	✓	✓	
	Hot water heaters		✓	
	Telephones	✓	✓	
Measuring devices	Kitchen tools		✓	
	Temperature controllers		✓	✓
	Sensor modules			✓
	Flow meter			✓



RL78/L12, L13, L1C Product lineup

ROM	Pins	32	44	48	52	64	80	100
256 KB							16 K	16 K
192 KB							16 K	16 K
128 KB						8 K	12 K	12 K
96 KB						6 K	10 K	10 K
64 KB						4 K	8 K	8 K
48 KB						2 K		
32 KB		1.5 K	1.5 K	1.5 K	1.5 K	1.5 K	1.5 K	
16 KB		1 K	1 K	1 K	1 K	1 K	1 K	
8 K		1 K	1 K	1 K	1 K			

RAM RL78/L12 : 32-pin - 64-pin

RAM RL78/L13 : 64-pin - 80-pin

RAM RL78/L1C : 80-pin - 100-pin

LCD display seg × com lineup

At each pin count the new products support higher segment counts than earlier products.

Seg count (K com)	Pins		32	48	52	64	80	100	128	
50 or more							51	56	56	54
45 - 49							48			
40 - 44							40	40		
35 - 39						39		40		
30 - 34				30	32	32	32	31	32	
25 - 29		26		24						
20 - 24		22	24	24						
15 - 19										
9 - 14	13	9								

■ RL78/L1x ■ 78K0R/Lx3 ■ 78K0/Lx3 ■ R8C/L3xx ■ R8C/LAxx









Ultra-low standby current consumption (clock counter + LCD display)

Capacitor split provides extremely low current consumption when driving LCD panels.

		Renesas RL78/L1x	Company A	Company B	Company C	Company D
Current during LCD drive*	Resistance division method*2	11.6 μA (typ.)	11.7 μA (@2.2 V)	Not implemented	12.0 μA (@1.8 V)	Not implemented
	Capacitor split method	7.35 μA (typ.)	Not implemented	Not implemented	Not implemented	Not implemented
	Voltage boost method	21.19 μA (typ.)	24.5 μA	22.9 μA	Not implemented	23.7 μA

Notes: 1. Current value including sub-oscillator, RTC operation, LCD operation and current flow to LCD panel. The calculation assumes an LCD panel drive current of 10 μA when using the resistance division method. (The value differs depending on the drive method.)
 2. Calculated using an external resistance value of 1,000 kΩ for the external resistance division method.

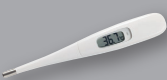
Supports the three typically used LCD drive methods. Enables LCD circuits with ultra-low power consumption.

		Features/anticipated applications				
Resistance division method	<p>For heavy-duty LCD/AC power supply applications</p> <p>Using resistance division to generate the drive voltage achieves high LCD drive capacity at low cost. External resistors are used for voltage division to generate the LCD drive voltage. The ability to input an external voltage means that external resistors and capacitors can be used to adjust the operating current and drive capacity.</p>	<p>High Good</p> <p>Suitable for large LCD panels</p>	<p>Standard</p> <p>10.4 μA[typ.]*1</p>	<p>Dependent on VDD</p> <p>Display dims as power supply voltage drops.</p>	 <p>Microwave ovens</p>  <p>Washing machines</p>  <p>Rice cookers</p>	
	<p>For battery-powered applications</p> <p>The operating current is small and the drive voltage remains constant even when the battery voltage drops, so there is no dimming of the LCD display. The reference voltage is generated internally, and external capacitors are used to boost the voltage. The reference voltage can be adjusted by software in order to modify the LCD contrast. (On the RL78/L12, 18 setting steps are supported.)</p>	<p>Standard</p>	<p>Small current Good</p> <p>0.63μA[typ.]*</p>	<p>Constant Good</p> <p>No change when power supply voltage from battery, etc., drops, so no dimming of display.</p>	 <p>Kitchen tools</p>  <p>Composition meters</p>  <p>LCD remote controls</p>	
Capacitor split method	<p>For battery-powered applications</p> <p>This method uses the smallest operating current. The LCD display dims when the battery voltage drops. It can be used without modification in cases where the aim is to dim the display according to the remaining battery capacity. To prevent the display from dimming as the battery voltage drops, the system can switch to the internal voltage boost method when the battery voltage is low. It is also possible to use the internal voltage boost method with the capacitor split method implemented in an external circuit.</p>	<p>High Good</p>	<p>Very small current Very Good</p> <p>0.12μA[typ.]*1</p>	<p>Dependent on VDD</p> <p>Display dims as power supply voltage drops.</p>	 <p>Thermometers</p>  <p>Activity meters</p>	

Note: 1. Drive voltage: 3 V, 1/3 bias, external resistance value: 1,000 kΩ, no LCD panel connected

LCD, ANALOG

RL78/L1A

RL78/L1A features

On-chip analog functions, low current consumption, low-voltage analog, on-chip LCD driver

This power-efficient 16-bit LCD microcontroller is ideal for use in portable healthcare devices such as blood glucose meter.

World-top-class power efficiency

- Current consumption during operation: 66 μ A/MHz
- In RTC mode: 1 μ A or less

Notable analog functions

- On-chip 12-bit ADC and 12-bit DAC that maintain consistent accuracy up to 2.0 V
- Rail-to-rail op-amp with analog switch

RL78/L1A specifications

- **RL78 CPU Core**
 - Three-stage pipeline CISC architecture
 - Max. operating frequency: 24MHz
- **Memory**
 - Support for 1.8 V flash programming and boot swap
 - Program Flash: 48 KB–128 KB
 - SRAM: 5.5 KB
 - Data Flash: 8 KB
- **System**
 - High-speed on-chip oscillator: 24 MHz
 - Low-speed on-chip oscillator: 15 kHz
- **Power management**
 - Power-on reset (POR)
 - Low-voltage detection circuit (LVD)
 - RTC output (1 Hz) \times 1
- **Safety**
 - Compliant with European safety standard for household appliances (IEC/UL 60730)
- **Timers**
 - Advanced-functionality timer array unit (TAU)
 - Watchdog timer, real-time clock
- **Analog**
 - 12-bit ADC \times 14 channels
 - 12-bit DAC \times 2 channels
- **Communication**
 - 3 \times SCI: Simple SPI/simple I²C/UART
- **LCD**
 - 32 seg \times 4 com (80-pin)
 - 45 seg \times 4 com (100-pin)
- **Package**
 - LQFP 12 \times 12 mm 80-pin, 0.5 mm pitch
 - LQFP 14 \times 14 mm 100-pin, 0.5 mm pitch
- **RAM parity error detection function**
- **Illegal memory access detection**
- **ADC test function**

RL78/L1A lineup

ROM	Pins		80		100	
	RAM size	DATA flash size	RAM size	DATA flash size	RAM size	DATA flash size
128 K			5.5 K	8 KB	5.5 K	8 KB
96 K	5.5 K	8 KB	5.5 K	8 KB	5.5 K	8 KB
64 K	5.5 K	8 KB	5.5 K	8 KB	5.5 K	8 KB
48 K	5.5 K	8 KB				

■ RAM size ■ DATA flash size

Memory	RL78 16-bit CPU 24 MHz 38.4 DMIPS		
Program Flash up to 128 KB	CISC Harvard Architecture 3-stage Pipeline		
SRAM 5.5 KB	MUL/DIV/MAC instruction		
Data Flash 8 KB	Four Register Banks		
	16-bit Barrel Shifter		
System	Safety	Analog	Communication
DTC/ELC	RAM Parity Check	ADC 12-bit, 14 ch	I ² C Multi-Master CSI/UART/ Simplified I ² C 4 ch
Interrupt Controller 4 Levels	ADC Self-diagnostic	DAC 12-bit, 2 ch	
Clock Generation Internal, External	Clock Monitoring	Op-Amp 3 ch	Internal Vref. Temp. Sensor
POR, LVD	Memory CRC	Comparator 1 ch	
Debug Single-Wire			
Power Management	Timers		
HALT RTC, DTC Enabled	Timer Array Unit 16-bit, 8 ch		
SNOOZE Serial Enabled	Interval Timer 16-bit/8-bit, 1 ch/2 ch		
STOP SRAM On	Interval Timer 12-bit, 1 ch		
	RTC Calendar		
LCD	45 seg \times 4 com 41 seg \times 8 com	Internal Boost	Split Cap.

Analog frontend function configuration

In blood glucose meter use case

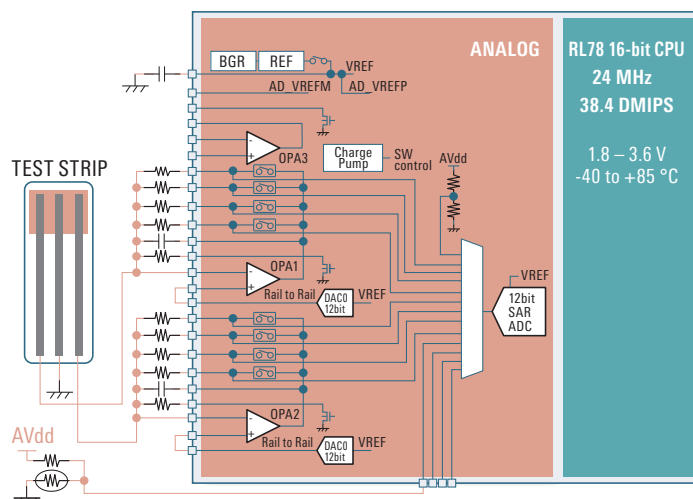

Features of analog functions

I/V conversion with transimpedance amplifier

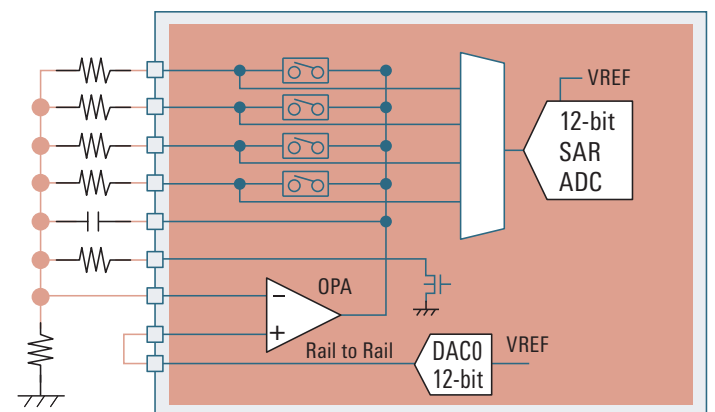

Using analog switches, you can switch among the external feedback resistors. It can be accomplished by means of software. So they help you to create a common board design for use with multiple product types.

Low-voltage operation of analog functions

Analog functions maintain accuracy while operating at 2.0 V. Low-voltage operation contributes to extended battery life.

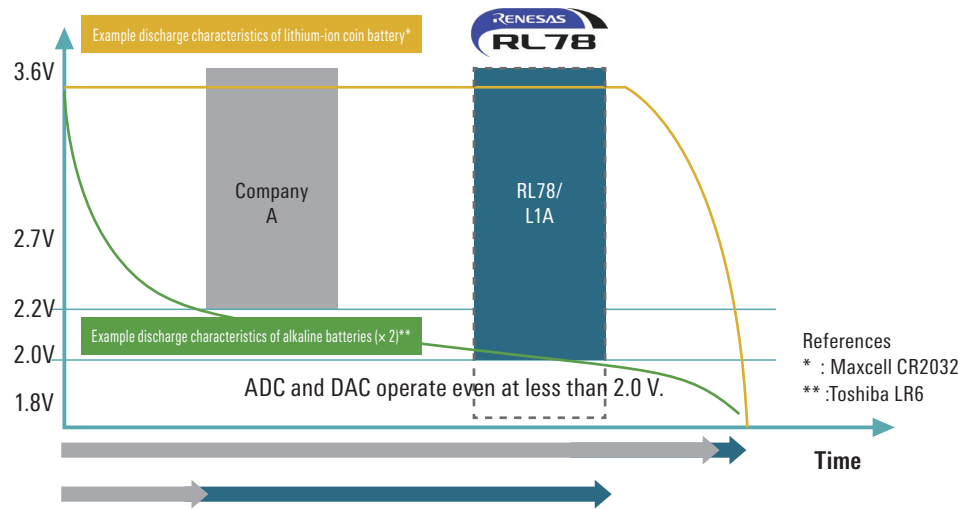

Enhanced on-chip microcontroller functions to reduce the number of system components

Peripheral functions such as AFE, main clock, and EEPROM are incorporated into the microcontroller. This reduces the number of additional components required.

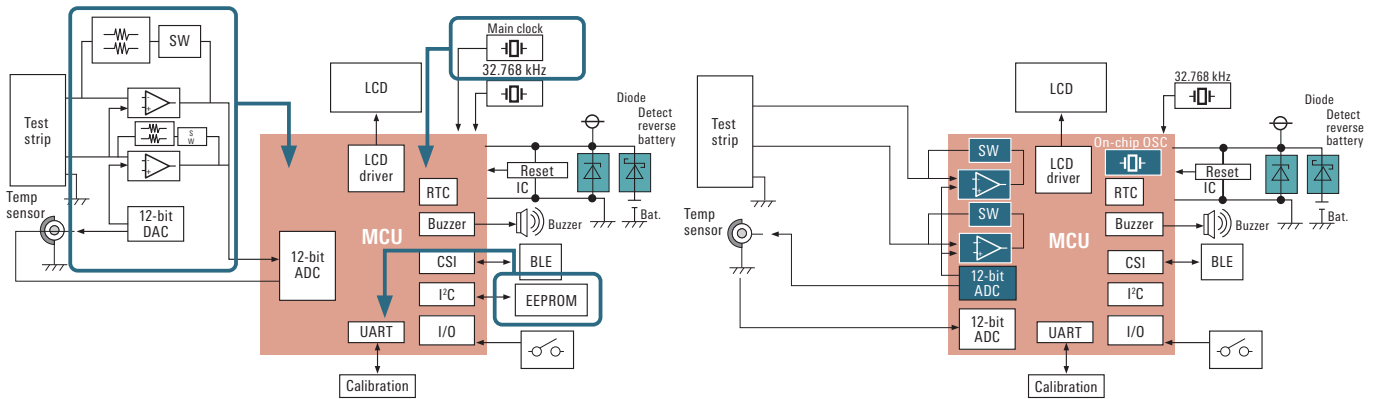

Blood glucose meter reference solution is coming soon

We plan to expand its range of reference solutions and application notes for blood glucose meter. It utilizes analog functions of RL78/L1A, such as 12-bit A/D and 12-bit D/A converters and op-amps.

ASSP, LIGHTING/POWER SUPPLY

RL78/I1A

RL78/I1A features

- Basic peripheral functions for lighting and power supply applications
 - Timers for LED control and PFC control
 - 64 MHz source clock, zero current detection, forced output stop function
 - Analog functions for feedback
 - 10-bit A/D converter (2.125 μ s. conversion), PGA, comparator
 - Support for high temperatures up to 105°C or 125°C
- Current consumption
 - LED power supply control: 3.3 mA (main operation), CPU clock: 16 MHz, timer KB clock: 64 MHz, PLL: on
 - UART (DALI) receive standby: 0.23 μ A (STOP current)
- Full complement of connectivity functions
 - Communication functions (DALI, PMBus, SMBus, DMX512, UART, I²C, CSI)
- Special peripheral functions for "intelligent" operation and improved efficiency
 - Dithering function (0.98 ns pseudo-resolution), software start function, max. frequency limit function, interleaved PFC, standby communication wait

RL78/I1A lineup

ROM	Pins	20	30	38
64 KB			4 K	4 K
32 KB		2 K	2 K	

RAM size

Operating temperature ranges up to 105°C or 125°C supported

Main applications

- LED Lighting, Lighting switches
- Digital power supplies
- Illumination fixtures
- Laser printers
- Microwave ovens
- Vacuum cleaners
- Communication devices

Advantages of RL78/I1A

Dithering function

Delivers min. average resolution of 0.98 ns.

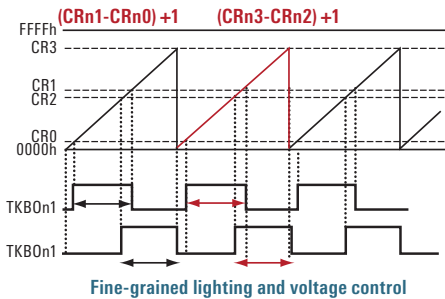

Linked operation of 16-bit timer KB and INTP comparator

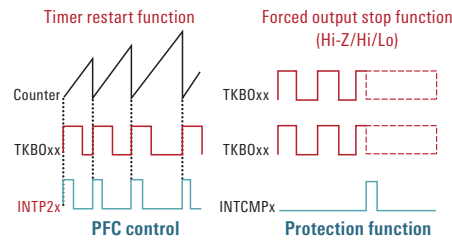

Support for multiple power supply control methods

AC/DC (PFC) control circuit	PFC control mode
Boost converter	CRM-PFC control (DCM or CCM also supported)
Flyback converter	
DC/DC control circuit	Constant-current control mode
Buck converter	Average-current control
Boost converter	Peak-current control
Flyback converter	
Half-bridge	
Full-bridge	

DALI master/slave communication functions

Manchester coding

Transmit/receive data: 8-, 16-, 17-, or 24-bit

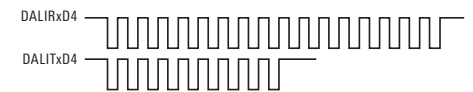

Implementation in hardware of communication functions for lighting

System configuration example: PFC control + LED constant current control

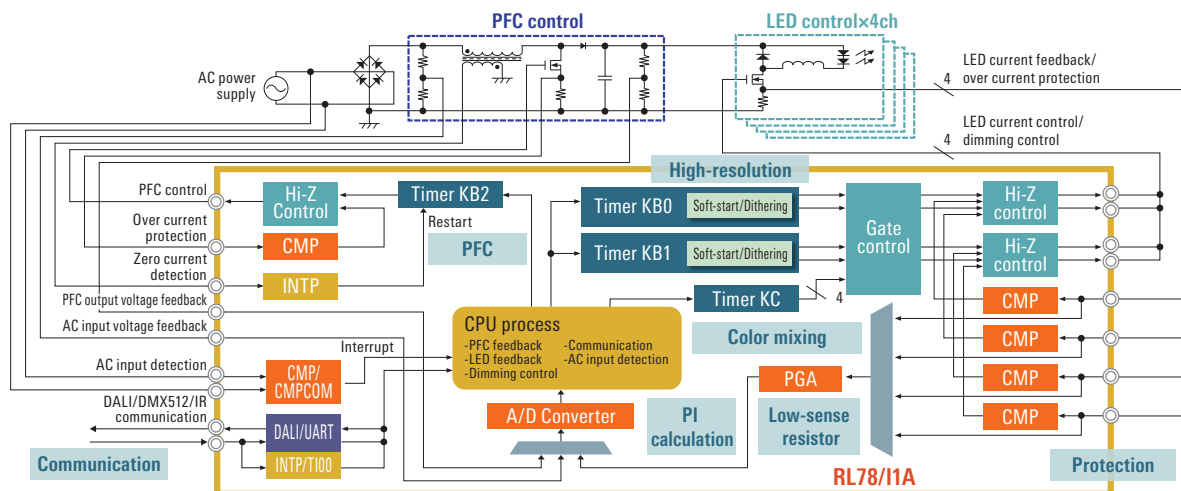

ASSP, ELECTRICITY METER

RL78/I1B

Target electricity meter markets of RL78/I1B

Electricity meter types

Wiring Type	Main Applications	Main Regions
Single-phase, two-wire	Home	Europe, China, India
Single-phase, three-wire	Home	Japan, U.S.A
Three-phase, three-wire	Commercial/industrial	Worldwide

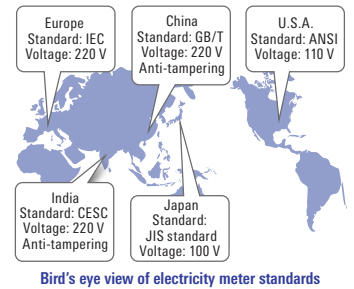
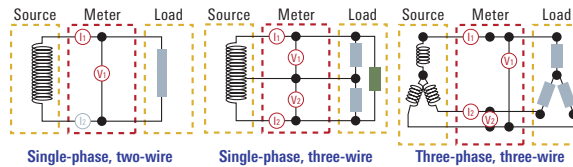

RL78/I1B lineup and concept

ROM	Pins	80	100
128 KB		8 K	8 K
64 KB		6 K	6 K

RAM size

- Product lineup to accommodate various meter types
- Four products

Aiming for low power consumption

Low power consumption among the best in its class: Power efficient during both calculations and backup operation

- Low power consumption
 - Operating current: 96 μ A/MHz
 - Standby current: 0.69 μ A (during RTC or LVD operation)
- 24-bit $\Delta\Sigma$ ADC
 - Current during ADC operation: 0.53 mA/channel

Lowest power consumption at all operating frequencies

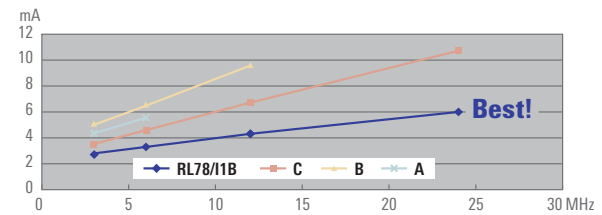

25% lower power consumption than competing products*1

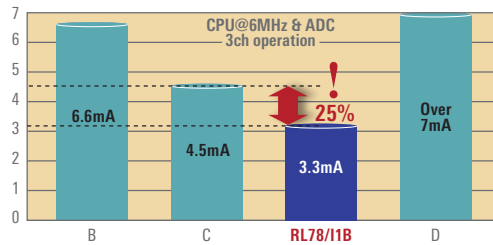

Note: 1. Based on research by Renesas

CPU Frequency (MHz)	MCU	RL78/I1B	A	B	C
		64/128 KB	Up to 32 KB	Up to 120 KB	Up to 128 KB
ADC 3-channel operation at each CPU operating frequency (MHz)	3	2.8	4.35	5.1	3.525
	6	3.3	5.55	6.6	4.595
	12	4.2	—	9.6	6.695
	24	6	—	—	10.725

$\Delta\Sigma$ ADC with improved functionality for electricity meters

Implementation in hardware of functions essential for power measurement

Phase correction circuit, high-pass filter

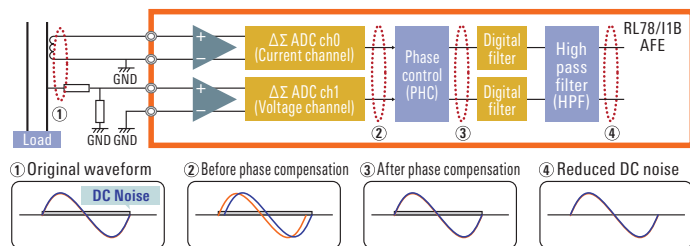

- 24-bit ADC
 - Designed for low power consumption
 - Reduced CPU operating frequency that contributes to lower power consumption (on-chip PHC and HPF)
- To further cut power consumption ...
 - Support for multiple sampling frequencies (3.906 kHz and 1.953 kHz)

High-speed on-chip oscillator with accuracy of $\pm 0.05\%$

Subclock resonator single-crystal system

Exclusive Renesas system is more robust than conventional PLL designs.

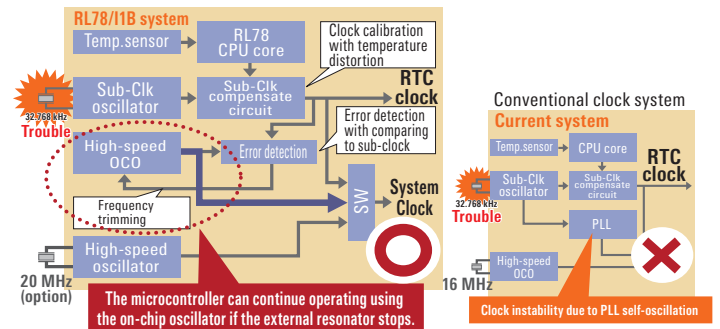

- High-precision clock: $\pm 0.05\%$ (high-speed on-chip oscillator with correction circuit)
 - Correction of on-chip oscillator by subclock (exclusive Renesas circuit)
- Safety functions: Clock system
 - High-speed on-chip oscillator maintains oscillation at $\pm 1\%$ accuracy even if external resonator stops operating.

ASSP, ELECTRICITY METER

RL78/I1C

RL78/I1C target markets

- Ideal for smart meters, including those using DLMS communication.
- Suitable for a wide variety of power platforms, from single-phase two-wire to three-phase four-wire.

RL78/I1C lineup

- Available flash memory configurations are 512 KB or 256 KB for high-end single-phase and three-phase meters, and 128 KB or 64 KB for low-end single-phase meters.
- Available package pin counts are 64, 80, and 100 pins to accommodate a variety of requirements regarding peripheral functions and mounting space.

Wiring Type	Main Applications	Main Regions
Single-phase, two-wire	Home	Europe, China, India
Single-phase, three-wire	Home	Japan, U.S.A
Three-phase, three-wire	Commercial/industrial	Worldwide
Three-phase, four-wire	Commercial/industrial Agriculture/urban housing	Worldwide

ROM \ Pins	64	80	100
512 KB (256KB × 2 bank)		32 K	32 K
256 KB		16 K	16 K
128 KB	8 K	8 K	8 K
64 KB	6 K	6 K	

■ RAM size

RL78/I1C features

- World's first Continuous Metrology FOTA* solution that solves the problem of power meter operation stopping during firmware updates
 - The RL78/I1C's bank programming and bank swapping functions and improved 32-bit multiply-accumulator enable continuous power meter operation during firmware updates.

*: Firmware update Over The Air

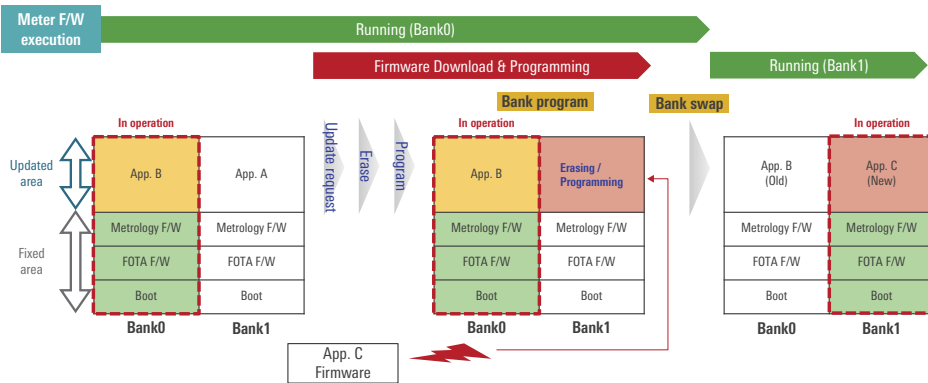

- First in the industry to implement AES GCM mode in hardware, as required by the DLMS standard.
 - Encryption and decryption are over 20 times faster than the software processing used on previous Renesas products.
- Power measurement processing and DLMS processing on a single chip.
 - Ability to handle DLMS communication while power measurement processing is taking place.
 - Approx. 30% reduction in power consumption compared with two-chip solutions combining an earlier meter microcontroller and a dedicated microcontroller for DLMS processing.
 - Contributes to the system cost reduction.
- Approx. 30% improvement in arithmetic capacity required for power calculation.
 - On-chip PLL boosts the maximum operating frequency from 24 MHz to 32 MHz.
 - 32-bit multiply-and accumulate unit dramatically reduce the software burden when performing calculations on 24-bit data converted by the 24-bit $\Delta\Sigma$ A/D converter.
- Independent power supply real-time clock
 - Current consumption of 0.7 μA (typ.) during operation
- Enhanced power supply monitoring function
 - Low-voltage monitoring of power supply pins using LVD and improved battery backup function to deliver power to the CPU and peripheral functions when power is interrupted.

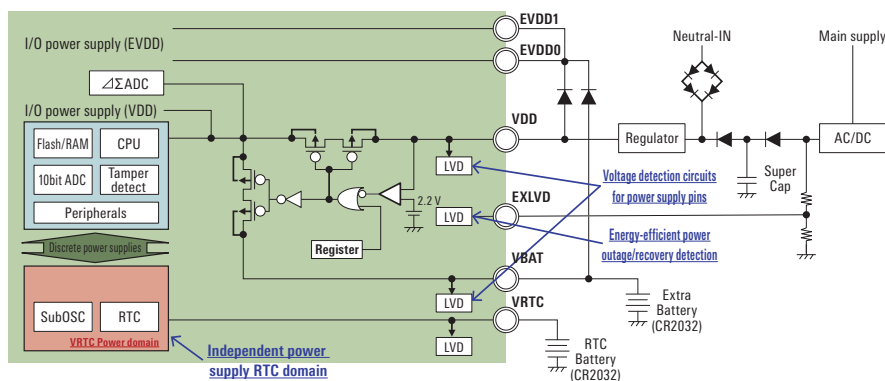

ASSP, DETECTOR/SENSOR

RL78/I1D

RL78/I1D features

- Low power consumption for extended battery life
 - High-speed recovery from STOP mode in just 3.4 μ s, and supply of operating current in 124 μ A when operating at 1 MHz.
 - Ability to operate peripheral circuits (sensor activation, signal amplification, obtaining A/D conversion results) without CPU intervention. Ability to determine whether it is necessary to activate the CPU based on A/D conversion results.
- On-chip analog functions needed for security and emergency applications
 - On-chip general-purpose op-amp, 12-bit A/D converter, and comparator

RL78/I1D lineup

ROM	Pins	20	24	30	32	48
32 KB				3 K	3 K	3 K
16 KB		2 K	2 K	2 K	2 K	2 K
8 KB		0.7 K	0.7 K	0.7 K		

RAM size

RL78/I1D specifications

- RL78 CPU Core**
 - Three-stage pipeline CISC architecture
 - Max. operating frequency: 24 MHz
 - Support for multiply, divide, and multiply-accumulate instructions
- Memory**
 - Support for 1.8 V flash programming and boot swap
 - Program flash: 8 KB–32 KB
 - SRAM: 0.7 KB–3 KB
 - Data flash: 2 KB
- System**
 - High-speed on-chip oscillator: 24 MHz \pm 1%
 - Middle-speed on-chip oscillator: 4 MHz \pm 12% (support for high-speed wakeup in 3.4 μ s)
- Power management**
 - Operating current: 58.3 μ A/MHz
 - HALT current: 0.64 μ A (RTC + LVD)
 - STOP current: 220 nA (SRAM data retained)
 - SNOOZE current: 700 μ A (UART), 500 μ A (ADC)
- Safety**
 - Compliant with European safety standard for household appliances (IEC/UL 60730)
- Timers**
 - Advanced-functionality timer array unit (TAU)
 - 8-bit interval timer (can be used as 16-bit interval timer)
 - Watchdog timer, real-time clock
- Analog**
 - 1.6 V (VDD) operation
 - On-chip ADC, 12-bit \times 17 channels, conversion time: 3.375 μ s
 - Internal reference voltage (1.8 V)
 - Op-amp \times 4 channels (high-speed and low-power modes)
 - Comparator \times 2 channels (window mode support)
- Communication**
 - CSI, UART, Simple I²C
- Package**
 - 20-pin, 24-pin, 30-pin, 32-pin, 48-pin

Memory Program Flash up to 32 KB SRAM up to 3 KB Data Flash 2 KB	RL78 16-bit CPU 24 MHz 38.4 DMIPS 34 MHz: 2.7 V to 3.6 V 4 MHz: 1.6 V to 3.6 V MUL/DIV/MAC Instruction 16-bit Barrel Shifter -40 to 105°C operation	
System DOC (Data Operation Circuit) ELC (Event Link Controller) DTC (Data Transfer Controller) OCD (Single-wire On-chip debugger) POR (Power On Reset) LVD (Low Voltage Detector) Interrupt Controller 4 Levels	Safety RAM Parity Check ADC Self-diagnostic Clock Monitoring Memory CRC I/O port Read Back	Analog ADC 12-bit, up to 17 ch Comparator 2 ch Op-Amp up to 4 ch Internal Vref. Temp. Sensor
Power Management Fast wake up 4 μ s HALT RTC, DTC Enabled SNOOZE Serial, ADC Enabled STOP SRAM On	Timers Timer Array Unit 16-bit, 4 ch (1 ch: 2 \times 8-bit) Interval Timer 12-bit, 1 ch Interval Timers 8-bit, 4 ch Window WDT 17-bit, 1 ch RTC Calendar	Communication CSI up to 2 ch UART 1 ch I ² C up to 2 ch, Master

SNOOZE mode operation example

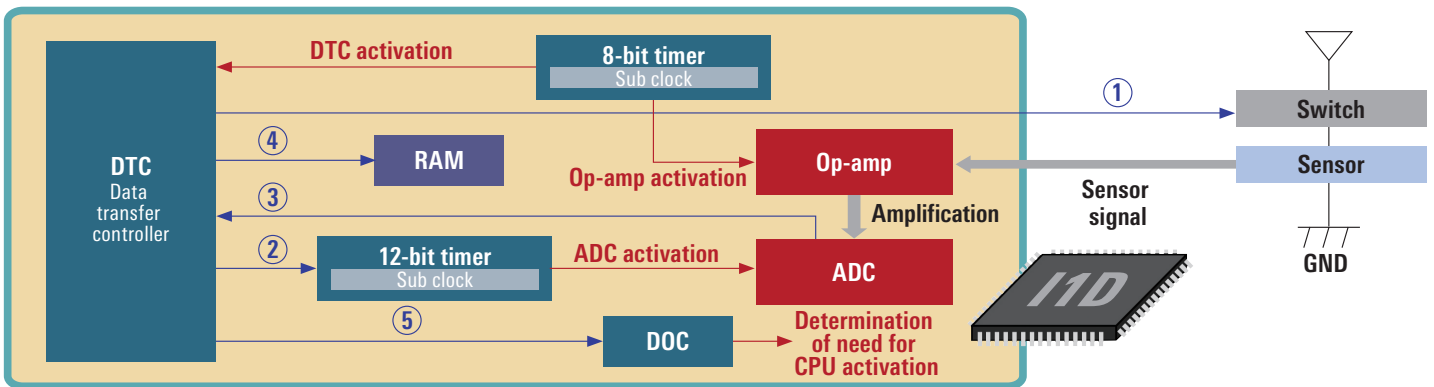

Operation procedure

- sensor activation, ②ADC activation, ③obtaining A/D conversion results,
- ④storing A/D conversion results in RAM, ⑤transmission of A/D conversion results to DOC (determination of need for CPU activation)

ASSP, ANALOG

RL78/I1E

RL78/I1E features

- High-precision analog functions
 - 24-bit $\Delta\Sigma$ A/D converter \times 4 channels
 - 10-bit SAR A/D converter \times 10 channels
 - Configurable amplifier \times 3 channels
 - 12-bit D/A converter \times 1 channel
 - Sensor power supply \times 1 channel
- Compact package
 - 4 mm square: 36-pin FBGA
 - 5 mm square: 32-pin VQFN
- Support for high temperatures
 - 40 to 105°C
 - 40 to 125°C

RL78/I1E lineup

ROM	Pins	32	36
32 KB		8 KB	8 KB

RAM Size

Memory	System	Power Management	Timers	Communication	Analog	Safety
Program Flash 32 KB	DTC 23 sources	Main OSC 1-20 MHz	Timer Array Unit 16-bit, 6 ch	2 x CSI /2 x UART /2 x Simplified I ² C (exclusive)	Delta-Sigma ADC with Instrumentation AMP 24-bit, 4 ch	CMOS In/Dut 11 ch
SRAM 8 KB	ELC 16 sources	HOCO 32 MHz/24 MHz	Timer RG 16-bit, 1 ch		SAR ADC 10-bit, 10 ch	CMOS Input 3 ch
Data Flash 4 KB	Interrupt Controller 4 Levels	LOCO 15 kHz	Timer RJ 16-bit, 1 ch		Op-Amp 3 ch	
	POR, LVD	PLL 32 MHz/24 MHz	WDT		DAC 12-bit, 1 ch	
	On-chip Debug Single-Wire		RTC		Temperature sensor	
			Interval Timer 12-bit, 1 ch		Sensor Bias	

On-chip 24-bit $\Delta\Sigma$ A/D converter

- AFE* circuits for many types of sensor measurements, including using pressure sensors, load cells, and thermocouples, integrated on a single chip.
- Ability to use common sensor power supply and ADC reference voltage, minimizing ratiometric error.

*AFE: Analog Front End

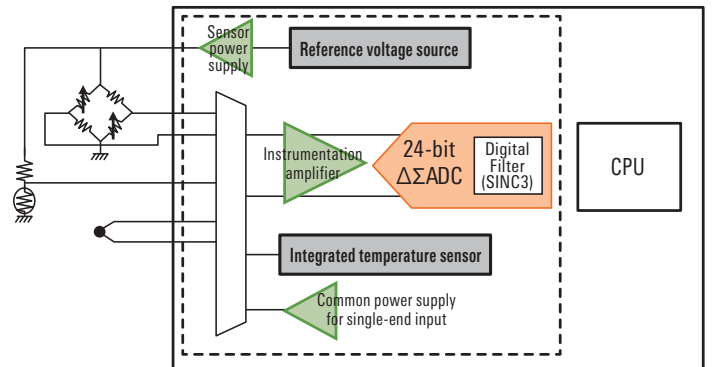

On-chip configurable amplifier

- General-purpose analog I/O ports and configurable switches enable configuration of a variety of op-amp circuits.
- Integrated peripheral analog functions

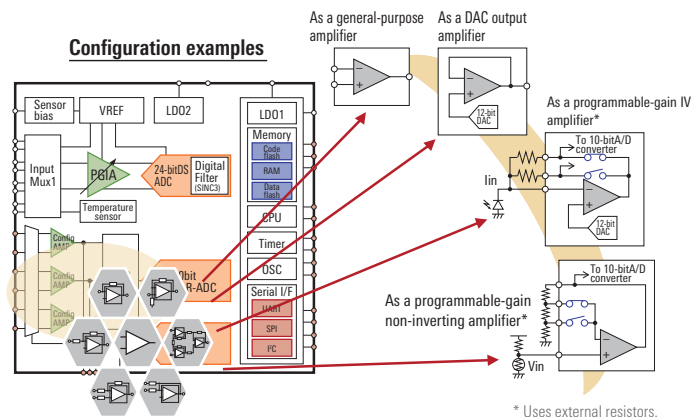

* Uses external resistors.

Code generation tool for RL78/I1E

This GUI-based tool lets you specify a variety of information and automatically generates code for analog circuit control programs.

- PGA $\Delta\Sigma$ A/D converter settings



- Configurable amplifier settings

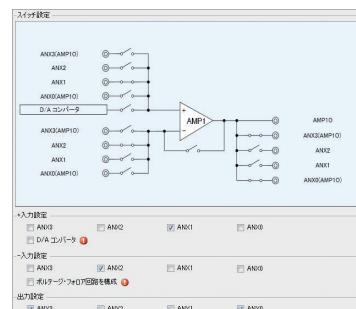

ASSP, HEALTHCARE/ELECTRICITY METER

RL78/H1D

Optimized with rich analog functions and timers, the RL78/H1D microcontroller is ideal for healthcare and flow meter applications. The RL78/H1D microcontroller includes high precision analog functions such as Delta-Sigma A/D converter, SAR A/D converter, Programmable Gain amplifiers, Operational amplifier, and 8-bit/12-bit D/A converter. It also has a built-in LCD controller/driver which makes the RL78/H1D well suited for healthcare devices, especially blood pressure monitor.

RL78/H1D features

- Rich analog functions
 - 24-bit $\Delta\Sigma$ A/D converter
 - 10-bit SAR A/D converter
 - 12-bit D/A converter
 - 8-bit D/A converter
 - OpAMP
- Timers
 - External signal sampler
 - Sampling output timer detector
- Low power LCD
- Ideal for healthcare (blood pressure monitor, body composition monitor) and flow meter applications
- Rich package lineup
 - 48-/64-/80-pin LFQFP
 - 64-pin TFBGA

RL78/H1D lineup

ROM	Pins	48		64		80	
128 KB		5.5 KB	4 KB	5.5 KB	4 KB	5.5 KB/8 KB	4 KB
96 KB		5.5 KB	4 KB	5.5 KB	4 KB	5.5 KB	4 KB
64 KB						5.5 KB	4 KB

■ RAM size ■ DATA flash size

Memory Program Flash up to 128KB SRAM 5.5KB Data Flash 4KB	RL78 16-bit CPU 24 MHz 38.4 DMIPS CISC Harvard Architecture 3-stage Pipeline Four Register Banks 16-bit Barrel Shifter
System DTC/ELC 2ch Interrupt Controller 4 Levels Clock Generation Internal, External POR, LVD MUL/DIV/MAC Debug Single-Wire	Safety RAM Parity Check ADC Self-diagnostic Clock Monitoring Memory CRC
Power Management HALT RTC, DTC Enabled SNOOZE Serial, ADC Enabled STOP SRAM On	Timers Timer Array Unit 16-bit, 8ch Interval Timer 16-bit/8-bit, 1ch/2ch WDT 17-bit, 1ch RTC Calendar
LCD 32seg x 8com	Internal Boost Capacitor Split

Analog OpAMP 1ch Internal Vref. Temp. Sensor Delta-Sigma ADC 24-bit x 2ch SAR ADC 8/10-bit x 3ch DAC 8-bit x 1ch DAC 12-bit x 1ch PGA 2ch	Communication 1 x I ² C Multi-Master 3 x CSI/UART / Simple I ² C
--	---

Analog front end function configuration

Blood pressure monitor use case (80-pin LFQFP)

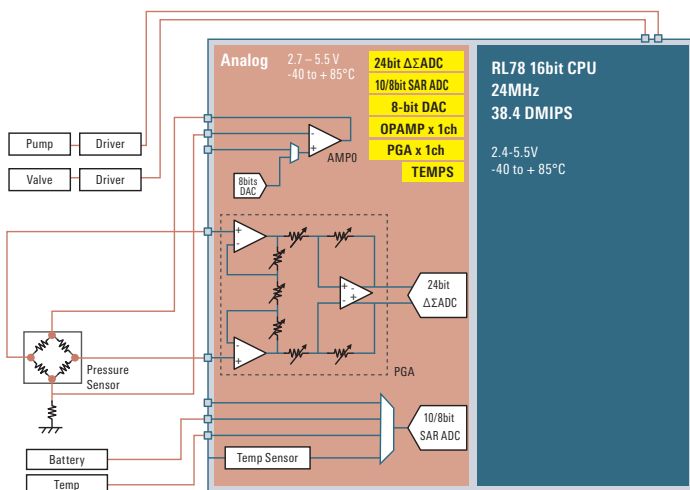

Blood Pressure Monitoring Evaluation Kit for RL78/H1D

Part Name: RTK0EH0003S02001BR

Blood Pressure Monitoring Evaluation Kit includes hardware and development tools needed to quickly and easily get started.



RL78 FAMILY FAST PROTOTYPING BOARD

Overview

The Fast Prototyping Board for RL78 Family comes equipped with an RL78 Family microcontroller and is an evaluation board specialized for prototype development for a variety of applications. It has a built-in emulator circuit that is equivalent to an E2 emulator Lite so you can write/debug programs without additional tools. In addition, with Arduino and Pmod™ interfaces included as standard and through-hole access to all pins of the microcontroller, and so on, it has high expandability.



RL78 Family Fast Prototyping Board

Features

- Equipped with an RL78 family 8/16-bit microcontroller
- No additional tools are required for program debugging/writing with the built-in emulator circuit equivalent to an E2 emulator Lite or the built-in for COM port debug circuit
- Through-holes with access to the pins of the microcontroller
- Arduino and Pmod™ interfaces come standard (some products have Arduino interface only)
- Support for various RL78 software and tools

Product lineup

Description	Orderable Part ID
RL78/G14 Fast Prototyping Board	RTK5RLG140C00000BJ
RL78/G15 Fast Prototyping Board	RTK5RLG150C00000BJ
RL78/G16 Fast Prototyping Board	RTK5RLG160C00000BJ
RL78/G1P Fast Prototyping Board	RTK5RLG1P0C00000BJ
RL78/G1M Fast Prototyping Board	RTK5RLG1M0C00000BJ
RL78/G1N Fast Prototyping Board	RTK5RLG1N0C00000BJ
RL78/G22 Fast Prototyping Board	RTK7RLG220C00000BJ
RL78/G23-64p Fast Prototyping Board	RTK7RLG230CLG000BJ
RL78/G23-128p Fast Prototyping Board	RTK7RLG230CSN000BJ
RL78/G24 Fast Prototyping Board	RTK7RLG240C00000BJ
RL78/I1C(512KB) Fast Prototyping Board	RTK5RL10N0CPL000BJ

AUTOMOTIVE

RL78/F23, F24

The RL78/F2x microcontrollers deliver the best combination between ultra-low power consumption and high performance for efficient power management of smart actuators and sensors. The newly embedded Application Accelerator Unit improves the FoC efficiency for BLDC motors. Utilize the built-in EVITA Light security hardware compliant to ISO 21434, and highly-optimized ISO 26262 ASIL B functional safety to provide a high-level of security and reliability for your development.

RL78/F23 features

- LIN products with lineup of pin counts from 32 to 80 pins and 128 KB memory
- Safety and Security support
- Expanded motor functionality
- Compatible with RL78/F13 for easy migration

RL78/F24 features

- CAN/CANFD products with lineup of pin counts from 32 to 100 pins and 256 KB memory
- Safety and Security support
- Expanded motor functionality
- Compatible with RL78/F14 for easy migration

- More advanced functionality
 - 40 MHz operation (2.7 V to 5.5 V at 105/125/150°C)
 - Enhanced Three-phase waveform output function (timer RDe)
 - Motor assist (Application accelerator unit)
 - 8 KB BGO Data flash (RL78/F23)
 - 16 KB BGO Data flash (RL78/F24)
 - High-speed on-chip oscillator ($\pm 2\%$ at -40 to $+105/125^\circ\text{C}$)
CPU: 40 MHz, peripheral: 80 MHz (timerRDe)
 - Advanced on-chip debugging functionality
Hot plugin
DTC real-time RAM monitor (RRM) and dynamic memory modification (DMM)
On-chip trace
 - ASIL-B (ISO26262)
 - Evita light (ISO/SAE21434)
- Compact package
 - 32-pin QFN Package lineup
- High temperature support
 - $T_a = 150^\circ\text{C}$

RL78/F23, F24 lineup

RL78/F23

ROM	Pin	32	48	64	80
128 KB		12 KB	12 KB	12 KB	12 KB

White numbers indicate RAM Size

RL78/F24

ROM	Pins	32	48	64	80	100
256 KB		24 KB	24 KB	24 KB	24 KB	24 KB

White numbers indicate RAM Size

RL78/F23, F24 block diagram

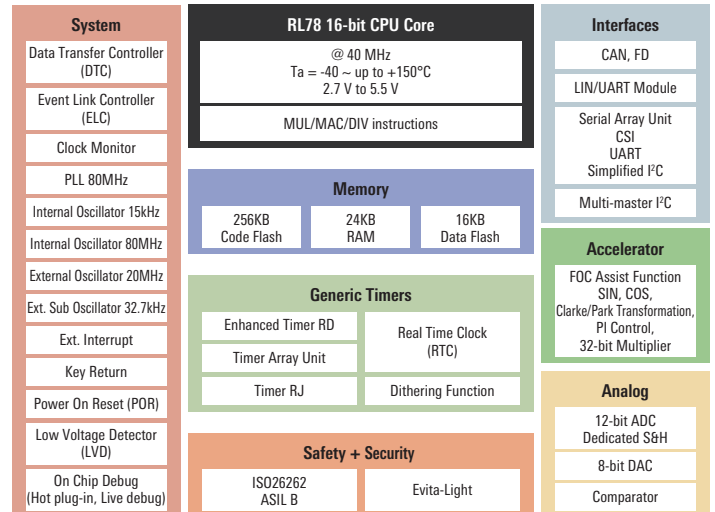

Abbreviation:
FOC: Field Oriented Control (BLDC motor vector control method)

Note: The block diagram of F24

RL78/F13, F14, F15

The RL78/F1x microcontrollers are the successors to the 78K0R and R8C families. They combine high performance with low power consumption, and features such as CAN/LIN communication functions, advanced-functionality timers, and safety functions make them ideal for both automotive and industrial applications.

RL78/F13, F14, F15 lineup

RL78/F13

ROM	Pins		20	30	32	48	64	80
128 KB				8 K	8 K	8 K	8 K	8 K
96 KB				6 K	6 K	6 K	6 K	6 K
64 KB	4 K	4 K	4 K	4 K	4 K	4 K	4 K	4 K
48 KB	3 K	3 K	3 K	3 K	3 K	3 K	3 K	
32 KB	2 K	2 K	2 K	2 K	2 K	2 K	2 K	
16 KB	1 K	1 K		1 K		1 K		

RL78/F14

ROM	Pins		30	32	48	64	80	100
256 KB					20 K	20 K	20 K	20 K
192 KB					16 K	16 K	16 K	16 K
128 KB					10 K	10 K	10 K	10 K
96 KB					8 K	8 K	8 K	8 K
64 KB	6 K	6 K	6 K	6 K	6 K	6 K	6 K	6 K
48 KB	4 K	4 K	4 K	4 K				

RL78/F15

ROM	Pins		48	64	80	100	144
512 KB			32 K	32 K	32 K	32 K	32 K
384 KB			26 K	26 K	26 K	26 K	26 K
256 KB						20 K	20 K
152 KB						16 K	16 K
128 KB						10 K	10 K

LIN CAN 1ch CAN 2ch White numbers indicate RAM Size (B)

RL78/F13 features

- Lineup of pin counts from 20 to 80 pins and memory from 16 KB to 128 KB CAN products and non-CAN products are pin compatible.
- Compatible with RL78/F14 and RL78/F15 for easy migration

RL78/F14 features

- Expanded motor functionality
Comparator and D/A converter can be combined with timer RD for applications such as brushless DC motor control.
- Compatible with RL78/F13 and RL78/F15 for easy migration

RL78/F15 features

- Compatible with RL78/F13 and RL78/F14 for easy migration
- Expanded number of CAN and LIN channels, on-chip IEBus controller.
Enhanced functions suitable for use in automotive gateway products.

RL78/F14 block diagram

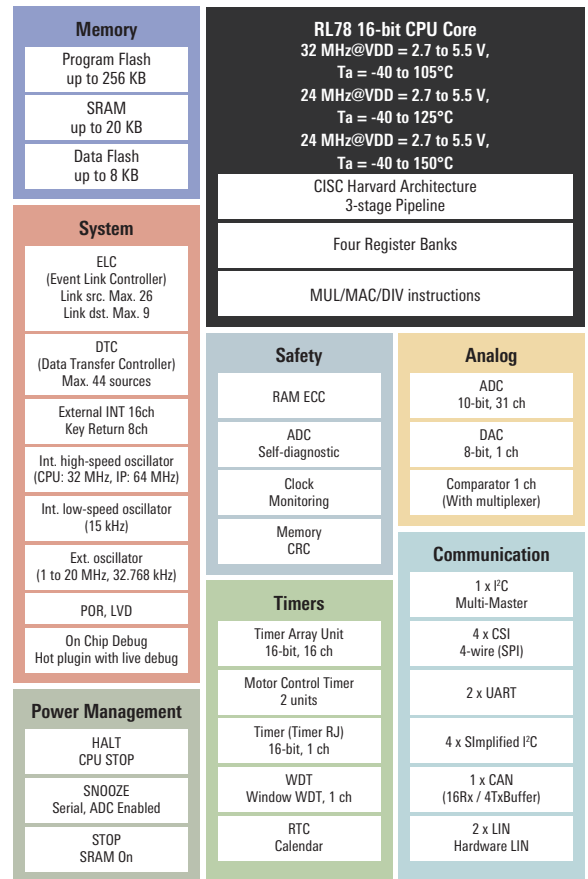

100-pin product

- More advanced functionality
 - 32 MHz operation (2.7 V to 5.5 V at 105°C)
 - Three-phase waveform output function (timer RD)
 - 4 KB BGO data flash (RL78/F13)
 - 8 KB BGO data flash (RL78/F14)
 - 16 KB BGO data flash (RL78/F15)
 - High-speed on-chip oscillator ($\pm 2\%$ at -40 to $+105^\circ\text{C}$)
CPU: 32 MHz, peripheral: 64 MHz (timer RD)
 - Advanced on-chip debugging functionality
Hot plugin
DTC real-time RAM monitor (RRM) and dynamic memory modification (DMM)
On-chip trace
 - Functional safety support
- Compact package
 - QFN Package lineup
Ex. 32-pin SSOP 32-pin QFN
- High temperature support
 - Operation at Ta = 150°C (RL78/F13, F14)

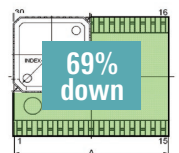

























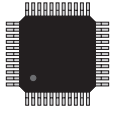



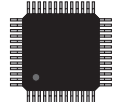

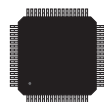
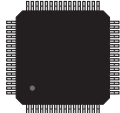
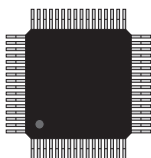
RL78 FAMILY OVERVIEW

	G10	G11	G12	G13	G13A	G14	G15	G16	G1A	G1C	G1D	G1F	G1G	G1H	G1M	G1N	G1P	G22	G23	G24	L12	L13	L1A	L1C	H1D	I1A	I1B	I1C	I1D	I1E	F13	F14	F15	F23	F24		
Key Feature, Application	Low Pin	Low-Power Analog	Basic	Standard	Standard	Enhanced	Standard	Standard	12-bit ADC	USB	Bluetooth	Enhanced Motor	Small Motor	Sub-GHz	Low Pin Motor	Low Pin LED	Low Pin Analog	Standard	Standard	Enhanced	LCD Basic	LCD Standard	Blood Glucose	LCD Enhanced	Blood Pressure	Lighting	Measuring	Enhanced Measuring	Detector	Ind. Sensor	CAN Auto	CAN Auto	CAN Auto	Auto	CAN Auto		
Max speed (MHz)	20	24	24	32	32	32	16	16	32	24	32	32	24	32	20	20	32	32	32	48	24	24	24	24	32	24	24	32	24	32	32	32	40	40			
Voltage (V)	2.0-5.5	1.6-5.5	1.8-5.5	1.6-5.5	1.6-5.5	1.6-5.5	2.4-5.5	2.4-5.5	1.6-3.6	2.4-5.5	1.6-3.6	1.6-5.5	2.7-5.5	1.8-3.6	2.0-5.5	2.0-5.5	2.7-3.6	1.6-5.5	1.6-5.5	1.6-5.5	1.6-5.5	1.6-5.5	1.8-3.6	1.6-3.6	1.8-5.5	2.7-5.5	1.9-5.5	1.7-5.5	1.6-3.6	2.4-5.5	2.7-5.5	2.7-5.5	2.7-5.5	2.7-5.5			
Pin	10-16	10-25	20-30	20-128	44-100	30-100	8-20	10-32	25-64	32-48	48	24-64	30-44	64	20	20	24, 32	16-48	30-128	20-64	32-64	64-80	80-100	80-100	48-80	20-38	80-100	64-100	20-48	32-36	20-80	30-100	48-144	32-80	32-100		
Flash (KB)	1-4	16	2-16	16-512	384-512	16-512	4-8	16-32	16-64	32	128-256	32-64	8-16	256-512	4, 8	4, 8	16	32-64	96-768	64-128	8-32	16-128	48-128	64-256	64-128	32-64	64-128	64-512	8-32	32	16-128	48-256	128-512	128	256		
Data Flash (KB)	-	2	-/2	-/4-8	8	4-8	1	1	4	2	8	4	-	8	-	-	2	2	8	4	2	4	8	8	4	4	4	-	2	2	4	4	4-8	8-16	8	16	
RAM (KB)	0.1-0.5	1.5	0.2-2	2-32	24-32	2.5-48	1	2	2-4	5.5	12-20	5.5	1.5	24-48	0.5-1	0.5-1	1.5	4	12-48	12	1-1.5	1-8	5.5	8-16	5/5/8	2-4	6-8	6-32	0.7-3	8	1-8	4-20	10-32	12	24		
Max temp. option (°C)	85	85, 105	85, 105	85, 105	85, 105	85, 105	85, 105, 125	85, 105, 125	85, 105	85, 105	85	85, 105	85	85	85	85	85	85, 105	85, 105	85, 105, 125	85, 105	85, 105	85	85, 105	85	105, 125	85	85	105	105, 125	105, 125, 150	105, 125, 150	105, 125, 150	105, 125, 150	105, 125, 150		
ADC, TAU, 12-bit interval timer, SPI, UART, I2C	■	■	■	■	■	■	■	■	■	■	■	■	■	■	■	■	■	■	■	■	■	■	■	■	■	■	■	■	■	■	■	■	■	■	■	■	
Vref/temp. sensor	■	■	■	■	■	■	■	■	■	■	■	■	■	■	■	■	■	■	■	■	■	■	■	■	■	■	■	■	■	■	■	■	■	■	■	■	
Fast Wake-up 4µs max 8/16-bit interval timer		■																										■	■								
RTC (32 kHz)				■	■	■			■	■	■	■	■	■	■	■	■	■	■	■	■	■	■	■	■	■	■	■	■	■	■	■	■	■	■	■	
MAC/DIV/MUL		■	■	■	■	■			■	■	■	■	■	■	■	■	■	■	■	■	■	■	■	■	■	■	■	■	■	■	■	■	■	■	■	■	■
DMA/DTC (DMA unless otherwise noted)		■	■	■	■	■			■	■	■	■	■	■	■	■	■	■	■	■	■	■	■	■	■	■	■	■	■	■	■	■	■	■	■	■	■
ELC						■											■	■	■	■	■	■	■	■	■	■	■	■	■	■	■	■	■	■	■	■	
Comparator	■	■				■	■					■	■									■	■	■		■	■	■	■	■	■	■	■	■	■	■	
DAC (8-bit) unless otherwise indicated		■				■						■	■			■						■	■	■	■	■	■	■	■	■	■	■	■	■	■	■	
PGA/AMP		■										■	■							■			■	■	■	■	■	■	■	■	■	■	■	■	■	■	
12-bit ADC									■							■							■	■													
24-bit ADC																							■	■	■	■	■	■	■	■	■	■	■	■	■	■	
Motor (RD), Power stage (KB) control timer		■				■						■	■	■									■	■		■						■	■	■	■	■	
LCD																							■	■	■	■	■	■	■	■	■	■	■	■	■	■	
USB										■														■													
CAN		■		■	■	■										■															■	■	■	■	■	■	
2x PC addresses				■	■	■																															
Radio											■			■																							

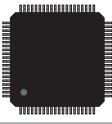
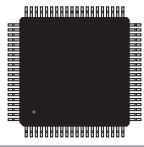
Notes: 1. No Vref and 12-bit interval timer in 10-pin; no temp sensor. 2. Except R5F11R 3. Except 48QFP and 64BGA 4. Only I1C (512 KB)

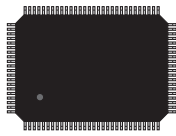
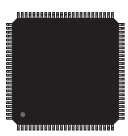
RL78 FAMILY PACKAGE LINEUP

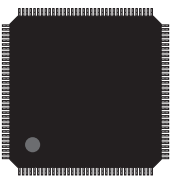
									
Pin-type:	8-WDFN	10-LSSOP	16-SSOP	16-HWQFN	20-LSSOP	20-LSSOP	20-TSSOP	24-HWQFN	25-WFLGA
Size:	3 x 3 mm	4.4 x 3.6 mm	4.4 x 5 mm	3 x 3 mm	4.4 x 6.5 mm	6.1 x 6.65 mm	4.4 x 6.5 mm	4 x 4 mm	3 x 3 mm
Pitch:	0.65 mm	0.65 mm	0.65 mm	0.50 mm	0.65 mm	0.65 mm	0.65 mm	0.50 mm	0.50 mm
Thickness:	0.80 mm	1.45 mm	1.725 mm	0.80 mm	1.45 mm	1.40 mm	1.20 mm	0.80 mm	0.76 mm
Group:	G15	G10, G11, G15, G16	G10, G11, G15, G16	G11, G15, G16, G22	G11, G12, G15, G16, G22, G24, I1A, I1D	G13, F13	G11, G12, G13, G1M, G1N	G11, G12, G13, G16, G22, G24, G1F, G1P, I1D	G11, G13, G22, G24, G1A
									
Pin-type:	30-LSSOP	32-HVQFN	32-HWQFN	32-LQFP	36-TFBGA	36-WFLGA	38-SSOP		
Size:	6.1 x 9.85 mm	5 x 5 mm	5 x 5 mm	7 x 7 mm	4 x 4 mm	4 x 4 mm	6.1 x 12.3 mm		
Pitch:	0.65 mm	0.50 mm	0.50 mm	0.80 mm	0.50 mm	0.50 mm	0.65 mm		
Thickness:	1.40 mm	0.90 mm	0.80 mm	1.70 mm	1.10 mm	0.76 mm	2.00 mm		
Group:	G12, G13, G14, G22, G23, G24, G1G, I1A, I1D, F13, F14	I1D, I1E, F13, F14	G13, G14, G16, G22, G23, G24, G1A, G1C, G1F, F23, F24	G14, G16, G22, G23, G24, G1C, G1F, G1G, G1P, I1D, L12	I1E	G13, G14, G22, G23, G1F	I1A		
									
Pin-type:	40-HWQFN	44-LQFP	48-HVQFN	48-HWQFN	48-HWQFN	48-LFQFP			
Size:	6 x 6 mm	10 x 10 mm	7 x 7 mm	6 x 6 mm	7 x 7 mm	7 x 7 mm			
Pitch:	0.50 mm	0.80 mm	0.50 mm	0.40 mm	0.50 mm	0.50 mm			
Thickness:	0.80 mm	1.60 mm	0.90 mm	0.80 mm	0.80 mm	1.60 mm			
Group:	G13, G14, G22, G23, G24	G13, G13A, G14, G22, G23, G24, G1G, L12	F13, F14, F15	G1D	G13, G14, G22, G23, G24, G1A, G1C	G13, G13A, G14, G1A, G1C, L12, F13, F14, F15, F23, F24	G14, G22, G23, G24, G1F, I1D, H1D, F23, F24		
									
Pin-type:	52-LQFP	64-HVQFN	64-HWQFN	64-LFQFP	64-LQFP	64-LQFP			
Size:	10 x 10 mm	9 x 9 mm	8 x 8 mm	10 x 10 mm	12 x 12 mm	14 x 14 mm			
Pitch:	0.65 mm	0.50 mm	0.40 mm	0.50 mm	0.65 mm	0.80 mm			
Thickness:	1.70 mm	1.00 mm	0.80 mm	1.60 mm	1.60 mm	1.70 mm			
Group:	G13, G14, G23, G24, L12	G1H	L12	G13, G13A, G14, G1A, L12, F13, F14, F15, F23, F24	G14*1, G23, G24, G1F, H1D, I1C, L13, F23, F24	G13, G14, G23, G24, L12, L13	G14		
									
Pin-type:	64-TFBGA	64-VFBGA	64-WFLGA	80-LFQFP	80-LQFP	85-VFLGA			
Size:	4 x 4 mm	4 x 4 mm	5 x 5 mm	12 x 12 mm	14 x 14 mm	7 x 7 mm			
Pitch:	0.40 mm	0.40 mm	0.50 mm	0.50 mm	0.65 mm	0.65 mm			
Thickness:	1.10 mm	0.99 mm	0.76 mm	1.60 mm	1.70 mm	1.00 mm			
Group:	H1D	G13, G1A	G14, G23	G13, G14, F13, F14, F15, F23, F24	G13, G14, G23, L13	L1C			
									
Pin-type:	100-LQFP	100-LFQFP	128-LFQFP	144-LFQFP					
Size:	14 x 20 mm	14 x 14 mm	14 x 14 mm	20 x 20 mm					
Pitch:	0.65 mm	0.50 mm	0.50 mm	0.50 mm					
Thickness:	1.60 mm	1.60 mm	1.60 mm	1.60 mm					
Group:	G13, G14, G23	G13, G13A, G14, F14, F15, F24	G14*1, G23, I1B, I1C, L1A, L1C, F24	G13, G23	F15				

Note: *1. G14 (384, 512 KB)

RL78 FAMILY DEVELOPMENT ENVIRONMENT

Renesas Electronics supports all aspects of application development for the RL78 Family with products such as the integrated development environment CS+, e² studio, real-time OSes, and programming tools.

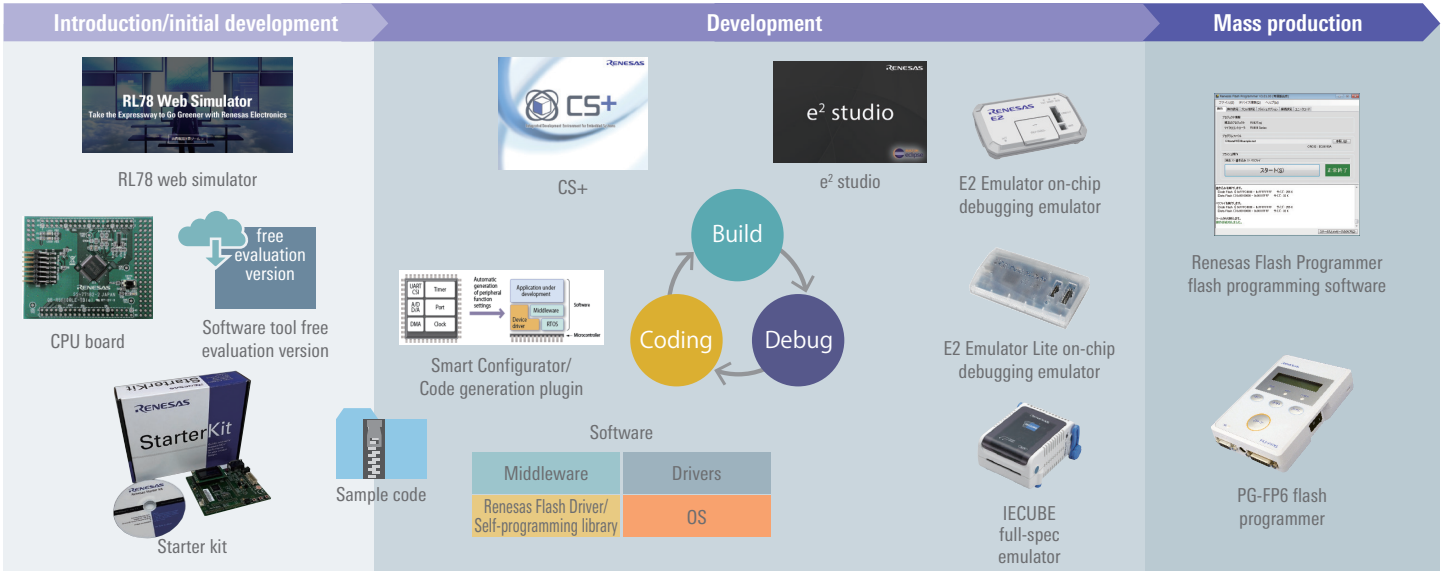

RL78 web simulator

Now you can easily develop prototypes using RL78 microcontrollers and run current consumption simulations without having to purchase developer tools.
<https://www.renesas.com/websimulator-en>

Current consumption calculation tool

Just enter microcontroller operating settings and this tool instantly calculates the current consumption, including peripheral functions. There is no need to consult the hardware manual or write a program.



Virtual board and current consumption simulator

Use the virtual board to check the operation of microcontroller peripheral functions, external switches, LEDs, etc. It is also possible to monitor microcontroller I/O signals and get started with initial evaluation before actually purchasing a board or emulator. The virtual board is useful for everything from analyzing program operation to calculating current consumption with a high degree of accuracy.

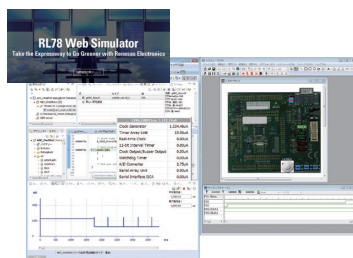

Evaluation boards: Enabling smooth introduction of new microcontrollers

Renesas supplies evaluation boards for a variety of purposes, including microcontroller performance evaluation, initial operation confirmation, evaluation circuit creation, and prototyping of application products.

Renesas starter kit features and usage example

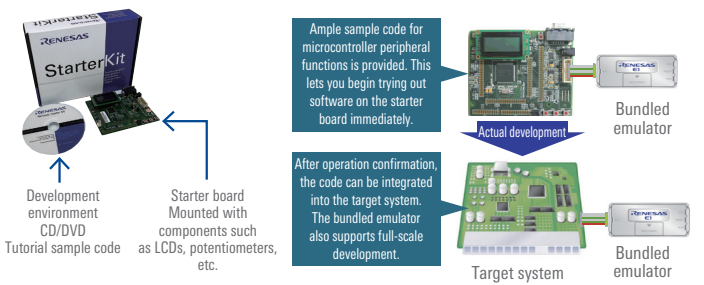

CPU board features and usage example

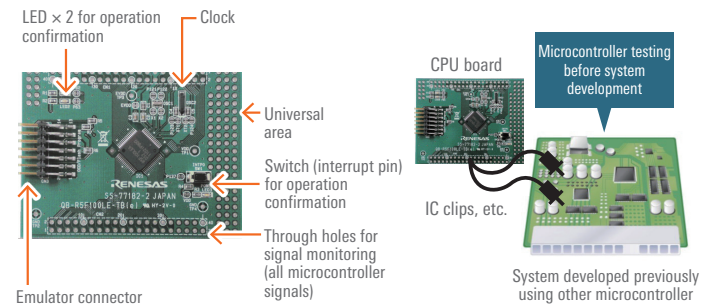

Integrated development environments

CS+

An integrated development environment for 8-bit to 32-bit microcontrollers from Renesas. Even novices will find CS+ simple, convenient, and safe to use. Highly recommended for developers making extensive use of Renesas microcontrollers.

e² studio

Based on the “Eclipse” open-source integrated development environment, e² studio supports the Renesas RL78 Family of microcontrollers. Ideal for developers who are familiar with the Eclipse environment or who wish to utilize the many plugins available in the open-source ecosystem.

CC-RL

RL78 Family C compiler realized through Renesas’ latest compiler optimization techniques.

CC-RL assists device functions with C language specification conformed to ANSI-C, optimization function based on RL78 family architecture, interrupt servicing description.

Evaluation software tools

Software tools for evaluating product functions and performance are available free of charge.

https://www.renesas.com/tool_evaluation

Smart Configurator/Code generation plugin

Included in CS+ and e² studio. It automatically generates code for device drivers, the software that controls microcontroller peripheral functions, based on settings entered via a GUI. A pin table can be displayed to check the settings of multiplexed pins.

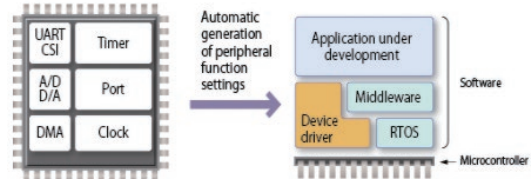

Renesas Flash Driver (RFD), EEPROM Emulation Software (EES) for RL78/G2x, F2x

This custom driver software for flash programming can be used to write programs or data to microcontrollers that require programming in the field following shipment.

- RFD RL78 Type01 (for RL78/G2x), RFD RL78 Type02 (for RL78/F23, F24): RFD RL78 Type01 or Type02 are embedded in user program and user can re-program user program area or data flash area.*1
- EES RL78 Type01 (for RL78/G2x), EES RL78 Type02 (for RL78/F23,F24): Software for EEPROM emulation.*2

- Notes: 1. Because the flash hardware interface for RL78/G2x, RL78/F23 and F24 are disclosed, RFD RL78 Type01 and RFD RL78 Type02 are distributed with a C language source program style. A customer refers to this source program and development of a customer’s own flash re-programming software is also possible.
2. Allows writing and reading of user data without consideration for the designated location for user data (data flash). EES can make the number of times of rewriting of the data for EES increase by decentralizing the writing of data with the system to add.

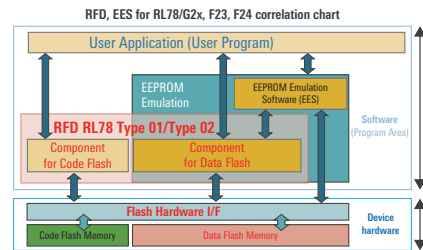

RL78 Family self-programming libraries

These custom software libraries for flash programming can be used to write programs or data to microcontrollers that require programming in the field following shipment.

Code flash library

https://www.renesas.com/flash_libraries/self_prg

Data flash library

https://www.renesas.com/flash_libraries/data_flash

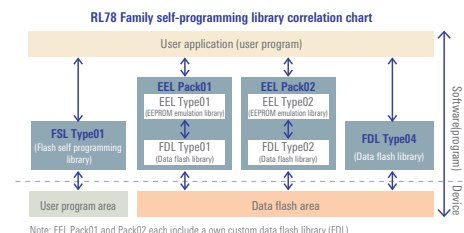

- FSL Type01: Library for writing user programs to flash memory
- FDL Type04: Library for writing data to data flash
- EEL Pack01/EEL Pack02: Library for EEPROM emulation*1

- Note: 1. Allows writing and reading of user data without consideration for the designated location for user data (data flash). Also, since data is appended it is written to scattered locations, and this increases the number of write cycles for EEL target data.



Emulators

Renesas offers IECUBE, E2 Emulator, and E2 Emulator Lite to meet the debugging requirements of customers.

Lineup	Features	Trace Function	Time Measurement Function	Coverage Function	Flash Programming Function	Device Equivalence	Extended Function
IECUBE Support for powerful debugging functions 	Advanced debugging functions including tracing of all instructions, measurement of time between events, and coverage.	Yes	2*2	Yes	No	○*4	No
E2 Emulator Correspondence to extended functions 	An advanced on-chip debugging emulator and flash programmer developed based on a concept of “improvement of development efficiency”.	Yes*1	1*3	No	Yes	◎*5	Yes*6
E2 Emulator Lite Entry model 	An on-chip debugging emulator and flash programmer that provides standard debugging functions at low cost.						No

Notes: 1. Microcontrollers with on-chip trace support only 2. Capable of measuring time between events 3. Capable of measuring run-break duration 4. Emulation of device operation for FPGA, etc 5. Actual device operating 6. Current consumption tuning solution

RL78V4 V2 real-time OS compliant with μ TRON standard

A high-quality real-time multitasking environment for embedded systems

- Complies with worldwide standard μ TRON 4.0 specification
- Compact design suitable for ROM storage
- Full complement of service calls
- Excellent real-time performance (interrupt response time, task switching time)
- Support for convenient functions when used in conjunction with the CS+ integrated development environment (automatic setting of options required to build the OS, display of the state of objects managed by the OS such as tasks and semaphores, graphical display of task operation history and service call issue history)
- Supports the RL78 family C compiler package (CC-RL)
- Provide a trial version

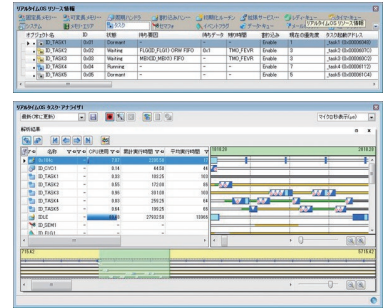

Illustration of function screens in conjunction with CS+

Middleware

- Extensive lineup for RL78 applications, including audio, file system, and memory drivers
- Common interface design with flexible support for the entire RL78 Family
- Sample programs included. Highly efficient design process for less time to product completion

RL78 Family middleware lineup

- Audio
 - ADPCM encoder/decoder
- Signal processing
 - Digital filters (FIR, IIR)
 - FFT library
- Security
 - AES library
 - SHA hash function library
 - RSA library
- File system
 - Open source FAT file system (TFAT)
- Memory drivers
 - SPI mode MultiMediaCard driver
 - SPI mode MMC/SD memory card driver
 - SPI serial flash driver
 - SPI single master driver
 - Renesas SPI serial EEPROM driver
 - Renesas I²C serial EEPROM driver
 - I²C single master driver

Application notes and sample code

Renesas provides sample programs with documentation describing how to use microcontroller peripheral functions as well as system examples.

- Sample code for RL78, constantly expanding lineup
- Extensive sample code including register definition files
- Substantial reduction in time to completion for products incorporating RL78 Family microcontrollers

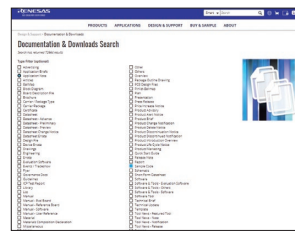

Visit the following URL to download sample code based on the philosophy of "simpler and faster".

<http://www.renesas.com/software>

Three types of debugging environment to match your development style

Debugging on a PC [CS+ simulator, e²studio simulator]

Simulator enabling source-level debugging of applications in the CS+ and e²studio integrated development environment before the target system exists

- Rich break functions and coverage measurement functions
- Ability to evaluate software modules in a manner very similar to evaluation on the actual device

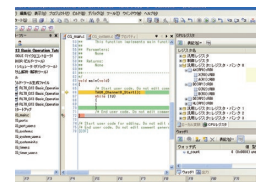

Simulator for CS+

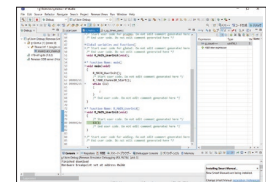

e²studio simulator

Debugging with basic functions [E2, E2 Lite on-chip debugging emulator]

Basic debugging capabilities at an inexpensive price. This emulator also supports on-chip trace functionality.*1

- Simple to connect. Allows debugging via a connection to an RL78 microcontroller mounted in the system under development.
- Also functions as a flash programmer.
- Environmentally friendly. All materials from the components to the packaging are RoHS compliant.



Note: 1. On microcontrollers with on-chip trace support only.

Debugging with high-level functions [IECUBE full-spec emulator]

A high-performance full-spec emulator with more advanced functions

- Trace with time-tag function
- Provides access via a GUI to more powerful debugging capabilities, including a duration measurement function and coverage function.



Three types of programming environment to match your development goals and circumstances

Programming controlled by a PC [Renesas Flash Programmer flash programming software]

- Simple GUI specialized for programming
- Batch processing efficiently for programming large quantities at mass production
- PC-controlled programming using E2 emulator, E2 emulator Lite or serial
- Ability to embed unique code

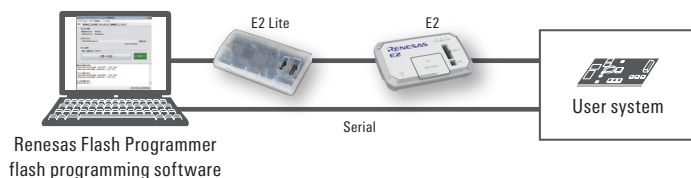

Programming controlled by a PC or stand-alone programming [PG-FP6 flash programmer]

- Stand-alone programming
- Programming controlled by a PC using a dedicated GUI
- Ability to store settings for up to eight environments
- Ideal for use on the production line (command control, remote control)
- Ability to embed unique code

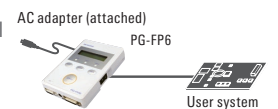

Ordering pre-programmed ROM (growing number of products supported)*1

- Pre-programmed flash memory products from Renesas Electronics

Note: 1. The support status differs depending on the product.

Please contact a Renesas sales company or agent for details.



Development tools for RL78 Family

Group	CPU Boards	Promotion Boards	Starter Kits	Development Kits	Solutions Kits
G10	QB-R5F10Y16-TB RTE510Y470TGB00000R	–	–	–	–
G11	YQB-R5F1057A-TB	YRPBRL78G11	–	–	–
G12	QB-R5F1026A-TB	–	–	–	–
G13	QB-R5F100LE-TB QB-R5F100SL-TB	YRPBRL78G13	R0K50100LS900BE	YRDKRL78G13	–
G13A	RTK5RLG13AC00000BJ	–	–	–	–
G14	QB-R5F104LE-TB QB-R5F104PJ-TB FB-R5F104PL-TB* ¹ RTK5RLG140C00000BJ	YRPBRL78G14	R0K50104PS900BE	YRDKRL78G14	YRMCKITRL78G14 (Motor control)
G15	RTK5RLG150C00000BJ	–	–	–	–
G16	RTK5RLG160C00000BJ	–	–	–	–
G22	RTK7RLG220C00000BJ	–	–	–	–
G23	RTK7RLG230CLG000BJ RTK7RLG230CSN000BJ	–	–	–	–
G24	RTK7RLG240C00000BJ	–	–	–	–
G1A	QB-R5F10ELE-TB	–	–	–	–
G1C	QB-R5F10JGC-TB	–	R0K5010JGS900BE	–	R0K578G1CD010BR (USB charger)
G1D	RTK0EN001D010001BZ (Evaluation Kit)	–	–	–	YRLI1D-BLE-SOL
G1D Module	RM-110-RFB-2* ¹ (Evaluation Board)	–	–	–	–
G1F	–	–	–	–	RTK0EML240C03000BJ (Motor CPU Card)
G1G	YQB-R5F11EFA-TB	–	R0K5011EFS900BE	–	–
G1H	TK-RLG1H+SB2* ² (Evaluation Kit)	–	–	–	–
G1M	RTK5RLG1M0C00000BJ	–	–	–	–
G1N	RTK5RLG1N0C00000BJ	–	–	–	–
G1P	RTK5RLG1P0C00000BJ	–	–	–	–
L12	QB-R5F10RLC-TB	YRPBRL78L12	R0K5010RLS900BE#WS	–	–
L13	QB-R5F10WMG-TB	–	R0K5010WMS900BE	–	–
L1C	QB-R5F110PJ-TB	–	R0K50110PS900BE	–	R0K578L1CD000BR (HMI)
H1D	–	–	–	–	RTK0EH0003S02001BR (Blood Pressure)
I1A	QB-R5F107DE-TB	–	–	–	Y-RL78-DCDC-LED (LED)
I1B	RTE510MPG0TGB00000R	–	–	–	–
I1C	RTK5RL10N0CPL000BJ	–	–	–	–
I1D	RTE5117GC0TGB00000R	–	–	–	YDETECT-IT-RL78 (Detector)
I1E	FB-R5F11CCC-TB* ¹	–	–	–	FB-R5F11CCC-LC* ¹
F13	QB-R5F10BMG-TB	–	–	Y-ASK-RL78F13-V2	–
F14	QB-R5F10PPJ-TB	–	–	YRDKRL78F14	–
F15	Y-QB-R5F113TL-TB-V2	–	–	Y-ASK-RL78F15-V2	–
F23* ³	–	–	–	–	–
F24	RTK7F124FPC01000BJ	–	–	Y-ASK-RL78F24	RTK7F124FGS00000BJ

Notes: 1. Products of Naito Densai Machida Mfg. 2. Product of Tesser Technology Inc. (P/N: TK-RLG1H+SB2) 3. Please use F24 tools as an upward compatible product.

EXPLANATION OF ORDERABLE PART NUMBERS

(For part numbers start with R5F)

R5 F 1 00 6 E C A SP #Vx

Renesas MCU ROM Type F: Flash RL78 Family

Product group

00	G13	Data Flash
01		No Data Flash
02	G12	Data Flash
03		No Data Flash
04	G14	
05	G11	
07	I1A	
09	F12	
0A	F13	LIN
0B		LIN & CAN
0E	G1A	
0F	G1E	
0J	G1C	USB Host & Function
0K		USB Function
0M	I1B	
0N	I1C	On-chip AES
0P	F14	
0R	L12	
0W	L13	
0Y	G10	
10	L1C	LCD & USB Function
11		LCD
13	F15	
17	I1D	
1A	G1D	
1B	G1F	
1C	I1E	
1E	G1G	
1F	G1H	
1M	L1A	
1N	H1D	AFE, LQFP package
1P		AFE, TFBGA package
1R		Meter, Timer
1T	I1C	No On-chip AES
1W	G1M	
1Y	G1N	
1Z	G1P	
20	G15	
21	G16	
40	G13A	

Pin count

0	8
1	10
4	16
6	20
7	24
8	25
A	30
B	32
C	36
D	38
E	40
F	44
G	48
J	52
L	64
M	80
P	100
S	128
T	144

ROM Size (KB)

4	1
6	2
7	4
8	8
9	12
A	16
B	24
C	32
D	48
E	64
F	96
G	128
H	192
J	256
K	384
L	512

Packaging, Material (Pb-free)

#G, #0	Full Carton (HWQFN, HVQFN, WFLGA)
#H, #1	Full Carton (SSOP, LSSOP, LQFP, LFQFP, TSSOP, WDFN)
#U, #2	Tray (HWQFN, HVQFN, VFBGA, VFLGA, WFLGA, FLGA, TFBGA)
#V, #3	Tray, Tube*1 (SSOP, LSSOP, LQFP, LFQFP, TSSOP, WDFN)
#W, #4	Embossed Tape (HWQFN, HVQFN, VFBGA, VFLGA, WFLGA, FLGA, TFBGA)
#X, #5	Embossed Tape (SSOP, LSSOP, LQFP, LFQFP, TSSOP, WDFN)

Package, Pin Pitch

SP	SSOP 0.65 mm	LA	WFLGA 0.5 mm
	LSSOP 0.65 mm		VFLGA 0.65 mm
SM	TSSOP 0.65 mm	BG	VFBGA 0.4 mm
			TFBGA 0.5 mm
NA	HWQFN 0.5 mm	FA	LQFP 0.65 mm
	HVQFN 0.5 mm		
NB	HWQFN 0.65 mm	FB	LFQFP 0.5 mm
	HWQFN 0.4 mm		FP

Temperature & Quality Grade

A	-40°C to 85°C	Consumer
D	-40°C to 85°C	Industrial
G	-40°C to 105°C	Industrial
M	-40°C to 125°C	Industrial
J	-40°C to 85°C	Automotive
L	-40°C to 105°C	Automotive
K	-40°C to 125°C	Automotive
Y	-40°C to 150°C	Automotive

Bonding wire (Only part of RL78/F1x)*2

C	Cu (Copper)
---	-------------

Notes: 1. For 20-pin RL78/G11, RL78/G12, RL78/G15, RL78/G16 RL78/I1A and RL78/I1D LSSOP products only the package specification is tube.
 2. Please contact Renesas sales or agent for details.

EXPLANATION OF ORDERABLE PART NUMBERS

(For part numbers start with R7F)

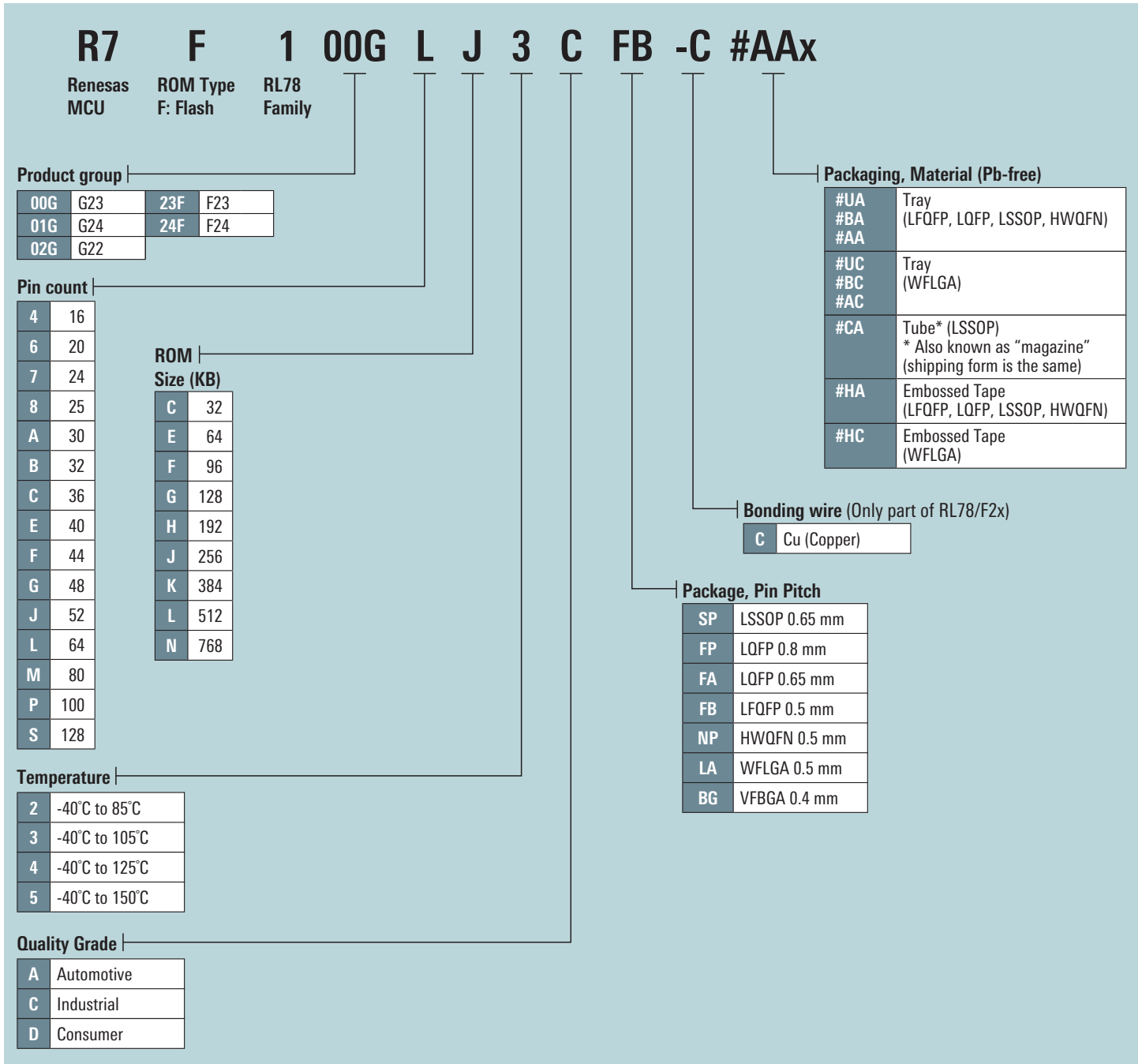

Renesas Electronics Corporation TOYOSU FORESIA, 3-2-24 Toyosu, Koto-ku, Tokyo 135-0061, Japan

Notice

1. Descriptions of circuits, software and other related information in this document are provided only to illustrate the operation of semiconductor products and application examples. You are fully responsible for the incorporation or any other use of the circuits, software, and information in the design of your product or system. Renesas Electronics disclaims any and all liability for any losses and damages incurred by you or third parties arising from the use of these circuits, software, or information.
 2. Renesas Electronics hereby expressly disclaims any warranties against and liability for infringement or any other claims involving patents, copyrights, or other intellectual property rights of third parties, by or arising from the use of Renesas Electronics products or technical information described in this document, including but not limited to, the product data, drawings, charts, programs, algorithms, and application examples.
 3. No license, express, implied or otherwise, is granted hereby under any patents, copyrights or other intellectual property rights of Renesas Electronics or others.
 4. You shall be responsible for determining what licenses are required from any third parties, and obtaining such licenses for the lawful import, export, manufacture, sales, utilization, distribution or other disposal of any products incorporating Renesas Electronics products, if required.
 5. You shall not alter, modify, copy, or reverse engineer any Renesas Electronics product, whether in whole or in part. Renesas Electronics disclaims any and all liability for any losses or damages incurred by you or third parties arising from such alteration, modification, copying or reverse engineering.
 6. Renesas Electronics products are classified according to the following two quality grades: "Standard" and "High Quality". The intended applications for each Renesas Electronics product depends on the product's quality grade, as indicated below.
 - "Standard": Computers; office equipment; communications equipment; test and measurement equipment; audio and visual equipment; home electronic appliances; machine tools; personal electronic equipment; industrial robots; etc.
 - "High Quality": Transportation equipment (automobiles, trains, ships, etc.); traffic control (traffic lights); large-scale communication equipment; key financial terminal systems; safety control equipment; etc.
 Unless expressly designated as a high reliability product or a product for harsh environments in a Renesas Electronics data sheet or other Renesas Electronics document, Renesas Electronics products are not intended or authorized for use in products or systems that may pose a direct threat to human life or bodily injury (artificial life support devices or systems; surgical implantations; etc.), or may cause serious property damage (space system; undersea repeaters; nuclear power control systems; aircraft control systems; key plant systems; military equipment; etc.). Renesas Electronics disclaims any and all liability for any damages or losses incurred by you or any third parties arising from the use of any Renesas Electronics product that is inconsistent with any Renesas Electronics data sheet, user's manual or other Renesas Electronics document.
 7. No semiconductor product is absolutely secure. Notwithstanding any security measures or features that may be implemented in Renesas Electronics hardware or software products, Renesas Electronics shall have absolutely no liability arising out of any vulnerability or security breach, including but not limited to any unauthorized access to or use of a Renesas Electronics product or a system that uses a Renesas Electronics product. RENESAS ELECTRONICS DOES NOT WARRANT OR GUARANTEE THAT RENESAS ELECTRONICS PRODUCTS, OR ANY SYSTEMS CREATED USING RENESAS ELECTRONICS PRODUCTS WILL BE INVULNERABLE OR FREE FROM CORRUPTION, ATTACK, VIRUSES, INTERFERENCE, HACKING, DATA LOSS OR THEFT, OR OTHER SECURITY INTRUSION ("Vulnerability Issues"). RENESAS ELECTRONICS DISCLAIMS ANY AND ALL RESPONSIBILITY OR LIABILITY ARISING FROM OR RELATED TO ANY VULNERABILITY ISSUES. FURTHERMORE, TO THE EXTENT PERMITTED BY APPLICABLE LAW, RENESAS ELECTRONICS DISCLAIMS ANY AND ALL WARRANTIES, EXPRESS OR IMPLIED, WITH RESPECT TO THIS DOCUMENT AND ANY RELATED OR ACCOMPANYING SOFTWARE OR HARDWARE, INCLUDING BUT NOT LIMITED TO THE IMPLIED WARRANTIES OF MERCHANTABILITY, OR FITNESS FOR A PARTICULAR PURPOSE.
 8. When using Renesas Electronics products, refer to the latest product information (data sheets, user's manuals, application notes, "General Notes for Handling and Using Semiconductor Devices" in the reliability handbook, etc.), and ensure that usage conditions are within the ranges specified by Renesas Electronics with respect to maximum ratings, operating power supply voltage range, heat dissipation characteristics, installation, etc. Renesas Electronics disclaims any and all liability for any malfunctions, failure or accident arising out of the use of Renesas Electronics products outside of such specified ranges.
 9. Although Renesas Electronics endeavors to improve the quality and reliability of Renesas Electronics products, semiconductor products have specific characteristics, such as the occurrence of failure at a certain rate and malfunctions under certain use conditions. Unless designated as a high reliability product or a product for harsh environments in a Renesas Electronics data sheet or other Renesas Electronics document, Renesas Electronics products are not subject to radiation resistance design. You are responsible for implementing safety measures to guard against the possibility of bodily injury, injury or damage caused by fire, and/or danger to the public in the event of a failure or malfunction of Renesas Electronics products, such as safety design for hardware and software, including but not limited to redundancy, fire control and malfunction prevention, appropriate treatment for aging degradation or any other appropriate measures. Because the evaluation of microcomputer software alone is very difficult and impractical, you are responsible for evaluating the safety of the final products or systems manufactured by you.
 10. Please contact a Renesas Electronics sales office for details as to environmental matters such as the environmental compatibility of each Renesas Electronics product. You are responsible for carefully and sufficiently investigating applicable laws and regulations that regulate the inclusion or use of controlled substances, including without limitation, the EU RoHS Directive, and using Renesas Electronics products in compliance with all these applicable laws and regulations. Renesas Electronics disclaims any and all liability for damages or losses occurring as a result of your noncompliance with applicable laws and regulations.
 11. Renesas Electronics products and technologies shall not be used for or incorporated into any products or systems whose manufacture, use, or sale is prohibited under any applicable domestic or foreign laws or regulations. You shall comply with any applicable export control laws and regulations promulgated and administered by the governments of any countries asserting jurisdiction over the parties or transactions.
 12. It is the responsibility of the buyer or distributor of Renesas Electronics products, or any other party who distributes, disposes of, or otherwise sells or transfers the product to a third party, to notify such third party in advance of the contents and conditions set forth in this document.
 13. This document shall not be reprinted, reproduced or duplicated in any form, in whole or in part, without prior written consent of Renesas Electronics.
 14. Please contact a Renesas Electronics sales office if you have any questions regarding the information contained in this document or Renesas Electronics products.
- (Note 1) "Renesas Electronics" as used in this document means Renesas Electronics Corporation and also includes its directly or indirectly controlled subsidiaries.
- (Note 2) "Renesas Electronics product(s)" means any product developed or manufactured by or for Renesas Electronics.

(Rev.5.0-1 2020.10)

■ Contact Us
<https://www.renesas.com/contact-us>



Renesas Electronics Corporation

www.renesas.com