

TEST REPORT

Test report no.: 1-6662/18-01-04



BNetzA-CAB-02/21-102

Testing laboratory

CTC advanced GmbH

Untertuerkheimer Strasse 6 – 10

66117 Saarbruecken / Germany

Phone: + 49 681 5 98 - 0

Fax: + 49 681 5 98 - 9075

Internet: <http://www.ctcadvanced.com>

e-mail: mail@ctcadvanced.com

Accredited Testing Laboratory:

The testing laboratory (area of testing) is accredited according to DIN EN ISO/IEC 17025 (2005) by the Deutsche Akkreditierungsstelle GmbH (DAkkS)

The accreditation is valid for the scope of testing procedures as stated in the accreditation certificate with the registration number: D-PL-12076-01-03

Applicant

Dialog Semiconductor BV

Het Zuiderkruis 53

5215 MV 's Hertogenbosch / Netherlands

Phone: -/-

Contact: Laura Dimitropoulou

e-mail: Laura.Dimitropoulou@diasemi.com

Phone: +30 2610 462406

Manufacturer

Dialog Semiconductor BV

Het Zuiderkruis 53

5215 MV 's Hertogenbosch / Netherlands

Test standard/s

FCC - Title 47 CFR
Part 15

FCC - Title 47 of the Code of Federal Regulations; Chapter I; Part 15 - Radio frequency devices

RSS - 247 Issue 2

Digital Transmission Systems (DTSs), Frequency Hopping Systems (FHSs) and Licence - Exempt Local Area Network (LE-LAN) Devices

RSS - Gen Issue 5

Spectrum Management and Telecommunications Radio Standards Specification - General Requirements for Compliance of Radio Apparatus

For further applied test standards please refer to section 3 of this test report.

Test Item

Kind of test item: Bluetooth LE SoC

Model name: DA1469x

FCC ID: -/-

IC: -/-

Frequency: DTS band 2400 MHz to 2483.5 MHz

Technology tested: Bluetooth® LE

Antenna: Integrated printed inverted F antenna

Power supply: 3.0 V DC by external power supply

Temperature range: -40°C to +85°C



This test report is electronically signed and valid without handwritten signature. For verification of the electronic signatures, the public keys can be requested at the testing laboratory.

Test report authorized:

Andreas Luckenbill
Lab Manager
Radio Communications & EMC

Test performed:

Mihail Dorongovskij
Lab Manager
Radio Communications & EMC

1 Table of contents

1	Table of contents.....	2
2	General information	3
2.1	Notes and disclaimer	3
2.2	Application details	3
2.3	Test laboratories sub-contracted	3
3	Test standard/s and references.....	4
4	Test environment	5
5	Test item	5
5.1	General description.....	5
5.2	Additional information	5
6	Sequence of testing	6
6.1	Sequence of testing radiated spurious 9 kHz to 30 MHz	6
6.2	Sequence of testing radiated spurious 30 MHz to 1 GHz	7
6.3	Sequence of testing radiated spurious 1 GHz to 18 GHz	8
6.4	Sequence of testing radiated spurious above 18 GHz	9
7	Description of the test setup	10
7.1	Shielded semi anechoic chamber	11
7.2	Shielded fully anechoic chamber	12
7.3	Radiated measurements > 18 GHz	13
7.4	Conducted measurements.....	14
8	Measurement uncertainty.....	15
9	Summary of measurement results	16
10	Additional comments	17
11	Measurement results	18
11.1	System gain.....	18
11.2	Power spectral density	19
11.3	DTS bandwidth – 6 dB bandwidth.....	20
11.4	Occupied bandwidth – 99% emission bandwidth	21
11.5	Maximum output power	22
11.6	Detailed spurious emissions @ the band edge - conducted	23
11.7	Band edge compliance radiated	24
11.8	TX spurious emissions conducted	27
11.9	Spurious emissions radiated below 30 MHz	29
11.10	Spurious emissions radiated 30 MHz to 1 GHz	33
11.11	Spurious emissions radiated above 1 GHz	38
Annex A	Glossary	47
Annex B	Document history	48
Annex C	Accreditation Certificate	48

2 General information

2.1 Notes and disclaimer

The test results of this test report relate exclusively to the test item specified in this test report. CTC advanced GmbH does not assume responsibility for any conclusions and generalizations drawn from the test results with regard to other specimens or samples of the type of the equipment represented by the test item.

The test report may only be reproduced or published in full. Reproduction or publication of extracts from the report requires the prior written approval of CTC advanced GmbH.

The testing service provided by CTC advanced GmbH has been rendered under the current "General Terms and Conditions for CTC advanced GmbH".

CTC advanced GmbH will not be liable for any loss or damage resulting from false, inaccurate, inappropriate or incomplete product information provided by the customer.

Under no circumstances does the CTC advanced GmbH test report include any endorsement or warranty regarding the functionality, quality or performance of any other product or service provided.

Under no circumstances does the CTC advanced GmbH test report include or imply any product or service warranties from CTC advanced GmbH, including, without limitation, any implied warranties of merchantability, fitness for purpose, or non-infringement, all of which are expressly disclaimed by CTC advanced GmbH.

All rights and remedies regarding vendor's products and services for which CTC advanced GmbH has prepared this test report shall be provided by the party offering such products or services and not by CTC advanced GmbH. In no case this test report can be considered as a Letter of Approval.

This test report is electronically signed and valid without handwritten signature. For verification of the electronic signatures, the public keys can be requested at the testing laboratory.

2.2 Application details

Date of receipt of order:	2018-06-21
Date of receipt of test item:	2018-07-16
Start of test:	2018-07-16
End of test:	2018-07-17
Person(s) present during the test:	Mr. Kai Lewandowski

2.3 Test laboratories sub-contracted

None

3 Test standard/s and references

Test standard	Date	Description
FCC - Title 47 CFR Part 15		FCC - Title 47 of the Code of Federal Regulations; Chapter I; Part 15 - Radio frequency devices
RSS - 247 Issue 2	February 2017	Digital Transmission Systems (DTSs), Frequency Hopping Systems (FHSs) and Licence - Exempt Local Area Network (LE-LAN) Devices
RSS - Gen Issue 5	April 2018	Spectrum Management and Telecommunications Radio Standards Specification - General Requirements for Compliance of Radio Apparatus

Guidance	Version	Description
DTS: KDB 558074 D01	v04	Guidance for Performing Compliance Measurements on Digital Transmission Systems (DTS) Operating Under §15.247
ANSI C63.4-2014	-/-	American national standard for methods of measurement of radio-noise emissions from low-voltage electrical and electronic equipment in the range of 9 kHz to 40 GHz
ANSI C63.10-2013	-/-	American national standard of procedures for compliance testing of unlicensed wireless devices

6 Sequence of testing

6.1 Sequence of testing radiated spurious 9 kHz to 30 MHz

Setup

- The equipment is set up to simulate normal operation mode as described in the user manual or defined by the manufacturer.
- If the EUT is a tabletop system, it is placed on a table with 0.8 m height.
- If the EUT is a floor standing device, it is placed directly on the turn table.
- Auxiliary equipment and cables are positioned to simulate normal operation conditions as described in ANSI C 63.4.
- The AC power port of the EUT (if available) is connected to a power outlet below the turntable.
- Measurement distance is 3 m (see ANSI C 63.4) – see test details.
- EUT is set into operation.

Premeasurement*

- The turntable rotates from 0° to 315° using 45° steps.
- The antenna height is 1 m.
- At each turntable position the analyzer sweeps with positive-peak detector to find the maximum of all emissions.

Final measurement

- Identified emissions during the pre-measurement are maximized by the software by rotating the turntable from 0° to 360°.
- Loop antenna is rotated about its vertical axis for maximum response at each azimuth about the EUT. (For certain applications, the loop antenna plane may also need to be positioned horizontally at the specified distance from the EUT)
- The final measurement is done in the position (turntable and elevation) causing the highest emissions with quasi-peak (as described in ANSI C 63.4).
- Final levels, frequency, measuring time, bandwidth, turntable position, correction factor, margin to the limit and limit will be recorded. A plot with the graph of the premeasurement and the limit is stored.

*)Note: The sequence will be repeated three times with different EUT orientations.

6.2 Sequence of testing radiated spurious 30 MHz to 1 GHz

Setup

- The equipment is set up to simulate normal operation mode as described in the user manual or defined by the manufacturer.
- If the EUT is a tabletop system, a table with 0.8 m height is used, which is placed on the ground plane.
- If the EUT is a floor standing device, it is placed on the ground plane with insulation between both.
- Auxiliary equipment and cables are positioned to simulate normal operation conditions as described in ANSI C 63.4.
- The AC power port of the EUT (if available) is connected to a power outlet below the turntable.
- Measurement distance is 10 m or 3 m (see ANSI C 63.4) – see test details.
- EUT is set into operation.

Premeasurement

- The turntable rotates from 0° to 315° using 45° steps.
- The antenna is polarized vertical and horizontal.
- The antenna height changes from 1 m to 3 m.
- At each turntable position, antenna polarization and height the analyzer sweeps three times in peak to find the maximum of all emissions.

Final measurement

- The final measurement is performed for at least six highest peaks according to the requirements of the ANSI C63.4.
- Based on antenna and turntable positions at which the peak values are measured the software maximize the peaks by changing turntable position $\pm 45^\circ$ and antenna height between 1 and 4 m.
- The final measurement is done with quasi-peak detector (as described in ANSI C 63.4).
- Final levels, frequency, measuring time, bandwidth, antenna height, antenna polarization, turntable angle, correction factor, margin to the limit and limit are recorded. A plot with the graph of the premeasurement with marked maximum final results and the limit is stored.

6.3 Sequence of testing radiated spurious 1 GHz to 18 GHz

Setup

- The equipment is set up to simulate normal operation mode as described in the user manual or defined by the manufacturer.
- If the EUT is a tabletop system, a 2-axis positioner with 1.5 m height is used.
- If the EUT is a floor standing device, it is placed directly on the turn table.
- Auxiliary equipment and cables are positioned to simulate normal operation conditions as described in ANSI C 63.4.
- The AC power port of the EUT (if available) is connected to a power outlet below the turntable.
- Measurement distance is 3 m (see ANSI C 63.4) – see test details.
- EUT is set into operation.

Premeasurement

- The turntable rotates from 0° to 315° using 45° steps.
- The antenna is polarized vertical and horizontal.
- The antenna height is 1.5 m.
- At each turntable position and antenna polarization the analyzer sweeps with positive peak detector to find the maximum of all emissions.

Final measurement

- The final measurement is performed for at least six highest peaks according to the requirements of the ANSI C63.4.
- Based on antenna and turntable positions at which the peak values are measured the software maximizes the peaks by rotating the turntable from 0° to 360°. This measurement is repeated for different EUT-table positions (0° to 150° in 30°-steps) and for both antenna polarizations.
- The final measurement is done in the position (turntable, EUT-table and antenna polarization) causing the highest emissions with Peak and RMS detector (as described in ANSI C 63.4).
- Final levels, frequency, measuring time, bandwidth, turntable position, EUT-table position, antenna polarization, correction factor, margin to the limit and limit are recorded. A plot with the graph of the premeasurement with marked maximum final results and the limit is stored.

6.4 Sequence of testing radiated spurious above 18 GHz

Setup

- The equipment is set up to simulate normal operation mode as described in the user manual or defined by the manufacturer.
- Auxiliary equipment and cables are positioned to simulate normal operation conditions as described in ANSI C 63.4.
- The AC power port of the EUT (if available) is connected to a power outlet.
- The measurement distance is as appropriate (e.g. 0.5 m).
- The EUT is set into operation.

Premeasurement

- The test antenna is handheld and moved carefully over the EUT to cover the EUT's whole sphere and different polarizations of the antenna.

Final measurement

- The final measurement is performed at the position and antenna orientation causing the highest emissions with Peak and RMS detector (as described in ANSI C 63.4).
- Final levels, frequency, measuring time, bandwidth, correction factor, margin to the limit and limit are recorded. A plot with the graph of the premeasurement and the limit is stored.

7 Description of the test setup

Typically, the calibrations of the test apparatus are commissioned to and performed by an accredited calibration laboratory. The calibration intervals are determined in accordance with the DIN EN ISO/IEC 17025. In addition to the external calibrations, the laboratory executes comparison measurements with other calibrated test systems or effective verifications. Weekly chamber inspections and range calibrations are performed. Where possible, RF generating and signaling equipment as well as measuring receivers and analyzers are connected to an external high-precision 10 MHz reference (GPS-based or rubidium frequency standard).

In order to simplify the identification of the equipment used at some special tests, some items of test equipment and ancillaries can be provided with an identifier or number in the equipment list below (Lab/Item).

Agenda: Kind of Calibration

k	calibration / calibrated	EK	limited calibration
ne	not required (k, ev, izw, zw not required)	zw	cyclical maintenance (external cyclical maintenance)
ev	periodic self verification	izw	internal cyclical maintenance
Ve	long-term stability recognized	g	blocked for accredited testing
vkl!	Attention: extended calibration interval		
NK!	Attention: not calibrated	*)	next calibration ordered / currently in progress

7.1 Shielded semi anechoic chamber

The radiated measurements are performed in vertical and horizontal plane in the frequency range from 30 MHz to 1 GHz in semi-anechoic chambers. The EUT is positioned on a non-conductive support with a height of 0.80 m above a conductive ground plane that covers the whole chamber. The receiving antennas are conform to specifications ANSI C63. These antennas can be moved over the height range between 1.0 m and 4.0 m in order to search for maximum field strength emitted from EUT. The measurement distances between EUT and receiving antennas are indicated in the test setups for the various frequency ranges. For each measurement, the EUT is rotated in all three axes until the maximum field strength is received. The wanted and unwanted emissions are received by spectrum analyzers where the detector modes and resolution bandwidths over various frequency ranges are set according to requirement ANSI C63.

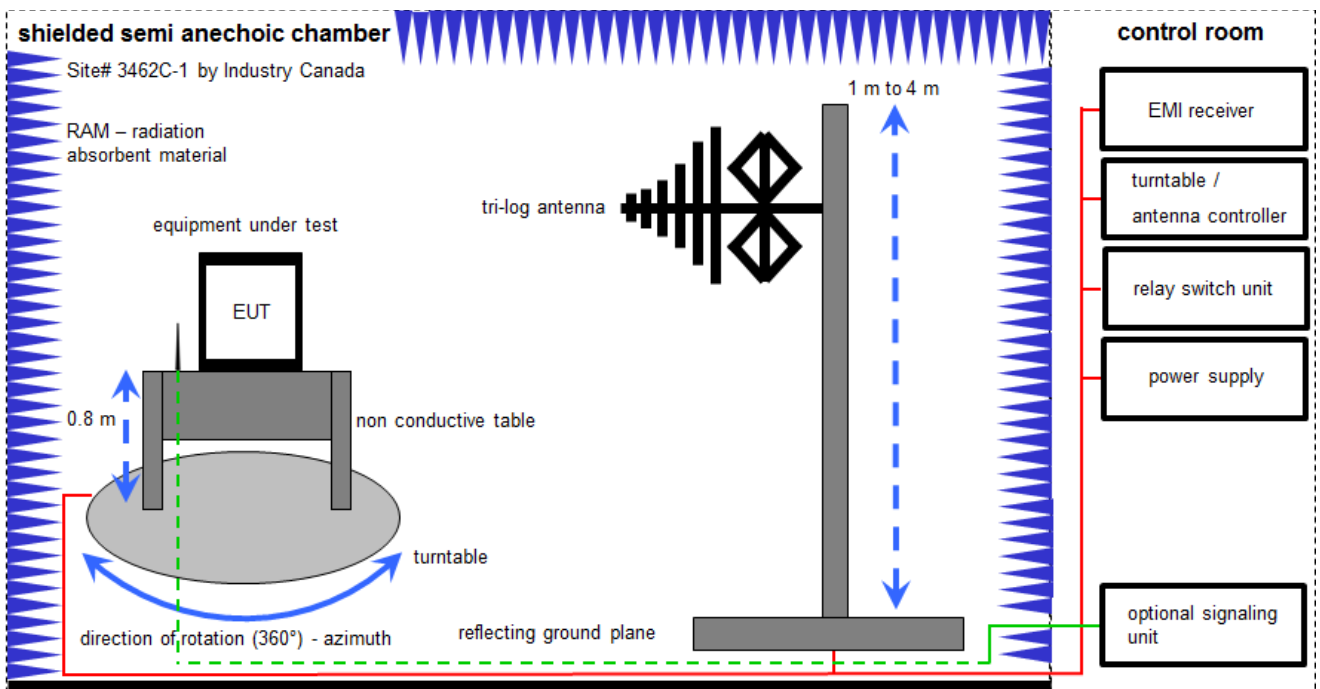

Measurement distance: tri-log antenna 10 meter
EMC32 software version: 10.30.0

FS = UR + CL + AF
(FS-field strength; UR-voltage at the receiver; CL-loss of the cable; AF-antenna factor)

Example calculation:

FS [dBµV/m] = 12.35 [dBµV/m] + 1.90 [dB] + 16.80 [dB/m] = 31.05 [dBµV/m] (35.69 µV/m)

Equipment table:

No.	Lab / Item	Equipment	Type	Manufacturer	Serial No.	INV. No.	Kind of Calibration	Last Calibration	Next Calibration
1	A	Switch-Unit	3488A	HP	2719A14505	300000368	ev	-/-	-/-
2	A	Meßkabin 1	HF-Absorberhalle	MWB AG 300023	-/-	300000551	ne	-/-	-/-
3	A	EMI Test Receiver	ESCI 3	R&S	100083	300003312	k	15.12.2017	14.12.2018
4	A	Antenna Tower	Model 2175	ETS-Lindgren	64762	300003745	izw	-/-	-/-
5	A	Positioning Controller	Model 2090	ETS-Lindgren	64672	300003746	izw	-/-	-/-
6	A	Turntable Interface-Box	Model 105637	ETS-Lindgren	44583	300003747	izw	-/-	-/-
7	A	TRILOG Broadband Test-Antenna 30 MHz - 3 GHz	VULB9163	Schwarzbeck Mess - Elektronik	371	300003854	v IKI!	24.11.2017	23.11.2020
8	A	DC power supply, 60Vdc, 50A, 1200 W	6032A	HP	2818A03450	300001040	v IKI!	12.12.2017	11.12.2020

7.2 Shielded fully anechoic chamber

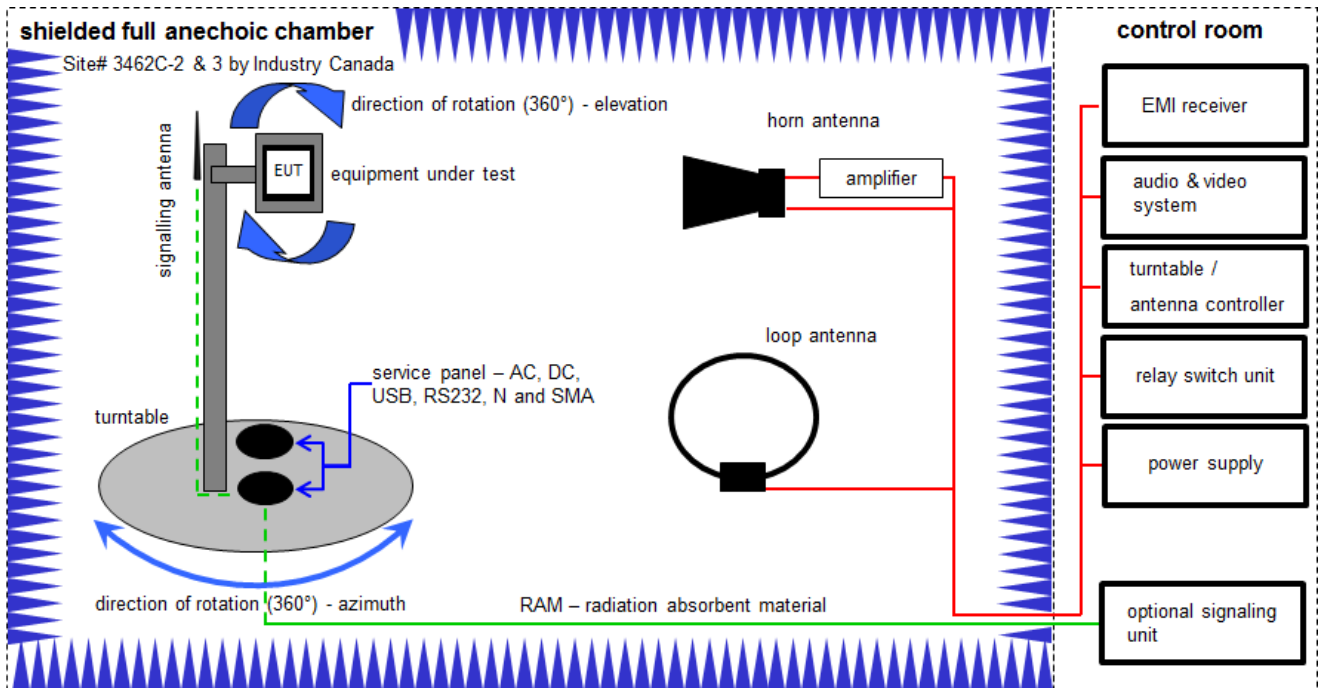

Measurement distance: horn antenna 3 meter; loop antenna 3 meter
EMC32 software version: 10.30.0

FS = UR + CA + AF
(FS-field strength; UR-voltage at the receiver; CA-loss of the signal path; AF-antenna factor)

Example calculation:

$$FS \text{ [dB}\mu\text{V/m]} = 40.0 \text{ [dB}\mu\text{V/m]} + (-35.8) \text{ [dB]} + 32.9 \text{ [dB/m]} = 37.1 \text{ [dB}\mu\text{V/m]} \text{ (} 71.61 \text{ }\mu\text{V/m)}$$

Equipment table:

No.	Lab / Item	Equipment	Type	Manufacturer	Serial No.	INV. No.	Kind of Calibration	Last Calibration	Next Calibration
1	B	Active Loop Antenna 9 kHz to 30 MHz	6502	EMCO	2210	300001015	k	07.07.2017	06.07.2019
2	A, B	Anechoic chamber	FAC 3/5m	MWB / IDK	87400/02	300000996	ev	-/-	-/-
3	A	Double-Ridged Wavguide Horn Antenna 1-18.0GHz	3115	EMCO	9107-3697	300001605	v IKI!	14.02.2017	13.02.2019
4	A, B	Switch / Control Unit	3488A	HP	*	300000199	ne	-/-	-/-
5	A	Band Reject filter	WRCG2400/2483- 2375/2505-50/10SS	Wainwright	11	300003351	ev	-/-	-/-
6	A, B	EMI Test Receiver 20Hz- 26,5GHz	ESU26	R&S	100037	300003555	k	20.12.2017	19.12.2018
7	A	Highpass Filter	WHK1.1/15G-10SS	Wainwright	3	300003255	ev	-/-	-/-
8	A	Highpass Filter	WHKX7.0/18G-8SS	Wainwright	19	300003790	ne	-/-	-/-
9	A	Broadband Amplifier 0.5-18 GHz	CBLU5184540	CERNEX	22049	300004481	ev	-/-	-/-
10	A, B	4U RF Switch Plattorm	L4491A	Agilent Technologies	MY50000037	300004509	ne	-/-	-/-
11	A, B	NEXIO EMV- Software	BAT EMC V3.16.0.49	EMCO	-/-	300004682	ne	-/-	-/-
12	A, B	PC	ExOne	F+W	-/-	300004703	ne	-/-	-/-
13	A, B	DC power supply, 60Vdc, 50A, 1200 W	6032A	HP	2818A03450	300001040	v IKI!	12.12.2017	11.12.2020

7.3 Radiated measurements > 18 GHz

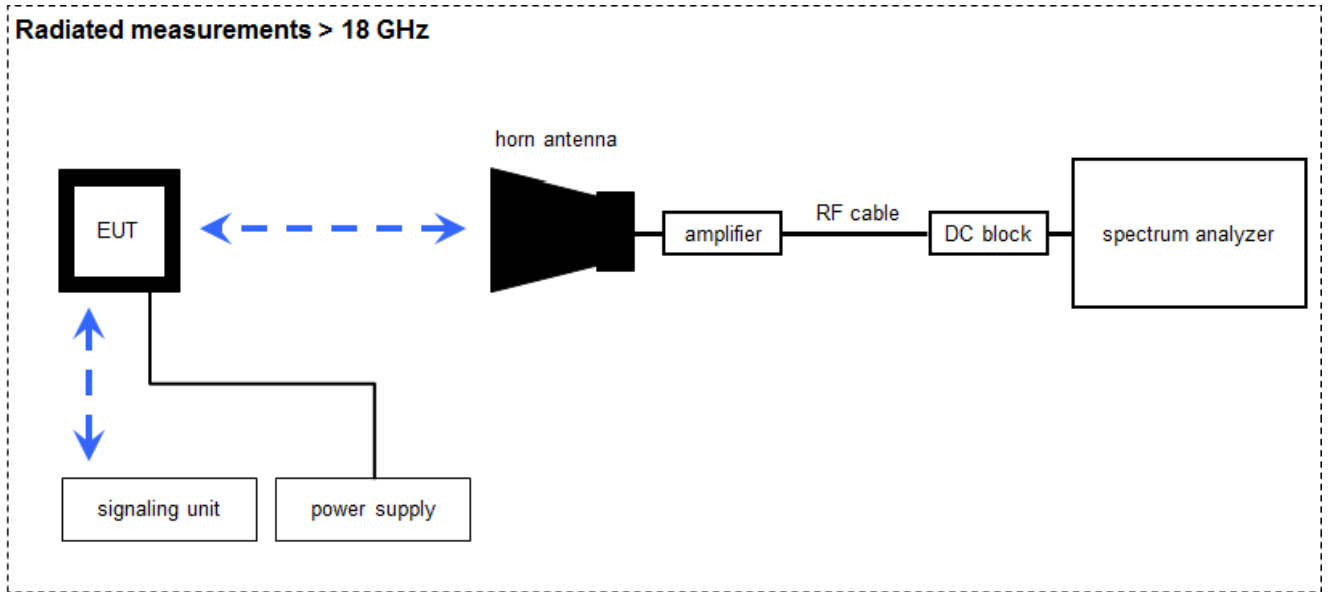

Measurement distance: horn antenna 50 cm

FS = UR + CA + AF

(FS-field strength; UR-voltage at the receiver; CA-loss signal path & distance correction; AF-antenna factor)

Example calculation:

FS [dB μ V/m] = 40.0 [dB μ V/m] + (-60.1) [dB] + 36.74 [dB/m] = 16.64 [dB μ V/m] (6.79 μ V/m)

Equipment table:

No.	Lab / Item	Equipment	Type	Manufacturer	Serial No.	INV. No.	Kind of Calibration	Last Calibration	Next Calibration
1	A	Amplifier 2-40 GHz	JS32-02004000-57-5P	MITEQ	1777200	300004541	ev	-/-	-/-
2	A	RF-Cable	ST118/SMAM/SMAM/48	Huber & Suhner	Batch no. 600918	400001182	ev	-/-	-/-
3	A	RF-Cable	ST118/SMAM/SMAM/48	Huber & Suhner	Batch no. 127377	400001183	ev	-/-	-/-
4	A	DC-Blocker 0.1-40 GHz	8141A	Inmet	-/-	400001185	ev	-/-	-/-
5	A	Std. Gain Horn Antenna 18.0-26.5 GHz	638	Narda	-/-	300000486	k	13.12.2017	12.12.2019
6	A	Signal Analyzer 40 GHz	FSV40	R&S	101042	300004517	k	16.01.2018	15.01.2019

7.4 Conducted measurements

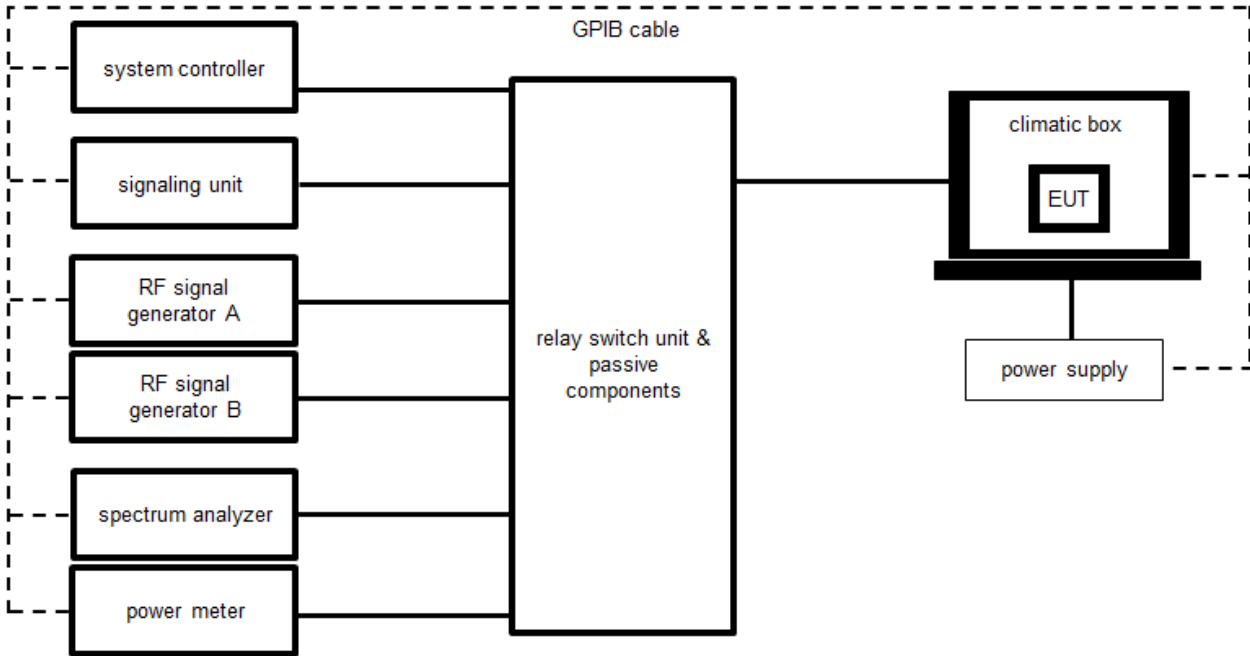

OP = AV + CA
(OP-output power; AV-analyzer value; CA-loss signal path)

Example calculation:

OP [dBm] = 6.0 [dBm] + 11.7 [dB] = 17.7 [dBm] (58.88 mW)

Equipment table:

No.	Lab / Item	Equipment	Type	Manufacturer	Serial No.	INV. No.	Kind of Calibration	Last Calibration	Next Calibration
1	A	USB/GPIB interface	82357B	Agilent Technologies	MY52103346	300004390	ne	-/-	-/-
2	A	PC	Exone	F+W		300004179	ne	-/-	-/-
3	A	Wireless Connectivity Tester	CMW270	Rohde & Schwarz	100683	300005133	k	03.01.2018	02.01.2020
4	A	Spectrum Analyzer	FSV30	Rohde & Schwarz	103809	300005359	k	04.04.2017	03.04.2019
5	A	Relay Switch Matrix	RSM-1	CTC	1	400001355	ev	07.02.2018	06.02.2019
6	A	RF-Cable	ST18/SMAm/SMAm/48	Huber & Suhner	Batch no. 699866	400001189	k	-/-	-/-
7	A	RF-Cable	ST18/SMAm/SMAm/48	Huber & Suhner	Batch no. 14844	400001190	k	-/-	-/-

8 Measurement uncertainty

Measurement uncertainty	
Test case	Uncertainty
Antenna gain	± 3 dB
Spectrum bandwidth	± 21.5 kHz absolute; ± 15.0 kHz relative
Maximum output power	± 1 dB
Detailed conducted spurious emissions @ the band edge	± 1 dB
Band edge compliance radiated	± 3 dB
Band edge compliance conducted	± 1.5 dB
Spurious emissions conducted	± 3 dB
Spurious emissions radiated below 30 MHz	± 3 dB
Spurious emissions radiated 30 MHz to 1 GHz	± 3 dB
Spurious emissions radiated 1 GHz to 12.75 GHz	± 3.7 dB
Spurious emissions radiated above 12.75 GHz	± 4.5 dB
Spurious emissions conducted below 30 MHz (AC conducted)	± 2.6 dB

9 Summary of measurement results

<input type="checkbox"/>	No deviations from the technical specifications were ascertained
<input type="checkbox"/>	There were deviations from the technical specifications ascertained
<input checked="" type="checkbox"/>	This test report is only a partial test report. The content and verdict of the performed test cases are listed below.

TC Identifier	Description	Verdict	Date	Remark
RF-Testing	CFR Part 15 RSS - 247, Issue 2	See table!	2018-07-20	Pretest session

Test specification clause	Test case	Guideline	Temperature conditions	Power source voltages	Mode	C	NC	NA	NP	Remark
§15.247(b)(4) RSS - 247 / 5.4 (4)	System gain	-/-	Nominal	Nominal	1 Msps	<input checked="" type="checkbox"/>	<input type="checkbox"/>	<input type="checkbox"/>	<input type="checkbox"/>	-/-
§15.247(e) RSS - 247 / 5.2 (b)	Power spectral density	KDB 558074 DTS clause: 10.6	Nominal	Nominal	1 Msps 2 Msps	<input checked="" type="checkbox"/>	<input type="checkbox"/>	<input type="checkbox"/>	<input type="checkbox"/>	-/-
§15.247(a)(2) RSS - 247 / 5.2 (a)	DTS bandwidth – 6 dB bandwidth	KDB 558074 DTS clause: 8.1	Nominal	Nominal	1 Msps 2 Msps	<input checked="" type="checkbox"/>	<input type="checkbox"/>	<input type="checkbox"/>	<input type="checkbox"/>	-/-
RSS Gen clause 4.6.1	Occupied bandwidth	-/-	Nominal	Nominal	1 Msps 2 Msps	<input checked="" type="checkbox"/>	<input type="checkbox"/>	<input type="checkbox"/>	<input type="checkbox"/>	-/-
§15.247(b)(3) RSS - 247 / 5.4 (4)	Maximum output power	KDB 558074 DTS clause: 9.1.1	Nominal	Nominal	1 Msps 2 Msps	<input checked="" type="checkbox"/>	<input type="checkbox"/>	<input type="checkbox"/>	<input type="checkbox"/>	-/-
§15.247(d) RSS - 247 / 5.5	Detailed spurious emissions @ the band edge - conducted	-/-	Nominal	Nominal	1 Msps 2 Msps	<input checked="" type="checkbox"/>	<input type="checkbox"/>	<input type="checkbox"/>	<input type="checkbox"/>	-/-
§15.205 RSS - 247 / 5.5 RSS - Gen	Band edge compliance cond. & rad.	KDB 558074 DTS clause: 13.3.2 and clause 12.2.2	Nominal	Nominal	1 Msps 2 Msps	<input checked="" type="checkbox"/>	<input type="checkbox"/>	<input type="checkbox"/>	<input type="checkbox"/>	-/-
§15.247(d) RSS - 247 / 5.5	TX spurious emissions conducted	KDB 558074 DTS clause: 11.1 & 11.2 11.3	Nominal	Nominal	1 Msps 2 Msps	<input checked="" type="checkbox"/>	<input type="checkbox"/>	<input type="checkbox"/>	<input type="checkbox"/>	-/-
§15.209(a) RSS - Gen	Spurious emissions radiated below 30 MHz	-/-	Nominal	Nominal	1 Msps 2 Msps	<input checked="" type="checkbox"/>	<input type="checkbox"/>	<input type="checkbox"/>	<input type="checkbox"/>	-/-
§15.247(d) RSS - 247 / 5.5 §15.109 RSS - Gen	Spurious emissions radiated 30 MHz to 1 GHz	-/-	Nominal	Nominal	1 Msps RX mode	<input checked="" type="checkbox"/>	<input type="checkbox"/>	<input type="checkbox"/>	<input type="checkbox"/>	Only 1 Msps perform ed
§15.247(d) RSS - 247 / 5.5 §15.109 RSS - Gen	Spurious emissions radiated above 1 GHz	-/-	Nominal	Nominal	1 Msps 2 Msps RX mode	<input checked="" type="checkbox"/>	<input type="checkbox"/>	<input type="checkbox"/>	<input type="checkbox"/>	-/-
§15.107(a) §15.207	Conducted emissions below 30 MHz (AC conducted)	-/-	Nominal	Nominal	1 Msps	<input type="checkbox"/>	<input type="checkbox"/>	<input checked="" type="checkbox"/>	<input type="checkbox"/>	-/-

Note: C = Compliant; NC = Not compliant; NA = Not applicable; NP = Not performed

10 Additional comments

The Bluetooth® word mark and logos are owned by the Bluetooth SIG Inc. and any use of such marks by CTC advanced GmbH is under license.

Reference documents: 1-6662_18-01-04_log1_conducted.pdf
(Conducted plots from CTC measurement system)
Test report no. 1-6662_18-01-02

Special test descriptions: None

Configuration descriptions:

Bluetooth Low Energy	
Longest Supported payload (37 – 255 Byte)	Tx: 255, RX: 255
LE 1M PHY supported	Yes
LE 2M PHY supported	Yes
Stable Modulation Index supported (SMI)	No
LE Coded PHY supported (S=2)	No
LE Coded PHY supported (S=8)	No

- Test mode:
- Bluetooth LE Test mode enabled (EUT is controlled by CMW)
 - Special software is used. EUT is transmitting pseudo random data by itself
- Antennas and transmit operating modes:
- Operating mode 1 (single antenna)
 - Equipment with 1 antenna,
 - Equipment with 2 diversity antennas operating in switched diversity mode by which at any moment in time only 1 antenna is used,
 - Smart antenna system with 2 or more transmit/receive chains, but operating in a mode where only 1 transmit/receive chain is used)
 - Operating mode 2 (multiple antennas, no beamforming)
 - Equipment operating in this mode contains a smart antenna system using two or more transmit/receive chains simultaneously but without beamforming.
 - Operating mode 3 (multiple antennas, with beamforming)
 - Equipment operating in this mode contains a smart antenna system using two or more transmit/receive chains simultaneously with beamforming. In addition to the antenna assembly gain (G), the beamforming gain (Y) may have to be taken into account when performing the measurements.

11 Measurement results

11.1 System gain

Limits:

FCC	IC
6 dBi / > 6 dBi output power and power density reduction required	

Results: Extracted from Test report no. 1-6662_18-01-02

T_{nom}	V_{nom}	2402 MHz	2440 MHz	2480 MHz
Gain [dBi] Calculated		0.0	0.1	-1.7

11.2 Power spectral density

Description:

Measurement of the power spectral density of a digital modulated system.

Measurement parameters	
External result file	1-6662_18-01-04_log1_conducted.pdf FCC Part 15.247 Peak Power Spectral Density DTS
Test setup	See sub clause 7.4 A
Measurement uncertainty	See sub clause 8

Limits:

FCC	IC
Power spectral density	
For digitally modulated systems the transmitter power spectral density conducted from the transmitter to the antenna shall not be greater than 8 dBm in any 3 kHz band during any time interval of continuous transmission or over 1.0 second if the transmission exceeds 1.0-second duration.	

Results:

	Frequency		
	2402 MHz	2440 MHz	2480 MHz
Power spectral density [dBm / 3kHz] 1 Msps	-11.2	-11.4	-11.5
Power spectral density [dBm / 3kHz] 2 Msps	-11.9	-11.8	-11.8

11.3 DTS bandwidth – 6 dB bandwidth

Description:

Measurement of the 6 dB bandwidth of the modulated signal.

Measurement parameters	
According to DTS clause: 8.1	
External result file	1-6662_18-01-04_log1_conducted.pdf FCC Part 15.247 Bandwidth 6dB DTS
Test setup	See sub clause 7.4 A
Measurement uncertainty	See sub clause 8

Limits:

FCC	IC
DTS bandwidth – 6 dB bandwidth	
Systems using digital modulation techniques may operate in the 2400–2483.5 MHz band. The minimum 6 dB bandwidth shall be at least 500 kHz.	

Results:

	Frequency		
	2402 MHz	2440 MHz	2480 MHz
6 dB bandwidth [kHz] 1 Msps	674	674	678
6 dB bandwidth [kHz] 2 Msps	1136	1145	1141

11.4 Occupied bandwidth – 99% emission bandwidth

Description:

Measurement of the 99% bandwidth of the modulated signal acc. RSS-GEN.

Measurement parameters	
External result file	1-6662_18-01-04_log1_conducted.pdf FCC Part 15.247 Bandwidth 99PCT
Test setup	See sub clause 7.4 A
Measurement uncertainty	See sub clause 8

Usage:

-/-	IC
Occupied bandwidth – 99% emission bandwidth	
OBW is necessary for emission designator	

Results:

	Frequency		
	2402 MHz	2440 MHz	2480 MHz
99% bandwidth [kHz] 1 Msps	1019	1086	1025
99% bandwidth [kHz] 2 Msps	2040	2040	2040

11.5 Maximum output power

Description:

Measurement of the maximum output power conducted. EUT in single channel mode.

Measurement parameters	
External result file	1-6662_18-01-04_log1_conducted.pdf FCC Part 15.247 Maximum Peak Conducted Output Power DTS
Test setup	See sub clause 7.4 A
Measurement uncertainty	See sub clause 8

Limits:

FCC	IC
Maximum output power	
Conducted: 1.0 W – antenna gain max. 6 dBi	

Results:

	Frequency		
	2402 MHz	2440 MHz	2480 MHz
Maximum output power conducted [dBm] 1 Mps	4.7	4.6	4.5
Maximum output power conducted [dBm] 2 Mps	4.8	4.8	4.6

11.6 Detailed spurious emissions @ the band edge - conducted

Description:

Measurement of the conducted band edge compliance. EUT is measured at the lower and upper band edge in single channel.

Measurement parameters	
External result file	1-6662_18-01-04_log1_conducted.pdf FCC Part 15.247 TX Spurious Conducted
Test setup	See sub clause 7.4 A
Measurement uncertainty	See sub clause 8

Limits:

FCC	IC
In any 100 kHz bandwidth outside the frequency band in which the spread spectrum or digitally modulated intentional radiator is operating, the radio frequency power that is produced by the intentional radiator shall be at least 20 dB below that in the 100 kHz bandwidth within the band that contains the highest level of the desired power, based on either an RF conducted or a radiated measurement. Attenuation below the general limits specified in Section 15.209(a) is not required.	

Results:

Scenario	Spurious band edge conducted [dB]
Data rate	1 Msps
Lower band edge	> 20 dB
Upper band edge	> 20 dB
Data rate	2 Msps
Lower band edge	> 20 dB
Upper band edge	> 20 dB

11.7 Band edge compliance radiated

Description:

Measurement of the radiated band edge compliance. The EUT is turned in the position that results in the maximum level at the band edge. Then a sweep over the corresponding restricted band is performed. The EUT is set to single channel mode and the transmit frequency 2402 MHz for the lower restricted band and 2480 MHz for the upper restricted band. Measurement distance is 3m.

Measurement parameters	
Detector	Peak / RMS
Sweep time	Auto
Resolution bandwidth	1 MHz
Video bandwidth	3 MHz
Span	Lower Band: 2300 – 2400 MHz higher Band: 2480 – 2500 MHz
Trace mode	Max hold
Test setup	See sub clause 7.2 B
Measurement uncertainty	See sub clause 8

Limits:

FCC	IC
Band edge compliance radiated	
<p>In any 100 kHz bandwidth outside the frequency band in which the spread spectrum or digitally modulated intentional radiator is operating, the radio frequency power that is produced by the intentional radiator shall be at least 20 dB below that in the 100 kHz bandwidth within the band that contains the highest level of the desired power, based on either an RF conducted or a radiated measurement. Attenuation below the general limits specified in Section 15.209(a) is not required. In addition, radiated emissions which fall in the restricted bands, as defined in Section 15.205(a), must also comply with the radiated emission limits specified in Section 15.209(a) (see Section 5.205(c)).</p>	
54 dB μ V/m AVG 74 dB μ V/m Peak	

Result:

Scenario	Band edge compliance radiated [dB μ V/m]
Data rate	1 Msps
Lower restricted band	32.4 dB μ V/m AVG 44.0 dB μ V/m Peak
Upper restricted band	46.7 dB μ V/m AVG 59.4 dB μ V/m Peak
Data rate	2 Msps
Lower restricted band	35.0 dB μ V/m AVG 50.3 dB μ V/m Peak
Upper restricted band	48.8 dB μ V/m AVG 58.9 dB μ V/m Peak

Plots:

Plot 1: Lower restricted band, 1 Msps

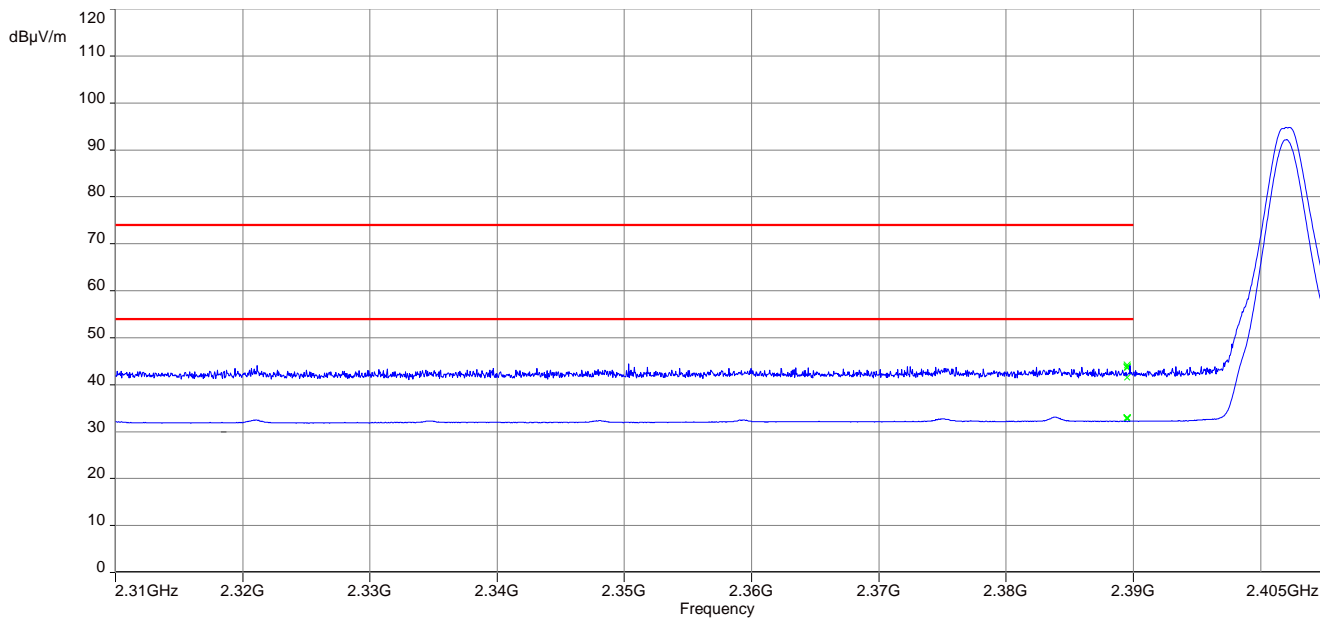

Plot 2: Upper restricted band, 1 Msps

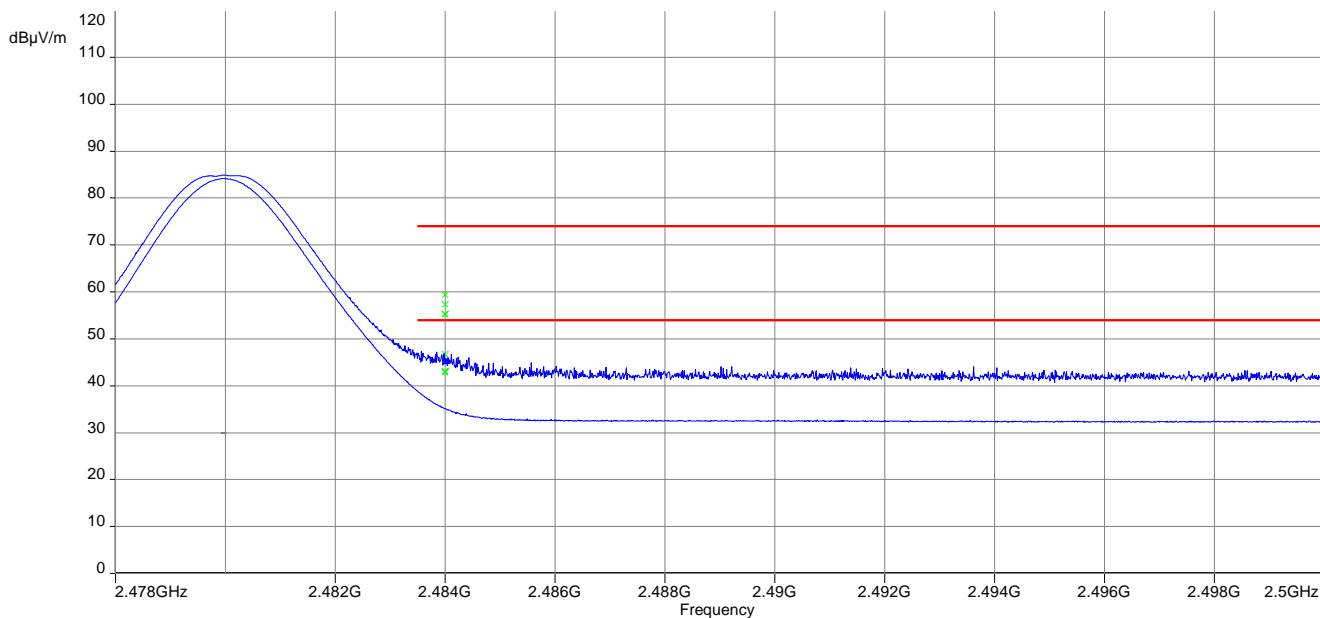

Plot 3: Lower restricted band, 2 Msps

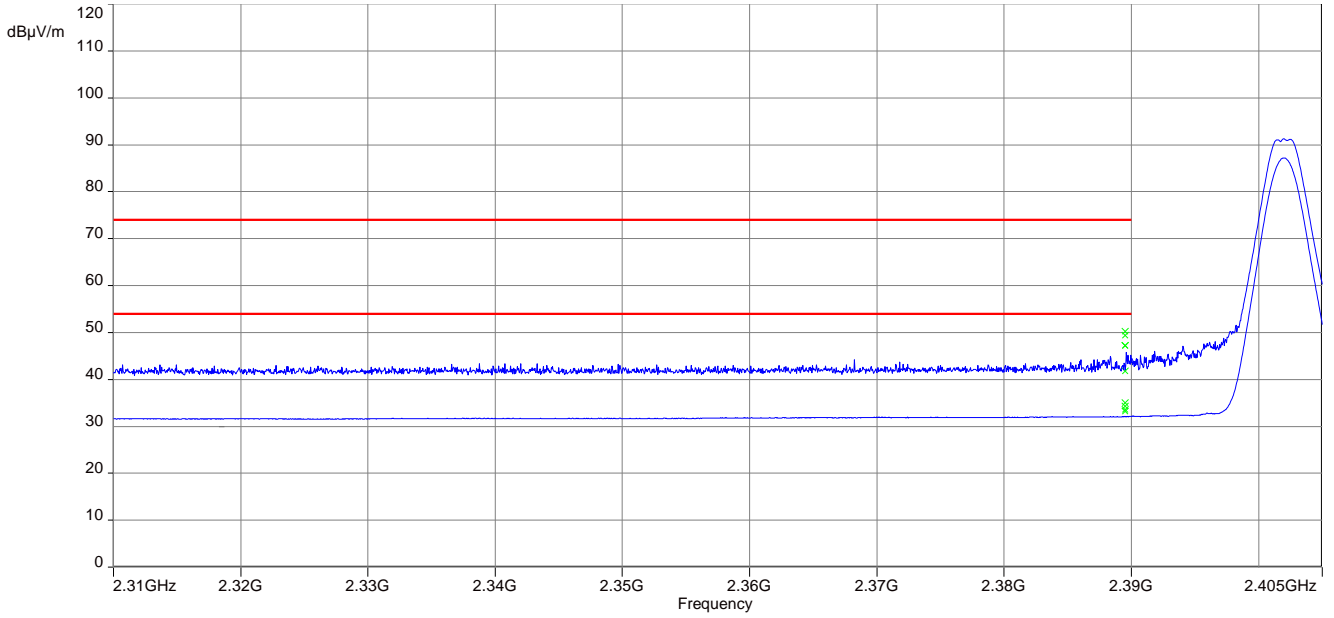

Plot 4: Upper restricted band, 2 Msps

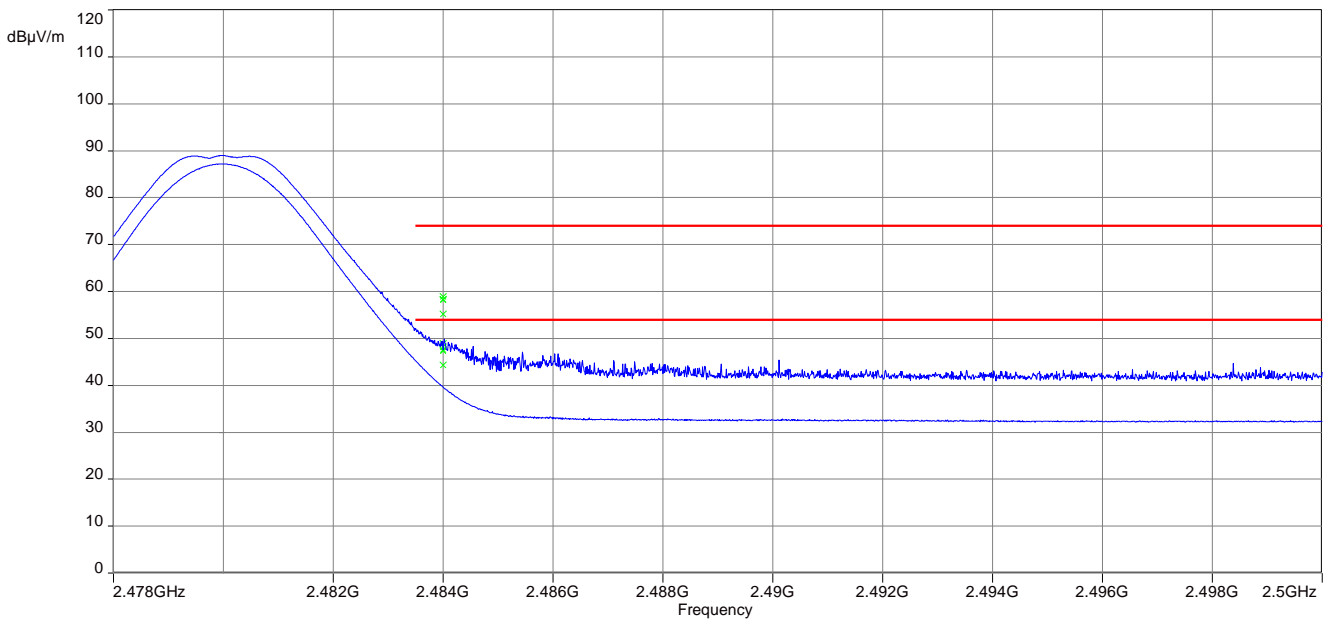

11.8 TX spurious emissions conducted

Description:

Measurement of the conducted spurious emissions in transmit mode. The EUT is set to single channel mode and the transmit frequencies are 2402 MHz, 2440 MHz and 2480 MHz.

Measurement parameters	
External result file	1-6662_18-01-04_log1_conducted.pdf FCC Part 15.247 TX Spurious Conduced
Test setup	See sub clause 7.4 A
Measurement uncertainty	See sub clause 8

Limits:

FCC	IC
TX spurious emissions conducted	
<p>In any 100 kHz bandwidth outside the frequency band in which the spread spectrum or digitally modulated intentional radiator is operating, the radio frequency power that is produced by the intentional radiator shall be at least 20 dB below that in the 100 kHz bandwidth within the band that contains the highest level of the desired power, based on either an RF conducted or a radiated measurement. Attenuation below the general limits specified in Section 15.209(a) is not required</p>	

Results: 1 Msps

TX spurious emissions conducted					
f [MHz]		amplitude of emission [dBm]	limit max. allowed emission power	actual attenuation below frequency of operation [dB]	results
2402		2.6	30 dBm		Operating frequency
All detected emissions are compliant with the -20 dBc limit!			-20 dBc		compliant
2440		3.0	30 dBm		Operating frequency
All detected emissions are compliant with the -20 dBc limit!			-20 dBc		compliant
2480		3.5	30 dBm		Operating frequency
All detected emissions are compliant with the -20 dBc limit!			-20 dBc		compliant

Results: 2 Msps

TX spurious emissions conducted					
f [MHz]		amplitude of emission [dBm]	limit max. allowed emission power	actual attenuation below frequency of operation [dB]	results
2402		3.0	30 dBm		Operating frequency
All detected emissions are compliant with the -20 dBc limit!			-20 dBc		compliant
2440		3.4	30 dBm		Operating frequency
All detected emissions are compliant with the -20 dBc limit!			-20 dBc		compliant
2480		1.0	30 dBm		Operating frequency
All detected emissions are compliant with the -20 dBc limit!			-20 dBc		compliant

11.9 Spurious emissions radiated below 30 MHz

Description:

Measurement of the radiated spurious emissions in transmit mode below 30 MHz. The EUT is set to single channel mode and the transmit frequencies are 2402 MHz, 2440 MHz and 2480 MHz. The limits are recalculated to a measurement distance of 3 m according the ANSI C63.10.

Measurement parameters	
Detector	Peak / Quasi peak
Sweep time	Auto
Resolution bandwidth	F < 150 kHz: 200 Hz F > 150 kHz: 9 kHz
Video bandwidth	F < 150 kHz: 1 kHz F > 150 kHz: 30 kHz
Span	9 kHz to 30 MHz
Trace mode	Max hold
Test setup	See sub clause 7.2 B
Measurement uncertainty	See sub clause 8

Limits:

FCC		IC
TX spurious emissions radiated below 30 MHz		
Frequency (MHz)	Field strength (dBµV/m)	Measurement distance
0.009 – 0.490	2400/F(kHz)	300
0.490 – 1.705	24000/F(kHz)	30
1.705 – 30.0	30	30

Results:

TX spurious emissions radiated below 30 MHz [dBµV/m]		
F [MHz]	Detector	Level [dBµV/m]
All detected emissions are more than 20 dB below the limit.		

Plots:

Plot 1: 9 kHz to 30 MHz, 2402 MHz, transmit mode, 1 Msps

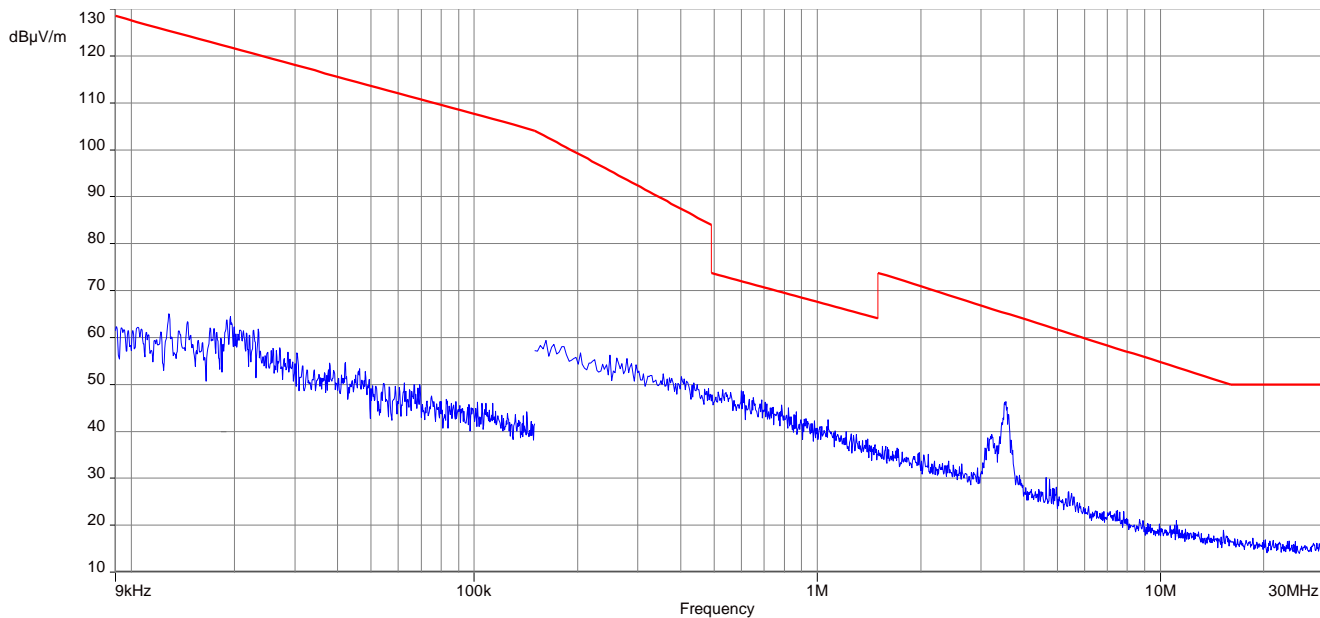

Plot 2: 9 kHz to 30 MHz, 2440 MHz, transmit mode, 1 Msps

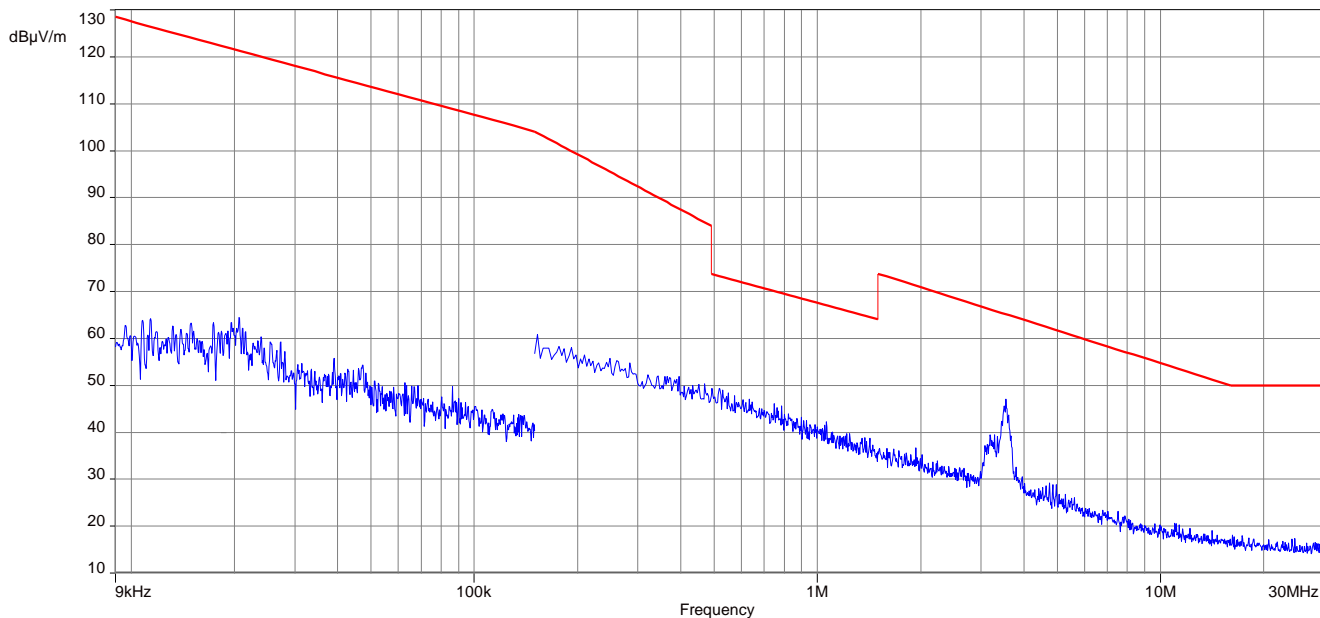

Plot 3: 9 kHz to 30 MHz, 2480 MHz, transmit mode, 1 Msps

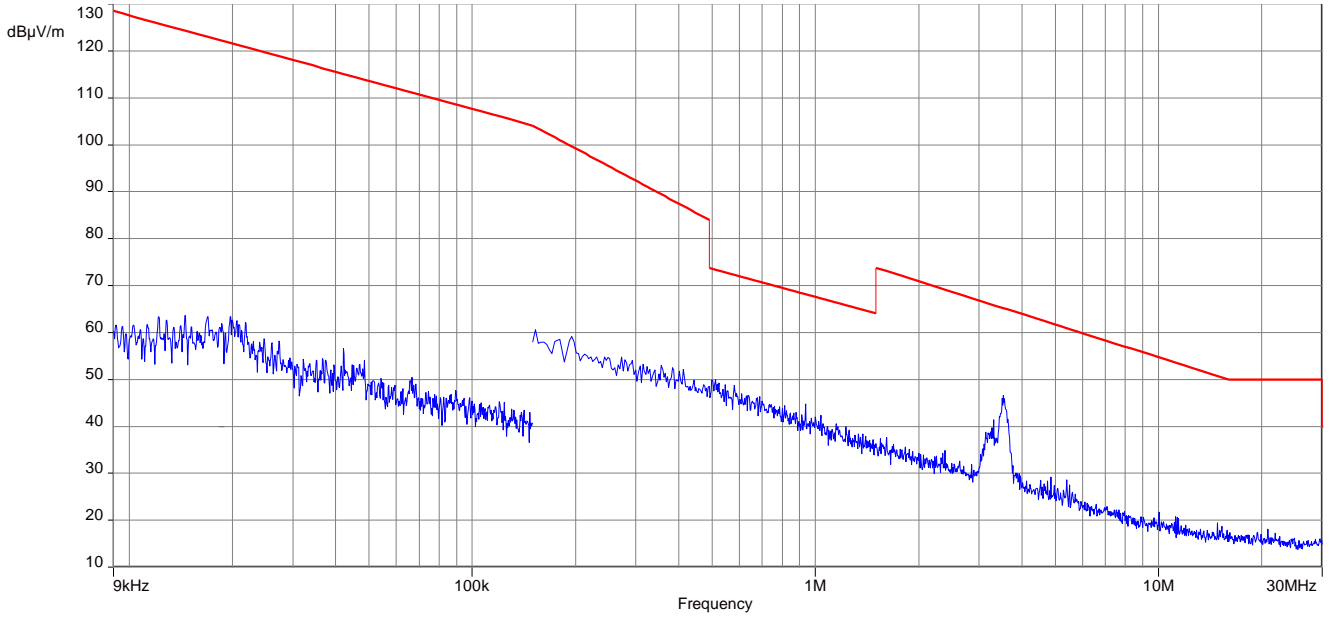

Plot 4: 9 kHz to 30 MHz, 2402 MHz, transmit mode, 2 Msps

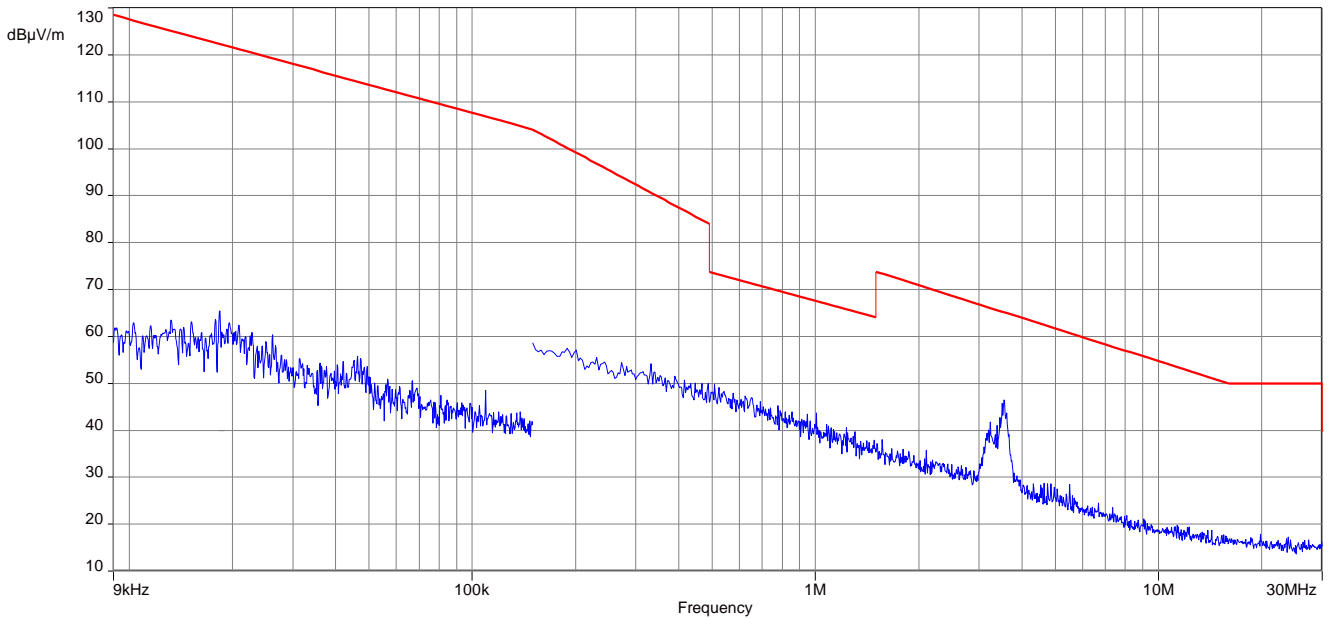

Plot 5: 9 kHz to 30 MHz, 2440 MHz, transmit mode, 2 Msps

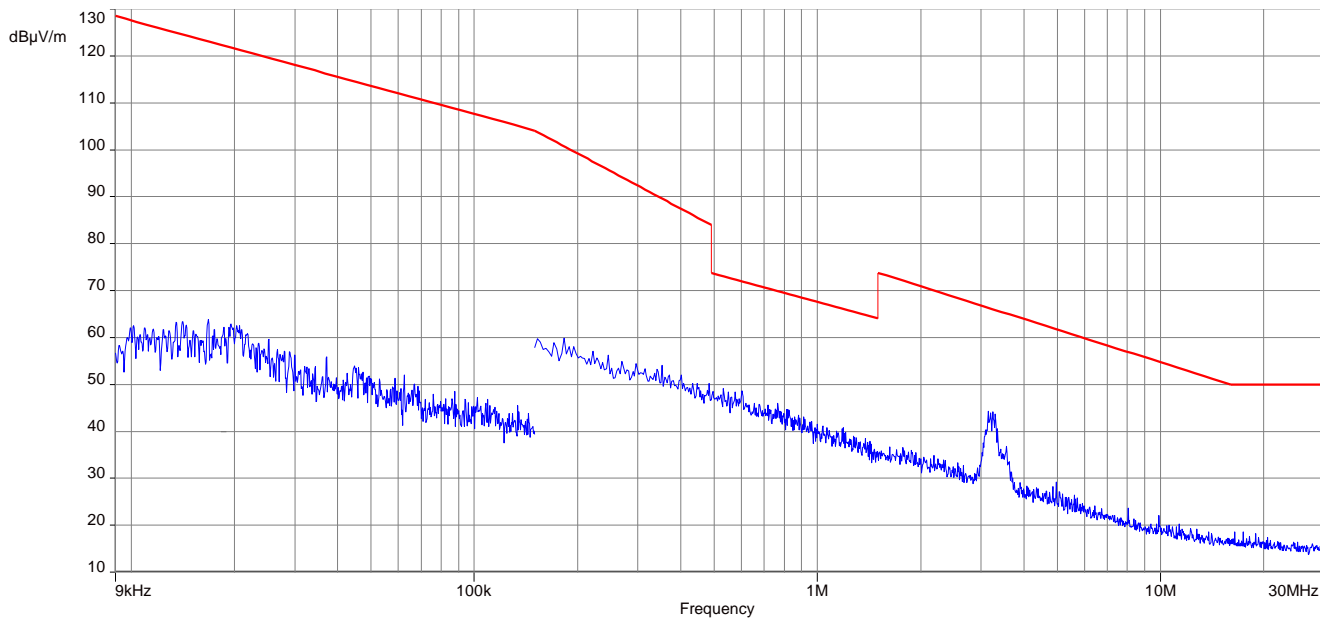

Plot 6: 9 kHz to 30 MHz, 2480 MHz, transmit mode, 2 Msps

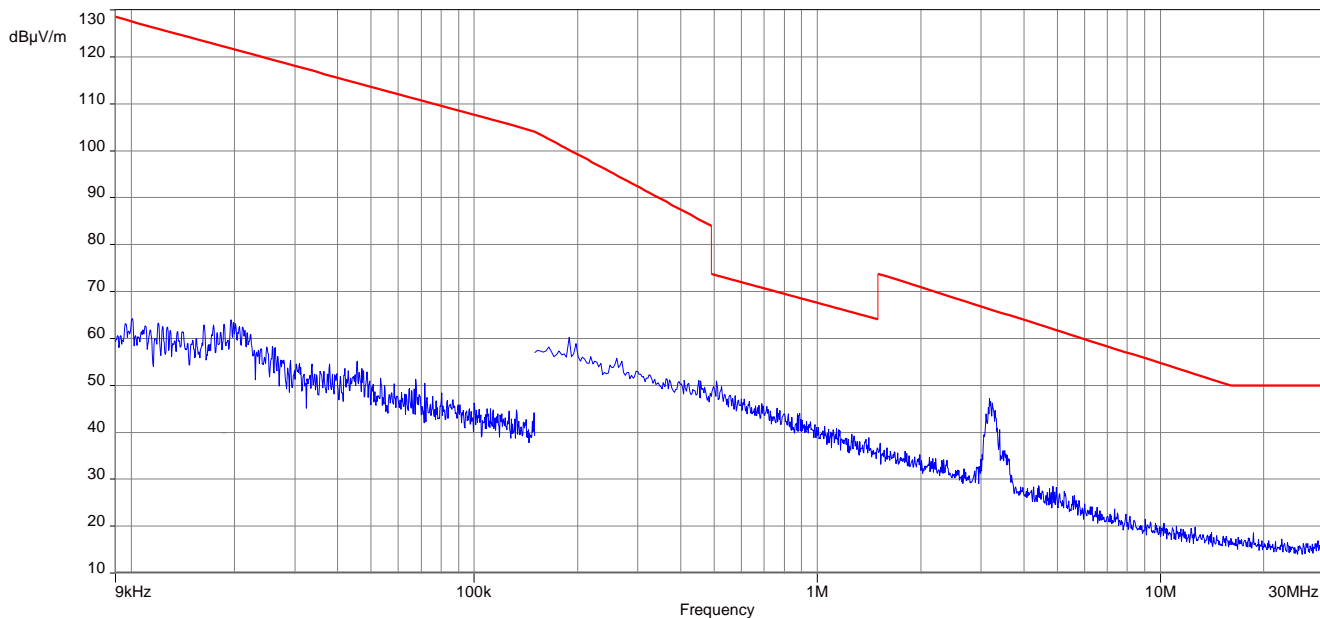

11.10 Spurious emissions radiated 30 MHz to 1 GHz

Description:

Measurement of the radiated spurious emissions in transmit mode. The EUT is set to single channel mode and the transmit frequencies are 2402 MHz, 2440 MHz and 2480 MHz.

Measurement parameters	
Detector	Peak / Quasi Peak
Sweep time	Auto
Resolution bandwidth	120 kHz
Video bandwidth	3 x RBW
Span	30 MHz to 1 GHz
Trace mode	Max hold
Measured modulation	GFSK
Test setup	See sub clause 7.1 A
Measurement uncertainty	See sub clause 8

Limits:

FCC	IC	
TX spurious emissions radiated		
In any 100 kHz bandwidth outside the frequency band in which the spread spectrum or digitally modulated intentional radiator is operating, the radio frequency power that is produced by the intentional radiator shall be at least 20 dB below that in the 100 kHz bandwidth within the band that contains the highest level of the desired power, based on either an RF conducted or a radiated measurement. Attenuation below the general limits specified in Section 15.209(a) is not required. In addition, radiated emissions which fall in the restricted bands, as defined in §15.205(a), must also comply with the radiated emission limits specified in §15.209(a) (see §15.205(c)).		
§15.209		
Frequency (MHz)	Field strength (dB μ V/m)	Measurement distance
30 - 88	30.0	10
88 – 216	33.5	10
216 – 960	36.0	10
Above 960	54.0	3

Plots: Transmit mode

Plot 1: 30 MHz to 1 GHz, TX mode, 2402 MHz, vertical & horizontal polarization, 1 Msp/s

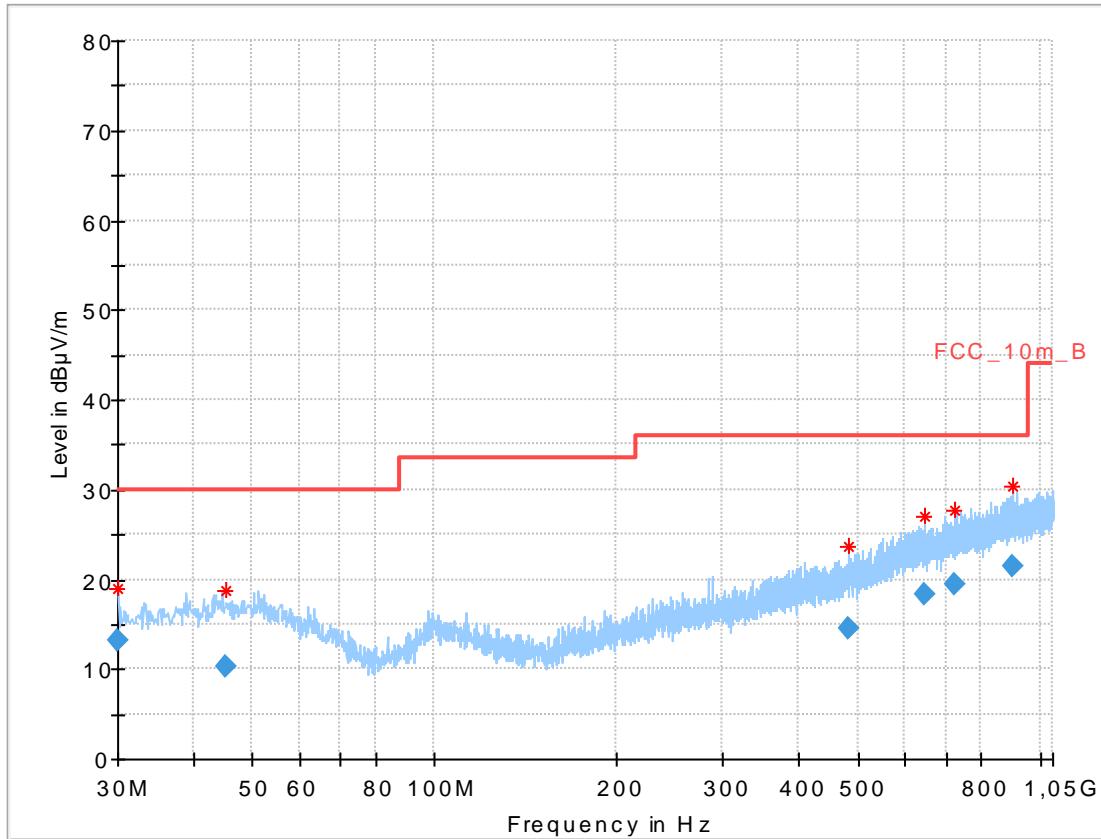

Final results:

Frequency (MHz)	QuasiPeak (dBµV/m)	Limit (dBµV/m)	Margin (dB)	Meas. Time (ms)	Bandwidth (kHz)	Height (cm)	Pol	Azimuth (deg)	Corr. (dB)
30.006	13.18	30.0	16.82	1000	120	170.0	V	180.0	11.8
45.156	10.35	30.0	19.65	1000	120	170.0	H	180.0	13.6
484.126	14.52	36.0	21.48	1000	120	170.0	H	270.0	18.4
647.338	18.31	36.0	17.69	1000	120	170.0	H	0.0	21.1
721.957	19.41	36.0	16.59	1000	120	98.0	H	0.0	22.1
903.418	21.37	36.0	14.63	1000	120	98.0	V	90.0	24.2

Plot 2: 30 MHz to 1 GHz, TX mode, 2440 MHz, vertical & horizontal polarization, 1 Msp/s

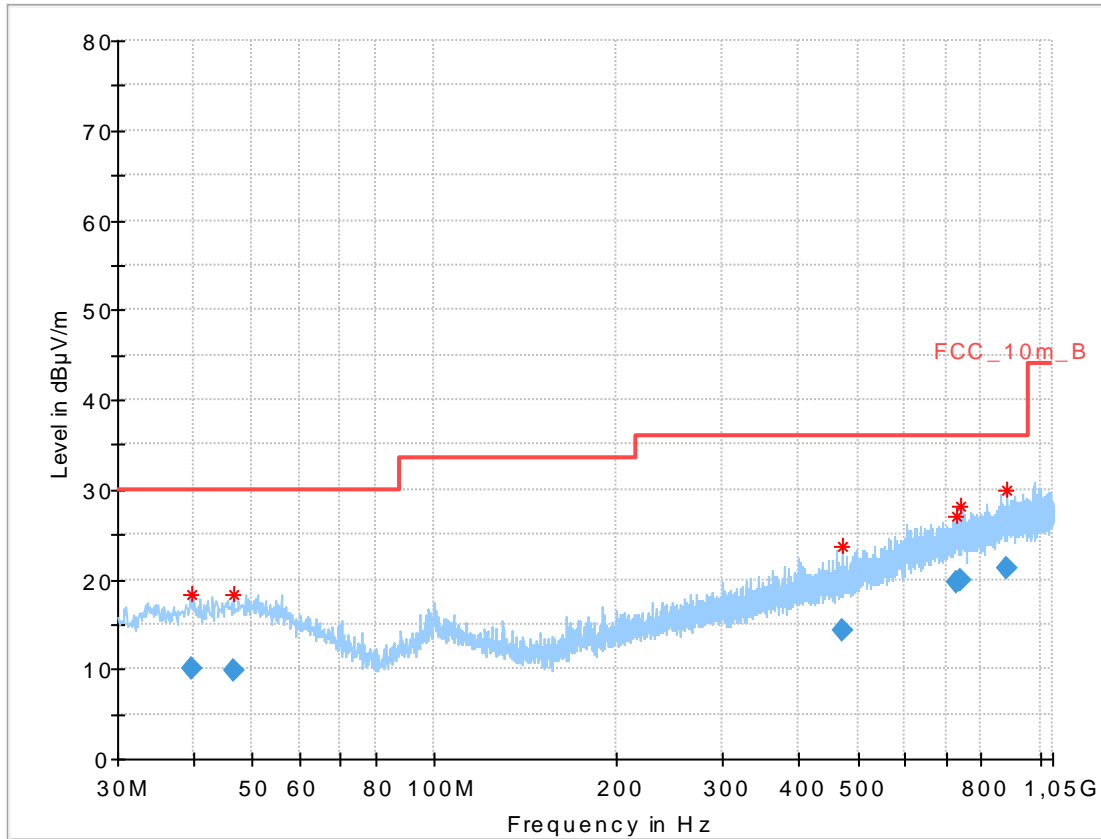

Final results:

Frequency (MHz)	QuasiPeak (dBµV/m)	Limit (dBµV/m)	Margin (dB)	Meas. Time (ms)	Bandwidth (kHz)	Height (cm)	Pol	Azimuth (deg)	Corr. (dB)
39.669	10.10	30.0	19.90	1000	120	101.0	V	0.0	13.2
46.519	9.81	30.0	20.19	1000	120	170.0	V	180.0	13.7
470.867	14.19	36.0	21.81	1000	120	170.0	H	90.0	18.1
728.193	19.60	36.0	16.40	1000	120	170.0	V	0.0	22.2
741.173	19.78	36.0	16.22	1000	120	170.0	H	180.0	22.5
882.185	21.32	36.0	14.68	1000	120	170.0	H	180.0	24.0

Plot 3: 30 MHz to 1 GHz, TX mode, 2480 MHz, vertical & horizontal polarization, 1 Mps

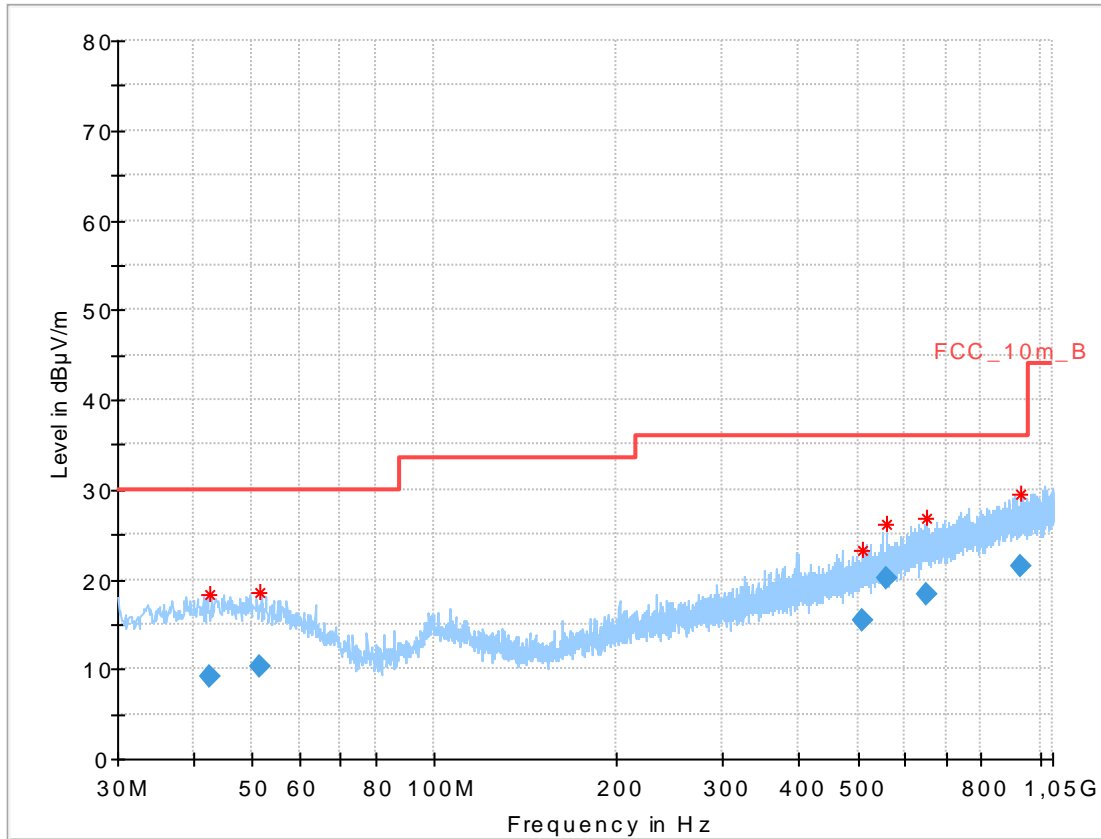

Final results:

Frequency (MHz)	QuasiPeak (dBµV/m)	Limit (dBµV/m)	Margin (dB)	Meas. Time (ms)	Bandwidth (kHz)	Height (cm)	Pol	Azimuth (deg)	Corr. (dB)
42.651	9.27	30.0	20.73	1000	120	170.0	H	0.0	13.4
51.385	10.39	30.0	19.61	1000	120	101.0	V	270.0	13.6
509.306	15.42	36.0	20.58	1000	120	98.0	V	90.0	18.8
560.010	20.21	36.0	15.79	1000	120	170.0	H	180.0	19.6
650.039	18.34	36.0	17.66	1000	120	170.0	H	90.0	21.1
927.036	21.38	36.0	14.62	1000	120	98.0	H	90.0	24.3

Plots: Receiver mode

Plot 1: 30 MHz to 1 GHz, RX / idle – mode, vertical & horizontal polarization

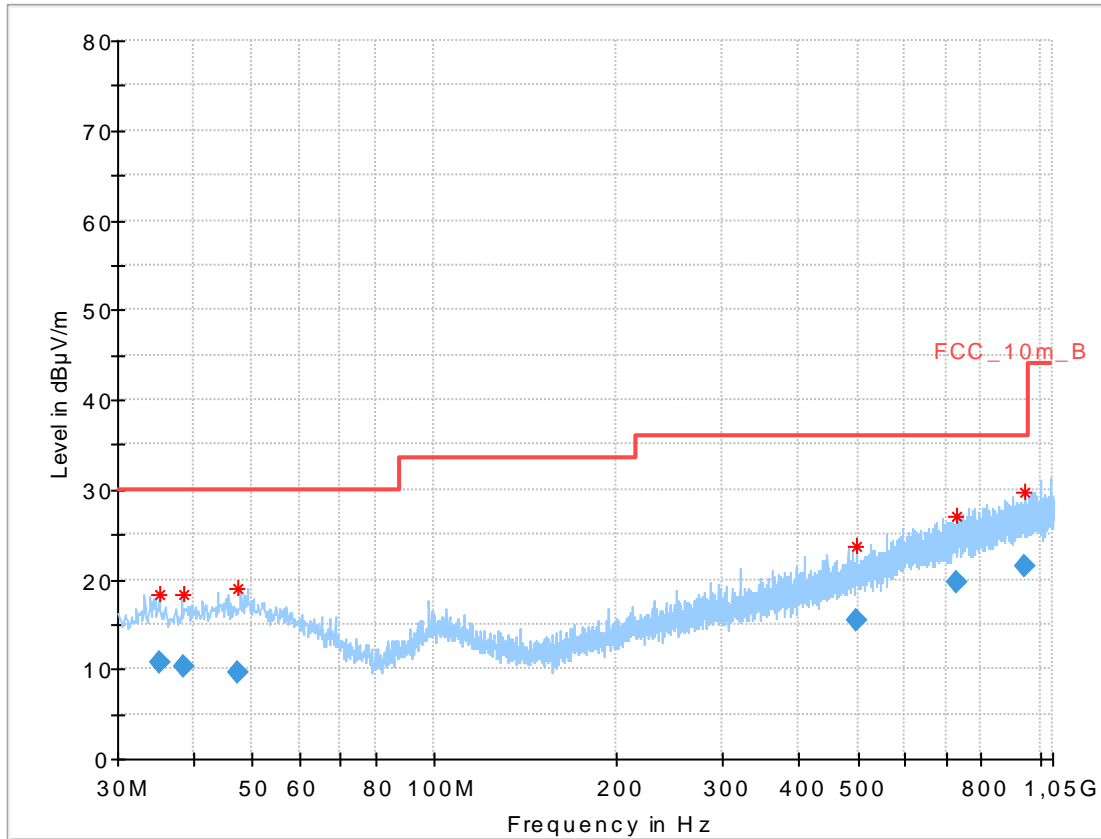

Final results:

Frequency (MHz)	QuasiPeak (dBµV/m)	Limit (dBµV/m)	Margin (dB)	Meas. Time (ms)	Bandwidth (kHz)	Height (cm)	Pol	Azimuth (deg)	Corr. (dB)
35.073	10.82	30.0	19.18	1000	120	98.0	V	0.0	12.7
38.595	10.31	30.0	19.69	1000	120	101.0	V	0.0	13.1
47.417	9.53	30.0	20.47	1000	120	170.0	H	180.0	13.7
499.549	15.36	36.0	20.64	1000	120	98.0	H	90.0	18.7
728.735	19.66	36.0	16.34	1000	120	98.0	V	90.0	22.2
944.329	21.48	36.0	14.52	1000	120	170.0	V	180.0	24.3

11.11 Spurious emissions radiated above 1 GHz

Description:

Measurement of the radiated spurious emissions in transmit mode. The EUT is set to single channel mode and the transmit frequencies are 2402 MHz, 2440 MHz and 2480 MHz.

Measurement parameters	
Detector	Peak / RMS
Sweep time	Auto
Resolution bandwidth	1 MHz
Video bandwidth	3 x RBW
Span	1 GHz to 26 GHz
Trace mode	Max hold
Measured modulation	GFSK
Test setup	See sub clause 7.2 A (1 GHz - 18 GHz) See sub clause 7.3 A (18 GHz - 26 GHz)
Measurement uncertainty	See sub clause 8

Limits:

FCC	IC	
TX spurious emissions radiated		
In any 100 kHz bandwidth outside the frequency band in which the spread spectrum or digitally modulated intentional radiator is operating, the radio frequency power that is produced by the intentional radiator shall be at least 20 dB below that in the 100 kHz bandwidth within the band that contains the highest level of the desired power, based on either an RF conducted or a radiated measurement. Attenuation below the general limits specified in Section 15.209(a) is not required. In addition, radiated emissions which fall in the restricted bands, as defined in §15.205(a), must also comply with the radiated emission limits specified in §15.209(a) (see §15.205(c)).		
§15.209		
Frequency (MHz)	Field strength (dBµV/m)	Measurement distance
Above 960	54.0 (Average)	3
Above 960	74.0 (Peak)	3

Results: Transmitter mode, 1 Msps

TX spurious emissions radiated [dBµV/m]								
2402 MHz			2440 MHz			2480 MHz		
F [MHz]	Detector	Level [dBµV/m]	F [MHz]	Detector	Level [dBµV/m]	F [MHz]	Detector	Level [dBµV/m]
12012	Peak	51.5	12198	Peak	52.0	7439	Peak	47.6
	AVG	42.7		AVG	43.8		AVG	37.1
16813*	Peak	58.5		Peak		12399	Peak	53.5
	AVG	52.4		AVG			AVG	46.1
	Peak			Peak			Peak	
	AVG			AVG			AVG	

* The emission is not in a restricted band.

Results: Transmitter mode, 2 Msps

TX spurious emissions radiated [dBµV/m]								
2402 MHz			2440 MHz			2480 MHz		
F [MHz]	Detector	Level [dBµV/m]	F [MHz]	Detector	Level [dBµV/m]	F [MHz]	Detector	Level [dBµV/m]
12012	Peak	51.5	12200	Peak	52.0	12402	Peak	52.2
	AVG	42.7		AVG	43.5		AVG	43.5
	Peak			Peak			Peak	
	AVG			AVG			AVG	
	Peak			Peak			Peak	
	AVG			AVG			AVG	

Results: Receiver mode

RX spurious emissions radiated [dBµV/m]		
F [MHz]	Detector	Level [dBµV/m]
All detected emissions are more than 20 dB below the limit.		
	Peak	
	AVG	

Note: The limit was recalculated with 20 dB / decade (Part 15.31) for all radiated spurious emissions 30 MHz to 1 GHz from 3 meter limit to a 10 meter distance. (40dB/decade for emissions < 30MHz)

Plots: Transmitter mode

Plot 1: 1 GHz to 18 GHz, TX mode, 2402 MHz, vertical & horizontal polarization, 1 Msps

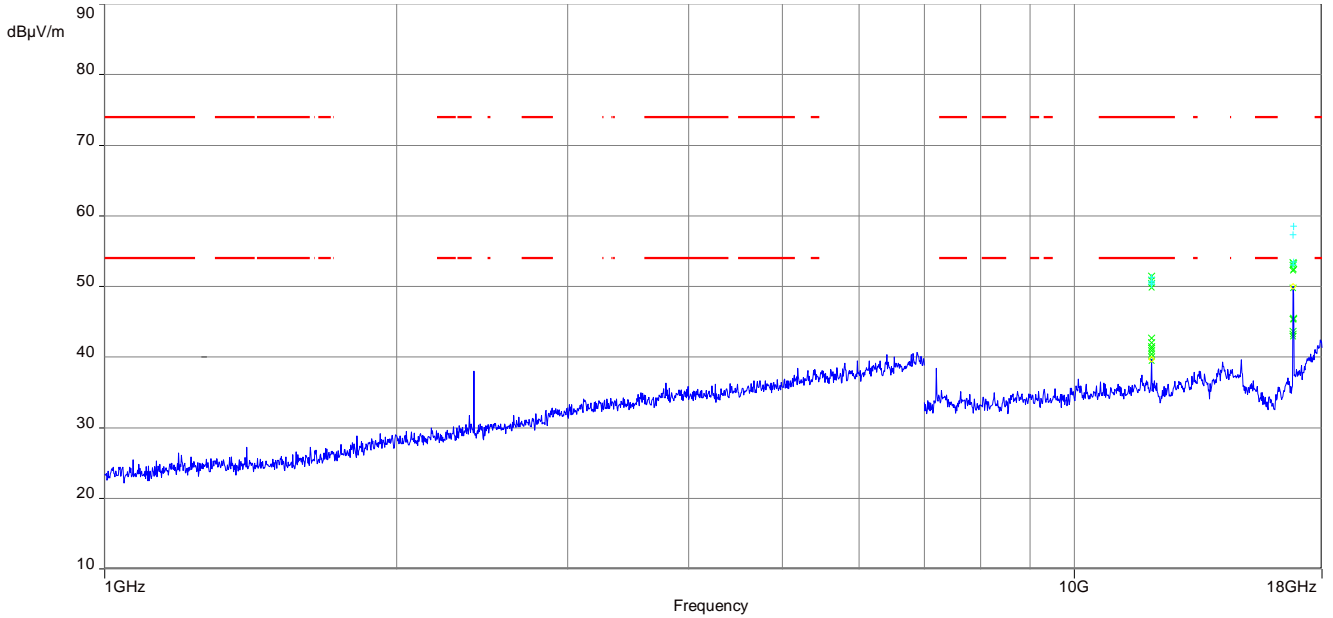

The carrier signal is notched with a 2.4 GHz band rejection filter.

Plot 2: 18 GHz to 26 GHz, TX mode, 2402 MHz, vertical & horizontal polarization, 1 Msps

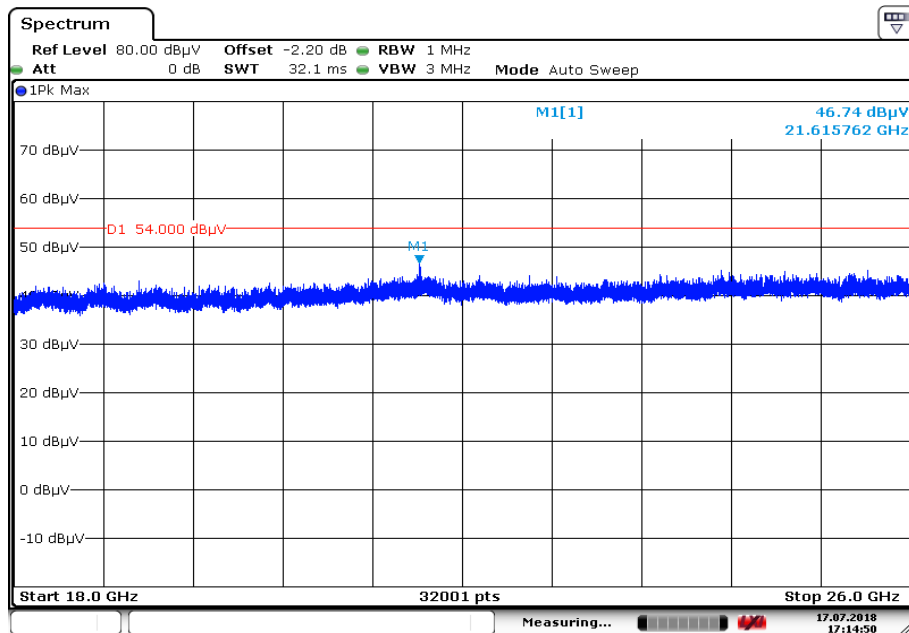

Date: 17 JUL 2018 17:14:50

Plot 3: 1 GHz to 18 GHz, TX mode, 2440 MHz, vertical & horizontal polarization, 1 Msps

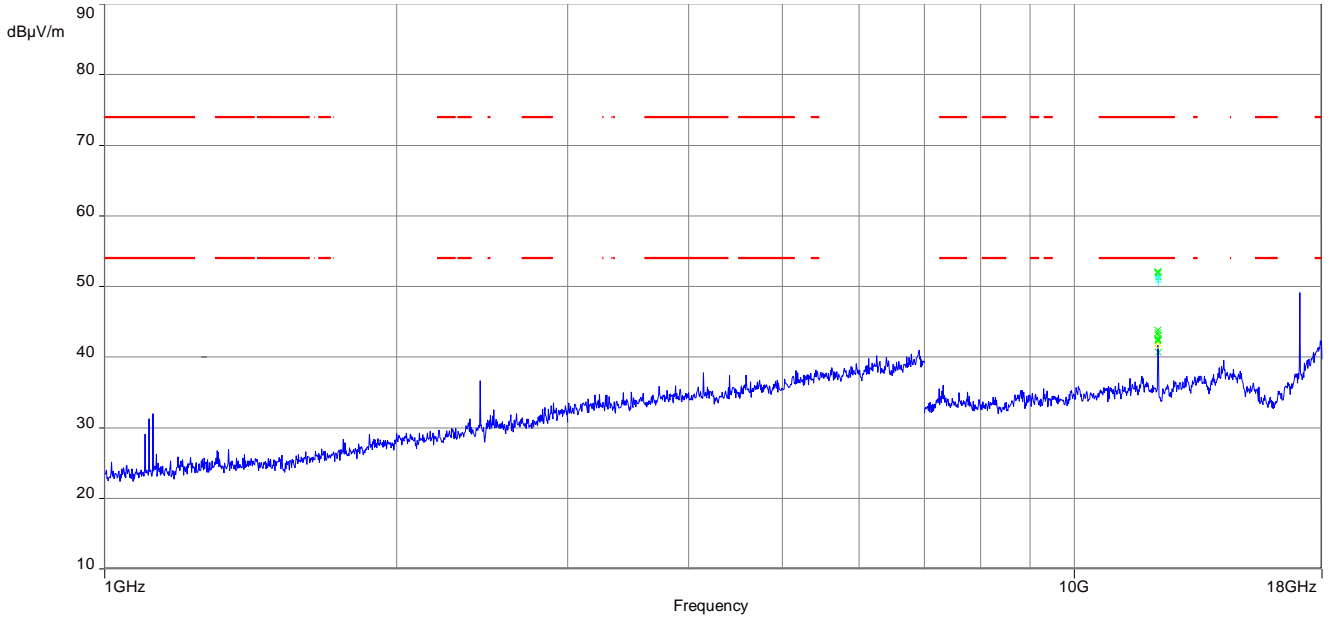

The carrier signal is notched with a 2.4 GHz band rejection filter.

Plot 4: 18 GHz to 26 GHz, TX mode, 2440 MHz, vertical & horizontal polarization, 1 Msps

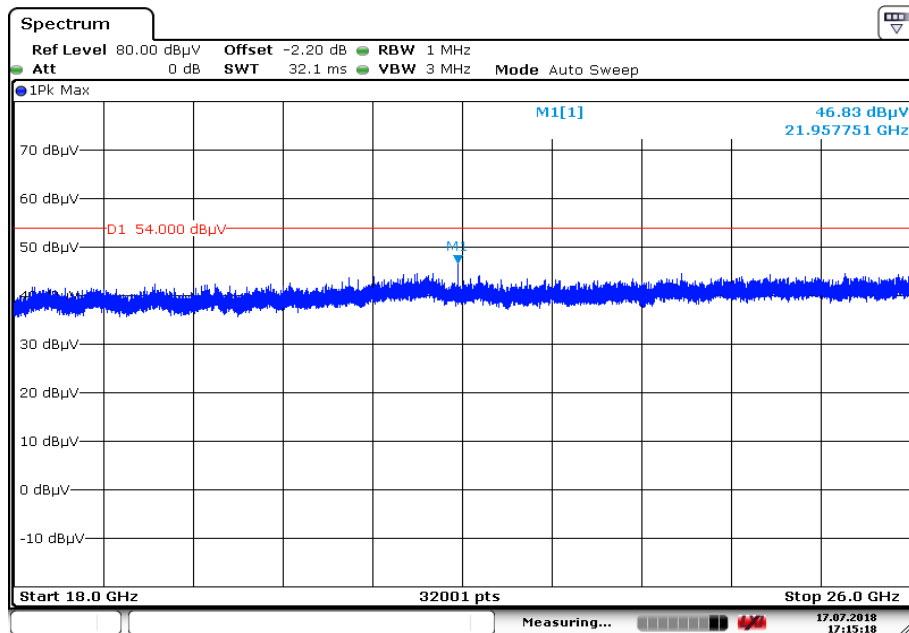

Date: 17 JUL 2018 17:15:18

Plot 5: 1 GHz to 18 GHz, TX mode, 2480 MHz, vertical & horizontal polarization, 1 Msps

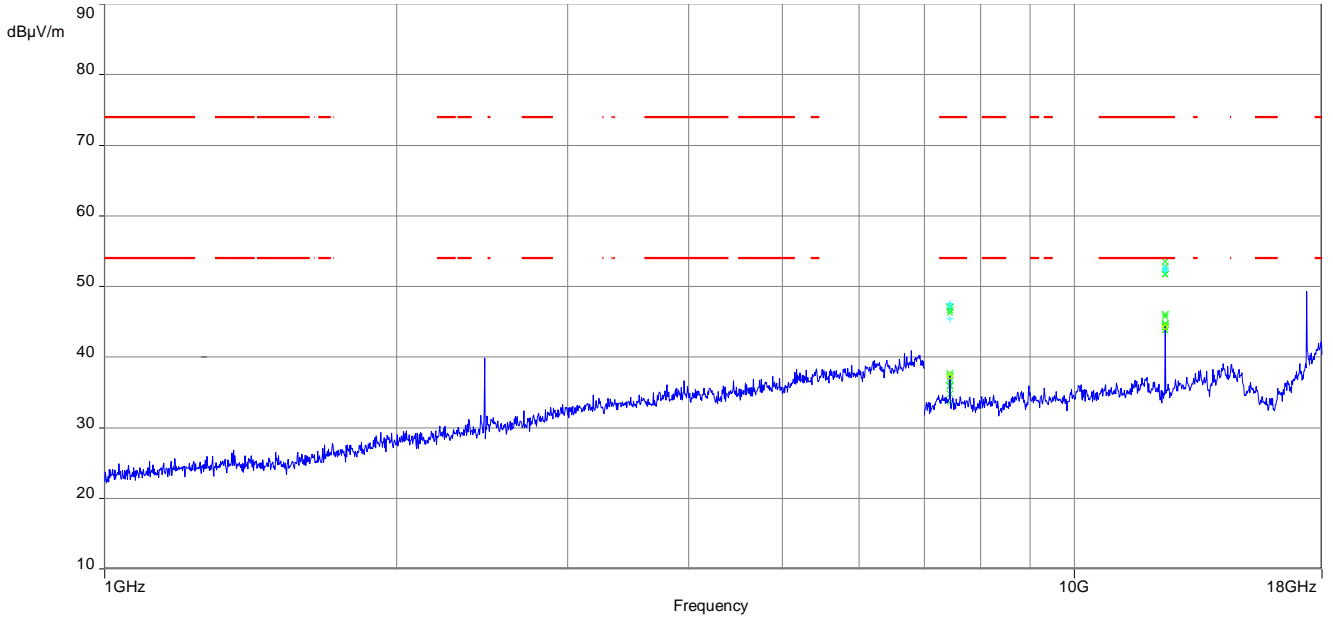

The carrier signal is notched with a 2.4 GHz band rejection filter.

Plot 6: 18 GHz to 26 GHz, TX mode, 2480 MHz, vertical & horizontal polarization, 1 Msps

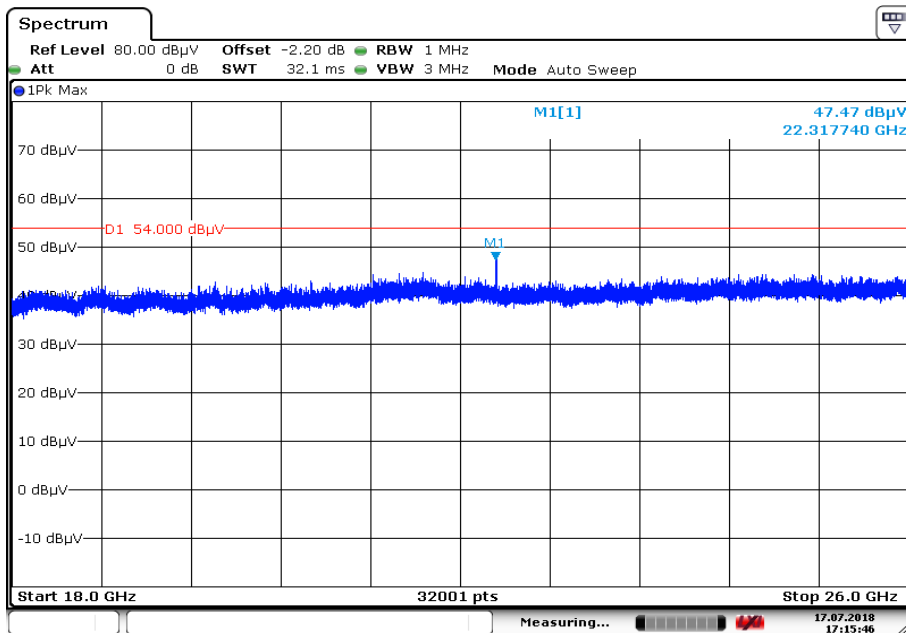

Date: 17 JUL 2018 17:15:46

Plot 7: 1 GHz to 18 GHz, TX mode, 2402 MHz, vertical & horizontal polarization, 2 Msps

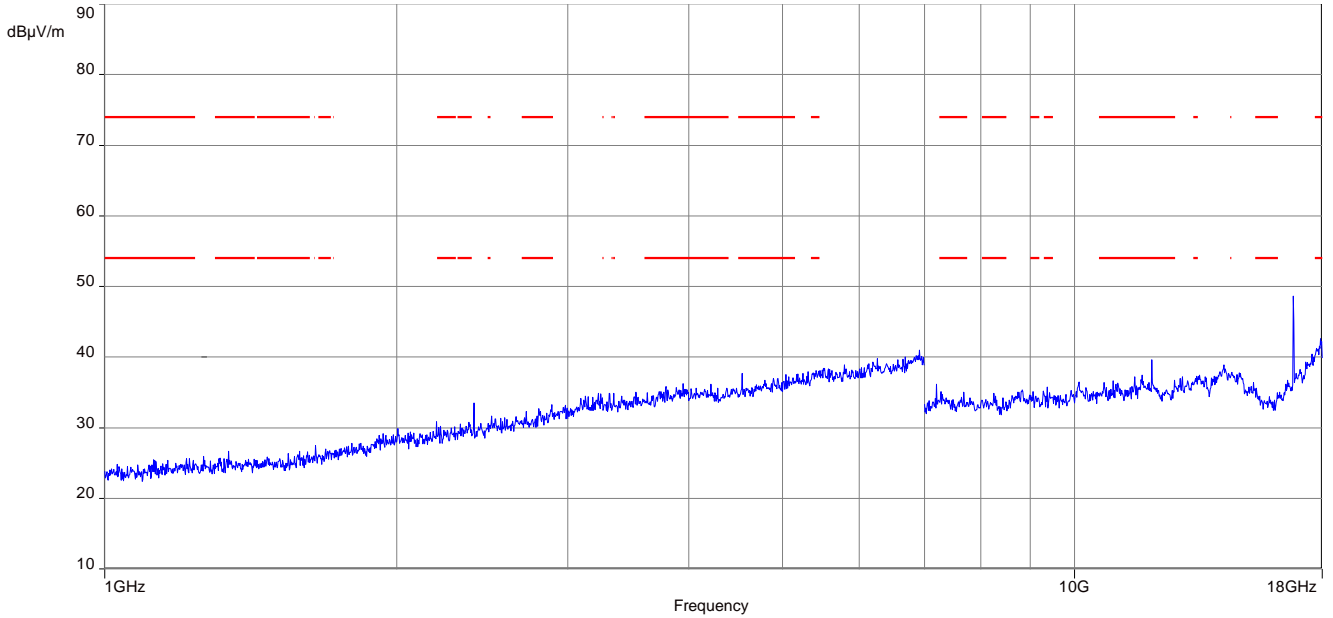

The carrier signal is notched with a 2.4 GHz band rejection filter.

Plot 8: 18 GHz to 26 GHz, TX mode, 2402 MHz, vertical & horizontal polarization, 2 Msps

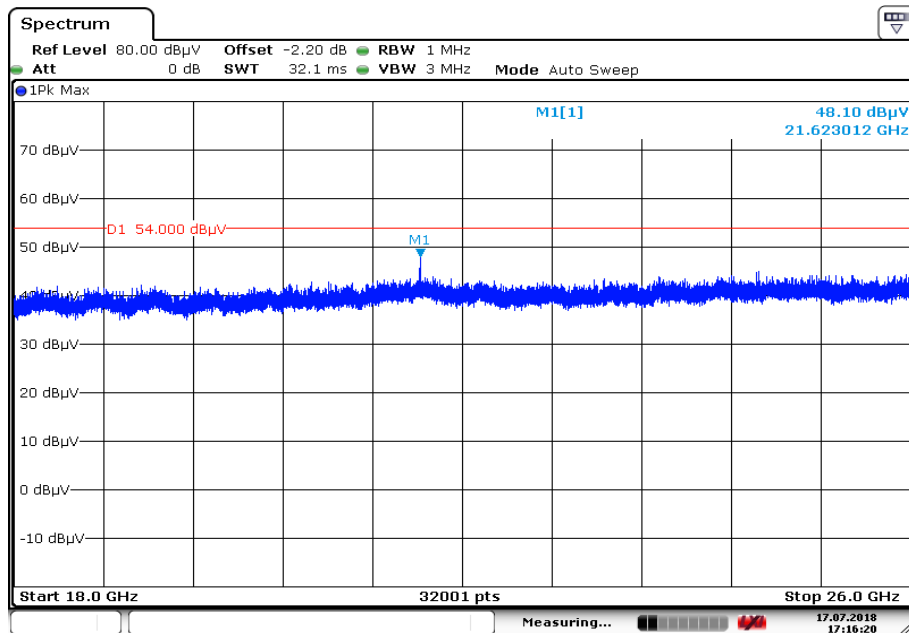

Date: 17 JUL 2018 17:16:21

Plot 9: 1 GHz to 18 GHz, TX mode, 2440 MHz, vertical & horizontal polarization, 2 Msps

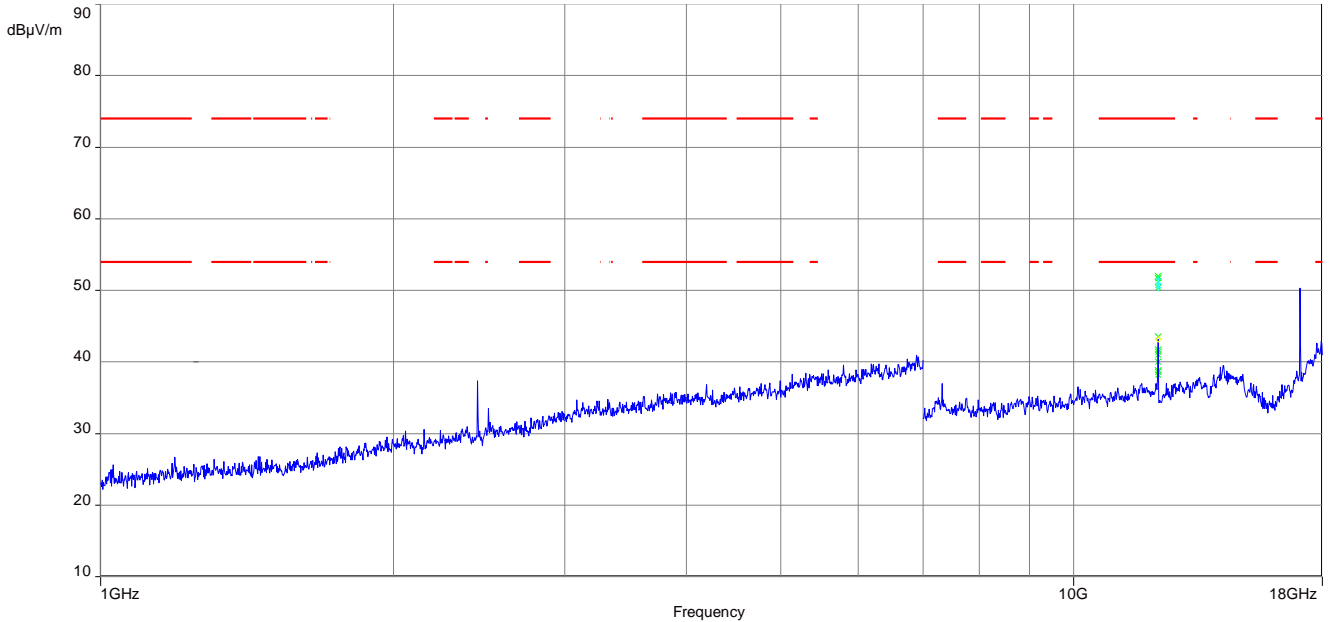

The carrier signal is notched with a 2.4 GHz band rejection filter.

Plot 10: 18 GHz to 26 GHz, TX mode, 2440 MHz, vertical & horizontal polarization, 2 Msps

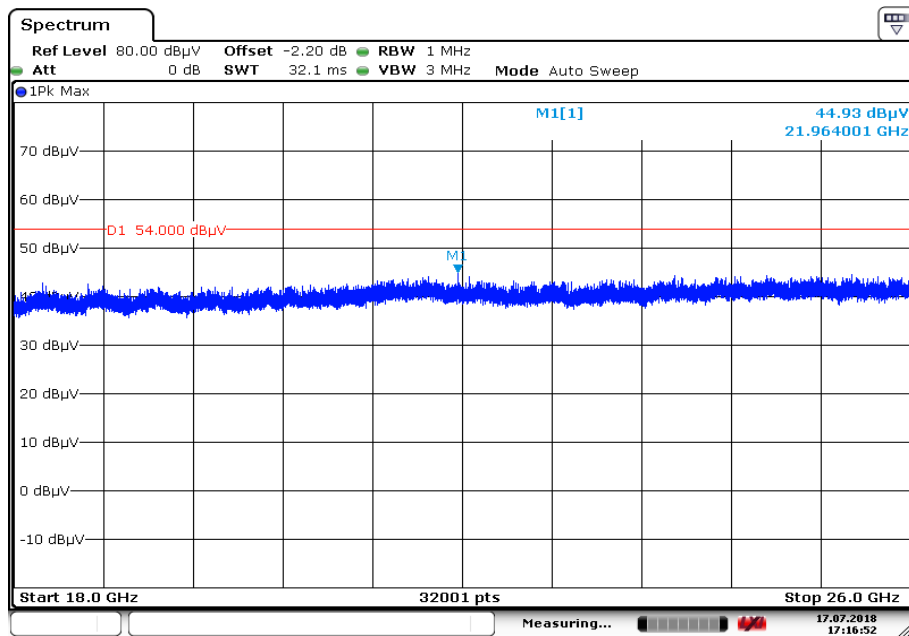

Date: 17 JUL 2018 17:16:52

Plot 11: 1 GHz to 18 GHz, TX mode, 2480 MHz, vertical & horizontal polarization, 2 Msps

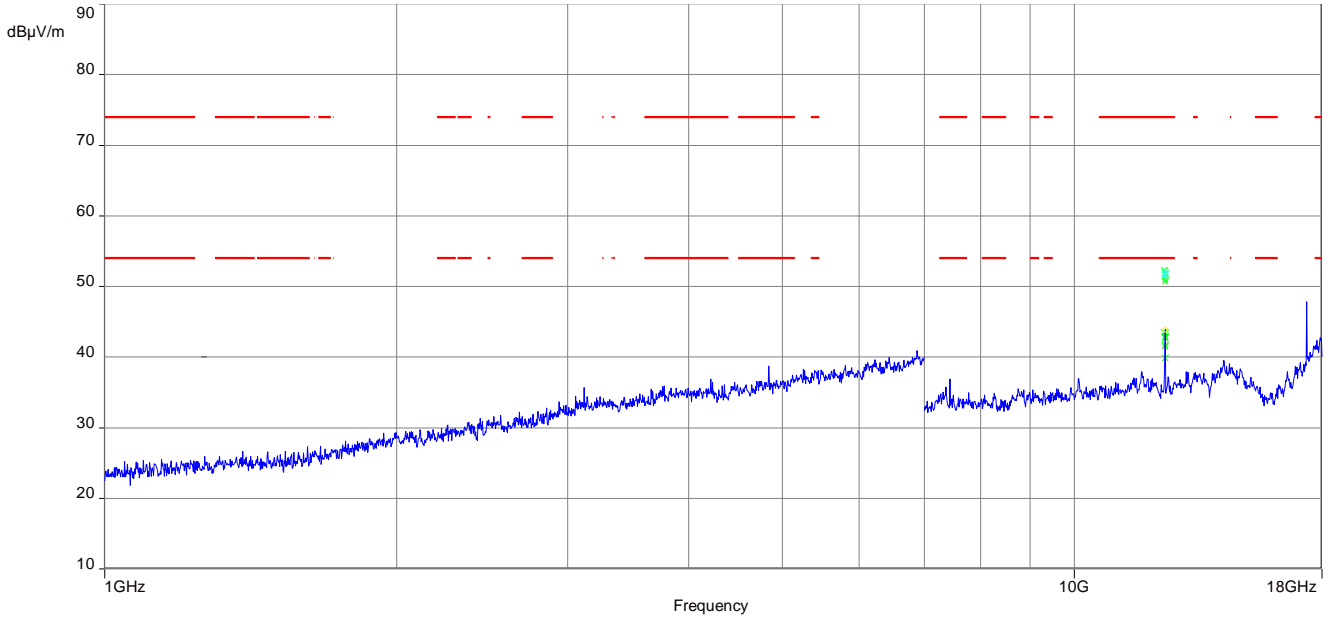

The carrier signal is notched with a 2.4 GHz band rejection filter.

Plot 12: 18 GHz to 26 GHz, TX mode, 2480 MHz, vertical & horizontal polarization, 2 Msps

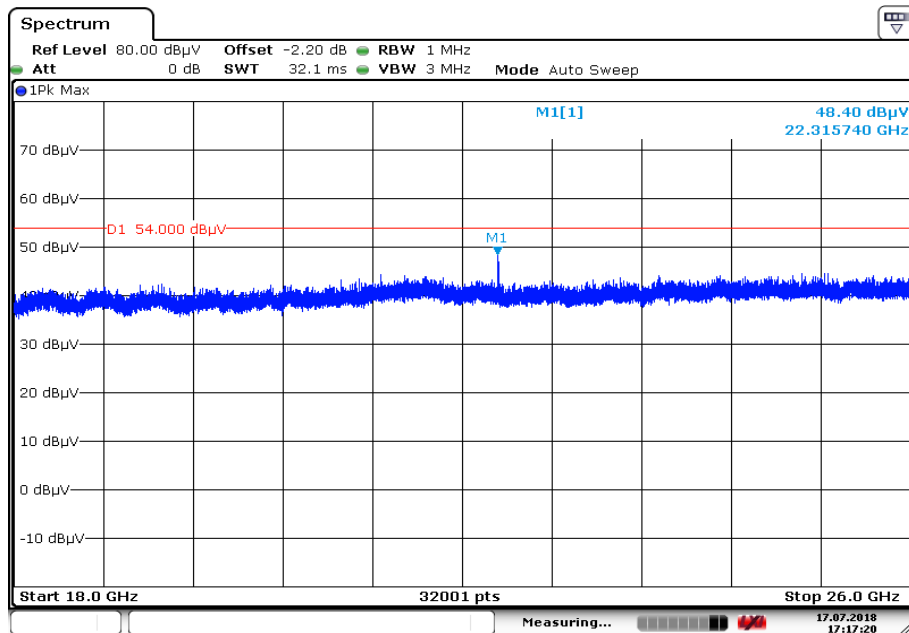

Date: 17 JUL 2018 17:17:20

Plots: Receiver mode

Plot 1: 1 GHz to 18 GHz, RX / idle – mode, vertical & horizontal polarization

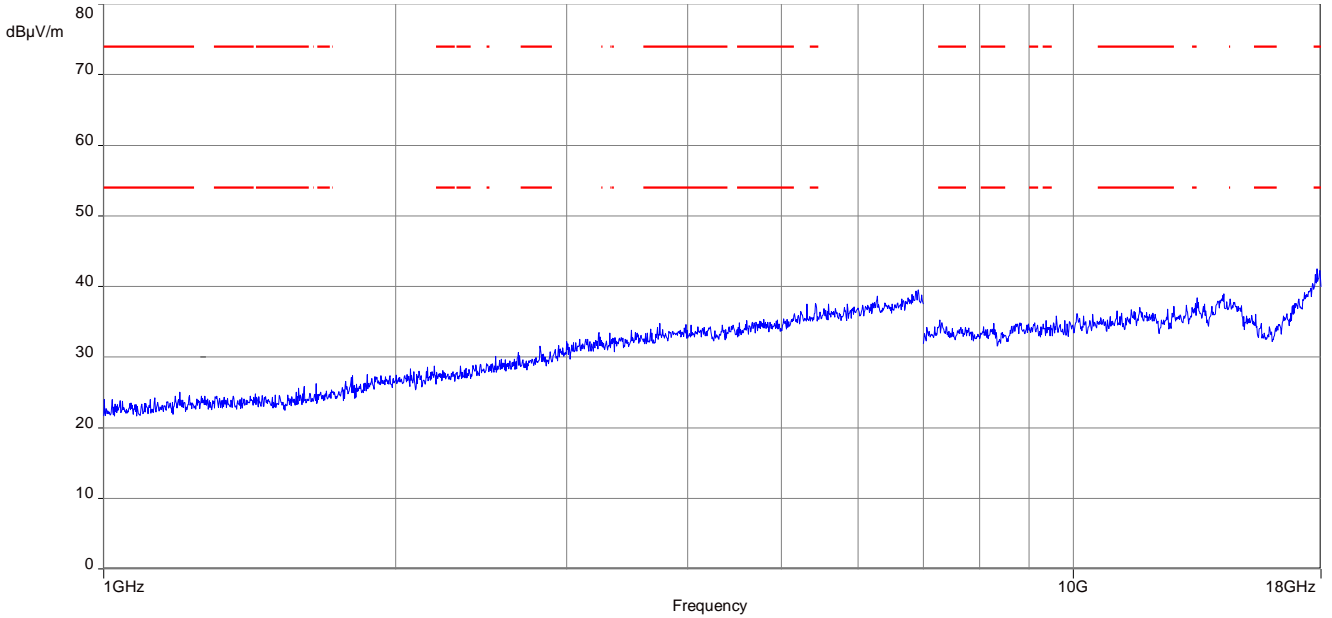

Plot 2: 18 GHz to 26 GHz, RX / idle – mode, vertical & horizontal polarization

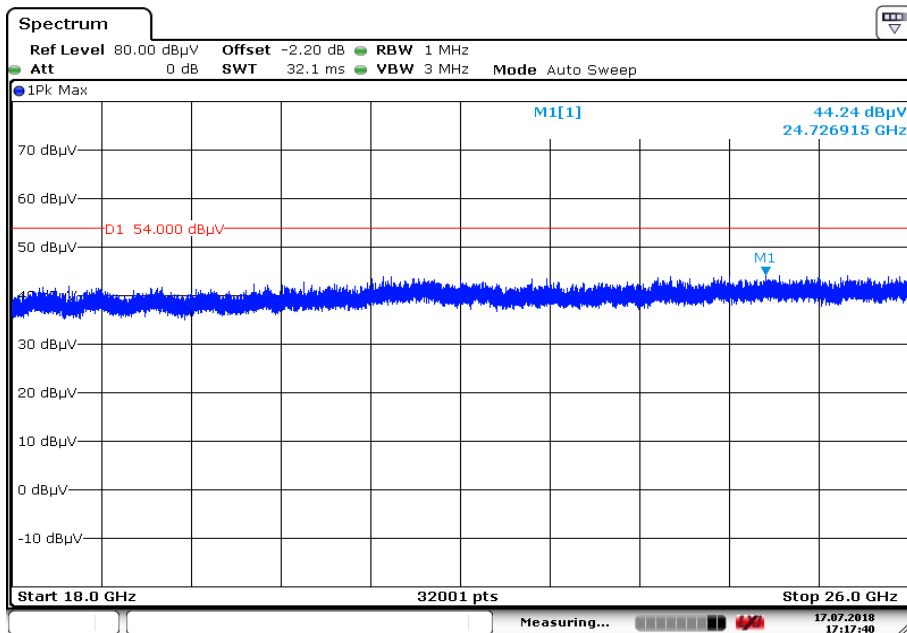

Date: 17 JUL 2018 17:17:41

Annex A Glossary

EUT	Equipment under test
DUT	Device under test
UUT	Unit under test
GUE	GNSS User Equipment
ETSI	European Telecommunications Standards Institute
EN	European Standard
FCC	Federal Communications Commission
FCC ID	Company Identifier at FCC
IC	Industry Canada
PMN	Product marketing name
HMN	Host marketing name
HVIN	Hardware version identification number
FVIN	Firmware version identification number
EMC	Electromagnetic Compatibility
HW	Hardware
SW	Software
Inv. No.	Inventory number
S/N or SN	Serial number
C	Compliant
NC	Not compliant
NA	Not applicable
NP	Not performed
PP	Positive peak
QP	Quasi peak
AVG	Average
OC	Operating channel
OCW	Operating channel bandwidth
OBW	Occupied bandwidth
OOB	Out of band
DFS	Dynamic frequency selection
CAC	Channel availability check
OP	Occupancy period
NOP	Non occupancy period
DC	Duty cycle
PER	Packet error rate
CW	Clean wave
MC	Modulated carrier
WLAN	Wireless local area network
RLAN	Radio local area network
DSSS	Dynamic sequence spread spectrum
OFDM	Orthogonal frequency division multiplexing
FHSS	Frequency hopping spread spectrum
GNSS	Global Navigation Satellite System
C/N₀	Carrier to noise-density ratio, expressed in dB-Hz

Annex B Document history

Version	Applied changes	Date of release
-/-	Initial release	2018-07-20

Annex C Accreditation Certificate

first page	last page
 <p>Deutsche Akkreditierungsstelle GmbH</p> <p>Entrusted according to Section 8 subsection 1 AkkStelleG in connection with Section 1 subsection 1 AkkStelleGBV Signatory to the Multilateral Agreements of EA, ILAC and IAF for Mutual Recognition</p> <p>Accreditation</p> <p>The Deutsche Akkreditierungsstelle GmbH attests that the testing laboratory CTC advanced GmbH Untertürkheimer Straße 6-10, 66117 Saarbrücken</p> <p>is competent under the terms of DIN EN ISO/IEC 17025:2005 to carry out tests in the following fields: Telecommunication</p> <p>The accreditation certificate shall only apply in connection with the notice of accreditation of 02.06.2017 with the accreditation number D-PL-12076-01 and is valid until 21.04.2021. It comprises the cover sheet, the reverse side of the cover sheet and the following annex with a total of 43 pages.</p> <p>Registration number of the certificate: D-PL-12076-01-03</p> <p>Frankfurt, 02.06.2017</p> <p>Dipl.-Ing. (FH) Ralf Böber Head of Division</p>	 <p>Deutsche Akkreditierungsstelle GmbH</p> <p>Office Berlin Spittelmarkt 10 10117 Berlin</p> <p>Office Frankfurt am Main Europa-Allee 52 60327 Frankfurt am Main</p> <p>Office Braunschweig Bundesallee 100 38116 Braunschweig</p> <p>The publication of extracts of the accreditation certificate is subject to the prior written approval by Deutsche Akkreditierungsstelle GmbH (DAkkS). Exempted is the unchanged form of separate disseminations of the cover sheet by the conformity assessment body mentioned overleaf.</p> <p>No impression shall be made that the accreditation also extends to fields beyond the scope of accreditation attested by DAkkS.</p> <p>The accreditation was granted pursuant to the Act on the Accreditation Body (AkkStelleG) of 31 July 2009 (Federal Law Gazette I p. 2625) and the Regulation (EC) No 765/2008 of the European Parliament and of the Council of 9 July 2008 setting out the requirements for accreditation and market surveillance relating to the marketing of products (Official Journal of the European Union L 218 of 9 July 2008, p. 30). DAkkS is a signatory to the Multilateral Agreements for Mutual Recognition of the European co-operation for Accreditation (EA), International Accreditation Forum (IAF) and International Laboratory Accreditation Cooperation (ILAC). The signatories to these agreements recognise each other's accreditations.</p> <p>The up-to-date state of membership can be retrieved from the following websites: EA: www.european-accreditation.org ILAC: www.ilac.org IAF: www.iaf.nu</p>

Note: The current certificate annex is published on the website (link see below) of the Accreditation Body DAkkS or may be received by CTC advanced GmbH on request

<https://www.dakks.de/as/ast/d/D-PL-12076-01-03e.pdf>

END OF TEST REPORT