

EMBOSS TAPE CONTAINER

Tape Dimensions

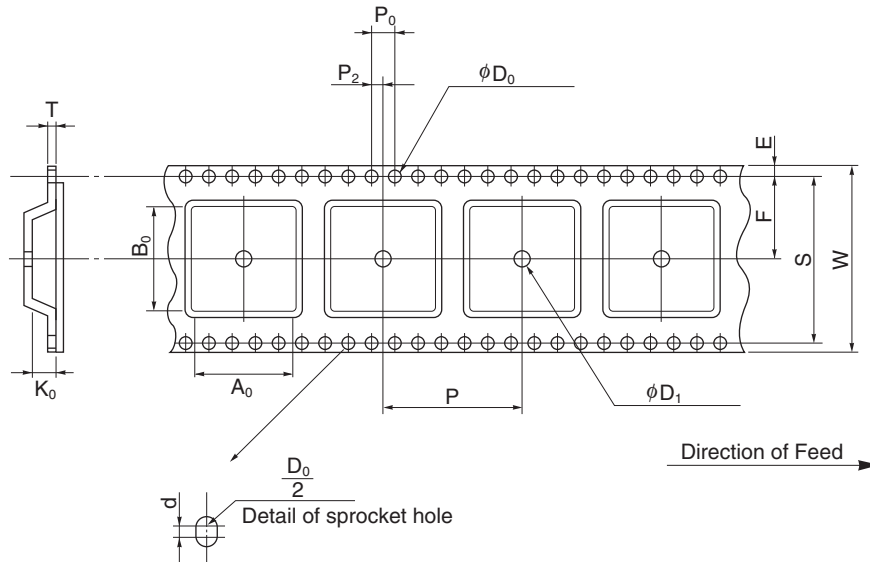

(Unit :mm)

Symbol	Specification
A_0	20.55
B_0	20.55
K_0	5.35
W	32 ± 0.3
F	14.2 ± 0.1
E	1.75 ± 0.1
P	24 ± 0.1
P_2	2 ± 0.1
P_0	4 ± 0.1
D_0	$1.5^{+0.1}_0$
T	0.3
D_1	2.0 MIN.
S	28.4 ± 0.1
d	0.2 ± 0.05

Reel Dimensions

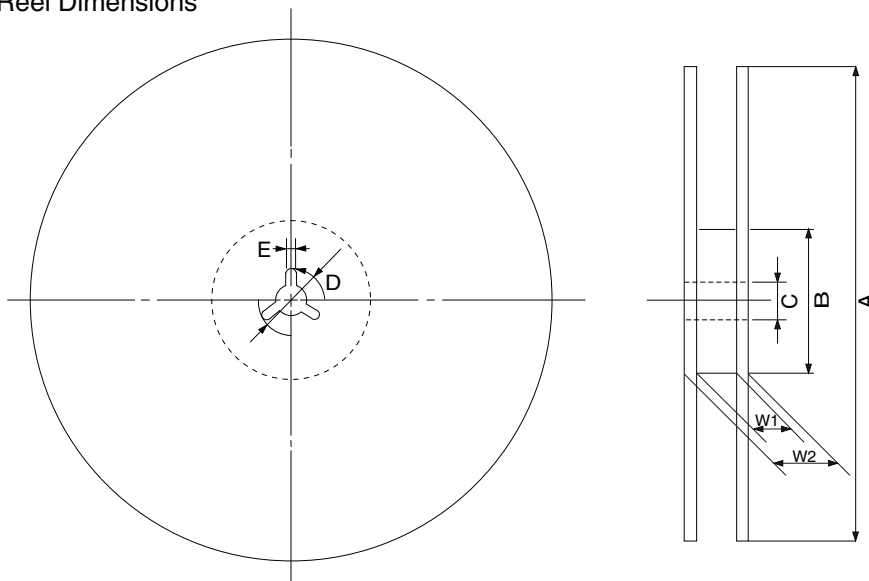

(Unit: mm)

Symbol	Specification
A	$\phi 330 \pm 2.0$
B	$\phi 100$
C	$\phi 13.0 \pm 0.2$
D	$\phi 21.0 \pm 0.8$
E	2.0 ± 0.5
W_1	33.5
W_2	37.5

Applied Package	Quantity (pcs)
52-pin QFJ (PLCC) (19.05mm(750))	MAX. 500