

Integrated Ultra-Low Quiescent Current, Ultra-Low Output Ripple Buck Regulator with 100 mA LDO

General Description

DA9233 is an ultra-low quiescent current high efficiency buck regulator and an ultra-low quiescent current LDO in a compact I²C configurable WLCSP package. The Buck regulator also features ultra-low output ripple (<10mV). It is targeting battery powered applications needing low ripple and highly efficient power supplies.

The buck regulator extends high light load efficiency down to 20 μ A further extending battery life. Dynamic Voltage Control in the Buck regulator facilitates optimization across the system power modes enabling further improvement in System efficiency and battery life.

The low quiescent current LDO can be configured as a Load Switch and provides the second supply output. The LDO's uncommitted inputs can be connected to either the battery or the buck output. Connecting the input to the buck output provides the flexibility to improve the PSRR at the LDO output as needed.

DA9233 provides multiple protection features and comes with the ability to monitor the events and indicators in the GPO pin.

Suitable for space constrained applications, the DA9233 comes in a 1.65 mm x 1.25 mm x 0.5 mm, 12-pin WLCSP package.

Key Features

- 60 mA buck regulator
 - 750 nA total input current (buck enabled, no load)
 - Up to 80 % efficiency at 1.8 V output, 20 μ A load currents
 - Input voltage 2.5 V to 5.5 V (Minimum 2.75 V for start-up)
 - Output voltage 0.6 V to 1.9 V Dynamic Voltage Control (DVC)
- 100 mA LDO / Load Switch
 - Ultra-low quiescent current
 - Input voltage 1.8 V to 5.5 V
 - Output voltage 0.7 V to 3.3 V
- I²C interface for device configuration and control
- Protection features and System Monitors
- Small 1.65 mm x 1.25 mm x 0.5 mm, 12-pin WLCSP package

Applications

- Wearables – wrist wear, hearables
- Smart devices - thermostats and door locks
- Smoke detectors
- Portable medical devices
- Remote sensors
- High efficiency, low power applications

Integrated Ultra-Low Quiescent Current, Ultra-Low Output Ripple Buck Regulator with 100 mA LDO

Contents

General Description	1
Key Features	1
Applications	1
Contents	2
Figures	3
Tables	4
1 Terms and Definitions	5
2 Block and Application Diagrams	6
3 Pinout	7
4 Absolute Maximum Ratings	9
5 Recommended Operating Conditions	10
6 ESD Ratings	11
7 Electrical Characteristics	12
8 Thermal Characteristics	16
9 Typical Operating Characteristics	17
9.1 Buck No Load Quiescent Current vs Temperature, Device is Switching.....	17
9.2 Buck FETs RDSon vs Temperature.....	17
9.3 Buck Efficiency vs Load Current	18
9.4 LDO V _{OUT} Accuracy.....	19
9.5 LDO Load Transient Response	20
9.6 LDO PSRR.....	21
10 Feature Descriptions	22
10.1 Chip Enable and Disable Through IC_EN	22
10.2 VDD Under-Voltage Lockout.....	22
10.3 Over-Temperature Protection	22
10.4 Buck Regulator.....	22
10.4.1 Buck Output Voltage Programmability.....	22
10.4.2 Start-up Operation	23
10.4.3 Power Saving Mode Operation.....	24
10.4.4 Dynamic Voltage Control	24
10.4.5 Cycle-by-cycle Over-Current Protection	24
10.4.6 Output Over-Voltage Protection	24
10.4.7 Output Under-Voltage Protection	24
10.4.8 Automatic Output voltage Discharge	25
10.4.9 Event Flag and Fault Control.....	25
10.5 Load Switch, LDO Output and Control.....	26

Integrated Ultra-Low Quiescent Current, Ultra-Low Output Ripple Buck Regulator with 100 mA LDO

10.5.1	LDO Output Programmability	26
10.5.2	Automatic Output Voltage Discharge	27
10.5.3	Load Switch	27
10.6	I ² C Programming.....	28
10.6.1	Interface Description.....	28
10.6.2	Details of the I ² C Protocol.....	28
10.7	GPO Pin Function Programming	29
10.7.1	Power Good Indicator	29
10.7.2	Event Indicator.....	29
10.7.3	Reset Pulse Generation	29
10.7.4	Always Pull-Down or Hi-Z.....	30
11	Register Overview	31
11.1	Register Map.....	31
11.1.1	Buck and LDO Control.....	31
11.1.2	System Module.....	32
11.2	Register Definitions.....	32
11.2.1	Buck and LDO Control.....	32
11.2.1.1	Event/Status/Mask Registers	32
11.2.1.2	User Registers	35
11.2.2	System Module.....	43
11.2.2.1	System Reset Registers	43
11.2.2.2	System ID Registers	44
12	Package Information	46
12.1	Package Outlines	46
12.2	Moisture Sensitivity Level.....	47
12.3	Soldering Information.....	47
13	Ordering Information	48

Figures

Figure 1: Block Diagram	6
Figure 2: DA9233 Application Diagram	6
Figure 3: Pinout Diagram (Top View)	7
Figure 4: Buck V _{OUT} = 1.8 V	17
Figure 5: Buck V _{OUT} = 0.7 V	17
Figure 6: High-Side FET.....	17
Figure 7: Low-Side FET.....	17
Figure 8: Buck V _{OUT} = 1.8 V	18
Figure 9: Buck V _{OUT} = 0.7 V	18
Figure 10: LDO V _{OUT} = 0.8 V	19
Figure 11: LDO V _{OUT} = 1.8 V	19

Integrated Ultra-Low Quiescent Current, Ultra-Low Output Ripple Buck Regulator with 100 mA LDO

Figure 12: LDO $V_{OUT} = 3.3\text{ V}$	19
Figure 134: LDO $I_{LOAD} = 5\text{ mA}$ to 100 mA to 5 mA ($0.1\text{ A} / 1\ \mu\text{s}$); LDO $V_{IN} = 3.6\text{ V}$, LDO $V_{OUT} = 0.8\text{ V}$	20
Figure 145: LDO $I_{LOAD} = 5\text{ mA}$ to 100 mA to 5 mA ($0.1\text{ A} / 1\ \mu\text{s}$); LDO $V_{IN} = 3.6\text{ V}$, LDO $V_{OUT} = 2\text{ V}$	20
Figure 156: LDO $I_{LOAD} = 5\text{ mA}$ to 100 mA to 5 mA ($0.1\text{ A} / 1\ \mu\text{s}$); LDO $V_{IN} = 3.6\text{ V}$, LDO $V_{OUT} = 3.3\text{ V}$	20
Figure 167: LDO $V_{IN} = 3.7\text{ V}$, LDO No Load	21
Figure 178: LDO $V_{IN} = 3.7\text{ V}$, LDO $I_{LOAD} = 100\text{ mA}$	21
Figure 189: I ² C Serial Interface Pins	28
Figure 191: Package Outline Drawing.....	46

Tables

Table 1: Pin Description	7
Table 2: Pin Type Definition	8
Table 3: Absolute Maximum Ratings.....	9
Table 4: Recommended Operating Conditions	10
Table 5: Input Current.....	12
Table 6: Buck Output.....	12
Table 7: GPO - Electrical performance	13
Table 8: Analog Core - Electrical performance	13
Table 9: I2C interface	14
Table 10: Thermal Characteristics	16
Table 11: Buck Output Voltage Settings	22
Table 12: LDO Output Voltages Settings	26
Table 13: GPO as Power Good Indicator.....	29
Table 14: Event/Status/Mask and User Registers	31
Table 15: System Registers	32
Table 16: Register EVENT	32
Table 17: Register STATUS	33
Table 18: Register MASK.....	34
Table 19: Register GPO	35
Table 20: Register BUCK	36
Table 21: Register BUCK_CFG	39
Table 22: Register LS_LDO	39
Table 23: Register FAULT_CTL.....	41
Table 24: Register PIN_MONTOR	42
Table 25: Register SYS_RST_EVENT.....	43
Table 26: Register SYS_SRST	43
Table 27: Register SYS_DEVICE_ID.....	44
Table 28: Register SYS_VARIANT_ID.....	44
Table 29: Register SYS_CONFIG_ID	44
Table 30: MSL Classification	47
Table 31: Ordering Information	48
Table 32: OTP List.....	48

Integrated Ultra-Low Quiescent Current, Ultra-Low Output Ripple Buck Regulator with 100 mA LDO

1 Terms and Definitions

CDM	Charged Device Model
DC	Direct Current
DCM	Discontinuous Conduction Mode
FET	Field Effect Transistor
NMOS	N-channel Metal-Oxide-Semiconductor
OTP	One-Time Programmable (memory)
PMIC	Power Management IC
PMOS	P-channel Metal-Oxide-Semiconductor
R/W	Read/Write
SCL	Serial Clock SDA
T&R	Tape and Reel
UVLO	Under-Voltage Lock Out
WLCSP	Wafer-Level Chip-Scale Package

Integrated Ultra-Low Quiescent Current, Ultra-Low Output Ripple Buck Regulator with 100 mA LDO

2 Block and Application Diagrams

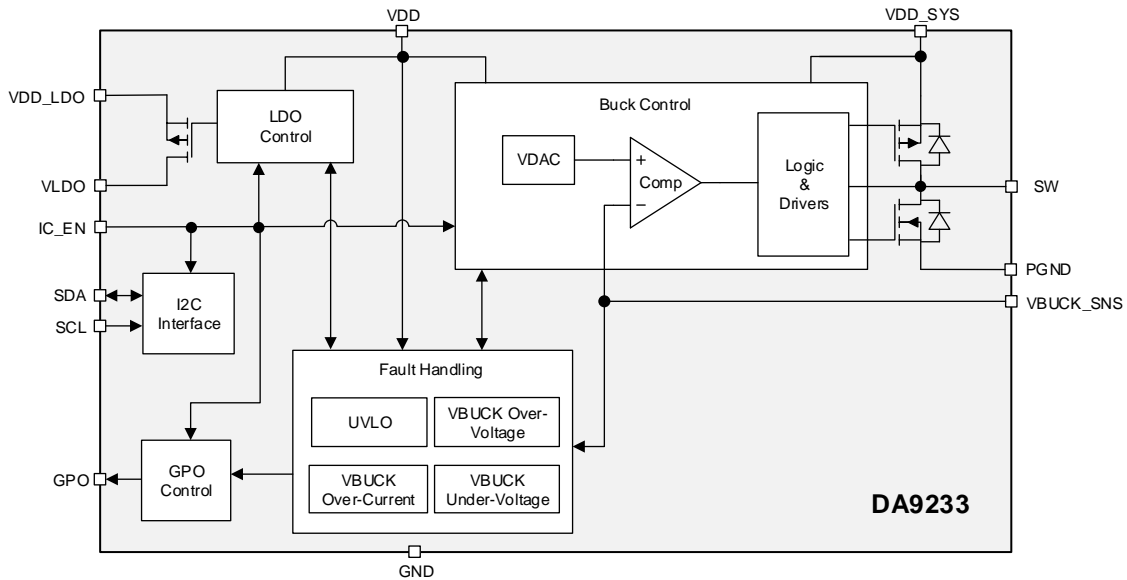

Figure 1: Block Diagram

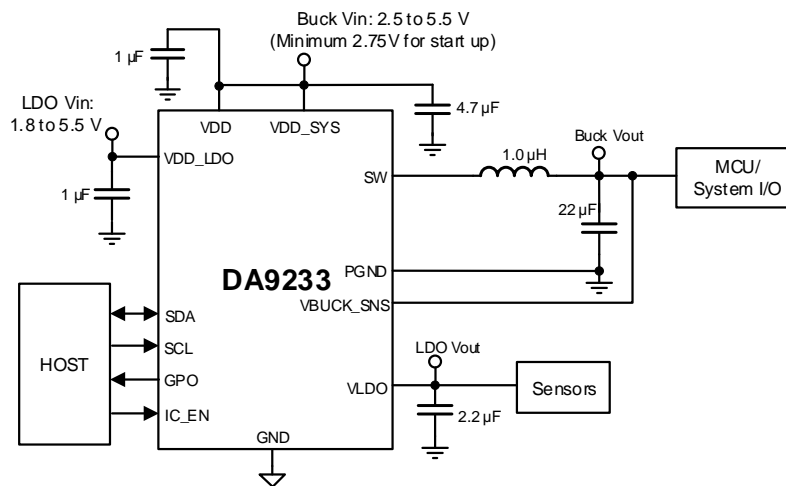

Figure 2: DA9233 Application Diagram

Integrated Ultra-Low Quiescent Current, Ultra-Low Output Ripple Buck Regulator with 100 mA LDO

3 Pinout

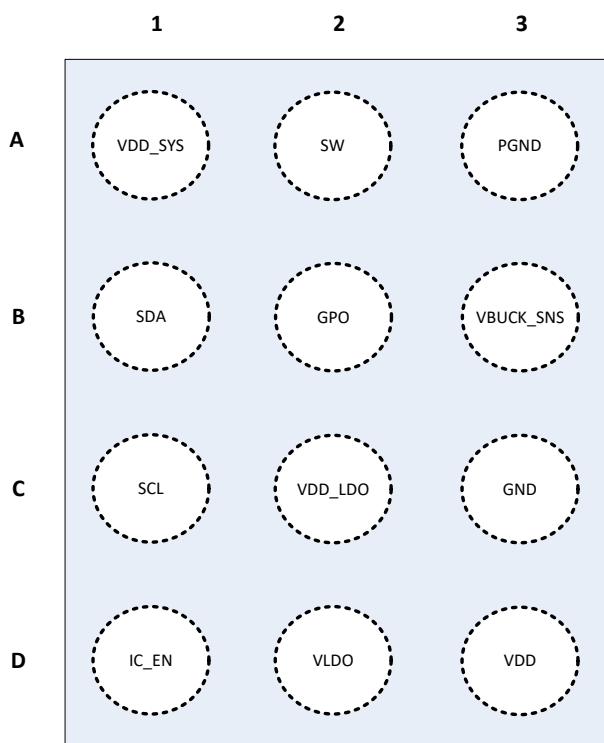

Figure 3: Pinout Diagram (Top View)

Table 1: Pin Description

Pin #	Pin Name	Type (See Table 2)	Drive (mA)	Reset State	Description
A1	VDD_SYS	AI			Buck V_{IN}
A2	SW	AIO			Buck switch node
A3	PGND	AIO			Buck ground
B1	SDA	DIO			I ² C serial data
B2	GPO	DO			General purpose output
B3	VBUCK_SNS	AI			Buck V_{OUT} /feedback voltage
C1	SCL	DI			I ² C serial clock
C2	VDD_LDO	AI			LDO input voltage
C3	GND	AI			Analog ground
D1	IC_EN	DI			Chip enable
D2	VLDO	AO			LDO output voltage

Integrated Ultra-Low Quiescent Current, Ultra-Low Output Ripple Buck Regulator with 100 mA LDO

Pin #	Pin Name	Type (See Table 2)	Drive (mA)	Reset State	Description
D3	VDD	AI			Analog V_{IN}

Table 2: Pin Type Definition

Pin Type	Description	Pin Type	Description
DI	Digital Input	AI	Analog Input
DO	Digital Output	AO	Analog Output
DIO	Digital Input/Output	AIO	Analog Input / Output
DIOD	Digital Input/Output open Drain	BP	Back drive Protection
PU	Fixed pull-up resistor	SPU	Switchable pull-up resistor
PD	Fixed pull-down resistor	SPD	Switchable pull-down resistor

Integrated Ultra-Low Quiescent Current, Ultra-Low Output Ripple Buck Regulator with 100 mA LDO

4 Absolute Maximum Ratings

Table 3: Absolute Maximum Ratings

Symbol	Description	Conditions	Min	Max	Unit
T _{STG}	Storage temperature		-65	150	°C
T _J	Operating junction temperature		-40	125	°C
V _{DD}	Analog V _{IN} pin	Tied to VDD_SYS	-0.3	6	V
V _{DD_SYS}	Power V _{IN} pin	Tied to VDD	-0.3	6	V
I/O pins	Maximum voltage	I/O pin voltage ≤ VDD	-0.3	6	V

Stresses beyond those listed under Absolute maximum ratings may cause permanent damage to the device. These are stress ratings only, so functional operation of the device at these or any other conditions beyond those indicated in the operational sections of the specification are not implied. Exposure to absolute maximum rating conditions for extended periods may affect device reliability.

Integrated Ultra-Low Quiescent Current, Ultra-Low Output Ripple Buck Regulator with 100 mA LDO

5 Recommended Operating Conditions

Table 4: Recommended Operating Conditions

Parameter	Description	Conditions	Min	Typ	Max	Unit
V _{DD}	Analog V _{IN}	Tied to VDD_SYS	2.5 Note 1		5.5	V
V _{DD_SYS}	Power V _{IN}	Tied to VDD	2.5 Note 1		5.5	V
I _{OUT_BUCK}	Load Current	Output current from SW pin, continuous DC current			60	mA
V _{DD_LDO}	Input voltage range for LDO mode	VDD_LDO ≤ VDD	1.8		5.5	V
	Input voltage range for Load switch mode	VDD_LDO ≤ VDD	0.8		5.5	V

Note 1 Requires minimum 2.75 V for start-up. Once started, input voltage can go down to 2.5 V.

Integrated Ultra-Low Quiescent Current, Ultra-Low Output Ripple Buck Regulator with 100 mA LDO

6 ESD Ratings

Parameter	Description	Conditions	Value	Unit
V _{ESD}	Electrostatic discharge	Human body model (HBM), per ANSI/ESDA/JEDEC JS-001 Note 1	± 2000	V
		Charged device model (CDM), per JEDEC specification JESD22-C101 Note 2	± 500	

Note 1 JEDEC document JEP155 states that 500-V HBM allows safe manufacturing with a standard ESD control process.

Note 2 JEDEC document JEP157 states that 250-V CDM allows safe manufacturing with a standard ESD control process.

Integrated Ultra-Low Quiescent Current, Ultra-Low Output Ripple Buck Regulator with 100 mA LDO

7 Electrical Characteristics

$V_{DD} = V_{DD_SYS} = 3.6\text{ V}$, $T_A = -40^\circ\text{C}$ to 85°C . Typical values are at $T_A = 25^\circ\text{C}$ (unless otherwise noted).

Table 5: Input Current

Symbol	Parameter	Conditions	Min	Typ	Max	Unit
Electrical performance						
$I_{Q_BUCK_LD}$ $I_{O_ON_NO_LD}$	Buck and LDO no load quiescent current	-40 °C < T_A < 85 °C Buck enabled and regulating with no load LDO enabled $2.5\text{ V} \leq V_{VDD_SYS} \leq 5.5\text{ V}$ $V_{BUCK} = 1.8\text{ V}$ $V_{VLDO} = 0.8\text{ V}$		1.35	4.25	μA
$I_{Q_BUCK_ON_NO_LD}$	Buck no load quiescent current	-40 °C < T_A < 85 °C Buck enabled and regulating, no load $2.5\text{ V} \leq V_{VDD_SYS} \leq 5.5\text{ V}$ $V_{BUCK} = 1.8\text{ V}$		0.75	3.5	μA

Table 6: Buck Output

Symbol	Parameter	Conditions	Min	Typ	Max	Unit
Electrical performance						
R_{ON_PMOS}	On resistance of PMOS pass device	$V_{VDD_SYS} = 3.6\text{ V}$ $I_{OUT} = 50\text{ mA}$		600	800	$\text{m}\Omega$
R_{ON_NMOS}	On resistance of NMOS pass device	$V_{VDD_SYS} = 3.6\text{ V}$ $I_{OUT} = 50\text{ mA}$		300	450	$\text{m}\Omega$
R_{SYS_DHCG}	MOSFET on-resistance for buck discharge	$V_{VDD_SYS} = 3.6\text{ V}$ $I_{OUT} = -10\text{ mA}$ into VOUT pin		33		Ω
t_{START}	Buck start-up time	$V_{VDD_SYS} = 3.6\text{ V}$ $V_{BUCK} = 1.8\text{ V}$ $I_{OUT} = 0\text{ A}$ from BUCK_EN = 1 to switching start		3		ms
$I_{LIM_SW_PMOS}$	SW current limit PMOS	$V_{VDD_SYS} = 3.6\text{ V}$ $V_{BUCK} = 1.8\text{ V}$		550		mA
f_{SW}	Switching frequency				1.5	MHz
$I_{LIM_PMOS_S_OFFSTART}$	PMOS switch current limit during softstart	Current limit is reduced during softstart		250		mA

Integrated Ultra-Low Quiescent Current, Ultra-Low Output Ripple Buck Regulator with 100 mA LDO

Symbol	Parameter	Conditions	Min	Typ	Max	Unit
V _{OUT_VBUCK_SNS}	Buck output voltage range	Programmable range, 50 mV steps	0.6		1.9	V
V _{OUT_VBUCK_SNS_HI}	Buck output voltage range	HI programmable range, 50 mV steps V _{OUT_RANGE_HI} = 1	1.3		1.9	V
V _{OUT_VBUCK_SNS_LO}	Buck output voltage range	LO programmable range, 50 mV steps V _{OUT_RANGE_HI} = 0	0.6		1.3	V
V _{OUT_VBUCK_ACC_HI}	Buck output voltage accuracy (Note 1)	V _{VDD_SYS} = 2.5 - 5.5V I _{OUT} = 0 - 60 mA V _{OUT_RANGE_HI} = 1 V _{BUCK} = 1.8 V	-1.5		1.5	%
V _{OUT_VBUCK_ACC_LO}	Buck output voltage accuracy (Note 1)	V _{VDD_SYS} = 2.5 - 5.5 V I _{OUT} = 0 - 60 mA V _{OUT_RANGE_HI} = 0 V _{BUCK} = 0.7 V	-2.5		2.5	%

Note 1: Includes all variations caused by Line and Load Regulations, Ripple and Temperature.

Table 7: GPO - Electrical performance

Symbol	Parameter	Conditions	Min	Typ	Max	Unit
R _{PD}	GPO pull-down resistance	V _{VDD_SYS} = 3.6 V		12		Ω
V _{OH}	GPO Output high voltage	V _{PULLUP} = 1.8 V	1.4			V
V _{OL}	GPO Output low voltage	V _{PULLUP} = 1.8 V			0.4	V

Table 8: Analog Core - Electrical performance

Symbol	Parameter	Conditions	Min	Typ	Max	Unit
T _{SHDN_HYS}	Thermal shut-down hysteresis			20		°C
T _{SHDN_THR}	Thermal shut-down threshold			125		°C
V _{TH_UVLO}	Under-voltage lockout threshold	Input voltage falling	2.4		2.5	V
V _{TH_UVLO_RISE}	Under-voltage lockout threshold rising.	Input voltage rising.			2.75	V
V _{HYS_UVLO}	Under-voltage lockout hysteresis	Input voltage rising		200		mV

Integrated Ultra-Low Quiescent Current, Ultra-Low Output Ripple Buck Regulator with 100 mA LDO

Table 9: I2C interface

Symbol	Parameter	Conditions	Min	Typ	Max	Unit
Electrical performance						
f _{I2C_CLK}	I ² C bus specification standard and fast mode frequency support		100		400	kHz
V _{IN_HI_THR}	Input high threshold level for SDA and SCL		1.4			V
V _{IN_LO_THR}	Input low threshold level for SDA and SCL				0.4	V
V _{OUT_LO_THR}	Output low threshold level for SDA				0.4	V
I _{LKG_HILVL}	High-level leakage current for SDA and SCL.	V _{PU} = V _{VDD} SDA and SCL			1	μA

Table 10: Bypass/LDO Output

Symbol	Parameter	Conditions	Min	Typ	Max	Unit
Electrical performance						
V _{IN_LDSW}	Input voltage range for LDO	Bypass mode V _{VDD_LDO} ≤ V _{VDD}	0.8		5.5	V
V _{IN_LDO}	Input voltage range for LDO	LDO mode V _{VDD_LDO} ≤ V _{VDD}	1.8		5.5	V
V _{OUT_ACC}	DC output accuracy	Over V _{DD_LDO} , I _{OUT} , temperature	-3		3	%
V _{OUT_LDO}	Output range for LDO	Programmable range, 100 mV steps	0.7		3.3	V
V _{OUT_LINE}	DC line regulation	I _{OUT} = 10 mA	-0.8		0.8	%
V _{OUT_LD}	DC load regulation	I _{OUT} = 100 mA V _{VDD_LDO} - V _{VLDO} ≥ 0.2 V		-2		%
V _{OUT_TR_LD}	Load transient	2 μA to 100 mA in 1 μs V _{VDD_LDO} ≥ 2.2 V V _{VDD_LDO} - V _{VLDO} ≥ 0.2 V C _{OUT_LDO} = 1 μF	-100		100	mV

Integrated Ultra-Low Quiescent Current, Ultra-Low Output Ripple Buck Regulator with 100 mA LDO

Symbol	Parameter	Conditions	Min	Typ	Max	Unit
$V_{OUT_TR_LDO}$	Load transient	2 μ A to 100 mA in 1 μ s $V_{VDD_LDO} < 2.2$ V $V_{VDD_LDO} - V_{VLDO} \geq 0.2$ V $C_{OUT_LDO} = 1$ μ F	-250		270	mV
R_{ON_LDO}	On resistance of LDO	$V_{VDD_LDO} = 3.7$ V		350		m Ω
$R_{DHCG_LDO_ON}$	MOSFET on-resistance for LDO discharge	$I_{LOAD} = -10$ mA		27	80	Ω
$I_{OUT_MAX_LDO}$	Output current capability in LDO mode	$V_{VDD_LDO} = 3.6$ V $V_{VLDO} = 3.3$ V			100	mA
$I_{OUT_MAX_LS}$	Output current capability in Load Switch mode				100	mA

Integrated Ultra-Low Quiescent Current, Ultra-Low Output Ripple Buck Regulator with 100 mA LDO

8 Thermal Characteristics

Table 10: Thermal Characteristics

Parameter	Description	Conditions	Typ	Unit
R_{TH_JA}	Junction-to-ambient thermal resistance	JEDEC 6-layer PCB, no airflow	73.2	°C/W
Ψ_{JT}	Junction-to-top characterization parameter	JEDEC 6-layer PCB, no airflow	6.66	°C/W
R_{TH_JB}	Junction-to-board thermal resistance	JEDEC 6-layer PCB, no airflow	34.8	°C/W

Integrated Ultra-Low Quiescent Current, Ultra-Low Output Ripple Buck Regulator with 100 mA LDO

9 Typical Operating Characteristics

Test Circuit of Figure 2, Buck $V_{IN} = VDD_SYS = VDD$, $L = 1.0 \mu H$, $T_A = 25^\circ C$, unless specified otherwise.

9.1 Buck No Load Quiescent Current vs Temperature, Device is Switching

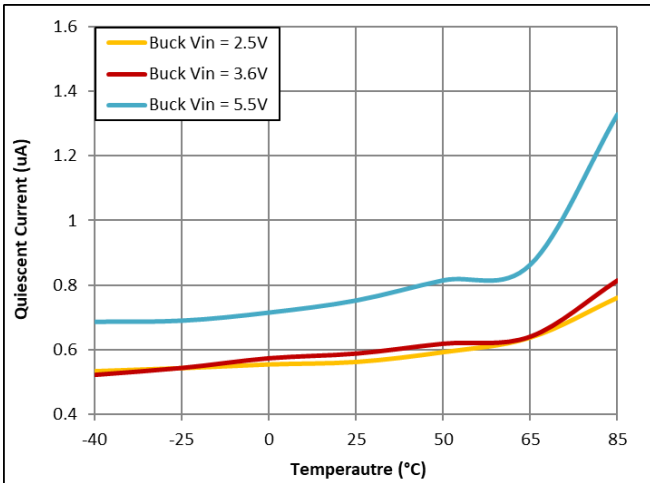

Figure 4: Buck $V_{OUT} = 1.8 V$

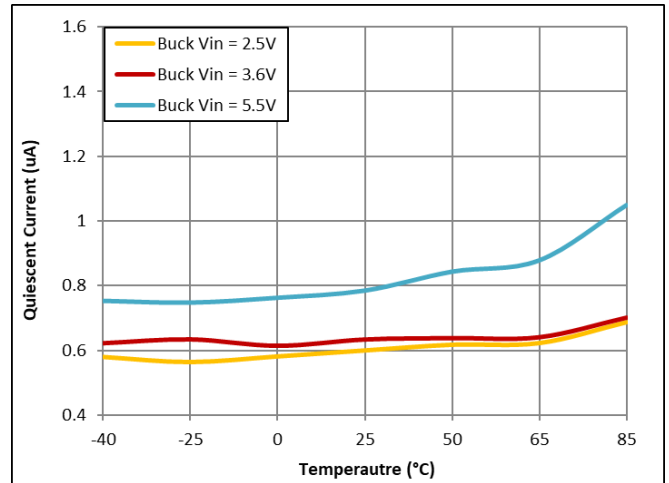

Figure 5: Buck $V_{OUT} = 0.7 V$

9.2 Buck FETs R_{DSon} vs Temperature

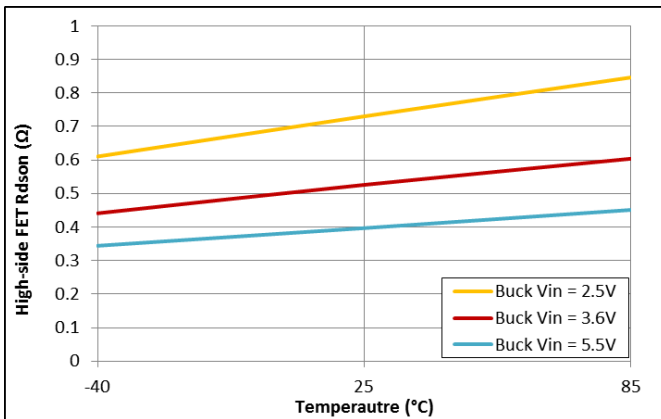

Figure 6: High-Side FET

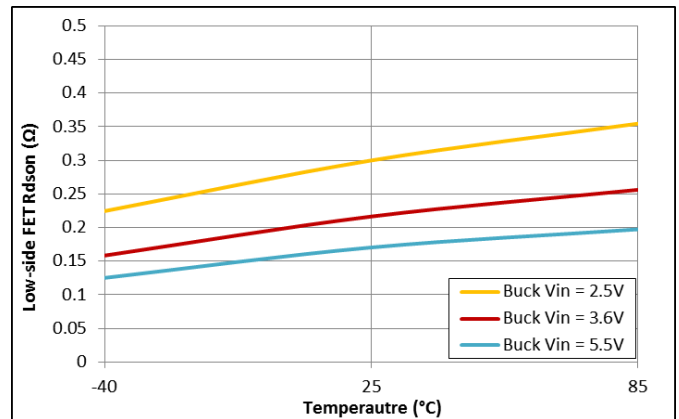

Figure 7: Low-Side FET

Integrated Ultra-Low Quiescent Current, Ultra-Low Output Ripple Buck Regulator with 100 mA LDO

9.3 Buck Efficiency vs Load Current

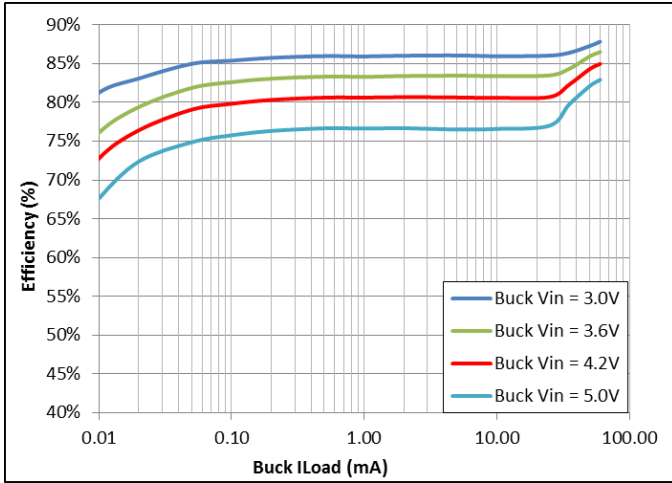

Figure 8: Buck V_{OUT} = 1.8 V

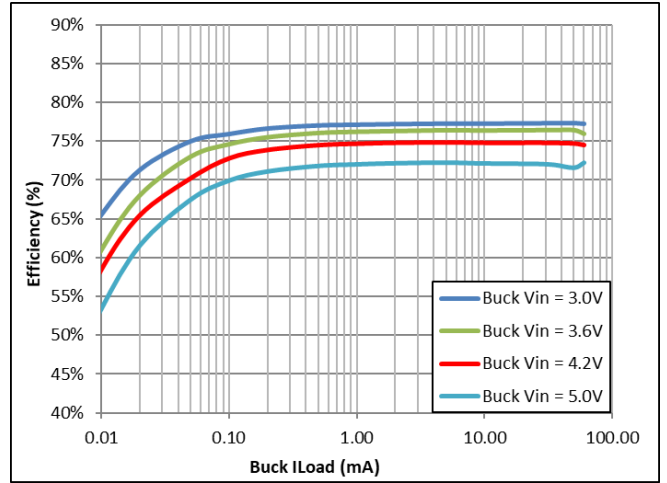

Figure 9: Buck V_{OUT} = 0.7 V

Integrated Ultra-Low Quiescent Current, Ultra-Low Output Ripple Buck Regulator with 100 mA LDO

LDO V_{OUT} Accuracy

LDO V_{OUT} Accuracy is calculated based on equation:

$$100\% \times (\text{Actual LDO output voltage} - \text{Target LDO output voltage}) / \text{Target LDO output voltage}$$

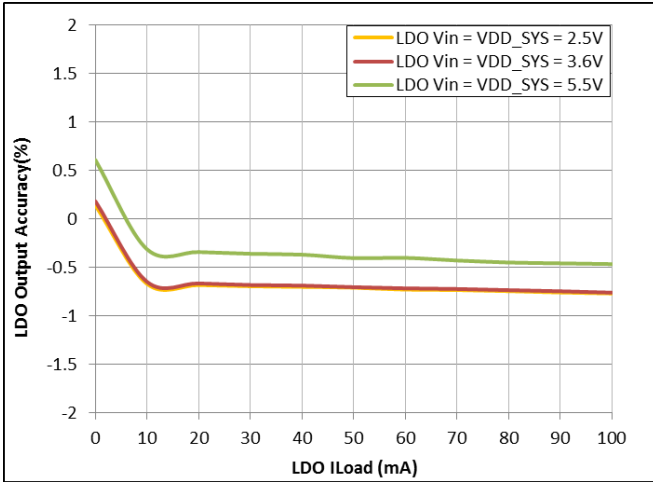

Figure 10: LDO V_{OUT} = 0.8 V

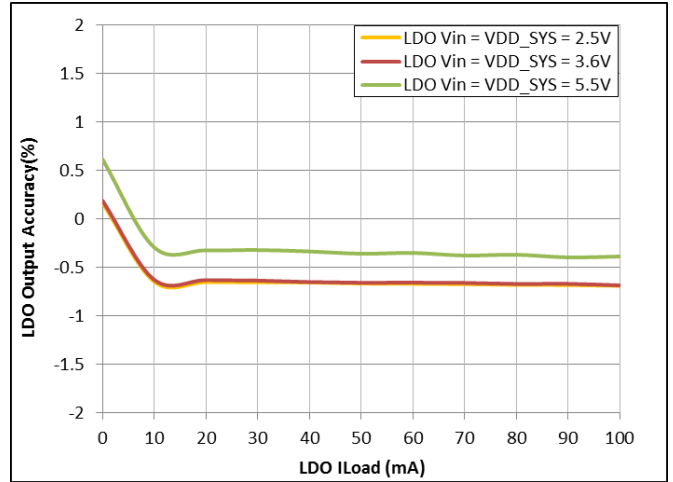

Figure 11: LDO V_{OUT} = 1.8 V

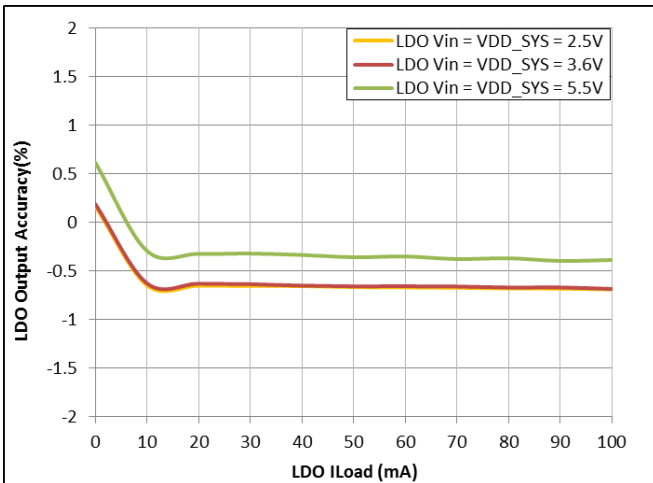

Figure 12: LDO V_{OUT} = 2.0 V

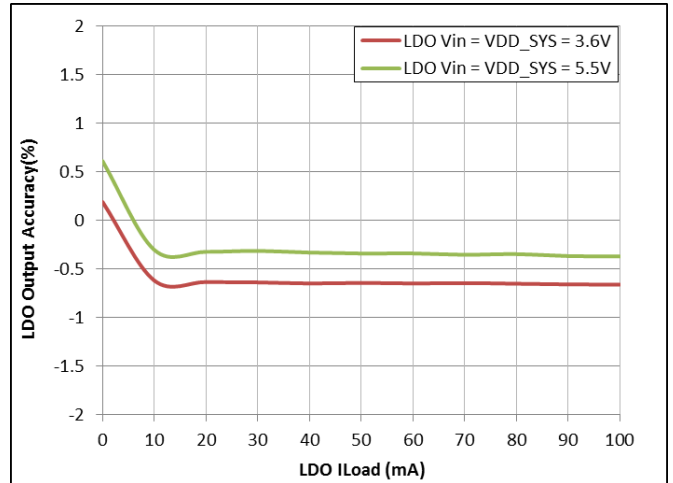
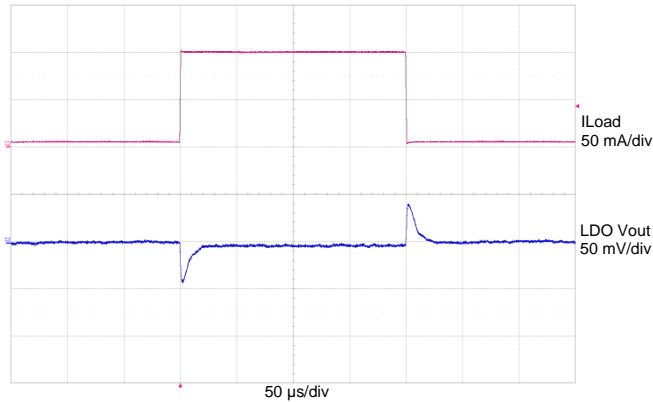

Figure 12: LDO V_{OUT} = 3.3 V

Integrated Ultra-Low Quiescent Current, Ultra-Low Output Ripple Buck Regulator with 100 mA LDO

LDO Load Transient Response



**Figure 134: LDO $I_{LOAD} = 5 \text{ mA}$ to 100 mA to 5 mA
($0.1 \text{ A} / 1 \mu\text{s}$);
LDO $V_{IN} = 3.6 \text{ V}$, LDO $V_{OUT} = 0.8 \text{ V}$**

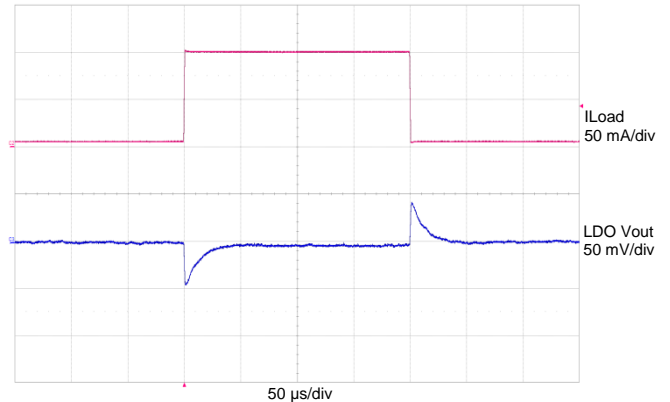

**Figure 145: LDO $I_{LOAD} = 5 \text{ mA}$ to 100 mA to 5 mA
($0.1 \text{ A} / 1 \mu\text{s}$);
LDO $V_{IN} = 3.6 \text{ V}$, LDO $V_{OUT} = 2 \text{ V}$**

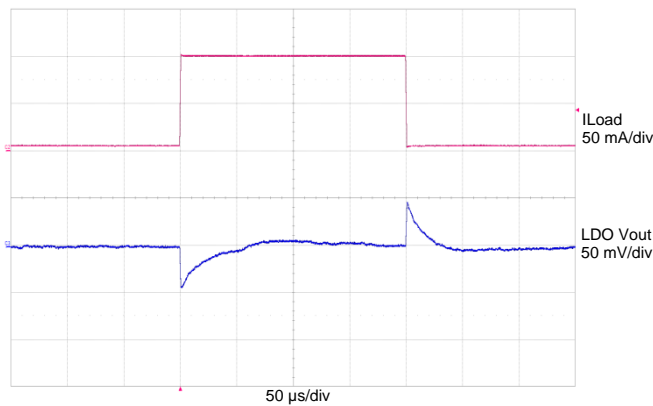

**Figure 156: LDO $I_{LOAD} = 5 \text{ mA}$ to 100 mA to 5 mA
($0.1 \text{ A} / 1 \mu\text{s}$);
LDO $V_{IN} = 3.6 \text{ V}$, LDO $V_{OUT} = 3.3 \text{ V}$**

Integrated Ultra-Low Quiescent Current, Ultra-Low Output Ripple Buck Regulator with 100 mA LDO

9.4 LDO PSRR

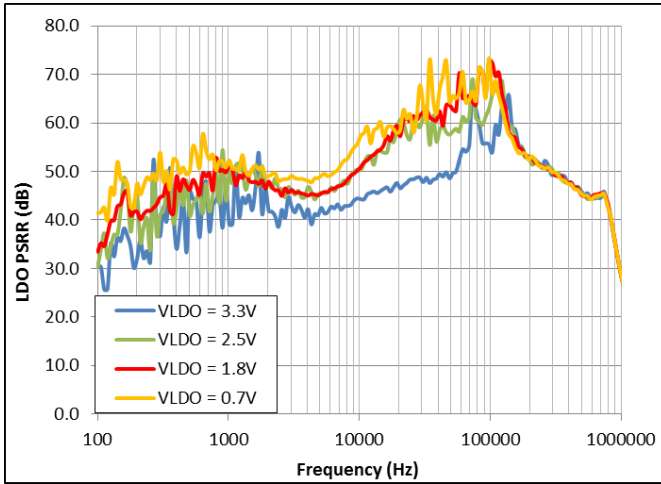

Figure 167: LDO $V_{IN} = 3.7\text{ V}$, LDO No Load

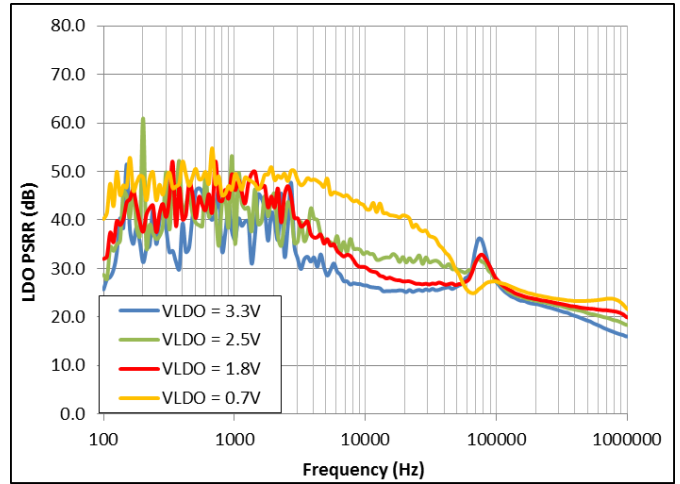

Figure 178: LDO $V_{IN} = 3.7\text{ V}$, LDO $I_{LOAD} = 100\text{ mA}$

Integrated Ultra-Low Quiescent Current, Ultra-Low Output Ripple Buck Regulator with 100 mA LDO

10 Feature Descriptions

10.1 Chip Enable and Disable Through IC_EN

DA9233 features a dedicated IC_EN pin to enable and disable the chip. When IC_EN = high, the device is turned on. IC_EN voltage should not exceed VDD_SYS voltage on the device. When EN = low, the device is shut down completely, including I²C communications.

10.2 VDD Under-Voltage Lockout

DA9233 features an under-voltage lockout (UVLO) on VDD. When VDD falls below UVLO falling threshold, both buck and LDO are disabled, see Section 10.4.9 for fault behaviour and control, A VIN_UV_Event will be flagged if it is not masked. When VDD rises above the UVLO rising threshold, the device will be alive. VDD should be always tied to VDD_SYS on the PCB board so both VDD and VDD_SYS will share the same UVLO protection.

10.3 Over-Temperature Protection

DA9233 also features an on-Chip over-temperature protection (TSD). The die junction temperature is monitored when LDO is ON. When the junction temperature is higher than the thermal shutdown threshold, both buck and LDO are disabled to prevent the device being damaged by over-heating, see Section 10.4.9 for fault behavior and control. An OT_Event will be flagged if it is not masked.

10.4 Buck Regulator

DA9233 includes a nano-ampere standby buck regulator with an adjustable output voltage, Dynamic Voltage Scaling capability and a maximum load current of 60 mA. It also has power saving mode operation and different protection features.

10.4.1 Buck Output Voltage Programmability

The DA9233 buck regulator can be set to two different ranges based on the value of VOUT_RANGE_HI. The value of BUCK_VOUT<4:0> is locked to a certain range based on the value of VOUT_RANGE_HI, and VOUT_RANGE_HI can only be changed while the buck is disabled. The buck can be set to the output voltages shown in Table 11. If a command is received outside of the allowable range (that is above 1.3 V for VOUT_RANGE_HI = 0 or below 1.3 V for VOUT_RANGE_HI = 1), digital will force the value of BUCK_VOUT<3:0> to 01110 (1.3 V).

Table 11: Buck Output Voltage Settings

VOUT_RANGE_HI	BUCK_VOUT<4:0>	Buck Output Voltage (V)
0	00000	0.60
0	00001	0.65
0	00010	0.70
0	00011	0.75
0	00100	0.80
0	00101	0.85

Integrated Ultra-Low Quiescent Current, Ultra-Low Output Ripple Buck Regulator with 100 mA LDO

VOUT_RANGE_HI	BUCK_VOUT<4:0>	Buck Output Voltage (V)
0	00110	0.90
0	00111	0.95
0	01000	1.00
0	01001	1.05
0	01010	1.10
0	01011	1.15
0	01100	1.20
0	01101	1.25
0 or 1	01110	1.30
1	01111	1.35
1	10000	1.40
1	10001	1.45
1	10010	1.50
1	10011	1.55
1	10100	1.60
1	10101	1.65
1	10110	1.70
1	10111	1.75
1	11000	1.80
1	11001	1.85
1	11010	1.90
1	11011	1.90
1	11100	1.90
1	11101	1.90
1	11110	1.90
1	11111	1.90

10.4.2 Start-up Operation

DA9233 buck integrates a start-up circuit to minimize output voltage over-shoot and input voltage drop during start-up. When writing 1 to BUCK_EN (Bit 7 of Reg0x05), the buck is enabled and starts switching after a typical delay time of 3 ms. During start-up, the cycle-by-cycle current limit is reduced to limit inrush current.

Integrated Ultra-Low Quiescent Current, Ultra-Low Output Ripple Buck Regulator with 100 mA LDO

10.4.3 Power Saving Mode Operation

DA9233 buck regulator features power saving mode that greatly reduces the quiescent current when device has very light load condition. Buck regulator operates in discontinuous mode with Pulse Frequency Modulation (PFM). The low-side FET will be turned off based on a zero-crossing comparator to prevent negative inductor current flowing through the FET which can result in additional conduction loss. If both FETs remain in the OFF state for a certain delay time after inductor current crosses zero, the device will enter power saving mode. In power saving mode, DA9233 shuts down most of the internal circuitry to save current consumption. The lighter the load, the longer the duration of power saving mode will be, to achieve the lowest quiescent current and improve light load efficiency.

10.4.4 Dynamic Voltage Control

DA9233 buck regulator has dynamic voltage control (DVC) feature which allows the buck output voltage to track the internal reference voltage when it changes at a rate of 50 mV / 2 ms. Since the buck output voltage can only be changed within an allowable range while still keeping the buck enabled, DVC also follows the same behaviour. The DVC is done via I²C, whereby the buck output voltage setting is stepped in 50 mV steps within either the low range or high range. Each voltage step lasts for 2 ms.

10.4.5 Cycle-by-cycle Over-Current Protection

For the Over-current Protection (OCP) in DA9233, the peak current through high-side FET is monitored cycle-by-cycle. When the sensed current exceeds the pre-set current limit, the high-side FET will be turned OFF immediately to limit the inductor current. The high-side FET will be turned on again after the constant-off time expires. If the OC condition persists for 64 μ s, buck will be forced off and buck output will be pull-down until the fault clears, see Section 10.4.9 for fault behavior and control and Section 10.4.8 for output voltage discharge and control. An OC_BUCK_Event will be flagged if it is not masked.

10.4.6 Output Over-Voltage Protection

DA9233 features an output over-voltage protection (OVP) to protect the load from damage. When both IC_EN and BUCK_EN are high and the buck output voltage is 200 mV greater than the internal reference voltage, the high side FET is immediately OFF, see Section 10.4.9 for fault behavior and control. Then the internal buck output discharge FET will be turned on to discharge buck output capacitor, see Section 10.4.8 for output voltage discharge and control. An OV_BUCK_Event will be flagged if it is not masked. Buck will remain off and buck output will be pull-down until the fault is cleared.

10.4.7 Output Under-Voltage Protection

When buck output short happens, inductor current will increase until the peak reaches the cycle-by-cycle current limit. Then the high-side FET turns OFF and low-side FET turns on. Since buck output is shorted, inductor current slope is very small during low-side FET on time. The inductor current could gradually go higher and higher. To effectively prevent the inductor current running away at V_{OUT} short condition, buck V_{OUT} is also monitored. If over-current condition happens and buck V_{OUT} drops 400 mV below the reference voltage, the buck regulator will be shut off immediately and an UV_BUCK_Event will be flagged if it is not masked, see Section 10.4.9 for fault behavior and control.

Integrated Ultra-Low Quiescent Current, Ultra-Low Output Ripple Buck Regulator with 100 mA LDO

10.4.8 Automatic Output voltage Discharge

To speed up the discharging of buck output capacitor and ensure a safer start-up next time, the buck regulator provides automatic output voltage discharge when IC_EN is pulled low or buck shutdown caused by any fault. Automatic output discharge when buck is forced OFF by fault needs to set register bit BUCK_PD_CFG1 = 0; automatic output discharge when buck is disabled by BUCK_EN = 0 needs to set register bit BUCK_PD_CFG2 = 0. The output of the buck regulator is discharged through VBUCK_SNS pin and an internal buck output discharge FET with typical 33 Ω resistance.

10.4.9 Event Flag and Fault Control

DA9233 has the flexibility for customers to control the behavior of buck/LDO when there is a fault condition. There are five register bits (UVLO_FRC_DIS, TSD_FRC_DIS, OV_DIS_BUCK, OC_BUCK_EVENT, SC_DIS_BUCK) controlling whether the buck/LDO will be disabled when the corresponding fault condition happens. In addition, users can choose whether to mask or unmask the event flag when the fault condition happens.

When there is a VDD Under-voltage condition, both BUCK and LDO will be forced OFF if UVLO_FRC_DIS = 1. Buck and LDO will remain alive if UVLO_FRC_DIS = 0. During the VDD Under-voltage condition, the event register bit VIN_UV_EVENT = 1 if the corresponding mask register bit M_VIN_UV is set to 0 otherwise VIN_UV_EVENT = 0.

When there is an Over-Temperature fault inside the device, both buck and LDO will be forced OFF if TSD_FRC_DIS = 1. If TSD_FRC_DIS = 0, buck and LDO will remain alive. During the over-temperature condition, the event register bit OT_EVENT = 1.

When there is an over-voltage fault at buck output, buck will be forced OFF if OV_DIS_BUCK = 1. Buck will continue switching if OV_DIS_BUCK = 0. During the fault, OV_BUCK_EVENT is set to 1 if M_OV_BUCK_EVENT = 0 otherwise OV_BUCK_EVENT = 0.

When the over-current condition in buck persists for 64 μ s and M_OC_BUCK_EVENT is set to 0, OC_BUCK_EVENT will be set to 1. If OC_DIS_BUCK = 1, BUCK is forced disabled. If OC_DIS_BUCK = 0, buck will continue switching during the over-current condition.

When there is a buck Output under-voltage condition and M_UV_BUCK_EVENT = 0, UV_BUCK_EVENT is set to 1. If both buck output under-voltage and over-current condition exist and SC_DIS_BUCK = 1, buck will be forced OFF. If SC_DIS_BUCK = 0, buck will continue switching without shutting down by the under-voltage protection.

DA9233 also has a fault recovery mechanism that can be customized through the 3-bits RCVRY_NUM. This value determines the fault recovery trial number for buck and is counted down by every fault that triggers buck OFF. When RCVRY_NUM reaches 0, recovery trial is ended and buck will remain OFF even if the buck enable signals are toggled HI. If RCVRY_NUM is set to 0x7, there will be no count down on the recovery trial number and recovery trail will not be ended. Before RCVRY_NUM reaches 0, buck will be recovered automatically if the fault condition disappears.

Event flags are not automatically cleared when the fault conditions disappear. They have to be cleared by changing the values in register EVENT through I²C.

Integrated Ultra-Low Quiescent Current, Ultra-Low Output Ripple Buck Regulator with 100 mA LDO

10.5 Load Switch, LDO Output and Control

10.5.1 LDO Output Programmability

The LDO can be set to the output voltages shown in [Table 12](#). The LDO output voltage can only be changed while LDO is disabled.

Table 12: LDO Output Voltages Settings

LDO_VOUT<4:0>	LDO Output Voltage (V)
00000	0.7
00001	0.8
00010	0.9
00011	1.0
00100	1.1
00101	1.2
00110	1.3
00111	1.4
01000	1.5
01001	1.6
01010	1.7
01011	1.8
01100	1.9
01101	2.0
01110	2.1
01111	2.2
10000	2.3
10001	2.4
10010	2.5
10011	2.6
10100	2.7
10101	2.8
10110	2.9
10111	3.0
11000	3.1
11001	3.2
11010	3.3
11011	Load switch mode

Integrated Ultra-Low Quiescent Current, Ultra-Low Output Ripple Buck Regulator with 100 mA LDO

LDO_VOUT<4:0>	LDO Output Voltage (V)
11100	Load switch mode
11101	Load switch mode
11110	Load switch mode
11111	Load switch mode

10.5.2 Automatic Output Voltage Discharge

Similar to buck regulator, the LDO also provides automatic output voltage discharge when IC_EN is pulled low or LDO turn-off caused by any fault. The internal LDO output discharge FET has a typical 25 Ω resistance.

10.5.3 Load Switch

DA9233 also features load switch mode for its LDO. When LDO_VOUT<4:0> is set to any value between 11011 and 11111, the LDO is configured as a load switch. In load switch mode, the LDO FET is fully ON. The turn-on and turn-off of load switch is controlled only through I²C command.

See Section 10.4.9 for fault behaviour and control, and Section 10.4.8 for output voltage discharge and control.

Integrated Ultra-Low Quiescent Current, Ultra-Low Output Ripple Buck Regulator with 100 mA LDO

10.6 I²C Programming

10.6.1 Interface Description

DA9233 includes an I²C compatible interface based on the following signals:

- SCL: standard 400 kHz I²C bus serial clock generated by the Host processor
- SDA: standard 400 kHz I²C bus serial address/data input output

SDA and SCL are open drain I/O terminals. The standard frequency of the I²C bus is 400 kHz in fast mode or 100 kHz in slow mode.

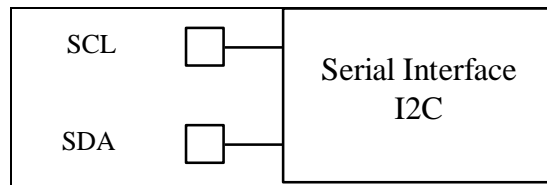

Figure 189: I²C Serial Interface Pins

The I²C bus is used to control most functions and change register values depending on the application requirements. In active battery, the I²C circuitry is powered from the battery. The interface maintains a proper operation as long as VDD_SYS is valid.

The device is compatible with the standard I²C protocol but only operates as a slave. The transfer protocol is the same whether operating in fast or slow mode.

10.6.2 Details of the I²C Protocol

The device supports 7-bit addressing only, the address is 0x2F. The 8-bit shifted address is 0x5E. A timer runs during I²C transitions. If the timer expires while SDA is held low, all additional commands are ignored and the I²C state machine is reset. The timer is reset with a START condition and stopped with a STOP condition.

The I²C bus is monitored at all times for a valid SLAVE address, and an acknowledge bit is generated if the SLAVE address was true.

- A START condition is initiated by a high to low transition on the SDA line while the SCL is in the high state.
- A STOP condition is indicated by a low to high transition on the SDA line while the SCL is in the high state.
- An ACKNOWLEDGE is indicated by the receiver pulling the SDA line low during the following clock cycle.

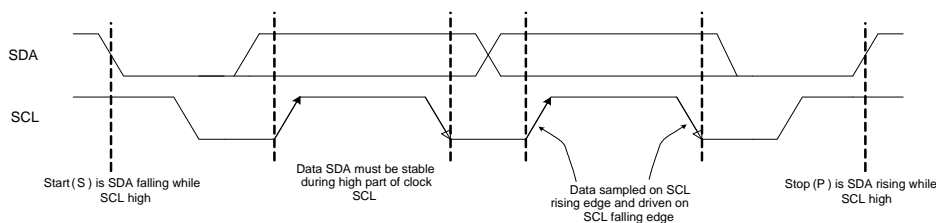

Figure 20: I²C Start and Stop Conditions

Integrated Ultra-Low Quiescent Current, Ultra-Low Output Ripple Buck Regulator with 100 mA LDO

When the address is matching the following event sequence happens:

1. The device generates an ACKNOWLEDGE to indicate to the master that the communication link has been established
2. The master generates SCL clock cycles to transmit or receive data
3. After receiving data, an ACKNOWLEDGE is generated either by the device or the master (whichever is transmitting the data)
A data sequence is 9-bit, consisting of 8-bit data and 1-bit ACKNOWLEDGE. It can be repeated as long as necessary.
4. The master generates a STOP condition to end the data transfer

The bus returns to IDLE-mode if during a message a new START or STOP condition occurs. Data is transmitted MSB first for both R/W operations.

10.7 GPO Pin Function Programming

DA9233 has a General purpose output (GPO) pin which can be programmed to have multiple functions.

10.7.1 Power Good Indicator

When GPO pin is configured to the VDD power good indicator, it is an open drain output and can be configured to either active high or active low. When GPO status is Hi-Z, an external pull-up is required for GPO to be high.

Table 13: GPO as Power Good Indicator

GPO Configuration	$V_{IN} > V_{IN_UVLO}$	GPO Status
Active High	No	0
	Yes	Hi-Z
Active Low	No	Hi-Z
	Yes	0

10.7.2 Event Indicator

GPO pin can also be configured as the event indicator in open drain output. Whenever there is an event or multiple events (VIN_UV_EVNT or OV_BUCK_EVENT or OC_BUCK_EVENT or UV_BUCK_EVENT) happen, GPO will be pulled down Low. This can be used as an interrupt to host CPU to inform events happened. When there is no event, GPO will remain in Hi-Z status and an external pull-up is required for GPO to be high.

10.7.3 Reset Pulse Generation

GPO pin can be configured to generate a reset pulse signal when buck starts. The reset signal can be used by host CPU or other device that are connected to buck output. When GPO is Low, it indicates a reset pulse period; when GPO is in Hi-Z status (An external pull-up is required for GPO to be high), it indicates a non-reset period.

There is also a timing control to negate the reset pulse signal. The GPO reset pulse width can be adjusted between 8 and 112 ms measured from written 1 to BUCK_EN register bit.

Integrated Ultra-Low Quiescent Current, Ultra-Low Output Ripple Buck Regulator with 100 mA LDO

10.7.4 Always Pull-Down or Hi-Z

When GPO pin is not used, it can be configured to either always Hi-Z or pull-down to Low.

Integrated Ultra-Low Quiescent Current, Ultra-Low Output Ripple Buck Regulator with 100 mA LDO

11 Register Overview

11.1 Register Map

11.1.1 Buck and LDO Control

Table 14: Event/Status/Mask and User Registers

User Registers									
Register	Addr	7	6	5	4	3	2	1	0
EVENT	0x0000	OT_EVENT	VIN_UV_EVENT	Reserved	OC_BUCK_EVENT	OV_BUCK_EVENT	UV_BUCK_EVENT	Reserved	Reserved
STATUS	0x0002	OT_STAT	VIN_UV_STAT	Reserved	OC_BUCK_STAT	OV_BUCK_STAT	UV_BUCK_STAT	Reserved	BUCK_EN_STAT
MASK	0x0003	Reserved	M_VIN_UV	Reserved	M_OC_BUCK_EVENT	M_OV_BUCK_EVENT	M_UV_BUCK_EVENT	Reserved	Reserved
GPO	0x0004	GPO_RST_CTRL<3:0>				GPO_CTRL<3:0>			
BUCK	0x0005	BUCK_EN	VOUT_RANGE_HI	Reserved	BUCK_VOUT<4:0>				
BUCK_CFG	0x0006	Reserved	Reserved	BUCK_PD_CFG2	BUCK_PD_CFG1	Reserved	Reserved	SEL_BUCK_ILIM<1:0>	
LS_LDO	0x0007	EN_LS_LDO	Reserved	Reserved	LS_LDO<4:0>				
FAULT_CTL	0x0008	SC_DIS_BUCK	OC_DIS_BUCK	OV_DIS_BUCK	TSD_FRC_DIS	UVLO_FRC_DIS	RCVRY_NUM<2:0>		
PIN_MONITOR	0x000A	Reserved	Reserved	Reserved	Reserved	Reserved	Reserved	Reserved	GPO_OUT_MON

Integrated Ultra-Low Quiescent Current, Ultra-Low Output Ripple Buck Regulator with 100 mA LDO

11.1.2 System Module

Table 15: System Registers

User Registers									
Register	Addr	7	6	5	4	3	2	1	0
SYS_RST_EVENT	0x0001	Reserved	Reserved	Reserved	Reserved	Reserved	Reserved	Reserved	RESET_EVENT
SYS_SRST	0x0009	Reserved	Reserved	Reserved	Reserved	SRST<3:0>			
SYS_DEVICE_ID	0x0080	DEV_ID<7:0>							
SYS_VARIANT_ID	0x0081	MRC<3:0>				VRC<3:0>			
SYS_CONFIG_ID	0x0082	CONFIG_REV<7:0>							

11.2 Register Definitions

11.2.1 Buck and LDO Control

11.2.1.1 Event/Status/Mask Registers

Table 16: Register EVENT

Address	Register Name	POR Value	Event flag						
0x0000	EVENT	0x00							
7	6	5	4	3	2	1	0		
OT_EVENT	VIN_UV_EVENT	Reserved	OC_BUCK_EVENT	OV_BUCK_EVENT	UV_BUCK_EVENT	Reserved	Reserved		

Integrated Ultra-Low Quiescent Current, Ultra-Low Output Ripple Buck Regulator with 100 mA LDO

Field Name	Bits	Type	POR	Description
OT_EVENT	[7]	evnt	0x0	Over Temperature fault event flag. When Over temperature condition is detected, this bit is set to 1. When I2C writes '1' to this bit, the event flag is cleared.
VIN_UV_EVENT	[6]	evnt	0x0	Under Voltage on VDD event flag. When Under Voltage (UVLO) condition is detected, this bit is set to 1. When I2C writes '1' to this bit, the event flag is cleared.
OC_BUCK_EVENT	[4]	evnt	0x0	Over Current on BUCK OUT event flag. When the buck Over Current condition is detected (when BUCK_EN==1 && M_OC_BUCK==0), this bit is set to 1. When I2C writes '1' to this bit, the event flag is cleared.
OV_BUCK_EVENT	[3]	evnt	0x0	Over Voltage on BUCK OUT event flag. When the buck Over Voltage condition is detected (when BUCK_EN==1 && M_OV_BUCK==0), this bit is set to 1. When I2C writes '1' to this bit, the event flag is cleared.
UV_BUCK_EVENT	[2]	evnt	0x0	Under voltage on BUCK OUT event flag. When the under voltage condition (i.e. short circuit) is detected on the buck (when BUCK_EN==1 && M_UV_BUCK==0), this bit is set to 1. When I2C writes '1' to this bit, this event flag is cleared.

Table 17: Register STATUS

Address	Register Name	POR Value	Status				
0x0002	STATUS	0x00					
7	6	5	4	3	2	1	0
OT_STAT	VIN_UV_STAT	Reserved	OC_BUCK_STAT	OV_BUCK_STAT	UV_BUCK_STAT	Reserved	BUCK_EN_STAT
Field Name	Bits	Type	POR	Description			
OT_STAT	[7]	virtual	0x0	Indicate present Over Temp status.			
VIN_UV_STAT	[6]	virtual	0x0	Indicate present VIN under-voltage status.			
OC_BUCK_STAT	[4]	virtual	0x0	Indicate present BUCK V _{OUT} over current status.			
OV_BUCK_STAT	[3]	virtual	0x0	Indicate present BUCK V _{OUT} over voltage status.			

Integrated Ultra-Low Quiescent Current, Ultra-Low Output Ripple Buck Regulator with 100 mA LDO

Field Name	Bits	Type	POR	Description
UV_BUCK_STAT	[2]	virtual	0x0	Indicate present BUCK V _{OUT} under voltage status.
BUCK_EN_STAT	[0]	virtual	0x0	Indicate present Buck Enable status. 1: Buck enabled 0: Buck disabled

Table 18: Register MASK

Address	Register Name	POR Value	Mask				
0x0003	MASK	0x7C					
7	6	5	4	3	2	1	0
Reserved	M_VIN_UV	Reserved	M_OC_BUCK_EVENT	M_OV_BUCK_EVENT	M_UV_BUCK_EVENT	Reserved	Reserved
Field Name	Bits	Type	POR	Description			
M_VIN_UV	[6]	cfg OTP	0x1	Mask to set VIN_UV_EVNT. VIN_UV_STAT is updated regardless of this mask.			
M_OC_BUCK_EVENT	[4]	cfg OTP	0x1	Masks to set OC_BUCK_EVENT. OC_BUCK_STAT is updated regardless of this mask.			
M_OV_BUCK_EVENT	[3]	cfg OTP	0x1	Masks to set OV_BUCK_EVENT. OV_BUCK_STAT is updated regardless of this mask.			
M_UV_BUCK_EVENT	[2]	cfg OTP	0x1	Masks to set UV_BUCK_EVENT. UV_BUCK_STAT is updated regardless of this mask.			

Integrated Ultra-Low Quiescent Current, Ultra-Low Output Ripple Buck Regulator with 100 mA LDO

11.2.1.2 User Registers

Table 19: Register GPO

Address	Register Name	POR Value	GPO control				
0x0004	GPO	0x00					
7	6	5	4	3	2	1	0
GPO_RST_CTRL<3:0>				GPO_CTRL<3:0>			
Field Name	Bits	Type	POR	Description			
GPO_RST_CTRL	[7:4]	cfg OTP	0x0	Reset pulse signal negate timing control			
				Value	Description		
				0x0	8 ms after BUCK_EN = 1, GPO reset pulse is negated.		
				0x1	16 ms after BUCK_EN = 1, GPO reset pulse is negated.		
				0x2	32 ms after BUCK_EN = 1, GPO reset pulse is negated.		
				0x3	48 ms after BUCK_EN = 1, GPO reset pulse is negated.		
				0x4	64 ms after BUCK_EN = 1, GPO reset pulse is negated.		
				0x5	80 ms after BUCK_EN = 1, GPO reset pulse is negated.		
				0x6	96 ms after BUCK_EN = 1, GPO reset pulse is negated.		
				0x7	112 ms after BUCK_EN = 1, GPO reset pulse is negated.		
				0x8	8 ms after EN_LS_LDO = 1, GPO reset pulse is negated.		
				0x9	16 ms after EN_LS_LDO = 1, GPO reset pulse is negated.		
				0xA	32 ms after EN_LS_LDO = 1, GPO reset pulse is negated.		
0xB	48 ms after EN_LS_LDO = 1, GPO reset pulse is negated.						

Integrated Ultra-Low Quiescent Current, Ultra-Low Output Ripple Buck Regulator with 100 mA LDO

Field Name	Bits	Type	POR	Description	
				0xC 64 ms after EN_LS_LDO = 1, GPO reset pulse is negated.	
				0xD 80 ms after EN_LS_LDO = 1, GPO reset pulse is negated.	
				0xE 96 ms after EN_LS_LDO = 1, GPO reset pulse is negated.	
				0xF 112 ms after EN_LS_LDO = 1, GPO reset pulse is negated.	
GPO_CTRL	[3:0]	cfg OTP	0x0	GPO Control	
				Value	Description
				0x1	Reset Pulse generation output
				0x2	PowerGood indicator, Active Low
				0x3	PowerGood indicator, Active High
				0x4	Event indicator
				0x8	Force GPO output low
				0x9	Force GPO output hi-z

Table 20: Register BUCK

Address	Register Name	POR Value					
0x0005	BUCK	0x58	Buck enable & V _{OUT} control				
7	6	5	4	3	2	1	0
BUCK_EN	VOUT_RANGE_HI	Reserved	BUCK_VOUT<4:0>				
Field Name	Bits	Type	POR	Description			
BUCK_EN	[7]	cfg OTP	0x0	BUCK enable			

Integrated Ultra-Low Quiescent Current, Ultra-Low Output Ripple Buck Regulator with 100 mA LDO

Field Name	Bits	Type	POR	Description	
VOUT_RANGE_HI	[6]	cfg OTP	0x1	Range selection for buck. This can only be changed while BUCK_EN = 0	
				Value	Description
				0x0	0.60 V <= VBUCK <= 1.30 V
				0x1	1.30 V <= VBUCK <= 1.90 V
BUCK_VOUT	[4:0]	datablk OTP	0x18	Buck output voltage	
				Value	Description
				0x00	0.60 V
				0x01	0.65 V
				0x02	0.70 V
				0x03	0.75 V
				0x04	0.80 V
				0x05	0.85 V
				0x06	0.90 V
				0x07	0.95 V
				0x08	1.00 V
				0x09	1.05 V
				0x0A	1.10 V
				0x0B	1.15 V
0x0C	1.20 V				
0x0D	1.25 V				

Integrated Ultra-Low Quiescent Current, Ultra-Low Output Ripple Buck Regulator with 100 mA LDO

Field Name	Bits	Type	POR	Description
				0x0E 1.30 V
				0x0F 1.35 V
				0x10 1.40 V
				0x11 1.45 V
				0x12 1.50 V
				0x13 1.55 V
				0x14 1.60 V
				0x15 1.65 V
				0x16 1.70 V
				0x17 1.75 V
				0x18 1.80 V
				0x19 1.85 V
				0x1A 1.90 V
				0x1B 1.90 V
				0x1C 1.90 V
				0x1D 1.90 V
				0x1E 1.90 V
				0x1F 1.90 V

Integrated Ultra-Low Quiescent Current, Ultra-Low Output Ripple Buck Regulator with 100 mA LDO

Table 21: Register BUCK_CFG

Address	Register Name	POR Value	Buck config				
0x0006	BUCK_CFG	0x00					
7	6	5	4	3	2	1	0
Reserved	Reserved	BUCK_PD_CFG2	BUCK_PD_CFG1	Reserved	Reserved	SEL_BUCK_ILIM<1:0>	
Field Name	Bits	Type	POR	Description			
BUCK_PD_CFG2	[5]	cfg OTP	0x0	0: If BUCK_EN = 0, BUCK_PD_EN = 1 1: If BUCK_EN = 0, BUCK_PD_EN = 0			
BUCK_PD_CFG1	[4]	cfg OTP	0x0	0: When BUCK is forced off by faults, BUCK_PD_EN = 1 1: When BUCK is forced off by faults, BUCK_PD_EN = 0			
SEL_BUCK_ILIM	[1:0]	cfg OTP	0x0	Buck peak current limit setting			
				Value	Description		
				0x0	Default current limit		
				0x1	Default +50 mA		
				0x2	Default +100 mA		
			0x3	Default +150 mA			

Table 22: Register LS_LDO

Address	Register Name	POR Value	LS/LDO control				
0x0007	LS_LDO	0x0A					
7	6	5	4	3	2	1	0
EN_LS_LDO	Reserved	Reserved	LS_LDO<4:0>				

Integrated Ultra-Low Quiescent Current, Ultra-Low Output Ripple Buck Regulator with 100 mA LDO

Field Name	Bits	Type	POR	Description	
EN_LS_LDO	[7]	cfg OTP	0x0	LDO Enable	
LS_LDO	[4:0]	cfg OTP	0xA	LDO voltage. This cannot be written when EN_LS_LDO is '1'	
				Value	Description
				0x00	0.70 V
				0x01	0.80 V
				0x02	0.90 V
				0x03	1.00 V
				0x04	1.10 V
				0x05	1.20 V
				0x06	1.30 V
				0x07	1.40 V
				0x08	1.50 V
				0x09	1.60 V
				0x0A	1.70 V
				0x0B	1.80 V
0x0C	1.90 V				
0x0D	2.00 V				
0x0E	2.10 V				
0x0F	2.20 V				
0x10	2.30 V				

Integrated Ultra-Low Quiescent Current, Ultra-Low Output Ripple Buck Regulator with 100 mA LDO

Field Name	Bits	Type	POR	Description
				0x11 2.40 V
				0x12 2.50 V
				0x13 2.60 V
				0x14 2.70 V
				0x15 2.80 V
				0x16 2.90 V
				0x17 3.00 V
				0x18 3.10 V
				0x19 3.20 V
				0x1A 3.30 V
				0x1B Load Switch Mode
				0x1C Load Switch Mode
				0x1D Load Switch Mode
				0x1E Load Switch Mode
				0x1F Load Switch Mode

Table 23: Register FAULT_CTL

Address	Register Name	POR Value	Description
0x0008	FAULT_CTL	0x1F	Fault & Recovery control

Integrated Ultra-Low Quiescent Current, Ultra-Low Output Ripple Buck Regulator with 100 mA LDO

7	6	5	4	3	2	1	0
SC_DIS_BUCK	OC_DIS_BUCK	OV_DIS_BUCK	TSD_FRC_DIS	UVLO_FRC_DIS	RCVRY_NUM<2:0>		
Field Name	Bits	Type	POR	Description			
SC_DIS_BUCK	[7]	cfg OTP	0x0	1: Force disable BUCK during SHORT CIRCUIT condition oc_buck=1 & uv_buck=1			
OC_DIS_BUCK	[6]	cfg OTP	0x0	1: Force disable BUCK during oc_buck=1 for over 64 cycles			
OV_DIS_BUCK	[5]	cfg OTP	0x0	1: Force disable BUCK during ov_buck=1			
TSD_FRC_DIS	[4]	cfg OTP	0x1	1: Force disable BUCK & LDO during Over Temp			
UVLO_FRC_DIS	[3]	cfg OTP	0x1	1: Force disable BUCK & LDO during UVLO			
RCVRY_NUM	[2:0]	data OTP	0x7	BUCK recovery trial fault number. This is counted down by every fault forcing BUCK off. If RCVRY_NUM becomes 0, Recovery trial is ended. If RCVRY_NUM is set 0x7, this is not counted down and recovery trail is not ended.			

Table 24: Register PIN_MONTOR

Address	Register Name	POR Value	PIN MONITOR				
0x000A	PIN_MONTOR	0x00					
7	6	5	4	3	2	1	0
Reserved	Reserved	Reserved	Reserved	Reserved	Reserved	Reserved	GPO_OUT_MON
Field Name	Bits	Type	POR	Description			
GPO_OUT_MON	[0]	virtual	0x0	Indicate current GPO output			

Integrated Ultra-Low Quiescent Current, Ultra-Low Output Ripple Buck Regulator with 100 mA LDO

11.2.2 System Module

11.2.2.1 System Reset Registers

Table 25: Register SYS_RST_EVENT

Address	Register Name	POR Value	Reset Event flag				
0x0001	SYS_RST_EVENT	0x01					
7	6	5	4	3	2	1	0
Reserved	Reserved	Reserved	Reserved	Reserved	Reserved	Reserved	RESET_EVENT
Field Name	Bits	Type	POR	Description			
RESET_EVENT	[0]	evnt	0x1	RESET event flag. After Reset, this bit is set. When I2C write '1' to this bit, this event flag is cleared.			

Table 26: Register SYS_SRST

Address	Register Name	POR Value	Soft Reset				
0x0009	SYS_SRST	0x00					
7	6	5	4	3	2	1	0
Reserved	Reserved	Reserved	Reserved	SRST<3:0>			
Field Name	Bits	Type	POR	Description			
SRST	[3:0]	cfg	0x0	Initiate Soft Reset by writing 0x5.			

Integrated Ultra-Low Quiescent Current, Ultra-Low Output Ripple Buck Regulator with 100 mA LDO

11.2.2.2 System ID Registers

Table 27: Register SYS_DEVICE_ID

Address	Register Name	POR Value	DEVICE_ID				
0x0080	SYS_DEVICE_ID	0x00					
7	6	5	4	3	2	1	0
DEV_ID<7:0>							
Field Name	Bits	Type	POR	Description			
DEV_ID	[7:0]	virtual	0x0	Device ID; hard-coded or metal-programmed			

Table 28: Register SYS_VARIANT_ID

Address	Register Name	POR Value	VARIANT_ID				
0x0081	SYS_VARIANT_ID	0x00					
7	6	5	4	3	2	1	0
MRC<3:0>				VRC<3:0>			
Field Name	Bits	Type	POR	Description			
MRC	[7:4]	virtual	0x0	Mask Revision Code; mask design changes increment reset value.			
VRC	[3:0]	trim OTP	0x0	Chip Variant Code; e.g. package variants.			

Table 29: Register SYS_CONFIG_ID

Address	Register Name	POR Value	CONFIG_ID
0x0082	SYS_CONFIG_ID	0x00	

Integrated Ultra-Low Quiescent Current, Ultra-Low Output Ripple Buck Regulator with 100 mA LDO

7	6	5	4	3	2	1	0
CONFIG_REV<7:0>							
Field Name	Bits	Type	POR	Description			
CONFIG_REV	[7:0]	trim OTP	0x0	OTP settings revision			

Integrated Ultra-Low Quiescent Current, Ultra-Low Output Ripple Buck Regulator with 100 mA LDO

12 Package Information

12.1 Package Outlines

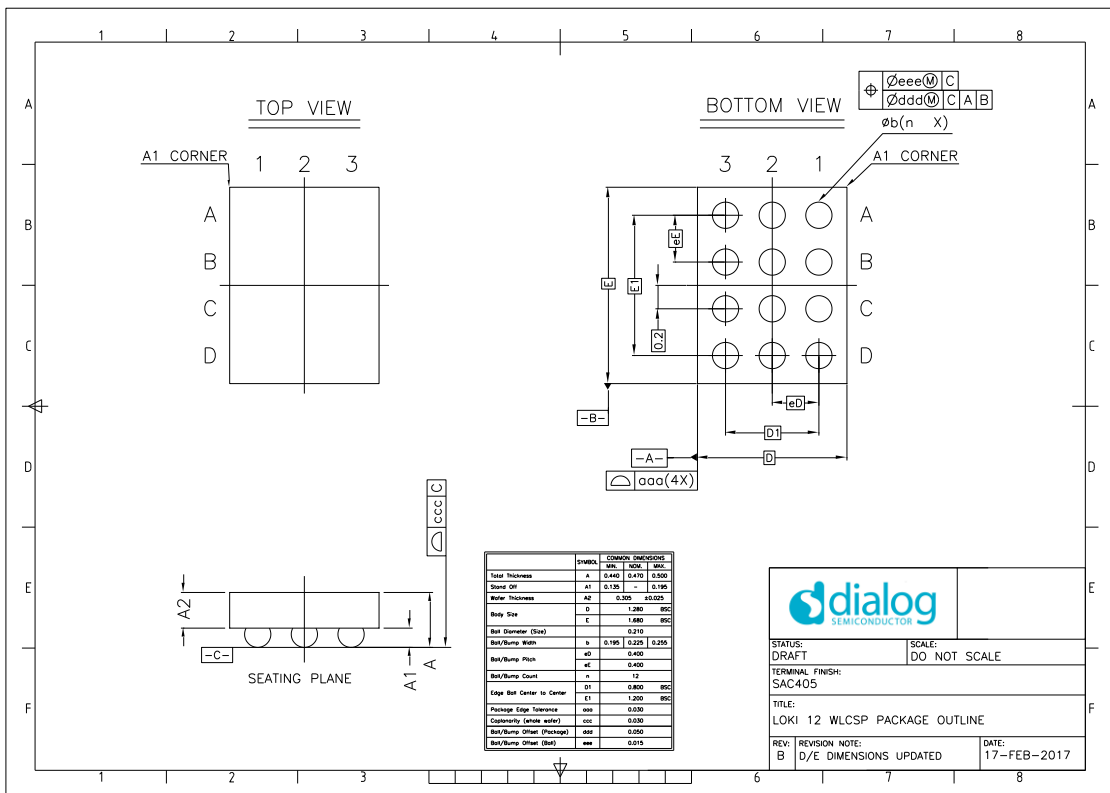

Figure 191: Package Outline Drawing

Integrated Ultra-Low Quiescent Current, Ultra-Low Output Ripple Buck Regulator with 100 mA LDO

12.2 Moisture Sensitivity Level

The Moisture Sensitivity Level (MSL) is an indicator for the maximum allowable time period (floor lifetime) in which a moisture sensitive plastic device, once removed from the dry bag, can be exposed to an environment with a maximum temperature of 30 °C and a maximum relative humidity of 60% RH before the solder reflow process. The MSL classification is defined in [Table 30](#).

The device package is qualified for MSL 1.

Table 30: MSL Classification

MSL level	Floor Lifetime
MSL 1	unlimited at 30 °C/85% RH

12.3 Soldering Information

Refer to the JEDEC standard J-STD-020 for relevant soldering information. This document can be downloaded from <http://www.jedec.org>.

Integrated Ultra-Low Quiescent Current, Ultra-Low Output Ripple Buck Regulator with 100 mA LDO

13 Ordering Information

The ordering number consists of the part number followed by a suffix indicating the packing method. For details and availability or other custom OTP parts, please consult your Renesas Electronics' [local sales representative](#).

Table 31: Ordering Information

Part number	Package	Size (mm)	Shipment Form	Pack Quantity
DA9233-xxxx	WLCSP-12	1.25 x 1.65	T&R	4500

Table 32: OTP List

Order number	Description	Buck V _{OUT} (V)	LDO V _{OUT} (V)
DA9233-A1VZ2	OTP with Buck and LDO voltage preconfigured	0.7	1.8

Integrated Ultra-Low Quiescent Current, Ultra-Low Output Ripple Buck Regulator with 100 mA LDO

Status Definitions

Revision	Datasheet Status	Product Status	Definition
1.<n>	Target	Development	This datasheet contains the design specifications for product development. Specifications may be changed in any manner without notice.
2.<n>	Preliminary	Qualification	This datasheet contains the specifications and preliminary characterization data for products in pre-production. Specifications may be changed at any time without notice in order to improve the design.
3.<n>	Final	Production	This datasheet contains the final specifications for products in volume production. The specifications may be changed at any time in order to improve the design, manufacturing and supply. Relevant changes will be communicated via Customer Product Notifications.
4.<n>	Obsolete	Archived	This datasheet contains the specifications for discontinued products. The information is provided for reference only.

Integrated Ultra-Low Quiescent Current, Ultra-Low Output Ripple Buck Regulator with 100 mA LDO

Important Notice and Disclaimer

RENESAS ELECTRONICS CORPORATION AND ITS SUBSIDIARIES (“RENESAS”) PROVIDES TECHNICAL SPECIFICATIONS AND RELIABILITY DATA (INCLUDING DATASHEETS), DESIGN RESOURCES (INCLUDING REFERENCE DESIGNS), APPLICATION OR OTHER DESIGN ADVICE, WEB TOOLS, SAFETY INFORMATION, AND OTHER RESOURCES “AS IS” AND WITH ALL FAULTS, AND DISCLAIMS ALL WARRANTIES, EXPRESS OR IMPLIED, INCLUDING, WITHOUT LIMITATION, ANY IMPLIED WARRANTIES OF MERCHANTABILITY, FITNESS FOR A PARTICULAR PURPOSE, OR NON-INFRINGEMENT OF THIRD PARTY INTELLECTUAL PROPERTY RIGHTS.

These resources are intended for developers skilled in the art designing with Renesas products. You are solely responsible for (1) selecting the appropriate products for your application, (2) designing, validating, and testing your application, and (3) ensuring your application meets applicable standards, and any other safety, security, or other requirements. These resources are subject to change without notice. Renesas grants you permission to use these resources only for development of an application that uses Renesas products. Other reproduction or use of these resources is strictly prohibited. No license is granted to any other Renesas intellectual property or to any third party intellectual property. Renesas disclaims responsibility for, and you will fully indemnify Renesas and its representatives against, any claims, damages, costs, losses, or liabilities arising out of your use of these resources. Renesas' products are provided only subject to Renesas' Terms and Conditions of Sale or other applicable terms agreed to in writing. No use of any Renesas resources expands or otherwise alters any applicable warranties or warranty disclaimers for these products.

© 2023 Renesas Electronics Corporation. All rights reserved.

(Rev.1.0 Mar 2020)

Corporate Headquarters

TOYOSU FORESIA, 3-2-24 Toyosu

Koto-ku, Tokyo 135-0061, Japan

www.renesas.com

Contact Information

For further information on a product, technology, the most up-to-date version of a document, or your nearest sales office, please visit:

<https://www.renesas.com/contact/>

Trademarks

Renesas and the Renesas logo are trademarks of Renesas Electronics Corporation. All trademarks and registered trademarks are the property of their respective owners.