

GENERAL DESCRIPTION

This document describes specifications for the F1653NLGI I/Q Modulator implementing Zero-Distortion™ technology for low power consumption with improved ACLR. This device interfaces directly to a high performance dual DAC.

COMPETITIVE ADVANTAGE

In typical multi-mode, multi-carrier basestation transmitters the modulator has limited linearity and high power consumption which penalizes the system ACLR and system Power consumptions budgets in a Digital-Pre-Distortion environment.

The IDTF1653 is designed to eliminate these penalties by embedding Zero-Distortion™ technology into the device such that very high IP3 and IP2 are achieved with minimal current draw.

- Power consumption ↓**45%**
- IM3 Distortion ↓**14 dB**

PART# MATRIX

Part#	RF freq Range	IP2 _o	Power Cons.	IP3 _o	Noise
F1650	600 – 2400	+60 dBm	587 mW	+36 dBm	-158 dBm/Hz
F1653	600 – 2900	+64 dBm	587 mW	+36 dBm	-159 dBm/Hz

FEATURES

- Power Gain = 3dB
- Direct 100Ω differential drive from Tx DAC
- **< 590mW Power Consumption**
- -159 dBm/Hz Output Noise
- -161 dBc/Hz Internal LO Path Noise
- IP2_o = +64 dBm @ 2GHz
- **IP3_o = +36 dBm @ 2GHz**
- Excellent native LO and image suppression
- 600 MHz input 1dB Bandwidth
- 600 MHz to 2900 MHz RF BW
- **Fast Settling for TDD (< 200 nsec)**
- 3.3V Single Power Supply
- LO port can be driven single ended or differential
- 4mm x 4mm, 24-pin TQFN package

DEVICE BLOCK DIAGRAM

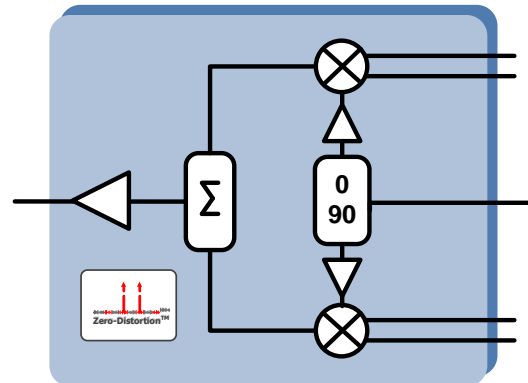

ORDERING INFORMATION



ABSOLUTE MAXIMUM RATINGS

VDD to GND	-0.3V to +3.6V
STBY	-0.3V to (VDD + 0.3V)
BB_I+, BB_I-, BB_Q+, BB_Q-	-0.3V to 1.8V
LO_IN	-0.3V to 0.3V
RF_OUT	(VDD-0.35V) to (VDD-0.05V)
Continuous Power Dissipation	1.5W
θ_{JA} (Junction – Ambient)	+45°C/W
θ_{JC} (Junction – Case) The Case is defined as the exposed paddle	+2.5°C/W
Operating Temperature Range (Case Temperature)	$T_{CASE} = -40^{\circ}\text{C}$ to $+105^{\circ}\text{C}$
Maximum Junction Temperature	150°C
Storage Temperature Range	-65°C to +150°C
Lead Temperature (soldering, 10s)	+260°C

Stresses above those listed above may cause permanent damage to the device. Functional operation of the device at these or any other conditions above those indicated in the operational section of this specification is not implied. Exposure to absolute maximum rating conditions for extended periods may affect device reliability

IDTF1653 RECOMMENDED OPERATION CONDITIONS

Parameter	Symbol	Comment	min	typ	max	units
Supply Voltage(s)	V_{DD}	All V_{DD} pins	3.15	3.30	3.45	V
Operating Temperature	T_{CASE}	Case Temperature	-40	25	+105	deg C
LO Freq Range	F_{LO}	LO power -3dBm to +5dBm	600		2900	MHz
BB Common Mode Voltage	V_{CM}	<ul style="list-style-type: none"> • $T_{CASE} = -40C$ to $+105C$ • $V_{DD} = 3.3$ V • LO level = 0dBm 	0.1	0.25	0.8	V
BB input voltage compliance range		For each BB pin	0		1	Vpeak
BB Freq Range	F_{BB}	<ul style="list-style-type: none"> ▪ $F_{LO} = 1950$ MHz, $BB_IQ = 200$ mVp-p ▪ P_{RF} degrades < 1 dB 	DC		600	MHz

IDTF1653 SPECIFICATION

See application circuit. Typical values are measured at $V_{DD} = +3.3V$, $F_{LO} = 1950$ MHz, $P_{LO} = 0$ dBm, $T_{CASE} = +25^{\circ}C$, STBY = GND, BB_IQ frequency = 49, 50 MHz, BB_I&Q levels = 200 mVp-p each (-13dBm and 14 dB backoff from 1V DAC compliance), I & Q = 0.250V common-mode bias unless otherwise noted.

Parameter	Symbol	Comment	min	typ	max	units
Logic Input High	V_{IH}	For STBY Pin	1.07			V
Logic Input Low	V_{IL}	For STBY Pin			0.68	V
Logic Current	I_{IH}, I_{IL}	For STBY Pin	-100		+1	μA
Supply Current (ON)	I_{SUPP}	Total V_{DD}		178	190¹	mA
Supply Current (STBY)	I_{STBY}	Total V_{DD} , STBY = V_{IH}		2.8	5	mA
LO Power	P_{LO}	600MHz to 2900MHz	-3		+5	dBm
BB Input Resistance (Differential)	R_{BB}	Freq = 100 MHz		113		Ω
LO port Impedance	Z_{LO}	<ul style="list-style-type: none"> Single Ended (RL < -10dB) Can be driven differentially 		50		Ω
RF port Impedance	Z_{RF}	Single Ended (RL < -10dB)		50		Ω
Power Gain	G		2.0	3.0	4.0	dB
Output IP3 @ 850 MHz	$IP3_{O1}$	LO = 800 MHz		37		dBm
Output IP3 @ 2.00 GHz	$IP3_{O2}$	LO = 1950 MHz	30	36		
Output IP3 @ 2.85 GHz	$IP3_{O3}$	LO = 2800 MHz		31		
Output IP2 @ 850 MHz	$IP2_{O1}$	LO = 800 MHz Differential baseband input		65		dBm
Output IP2 @ 2.00 GHz	$IP2_{O}$	LO = 1950 MHz Differential baseband input	58^2	64		
Output IP2 @ 2.85 GHz	$IP3_{O2}$	LO = 2800 MHz Differential baseband input		63		
Turn on time	P_{ON}	STBY = low to 90% final output power		175		nsec
Turn off time	P_{OFF}	STBY = high to initial output power -30dB		26		
LO (Carrier) Suppression	LO_{supp}	Native, Uncorrected $F_{LO} = 1950$ MHz		-39	-30	dBm
Sideband (Image) Suppression	SS	Native, Uncorrected $F_{LO} = 1950$ MHz Differential baseband input		-34	-30	dBc
Output P1dB	$P1dB_{O}$	Output Compression		15		dBm
Output Noise	NSD	<ul style="list-style-type: none"> 10 MHz offset from LO BB I&Q levels = 0 V_{p-p} 	-157	-159		dBm/Hz
LO Path Noise (internal)	$\Phi_{N,LO}$	+10 MHz offset		-161		dBc/Hz

SPECIFICATION NOTES:

- 1 – Items in min/max columns in **bold italics** are Guaranteed by Test
- 2 – All other Items in min/max columns are Guaranteed by Design Characterization

TYPICAL OPERATING CONDITIONS GRAPHS

Unless otherwise noted, the following conditions apply:

- Baseband I&Q levels = 200 mV_{PP} each (-13 dBm / Channel / Tone)
- Baseband I&Q tones = 49, 50 MHz
- Low Side Injection
- T_{AMB} = 25C, V_{CC} = 3.30 V, LO Power = 0 dBm
- V_{CM} = 0.250 Volts
- Flo = 1.95GHz unless otherwise specified
- EVKit RF output Trace and Connector Losses De-Embedded

EVkit RF output loss (Trace + Connector)

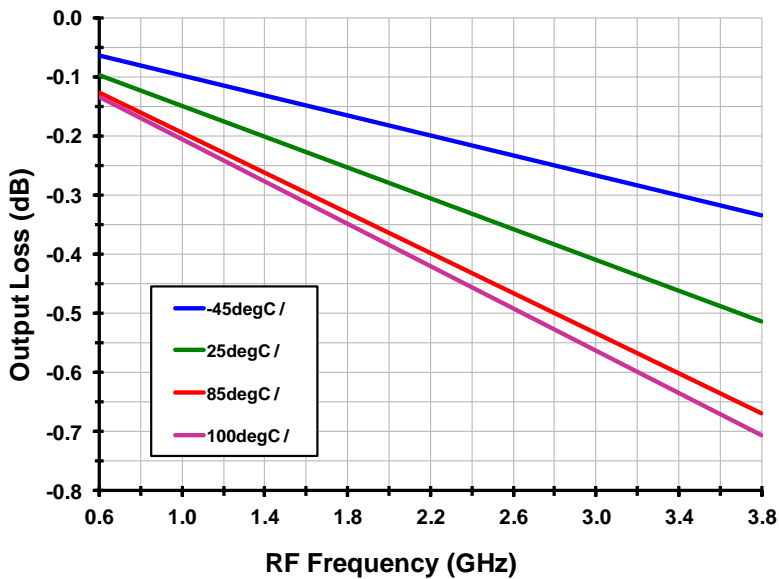

TYPICAL OPERATING CONDITIONS (-1-)

OIP3 vs. T_{AMB}

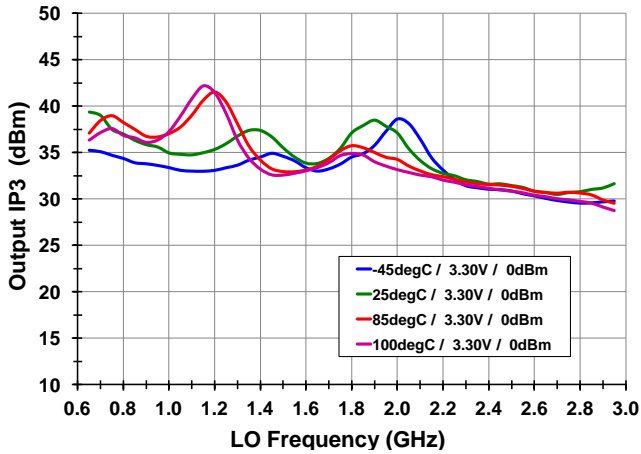

OIP3 vs. V_{CC}

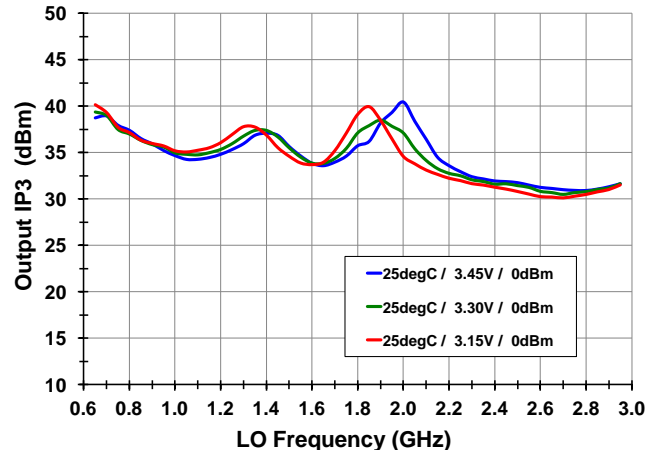

OIP3 vs. LO level

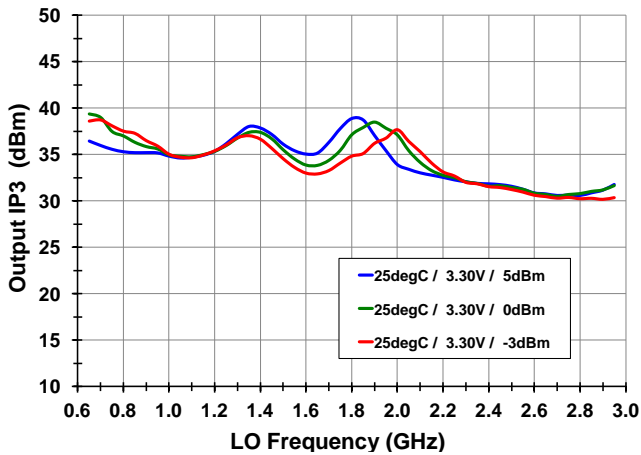

OIP2 vs. T_{AMB}

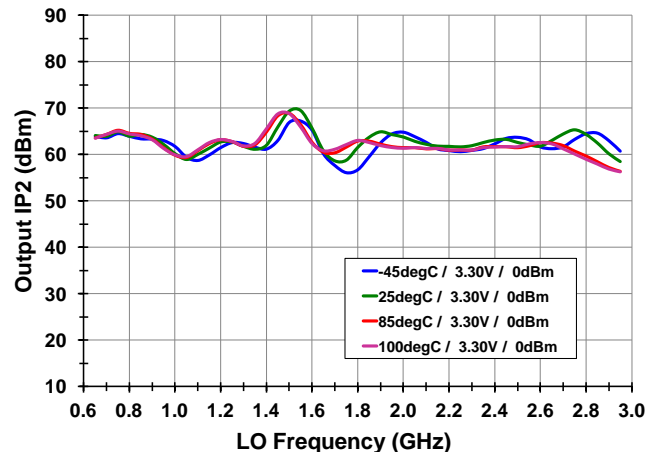

OIP2 vs. V_{CC}

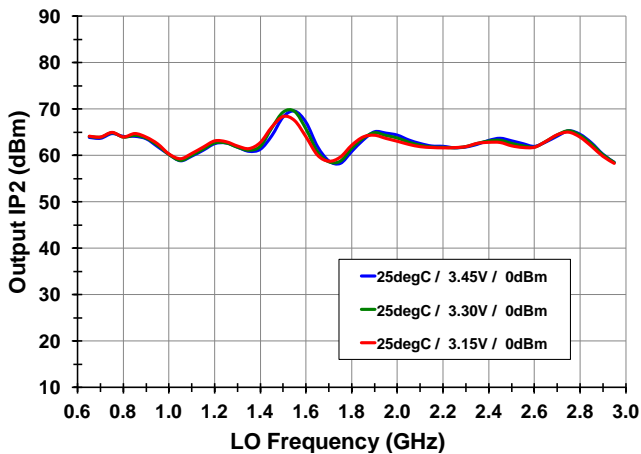

OIP2 vs. LO level

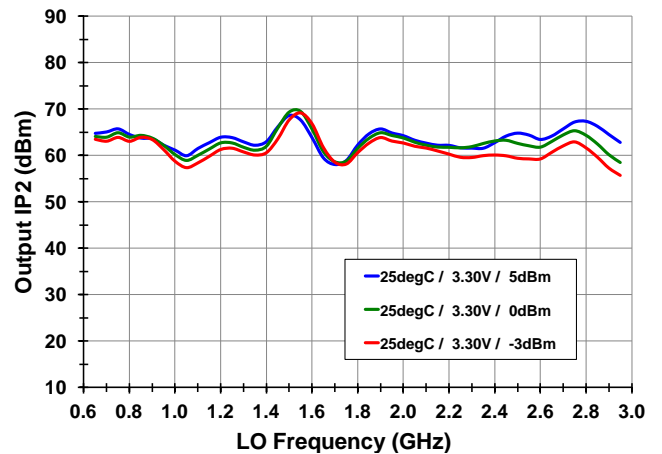

TYPICAL OPERATING CONDITIONS (-2-)

I_{CC} vs. T_{AMB}

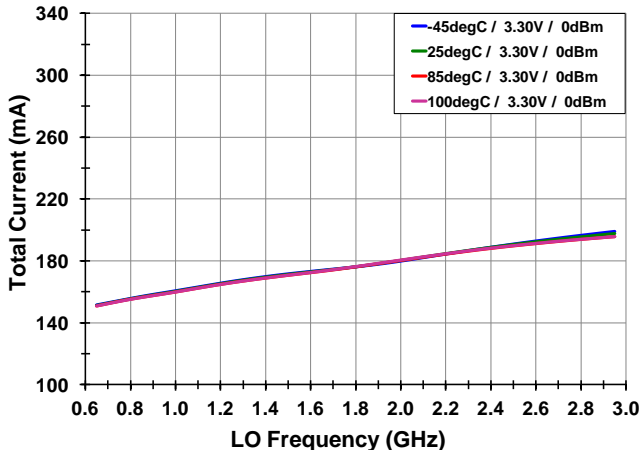

I_{CC} vs. V_{CC}

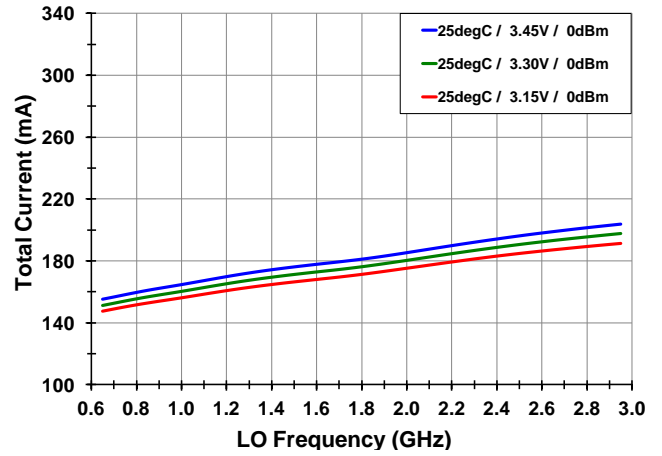

I_{CC} vs. LO level

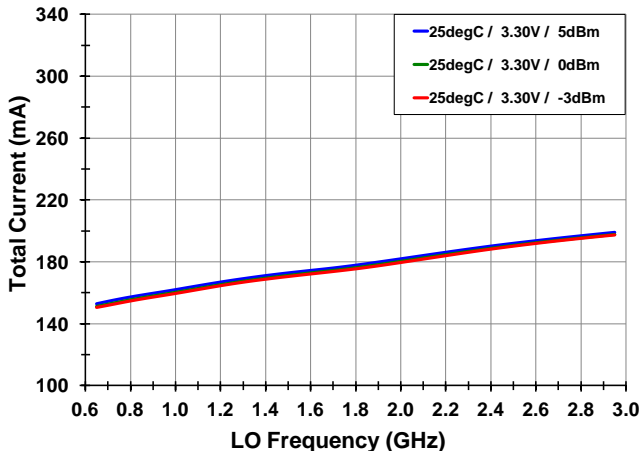

Power Consumption vs. T_{AMB}

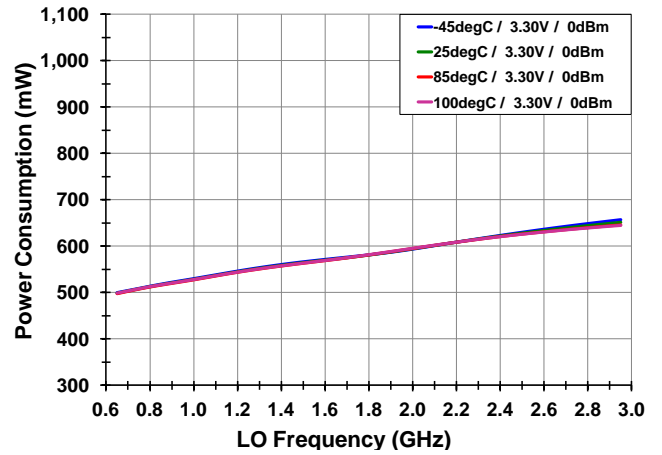

Power Consumption vs. V_{CC}

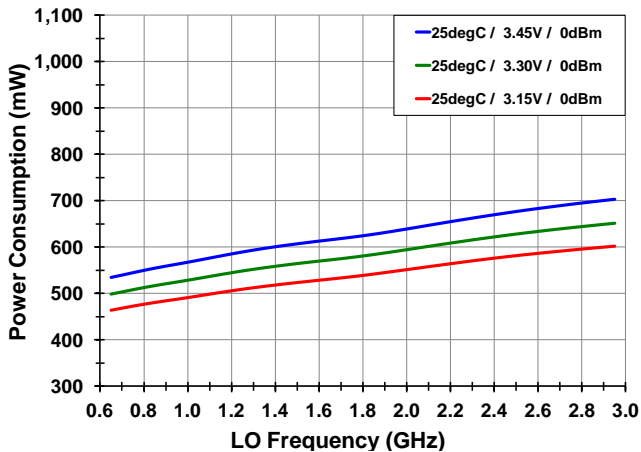

Power Consumption vs. LO level

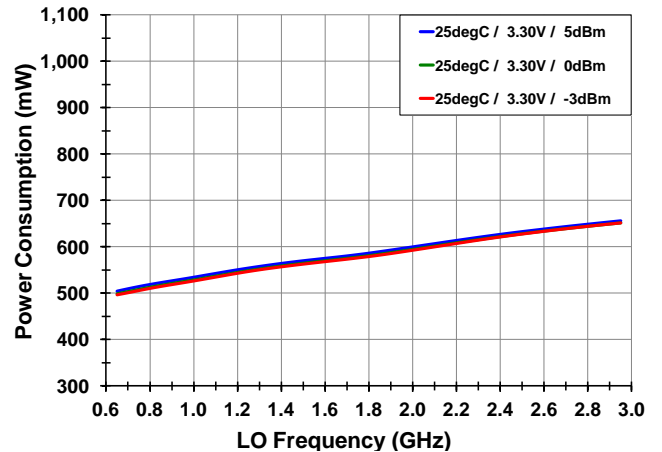

TYPICAL OPERATING CONDITIONS (-3-)

Gain vs. T_{AMB}

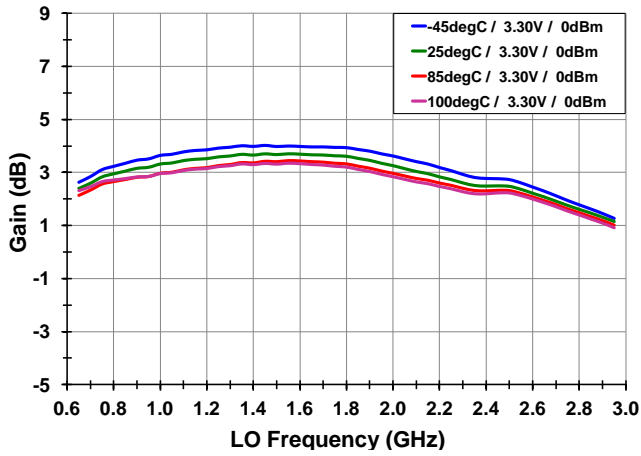

Gain vs. V_{CC}

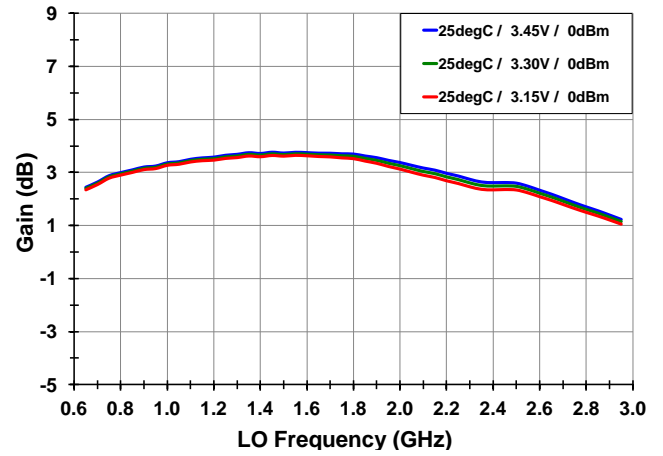

Gain vs. LO level

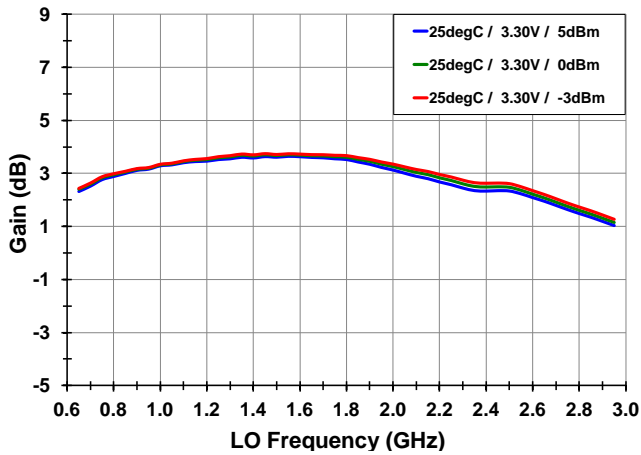

RF Output Power vs. T_{AMB}

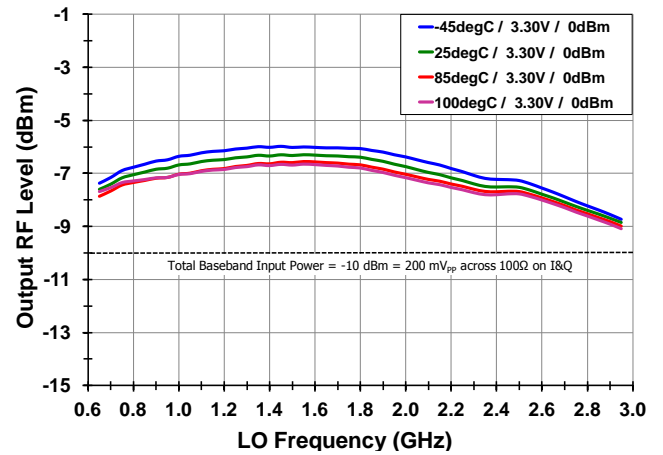

RF Output Power vs. V_{CC}

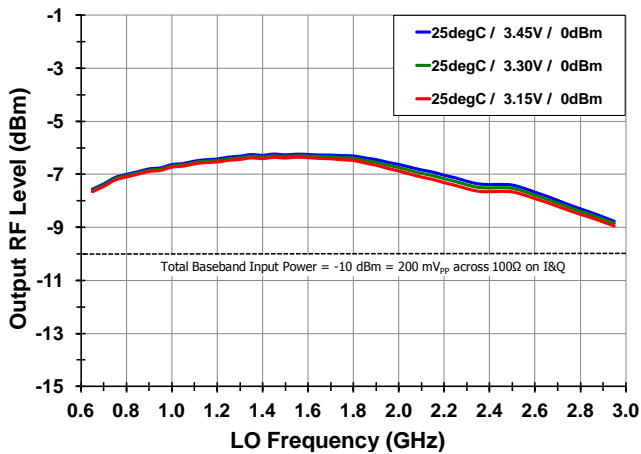

RF Output Power vs. LO level

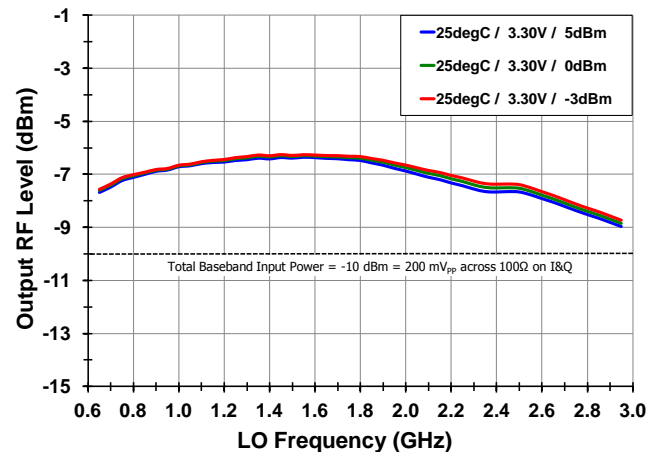

TYPICAL OPERATING CONDITIONS (-4-)

Unadjusted LO Suppression vs. T_{AMB}

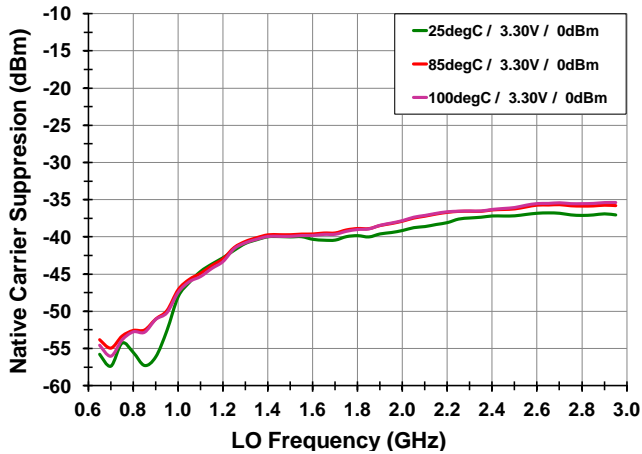

Unadjusted LO Suppression vs. V_{CC}

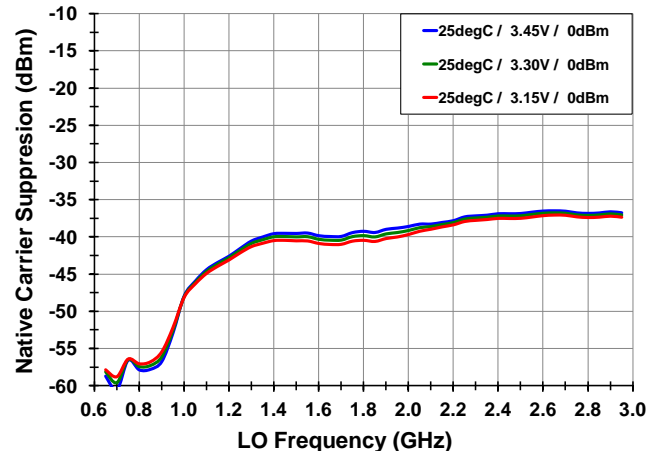

Unadjusted LO Suppression vs. LO level

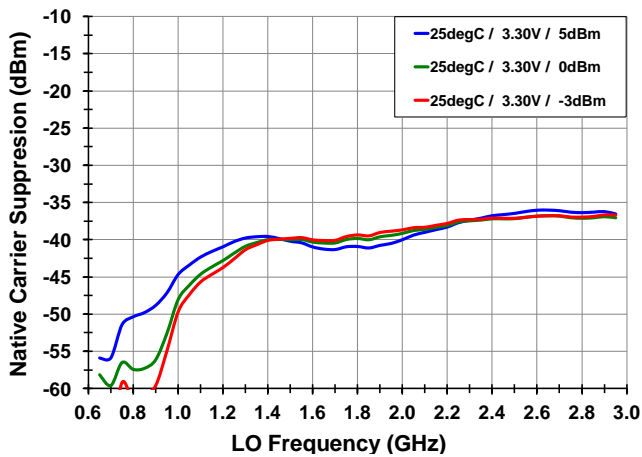

Unadjusted Sideband Suppression vs. T_{AMB}

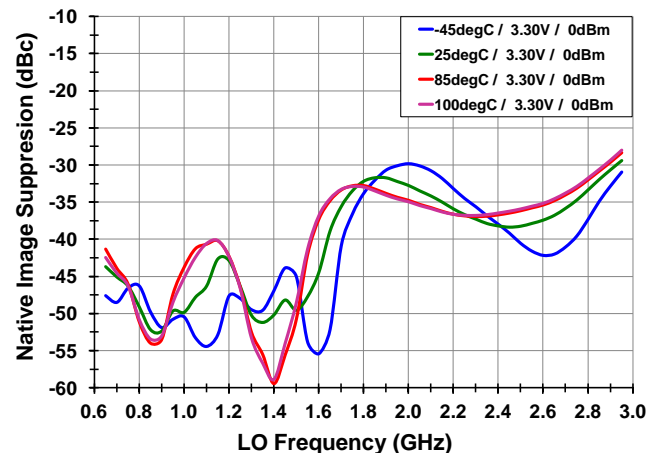

Unadjusted Sideband Suppression vs. V_{CC}

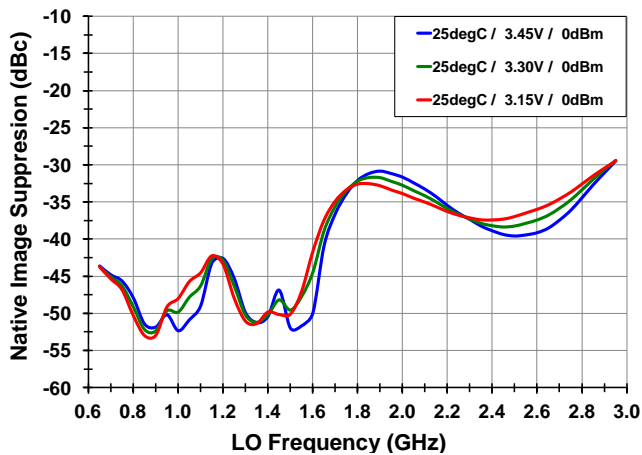

Unadjusted Sideband Suppression vs. LO level

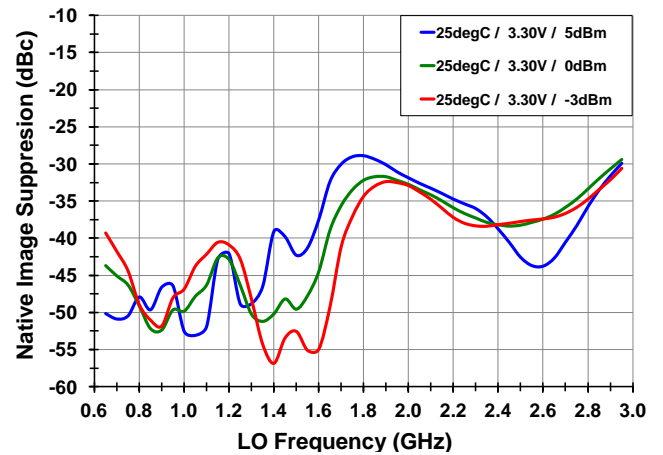

TYPICAL OPERATING CONDITIONS (-5-)

Baseband 2nd Harmonic vs. T_{AMB}

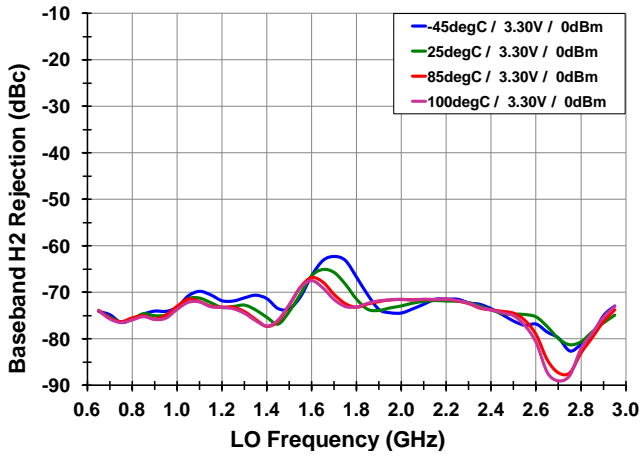

Baseband 2nd Harmonic vs. V_{CC}

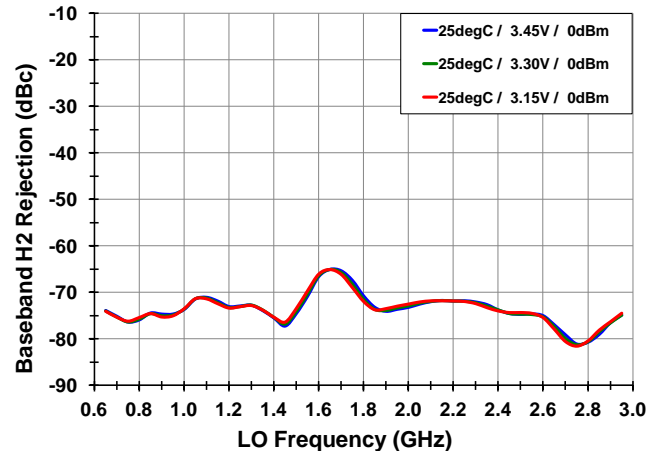

Baseband 2nd Harmonic vs. LO level

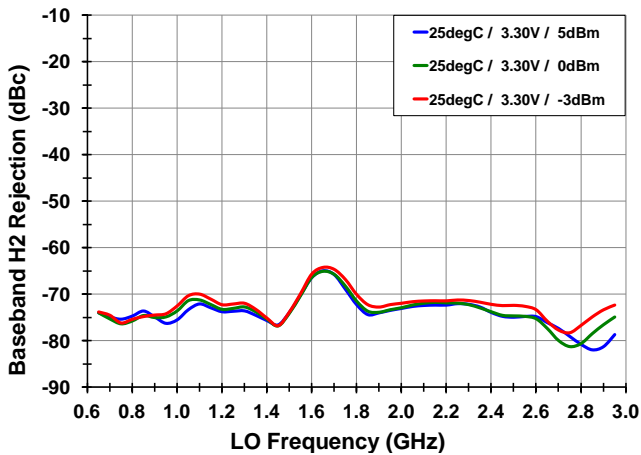

Baseband 3rd Harmonic vs. T_{AMB}

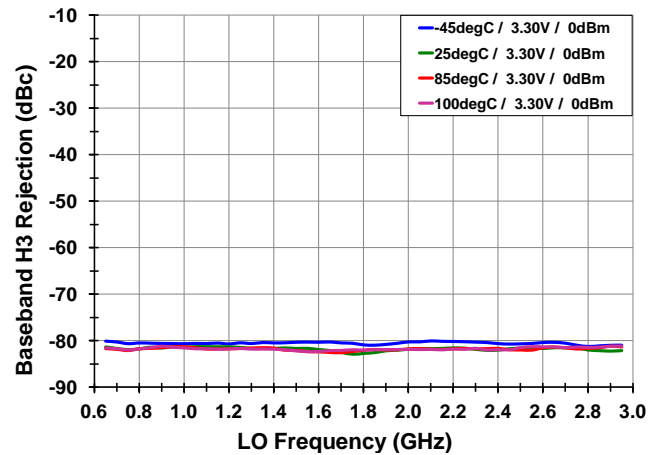

Baseband 3rd Harmonic vs. V_{CC}

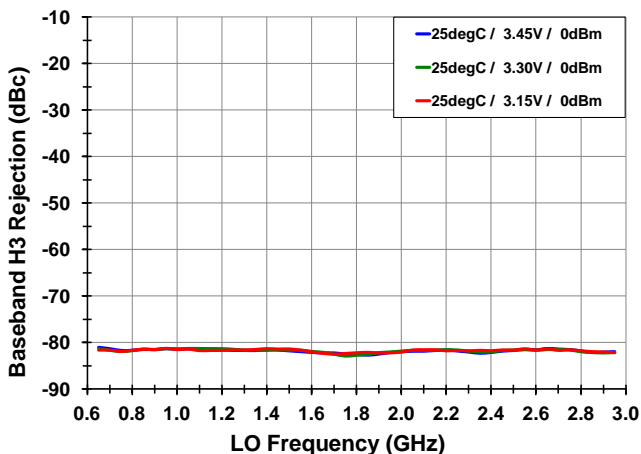

Baseband 3rd Harmonic vs. LO level

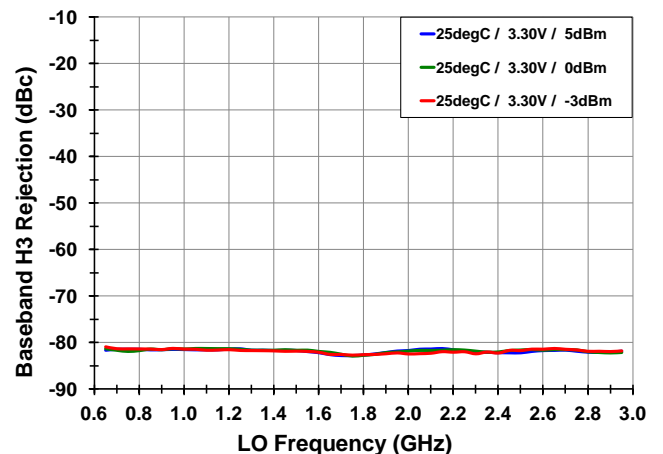

TYPICAL OPERATING CONDITIONS (-6-)

Output Noise vs. Frequency

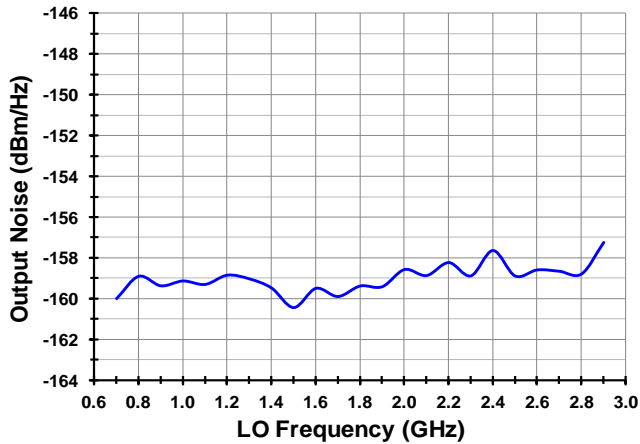

Output Noise vs. P_{OUT} [V_{CC} = 3.3V, T_{AMB} = 25C]

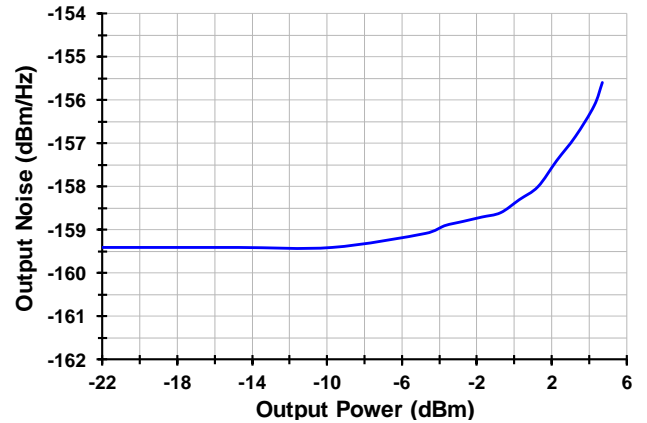

Input Bandwidth (fixed LO = 2.092 GHz)

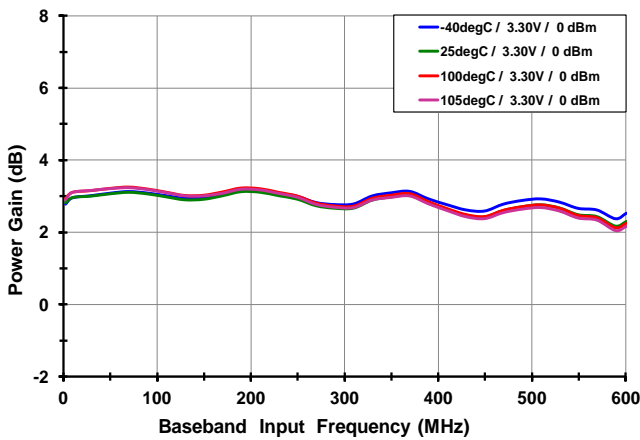

LO & RF Port Return Loss

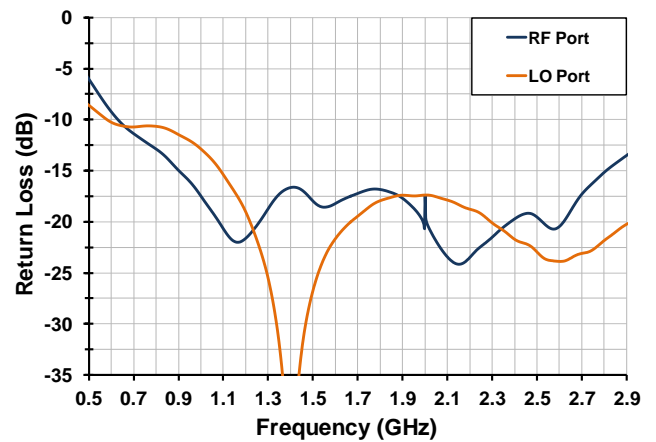

I&Q Input Parallel Resistance/Capacitance

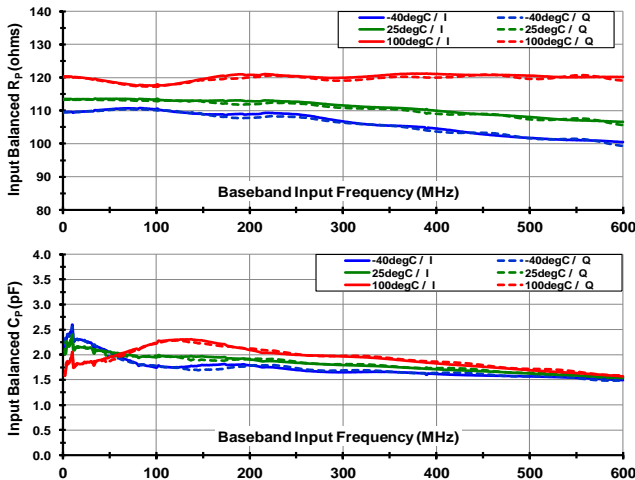

1dB Compression

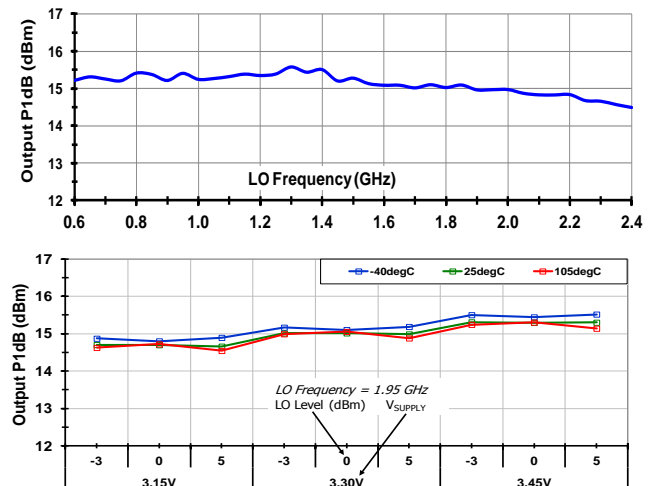

TYPICAL OPERATING CONDITIONS (-7-)

Turn On Time

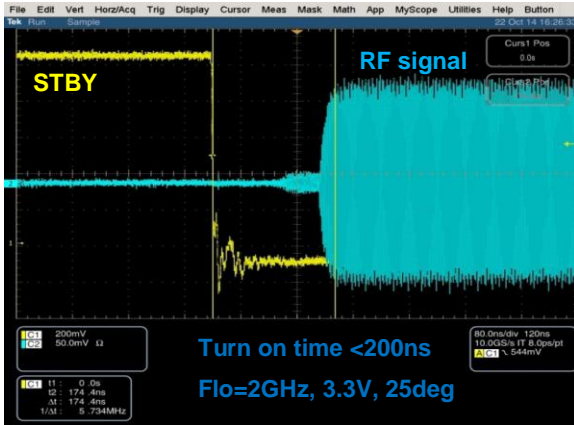

Turn Off Time

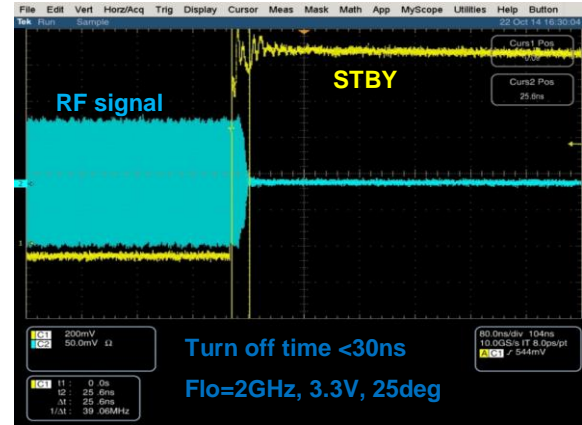

Polarity: LO = 2.0GHz, BB_I+/- leads BB_Q+/-

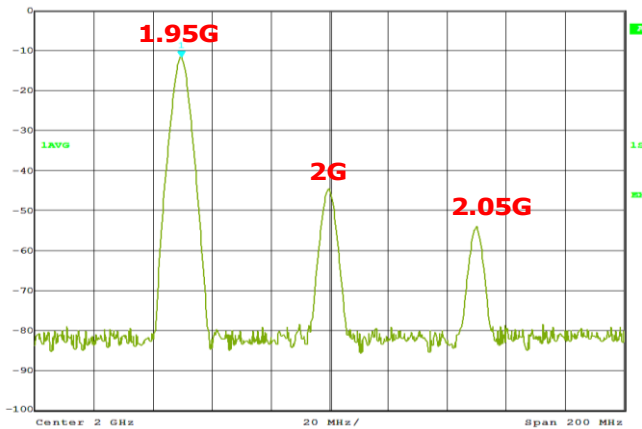

Polarity: LO = 2.0GHz, BB_I+/- lags BB_Q+/-

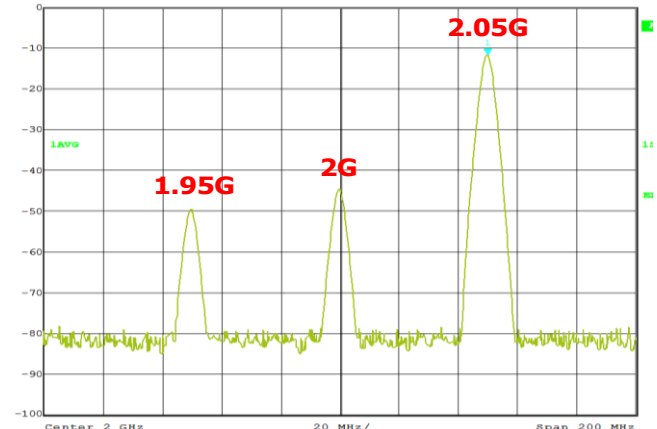

Carrier Suppression Nulling Performance

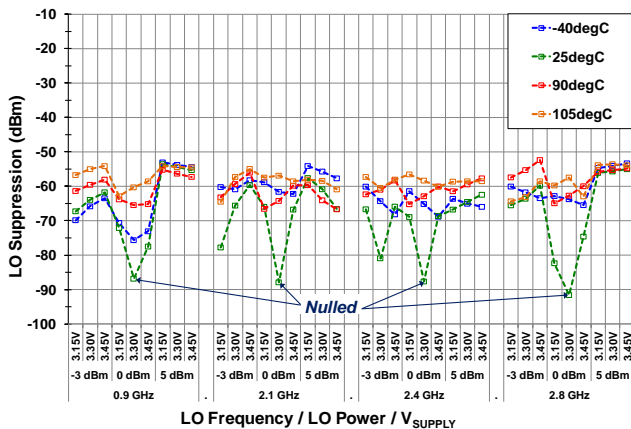
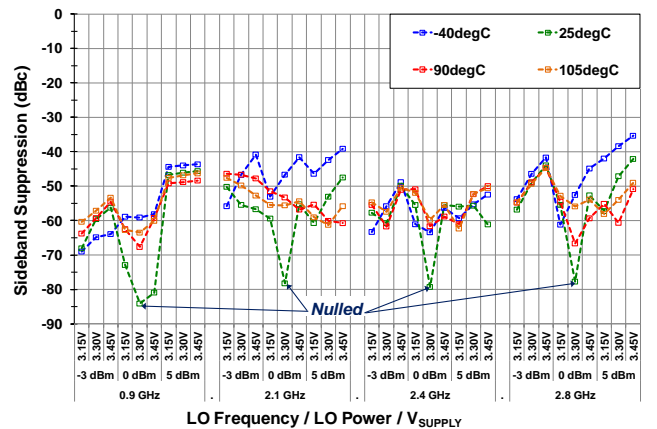
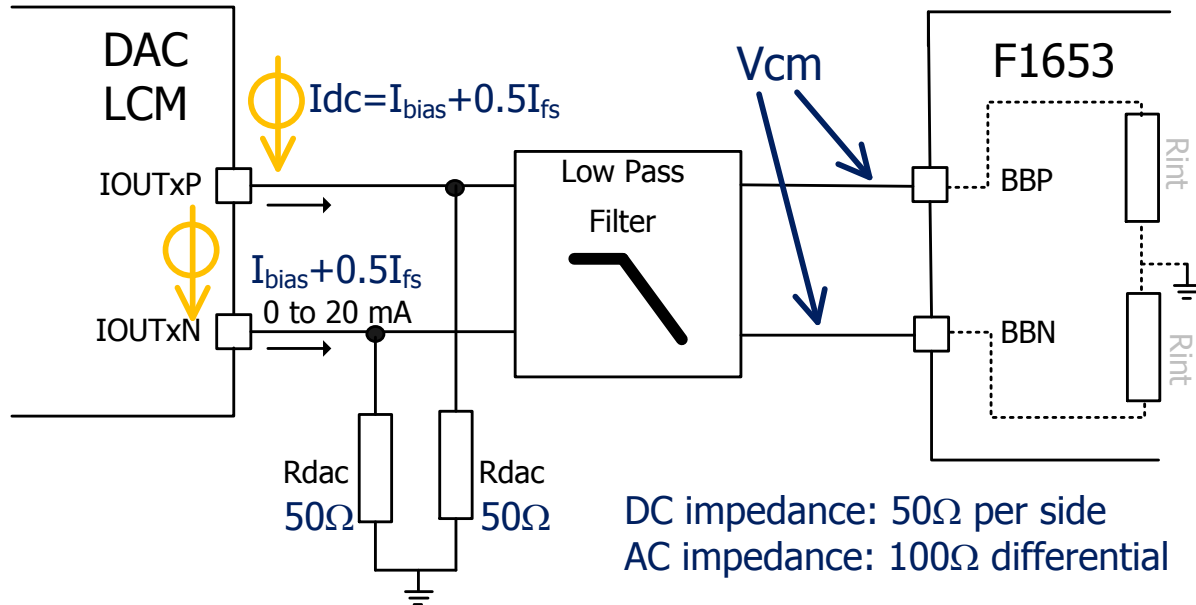

Image Suppression Nulling Performance



GENERIC DAC INTERFACE



- LCM DAC: low common mode voltage DAC usually has high output impedance and sourcing current out
- LPF: to filter out unwanted harmonics
- DC common mode voltage on BBP/BBN V_{cm} : $V_{cm} = I_{DC} \times R_{dac} // R_{dc_IQMOD}$
- V_{cm} is determined by DAC bias current and IQ Mod input DC impedance

PACKAGE DRAWING (4x4 24 PIN)

TOP VIEW

SIDE VIEW

BOTTOM VIEW

DETAIL "A"

DETAIL "B"

NOTES :

1. DIMENSIONS AND TOLERANCING CONFORM TO ASME Y14.5M - 1994.
2. ALL DIMENSIONS ARE IN MILLIMETERS, ϕ IS IN DEGREES.
3. H IS THE TOTAL NUMBER OF TERMINALS.
4. DIMENSION h APPLIES TO METALLIZED TERMINAL AND IS MEASURED BETWEEN 0.15 AND 0.20mm FROM TERMINAL TIP. IF THE TERMINAL HAS THE OPTIONAL RADIUS ON THE OTHER END OF THE TERMINAL, THE DIMENSION h SHOULD NOT BE MEASURED IN THAT RADIUS AREA. DIMENSION h SHOULD BE MEASURED IN THAT RADIUS AREA OF EACH D AND E SIDE RESPECTIVELY.
5. MAX. PROTRUSION HEIGHT IS 0.05 mm.
6. MAXIMUM ALLOWABLE BURR IS 0.025 mm IN ALL DIRECTIONS.
7. FIN #1 D ON TOP WILL BE LASER MARKED.
8. BILATERAL COMPLIABILITY ZONE APPLIES TO THE EXPOSED HEAT SINK SLUG AS WELL AS THE TERMINALS.
9. THIS DRAWING CONFORMS TO JEDEC REGISTERED OUTLINE MO-220
10. DEPENDING ON THE METHOD OF LEAD TERMINATION AT THE EDGE OF THE PACKAGE, PULLBACK (L1) MAYBE PRESENT
11. PULLBACK DESIGN OPTION IS FOR DASQMM NOMINAL LEADLENGTH ONLY.

DIMENSIONS		MIN.	NOM.	MAX.
A		0.80	0.90	1.0
A1		0.00	0.02	0.05
A2		0	0.20 REF.	12
K		0.20	MINL.	
D		4.0	BSC	
E		4.0	BSC	
L1		0.15	MM MAX	

SYMBOL	MIN.	NOM.	MAX.
ϕ		0.50	BSC.
N		24	
ND		6	
NE		6	
L	0.30	0.40	0.50
b	0.18	0.25	0.30
D2	2.30	2.45	2.60
E2	2.30	2.45	2.60

REV	DESCRIPTION	DATE	APPROVED
01	INITIAL RELEASE	10/23/98	RAC
02	ADD LEAD PULLBACK	11/18/00	JR

IBDT INTERNATIONAL BUSINESS DATA CORPORATION 3000 Central Expressway Santa Clara, CA 95051-1699 TEL: (408) 737-0600 FAX: (408) 737-0601	TITLE: PLURIS24 PACKAGE OUTLINE SIZE: 4.0 x 4.0 mm BODY 0.5 mm PITCH QFN	DATE: 10/23/98 DRAWN BY: PSC-4192 CHECKED BY:
------------------------------------------------------------------------------------------------------------------------------------------------------------	---------------------------------------------------------------------------------------	-------------------------------------------------------------------

PIN DIAGRAM

TOP View (looking through the top of the package)

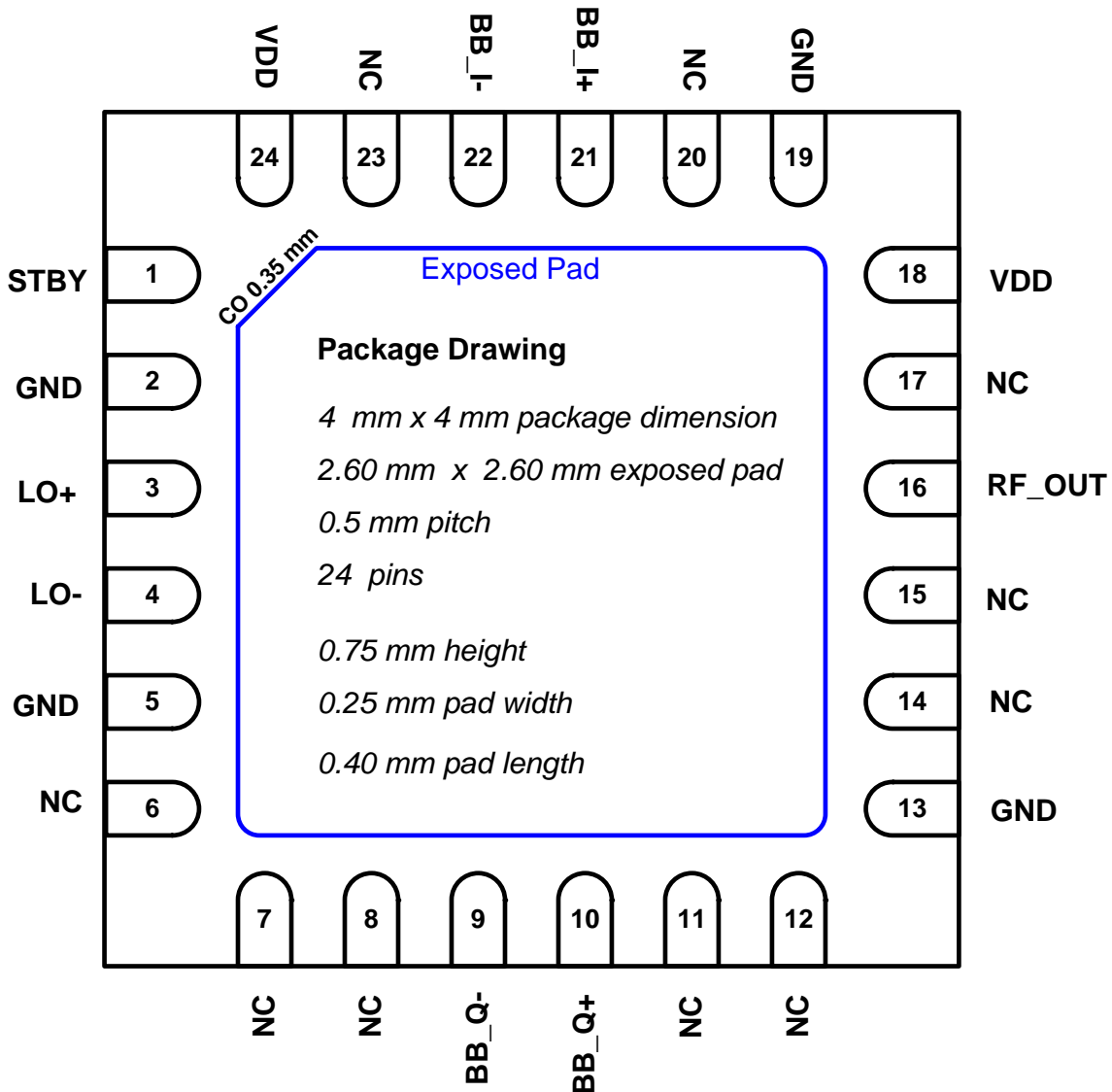

PIN DESCRIPTIONS

Pins	Name	Function
1	STBY	STBY Mode. Pull this pin high for Standby Mode. Pull low or ground for Normal Operation.
2, 5, 13, 19	GND	Ground these pins.
6, 7, 8, 11, 12, 14, 15, 17, 20, 23	NC	IDT recommends grounding these pins.
3, 4	LO+, LO-	Local oscillator (LO) 50 ohm differential or 25ohm each pin single-ended input. Pins must be ac-coupled. For 50 ohm single-ended operation, ac-couple USED Pin to 50 ohm termination and ac-couple UNUSED pin to GND.
9, 10	BB_Q-, BB_Q+	<i>Quadrature</i> differential baseband input. Internally matched to 100 ohms.
16	RF_OUT	RF output. Must be ac-coupled.
18, 24	VDD	Power Supply. Bypass to GND with capacitors as shown in the Typical Application Circuit as close to pin as possible.
21, 22	BB_I+, BB_I-	<i>In-Phase</i> differential baseband input. Internally matched to 100 ohms.
	— EP	Exposed Pad. Internally connected to GND. Solder this exposed pad to a PCB pad that uses multiple ground vias to provide heat transfer out of the device into the PCB ground planes. These multiple via grounds are also required to achieve the specified RF performance.

EVKIT SCHEMATIC

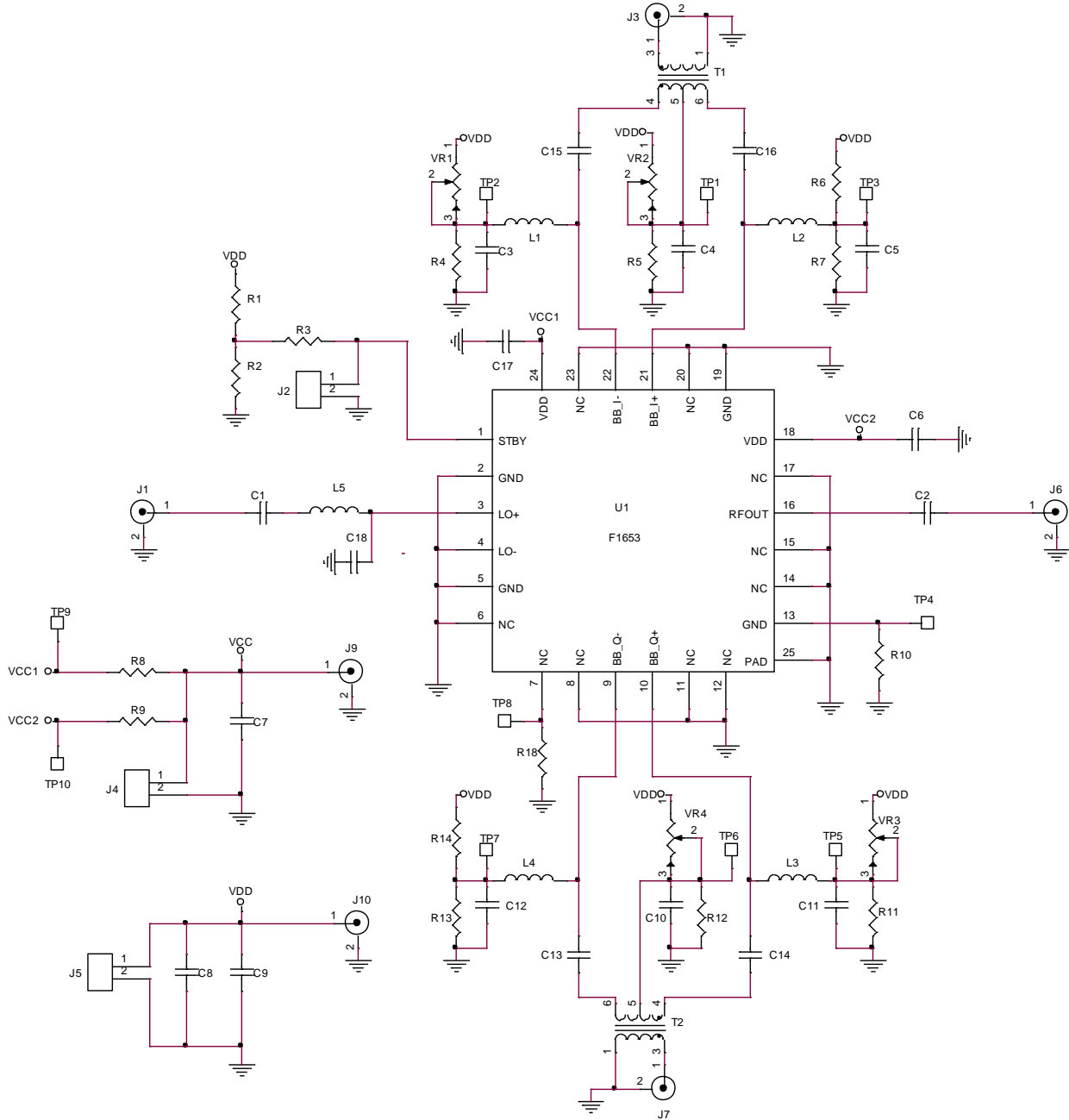

POWER SUPPLIES

All supply pins should be bypassed with external capacitors to minimize noise and fast transients. Supply noise can degrade noise figure and fast transients can trigger ESD clamps and cause them to fail. Supply voltage change or transients should have a slew rate smaller than $1V/20\mu s$. In addition, all control pins should remain at 0V (+/-0.3V) while the supply voltage ramps or while it returns to zero.

EVKIT BOM

Part Reference	QTY	DESCRIPTION	Mfr. Part #	Mfr.
C2	1	8pF $\pm 0.5\text{pF}$, 50V, C0G Ceramic Capacitor (0402)	GRM1555C1H8R0D	MURATA
C4,C6,C8,C10,C17	5	10nF $\pm 10\%$, 16V, X7R Ceramic Capacitor (0402)	GRM155R71C103K	MURATA
C1	1	39PF $\pm 5\%$, 50V, C0G Ceramic Capacitor (0402)	GRM1555C1H390J	MURATA
C7,C9	2	100nF $\pm 10\%$, 16V, X7R Ceramic Capacitor (0402)	GRM155R71C104K	MURATA
R3,R8,R9,C13-C16,L5	8	0 Ω 1/10W Resistor (0402)	ERJ-2GE0R00X	Panasonic
R5,R12	2	24.9 Ω $\pm 1\%$, 1/4W Resistor (1206)	RMCF1206FT24R9	Stackpole Electronics
R1	1	47.0K Ω $\pm 1\%$, 1/16W Resistor (0402)	RC0402FR-0747KL	Yageo
VR2,VR4	2	1K Ω $\pm 10\%$, 1/4W Resistor Trimmer	TS63Y102KR10	Vishay/Sfernice
J2,J5,J8,J9	4	CONN HEADER VERT SGL 2 X 1 POS GOLD	961102-6404-AR	3M
J3,J4,J7,J10	4	Edge Launch SMA (0.250 inch width, round center contact)	142-0711-821	Emerson Johnson
J1,J6	2	Edge Launch SMA (0.375 inch width, flat center contact)	142-0701-851	Emerson Johnson
T1,T2	2	2:1 Center Tap Balun	ADT2-1T+	Mini Circuits
U1	1	IQ MOD	F1653	IDT
	1	Printed Circuit Board	F1650 SE EVKIT REV (02)	Coastal Circuits
VR1,VR3		DNP		
C3,C5,C11,C12,C18		DNP		
L1,L2,L3,L4		DNP		
R2,R4,R6,R7,R10,R11		DNP		
R13,R14,R16,R18		DNP		

APPLYING V_{CM} AT THE BASEBAND INPUTS

With L1, L2, L3, and L4 unpopulated, the common mode voltage is set by VR2 and VR4. The voltage set by VR2 has a DC path through the balun transformer T1 to pins BB_I+ and BB_I-, as highlighted. This also applies for VR4, T2, and pins BB_Q+ and BB_Q-. With this configuration, the same voltage will be applied to BB_I+ and BB_I- and the same voltage will be applied to BB_Q+ and BB_Q-. The I and Q common mode voltages may be different from each other to null LO (carrier) leakage.

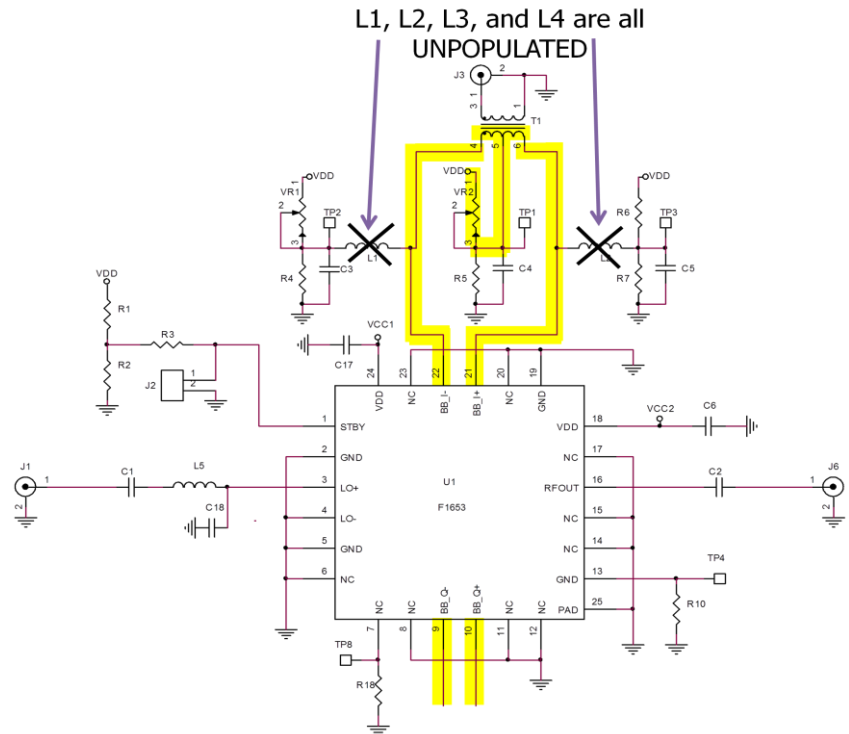

EVKIT PICTURE:

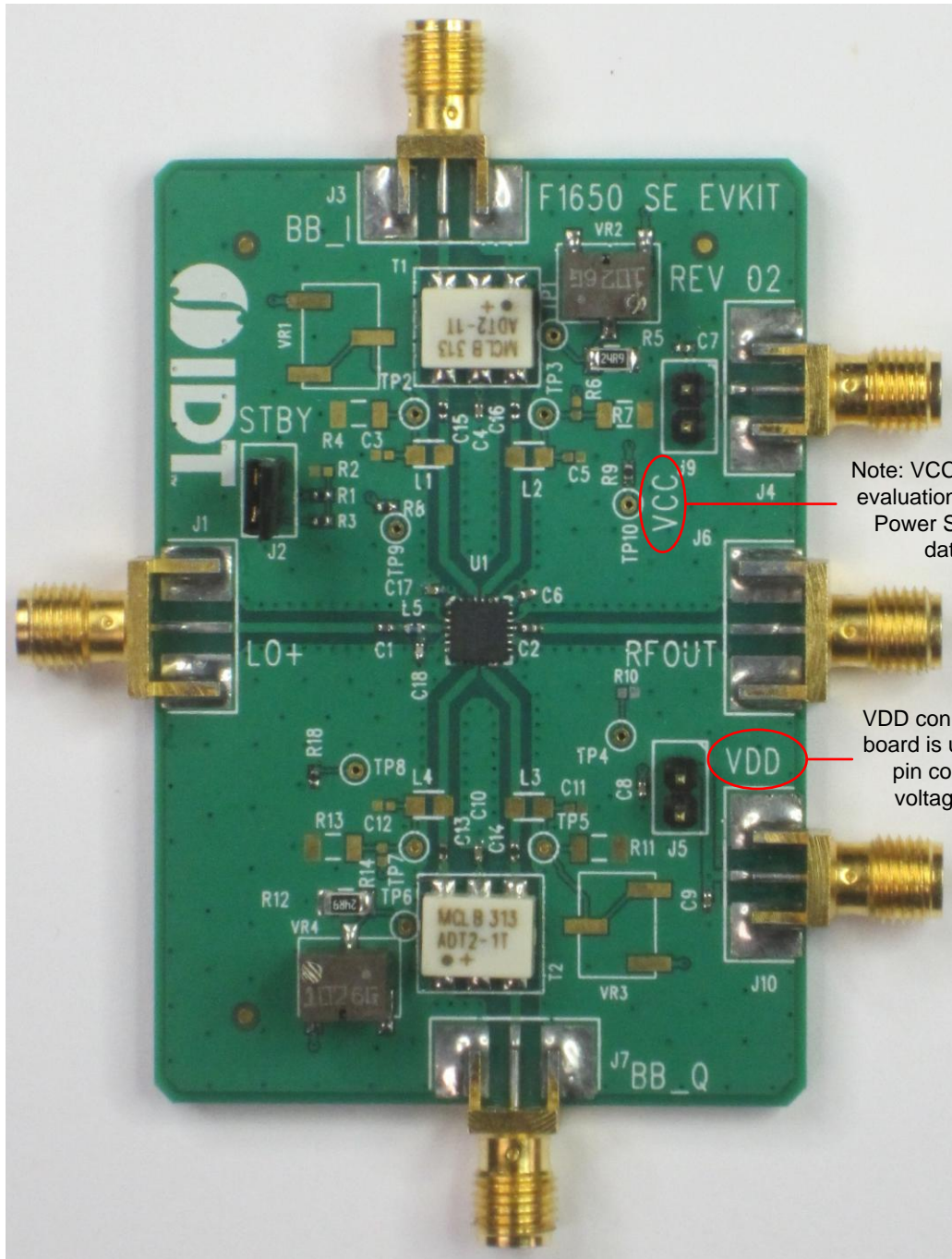

Note: VCC connection on evaluation board is VDD Power Supply on the datasheet.

VDD connection on evaluation board is used to set baseband pin common mode (CM) voltage (see schematic)

TOP MARKINGS

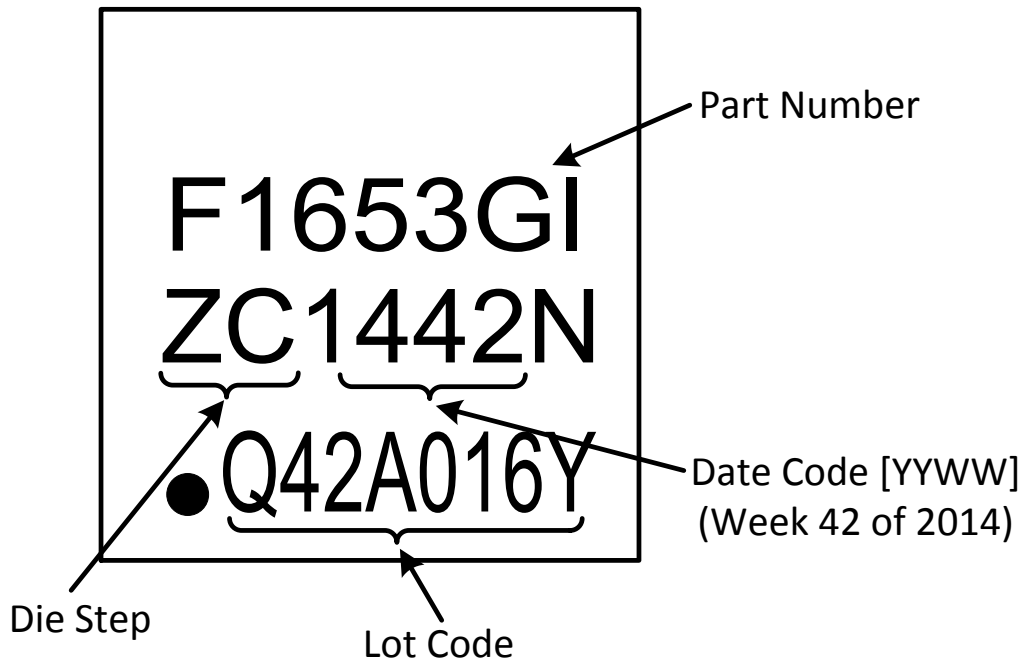

IMPORTANT NOTICE AND DISCLAIMER

RENESAS ELECTRONICS CORPORATION AND ITS SUBSIDIARIES (“RENESAS”) PROVIDES TECHNICAL SPECIFICATIONS AND RELIABILITY DATA (INCLUDING DATASHEETS), DESIGN RESOURCES (INCLUDING REFERENCE DESIGNS), APPLICATION OR OTHER DESIGN ADVICE, WEB TOOLS, SAFETY INFORMATION, AND OTHER RESOURCES “AS IS” AND WITH ALL FAULTS, AND DISCLAIMS ALL WARRANTIES, EXPRESS OR IMPLIED, INCLUDING, WITHOUT LIMITATION, ANY IMPLIED WARRANTIES OF MERCHANTABILITY, FITNESS FOR A PARTICULAR PURPOSE, OR NON-INFRINGEMENT OF THIRD-PARTY INTELLECTUAL PROPERTY RIGHTS.

These resources are intended for developers who are designing with Renesas products. You are solely responsible for (1) selecting the appropriate products for your application, (2) designing, validating, and testing your application, and (3) ensuring your application meets applicable standards, and any other safety, security, or other requirements. These resources are subject to change without notice. Renesas grants you permission to use these resources only to develop an application that uses Renesas products. Other reproduction or use of these resources is strictly prohibited. No license is granted to any other Renesas intellectual property or to any third-party intellectual property. Renesas disclaims responsibility for, and you will fully indemnify Renesas and its representatives against, any claims, damages, costs, losses, or liabilities arising from your use of these resources. Renesas' products are provided only subject to Renesas' Terms and Conditions of Sale or other applicable terms agreed to in writing. No use of any Renesas resources expands or otherwise alters any applicable warranties or warranty disclaimers for these products.

(Disclaimer Rev.1.01 Jan 2024)

Corporate Headquarters

TOYOSU FORESIA, 3-2-24 Toyosu,
Koto-ku, Tokyo 135-0061, Japan
www.renesas.com

Trademarks

Renesas and the Renesas logo are trademarks of Renesas Electronics Corporation. All trademarks and registered trademarks are the property of their respective owners.

Contact Information

For further information on a product, technology, the most up-to-date version of a document, or your nearest sales office, please visit www.renesas.com/contact-us/.