

HA1630S04/05/06 Series

Ultra-Small Low Voltage Operation CMOS Single Operational Amplifier

R03DS0082EJ0200

Rev.2.00

Jan 10, 2014

Description

The HA1630S04/05/06 are high slew rate single CMOS Operational Amplifiers realizing low voltage operation, low input offset voltage and low supply current. In addition to a low operating voltage from 1.8V, these device output can achieve full swing output voltage capability extending to either supply. Available in an ultra-small CMPAK-5 package that occupies only 1/8 the area of the SOP-8 package.

Features

- Low power and single supply operation $V_{DD} = 1.8$ to 5.5 V
- Low input offset voltage $V_{IO} = 4.0$ mV Max
- Low supply current $I_{DD} = 200$ μ A Typ (HA1630S04)
 $I_{DD} = 400$ μ A Typ (HA1630S05)
 $I_{DD} = 800$ μ A Typ (HA1630S06)
- High slew rate $SR = 2$ V/ μ s Typ (HA1630S04)
 $SR = 4$ V/ μ s Typ (HA1630S05)
 $SR = 8$ V/ μ s Typ (HA1630S06)
- Maximum output voltage $V_{OH} = 2.9$ V Min (at $V_{DD} = 3.0$ V)
- Low input bias current $I_{IB} = 1$ pA Typ

Ordering Information

Type No.	Package Name	Package Code
HA1630S04CM	CMPAK-5	PTSP0005ZC-A
HA1630S04LP	MPAK-5	PLSP0005ZB-A
HA1630S05CM	CMPAK-5	PTSP0005ZC-A
HA1630S05LP	MPAK-5	PLSP0005ZB-A
HA1630S06CM	CMPAK-5	PTSP0005ZC-A
HA1630S06LP	MPAK-5	PLSP0005ZB-A

Pin Arrangement

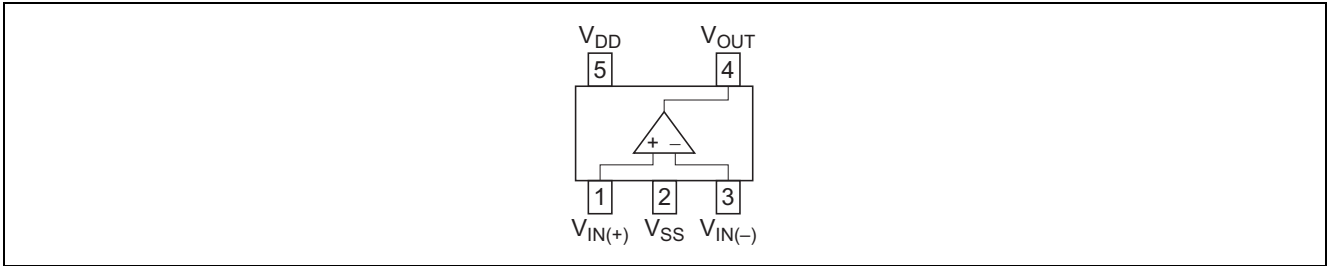

Equivalent Circuit

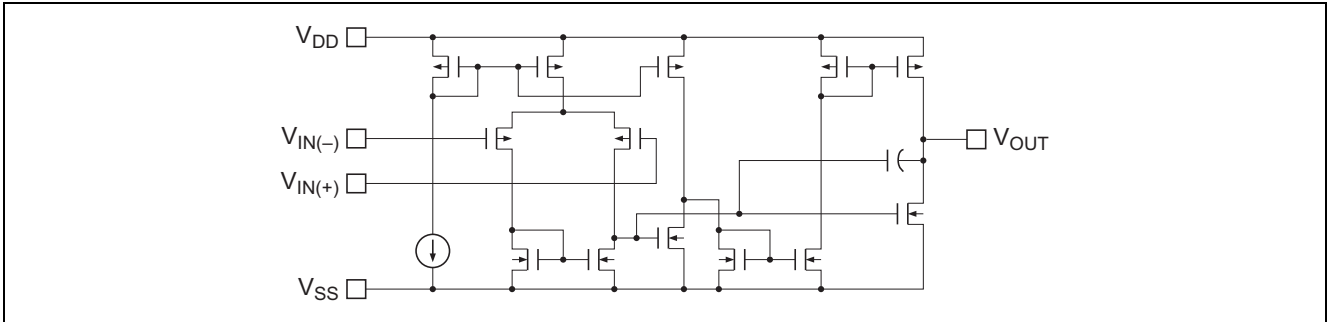

Absolute Maximum Ratings

(Ta = 25°C)

Items	Symbol	Ratings	Unit	Note
Supply voltage	V _{DD}	7	V	
Differential input voltage	V _{IN(diff)}	-V _{DD} to +V _{DD}	V	
Input voltage	V _{IN}	-0.3 to +V _{DD}	V	1
Power dissipation	P _T	200	mW	
Operating temp. Range	Topr	-40 to +85	°C	
Storage temp. Range	Tstg	-55 to +125	°C	

Note: 1. Do not apply Input Voltage exceeding V_{DD} or 7 V.

Electrical Characteristics

(V_{DD} = 3.0 V, Ta = 25°C)

Items	Symbol	Min	Typ	Max	Unit	Test Condition
Input offset voltage	V _{IO}	—	—	4.0	mV	V _{in} = 1.5 V
Input offset current	I _{IO}	—	(1.0)	—	pA	V _{in} = 1.5 V
Input bias current	I _{IB}	—	(1.0)	—	pA	V _{in} = 1.5 V
Output high voltage	V _{OH}	2.9	—	—	V	R _L = 100 kΩ
Output source current	I _{O SOURCE}	100	200	—	μA	V _{OH} = 2.5 V (HA1630S04)
		200	400	—		V _{OH} = 2.5 V (HA1630S05)
		400	800	—		V _{OH} = 2.5 V (HA1630S06)
Output low voltage	V _{OL}	—	—	0.1	V	R _L = 100 kΩ
Output sink current	I _{O SINK}	—	(5.0)	—	mA	V _{OL} = 0.5 V (HA1630S04)
		—	(6.0)	—		V _{OL} = 0.5 V (HA1630S05)
		—	(6.5)	—		V _{OL} = 0.5 V (HA1630S06)
Common mode input voltage range	V _{CM}	-0.05 to 2.1	—	—	V	(HA1630S04, HA1630S05)
		0 to 1.9	—	—		(HA1630S06)
Slew rate	SR	—	(2.0)	—	V/μs	C _L = 20 pF (HA1630S04)
		—	(4.0)	—		C _L = 20 pF (HA1630S05)
		—	(8.0)	—		C _L = 20 pF (HA1630S06)
Voltage gain	A _V	60	90	—	dB	
Gain bandwidth product	BW	—	(2.1)	—	MHz	C _L = 20 pF (HA1630S04)
		—	(3.3)	—		C _L = 20 pF (HA1630S05)
		—	(3.6)	—		C _L = 20 pF (HA1630S06)
Power supply rejection ratio	PSRR	50	70	—	dB	
Common mode rejection ratio	CMRR	50	70	—	dB	
Supply current	I _{DD}	—	200	400	μA	R _L = ∞ (HA1630S04)
		—	400	800		R _L = ∞ (HA1630S05)
		—	800	1700		R _L = ∞ (HA1630S06)

Notes: 1. In the case of continuous current flow, use a sink current of under 4 mA.

2. () : Design specification

Table of Graphs

Electrical Characteristics			HA1630S04 Figure	HA1630S05 Figure	HA1630S06 Figure	Test Circuit
Supply current	I_{DD}	vs Supply voltage	1-1	2-1	3-1	2
		vs Ambient temperature	1-2	2-2	3-2	
Output high voltage	V_{OH}	vs Output source current	1-3	2-3	3-3	4
		vs Supply voltage	1-4	2-4	3-4	
Output source current	$I_{O\ SOURCE}$	vs Ambient temperature	1-5	2-5	3-5	6
Output low voltage	V_{OL}	vs Output sink current	1-6	2-6	3-6	5
Output sink current	$I_{O\ SINK}$	vs Ambient temperature	1-7	2-7	3-7	6
Input offset voltage	V_{IO}	Distribution	1-8	2-8	3-8	1
		vs Supply voltage	1-9	2-9	3-9	
		vs Ambient temperature	1-10	2-10	3-10	
Common mode input voltage range	V_{CM}	vs Ambient temperature	1-11	2-11	3-11	7
Power supply rejection ratio	PSRR	vs Frequency	1-12	2-12	3-12	1
Common mode rejection ratio	CMRR	vs Frequency	1-13	2-13	3-13	7
Voltage gain & phase angle	A_V	vs Frequency	1-14	2-14	3-14	10
Input bias current	I_{IB}	vs Ambient temperature	1-15	2-15	3-15	3
		vs Input voltage	1-16	2-16	3-16	
Slew Rate (rising)	SRr	vs Ambient temperature	1-17	2-17	3-17	9
Slew Rate (falling)	SRf	vs Ambient temperature	1-18	2-18	3-18	
Slew rate		Large signal transient response	1-19	2-19	3-19	
		Small signal transient response	1-20	2-20	3-20	
Total harmonic distortion + noise	(0 dB)	vs. Output voltage p-p	1-21	2-21	3-21	8
	(40 dB)	vs. Output voltage p-p	1-22	2-22	3-22	
Maximum p-p output voltage		vs Frequency	1-23	2-23	3-23	
Voltage noise density		vs Frequency	1-24	2-24	3-24	

Main Characteristics (HA1630S04)

Figure 1-1. HA1630S04
Supply Current vs. Supply Voltage

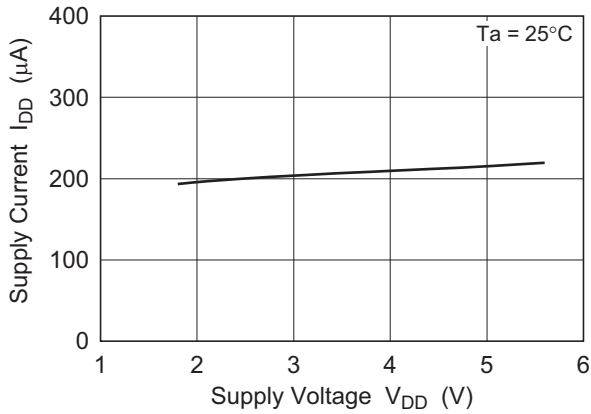

Figure 1-2. HA1630S04
Supply Current vs. Ambient Temperature

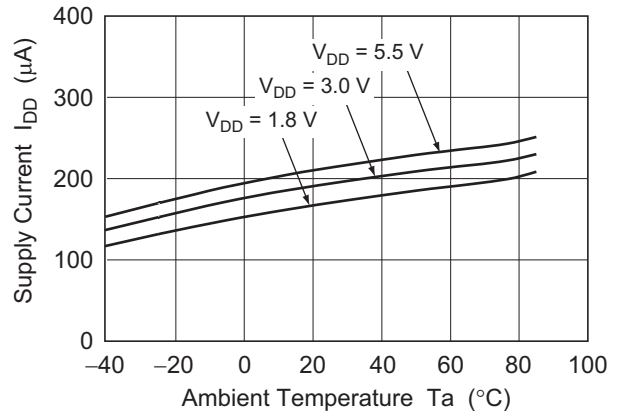

Figure 1-3. HA1630S04
Output High Voltage vs. Output Source Current

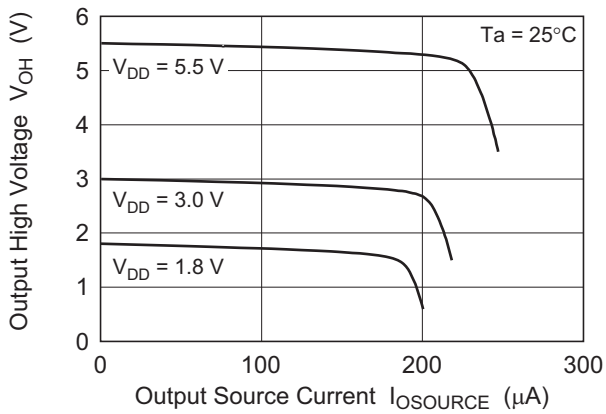

Figure 1-4. HA1630S04
Output High Voltage vs. Supply Voltage

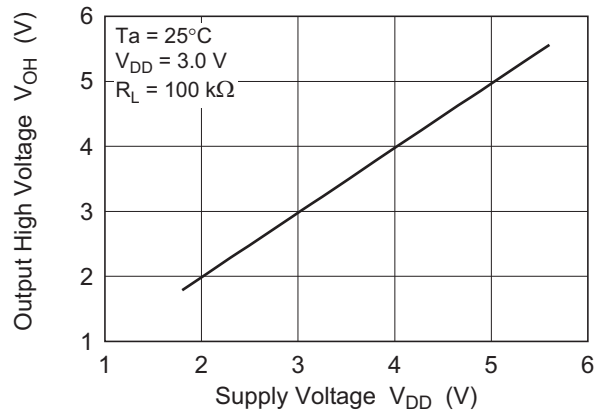
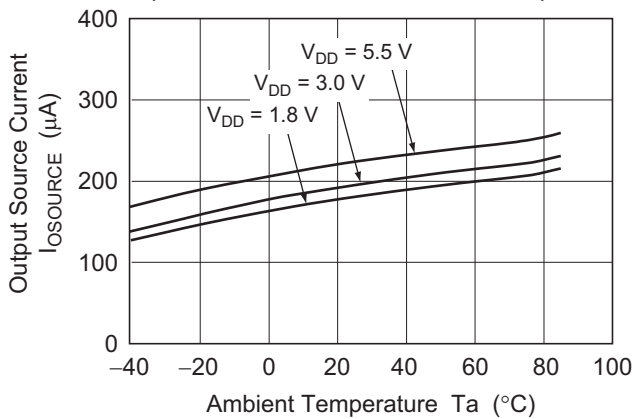

Figure 1-5. HA1630S04
Output Source Current vs. Ambient Temperature



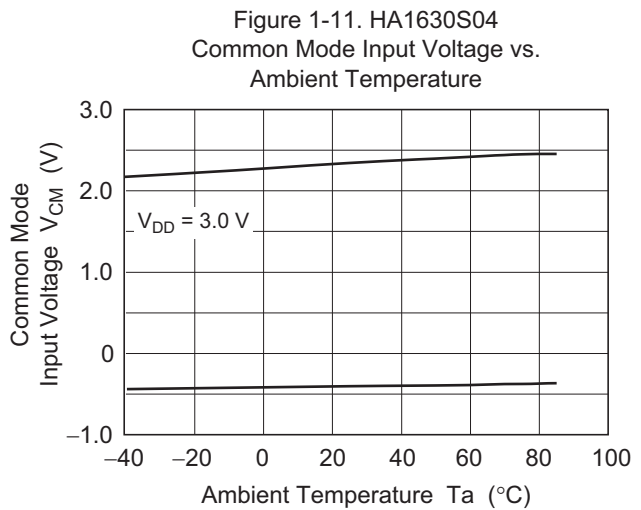
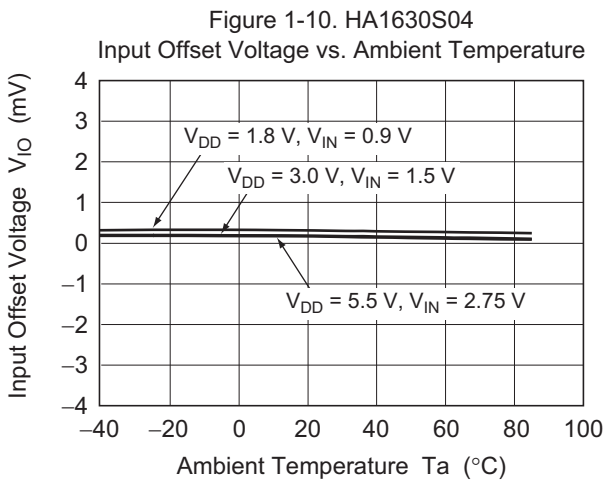
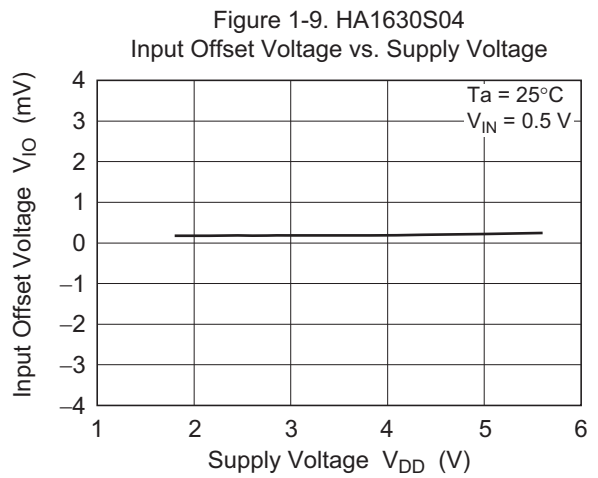
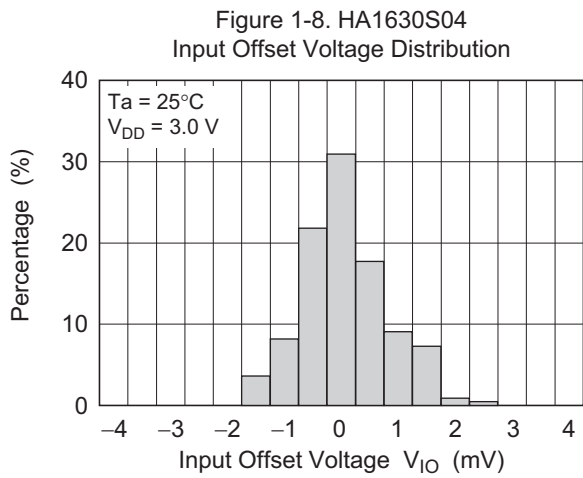
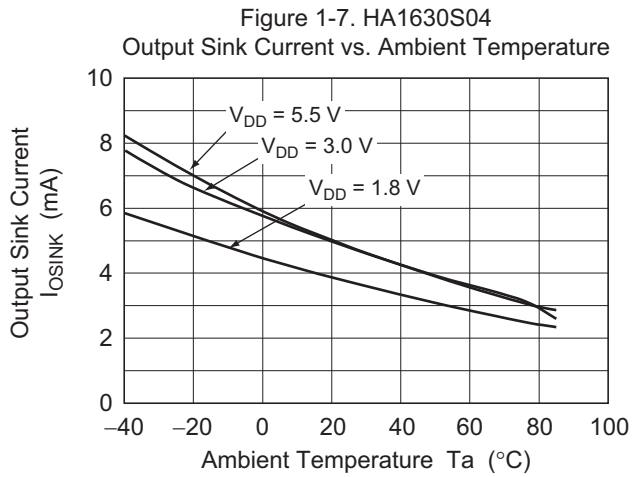
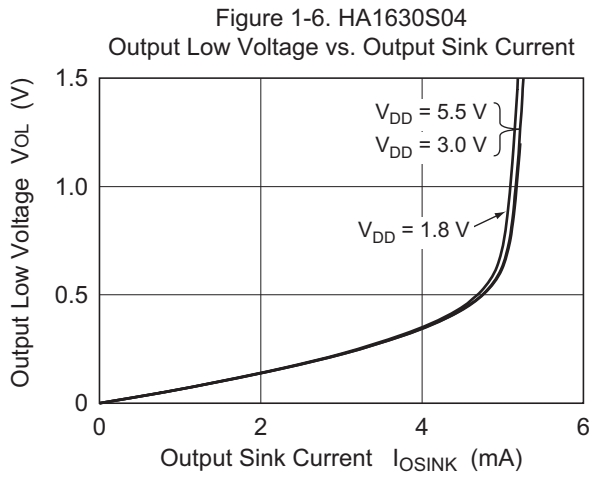

Figure 1-12. HA1630S04
Power Supply Rejection Ratio vs. Frequency

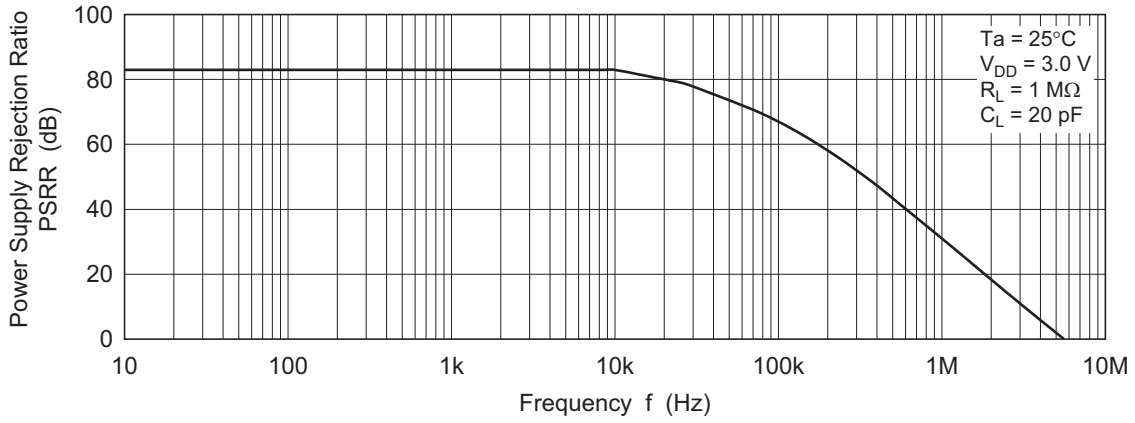

Figure 1-13. HA1630S04
Common Mode Rejection Ratio vs. Frequency

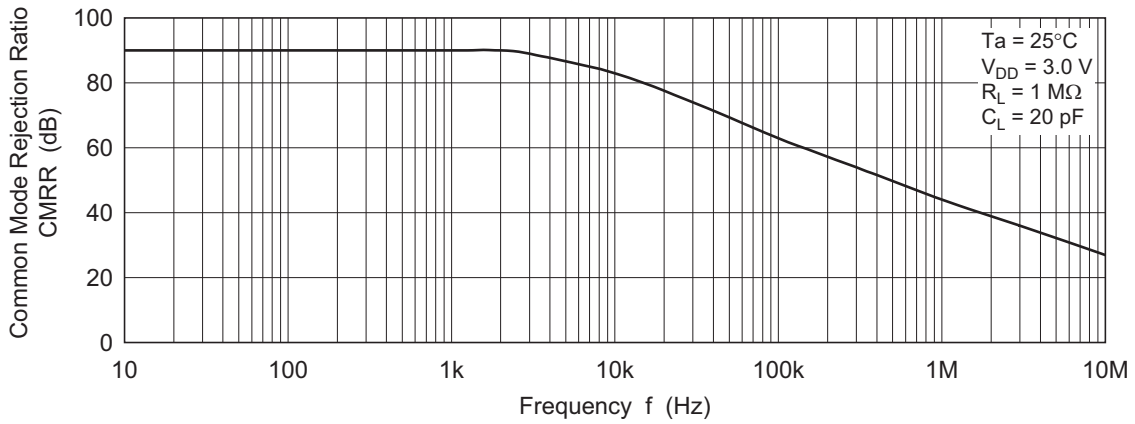
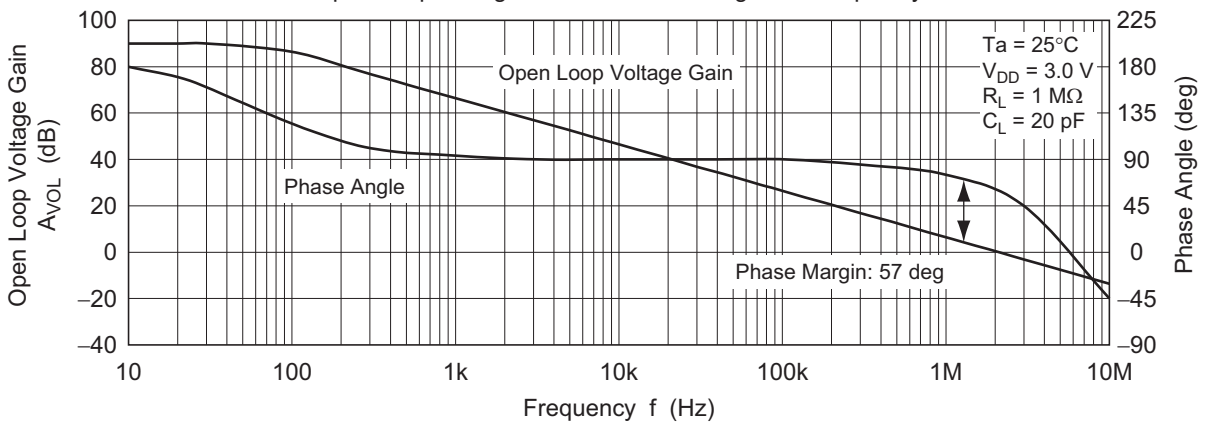

Figure 1-14. HA1630S04
Open Loop Voltage Gain and Phase Angle vs. Frequency



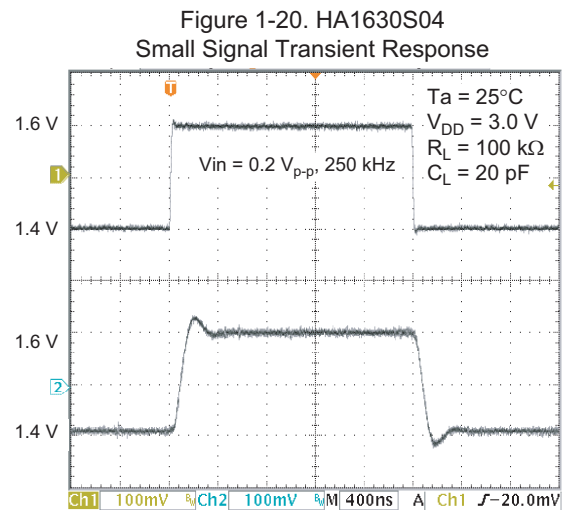
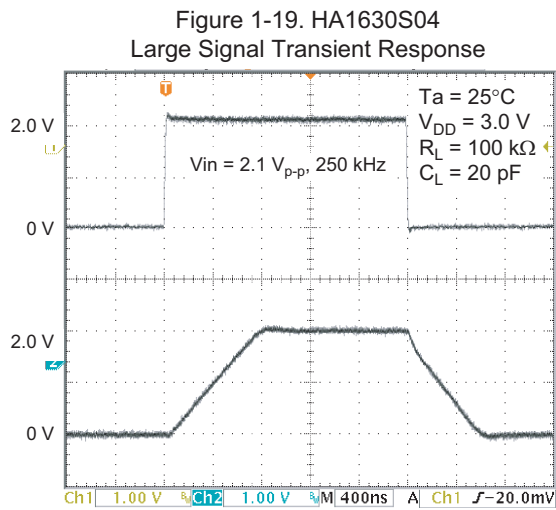
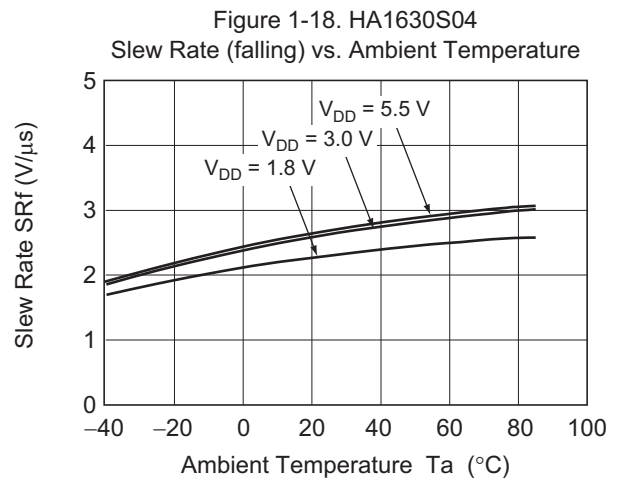
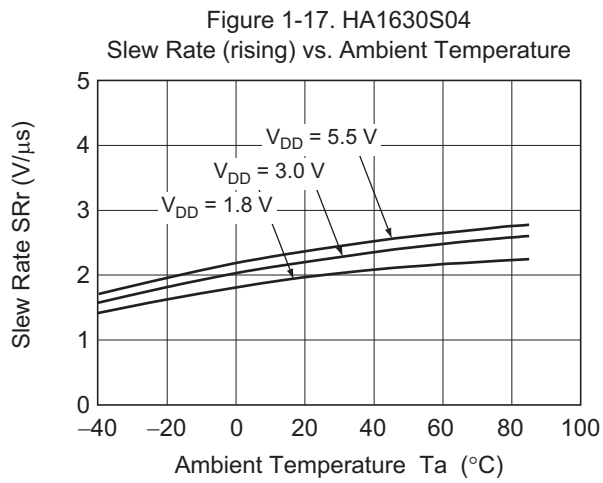
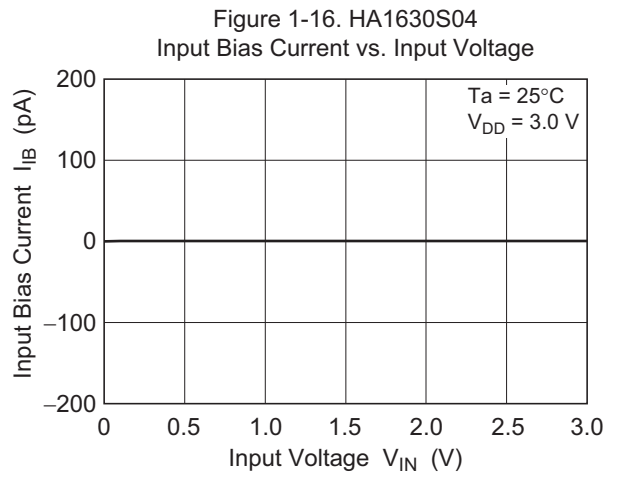
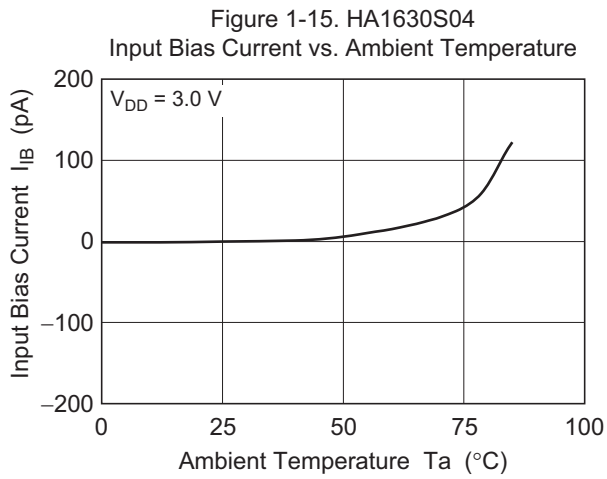

Figure 1-21. HA1630S04
Total Harmonic Distortion + Noise vs.
Output Voltage p-p

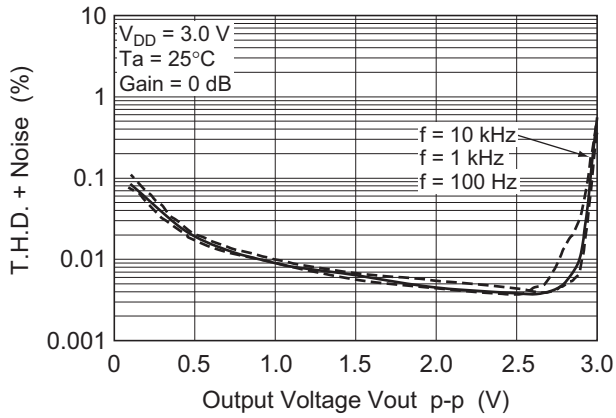

Figure 1-22. HA1630S04
Total Harmonic Distortion + Noise vs.
Output Voltage p-p

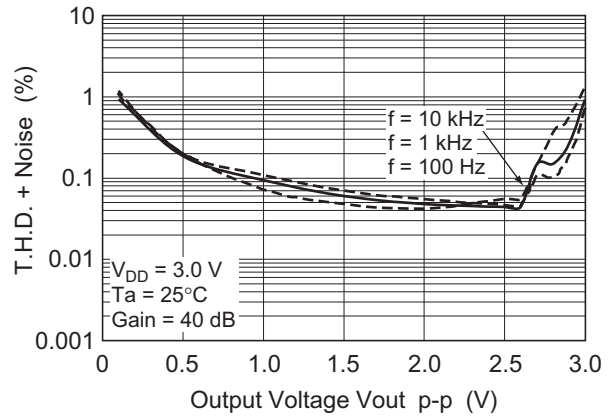

Figure 1-23. HA1630S04
Voltage Output p-p vs. Frequency

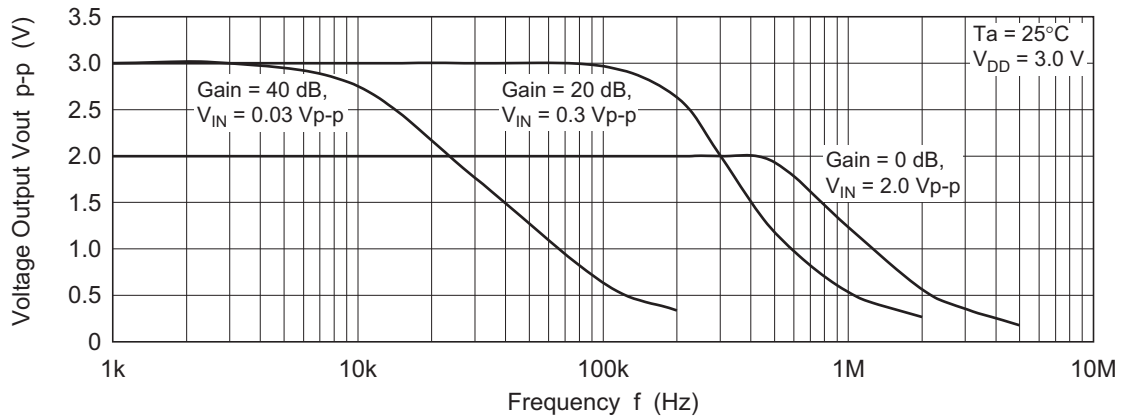
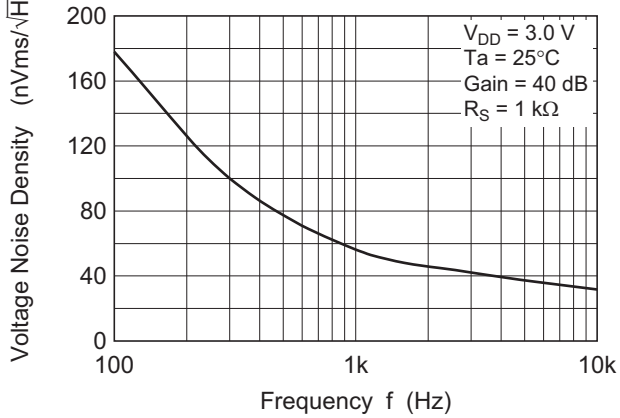
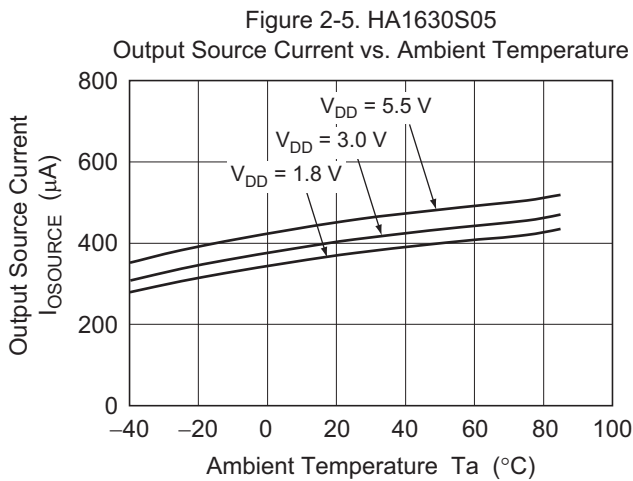
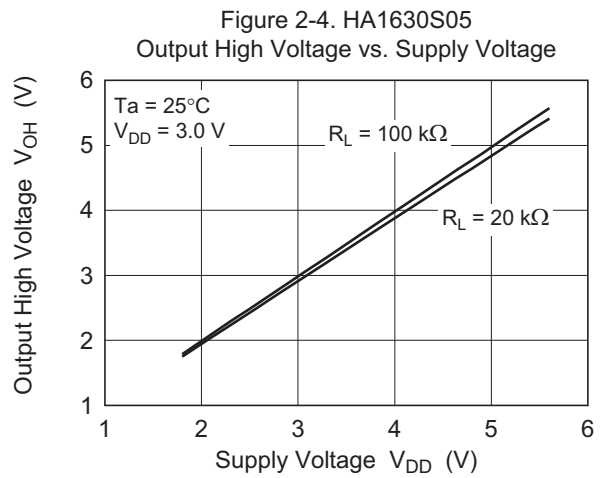
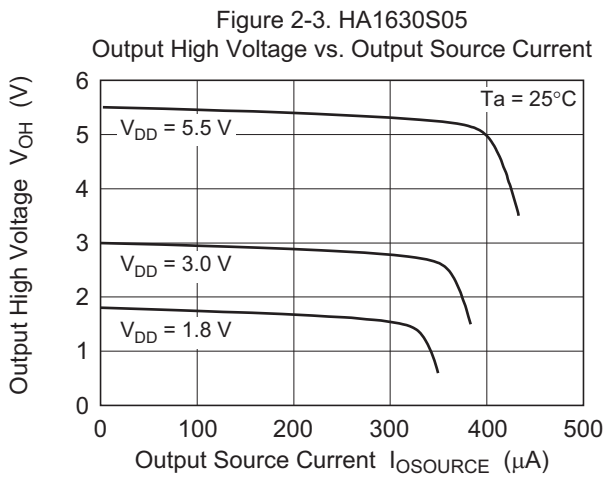
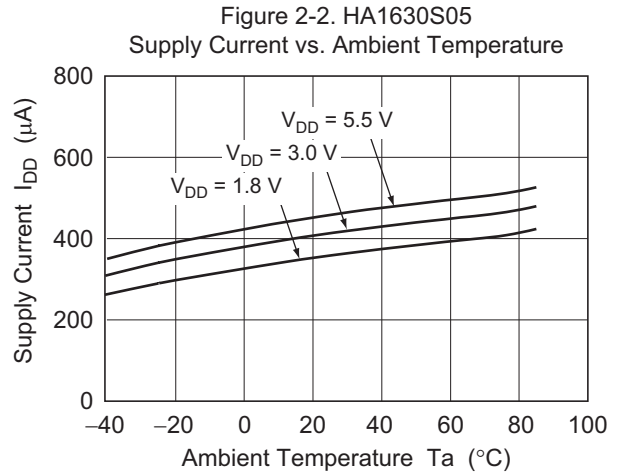
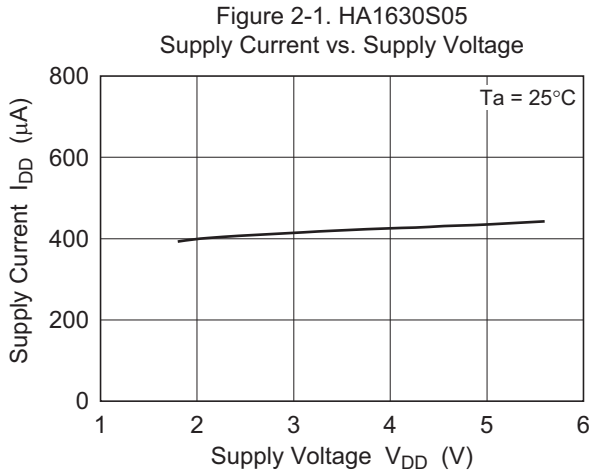

Figure 1-24. HA1630S04
Voltage Noise Density vs. Frequency



Main Characteristics (HA1630S05)



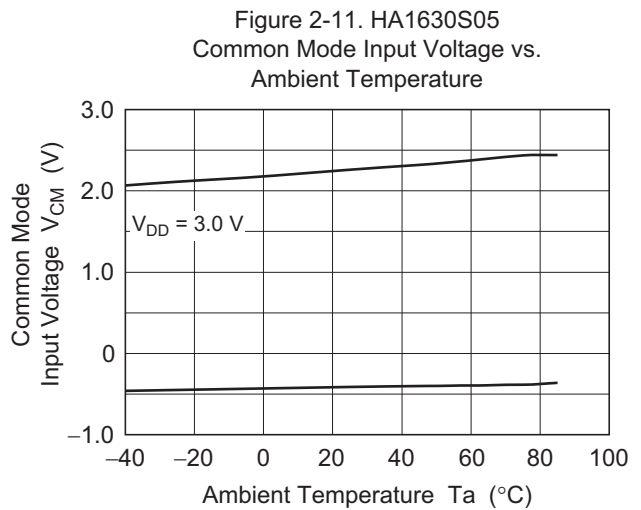
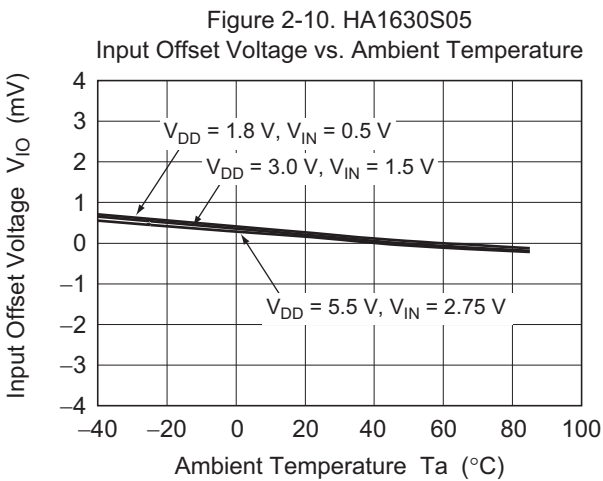
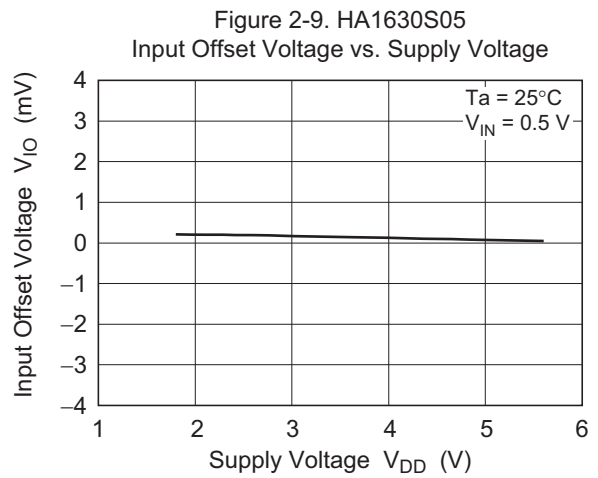
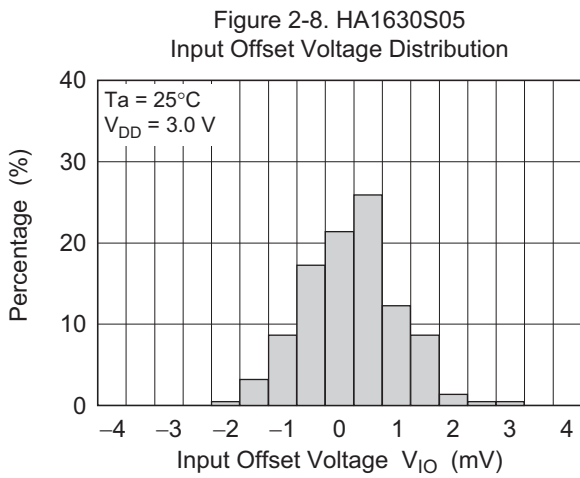
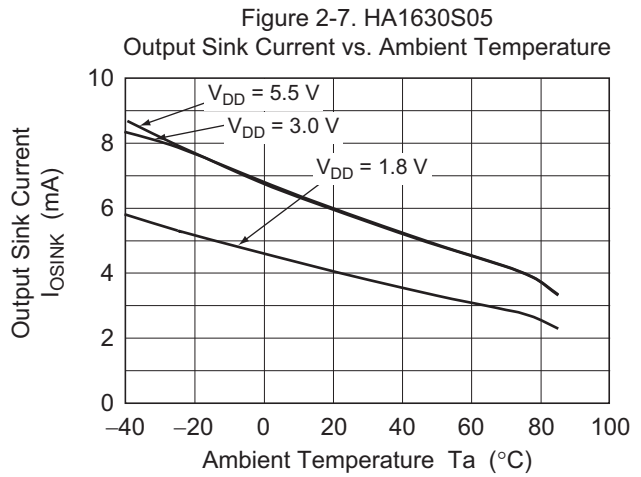
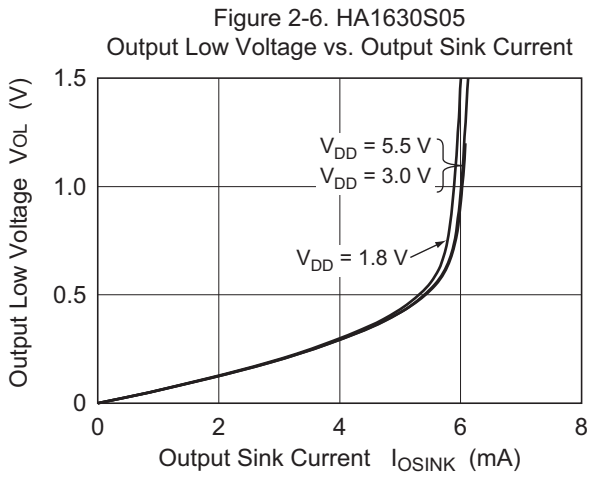

Figure 2-12. HA1630S05
Power Supply Rejection Ratio vs. Frequency

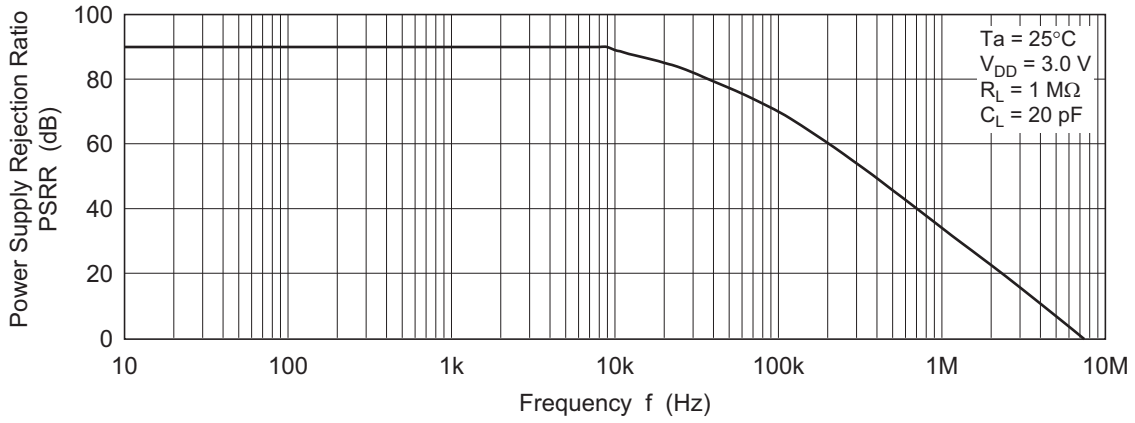

Figure 2-13. HA1630S05
Common Mode Rejection Ratio vs. Frequency

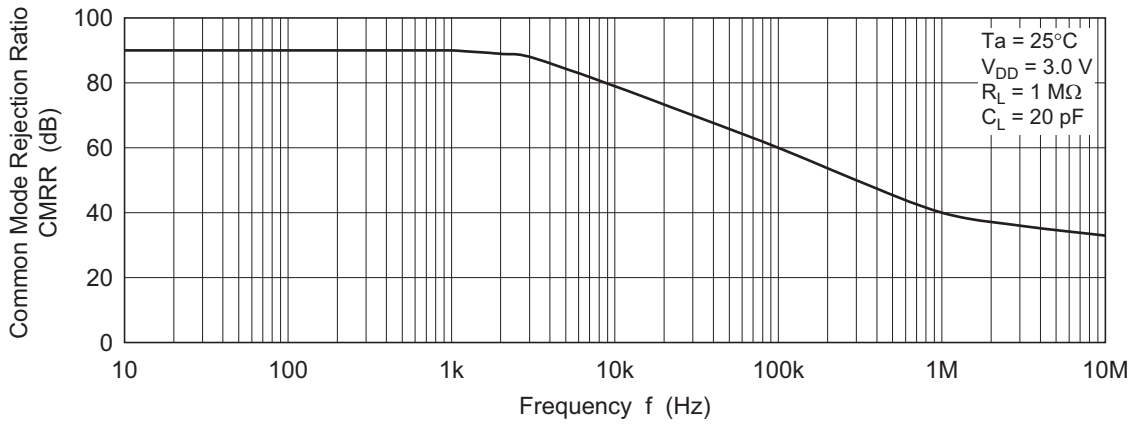
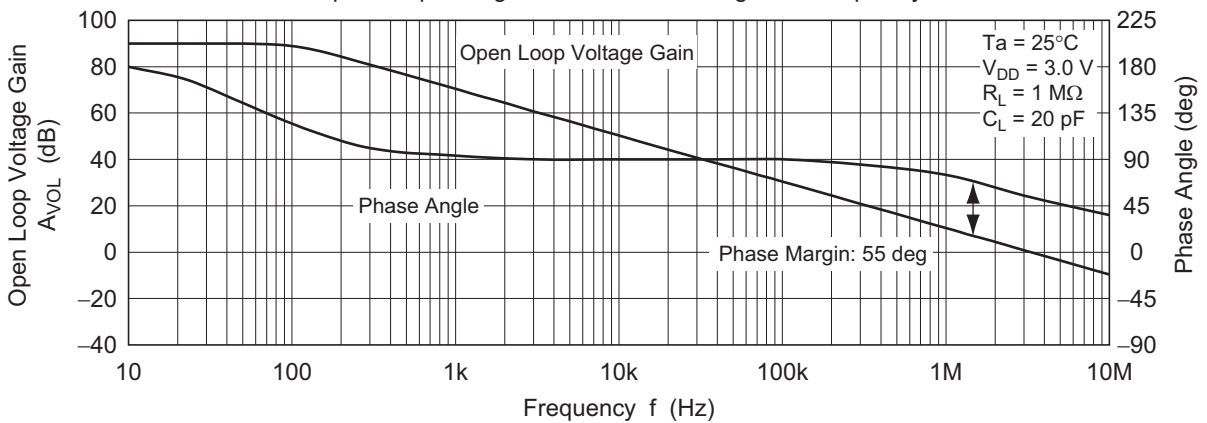

Figure 2-14. HA1630S05
Open Loop Voltage Gain and Phase Angle vs. Frequency



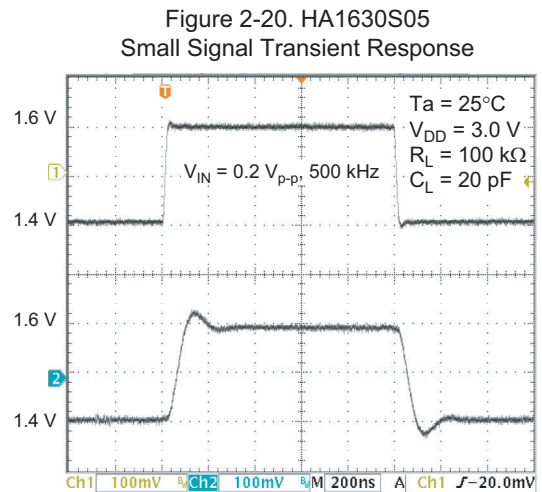
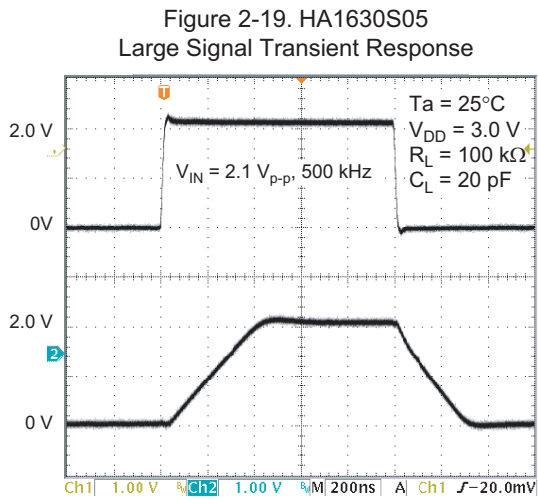
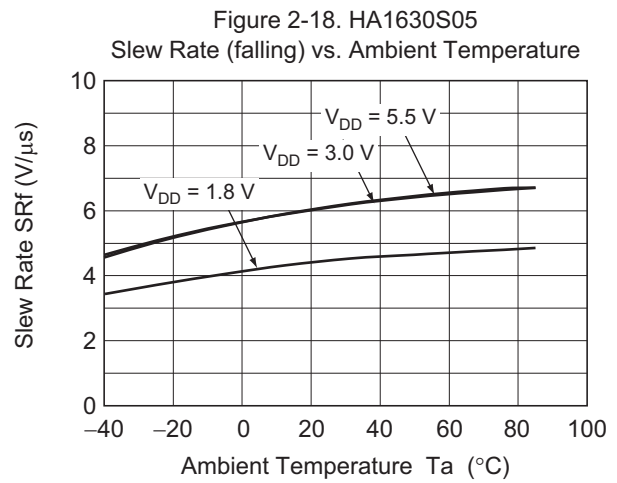
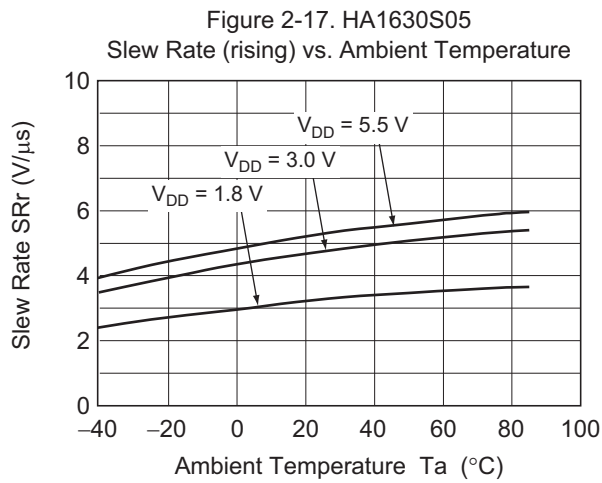
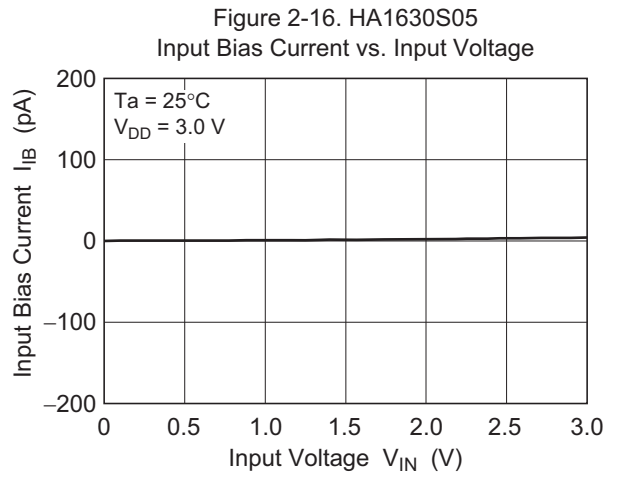
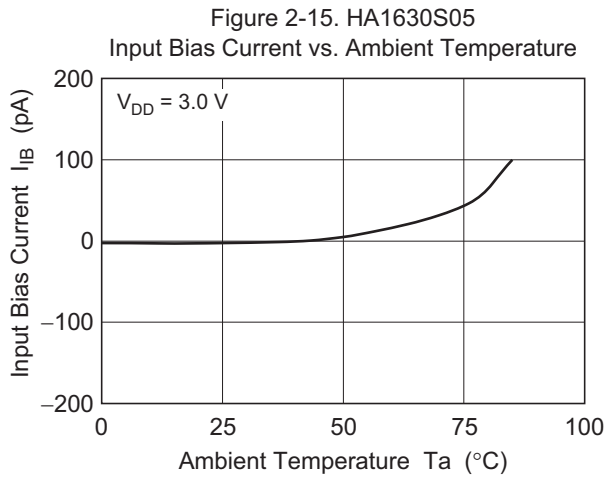

Figure 2-21. HA1630S05
Total Harmonic Distortion + Noise vs.
Output Voltage p-p

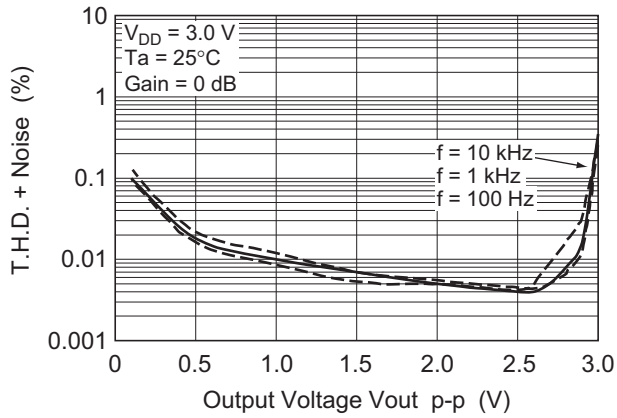

Figure 2-22. HA1630S05
Total Harmonic Distortion + Noise vs.
Output Voltage p-p

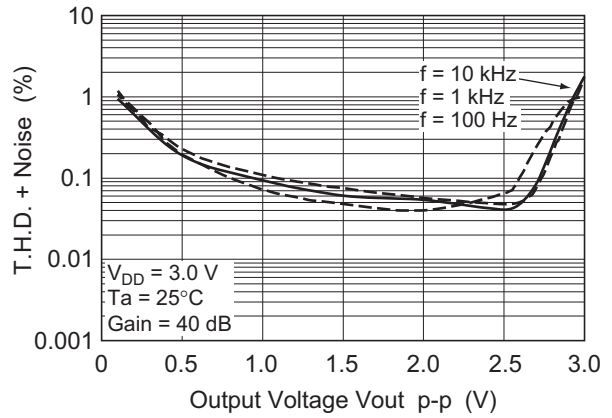

Figure 2-23. HA1630S05
Voltage Output p-p vs. Frequency

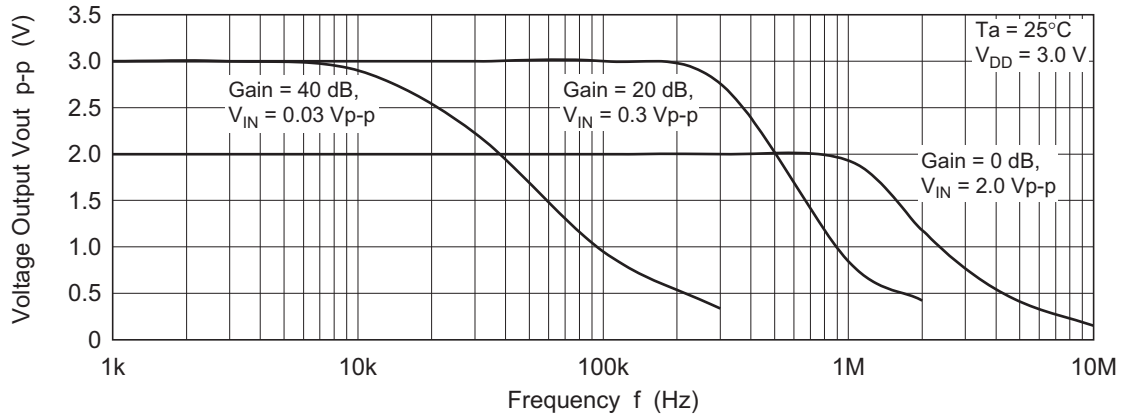
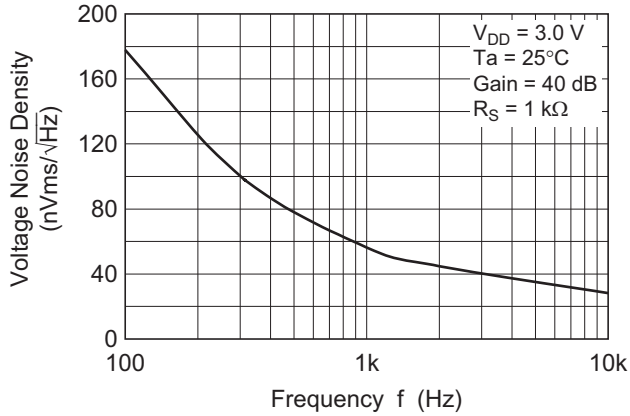
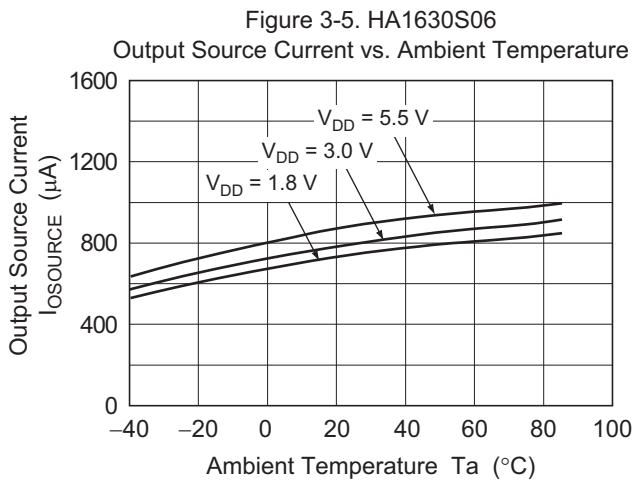
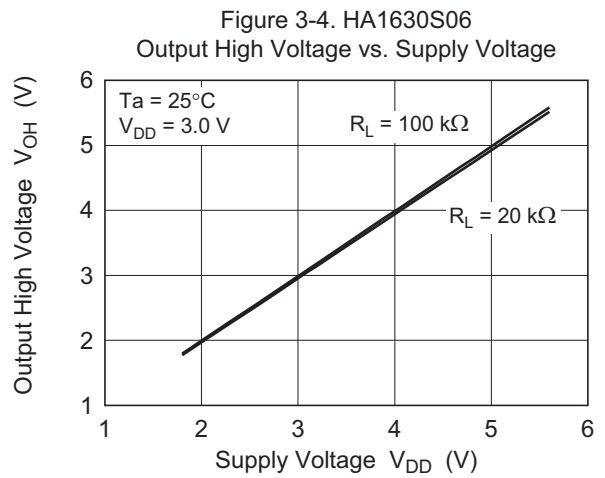
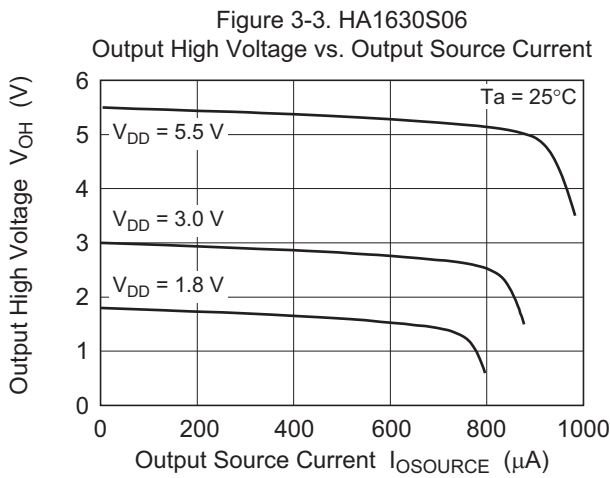
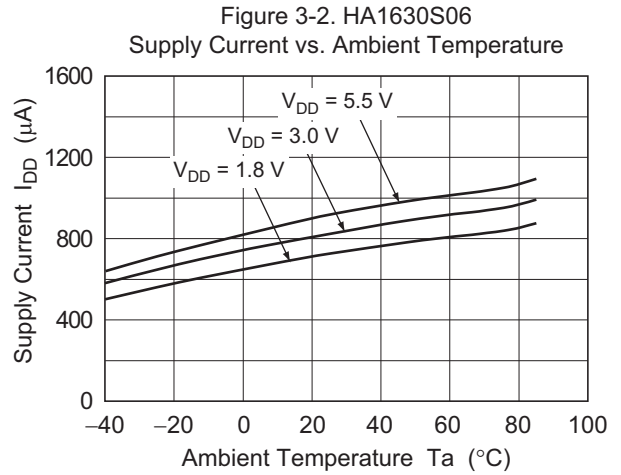
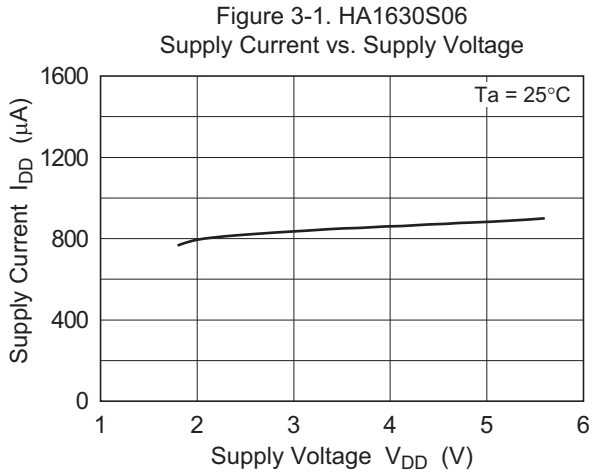

Figure 2-24. HA1630S05
Voltage Noise Density vs. Frequency



Main Characteristics (HA1630S06)



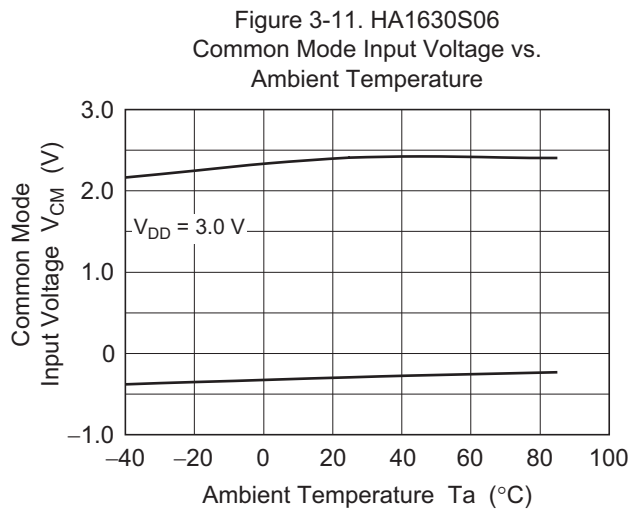
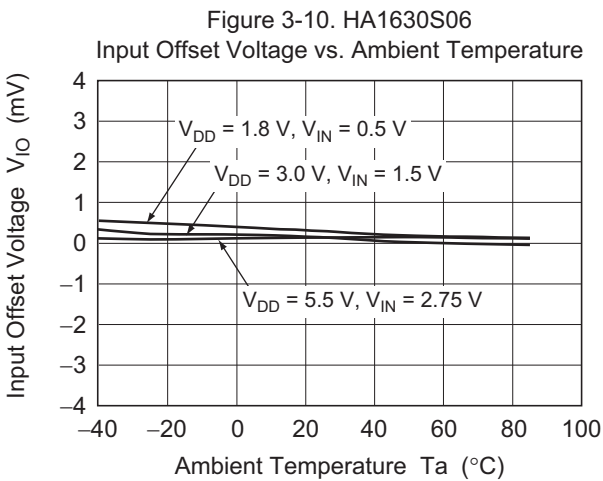
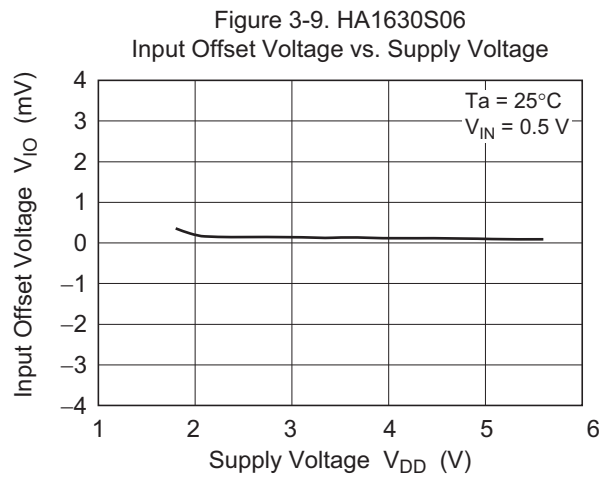
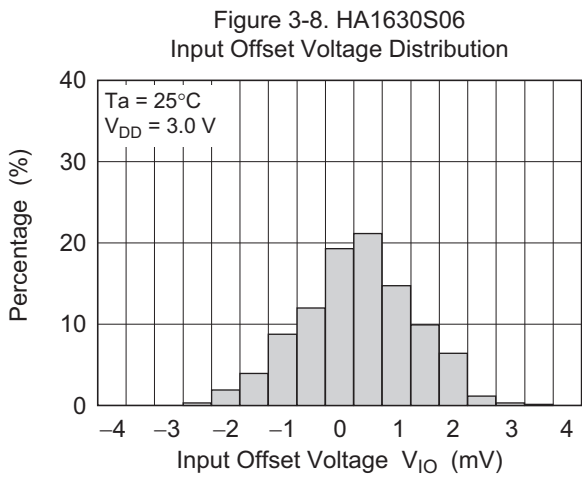
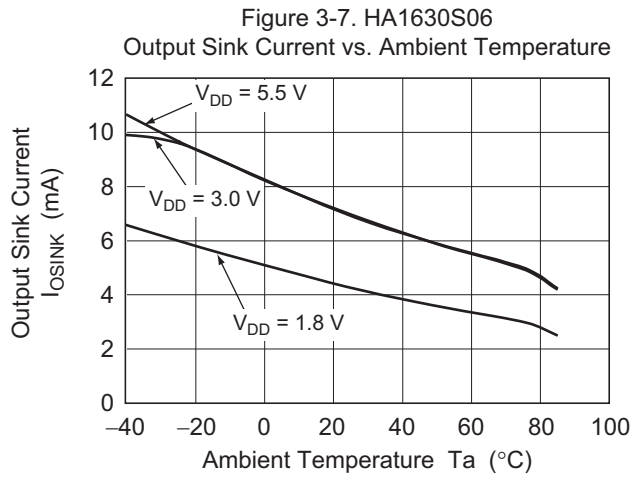
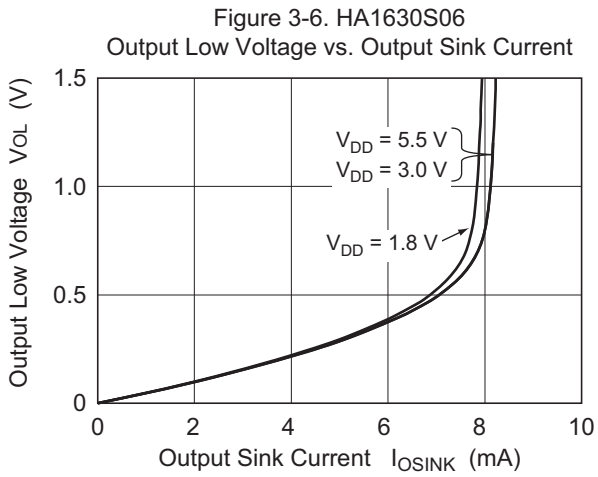

Figure 3-12. HA1630S06
Power Supply Rejection Ratio vs. Frequency

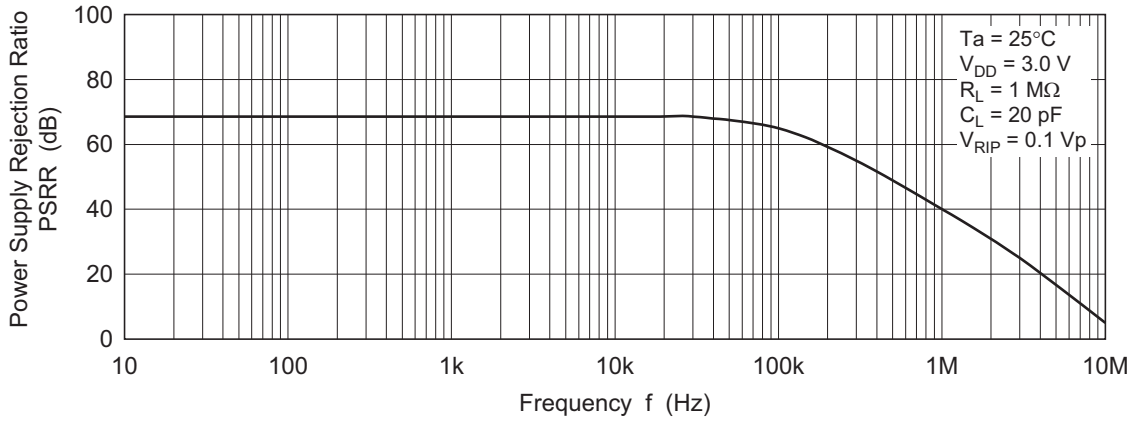

Figure 3-13. HA1630S06
Common Mode Rejection Ratio vs. Frequency

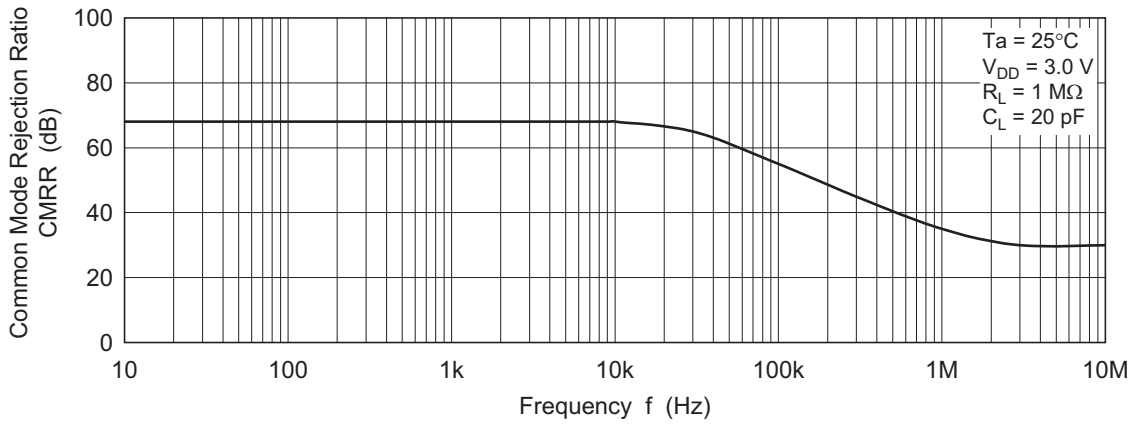
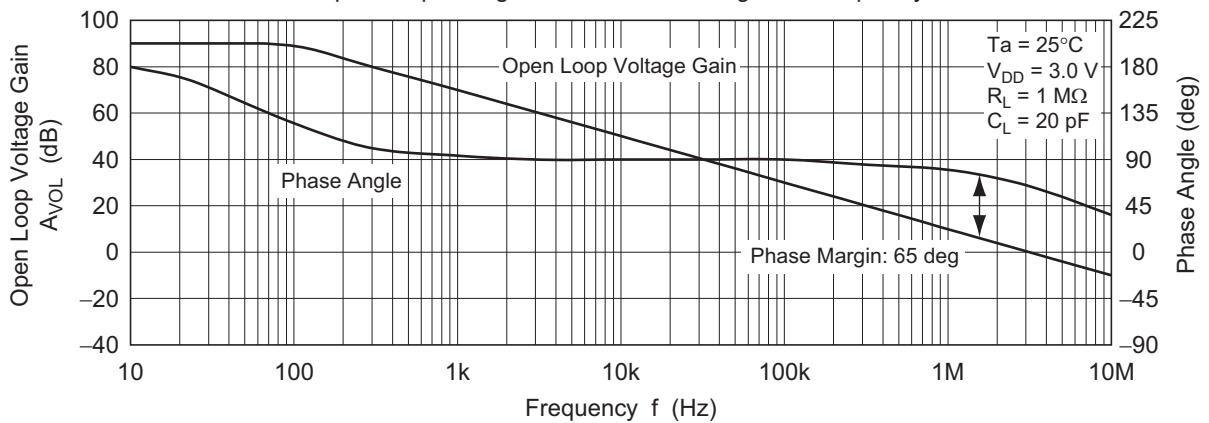

Figure 3-14. HA1630S06
Open Loop Voltage Gain and Phase Angle vs. Frequency



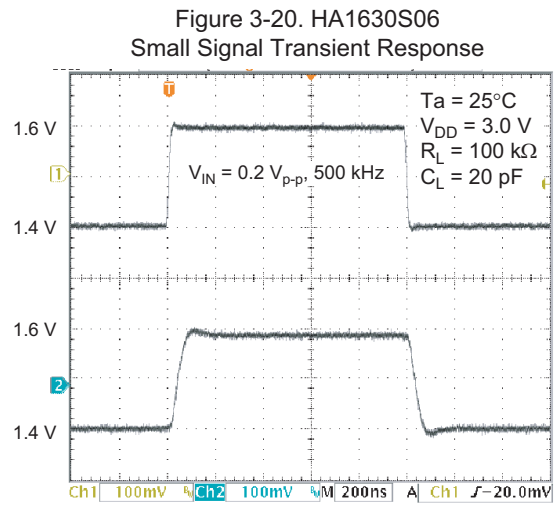
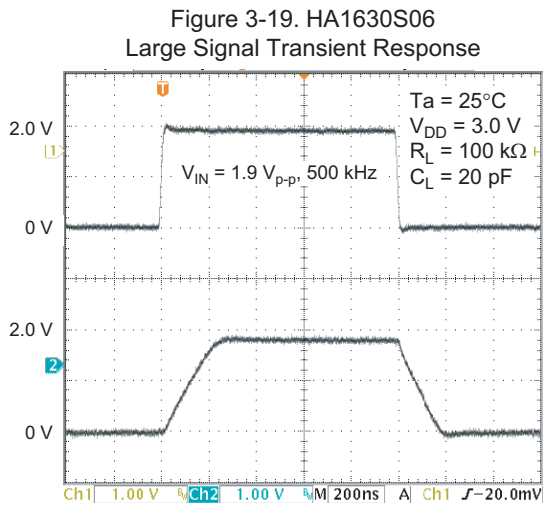
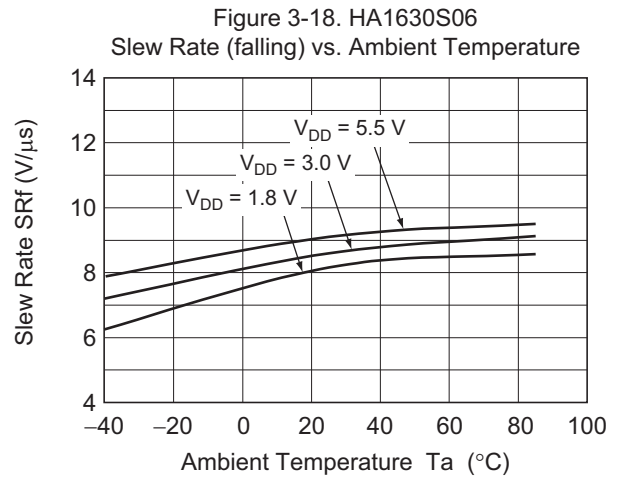
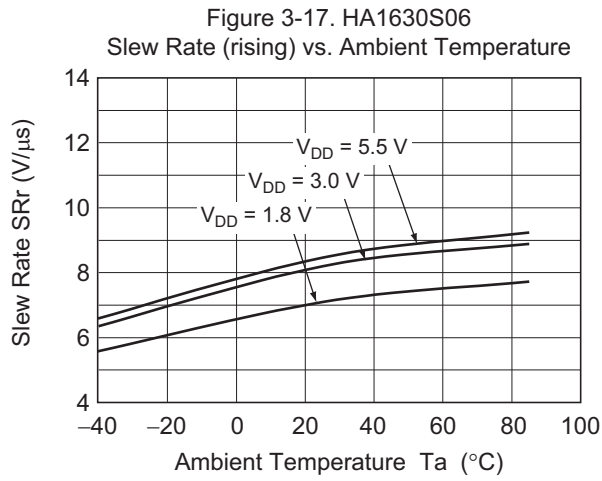
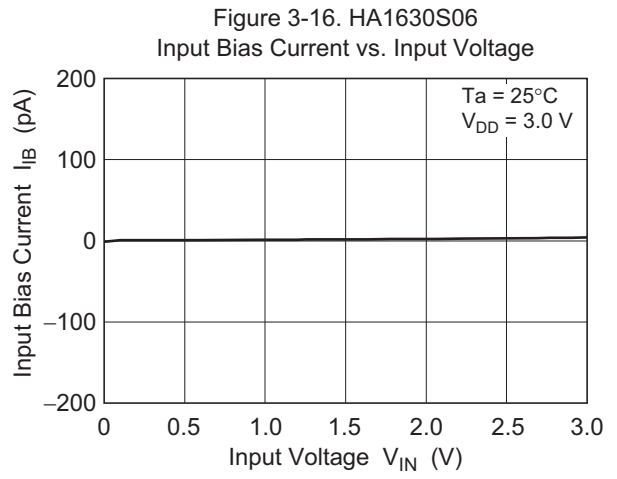
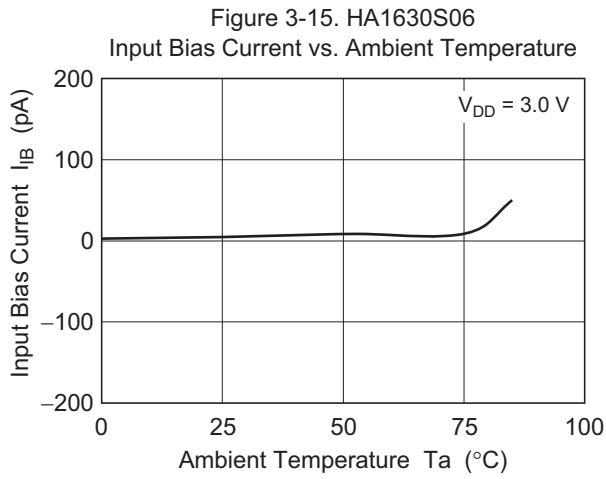

Figure 3-21. HA1630S06
Total Harmonic Distortion + Noise vs.
Output Voltage p-p

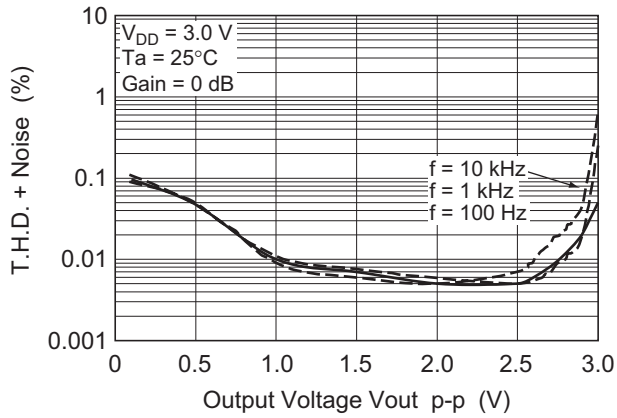

Figure 3-22. HA1630S06
Total Harmonic Distortion + Noise vs.
Output Voltage p-p

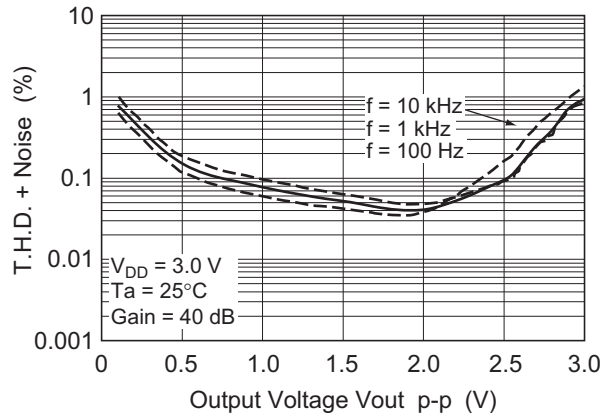

Figure 3-23. HA1630S06
Voltage Output p-p vs. Frequency

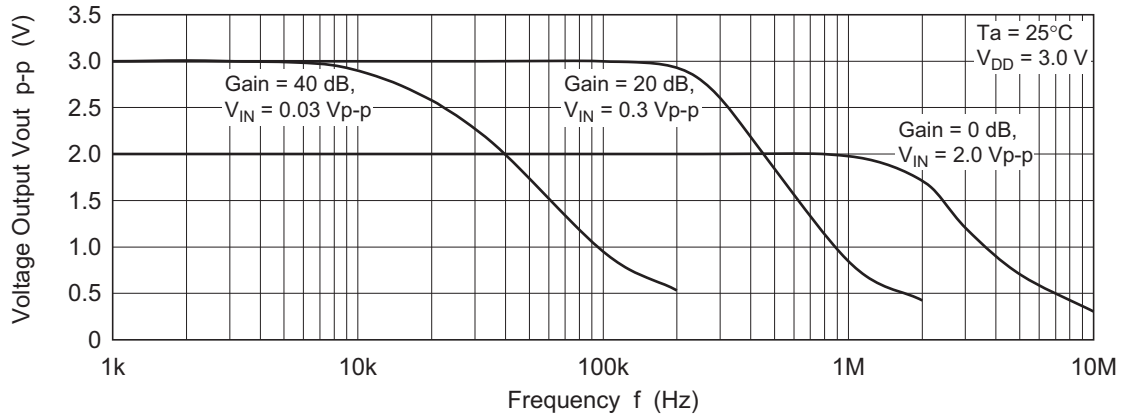
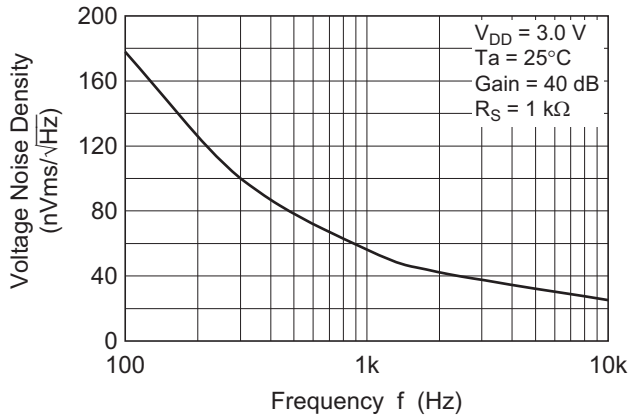
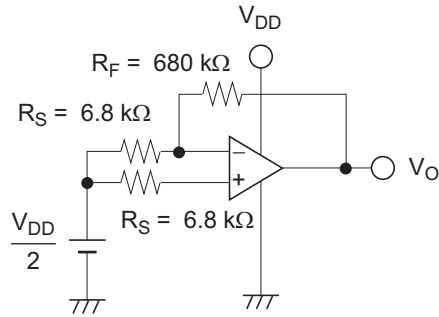

Figure 3-24. HA1630S06
Voltage Noise Density vs. Frequency



Test Circuits

1. Power Supply Rejection Ratio, PSRR & Voltage Offset, V_{IO}



$$V_{IO} = \left(V_O - \frac{V_{DD}}{2} \right) \times \frac{R_S}{R_S + R_F}$$

PSRR

$$PSRR = -20 \log \left(\left| \frac{V_{DD1} - V_{DD2}}{V_{O1} - V_{O2}} \right| \times \frac{R_S}{R_S + R_F} \right)$$

Measure V_O corresponding to $V_{DD1} = 2.95 \text{ V}$ and $V_{DD2} = 3.05 \text{ V}$

2. Supply Current, I_{DD}

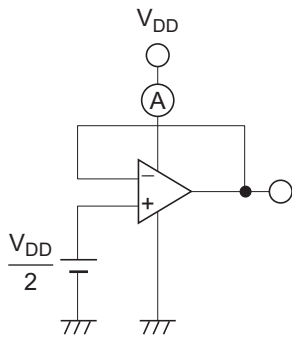

3. Input Bias Current, I_B

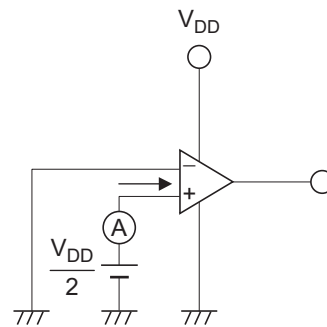

4. Output High Voltage, V_{OH}

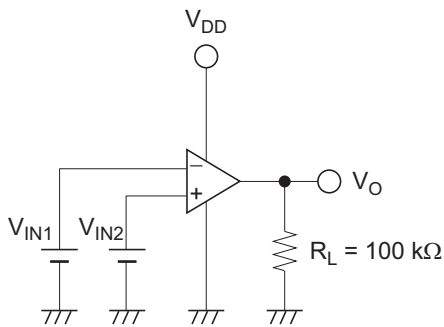

$$\begin{aligned} V_{OH} \\ V_{IN1} &= V_{DD} / 2 - 0.05 \text{ V} \\ V_{IN2} &= V_{DD} / 2 + 0.05 \text{ V} \end{aligned}$$

5. Output Low Voltage, V_{OL}

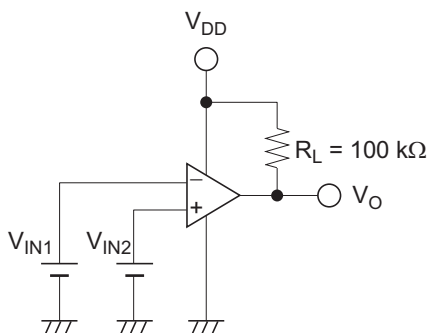

$$\begin{aligned} V_{OL} \\ V_{IN1} &= V_{DD} / 2 + 0.05 \text{ V} \\ V_{IN2} &= V_{DD} / 2 - 0.05 \text{ V} \end{aligned}$$

6. Output Source Current, $I_{OSOURCE}$ & Output Sink Current, I_{OSINK}

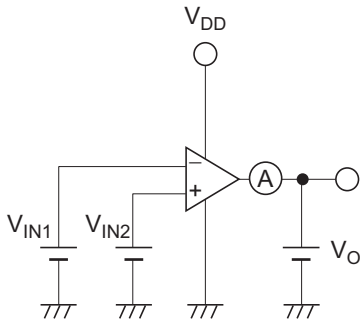

$I_{OSOURCE}$

$$V_O = V_{DD} - 0.5 \text{ V}$$

$$V_{IN1} = V_{DD} / 2 - 0.05 \text{ V}$$

$$V_{IN2} = V_{DD} / 2 + 0.05 \text{ V}$$

I_{OSINK}

$$V_O = + 0.5 \text{ V}$$

$$V_{IN1} = V_{DD} / 2 + 0.05 \text{ V}$$

$$V_{IN2} = V_{DD} / 2 - 0.05 \text{ V}$$

7. Common Mode Input Voltage, V_{CM} & Common Mode Rejection Ratio, CMRR

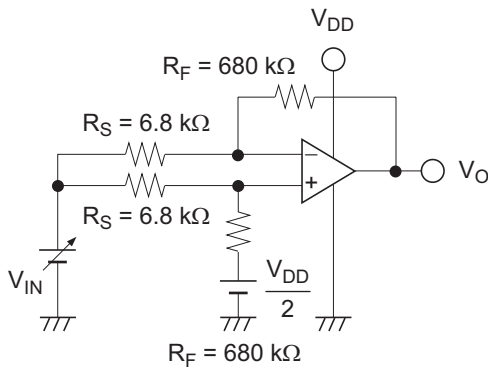

CMRR

$$CMRR = -20 \log \left(\left| \frac{V_{IN1} - V_{IN2}}{V_{O1} - V_{O2}} \right| \times \frac{R_S}{R_S + R_F} \right)$$

Measure V_O corresponding to $V_{IN1} = 1.45 \text{ V}$ and $V_{IN2} = 1.55 \text{ V}$

8. Total Harmonic Distortion, THD

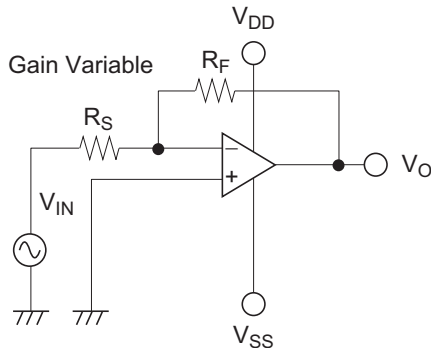

THD

Gain Variable
 $R_F / R_S = 20 \log (100 \text{ k}\Omega / 1 \text{ k}\Omega) = 40 \text{ dB}$
 $R_F / R_S = 20 \log (100 \text{ k}\Omega / 100 \text{ k}\Omega) = 0 \text{ dB}$
 freq = 100 Hz, 1 kHz, 10 kHz
 30 kHz LPF ON

9. Slew Rate, SR

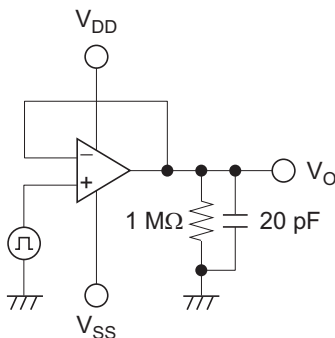

10. Gain, A_V & Phase, GBW

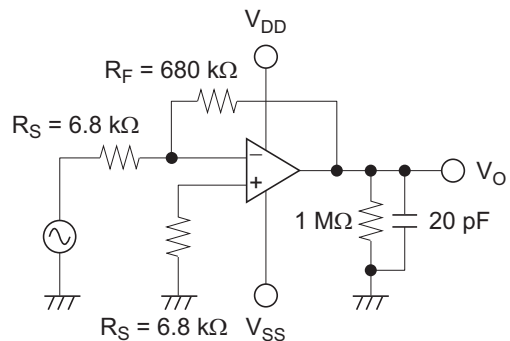

Package Dimensions

JEITA Package Code	RENESAS Code	Previous Code	MASS (Typ) [g]
SC-74A	PLSP0005ZB-A	MPAK-5 / MPAK-5V	0.015

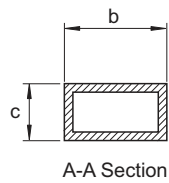
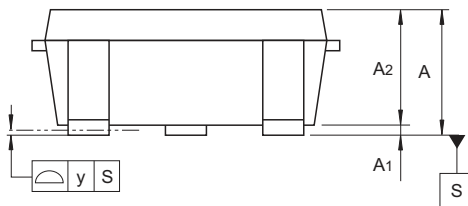
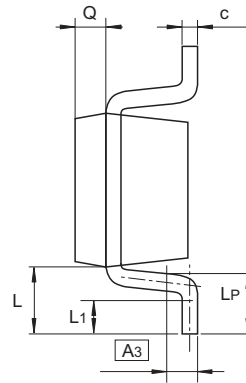
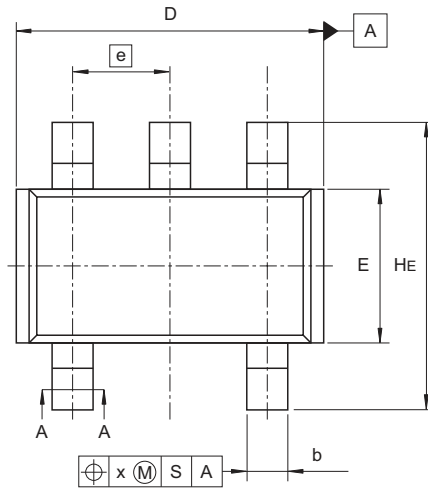

Reference Symbol	Dimensions in millimeters		
	Min	Nom	Max
A	1.0	—	1.4
A ₁	0	—	0.1
A ₂	1.0	1.1	1.3
A ₃	—	0.25	—
b	0.35	0.4	0.5
c	0.11	0.16	0.26
D	2.8	2.95	3.1
E	1.5	1.6	1.8
e	—	0.95	—
H _E	2.5	2.8	3.0
L	0.3	—	0.7
L ₁	0.1	—	0.5
L _P	0.2	—	0.6
x	—	—	0.05
y	—	—	0.05
Q	—	0.3	—

© 2013 Renesas Electronics Corporation. All rights reserved.

JEITA Package Code	RENESAS Code	Previous Code	MASS (Typ) [g]
SC-88A	PTSP0005ZC-A	CMPAK-5 / CMPAK-5V	0.006

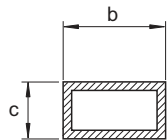
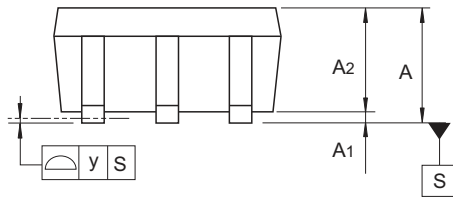
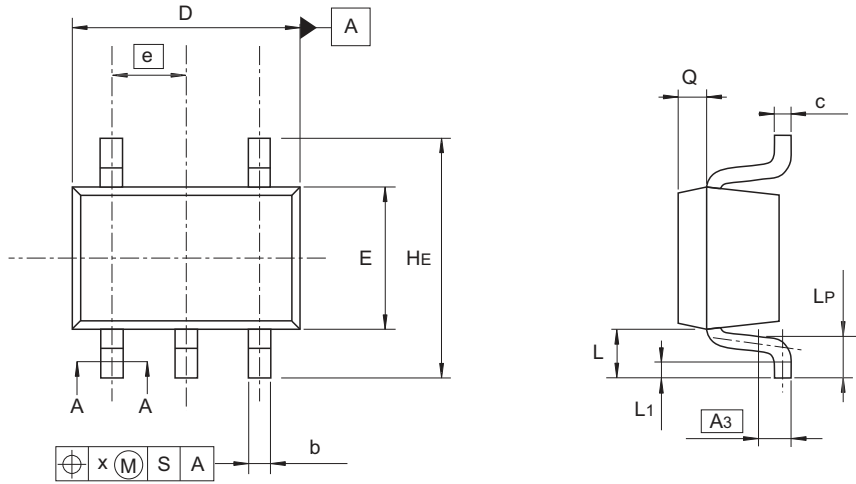

A-A Section

Reference Symbol	Dimensions in millimeters		
	Min	Nom	Max
A	0.8	—	1.1
A ₁	0	—	0.1
A ₂	0.8	0.9	1.0
A ₃	—	0.25	—
b	0.15	0.22	0.3
c	0.1	0.13	0.15
D	1.8	2.0	2.2
E	1.15	1.25	1.35
e	—	0.65	—
H _E	1.8	2.1	2.4
L	0.3	—	0.7
L ₁	0.1	—	0.5
L _P	0.2	—	0.6
x	—	—	0.05
y	—	—	0.05
Q	—	0.25	—

© 2013 Renesas Electronics Corporation. All rights reserved.

Taping & Reel Specification

[Taping]

Package Code	W	P	A ₀	B ₀	K ₀	E	F	D1	Maximum Storage No.
MPAK-5	8	4	3.3	3.3	1.5	1.75	3.5	1.05	3,000 pcs/reel
CMPAK-5	8	4	2.25	2.45	1.1	1.75	3.5	1.05	3,000 pcs/reel

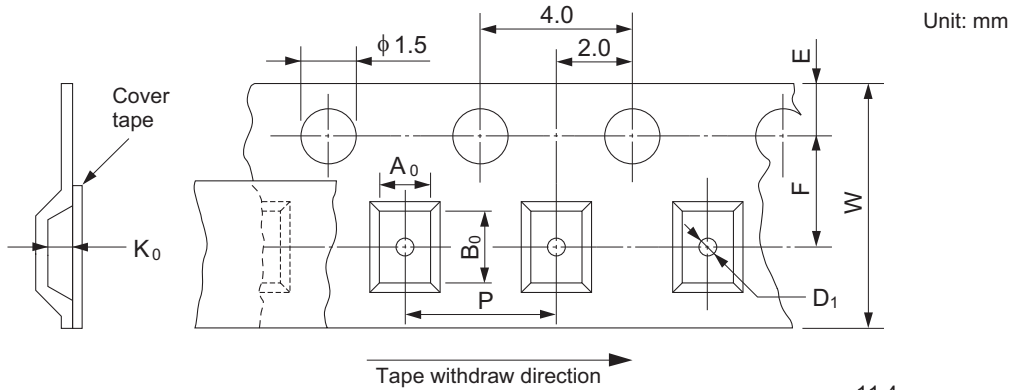

[Reel]

Package	Tape width	W1	W2
MPAK-5	8	11.4	9
CMPAK-5	8	11.4	9

[Ordering Information]

Ordering Unit
3,000 pcs

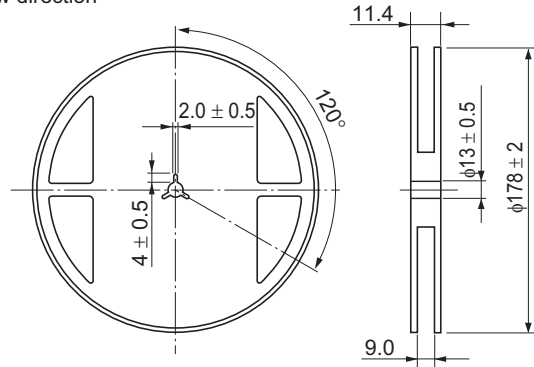

Mark Indication

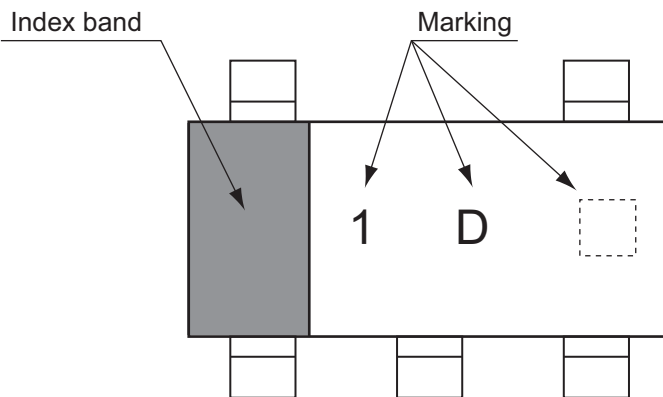

- 1 D □ : HA1630S04
- 1 E □ : HA1630S05
- 1 F □ : HA1630S06

□ = Control code
(— or blank)

Notice

1. Descriptions of circuits, software and other related information in this document are provided only to illustrate the operation of semiconductor products and application examples. You are fully responsible for the incorporation of these circuits, software, and information in the design of your equipment. Renesas Electronics assumes no responsibility for any losses incurred by you or third parties arising from the use of these circuits, software, or information.
2. Renesas Electronics has used reasonable care in preparing the information included in this document, but Renesas Electronics does not warrant that such information is error free. Renesas Electronics assumes no liability whatsoever for any damages incurred by you resulting from errors in or omissions from the information included herein.
3. Renesas Electronics does not assume any liability for infringement of patents, copyrights, or other intellectual property rights of third parties by or arising from the use of Renesas Electronics products or technical information described in this document. No license, express, implied or otherwise, is granted hereby under any patents, copyrights or other intellectual property rights of Renesas Electronics or others.
4. You should not alter, modify, copy, or otherwise misappropriate any Renesas Electronics product, whether in whole or in part. Renesas Electronics assumes no responsibility for any losses incurred by you or third parties arising from such alteration, modification, copy or otherwise misappropriation of Renesas Electronics product.
5. Renesas Electronics products are classified according to the following two quality grades: "Standard" and "High Quality". The recommended applications for each Renesas Electronics product depends on the product's quality grade, as indicated below.
"Standard": Computers; office equipment; communications equipment; test and measurement equipment; audio and visual equipment; home electronic appliances; machine tools; personal electronic equipment; and industrial robots etc.
"High Quality": Transportation equipment (automobiles, trains, ships, etc.); traffic control systems; anti-disaster systems; anti-crime systems; and safety equipment etc.
Renesas Electronics products are neither intended nor authorized for use in products or systems that may pose a direct threat to human life or bodily injury (artificial life support devices or systems, surgical implantations etc.), or may cause serious property damages (nuclear reactor control systems, military equipment etc.). You must check the quality grade of each Renesas Electronics product before using it in a particular application. You may not use any Renesas Electronics product for any application for which it is not intended. Renesas Electronics shall not be in any way liable for any damages or losses incurred by you or third parties arising from the use of any Renesas Electronics product for which the product is not intended by Renesas Electronics.
6. You should use the Renesas Electronics products described in this document within the range specified by Renesas Electronics, especially with respect to the maximum rating, operating supply voltage range, movement power voltage range, heat radiation characteristics, installation and other product characteristics. Renesas Electronics shall have no liability for malfunctions or damages arising out of the use of Renesas Electronics products beyond such specified ranges.
7. Although Renesas Electronics endeavors to improve the quality and reliability of its products, semiconductor products have specific characteristics such as the occurrence of failure at a certain rate and malfunctions under certain use conditions. Further, Renesas Electronics products are not subject to radiation resistance design. Please be sure to implement safety measures to guard them against the possibility of physical injury, and injury or damage caused by fire in the event of the failure of a Renesas Electronics product, such as safety design for hardware and software including but not limited to redundancy, fire control and malfunction prevention, appropriate treatment for aging degradation or any other appropriate measures. Because the evaluation of microcomputer software alone is very difficult, please evaluate the safety of the final products or systems manufactured by you.
8. Please contact a Renesas Electronics sales office for details as to environmental matters such as the environmental compatibility of each Renesas Electronics product. Please use Renesas Electronics products in compliance with all applicable laws and regulations that regulate the inclusion or use of controlled substances, including without limitation, the EU RoHS Directive. Renesas Electronics assumes no liability for damages or losses occurring as a result of your noncompliance with applicable laws and regulations.
9. Renesas Electronics products and technology may not be used for or incorporated into any products or systems whose manufacture, use, or sale is prohibited under any applicable domestic or foreign laws or regulations. You should not use Renesas Electronics products or technology described in this document for any purpose relating to military applications or use by the military, including but not limited to the development of weapons of mass destruction. When exporting the Renesas Electronics products or technology described in this document, you should comply with the applicable export control laws and regulations and follow the procedures required by such laws and regulations.
10. It is the responsibility of the buyer or distributor of Renesas Electronics products, who distributes, disposes of, or otherwise places the product with a third party, to notify such third party in advance of the contents and conditions set forth in this document, Renesas Electronics assumes no responsibility for any losses incurred by you or third parties as a result of unauthorized use of Renesas Electronics products.
11. This document may not be reproduced or duplicated in any form, in whole or in part, without prior written consent of Renesas Electronics.
12. Please contact a Renesas Electronics sales office if you have any questions regarding the information contained in this document or Renesas Electronics products, or if you have any other inquiries.
(Note 1) "Renesas Electronics" as used in this document means Renesas Electronics Corporation and also includes its majority-owned subsidiaries.
(Note 2) "Renesas Electronics product(s)" means any product developed or manufactured by or for Renesas Electronics.



SALES OFFICES

Renesas Electronics Corporation

<http://www.renesas.com>

Refer to "<http://www.renesas.com/>" for the latest and detailed information.

Renesas Electronics America Inc.
2880 Scott Boulevard Santa Clara, CA 95050-2554, U.S.A.
Tel: +1-408-586-6000, Fax: +1-408-588-6130

Renesas Electronics Canada Limited
1101 Nicholson Road, Newmarket, Ontario L3Y 9C3, Canada
Tel: +1-905-898-5441, Fax: +1-905-898-3220

Renesas Electronics Europe Limited
Dukes Meadow, Millboard Road, Bourne End, Buckinghamshire, SL8 5FH, U.K.
Tel: +44-1628-651-700, Fax: +44-1628-651-804

Renesas Electronics Europe GmbH
Arcadiastrasse 10, 40472 Düsseldorf, Germany
Tel: +49-211-65030, Fax: +49-211-6503-1327

Renesas Electronics (China) Co., Ltd.
7th Floor, Quantum Plaza, No.27 ZhiChunLu Haidian District, Beijing 100083, P.R.China
Tel: +86-10-8235-1155, Fax: +86-10-8235-7679

Renesas Electronics (Shanghai) Co., Ltd.
Unit 301, Tower A, Central Towers, 555 LanGao Rd., Putuo District, Shanghai, China
Tel: +86-21-2226-0888, Fax: +86-21-2226-0999

Renesas Electronics Hong Kong Limited
Unit 1601-1613, 16/F., Tower 2, Grand Century Place, 193 Prince Edward Road West, Mongkok, Kowloon, Hong Kong
Tel: +852-2886-9318, Fax: +852 2886-9022/9044

Renesas Electronics Taiwan Co., Ltd.
13F, No. 363, Fu Shing North Road, Taipei, Taiwan
Tel: +886-2-8175-9600, Fax: +886 2-8175-9670

Renesas Electronics Singapore Pte. Ltd.
80 Bendemeer Road, Unit #06-02 Hyflux Innovation Centre Singapore 339949
Tel: +65-6213-0200, Fax: +65-6213-0300

Renesas Electronics Malaysia Sdn.Bhd.
Unit 906, Block B, Menara Amcorp, Amcorp Trade Centre, No. 18, Jin Persiaran Barat, 46050 Petaling Jaya, Selangor Darul Ehsan, Malaysia
Tel: +60-3-7955-9390, Fax: +60-3-7955-9510

Renesas Electronics Korea Co., Ltd.
12F., 234 Teheran-ro, Gangnam-Gu, Seoul, 135-080, Korea
Tel: +82-2-558-3737, Fax: +82-2-558-5141