

ISL6115A

12V Power Distribution Controllers

FN6855  
Rev 1.00  
April 23, 2010

This fully featured hot swap power controller targets +12V applications. The ISL6115A with its integrated charge pump has a higher (6.5V vs 5V) gate drive than its sister part the ISL6115 making this part an immediate efficiency improvement replacement.

This IC features programmable overcurrent (OC) detection, current regulation (CR) with time delay to latch-off and soft-start.

The current regulation level is set by 2 external resistors;  $R_{ISET}$  sets the CR  $V_{th}$  and the other is a low ohmic sense resistor across, which the CR  $V_{th}$  is developed. The CR duration is set by an external capacitor on the CTIM pin, which is charged with a 20 $\mu$ A current once the CR  $V_{th}$  level is reached. The IC then quickly pulls down the GATE output latching off the pass FET.

Features

- HOT SWAP Single Power Distribution Control for +12V
- Overcurrent Fault Isolation
- Programmable Current Regulation Level
- Programmable Current Regulation Time to Latch-Off
- Rail-to-Rail Common Mode Input Voltage Range
- Enhanced Internal Charge Pump Drives N-Channel MOSFET gate to 6.5V above IC bias.
- Undervoltage and Overcurrent Latch Indicators
- Adjustable Turn-On Ramp
- Protection During Turn-On
- Two Levels of Overcurrent Detection Provide Fast Response to Varying Fault Conditions
- 1 $\mu$ s Response Time to Dead Short
- Pb-Free (RoHS Compliant)

Applications

- Power Distribution Control
- Hot Plug Components and Circuitry

Application Circuits - High Side Controller

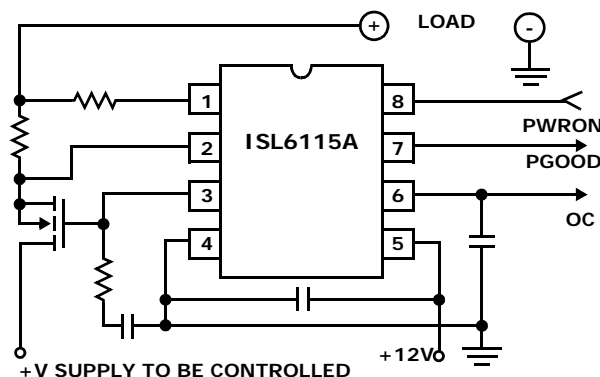



## Pin Descriptions

PIN NO.	SYMBOL	FUNCTION	DESCRIPTION
1	ISET	Current Set	Connect to the low side of the current sense resistor through the current limiting set resistor. This pin functions as the current limit programming pin.
2	ISEN	Current Sense	Connect to the more positive end of sense resistor to measure the voltage drop across this resistor.
3	GATE	External FET Gate Drive Pin	Connect to the gate of the external N-Channel MOSFET. A capacitor from this node to ground sets the turn-on ramp. At turn-on this capacitor will be charged to $V_{DD} + 6.5V$ by an $14\mu A$ current source.
4	VSS	Chip Return	
5	VDD	Chip Supply	12V chip supply. This can be either connected directly to the +12V rail supplying the switched load voltage or to a dedicated $V_{SS} + 12V$ supply.
6	CTIM	Current Limit Timing Capacitor	Connect a capacitor from this pin to ground. This capacitor determines the time delay between an overcurrent event and chip output shutdown (current limit time-out). The duration of current limit time-out is equal to $93k\Omega \times C_{TIM}$ .
7	PGOOD	Power Good Indicator	Indicates that the voltage on the ISEN pin is satisfactory. PGOOD is driven by an open drain N-Channel MOSFET and is pulled low when the output voltage (VISEN) is less than the UV level for the particular IC.
8	PWRON	Power-ON	PWRON is used to control and reset the chip. The chip is enabled when PWRON pin is driven high to a maximum of 5V or is left open. Do not drive this input >5V. After a current limit time-out, the chip is reset by a low level signal applied to this pin. This input has $20\mu A$ pull-up capability.

**Absolute Maximum Ratings**  $T_A = +25^\circ\text{C}$ 

$V_{DD}$	-0.3V to +16V
GATE	-0.3V to $V_{DD} + 8\text{V}$
ISEN, PGOOD, PWRON, CTIM, ISET	-0.3V to $V_{DD} + 0.3\text{V}$

**Operating Conditions**

$V_{DD}$ Supply Voltage Range	+12V $\pm$ 15%
Temperature Range ( $T_A$ )	-40°C to +85°C
ESD	
Human Body Model	2.5kV
Machine Model	250V

**Thermal Information**

Thermal Resistance (Typical, Note 4)	$\theta_{JA}$ ( $^\circ\text{C}/\text{W}$ )
8 Ld SOIC Package	98
Maximum Junction Temperature (Plastic Package)	+150°C
Maximum Storage Temperature Range	-65°C to +150°C
Pb-Free Reflow Profile	see link below
	<a href="http://www.intersil.com/pbfree/Pb-FreeReflow.asp">http://www.intersil.com/pbfree/Pb-FreeReflow.asp</a>

**CAUTION:** Do not operate at or near the maximum ratings listed for extended periods of time. Exposure to such conditions may adversely impact product reliability and result in failures not covered by warranty.

## NOTES:

- $\theta_{JA}$  is measured with the component mounted on a high effective thermal conductivity test board in free air. See Tech Brief TB379 for details.
- All voltages are relative to GND, unless otherwise specified.

**Electrical Specifications**  $V_{DD} = 12\text{V}$ ,  $T_A = T_J =$  full temperature range, Unless Otherwise Specified.

PARAMETER	SYMBOL	TEST CONDITIONS	MIN (Note 6)	TYP	MAX (Note 6)	UNITS
<b>CURRENT CONTROL</b>						
ISET Current Source	$I_{ISET\_ft}$		<b>17</b>	20	<b>22</b>	$\mu\text{A}$
ISET Current Source	$I_{ISET\_pt}$	$T_J = +15^\circ\text{C}$ to $+55^\circ\text{C}$	<b>19</b>	20	<b>21</b>	$\mu\text{A}$
Current Limit Amp Offset Voltage	$V_{io\_ft}$	$V_{ISET} - V_{ISEN}$	<b>-4.5</b>	0	<b>4.5</b>	mV
Current Limit Amp Offset Voltage	$V_{io\_pt}$	$V_{ISET} - V_{ISEN}$ , $T_J = +15^\circ\text{C}$ to $+55^\circ\text{C}$	<b>-2</b>	0	<b>2</b>	mV
<b>GATE DRIVE</b>						
GATE Response Time to Severe OC	$pd\_woc\_amp$	$V_{GATE}$ to 10.8V	-	100	-	ns
GATE Response Time to Overcurrent	$pd\_oc\_amp$	$V_{GATE}$ to 10.8V	-	600	-	ns
GATE Turn-On Current	$I_{GATE}$	$V_{GATE}$ to = 6V	<b>10.8</b>	14	<b>16.7</b>	$\mu\text{A}$
GATE Pull-Down Current	$OC\_GATE\_I\_4V$	Overcurrent	<b>45</b>	82	<b>124</b>	mA
GATE Pull-Down Current (Note 6)	$WOC\_GATE\_I\_4V$	Severe Overcurrent	-	0.8	-	A
Undervoltage Threshold	$12V_{UV\_VTH}$		<b>8.9</b>	9.6	<b>10.2</b>	V
GATE High Voltage	12VG	GATE Voltage	<b><math>V_{DD} + 5.7\text{V}</math></b>	$V_{DD} + 6.5\text{V}$	-	V
<b>BIAS</b>						
$V_{DD}$ Supply Current	$I_{VDD}$		-	3	<b>3.9</b>	mA
$V_{DD}$ POR Rising Threshold	$V_{DD\_POR\_L2H}$	VDD Low to High	<b>7</b>	8.4	<b>9</b>	V
$V_{DD}$ POR Falling Threshold	$V_{DD\_POR\_H2L}$	VDD High to Low	<b>6.9</b>	8.1	<b>8.7</b>	V
$V_{DD}$ POR Threshold Hysteresis	$V_{DD\_POR\_HYS}$	$V_{DD\_POR\_L2H} - V_{DD\_POR\_H2L}$	<b>0.1</b>	0.3	<b>0.5</b>	V
Maximum PWRON Pull-Up Voltage	$PWRN\_PUV$	Maximum External Pull-up Voltage	-	5	-	V
PWRON Pull-Up Voltage	$PWRN\_V$	PWRON Pin Open	<b>2.5</b>	3.2	-	V
PWRON Rising Threshold	$PWR\_Vth$		<b>1.1</b>	1.7	<b>2.35</b>	V
PWRON Hysteresis	$PWR\_hys$		<b>125</b>	170	<b>250</b>	mV
PWRON Pull-Up Current	$PWRN\_I$		<b>12.6</b>	17	<b>24</b>	$\mu\text{A}$

**Electrical Specifications**  $V_{DD} = 12V$ ,  $T_A = T_J =$  full temperature range, Unless Otherwise Specified.

PARAMETER	SYMBOL	TEST CONDITIONS	MIN (Note 6)	TYP	MAX (Note 6)	UNITS
<b>CURRENT REGULATION DURATION/POWER GOOD</b>						
$C_{TIM}$ Charging Current	$C_{TIM\_ichg0}$	$V_{CTIM} = 0V$	<b>17.2</b>	20.5	<b>25</b>	$\mu A$
$C_{TIM}$ Fault Pull-Up Current (Note 6)			-	20	-	mA
Current Limit Time-Out Threshold Voltage	$C_{TIM\_Vth}$	CTIM Voltage	<b>1.6</b>	1.8	<b>2.1</b>	V
Power Good Pull Down Current	PG_Ipd	$V_{OUT} = 0.5V$	-	8	-	mA

## NOTES:

6. Parameters with MIN and/or MAX limits are 100% tested at +25°C, unless otherwise specified. Temperature limits established by characterization and are not production tested.

## Description and Operation

The ISL6115A is targeted for +12V single power supply distribution control for generic hot swap switching applications.

This ICs features a highly accurate programmable current regulation (CR) level with programmable time delay to latch-off, and programmable soft-start turn-on ramp all set with a minimum of external passive components. It also includes severe OC protection that immediately shuts down the MOSFET switch should a rapid load current transient such as with a dead short cause the CR  $V_{th}$  to exceed the programmed level by 150mV. Additionally, it has an UV indicator and an OC latch indicator. The functionality of the PGOOD feature is enabled once the IC is biased, monitoring and reporting any UV condition on the ISEN pin.

Upon initial power-up, the IC can either isolate the voltage supply from the load by holding the external N-Channel MOSFET switch off or apply the supply rail voltage directly to the load for true hot swap capability. The PWRON pin must be pulled low for the device to isolate the power supply from the load by holding the external N-Channel MOSFET off. With the PWRON pin held high or floating the IC will be in true hot swap mode. In both cases the IC turns on in a soft-start mode protecting the supply rail from sudden inrush current.

At turn-on, the external gate capacitor of the N-Channel MOSFET is charged with a 11 $\mu A$  current source resulting in a programmable ramp (soft-start turn-on). The internal ISL6115A charge pump supplies the gate drive for the 12V supply switch driving that gate to  $-V_{DD} + 6.5V$ . Load current passes through the external current sense resistor. When the voltage across the sense resistor exceeds the user programmed CR voltage threshold value, (see Table 1 for  $R_{ISET}$  programming resistor value and resulting nominal current regulation threshold voltage,  $V_{CR}$ ) the controller enters its current regulation mode. At

this time, the time-out capacitor, on CTIM pin is charged with a 20 $\mu A$  current source and the controller enters the current limit time to latch-off period. The length of the current limit time to latch-off duration is set by the value of a single external capacitor (see Table 2) for  $C_{TIM}$  capacitor value and resulting nominal current limited time-out to latch-off duration placed from the CTIM pin (pin 6) to ground. The programmed current level is held until either the OC event passes or the time-out period expires. If the former is the case then the N-Channel MOSFET is fully enhanced and the  $C_{TIM}$  capacitor is discharged. Once  $C_{TIM}$  charges to  $\sim 1.8V$  signaling that the time-out period has expired, an internal latch is set whereby the FET gate is quickly pulled to 0V turning off the N-Channel MOSFET switch, isolating the faulty load.

**TABLE 1.  $R_{ISET}$  PROGRAMMING RESISTOR VALUE**

$R_{ISET}$ RESISTOR	NOMINAL CR $V_{TH}$
10k $\Omega$	200mV
4.99k $\Omega$	100mV
2.5k $\Omega$	50mV
1.25k $\Omega$	25mV

NOTE: Nominal  $V_{th} = R_{ISET} \times 20\mu A$ .

**TABLE 2.  $C_{TIM}$  CAPACITOR VALUE**

$C_{TIM}$ CAPACITOR	NOMINAL CURRENT LIMITED PERIOD
0.022 $\mu F$	2ms
0.047 $\mu F$	4.4ms
0.1 $\mu F$	9.3ms

NOTE: Nominal time-out period =  $C_{TIM} \times 93k\Omega$ .

This IC responds to a severe overcurrent load (defined as a voltage across the sense resistor >150mV over the OC  $V_{th}$  set point) by immediately driving the N-Channel MOSFET gate to 0V in about 10 $\mu s$ . The gate voltage is then slowly ramped up turning on the N-Channel MOSFET to the programmed current regulation level; this is the start of the time-out period.

Upon a UV condition, the PGOOD signal will pull low when connected through a resistor to the logic or VDD supply. This pin is a UV fault indicator. For an OC latch-off indication, monitor CTIM, pin 6. This pin will rise rapidly from 1.8V to VDD once the time-out period expires.

See Figures 2 through 13 for graphs and waveforms related to text.

The IC is reset after an OC latch-off condition by a low level on the PWRON pin and is turned on by the PWRON pin being driven high.

### Application Considerations

Design applications where the CR Vth is set extremely low (25mV or less), there is a two-fold risk to consider.

- There is the susceptibility to noise influencing the absolute CR Vth value. This can be addressed with a 100pF capacitor across the R<sub>SENSE</sub> resistor.
- Due to common mode limitations of the overcurrent comparator, the voltage on the ISET pin must be 20mV above the IC ground either initially (from  $I_{SET} \cdot R_{SET}$ ) or before C<sub>TIM</sub> reaches time-out (from gate charge-up). If this does not happen, the IC may incorrectly report overcurrent fault at start-up when there is no fault. Circuits with high load capacitance and initially low load current are susceptible to this type of unexpected behavior.

Do not signal nor pull-up the PWRON input to > 5V. Exceeding 6V on this pin will cause the internal charge pump to malfunction.

During the soft-start and the time-out delay duration with the IC in its current limit mode, the V<sub>GS</sub> of the external N-Channel MOSFET is reduced driving the MOSFET switch into a (linear region) high r<sub>DS(ON)</sub> state. Strike a balance between the CR limit and the timing requirements to avoid periods when the external N-Channel MOSFETs may be damaged or destroyed due to excessive internal power dissipation. Refer to the **MOSFET SOA** information in the manufacturer's data sheet.

When driving particularly large capacitive loads a longer soft-start time to prevent current regulation upon charging and a short CR time may offer the best application solution relative to reliability and FET MTF.

**Physical layout of R<sub>SENSE</sub> resistor** is critical to avoid the possibility of false overcurrent occurrences. Ideally, trace routing between the R<sub>SENSE</sub> resistors and the IC is as direct and as short as possible with zero current in the sense lines (see Figure 1).

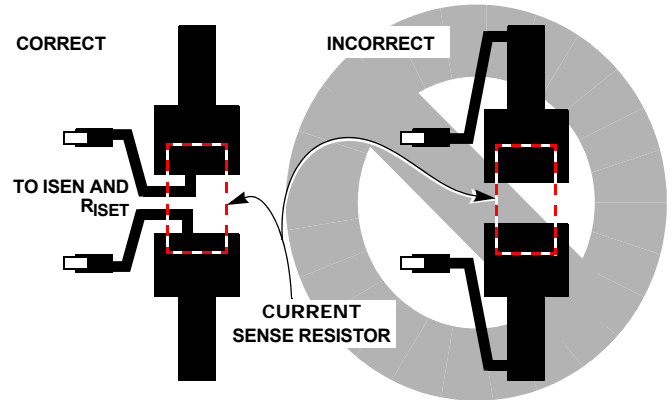

FIGURE 1. SENSE RESISTOR PCB LAYOUT

## Typical Performance Curves

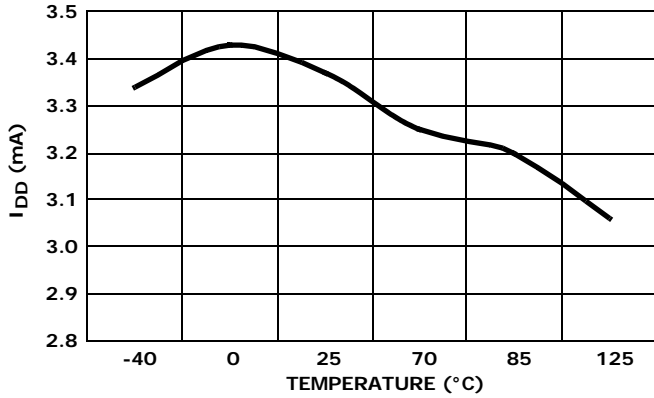

FIGURE 2. V<sub>DD</sub> BIAS CURRENT

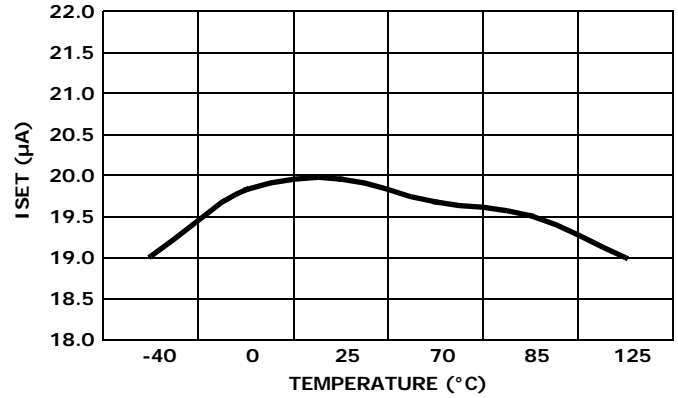

FIGURE 3. I<sub>SET</sub> SOURCE CURRENT

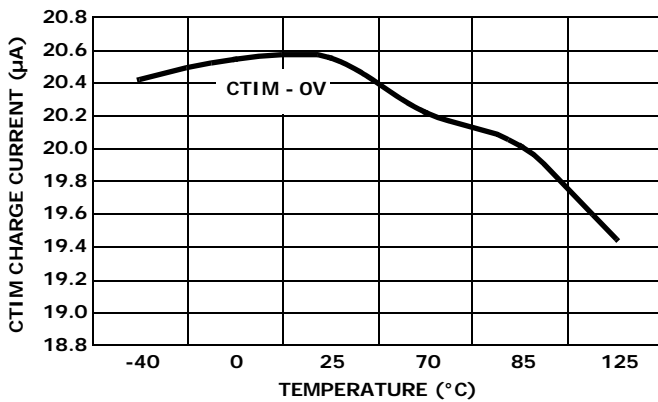

FIGURE 4. C<sub>TIM</sub> CURRENT SOURCE

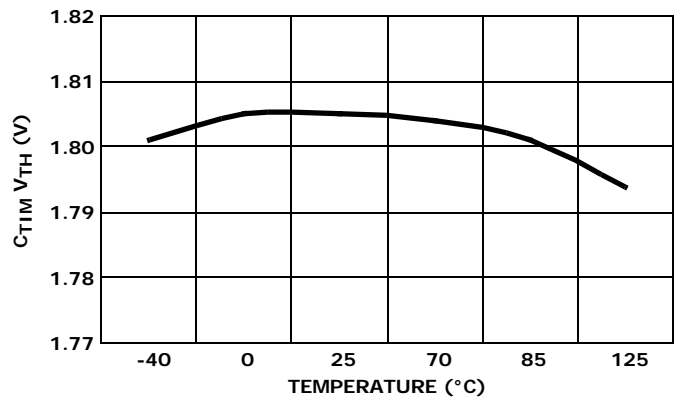

FIGURE 5. C<sub>TIM</sub> OC VOLTAGE THRESHOLD

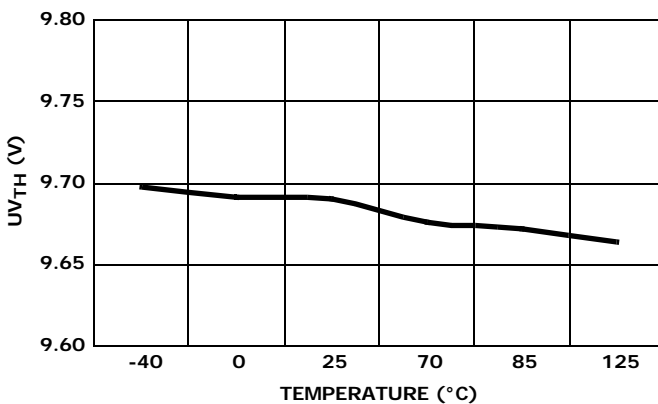

FIGURE 6. UV THRESHOLD

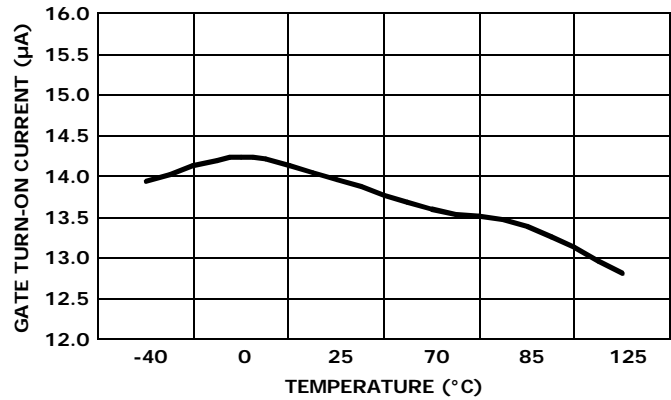

FIGURE 7. GATE CHARGE CURRENT

## Typical Performance Curves (Continued)

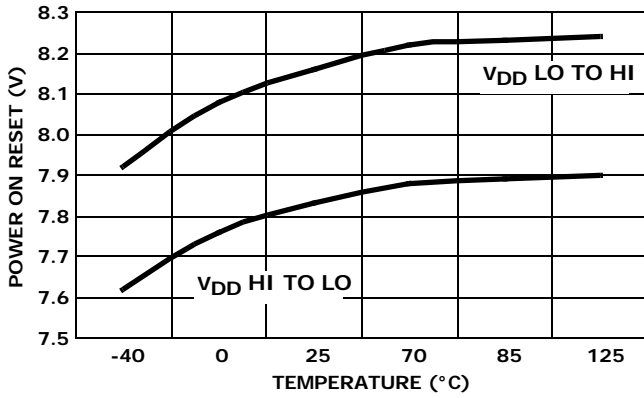

FIGURE 8. POWER-ON RESET VOLTAGE THRESHOLD

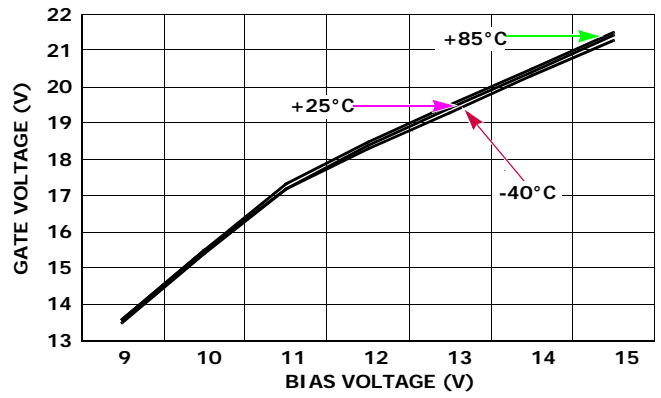

FIGURE 9. GATE VOLTAGE vs BIAS and TEMPERATURE

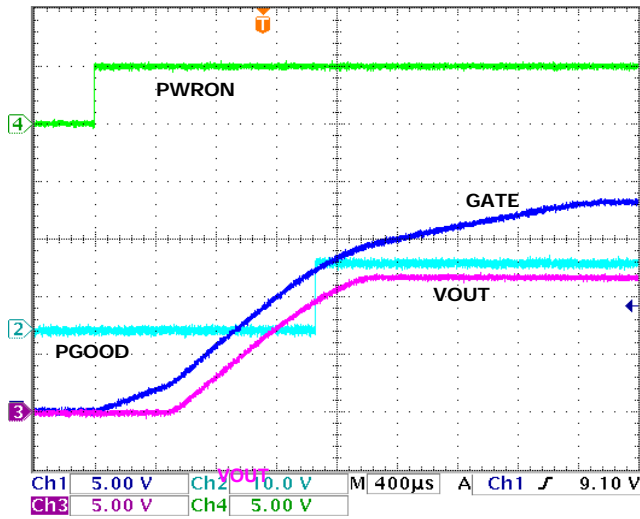

FIGURE 10. ISL6115A TURN-ON

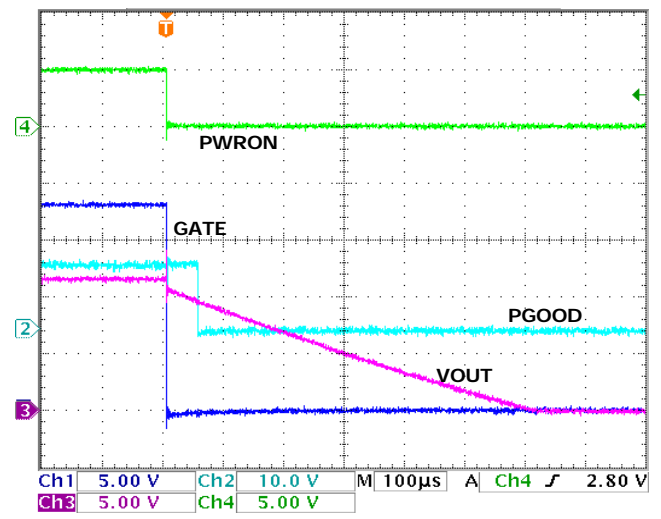

FIGURE 11. ISL6115A TURN-OFF

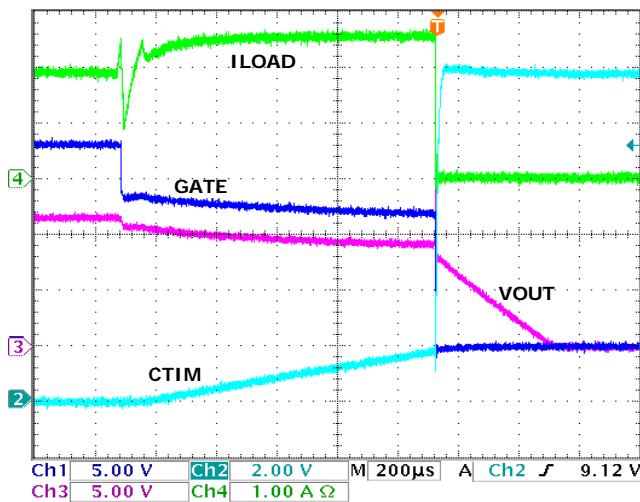

FIGURE 12. IOC REGULATION and TURN-OFF

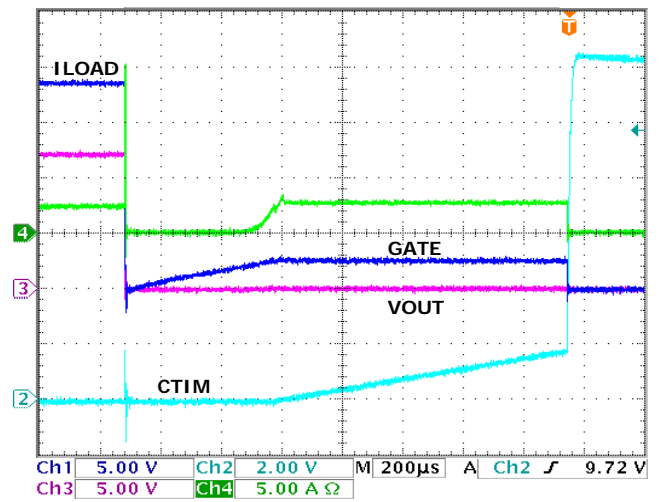

FIGURE 13. WOC TURN-OFF and RESTART



## ISL6115AEVAL1Z Board

The ISL6115AEVAL1Z is default provided as a +12V high side switch controller with the CR level set at ~2.5A. See Figure 11 for ISL6115AEVAL1Z schematic and Table 3 for BOM. Bias and load connection points are provided along with test points for each IC pin.

With J1 installed the ISL6115A will be biased from the +12V supply ( $V_{IN}$ ) being switched. Connect the load to VLOAD+. PWRON pin pulls high internally enabling the ISL6115A if not driven low via PWRON test point or J2.

With  $R_3 = 1.24k\Omega$  the CR  $V_{th}$  is set to 24.8mV and with the 10m $\Omega$  sense resistor ( $R_1$ ) the ISL6115AEVAL1Z has a nominal CR level of 2.5~A. The 0.01 $\mu$ F delay time to latch-off capacitor results in a nominal 1ms before latch-off of output after an OC event.

Reconfiguring the ISL6115AEVAL1Z board for a higher CR level can be done by changing the  $R_{SENSE}$  and/or  $R_{ISET}$  resistor values as the provided FET is rated for a much higher current.

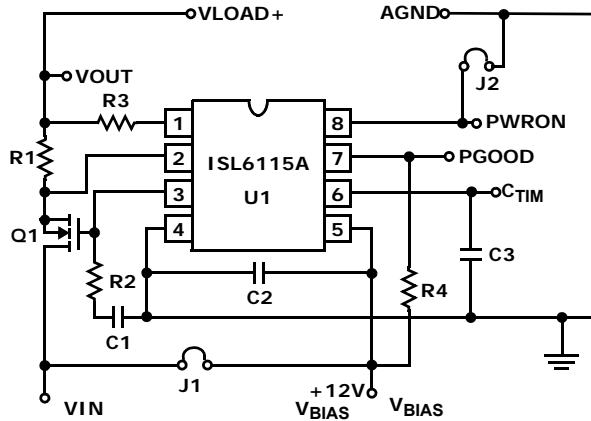
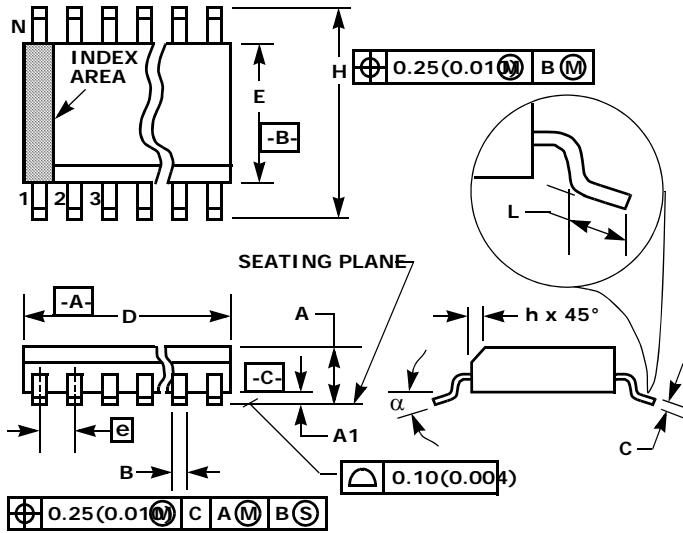

FIGURE 14. ISL6115AEVAL1Z HIGH SIDE SWITCH APPLICATION and PHOTOGRAPH

TABLE 3. BILL OF MATERIALS, ISL6115AEVAL1Z

COMPONENT DESIGNATOR	COMPONENT NAME	COMPONENT DESCRIPTION
U1	ISL6115A	Intersil
Q1	N-FET	11.5m $\Omega$ , 30V, 11.5A Logic Level N-Channel Power MOSFET or equivalent
R1	Load Current Sense Resistor	WSL-2512 10m $\Omega$ 1W Metal Strip Resistor
R2	Gate Stability Resistor	20 $\Omega$ 0603 Chip Resistor
R3	Overcurrent Voltage Threshold Set Resistor	1.24k $\Omega$ 0603 Chip Resistor ( $V_{th} = 24.8mV$ )
R4	PGOOD Pull up Resistor	10k $\Omega$ 0603 Chip Resistor
C1	Gate Timing Capacitor	0.001 $\mu$ F 0402 Chip Capacitor (<2ms)
C2	IC Decoupling Capacitor	0.1 $\mu$ F 0402 Chip Capacitor
C3	Time Delay Set Capacitor	0.01 $\mu$ F 0402 Chip Capacitor (1ms)
J1	Bias Voltage Selection Jumper	Install if switched rail voltage is = +12V. Remove and provide separate +12V bias voltage to U2 via $V_{BIAS}$ if ISL6116, ISL6117 or ISL6120 is being evaluated.
J2	PWRON Disable	Install J2 to disable U2. Connects PWRON to GND.

**Small Outline Plastic Packages (SOIC)**



**M8.15 (JEDEC MS-012-AA ISSUE C)  
8 LEAD NARROW BODY SMALL OUTLINE PLASTIC PACKAGE**

SYMBOL	INCHES		MILLIMETERS		NOTES
	MIN	MAX	MIN	MAX	
A	0.0532	0.0688	1.35	1.75	-
A1	0.0040	0.0098	0.10	0.25	-
B	0.013	0.020	0.33	0.51	9
C	0.0075	0.0098	0.19	0.25	-
D	0.1890	0.1968	4.80	5.00	3
E	0.1497	0.1574	3.80	4.00	4
e	0.050 BSC		1.27 BSC		-
H	0.2284	0.2440	5.80	6.20	-
h	0.0099	0.0196	0.25	0.50	5
L	0.016	0.050	0.40	1.27	6
N	8		8		7
a	0°	8°	0°	8°	-

NOTES:

1. Symbols are defined in the "MO Series Symbol List" in Section 2.2 of Publication Number 95.
2. Dimensioning and tolerancing per ANSI Y14.5M-1982.
3. Dimension "D" does not include mold flash, protrusions or gate burrs. Mold flash, protrusion and gate burrs shall not exceed 0.15mm (0.006 inch) per side.
4. Dimension "E" does not include interlead flash or protrusions. Interlead flash and protrusions shall not exceed 0.25mm (0.010 inch) per side.
5. The chamfer on the body is optional. If it is not present, a visual index feature must be located within the crosshatched area.
6. "L" is the length of terminal for soldering to a substrate.
7. "N" is the number of terminal positions.
8. Terminal numbers are shown for reference only.
9. The lead width "B", as measured 0.36mm (0.014 inch) or greater above the seating plane, shall not exceed a maximum value of 0.61mm (0.024 inch).
10. Controlling dimension: MILLIMETER. Converted inch dimensions are not necessarily exact.

Rev. 1 6/05

© Copyright Intersil Americas LLC 2009-2010. All Rights Reserved.  
All trademarks and registered trademarks are the property of their respective owners.

For additional products, see [www.intersil.com/en/products.html](http://www.intersil.com/en/products.html)

Intersil products are manufactured, assembled and tested utilizing ISO9001 quality systems as noted in the quality certifications found at [www.intersil.com/en/support/qualandreliability.html](http://www.intersil.com/en/support/qualandreliability.html)

*Intersil products are sold by description only. Intersil may modify the circuit design and/or specifications of products at any time without notice, provided that such modification does not, in Intersil's sole judgment, affect the form, fit or function of the product. Accordingly, the reader is cautioned to verify that datasheets are current before placing orders. Information furnished by Intersil is believed to be accurate and reliable. However, no responsibility is assumed by Intersil or its subsidiaries for its use; nor for any infringements of patents or other rights of third parties which may result from its use. No license is granted by implication or otherwise under any patent or patent rights of Intersil or its subsidiaries.*

For information regarding Intersil Corporation and its products, see [www.intersil.com](http://www.intersil.com)