

**ISL70419SEH, ISL73419SEH**

Radiation Hardened 36V Quad Precision Low Power Operational Amplifiers with Enhanced SET Performance

FN8653  
Rev.3.00  
Nov 21, 2019

The [ISL70419SEH](#) and [ISL73419SEH](#) contain four very high precision amplifiers featuring the perfect combination of low noise vs power consumption. Low offset voltage, low I<sub>BIAS</sub> current, and low temperature drift make it the ideal choice for applications requiring both high DC accuracy and AC performance. The combination of high precision, low noise, low power, and small footprint provides the user with outstanding value and flexibility relative to similar competitive parts.

Applications for these amplifiers include precision active filters, medical and analytical instrumentation, precision power supply controls, and industrial controls.

The ISL7x419SEH are offered in a 14 Ld hermetic ceramic flatpack package. These devices are offered in an industry standard pin configuration and operate across the extended temperature range from -55°C to +125°C.

**Applications**

- Precision instrumentation
- Spectral analysis equipment
- Active filter blocks
- Thermocouples and RTD reference buffers
- Data acquisition
- Power supply control

**Features**

- Electrically screened to DLA SMD# [5962-14226](#)
- Low input offset voltage. . . . . ±110µV, Max.
- Superb offset temperature coefficient. . . . . 1µV/°C, Max.
- Input bias current . . . . . ±15nA, Max.
- Input bias current TC . . . . . ±5pA/°C, Max.
- Low current consumption . . . . . 440µA
- Voltage noise . . . . . 8nV/√Hz
- Wide supply range . . . . . 4.5V to 36V
- Operating temperature range. . . . . -55°C to +125°C
- ISL70419SEH radiation acceptance testing
  - High dose rate (50-300rad(Si)/s): 300krad(Si)
  - Low dose rate (10mrad(Si)/s): 50krad(Si)
- ISL73419SEH radiation acceptance testing
  - Low dose rate (10mrad(Si)/s): 50krad(Si)
- SEE hardness (see SEE report for details)
  - SEL/SEB LET<sub>TH</sub> (V<sub>S</sub> = ±18V): 86.4MeV • cm<sup>2</sup>/mg

**Related Literature**

For a full list of related documents, visit our website:

- [ISL70419SEH](#), [ISL73419SEH](#) device pages

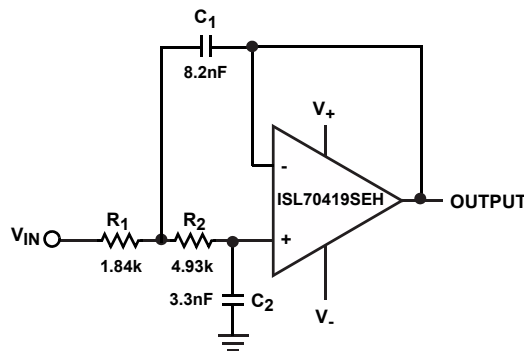

SALLEN-KEY LOW PASS FILTER (f<sub>c</sub> = 10kHz)

FIGURE 1. TYPICAL APPLICATION

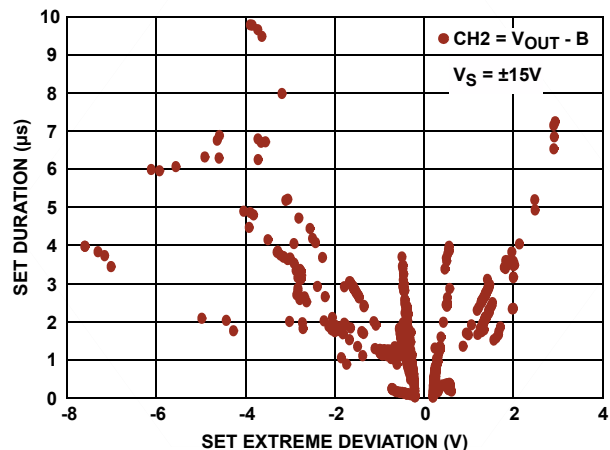

FIGURE 2. SET DEVIATION vs DURATION FOR LET = 60MeV • cm<sup>2</sup>/mg

## Ordering Information

ORDERING/ SMD NUMBER ( <a href="#">Note 2</a> )	PART NUMBER ( <a href="#">Note 1</a> )	RADIATION HARDNESS (Total Ionizing Dose)	TEMPERATURE RANGE (°C)	PACKAGE (RoHS Compliant)	PKG. DWG. #
5962F1422601VXC	ISL70419SEHVF	HDR to 300krad(Si), LDR to 50krad(Si)	-55 to +125	14 Ld Flatpack with EPAD	K14.C
5962F1422601V9AX	ISL70419SEHVX ( <a href="#">Note 3</a> )		-55 to +125	DIE	
5962L1422603VXC	ISL73419SEHVF	LDR to 50krad(Si)	-55 to +125	14 Ld Flatpack with EPAD	K14.C
5962L1422603V9A	ISL73419SEHVX ( <a href="#">Note 3</a> )		-55 to +125	DIE	
N/A	ISL70419SEHF/PROTO ( <a href="#">Note 4</a> )	N/A	-55 to +125	14 Ld Flatpack with EPAD	K14.C
N/A	ISL73419SEHF/PROTO ( <a href="#">Note 4</a> )	N/A	-55 to +125	14 Ld Flatpack with EPAD	K14.C
N/A	ISL70419SEHX/SAMPLE ( <a href="#">Notes 3, 4</a> )	N/A	-55 to +125	DIE	
N/A	ISL73419SEHX/SAMPLE ( <a href="#">Notes 3, 4</a> )	N/A	-55 to +125	DIE	
N/A	ISL70419SEHEV1Z ( <a href="#">Note 5</a> )	Evaluation Board			

### NOTES:

- These Pb-free Hermetic packaged products employ 100% Au plate - e4 termination finish, which is RoHS compliant and compatible with both SnPb and Pb-free soldering operations.
- Specifications for Rad Hard QML devices are controlled by the Defense Logistics Agency Land and Maritime (DLA). The SMD numbers listed must be used when ordering.
- Die product tested at  $T_A = +25^\circ\text{C}$ . The wafer probe test includes functional and parametric testing sufficient to make the die capable of meeting the electrical performance outlined in ["Electrical Specifications" on page 4](#).
- The /PROTO and /SAMPLE are not rated or certified for Total Ionizing Dose (TID) or Single Event Effect (SEE) immunity. These parts are intended for engineering evaluation purposes only. The /PROTO parts meet the electrical limits and conditions across temperature specified in the DLA SMD and are in the same form and fit as the qualified device. The /SAMPLE parts are capable of meeting the electrical limits and conditions specified in the DLA SMD. The /SAMPLE parts do not receive 100% screening across temperature to the DLA SMD electrical limits. These part types do not come with a Certificate of Conformance because they are not DLA qualified devices.
- Evaluation boards use the /PROTO parts and /PROTO parts are not rated or certified for Total Ionizing Dose (TID) or Single Event Effect (SEE) immunity.

# Pin Configuration

14 LD FLATPACK  
TOP VIEW

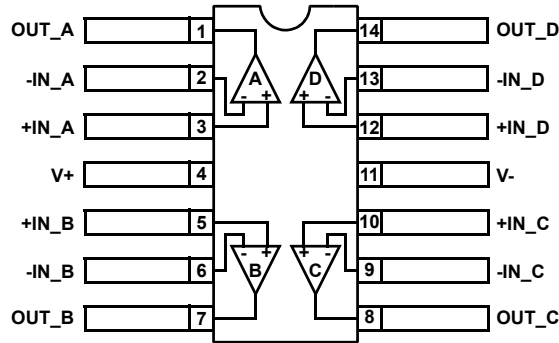

# Pin Descriptions

PIN NUMBER	PIN NAME	EQUIVALENT CIRCUIT	DESCRIPTION
1	OUT_A	Circuit 2	Amplifier A output
2	-IN_A	Circuit 1	Amplifier A inverting input
3	+IN_A	Circuit 1	Amplifier A non-inverting input
4	V+	Circuit 3	Positive power supply
5	+IN_B	Circuit 1	Amplifier B non-inverting input
6	-IN_B	Circuit 1	Amplifier B inverting input
7	OUT_B	Circuit 2	Amplifier B output
8	OUT_C	Circuit 2	Amplifier C output
9	-IN_C	Circuit 1	Amplifier C inverting input
10	+IN_C	Circuit 1	Amplifier C non-inverting input
11	V-	Circuit 3	Negative power supply
12	+IN_D	Circuit 1	Amplifier D non-inverting input
13	-IN_D	Circuit 1	Amplifier D inverting input
14	OUT_D	Circuit 2	Amplifier D output
	EPAD	N/A	EPAD under Package (unbiased, tied to package lid)

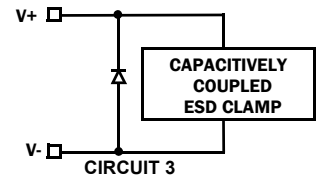
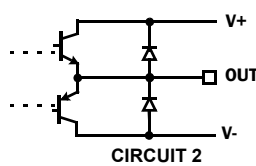
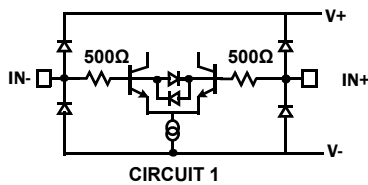

**Absolute Maximum Ratings**

Maximum Supply Voltage	42V
Maximum Supply Voltage (LET = 86.4MeV • cm <sup>2</sup> /mg)	36V
Maximum Differential Input Current	20mA
Maximum Differential Input Voltage	20V
Min/Max Input Voltage	V <sub>-</sub> - 0.5V to V <sub>+</sub> + 0.5V
Max/Min Input current for Input Voltage >V <sub>+</sub> or <V <sub>-</sub>	±20mA
Output Short-Circuit Duration (1 output at a time)	Indefinite
ESD Rating	
Human Body Model (Tested per MIL-PRF-883 3015.7)	2kV
Machine Model (Tested per EIA/JESD22-A115-A)	200V
Charged Device Model (Tested per JESD22-C101D)	750V

**Thermal Information**

Thermal Resistance (Typical)	$\theta_{JA}$ (°C/W)	$\theta_{JC}$ (°C/W)
14 Ld Flatpack (Notes 6, 7)	35	8
Maximum Storage Temperature Range	-65°C to +150°C	
Maximum Junction Temperature (T <sub>JMAX</sub> )	+150°C	

**Recommended Operating Conditions**

Ambient Operating Temperature Range	-55°C to +125°C
Maximum Operating Junction Temperature	+150°C
Supply Voltage	10V (±5V) to 30V (±15V)

**CAUTION:** Do not operate at or near the maximum ratings listed for extended periods of time. Exposure to such conditions can adversely impact product reliability and result in failures not covered by warranty.

**NOTES:**

- $\theta_{JA}$  is measured in free air with the component mounted on a high-effective thermal conductivity test board with direct attach features. See [TB379](#).
- For  $\theta_{JC}$ , the case temperature location is the center of the package underside.

**Electrical Specifications** V<sub>S</sub> ± 15V, V<sub>CM</sub> = 0, V<sub>O</sub> = 0V, T<sub>A</sub> = +25°C, unless otherwise noted. **Boldface limits apply across the operating temperature range, -55°C to +125°C; over a total ionizing dose of 300krad(Si) with exposure at a high dose rate of 50 - 300rad(Si)/s (ISL70419SEH only); or across a total ionizing dose of 50krad(Si) with exposure at a low dose rate of <10mrads(Si)/s.**

PARAMETER	SYMBOL	TEST CONDITIONS	MIN (Note 8)	TYP	MAX (Note 8)	UNIT
Input Offset Voltage	V <sub>OS</sub>			10	85	μV
					<b>110</b>	μV
Offset Voltage Drift	TCV <sub>OS</sub>	Established by characterization not tested		0.1	<b>1</b>	μV/°C
Input Bias Current	I <sub>B</sub>		-2.5	0.08	2.5	nA
		T <sub>A</sub> = -55°C to +125°C	-5		5	nA
		Over high and low dose radiation	-15		15	nA
Input Bias Current Temperature Coefficient	TCI <sub>B</sub>	Established by characterization not tested	<b>-5</b>	<b>1</b>	<b>5</b>	pA/°C
Input Offset Current	I <sub>OS</sub>		-2.5	0.08	2.5	nA
		T <sub>A</sub> = -55°C to +125°C	-3		3	nA
		Over high and low dose radiation	-10		10	nA
Input Offset Current Temperature Coefficient	TCI <sub>OS</sub>	Established by characterization not tested	<b>-3</b>	<b>0.42</b>	<b>3</b>	pA/°C
Input Voltage Range	V <sub>CM</sub>	Established by CMRR test	<b>-13</b>		<b>13</b>	V
Common-Mode Rejection Ratio	CMRR	V <sub>CM</sub> = -13V to +13V	120	145		dB
			<b>120</b>			dB
Power Supply Rejection Ratio	PSRR	V <sub>S</sub> = ±2.25V to ±20V	120	145		dB
			<b>120</b>			dB
Open-Loop Gain	A <sub>VOL</sub>	V <sub>O</sub> = -13V to +13V, R <sub>L</sub> = 10kΩ to ground	3,000	14,000		V/mV
Output Voltage High	V <sub>OH</sub>	R <sub>L</sub> = 10kΩ to ground	13.5	13.7		V
			<b>13.2</b>			V
		R <sub>L</sub> = 2kΩ to ground	13.3	13.55		V
			<b>13.0</b>			V

**Electrical Specifications**  $V_S \pm 15V$ ,  $V_{CM} = 0$ ,  $V_O = 0V$ ,  $T_A = +25^\circ C$ , unless otherwise noted. **Boldface limits apply across the operating temperature range,  $-55^\circ C$  to  $+125^\circ C$ ; over a total ionizing dose of 300krad(Si) with exposure at a high dose rate of 50 - 300rad(Si)/s (ISL70419SEH only); or across a total ionizing dose of 50krad(Si) with exposure at a low dose rate of  $<10$ mrad(Si)/s. (Continued)**

PARAMETER	SYMBOL	TEST CONDITIONS	MIN (Note 8)	TYP	MAX (Note 8)	UNIT
Output Voltage Low	$V_{OL}$	$R_L = 10k\Omega$ to ground		-13.7	-13.5	V
					<b>-13.2</b>	V
	$R_L = 2k\Omega$ to ground		-13.55	-13.3	V	
				<b>-13.0</b>	V	
Supply Current/Amplifier	$I_S$			0.44	0.625	mA
					<b>0.75</b>	mA
Short-Circuit Current	$I_{SC}$			43		mA
Supply Voltage Range	$V_{SUPPLY}$	Established by PSRR	<b><math>\pm 2.25</math></b>		<b><math>\pm 20</math></b>	V
<b>AC SPECIFICATIONS</b>						
Gain Bandwidth Product	GBWP	$A_V = 1k$ , $R_L = 2k\Omega$		1.5		MHz
Voltage Noise $V_{P-P}$	$e_{nV_{P-P}}$	0.1Hz to 10Hz		0.25		$\mu V_{P-P}$
Voltage Noise Density	$e_n$	$f = 10Hz$		10		$nV/\sqrt{Hz}$
Voltage Noise Density	$e_n$	$f = 100Hz$		8.2		$nV/\sqrt{Hz}$
Voltage Noise Density	$e_n$	$f = 1kHz$		8		$nV/\sqrt{Hz}$
Voltage Noise Density	$e_n$	$f = 10kHz$		8		$nV/\sqrt{Hz}$
Current Noise Density	$i_n$	$f = 1kHz$		0.1		$pA/\sqrt{Hz}$
Total Harmonic Distortion	THD + N	1kHz, $G = 1$ , $V_O = 3.5V_{RMS}$ , $R_L = 2k\Omega$		0.0009		%
		1kHz, $G = 1$ , $V_O = 3.5V_{RMS}$ , $R_L = 10k\Omega$		0.0005		%
<b>TRANSIENT RESPONSE</b>						
Slew Rate, $V_{OUT}$ 20% to 80%	SR	$A_V = 11$ , $R_L = 2k\Omega$ , $V_O = 4V_{P-P}$	0.3	0.5		$V/\mu s$
			<b>0.2</b>			$V/\mu s$
Rise Time 10% to 90% of $V_{OUT}$	$t_r$ , $t_f$ , small signal	$A_V = 1$ , $V_{OUT} = 50mV_{P-P}$ , $R_L = 10k\Omega$ to $V_{CM}$		130	450	ns
					<b>625</b>	ns
Fall Time 90% to 10% of $V_{OUT}$		$A_V = 1$ , $V_{OUT} = 50mV_{P-P}$ , $R_L = 10k\Omega$ to $V_{CM}$		130	600	ns
					<b>700</b>	ns
Settling Time to 0.1% 10V Step; 10% to $V_{OUT}$	$t_s$	$A_V = -1$ , $V_{OUT} = 10V_{P-P}$ , $R_L = 5k\Omega$ to $V_{CM}$		21		$\mu s$
				24		$\mu s$
Settling Time to 0.01% 10V Step; 10% to $V_{OUT}$		$A_V = -1$ , $V_{OUT} = 10V_{P-P}$ , $R_L = 5k\Omega$ to $V_{CM}$		13		$\mu s$
				18		$\mu s$
Output Positive Overload Recovery Time	$t_{OL}$	$A_V = -100$ , $V_{IN} = 0.2V_{P-P}$ , $R_L = 2k\Omega$ to $V_{CM}$		5.6		$\mu s$
Output Negative Overload Recovery Time				10.6		$\mu s$
Positive Overshoot	OS+	$A_V = 1$ , $V_{OUT} = 10V_{P-P}$ , $R_f = 0\Omega$ , $R_L = 2k\Omega$ to $V_{CM}$		15		%
					<b>33</b>	%
Negative Overshoot	OS-	$A_V = 1$ , $V_{OUT} = 10V_{P-P}$ , $R_f = 0\Omega$ , $R_L = 2k\Omega$ to $V_{CM}$		15		%
					<b>33</b>	%

**Electrical Specifications**  $V_S \pm 5V$ ,  $V_{CM} = 0$ ,  $V_O = 0V$ ,  $T_A = +25^\circ C$ , unless otherwise noted. **Boldface limits apply over the operating temperature range,  $-55^\circ C$  to  $+125^\circ C$ ; over a total ionizing dose of 300krad(Si) with exposure at a high dose rate of 50 - 300krad(Si)/s (ISL70419SEH only); or over a total ionizing dose of 50krad(Si) with exposure at a low dose rate of  $<10$ mrad(Si)/s.**

PARAMETER	SYMBOL	CONDITIONS	MIN (Note 8)	TYP	MAX (Note 8)	UNIT
Input Offset Voltage	$V_{OS}$			10	150	$\mu V$
					<b>250</b>	$\mu V$
Offset Voltage Drift	$TCV_{OS}$	Established by characterization not tested		0.1	<b>1</b>	$\mu V/^\circ C$
Input Bias Current	$I_B$		-2.5	0.08	2.5	nA
		$T_A = -55^\circ C$ to $+125^\circ C$	-5		5	nA
		Over high and low dose radiation	-15		15	nA
Input Bias Current Temperature Coefficient	$TCI_B$	Established by characterization not tested	<b>-5</b>	<b>1</b>	<b>5</b>	$\mu A/^\circ C$
Input Offset Current	$I_{OS}$		-2.5	0.08	2.5	nA
		$T_A = -55^\circ C$ to $+125^\circ C$	-3		3	nA
		Over high and low dose radiation	-10		10	nA
Input Offset Current Temperature Coefficient	$TCI_{OS}$	Established by characterization not tested	<b>-3</b>	<b>0.42</b>	<b>3</b>	$\mu A/^\circ C$
Input Voltage Range	$V_{CM}$	Established by CMRR test	<b>-3</b>		<b>3</b>	V
Common-Mode Rejection Ratio	CMRR	$V_{CM} = -3V$ to $+3V$	120	145		dB
			<b>120</b>			dB
Power Supply Rejection Ratio	PSRR	$V_S = \pm 2.25V$ to $\pm 5V$	120	145		dB
			<b>120</b>			dB
Open-Loop Gain	$A_{VOL}$	$V_O = -3.0V$ to $+3.0V$ $R_L = 10k\Omega$ to ground	3000	14000		V/mV
Output Voltage High	$V_{OH}$	$R_L = 10k\Omega$ to ground	3.5	3.7		V
			<b>3.2</b>			V
		$R_L = 2k\Omega$ to ground	3.3	3.55		V
			<b>3.0</b>			V
Output Voltage Low	$V_{OL}$	$R_L = 10k\Omega$ to ground		-3.7	-3.5	V
					<b>-3.2</b>	V
		$R_L = 2k\Omega$ to ground		-3.55	-3.3	V
					<b>-3.0</b>	V
Supply Current/Amplifier	$I_S$			0.44	0.625	mA
					<b>0.75</b>	mA
Short-Circuit Current	$I_{SC}$			43		mA
<b>AC SPECIFICATIONS</b>						
Gain Bandwidth Product	GBWP	$A_V = 1k$ , $R_L = 2k\Omega$		1.5		MHz
Voltage Noise	$e_{np-p}$	0.1Hz to 10Hz		0.25		$\mu V_{P-P}$
Voltage Noise Density	$e_n$	$f = 10Hz$		12		$nV/\sqrt{Hz}$
Voltage Noise Density	$e_n$	$f = 100Hz$		8.6		$nV/\sqrt{Hz}$
Voltage Noise Density	$e_n$	$f = 1kHz$		8		$nV/\sqrt{Hz}$
Voltage Noise Density	$e_n$	$f = 10kHz$		8		$nV/\sqrt{Hz}$
Current Noise Density	$i_n$	$f = 1kHz$		0.1		$\mu A/\sqrt{Hz}$

**Electrical Specifications**  $V_S \pm 5V$ ,  $V_{CM} = 0$ ,  $V_O = 0V$ ,  $T_A = +25^\circ C$ , unless otherwise noted. **Boldface limits apply over the operating temperature range,  $-55^\circ C$  to  $+125^\circ C$ ; over a total ionizing dose of 300krad(Si) with exposure at a high dose rate of 50 - 300krad(Si)/s (ISL70419SEH only); or over a total ionizing dose of 50krad(Si) with exposure at a low dose rate of  $<10$ mrad(Si)/s. (Continued)**

PARAMETER	SYMBOL	CONDITIONS	MIN (Note 8)	TYP	MAX (Note 8)	UNIT
<b>TRANSIENT RESPONSE</b>						
Slew Rate, $V_{OUT}$ 20% to 80%	SR	$A_V = 11$ , $R_L = 2k\Omega$ , $V_O = 4V_{P-P}$		0.5		V/ $\mu$ s
Rise Time 10% to 90% of $V_{OUT}$	$t_r$ , $t_f$ small signal	$A_V = 1$ , $V_{OUT} = 50mV_{P-P}$ , $R_L = 10k\Omega$ to $V_{CM}$		130		ns
Fall Time 90% to 10% of $V_{OUT}$		$A_V = 1$ , $V_{OUT} = 50mV_{P-P}$ , $R_L = 10k\Omega$ to $V_{CM}$		130		ns
Settling Time to 0.1% 4V Step; 10% to $V_{OUT}$	$t_s$	$A_V = -1$ , $V_{OUT} = 4V_{P-P}$ , $R_L = 5k\Omega$ to $V_{CM}$		12		$\mu$ s
Settling Time to 0.01% 4V Step; 10% to $V_{OUT}$		$A_V = -1$ , $V_{OUT} = 4V_{P-P}$ , $R_L = 5k\Omega$ to $V_{CM}$		19		$\mu$ s
Output Positive Overload Recovery Time	$t_{OL}$	$A_V = -100$ , $V_{IN} = 0.2V_{P-P}$ $R_L = 2k\Omega$ to $V_{CM}$		7		$\mu$ s
Output Negative Overload Recovery Time		$A_V = -100$ , $V_{IN} = 0.2V_{P-P}$ $R_L = 2k\Omega$ to $V_{CM}$		5.8		$\mu$ s
Positive Overshoot	OS+	$A_V = 1$ , $V_{OUT} = 10V_{P-P}$ , $R_f = 0\Omega$ $R_L = 2k\Omega$ to $V_{CM}$		15		%
Negative Overshoot	OS-	$A_V = 1$ , $V_{OUT} = 10V_{P-P}$ , $R_f = 0\Omega$ $R_L = 2k\Omega$ to $V_{CM}$		15		%

## NOTE:

8. Compliance to datasheet limits is assured by one or more methods: production test, characterization, and/or design.

# Typical Performance Curves

$V_S = \pm 15V$ ,  $V_{CM} = 0V$ ,  $R_L = \text{Open}$ ,  $T_A = +25^\circ C$ , unless otherwise specified.

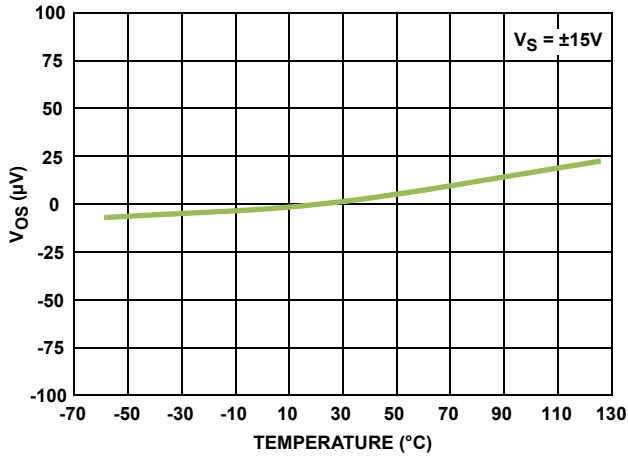

FIGURE 3.  $V_{OS}$  vs TEMPERATURE

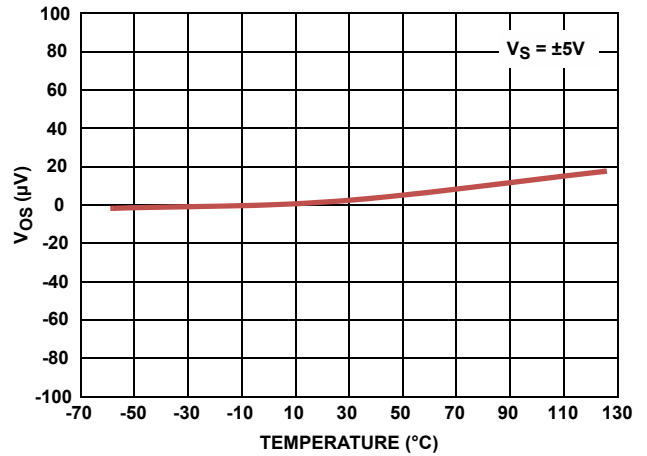

FIGURE 4.  $V_{OS}$  vs TEMPERATURE

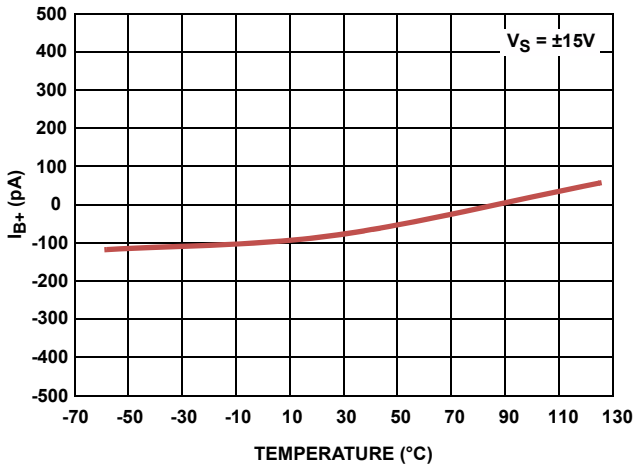

FIGURE 5.  $I_{B+}$  vs TEMPERATURE

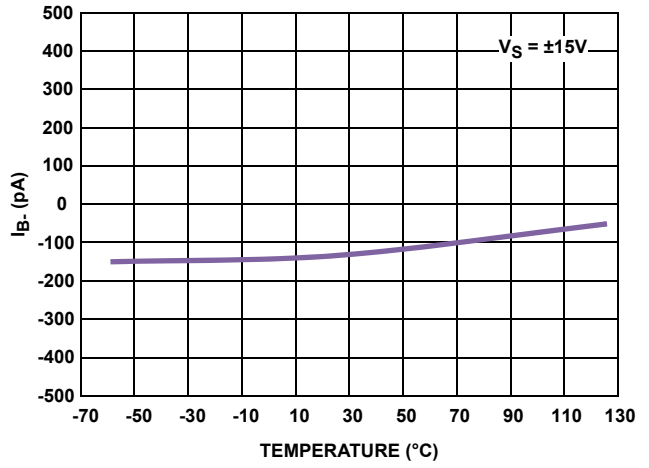

FIGURE 6.  $I_{B-}$  vs TEMPERATURE

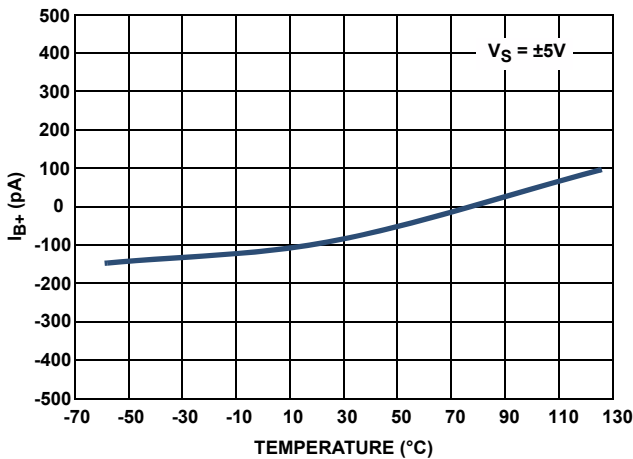

FIGURE 7.  $I_{B+}$  vs TEMPERATURE

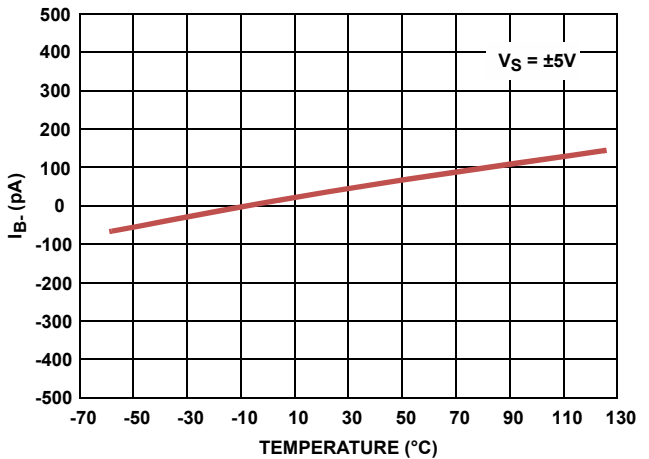

FIGURE 8.  $I_{B-}$  vs TEMPERATURE



**Typical Performance Curves**  $V_S = \pm 15V$ ,  $V_{CM} = 0V$ ,  $R_L = \text{Open}$ ,  $T_A = +25^\circ C$ , unless otherwise specified. **(Continued)**

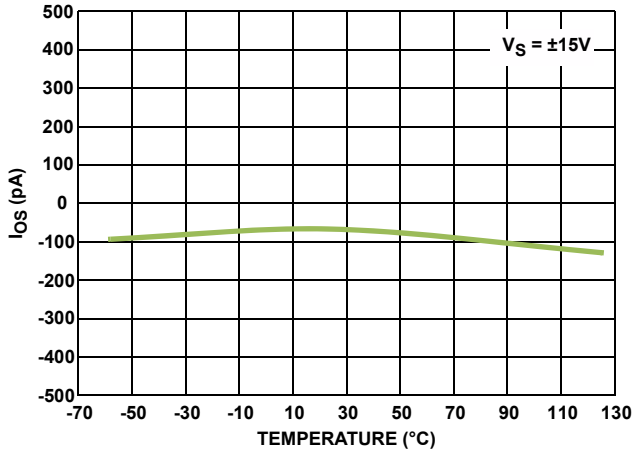

FIGURE 9.  $I_{OS}$  vs TEMPERATURE

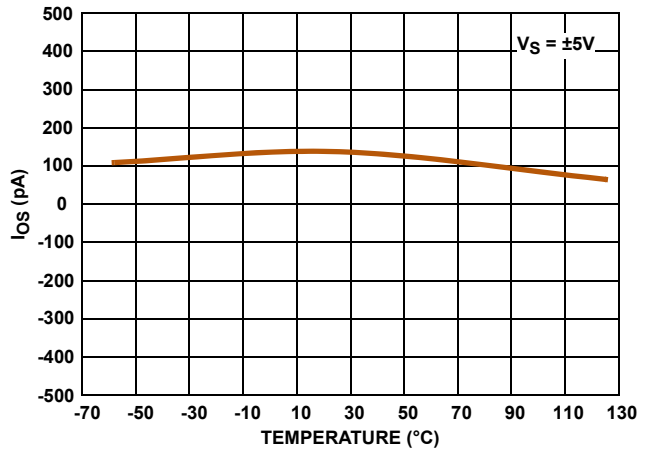

FIGURE 10.  $I_{OS}$  vs TEMPERATURE

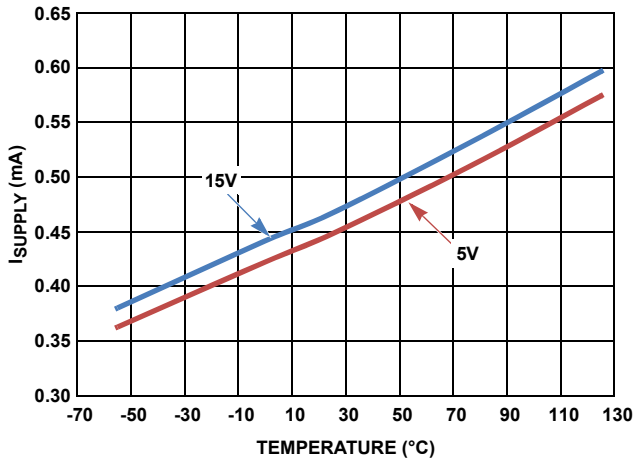

FIGURE 11. SUPPLY CURRENT PER AMP vs TEMPERATURE

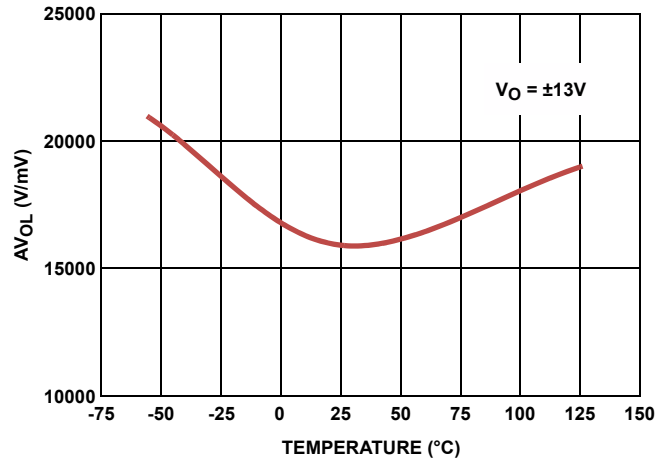

FIGURE 12.  $AV_{OL}$  vs TEMPERATURE

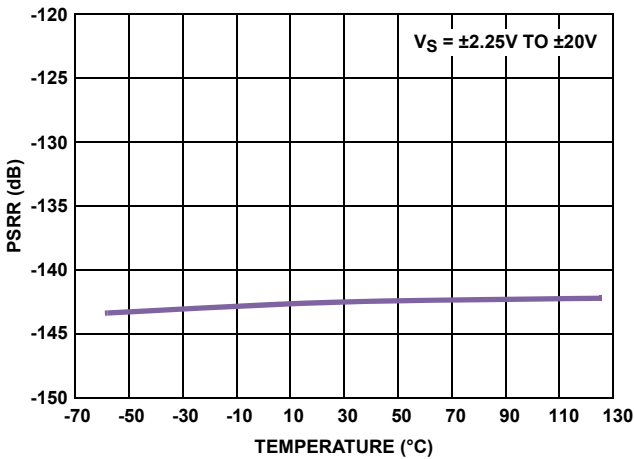

FIGURE 13. PSRR vs TEMPERATURE

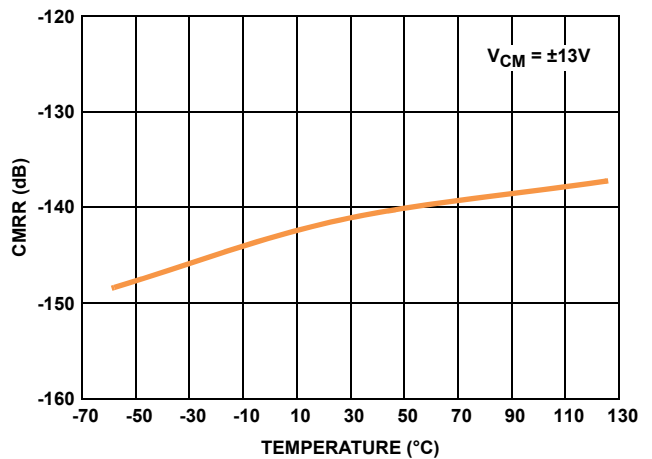

FIGURE 14. CMRR vs TEMPERATURE

**Typical Performance Curves**  $V_S = \pm 15V$ ,  $V_{CM} = 0V$ ,  $R_L = \text{Open}$ ,  $T_A = +25^\circ C$ , unless otherwise specified. **(Continued)**

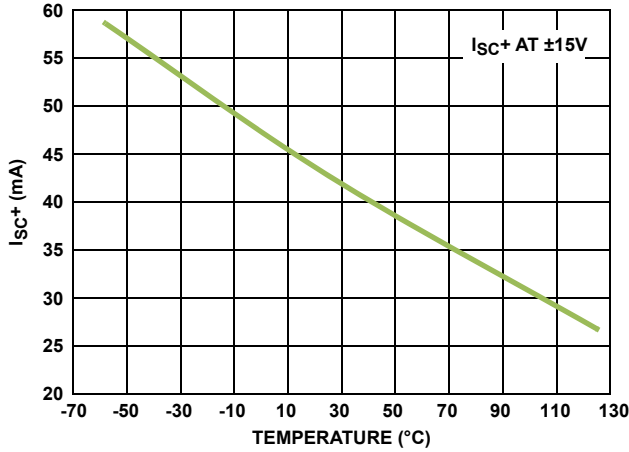

FIGURE 15. SHORT CIRCUIT CURRENT vs TEMPERATURE

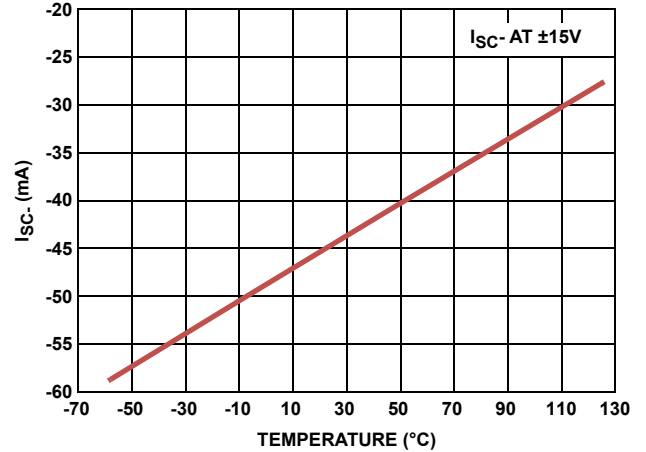

FIGURE 16. SHORT CIRCUIT CURRENT vs TEMPERATURE

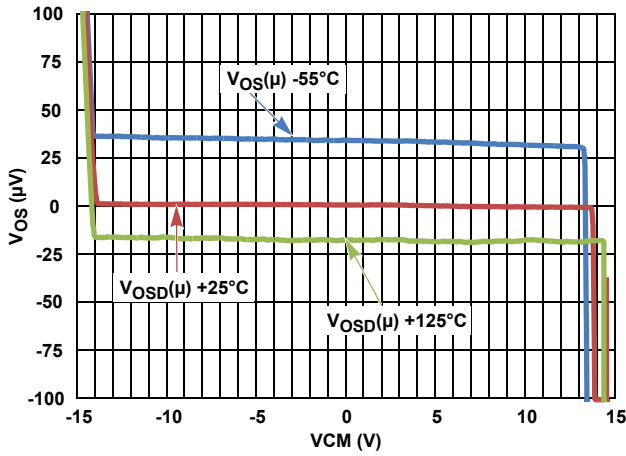

FIGURE 17. INPUT  $V_{OS}$  vs INPUT COMMON MODE VOLTAGE,  $V_S = \pm 15V$

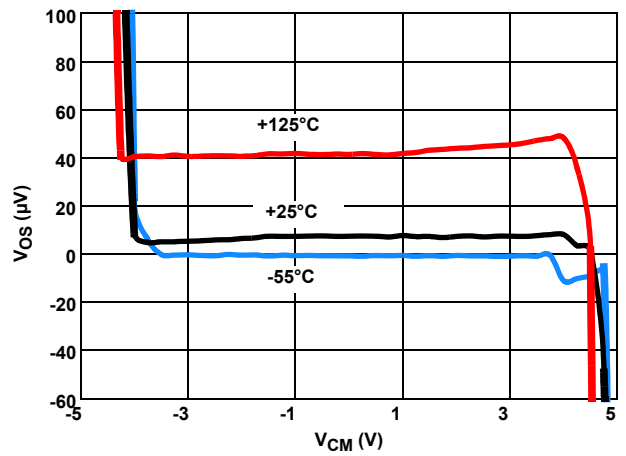

FIGURE 18. INPUT  $V_{OS}$  vs INPUT COMMON MODE VOLTAGE,  $V_S = \pm 5V$

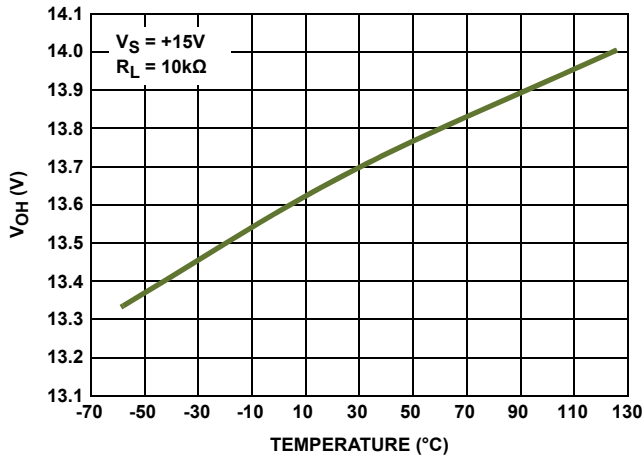

FIGURE 19.  $V_{OH}$  vs TEMPERATURE

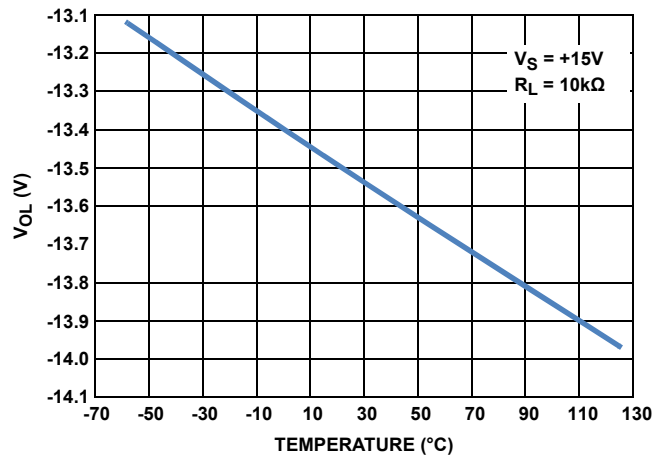

FIGURE 20.  $V_{OL}$  vs TEMPERATURE

**Typical Performance Curves**  $V_S = \pm 15V$ ,  $V_{CM} = 0V$ ,  $R_L = \text{Open}$ ,  $T_A = +25^\circ C$ , unless otherwise specified. **(Continued)**

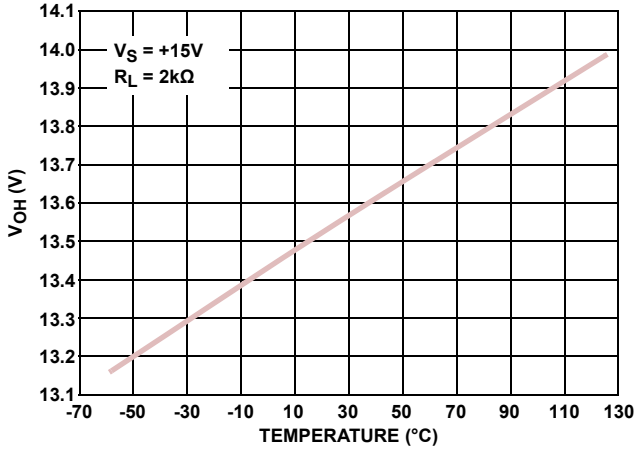

FIGURE 21.  $V_{OH}$  vs TEMPERATURE

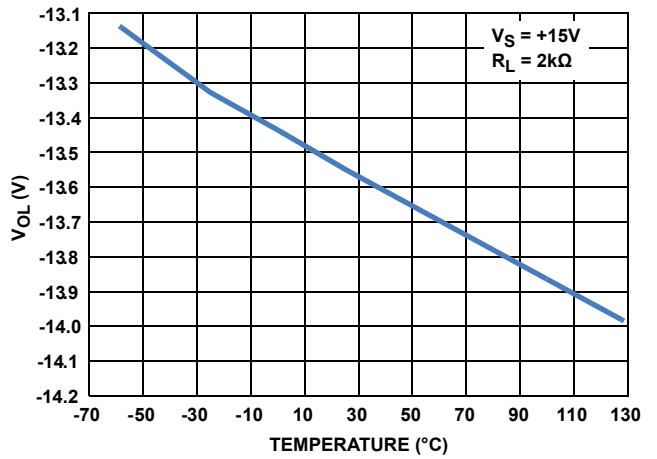

FIGURE 22.  $V_{OL}$  vs TEMPERATURE

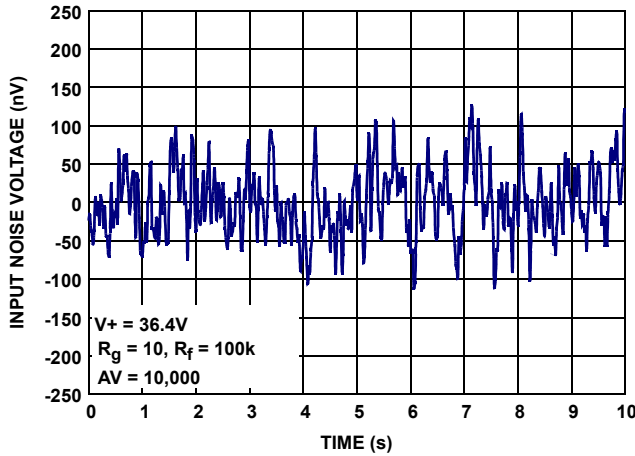

FIGURE 23. INPUT NOISE VOLTAGE 0.1Hz to 10Hz

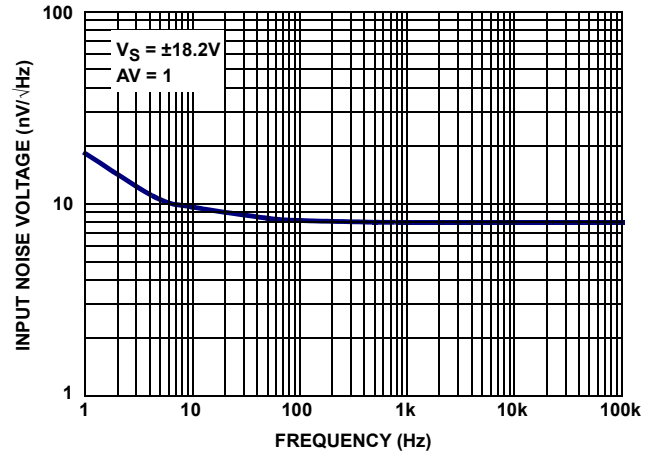

FIGURE 24. INPUT NOISE VOLTAGE SPECTRAL DENSITY

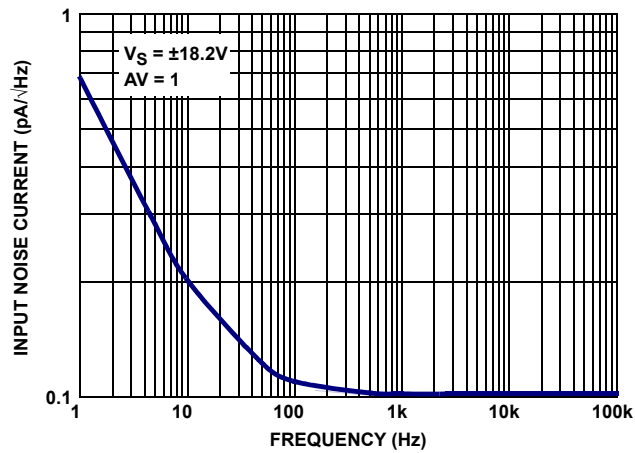

FIGURE 25. INPUT NOISE CURRENT SPECTRAL DENSITY

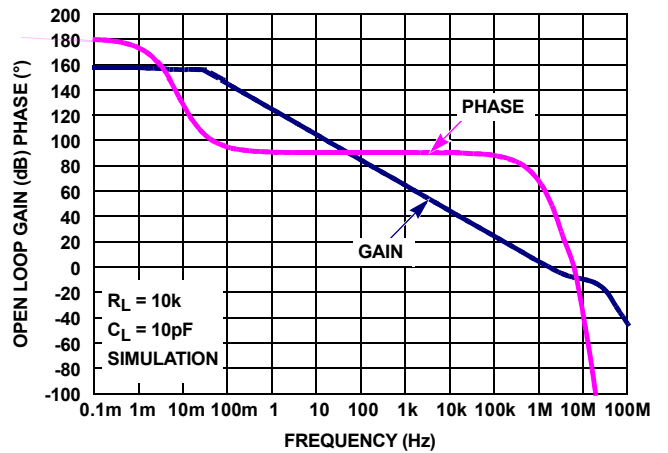

FIGURE 26. OPEN-LOOP GAIN, PHASE vs FREQUENCY,  $R_L = 10k\Omega$ ,  $C_L = 10pF$

**Typical Performance Curves**  $V_S = \pm 15V, V_{CM} = 0V, R_L = \text{Open}, T_A = +25^\circ C$ , unless otherwise specified. **(Continued)**

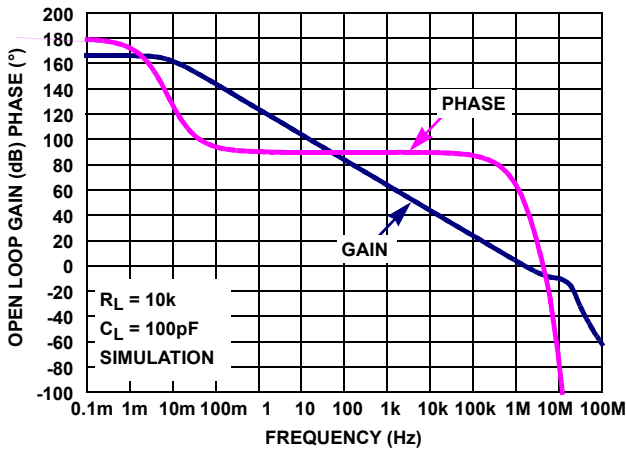

FIGURE 27. OPEN-LOOP GAIN, PHASE vs FREQUENCY,  $R_L = 10k\Omega, C_L = 100pF$

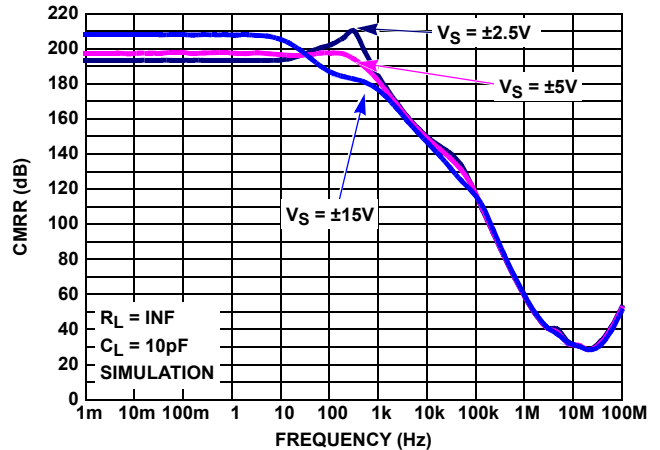

FIGURE 28. CMRR vs FREQUENCY,  $V_S = \pm 2.25, \pm 5V, \pm 15V$

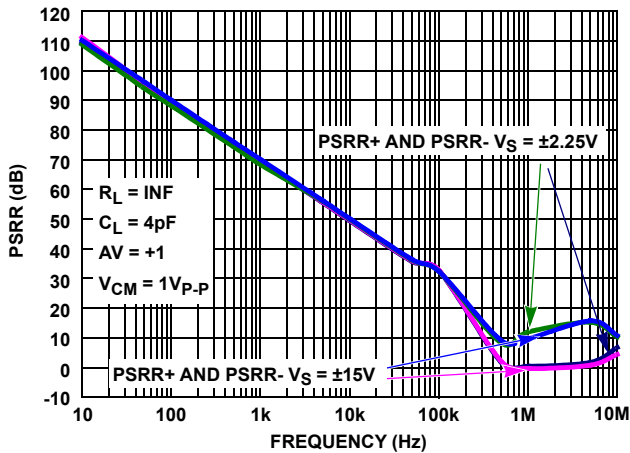

FIGURE 29. PSRR vs FREQUENCY,  $V_S = \pm 5V, \pm 15V$

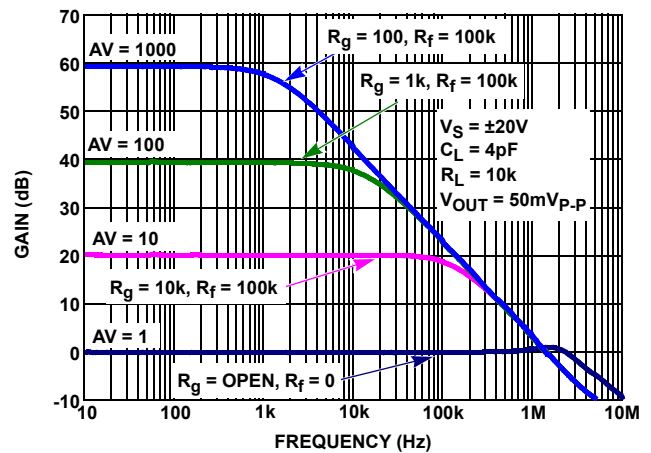

FIGURE 30. FREQUENCY RESPONSE vs CLOSED LOOP GAIN

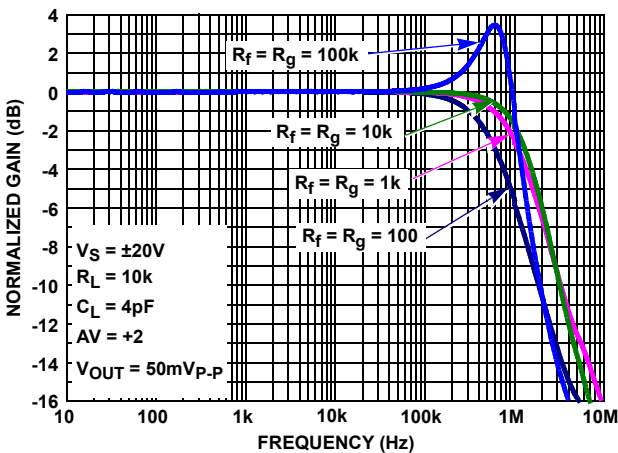

FIGURE 31. FREQUENCY RESPONSE vs FEEDBACK RESISTANCE  $R_f/R_g$

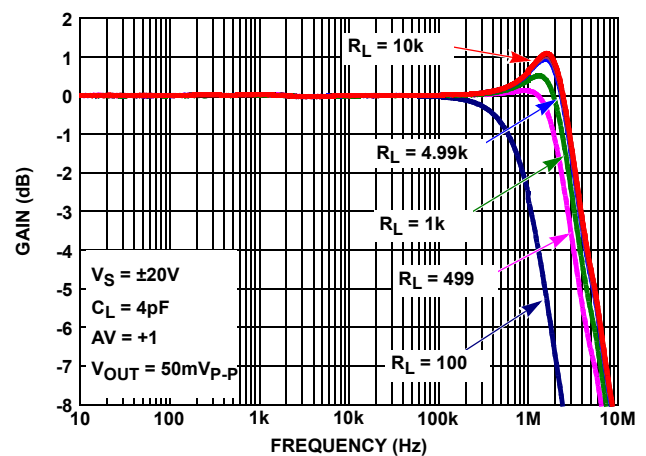

FIGURE 32. GAIN vs FREQUENCY vs  $R_L$

**Typical Performance Curves**  $V_S = \pm 15V, V_{CM} = 0V, R_L = \text{Open}, T_A = +25^\circ C$ , unless otherwise specified. **(Continued)**

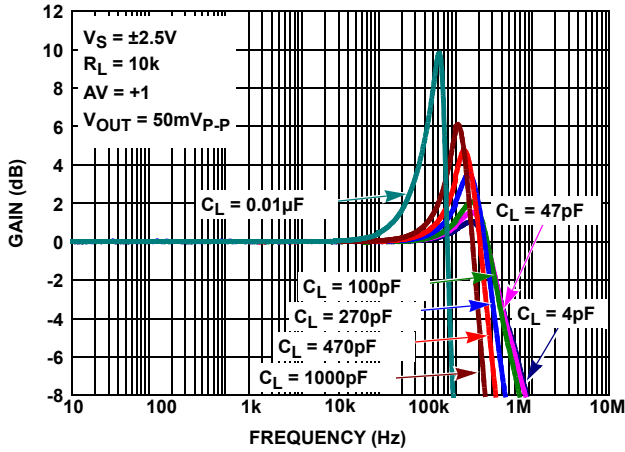

FIGURE 33. GAIN vs FREQUENCY vs  $C_L$

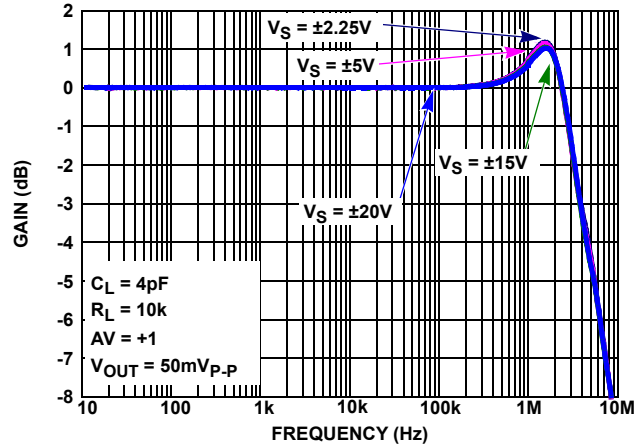

FIGURE 34. GAIN vs FREQUENCY vs SUPPLY VOLTAGE

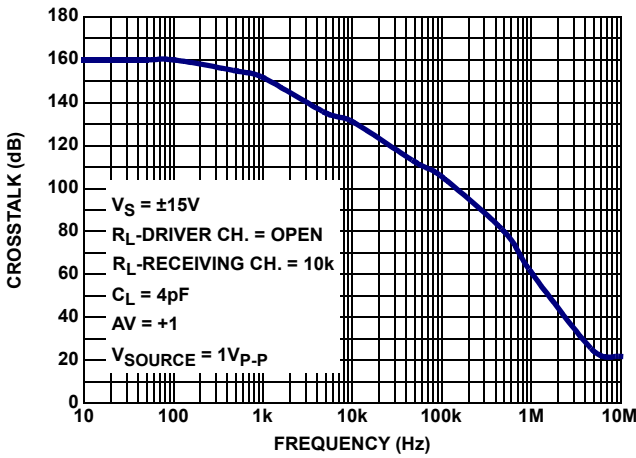

FIGURE 35. CROSSTALK,  $V_S = \pm 15V$

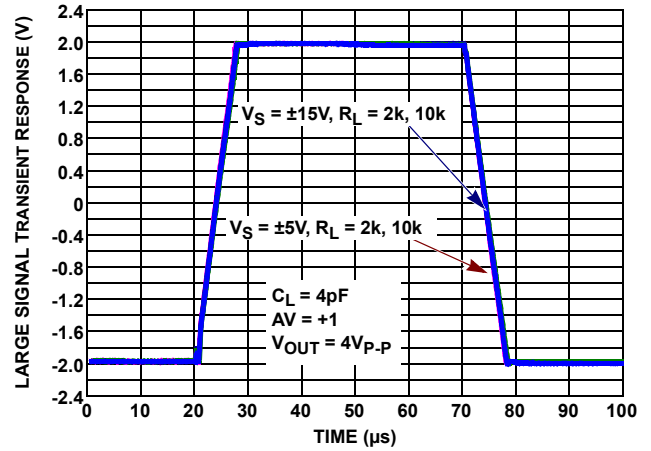

FIGURE 36. LARGE SIGNAL TRANSIENT RESPONSE vs  $R_L, V_S = \pm 5V, \pm 15V$

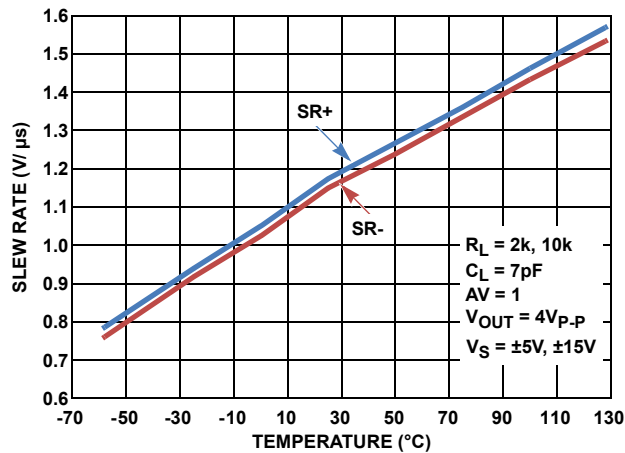

FIGURE 37. SLEW RATE vs TEMPERATURE  $V_S = \pm 5V, \pm 15V$

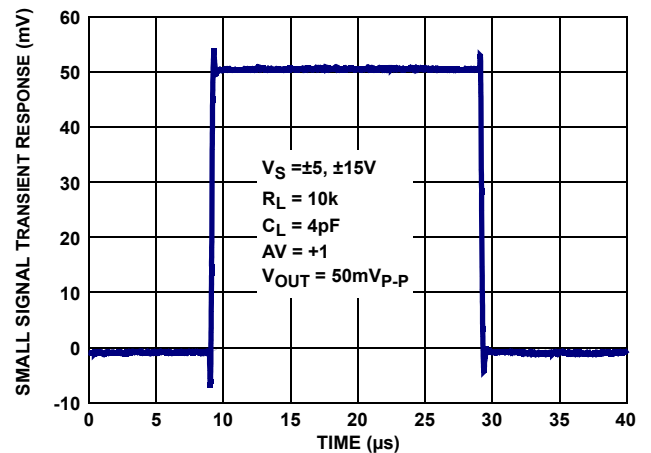
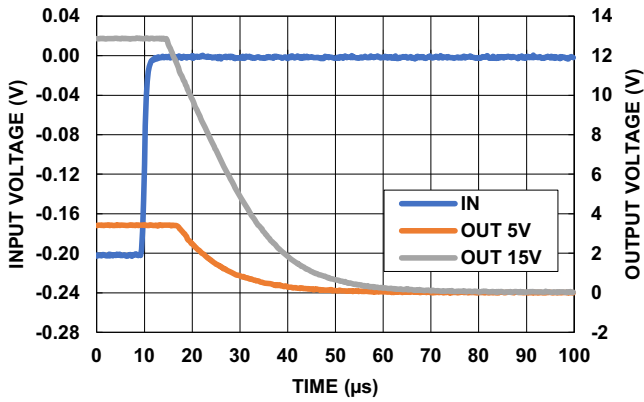
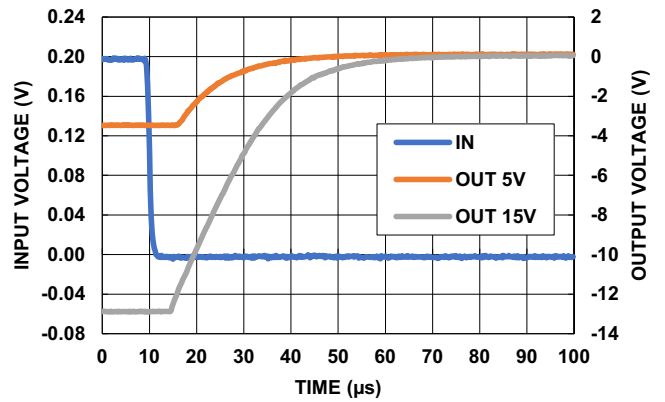

FIGURE 38. SMALL SIGNAL TRANSIENT RESPONSE,  $V_S = \pm 5V, \pm 15V$

**Typical Performance Curves**  $V_S = \pm 15V, V_{CM} = 0V, R_L = \text{Open}, T_A = +25^\circ C$ , unless otherwise specified. **(Continued)**



**FIGURE 39. POSITIVE OUTPUT OVERLOAD RESPONSE TIME,**  
 $V_S = \pm 5V, \pm 15V, R_L = 2k, C_L = 4pF, A_V = -100, R_f = 100k,$   
 $R_g = 1k, V_{IN} = 200mV_{p-p}$



**FIGURE 40. NEGATIVE OUTPUT OVERLOAD RESPONSE TIME,**  
 $V_S = \pm 5V, \pm 15V, R_L = 2k, C_L = 4pF, A_V = -100, R_f = 100k,$   
 $R_g = 1k, V_{IN} = 200mV_{p-p}$

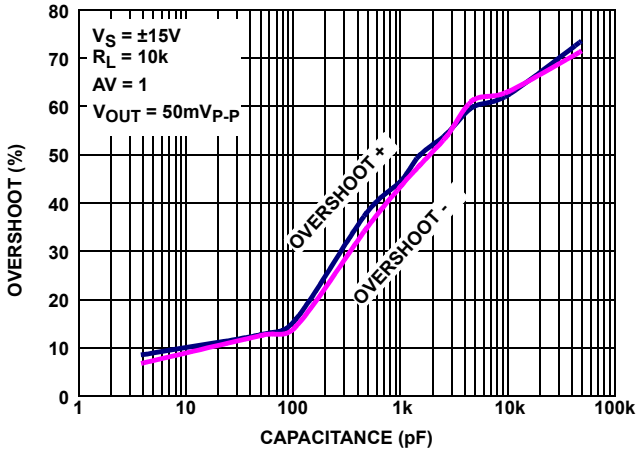

**FIGURE 41. % OVERSHOOT vs LOAD CAPACITANCE,  $V_S = \pm 15V$**

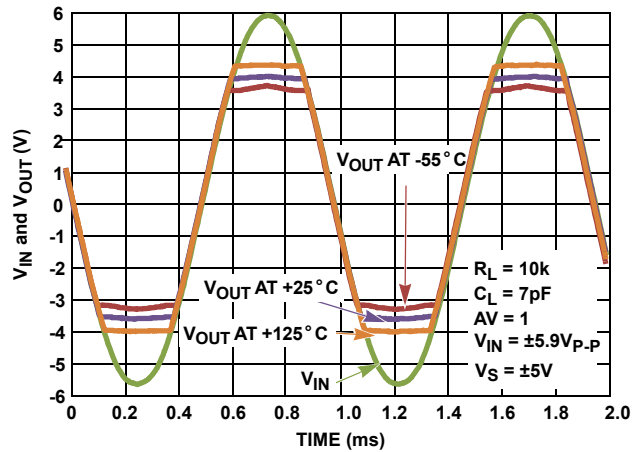

**FIGURE 42. OUTPUT PHASE REVERSAL RESPONSE vs TEMPERATURE**

**Post High Dose Radiation Characteristics** Unless otherwise specified,  $V_S \pm 15V$ ,  $V_{CM} = 0$ ,  $V_O = 0V$ ,  $T_A = +25^\circ C$ . This data is typical mean test data post radiation exposure at a high dose rate of 50 - 300rad(Si)/s. This data is intended to show typical parameter shifts due to high dose rate radiation. These are not limits nor are they guaranteed. ISL70419SEH only.

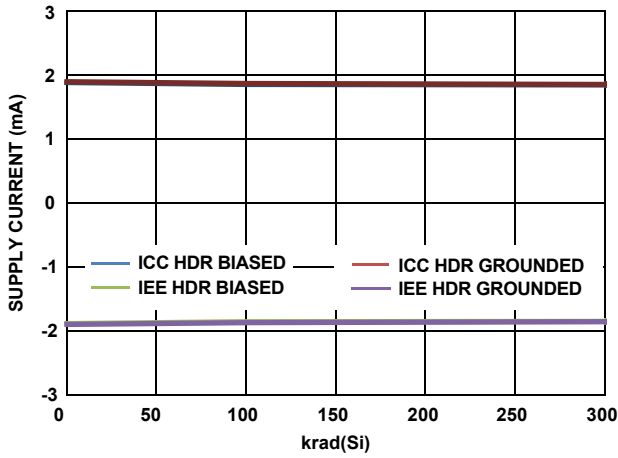

FIGURE 43. SUPPLY CURRENT vs HIGH DOSE RATE RADIATION

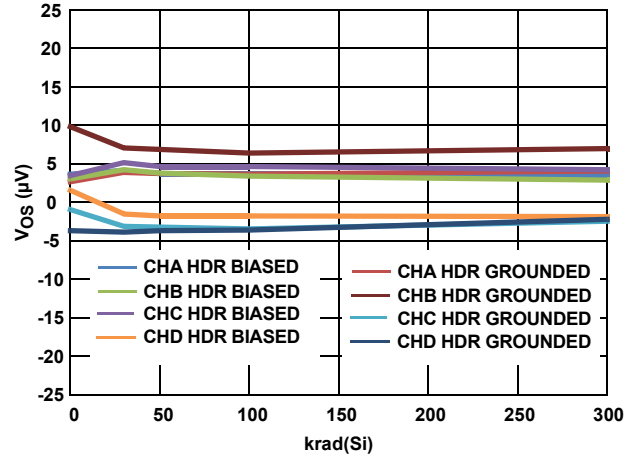

FIGURE 44.  $V_{OS}$  vs HIGH DOSE RATE RADIATION

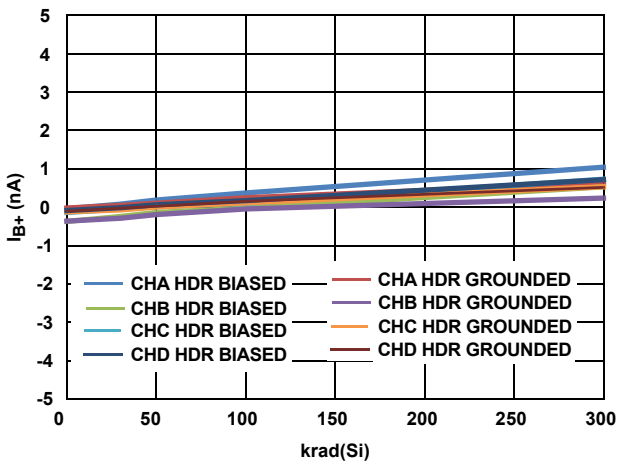

FIGURE 45.  $I_{B+}$  vs HIGH DOSE RATE RADIATION

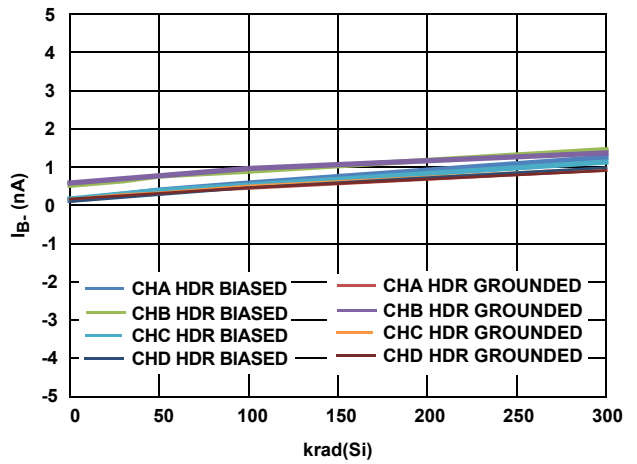

FIGURE 46.  $I_{B-}$  vs HIGH DOSE RATE RADIATION

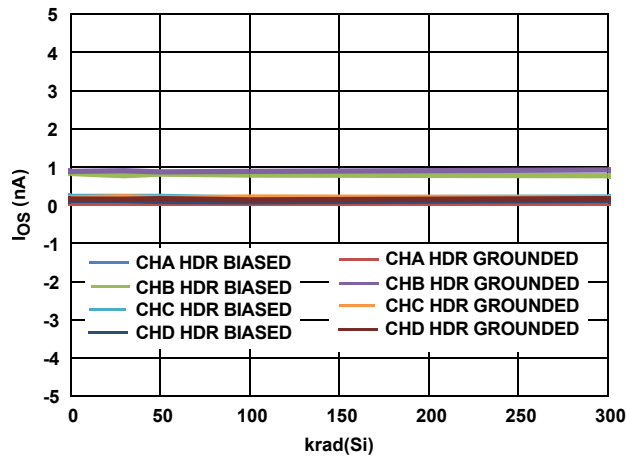

FIGURE 47.  $I_{OS}$  vs HIGH DOSE RATE RADIATION

**Post Low Dose Radiation Characteristics** Unless otherwise specified,  $V_S \pm 15V$ ,  $V_{CM} = 0$ ,  $V_O = 0V$ ,  $T_A = +25^\circ C$ . This data is typical mean test data post radiation exposure at a low dose rate of  $<10\text{mrad(Si)/s}$ . This data is intended to show typical parameter shifts due to low dose rate radiation. These are not limits nor are they guaranteed

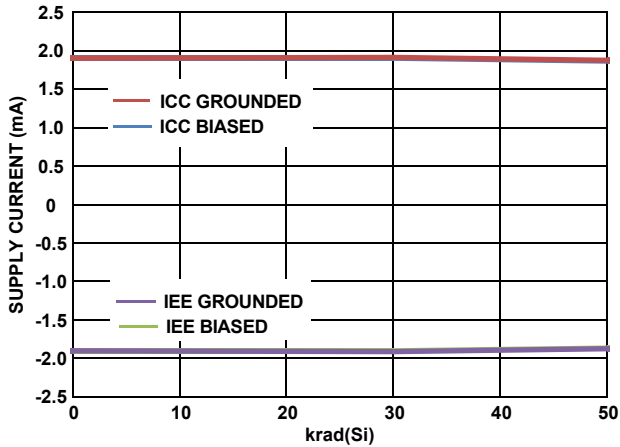

FIGURE 48. SUPPLY CURRENT vs LOW DOSE RATE RADIATION

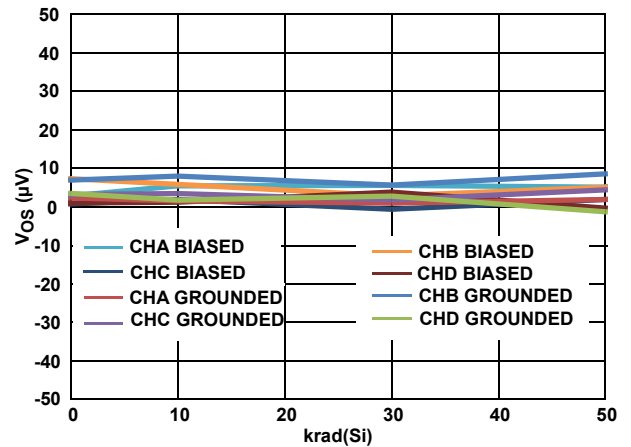

FIGURE 49.  $V_{OS}$  vs LOW DOSE RATE RADIATION

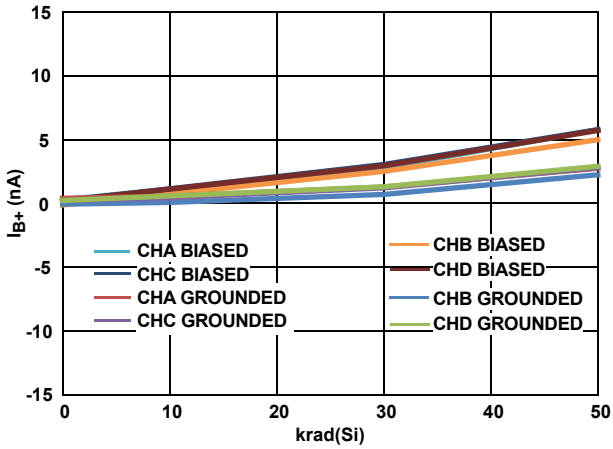

FIGURE 50.  $I_{B+}$  vs LOW DOSE RATE RADIATION

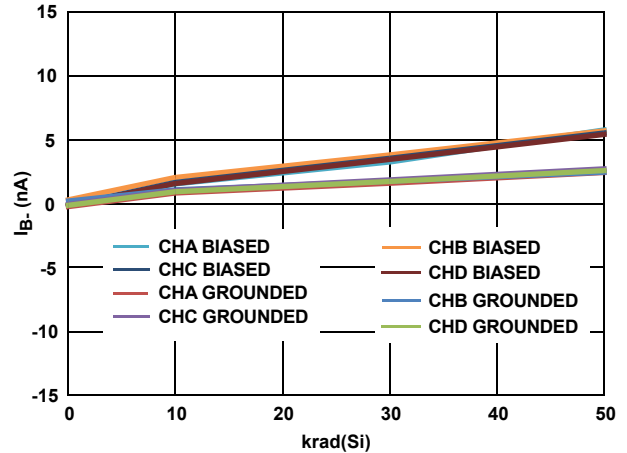

FIGURE 51.  $I_{B-}$  vs LOW DOSE RATE RADIATION

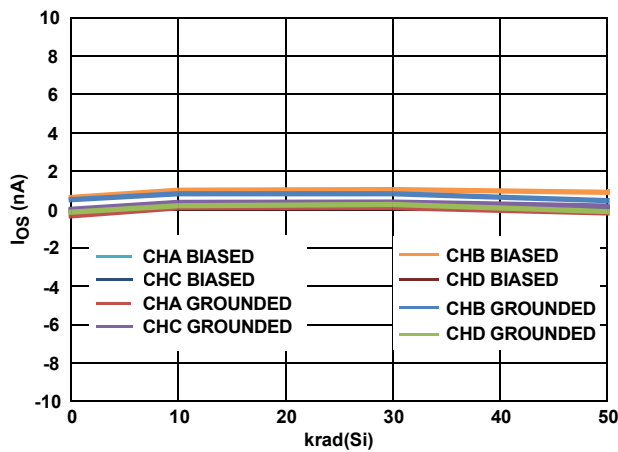

FIGURE 52.  $I_{OS}$  vs LOW DOSE RATE RADIATION



## Applications Information

### Functional Description

The ISL7x419SEH contain four low noise precision operational amplifiers (op amps). These devices are fabricated in a precision 40V complementary bipolar DI process. A super-beta NPN input stage with input bias current cancellation provides low input bias current (180pA typical), low input offset voltage (13 $\mu$ V typical), low input noise voltage (8nV/ $\sqrt{\text{Hz}}$ ), and low 1/f noise corner frequency ( $\sim$ 8Hz). The ISL7x419SEH also feature high open-loop gain (14kV/mV) for excellent CMRR (145dB) and THD+N performance (0.0005% at 3.5V<sub>RMS</sub>, 1kHz into 2k $\Omega$ ). A complementary bipolar output stage enables high capacitive load drive without external compensation.

### Operating Voltage Range

The ISL7x419SEH are designed to operate across the 4.5V ( $\pm$ 2.25V) to 36V ( $\pm$ 18V) voltage range and is fully characterized at 10V ( $\pm$ 5V) and 30V ( $\pm$ 15V). The Power Supply Rejection Ratio typically exceeds 140dB across the full operating voltage range and 120dB minimum across the -55 $^{\circ}$ C to +125 $^{\circ}$ C temperature range. The worst case common-mode input voltage range over-temperature is 2V to each rail. With  $\pm$ 15V supplies, Common-Mode Rejection Ratio (CMRR) performance is typically >130dB over-temperature. The minimum CMRR performance across the -55 $^{\circ}$ C to +125 $^{\circ}$ C temperature range is >120dB for power supply voltages from  $\pm$ 5V (10V) to  $\pm$ 15V (30V).

### Input Performance

The super-beta NPN input pair provides excellent frequency response while maintaining high input precision. High NPN beta (>1000) reduces input bias current while maintaining good frequency response, low input bias current, and low noise. Input bias cancellation circuits provide additional bias current reduction to <5nA and excellent temperature stabilization. [Figures 6](#) through [8](#) show the high degree of bias current stability at  $\pm$ 5V and  $\pm$ 15V supplies that is maintained across the -55 $^{\circ}$ C to +125 $^{\circ}$ C temperature range. The low bias current TC also produces very low input offset current TC, which reduces DC input offset errors in precision high impedance amplifiers.

The +25 $^{\circ}$ C maximum input offset voltage ( $V_{OS}$ ) is 75 $\mu$ V at  $\pm$ 15V supplies. The input offset voltage temperature coefficient ( $V_{OSTC}$ ) is a maximum of  $\pm$ 1.0 $\mu$ V/ $^{\circ}$ C. The  $V_{OS}$  temperature behavior is smooth ([Figures 3](#) through [4](#)), maintaining constant TC across the entire temperature range.

### Input ESD Diode Protection

The input terminals (IN+ and IN-) have internal ESD protection diodes to the positive and negative supply rails, series connected 500 $\Omega$  current limiting resistors, and an anti-parallel diode pair across the inputs ([Figure 53](#)).

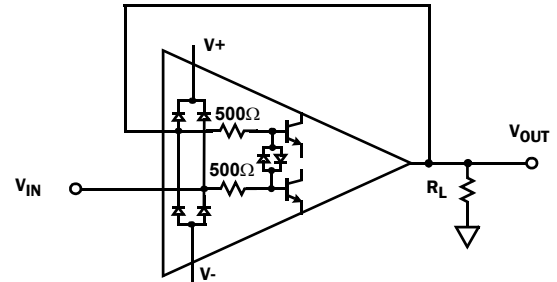

FIGURE 53. INPUT ESD DIODE CURRENT LIMITING- UNITY GAIN

The series resistors limit the high feed-through currents that can occur in pulse applications when the input  $dV/dt$  exceeds the 0.5V/ $\mu$ s slew rate of the amplifier. Without the series resistors, the input can forward-bias the anti-parallel diodes, causing current to flow to the output resulting in severe distortion and possible diode failure.

[Figure 36](#) provides an example of distortion free large signal response using a 4V<sub>p-p</sub> input pulse with an input rise time of <1ns. The series resistors enable the input differential voltage to be equal to the maximum power supply voltage (36V) without damage.

In applications where one or both amplifier input terminals are at risk of exposure to high voltages beyond the power supply rails, current limiting resistors may be needed at the input terminal to limit the current through the power supply ESD diodes to 20mA maximum.

### Output Current Limiting

The output current is internally limited to approximately  $\pm$ 45mA at +25 $^{\circ}$ C and can withstand a short-circuit to either rail if the power dissipation limits are not exceeded. This applies to only one amplifier at a time for the quad operational amplifier. Continuous operation under these conditions may degrade long term reliability. [Figures 15](#) and [16 on page 10](#) show the current limit variation with temperature.

### Output Phase Reversal

Output phase reversal is a change of polarity in the amplifier transfer function when the input voltage exceeds the supply voltage. The ISL7x419SEH are immune to output phase reversal, even when the input voltage is 1V beyond the supplies.

## Power Dissipation

It is possible to exceed the +150°C maximum junction temperatures under certain load and power supply conditions. It is therefore important to calculate the maximum junction temperature ( $T_{JMAX}$ ) for all applications to determine if power supply voltages, load conditions, or package type need to be modified to remain in the safe operating area. These parameters are related using [Equation 1](#):

$$T_{JMAX} = T_{MAX} + \theta_{JA} \times P_{D_{MAXTOTAL}} \quad (\text{EQ. 1})$$

where:

- $P_{D_{MAXTOTAL}}$  is the sum of the maximum power dissipation of each amplifier in the package ( $P_{D_{MAX}}$ )
- $P_{D_{MAX}}$  for each amplifier can be calculated using [Equation 2](#):

$$P_{D_{MAX}} = V_S \times I_{q_{MAX}} + (V_S - V_{OUTMAX}) \times \frac{V_{OUTMAX}}{R_L} \quad (\text{EQ. 2})$$

where:

- $T_{MAX}$  = Maximum ambient temperature
- $\theta_{JA}$  = Thermal resistance of the package
- $P_{D_{MAX}}$  = Maximum power dissipation of one amplifier
- $V_S$  = Total supply voltage
- $I_{q_{MAX}}$  = Maximum quiescent supply current of one amplifier
- $V_{OUTMAX}$  = Maximum output voltage swing of the application

## Package Characteristics

### Weight of Packaged Device

0.6043 grams (Typical)

### Lid Characteristics

Finish: Gold  
 Potential: Unbiased; tied to EPAD  
 Case Isolation to Any Lead:  $20 \times 10^9 \Omega$  (min)

## Die Characteristics

### Die Dimensions

2406 $\mu\text{m}$  x 2935 $\mu\text{m}$  (95 mils x 116 mils)  
 Thickness: 483 $\mu\text{m}$   $\pm$ 25 $\mu\text{m}$  (19mils  $\pm$ 1 mil)

### Interface Materials

#### GLASSIVATION

Type: Nitrox  
 Thickness: 15k $\text{\AA}$

## Metallization Mask Layout

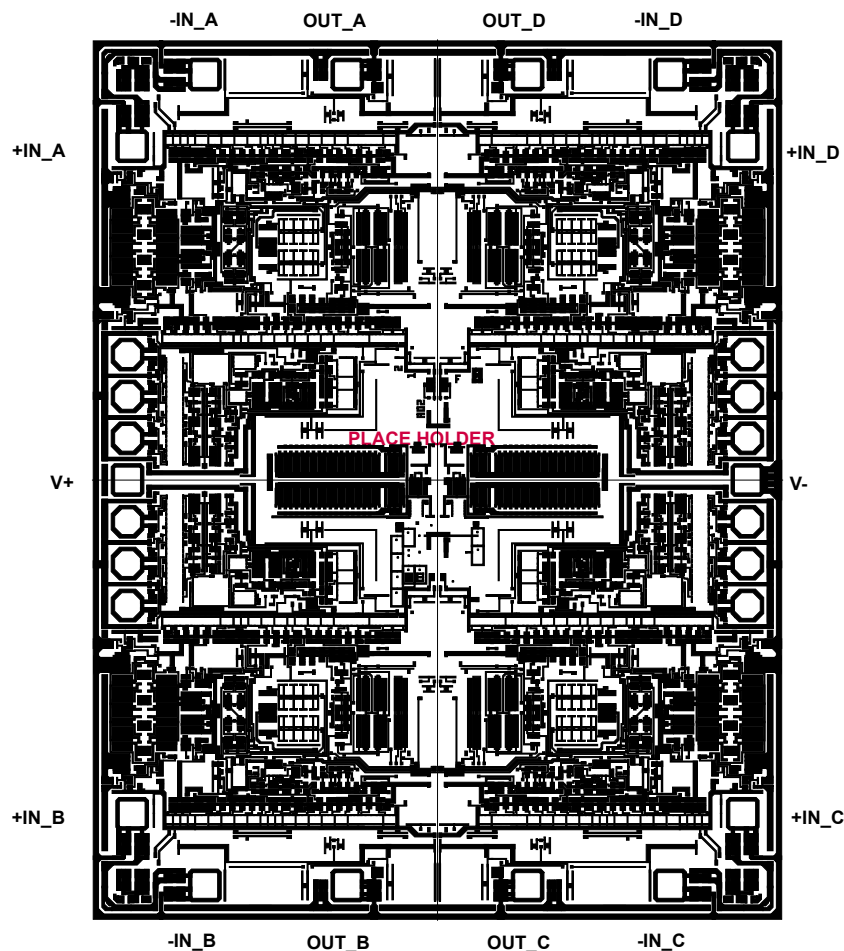

### TOP METALLIZATION

Type: AlCu (99.5%/0.5%)  
 Thickness: 30k $\text{\AA}$

### BACKSIDE FINISH

Silicon

### PROCESS

Dielectrically Isolated Complementary Bipolar - PR40

## ASSEMBLY RELATED INFORMATION

### SUBSTRATE POTENTIAL

Floating

## ADDITIONAL INFORMATION

### WORST CASE CURRENT DENSITY

$< 2 \times 10^5 \text{ A/cm}^2$

TABLE 1. DIE LAYOUT X-Y COORDINATES

PAD NAME	PAD NUMBER	X ( $\mu\text{m}$ )	Y ( $\mu\text{m}$ )	dX ( $\mu\text{m}$ )	dY ( $\mu\text{m}$ )	BOND WIRES PER PAD
OUT_A	3	-445.5	1308.5	70	70	1
-IN_A	4	-815	1308.5	70	70	1
+IN_A	5	-1040.5	1092	70	70	1
V+	9	-1044	0	70	70	1
+IN_B	13	-1040.5	-1092	70	70	1
-IN_B	14	-815	-1308.5	70	70	1
OUT_B	15	-445.5	-1308.5	70	70	1
OUT_C	16	445.5	-1308.5	70	70	1
-IN_C	17	815	-1308.5	70	70	1
+IN_C	18	1040.5	-1092	70	70	1
V-	22	1044	0	70	70	1
+IN_D	26	1040.5	1092	70	70	1
-IN_D	1	815	1308.5	70	70	1
OUT_D	2	445.5	1308.5	70	70	1

## NOTE:

9. Origin of coordinates is the center of die.

**Revision History** The revision history provided is for informational purposes only and is believed to be accurate, but not warranted. Please go to web to make sure you have the latest Revision.

DATE	REVISION	CHANGE
Nov 21, 2019	FN8653.3	Added the ISL73419SEH to the datasheet. Updated the rad levels on Features list and included rad levels in the Ordering Information table. Added Note 3. Updated figures 39 and 40.
Oct 15, 2018	FN8653.2	Updated Related Literature section. Updated Ordering Information table. Added Notes 3 and 4. Removed Pb-Free Reflow reference as it is not applicable to this type of package. Removed About Intersil section. Updated disclaimer and moved to end of document.
Jul 11, 2014	FN8653.1	Modified in Features on page 1 SEL/SEB LET <sub>TH</sub> (VS = ±36V) . . . . . 86.4MeV • cm <sup>2</sup> /mg to SEB LET <sub>TH</sub> (VS = ±18V) . . . . . 86.4MeV • cm <sup>2</sup> /mg  Added in Features on page 1 "SEL Immune (SOI Process)" under in the radiation environment section
Jun 24, 2014	FN8653.0	Initial Release

# Package Outline Drawing

For the most recent package outline drawing, see [K14.C](#).

K14.C  
 14 LEAD CERAMIC METAL SEAL FLATPACK PACKAGE  
 Rev 0, 9/12

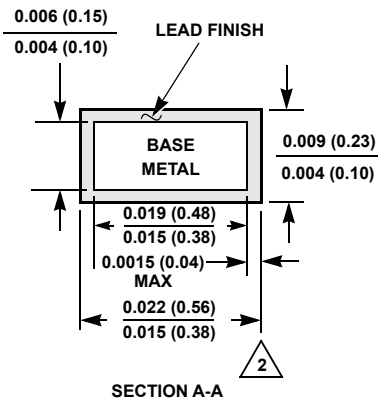
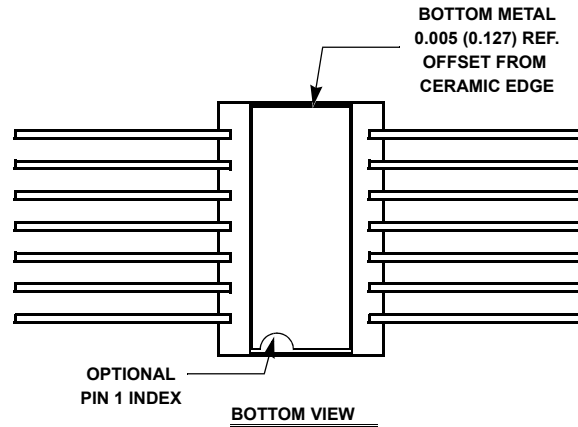
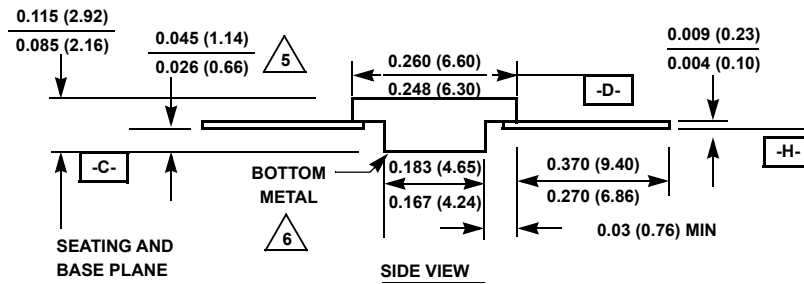
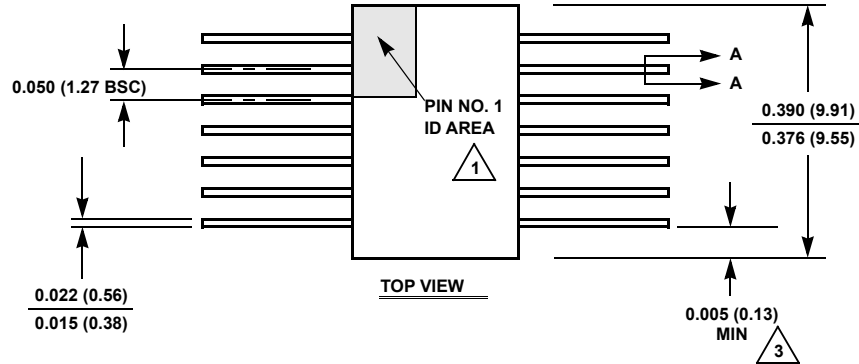

**NOTES:**

1. Index area: A notch or a pin one identification mark shall be located adjacent to pin one and shall be located within the shaded area shown. The manufacturer's identification shall not be used as a pin one identification mark.
2. The maximum limits of lead dimensions (section A-A) shall be measured at the centroid of the finished lead surfaces, when solder dip or tin plate lead finish is applied.
3. Measure dimension at all four corners.
4. For bottom-brazed lead packages, no organic or polymeric materials shall be molded to the bottom of the package to cover the leads.
5. Dimension shall be measured at the point of exit (beyond the meniscus) of the lead from the body. Dimension minimum shall be reduced by 0.0015 inch (0.038mm) maximum when solder dip lead finish is applied.
6. The bottom of the package is a solderable metal surface.
7. Dimensioning and tolerancing per ANSI Y14.5M - 1982.
8. Dimensions: INCH (mm). Controlling dimension: INCH.

## IMPORTANT NOTICE AND DISCLAIMER

RENESAS ELECTRONICS CORPORATION AND ITS SUBSIDIARIES (“RENESAS”) PROVIDES TECHNICAL SPECIFICATIONS AND RELIABILITY DATA (INCLUDING DATASHEETS), DESIGN RESOURCES (INCLUDING REFERENCE DESIGNS), APPLICATION OR OTHER DESIGN ADVICE, WEB TOOLS, SAFETY INFORMATION, AND OTHER RESOURCES “AS IS” AND WITH ALL FAULTS, AND DISCLAIMS ALL WARRANTIES, EXPRESS OR IMPLIED, INCLUDING, WITHOUT LIMITATION, ANY IMPLIED WARRANTIES OF MERCHANTABILITY, FITNESS FOR A PARTICULAR PURPOSE, OR NON-INFRINGEMENT OF THIRD PARTY INTELLECTUAL PROPERTY RIGHTS.

These resources are intended for developers skilled in the art designing with Renesas products. You are solely responsible for (1) selecting the appropriate products for your application, (2) designing, validating, and testing your application, and (3) ensuring your application meets applicable standards, and any other safety, security, or other requirements. These resources are subject to change without notice. Renesas grants you permission to use these resources only for development of an application that uses Renesas products. Other reproduction or use of these resources is strictly prohibited. No license is granted to any other Renesas intellectual property or to any third party intellectual property. Renesas disclaims responsibility for, and you will fully indemnify Renesas and its representatives against, any claims, damages, costs, losses, or liabilities arising out of your use of these resources. Renesas' products are provided only subject to Renesas' Terms and Conditions of Sale or other applicable terms agreed to in writing. No use of any Renesas resources expands or otherwise alters any applicable warranties or warranty disclaimers for these products.

(Rev.1.0 Mar 2020)

### Corporate Headquarters

TOYOSU FORESIA, 3-2-24 Toyosu,  
Koto-ku, Tokyo 135-0061, Japan  
[www.renesas.com](http://www.renesas.com)

### Contact Information

For further information on a product, technology, the most up-to-date version of a document, or your nearest sales office, please visit:  
[www.renesas.com/contact/](http://www.renesas.com/contact/)

### Trademarks

Renesas and the Renesas logo are trademarks of Renesas Electronics Corporation. All trademarks and registered trademarks are the property of their respective owners.