

ISL705xRH, ISL705xEH, ISL706xRH, ISL706xEH, ISL735xEH, ISL736xEH

Radiation Hardened, 5.0V/3.3V  $\mu$ -Processor Supervisory Circuits

The devices in this family (ISL705AEH, ISL705BEH, ISL705CEH, ISL705ARH, ISL705BRH, ISL705CRH, ISL706AEH, ISL706BEH, ISL706CEH, ISL706ARH, ISL706BRH, ISL706CRH, ISL735AEH, ISL735BEH, ISL735CEH, ISL736AEH, ISL736BEH, ISL736CEH) are radiation hardened 5.0V/3.3V supervisory circuits that reduce the complexity required to monitor supply voltages in microprocessor systems. These devices significantly improve accuracy and reliability relative to discrete solutions. Each IC provides four key functions.

- A reset output during power-up, power-down, and brownout conditions.
- An independent watchdog output that goes low if the watchdog input has not been toggled within 1.6s.
- A precision threshold detector for monitoring a power supply other than  $V_{DD}$ .
- An active-low, manual-reset input.

**Applications**

- Supervisor for  $\mu$ -processors,  $\mu$ -controllers, FPGAs, and DSPs
- Critical power supply monitoring
- Reliable replacement of discrete solutions

**Features**

- Electrically screened to SMD 5962-11213
- QML qualified per MIL-PRF-38535 requirements
- Precision supply voltage monitor
  - 4.65V threshold in the ISL7x5AxH/BxH/CxH
  - 3.08V threshold in the ISL7x6AxH/BxH/CxH
- 200ms (typ) reset pulse width
  - Active high, active low, and open-drain options
- Independent watchdog timer with 1.6s (typ) timeout
- Precision threshold detector
  - 1.25V threshold in the ISL7x5AxH/BxH/CxH
  - 0.6V threshold in the ISL7x6AxH/BxH/CxH
- Debounced TTL/CMOS compatible manual-reset input
- Reset output valid at  $V_{DD} = 1.2V$
- TID Rad Hard Assurance (RHA) testing - ISL705xRH, ISL706xRH
  - High dose rate (50rad(Si)/s - 300rad(Si)/s): 100krad(Si)
- TID Rad Hard Assurance (RHA) testing - ISL705xEH, ISL706xEH
  - High dose rate (50rad(Si)/s - 300rad(Si)/s): 100krad(Si)
  - Low dose rate (0.01rad(Si)/s): 50krad(Si)
- TID Rad Hard Assurance (RHA) testing - ISL735xEH, ISL736xEH
  - Low dose rate (0.01rad(Si)/s): 50krad(Si)
- SEE Characterization (see SEE report for details)
  - No DSEE for  $V_{DD} = 6.5V$  and  $86MeV \cdot cm^2/mg$

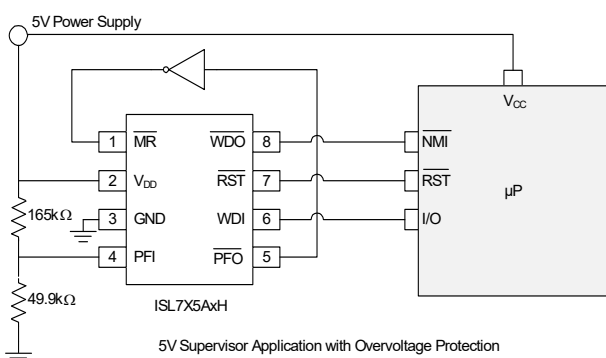

Figure 1. Typical Application

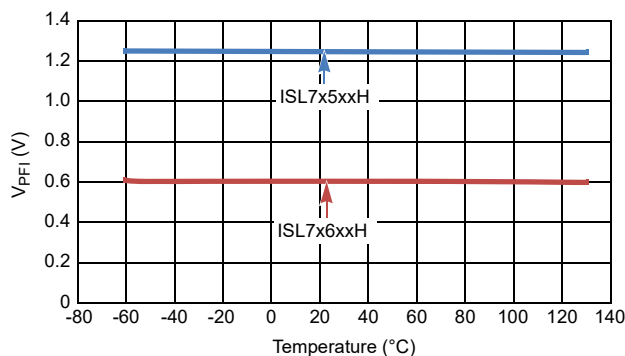

Figure 2. Precision Threshold Detector Temperature Characteristics Curve

## Contents

<b>1. Overview</b>	<b>3</b>
1.1 Functional Block Diagrams	3
<b>2. Pin Information</b>	<b>3</b>
2.1 Pin Configurations	3
2.2 Pin Descriptions	3
<b>3. Timing Diagrams</b>	<b>5</b>
<b>4. Specifications</b>	<b>6</b>
4.1 Absolute Maximum Ratings	6
4.2 Recommended Operating Conditions	6
4.3 Thermal Specifications	6
4.4 Electrical Specifications	6
<b>5. Typical Performance Curves</b>	<b>9</b>
<b>6. Post Radiation Characteristics</b>	<b>11</b>
<b>7. Functional Overview</b>	<b>14</b>
7.1 Reset Output	14
7.2 Power Failure Monitor	14
7.3 Manual Reset	15
7.4 Watchdog Timer	15
<b>8. Applications Information</b>	<b>15</b>
8.1 Negative Voltage Sensing	15
8.2 Assuring a Valid $\overline{\text{RST}}$ Output	16
8.3 Assuring a Valid RST Output	16
8.4 Selecting Pull-up Resistor Values	17
8.5 Adding Hysteresis to the PFI Comparator	17
8.6 Special Application Considerations	18
<b>9. Die and Assembly Characteristics</b>	<b>19</b>
<b>10. Metallization Mask Layout</b>	<b>20</b>
<b>11. Package Outline Drawing</b>	<b>21</b>
<b>12. Ordering Information</b>	<b>22</b>
<b>13. Revision History</b>	<b>24</b>

# 1. Overview

## 1.1 Functional Block Diagrams

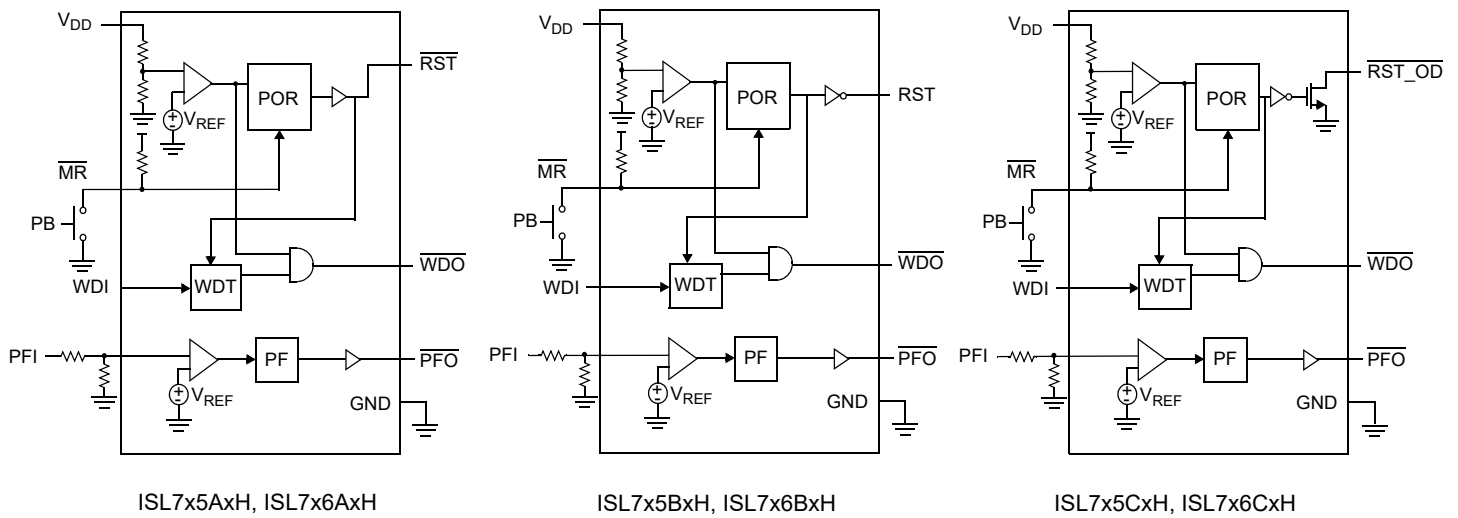

Figure 3. Functional Block Diagrams

# 2. Pin Information

## 2.1 Pin Configurations

ISL7x5AxH, ISL7x6AxH  
(8 LD FLATPACK)

Top View

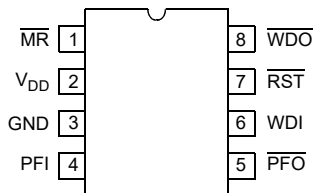

ISL7x5BxH, ISL7x6BxH  
(8 LD FLATPACK)

Top View

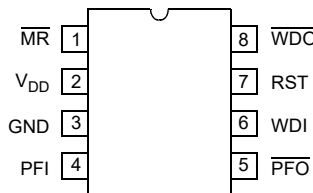

ISL7x5CxH, ISL7x6CxH  
(8 LD FLATPACK)

Top View

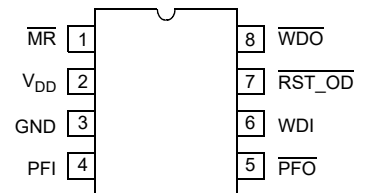

## 2.2 Pin Descriptions

ISL7x5AxH ISL7x6AxH	ISL7x5BxH ISL7x6BxH	ISL7x5CxH ISL7x6CxH	Pin Name	Description
1	1	1	$\overline{\text{MR}}$	<b>Manual Reset.</b> $\overline{\text{MR}}$ is an active-low, debounced, TTL/CMOS compatible input that can be used to trigger a reset pulse.
2	2	2	$V_{\text{DD}}$	<b>Power Supply.</b> $V_{\text{DD}}$ is a supply voltage input that provides power to all internal circuitry. This input is also monitored and used to trigger a reset pulse. Reset is guaranteed operable after $V_{\text{DD}}$ rises above 1.2V.
3	3	3	GND	<b>Ground.</b> GND is a supply voltage return for all internal circuitry. This return establishes the reference level for voltage detection and should be connected to signal ground.

ISL7x5AxH ISL7x6AxH	ISL7x5BxH ISL7x6BxH	ISL7x5CxH ISL7x6CxH	Pin Name	Description
4	4	4	PFI	<b>Power Fail Input.</b> PFI is an input to a threshold detector, which can be used to monitor another supply voltage level. The threshold of the detector ( $V_{PFI}$ ) is 1.25V in the ISL7x5AxH/BxH/CxH and 0.6V in the ISL7x6AxH/BxH/CxH. The PFI/PFO circuit is active when $V_{DD} \geq 1V$ and is inactive with PFO pulled to ground when $V_{DD} \leq 0.7V$ .
5	5	5	$\overline{PFO}$	<b>Power Fail Output.</b> $\overline{PFO}$ is an active-low, push-pull output of a threshold detector that indicates the voltage at the PFI pin is less than $V_{PFI}$ .
6	6	6	WDI	<b>Watchdog Input.</b> WDI is a tri-state input that monitors microprocessor activity. If the microprocessor does not toggle WDI within 1.6s and WDI is not tri-stated, $\overline{WDO}$ goes low. As long as reset is asserted or WDI is tri-stated, the watchdog timer will stay cleared and will not count. As soon as reset is released and WDI is driven high or low, the timer will start counting. Floating WDI or connecting WDI to a high impedance tri-state buffer disables the watchdog feature.
7	-	-	$\overline{RST}$	<b>Reset.</b> $\overline{RST}$ is an active-low, push-pull output that is guaranteed to be low after $V_{DD}$ reaches 1.2V. As $V_{DD}$ rises, $\overline{RST}$ stays low. When $V_{DD}$ rises above a 4.65V (ISL7x5AxH/BxH/CxH) or 3.08V (ISL7x6AxH/BxH/CxH) reset threshold, an internal timer releases $\overline{RST}$ after about 200ms. $\overline{RST}$ pulses low whenever $V_{DD}$ goes below the reset threshold. If a brownout condition occurs in the middle of a previously initiated reset pulse, the pulse will continue for at least 140ms. On power-down, after $V_{DD}$ falls below the reset threshold, $\overline{RST}$ goes low and is guaranteed low until $V_{DD}$ drops below 1.2V.
-	7	-	RST	<b>Reset.</b> RST is an active-high, push-pull output. RST is the inverse of $\overline{RST}$ .
-	-	7	$\overline{RST\_OD}$	<b>Reset.</b> $\overline{RST\_OD}$ is an active-low, open-drain output that goes low when reset is asserted. This pin can be pulled up to $V_{DD}$ with a resistor consistent with the sink and leakage current specifications of the output. Behavior is otherwise identical to the $\overline{RST}$ pin.
8	8	8	$\overline{WDO}$	<b>Watchdog Output.</b> $\overline{WDO}$ is an active-low, push-pull output that goes low if the microprocessor does not toggle WDI within 1.6s and WDI is not tri-stated. $\overline{WDO}$ is usually connected to the non-maskable interrupt input of a microprocessor. When $V_{DD}$ drops below the reset threshold, $\overline{WDO}$ will go low whether or not the watchdog timer has timed out. Reset is simultaneously asserted, thus preventing an interrupt. Since floating WDI disables the internal timer, $\overline{WDO}$ goes low only when $V_{DD}$ drops below the reset threshold, thus functioning as a low line output. The Watch Dog function is overridden and inactive when Reset is active. Please refer to <a href="#">Figure 14</a> .

### 3. Timing Diagrams

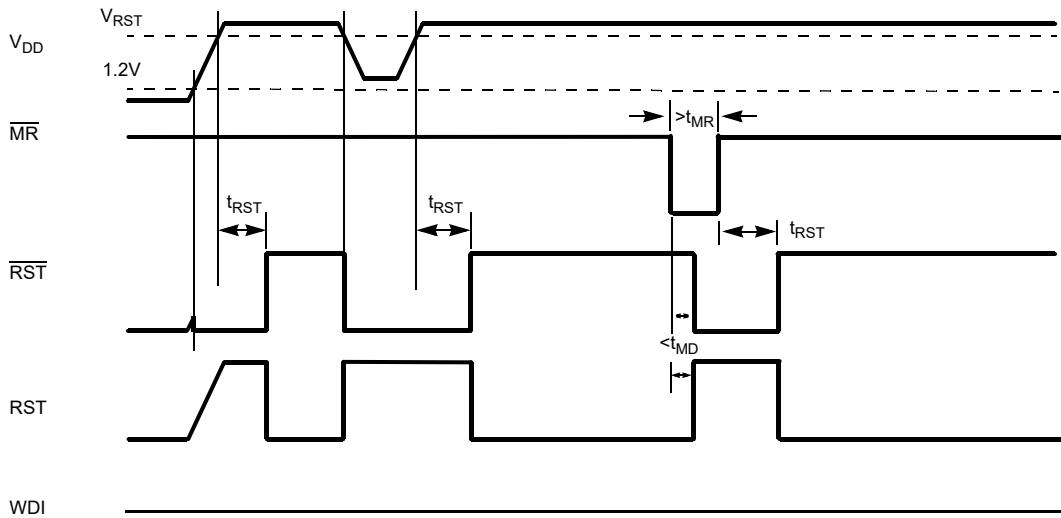

Figure 4.  $\overline{RST}$ ,  $\overline{MR}$  Timing Diagram

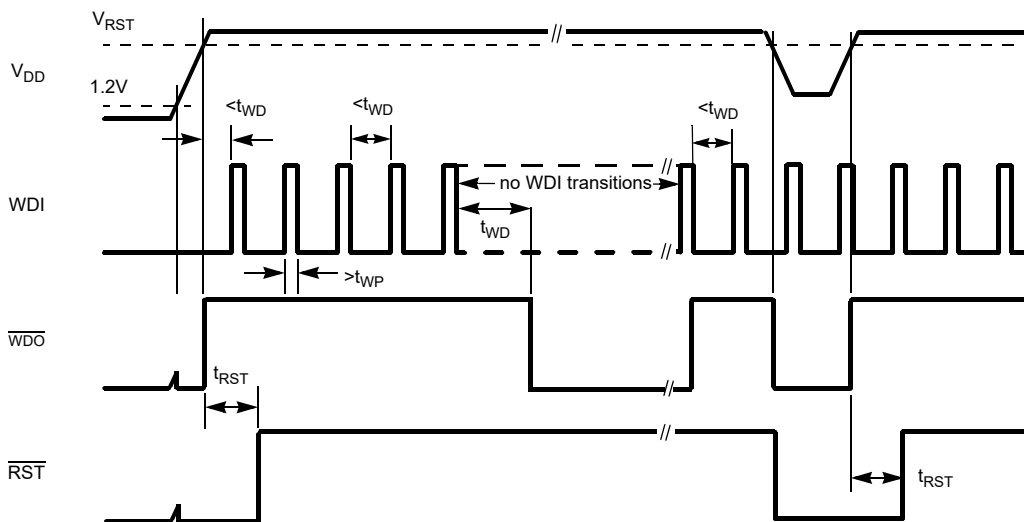

Figure 5. Watchdog Timing Diagram

## 4. Specifications

### 4.1 Absolute Maximum Ratings

Parameter	Minimum	Maximum	Unit
Supply Voltage Range	-0.3	6.5	V
Voltage on All Other Inputs	-0.3	$V_{DD} + 0.3$	V
Maximum Junction Temperature	-	+175	°C
Maximum Storage Temperature Range	-65	+150	°C
Human Body Model (Tested per MIL-PRF-883 3015.7)	-	3	kV
Machine Model (Tested per JESD22-A115C)	-	300	V
Charged Device Model (Tested per JESD22-C110D)	-	1	kV
Latch-Up (Tested per JESD-78C), Class 2, Level A	-	100	mA

### 4.2 Recommended Operating Conditions

Parameter	Minimum	Maximum	Unit
Ambient Temperature	-55	+125	°C
<b>Supply Voltage</b>			
ISL7x5AxH/BxH/CxH	4.75	5.5	V
ISL7x6AxH/BxH/CxH	3.15	3.6	V

### 4.3 Thermal Specifications

Parameter	Package	Symbol	Conditions	Typical Value	Unit
Thermal Resistance	8 Ld Flatpack	$\theta_{JA}^{[1]}$	Junction to ambient	140	°C/W
		$\theta_{JC}^{[2]}$	Junction to case	15	°C/W

- $\theta_{JA}$  is measured with the component mounted on a low-effective thermal conductivity test board in free air. See [TB379](#) for details.
- For  $\theta_{JC}$ , the case temperature location is the center of the package underside.

### 4.4 Electrical Specifications

Unless otherwise specified  $V_{DD} = 4.75V$  to  $5.5V$  for the ISL7x5AxH/BxH/CxH,  $V_{DD} = 3.15V$  to  $3.6V$  for the ISL7x6AxH/BxH/CxH,  $T_A = -55^\circ C$  to  $+125^\circ C$ . **Boldface limits apply across the operating temperature range,  $-55^\circ C$  to  $+125^\circ C$ ; over a total ionizing dose of 100krad(Si) with exposure at a high dose rate of 50 - 300krad(Si)/s; and over a total ionizing dose of 50krad(Si) with exposure at a low dose rate of  $<10\text{mrad(Si)/s}$ .**

Parameter	Symbol	Test Conditions	Min <sup>[1]</sup>	Typ <sup>[2]</sup>	Max <sup>[1]</sup>	Unit
<b>Power Supply Section</b>						
Operating Supply Voltage <sup>[3]</sup>	$V_{DD}$	ISL7x5AxH/BxH/CxH	<b>1.2</b>	5.0	<b>5.5</b>	V
		ISL7x6AxH/BxH/CxH	<b>1.2</b>	3.3	<b>3.6</b>	V
Operating Supply Current	$I_{DD}$	ISL7x5AxH/BxH/CxH	-	-	<b>530</b>	$\mu A$
		ISL7x6AxH/BxH/CxH	-	-	<b>400</b>	$\mu A$

Unless otherwise specified  $V_{DD} = 4.75V$  to  $5.5V$  for the ISL7x5AxH/BxH/CxH,  $V_{DD} = 3.15V$  to  $3.6V$  for the ISL7x6AxH/BxH/CxH,  $T_A = -55^{\circ}C$  to  $+125^{\circ}C$ . **Boldface limits apply across the operating temperature range,  $-55^{\circ}C$  to  $+125^{\circ}C$ ; over a total ionizing dose of 100krad(Si) with exposure at a high dose rate of 50 - 300krad(Si)/s; and over a total ionizing dose of 50krad(Si) with exposure at a low dose rate of <10mrad(Si)/s. (Cont.)**

Parameter	Symbol	Test Conditions	Min <sup>[1]</sup>	Typ <sup>[2]</sup>	Max <sup>[1]</sup>	Unit
<b>Reset Section</b>						
Reset Threshold Voltage	$V_{RST}$	ISL7x5AxH/BxH/CxH	<b>4.50</b>	4.65	<b>4.75</b>	V
		ISL7x6AxH/BxH/CxH	<b>3.00</b>	3.08	<b>3.15</b>	V
Reset Threshold Voltage Hysteresis	$V_{HYS}$	ISL7x5AxH/BxH/CxH	<b>20</b>	40		mV
		ISL7x6AxH/BxH/CxH	<b>20</b>	30		mV
Reset Pulse Width	$t_{RST}$	-	<b>140</b>	200	<b>280</b>	ms
Reset Output Voltage	$V_{OUT}$	ISL7x5AxH/BxH, $I_{SOURCE} = 800\mu A$	<b><math>V_{DD} - 1.5</math></b>			V
		ISL7x5AxH/BxH/CxH, $I_{SINK} = 3.2mA$	-	-	<b>0.4</b>	V
		ISL7x6AxH/BxH, $I_{SOURCE} = 500\mu A$	<b><math>0.8 \times V_{DD}</math></b>	-	-	V
		ISL7x6AxH/BxH/CxH, $I_{SINK} = 1.2mA$	-	-	<b>0.3</b>	V
		ISL7xAXAxH/CxH, $V_{DD} = 1.2V$ , $I_{SINK} = 100\mu A$	-	-	<b>0.3</b>	V
		ISL7xBxH, $V_{DD} = 1.2V$ , $I_{SOURCE} = 4\mu A$	<b>0.9</b>	-	-	V
Reset Output Leakage Current	$I_{LEAK}$	ISL7x5CxH, $V_{OUT} = V_{DD}$	-	-	<b>1</b>	$\mu A$
		ISL7x6CxH, $V_{OUT} = V_{DD}$	-	-	<b>1</b>	$\mu A$
<b>Watchdog Section</b>						
Watchdog Time-Out Period	$t_{WD}$	-	<b>1.00</b>	1.60	<b>2.25</b>	s
Watchdog Input (WDI) Pulse Width	$t_{WP}$	ISL7x5AxH/BxH/CxH, $V_{IL} = 0.4V$ , $V_{IH} = 0.8 \times V_{DD}$	<b>50</b>	-	-	ns
		ISL7x6AxH/BxH/CxH, $V_{IL} = 0.4V$ , $V_{IH} = 0.8 \times V_{DD}$	<b>100</b>	-	-	ns
Watchdog Input (WDI) Threshold Voltage	$V_{IL}$	ISL7x5AxH/BxH/CxH	-	-	<b>0.8</b>	V
	$V_{IH}$	ISL7x5AxH/BxH/CxH	<b>3.5</b>	--	-	V
	$V_{IL}$	ISL7x6AxH/BxH/CxH	-	-	<b>0.6</b>	V
	$V_{IH}$	ISL7x6AxH/BxH/CxH	<b><math>0.7 \times V_{DD}</math></b>	-	-	V
Watchdog Input (WDI) Current	$I_{WDI}$	ISL7x5AxH/BxH/CxH, $WDI = V_{DD}$	-	-	<b>100</b>	$\mu A$
		ISL7x5AxH/BxH/CxH, $WDI = 0V$	<b>-100</b>	-	-	$\mu A$
		ISL7x6AxH/BxH/CxH, $WDI = V_{DD}$	-	-	<b>5</b>	$\mu A$
		ISL7x6AxH/BxH/CxH, $WDI = 0V$	<b>-5</b>	-	-	$\mu A$
Watchdog Output ( $\overline{WDO}$ ) Voltage	$V_{WDO}$	ISL7x5AxH/BxH/CxH, $I_{SOURCE} = 800\mu A$	<b><math>V_{DD} - 1.5</math></b>	-	-	V
		ISL7x5AxH/BxH/CxH, $I_{SINK} = 1.2mA$	-	-	<b>0.4</b>	V
		ISL7x6AxH/BxH/CxH, $I_{SOURCE} = 500\mu A$	<b><math>0.8 \times V_{DD}</math></b>	-	-	V
		ISL7x6AxH/BxH/CxH, $I_{SINK} = 500\mu A$	-	-	<b>0.3</b>	V

Unless otherwise specified  $V_{DD} = 4.75V$  to  $5.5V$  for the ISL7x5AxH/BxH/CxH,  $V_{DD} = 3.15V$  to  $3.6V$  for the ISL7x6AxH/BxH/CxH,  $T_A = -55^{\circ}C$  to  $+125^{\circ}C$ . **Boldface limits apply across the operating temperature range,  $-55^{\circ}C$  to  $+125^{\circ}C$ ; over a total ionizing dose of 100krad(Si) with exposure at a high dose rate of 50 - 300krad(Si)/s; and over a total ionizing dose of 50krad(Si) with exposure at a low dose rate of  $<10\text{mrad(Si)/s}$ .** (Cont.)

Parameter	Symbol	Test Conditions	Min <sup>[1]</sup>	Typ <sup>[2]</sup>	Max <sup>[1]</sup>	Unit
<b>Manual Reset Section</b>						
Manual Reset ( $\overline{MR}$ ) Pull-Up Current	$I_{MR}$	ISL7x5AxH/BxH/CxH, $\overline{MR} = 0V$	<b>-500</b>	-	<b>-100</b>	$\mu A$
		ISL7x6AxH/BxH/CxH, $\overline{MR} = 0V$	<b>-250</b>	-	<b>-25</b>	$\mu A$
Manual Reset ( $\overline{MR}$ ) Pulse Width	$t_{MR}$	ISL7x5AxH/BxH/CxH	<b>150</b>	-	-	ns
		ISL7x6AxH/BxH/CxH	<b>150</b>	-	-	ns
Manual Reset ( $\overline{MR}$ ) Input Threshold Voltage	$V_{IL}$	ISL7x5AxH/BxH/CxH	-	-	<b>0.8</b>	V
	$V_{IH}$		<b>2.0</b>	-	-	V
	$V_{IL}$	ISL7x6AxH/BxH/CxH	-	-	<b>0.6</b>	V
	$V_{IH}$		<b><math>0.7 \times V_{DD}</math></b>	-	-	V
Manual Reset ( $\overline{MR}$ ) to Reset Out Delay	$t_{MD}$	ISL7x5AxH/BxH/CxH	-	-	<b>100</b>	ns
		ISL7x6AxH/BxH/CxH	-	-	<b>100</b>	ns
<b>Threshold Detector Section</b>						
Power Fail Input (PFI) Input Threshold Voltage	$V_{PFI}$	ISL7x5AxH/BxH/CxH	<b>1.20</b>	1.25	<b>1.30</b>	V
		ISL7x6AxH/BxH/CxH	<b>0.576</b>	0.600	<b>0.624</b>	V
Power Fail Input (PFI) Input Current	$I_{PFI}$	-	<b>-10</b>	-	<b>10</b>	nA
Power Fail Output ( $\overline{PFO}$ ) Output Voltage	$V_{PFO}$	ISL7x5AxH/BxH/CxH, $I_{SOURCE} = 800\mu A$	<b><math>V_{DD} - 1.5</math></b>	-	-	V
		ISL7x5AxH/BxH/CxH, $I_{SINK} = 3.2mA$	-	-	<b>0.4</b>	V
		ISL7x6AxH/BxH/CxH, $I_{SOURCE} = 500\mu A$	<b><math>0.8 \times V_{DD}</math></b>	-	-	V
		ISL7x6ARH/BRH/CRH, $I_{SINK} = 1.2mA$	-	-	<b>0.3</b>	V
PFI Rising Threshold Crossing to $\overline{PFO}$ Delay	$t_{RPFI}$	ISL7x5AxH/BxH/CxH	-	7	<b>15</b>	$\mu s$
		ISL7x6AxH/BxH/CxH	-	11	<b>20</b>	$\mu s$
PFI Falling Threshold Crossing to $\overline{PFO}$ Delay	$t_{FPFI}$	ISL7x5AxH/BxH/CxH	-	20	<b>35</b>	$\mu s$
		ISL7x6AxH/BxH/CxH	-	25	<b>40</b>	$\mu s$

1. Compliance to datasheet limits is assured by one or more methods: production test, characterization, and/or design.
2. Typical values shown reflect  $T_A = T_J = +25^{\circ}C$  operation and are not guaranteed.
3. Reset is the only parameter operable within 1.2V and the minimum recommended operating supply voltage.



## 5. Typical Performance Curves

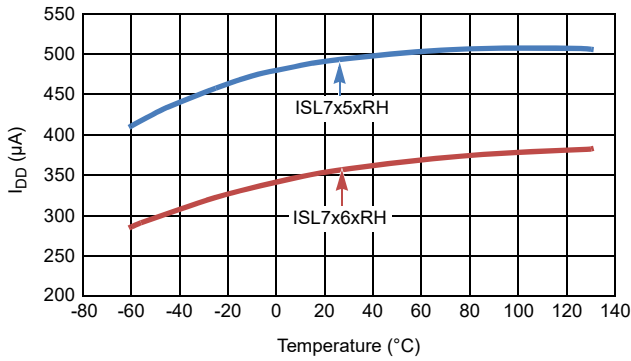

Figure 6. I<sub>DD</sub> vs Temperature

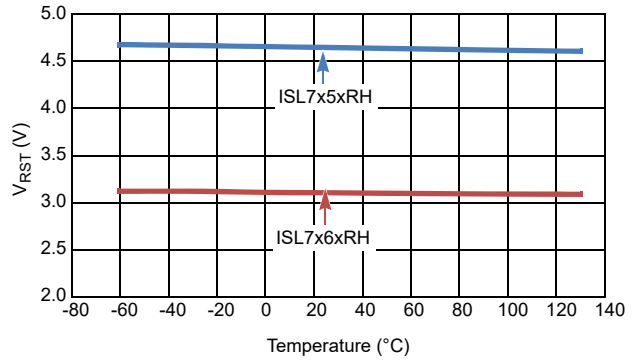

Figure 7. V<sub>RST</sub> vs Temperature

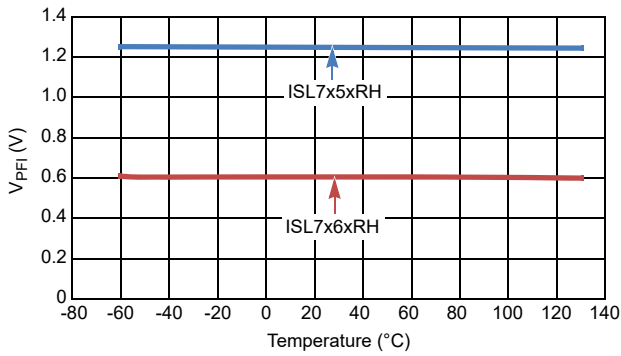

Figure 8. V<sub>PFI</sub> vs Temperature

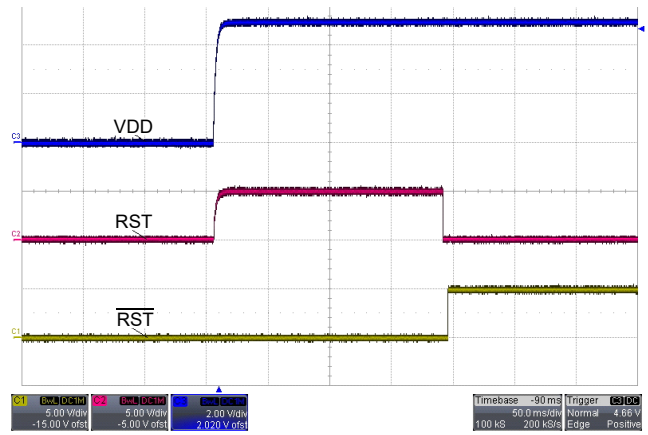

Figure 9. ISL7x5xRH RESET and  $\overline{\text{RESET}}$  Assertion

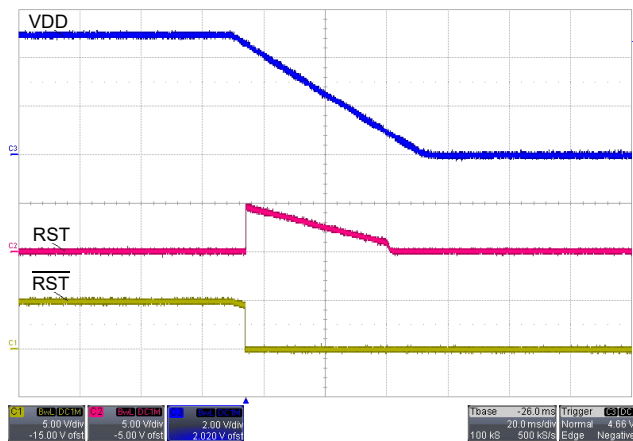

Figure 10. ISL7x5xRH RESET and  $\overline{\text{RESET}}$  Deassertion

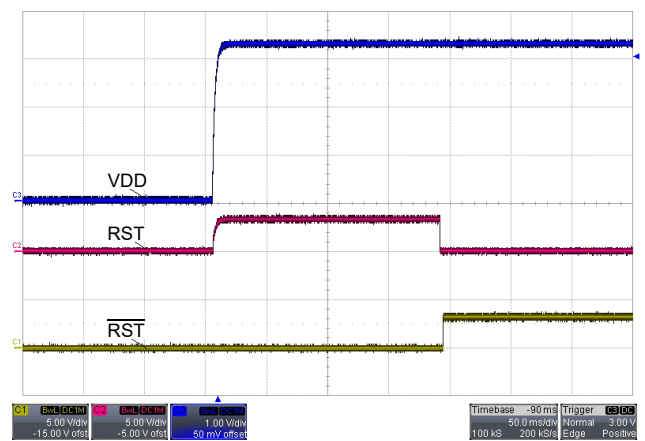

Figure 11. ISL7x6xRH RESET and  $\overline{\text{RESET}}$  Assertion

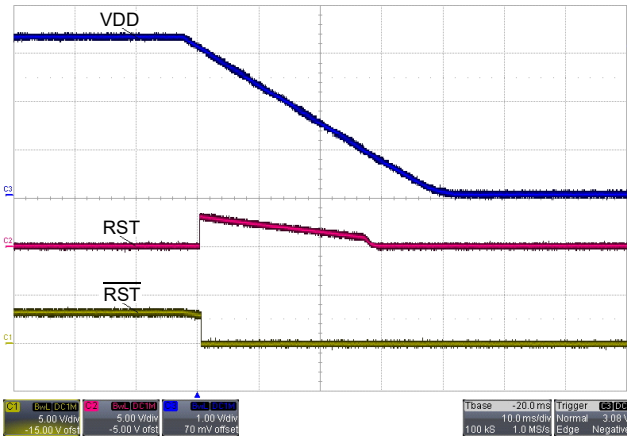

Figure 12. ISL7x6xRH RESET and  $\overline{\text{RESET}}$  Deassertion

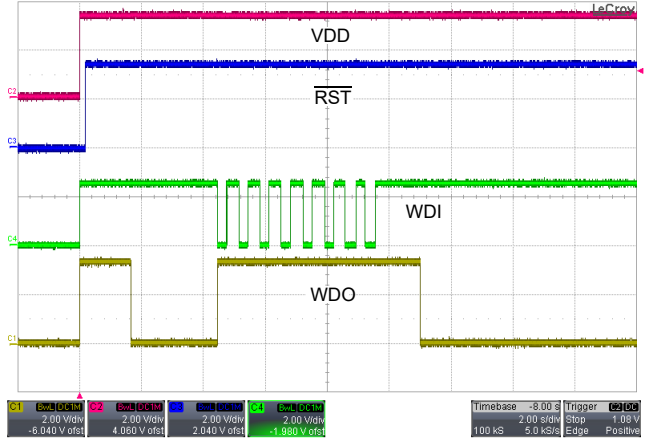

Figure 13. ISL7x6xEH Start-Up to RESET,  $\overline{\text{WDO}}$ , and WDI Function

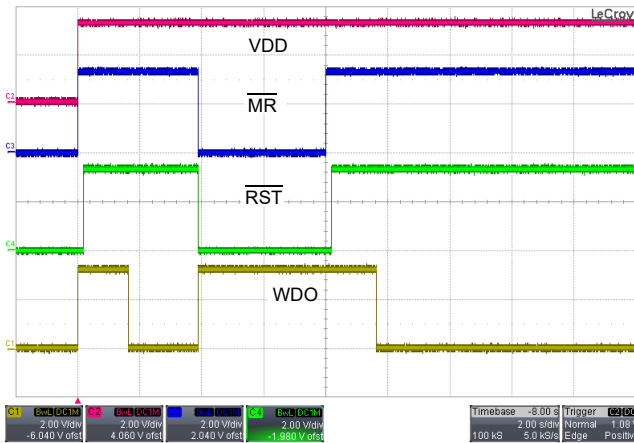

Figure 14. ISL7x6xEH Start-Up to RESET, Manual RESET, and  $\overline{\text{WDO}}$  Function

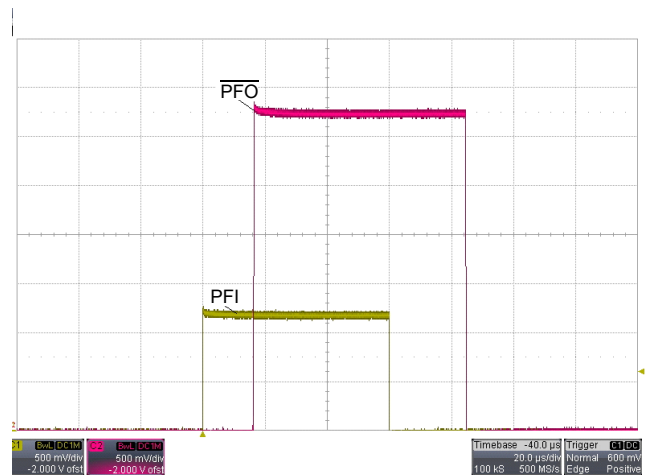

Figure 15. ISL7x5xRH PFI to  $\overline{\text{PFO}}$  Response

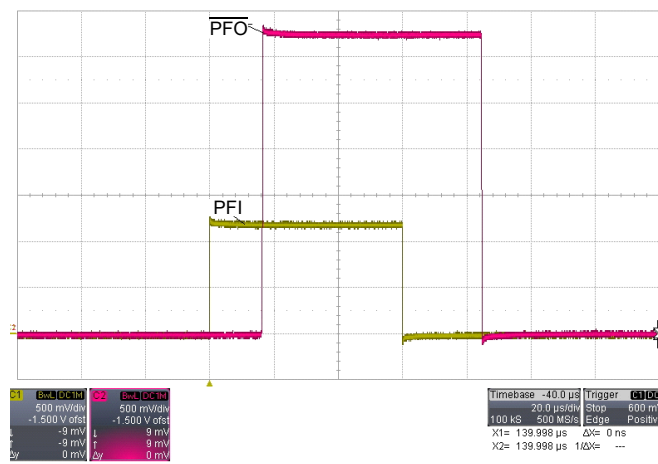

Figure 16. ISL7x6xRH PFI to  $\overline{\text{PFO}}$  Response

## 6. Post Radiation Characteristics

Unless otherwise specified,  $V_{DD} = 4.75V$  to  $5.5V$  for the ISL7x5AEH/BEH/CEH only,  $V_{DD} = 3.15V$  to  $3.6V$  for the ISL7x6AEH/BEH/CEH, only  $T_A = +25^\circ C$ . This data is typical mean test data post radiation exposure at a rate of  $<10\text{mrad(Si)/s}$ . This data is intended to show typical parameter shifts due to low dose rate radiation. These are not limits nor are they guaranteed.

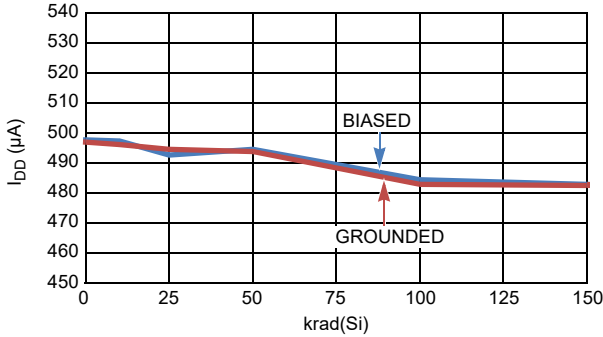

Figure 17. ISL7x5xEH  $I_{DD}$  vs Low Dose Rate Radiation

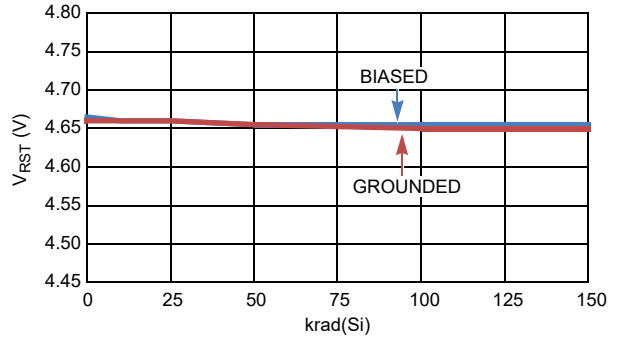

Figure 18. ISL7x5xEH  $V_{RST}$  vs Low Dose Rate Radiation

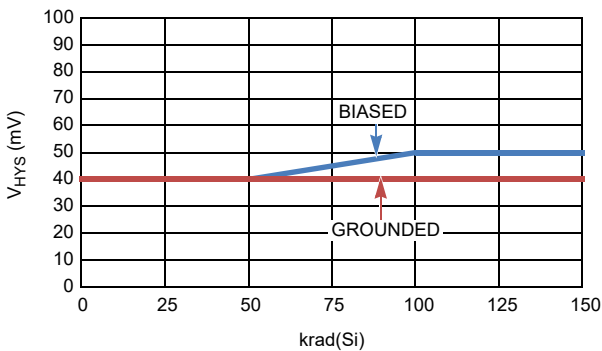

Figure 19. ISL7x5xEH  $V_{HYS}$  vs Low Dose Rate Radiation

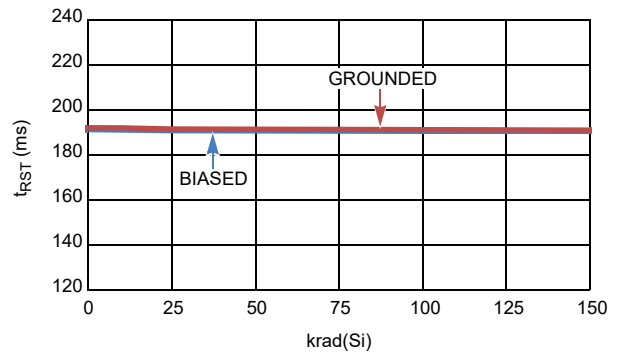

Figure 20. ISL7x5xEH  $t_{RST}$  vs Low Dose Rate Radiation

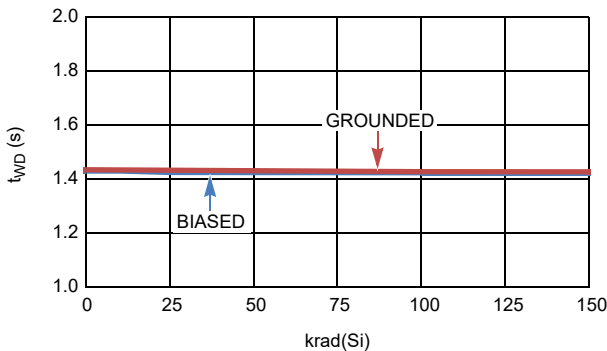

Figure 21. ISL7x5xEH  $t_{WD}$  vs Low Dose Rate Radiation

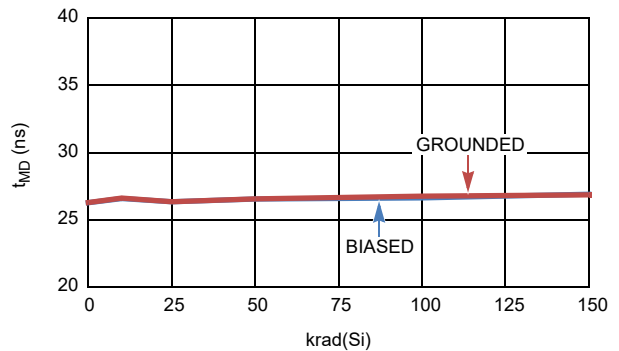

Figure 22. ISL7x5xEH  $t_{MD}$  vs Low Dose Rate Radiation

Unless otherwise specified,  $V_{DD} = 4.75V$  to  $5.5V$  for the ISL7x5AEH/BEH/CEH only,  $V_{DD} = 3.15V$  to  $3.6V$  for the ISL7x6AEH/BEH/CEH, only  $T_A = +25^\circ C$ . This data is typical mean test data post radiation exposure at a rate of  $<10\text{mrad(Si)/s}$ . This data is intended to show typical parameter shifts due to low dose rate radiation. These are not limits nor are they guaranteed. (Cont.)

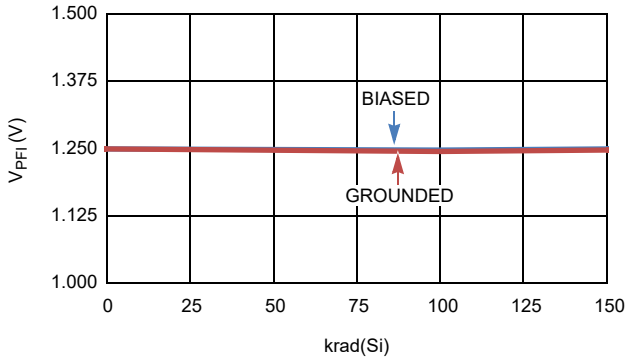

Figure 23. ISL7x5xEH  $V_{PFI}$  vs Low Dose Rate Radiation

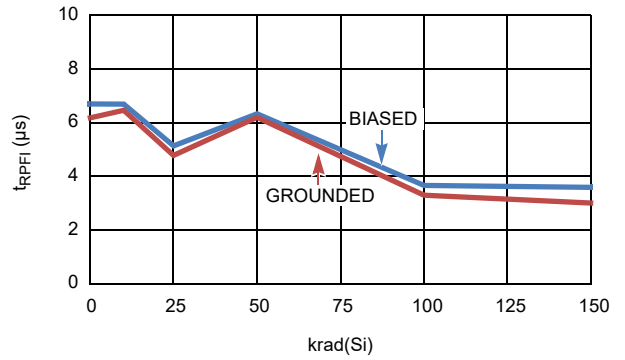

Figure 24. ISL7x5xEH  $t_{RPFI}$  vs Low Dose Rate Radiation

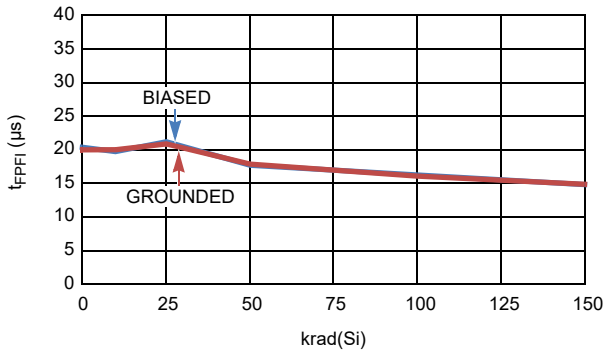

Figure 25. ISL7x5xEH  $t_{FPFI}$  vs Low Dose Rate Radiation

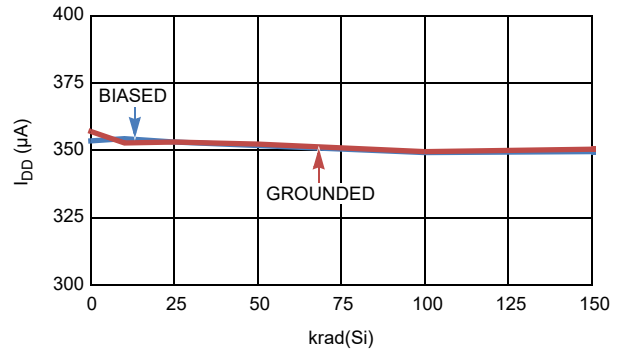

Figure 26. ISL7x6xEH  $I_{DD}$  vs Low Dose Rate Radiation

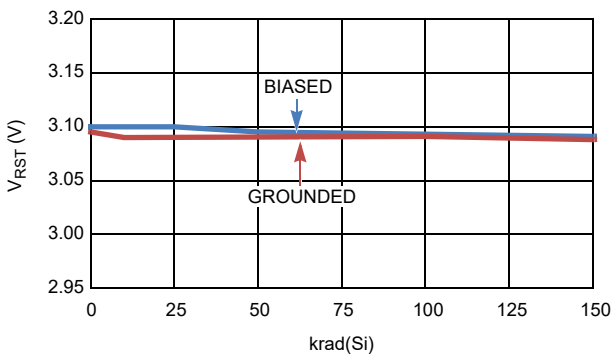

Figure 27. ISL7x6xEH  $V_{RST}$  vs Low Dose Rate Radiation

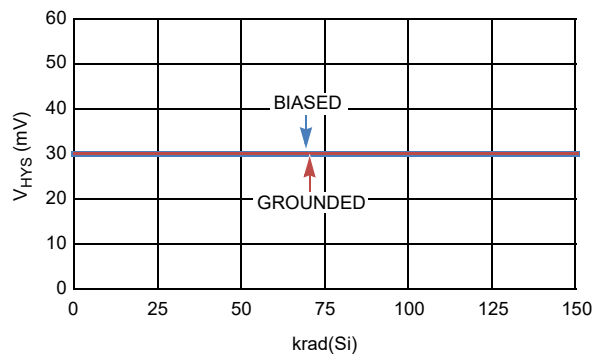

Figure 28. ISL7x6xEH  $V_{HYS}$  vs Low Dose Rate Radiation

Unless otherwise specified,  $V_{DD} = 4.75V$  to  $5.5V$  for the ISL7x5AEH/BEH/CEH only,  $V_{DD} = 3.15V$  to  $3.6V$  for the ISL7x6AEH/BEH/CEH, only  $T_A = +25^\circ C$ . This data is typical mean test data post radiation exposure at a rate of  $<10\text{mrad}(\text{Si})/\text{s}$ . This data is intended to show typical parameter shifts due to low dose rate radiation. These are not limits nor are they guaranteed. (Cont.)

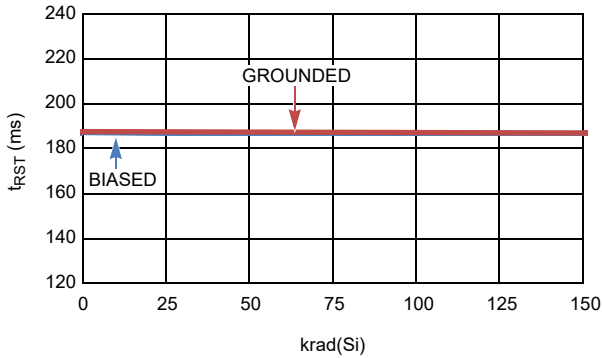

Figure 29. ISL7x6xEH  $t_{RST}$  vs Low Dose Rate Radiation

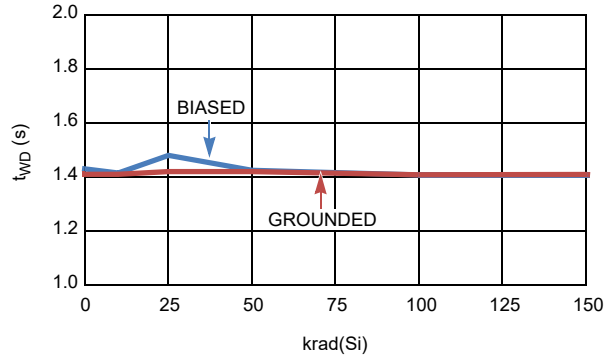

Figure 30. ISL7x6xEH  $t_{WD}$  vs Low Dose Rate Radiation

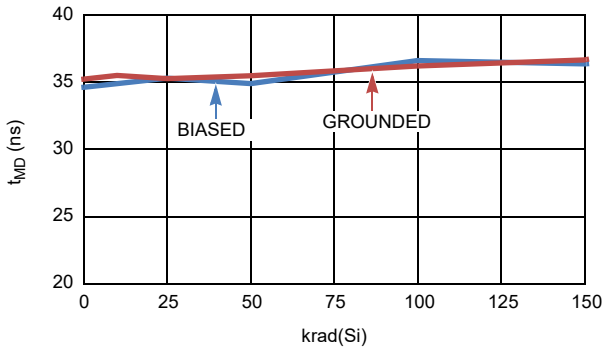

Figure 31. ISL7x6xEH  $t_{MD}$  vs Low Dose Rate Radiation

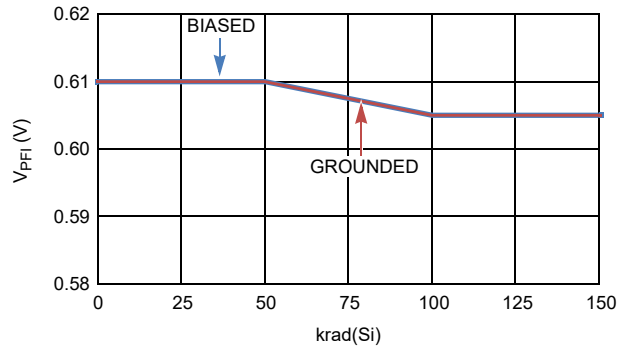

Figure 32. ISL7x6xEH  $V_{PFI}$  vs Low Dose Rate Radiation

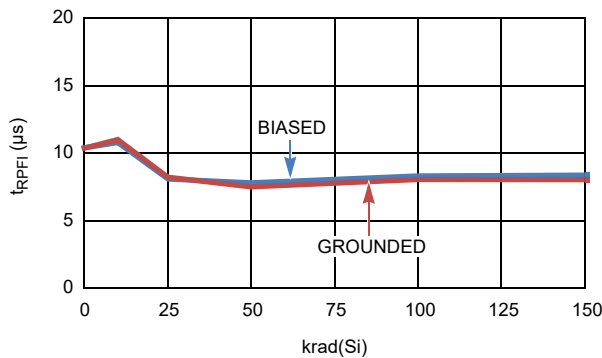

Figure 33. ISL7x6xEH  $t_{RPFI}$  vs Low Dose Rate Radiation

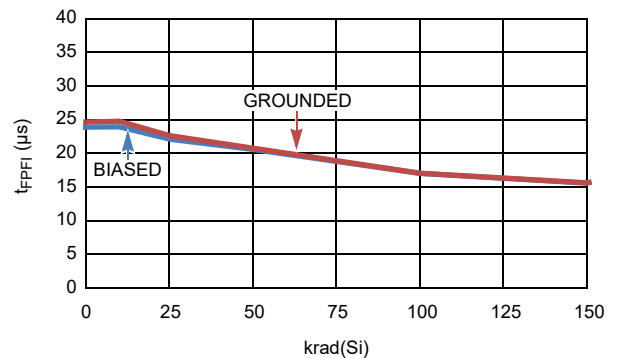

Figure 34. ISL7x6xEH  $t_{FPFI}$  vs Low Dose Rate Radiation

## 7. Functional Overview

The ISL7x5xxH and ISL7x6xxH provide the functions needed for monitoring critical voltages in high reliability applications such as microprocessor systems. Functions of these supervisors include power-on reset control, supply voltage supervisions, power-fail detection, manual-reset assertion, and a watchdog timer. The integration of these functions along with their high threshold accuracy, low power consumption, and radiation tolerance make these devices ideal for critical supply monitoring.

The family of devices are differentiated only by the radiation assurance levels that each one is qualified to. See the [Ordering Information](#) table for details on the radiation assurance levels each device obtains.

### 7.1 Reset Output

Reset control has long been a critical aspect of embedded control design. Microprocessors require a reset signal during power-up to ensure that the system environment is stable before initialization.

The reset signal provides several benefits:

- It prevents the system microprocessor from starting to operate with insufficient voltage.
- It prevents the processor from operating before stabilization of the oscillator.
- It ensures that the monitored device is held out of operation until internal registers are initialized.
- It allows time for an FPGA to perform its self configuration before initialization of the circuit.

On power-up, after  $V_{DD}$  reaches 1.2V,  $\overline{RST}$  is guaranteed logic low. As  $V_{DD}$  rises,  $\overline{RST}$  stays low. When  $V_{DD}$  rises above the reset threshold ( $V_{RST}$ ), an internal timer releases  $\overline{RST}$  after 200ms (typical).  $\overline{RST}$  pulses low whenever  $V_{DD}$  degrades to below  $V_{RST}$  (see [Figure 4](#)). If a brownout condition occurs in the middle of a previously initiated reset pulse, the pulse is lengthened 200ms (typical).

On power-down, after  $V_{DD}$  falls below the reset threshold,  $\overline{RST}$  stays low and is guaranteed to be low until  $V_{DD}$  drops below 1.2V.

The ISL7x5BxH and ISL7x6BxH active-high RST output is simply the complement of the  $\overline{RST}$  output and is guaranteed to be valid with  $V_{DD}$  down to 1.2V. The ISL7x5CxH and ISL7x6CxH active-low open-drain reset output is functionally identical to  $\overline{RST}$ .

### 7.2 Power Failure Monitor

Besides monitoring  $V_{DD}$  for reset control, these devices have a Power Failure Monitor feature that supervises an additional critical voltage on the Power-Fail Input (PFI) pin. For example, the PFI pin could be used to provide an early power-fail warning, overvoltage detection, or monitor a power supply other than  $V_{DD}$ .  $\overline{PFO}$  goes low whenever PFI is less than  $V_{PFI}$ .

The threshold detector can be adjusted using an external resistor divider network to provide custom voltage monitoring for voltages greater than  $V_{PFI}$ , according to [Equation 1](#) (see [Figure 35](#)).

$$(EQ. 1) \quad V_{IN} = V_{PFI} \left( \frac{R_1 + R_2}{R_2} \right)$$

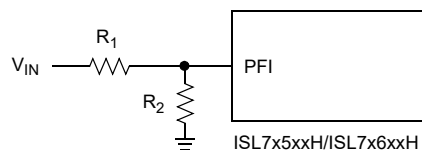

Figure 35. Custom  $V_{TH}$  with Resistor Divider on PFI

### 7.3 Manual Reset

The manual reset input ( $\overline{\text{MR}}$ ) allows designers to add manual system reset capability using a push button switch (see [Figure 36](#)). The MR input is an active low debounced input which asserts reset if the MR pin is pulled low to less than  $V_{IL}$  for at least 150ns. After  $\overline{\text{MR}}$  is released, the reset output remains asserted for  $t_{RST}$  and then released.  $\overline{\text{MR}}$  is a TTL/CMOS logic compatible, so it can be driven by external logic. By connecting  $\overline{\text{WDO}}$  to  $\overline{\text{MR}}$ , one can force a watchdog time out to generate a reset pulse.

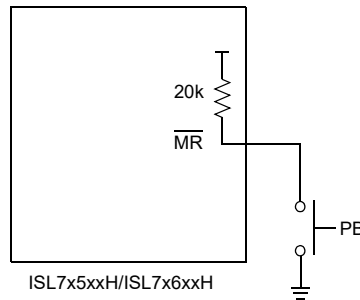

Figure 36. Connecting a Manual Reset Push-Button

### 7.4 Watchdog Timer

The watchdog time circuit checks for coherent program execution by monitoring the WDI pin. If the processor does not toggle the watchdog input within  $t_{WD}$ ,  $\overline{\text{WDO}}$  will go low. As long as reset is asserted or the WDI pin is tri-stated, the watchdog timer will stay cleared and not count. As soon as reset is released and WDI is driven high or low, the timer will start counting. Pulses as short as 50ns can be detected on the ISL7x5xxH, on ISL7x6xxH pulses as short as 100ns can be detected.

Whenever there is a low-voltage  $V_{DD}$  condition,  $\overline{\text{WDO}}$  goes low. Unlike the reset outputs, however,  $\overline{\text{WDO}}$  goes high as soon as  $V_{DD}$  rises above its voltage trip point (see [Figure 5](#)). With WDI open or connected to a tri-stated high impedance input, the watchdog timer is disabled and only pulls low when  $V_{DD} < V_{RST}$ .

## 8. Applications Information

### 8.1 Negative Voltage Sensing

This family of devices can be used to sense and monitor the presence of both a positive and negative rail.  $V_{DD}$  is used to monitor the positive supply while PFI monitors the negative rail.  $\overline{\text{PFO}}$  is high when the negative rail degrades below a  $V_{TRIP}$  value and remains low when the negative rail is above the  $V_{TRIP}$  value. As the differential voltage across the  $R_1$ ,  $R_2$  divider is increased, the resistor values must be chosen such that the PFI node is  $< 1.25V$  when the  $-V$  supply is satisfactory and the positive supply is at its maximum specified value. This allows the positive supply to fluctuate within its acceptable range without signaling a reset when configured as shown in [Figure 37](#).

$$(EQ. 2) \quad R_2 = \frac{R_1(V_{PFI} - V_{TRIP})}{V_{DD} - V_{PFI}}$$

In [Figure 37](#), the ISL7x5AxH is monitoring +5V through  $V_{DD}$  and -5V through PFI. In this example, the trip point ( $V_{TRIP}$ ) for the negative supply rail is set for -4.5V. [Equation 2](#) can be used to select the appropriate resistor values.  $R_1$  is selected arbitrarily as 100k $\Omega$ ,  $V_{DD} = 5V$ ,  $V_{PFI} = 1.25V$  and  $V_{TRIP} = (-4.5V)$ . By plugging the values

into Equation 2 as shown in Equation 3, it can be seen a resistor of 153.3kΩ is needed. The closest 1% resistor value is 154kΩ.

$$(EQ. 3) \quad R_2 = \frac{100k(1.25 - (-4.5))}{5 - 1.25} = 153.3k\Omega$$

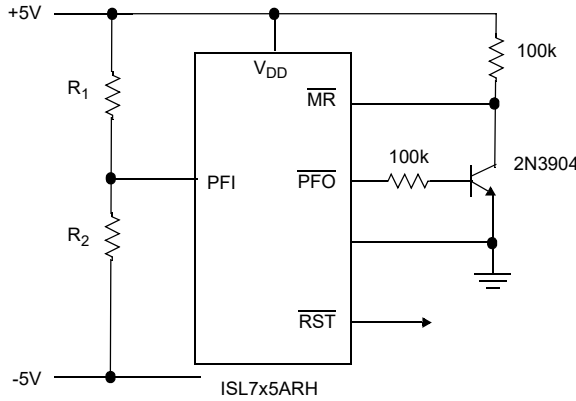

Figure 37. ±5V Monitoring

Figure 5 also has a general purpose NPN transistor in which the base is connected to the PFO pin through a 100kΩ resistor. The emitter is tied to ground and the collector is tied to MR signal. This configuration allows the negative voltage sense circuit to initiate a reset if it is not within its regulation window. A pull-up on the MR ensures no false reset triggering when the negative voltage is within its regulation window.

## 8.2 Assuring a Valid RST Output

When V<sub>DD</sub> falls below 1.2V, the RST output can no longer sink current and is essentially an open circuit. As a result, this pin can drift to undetermined voltages if left undriven. By adding a pull-down resistor to the RST pin as shown in Figure 38, any stray charge or leakage currents will be drained to ground and keep RST low when VDD falls below 1.2V. The resistor value (R<sub>1</sub>) is not critical, however, it should be large enough not to load RST and small enough to pull RST to ground. A 100kΩ resistor would suffice, assuming there is no load on the RST pin during that time.

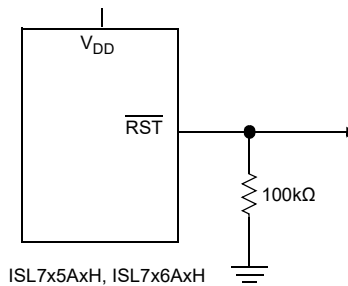

Figure 38. RST Valid to Ground Circuit

## 8.3 Assuring a Valid RST Output

On the ISL7x5BxH and ISL7x6BxH, when V<sub>DD</sub> falls below 1.2V, the RST output can no longer source enough current to track V<sub>DD</sub>. As a result, this pin can drift to undetermined voltages if left undriven. By adding a pull-up resistor to the RST pin as shown in Figure 39, RST will track V<sub>DD</sub> below 1.2V. The resistor value (R<sub>1</sub>) is not critical,



however, it should be large enough not to exceed the sink capability of RST pin at 1.2V. A 300kΩ resistor would suffice, assuming there is no load on the RST pin during that time.

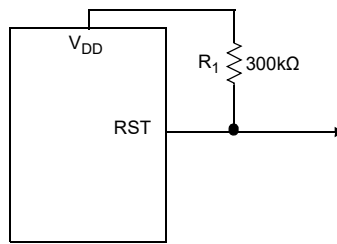

ISL7x5BxH, ISL7x6BxH

Figure 39. RST Valid to Ground Circuit

### 8.4 Selecting Pull-up Resistor Values

The ISL7x5CxH and ISL7x6CxH have open-drain, active-low reset outputs ( $\overline{\text{RST\_OD}}$ ). A pull-up resistor is needed to ensure  $\overline{\text{RST\_OD}}$  is high when  $V_{DD}$  is in a valid state (Figure 40). The resistor value must be chosen in order not to exceed the sink capability of the  $\overline{\text{RST\_OD}}$  pin. The ISL7x5CxH has a sink capability of 3.2mA and the ISL7x6CxH has a sink capability of 1.2mA. Equation 4 can be used to select resistor  $R_{PULL}$  based on the pull-up voltage  $V_{PULL}$ . It is also important that the pull-up voltage does not exceed  $V_{DD}$ .

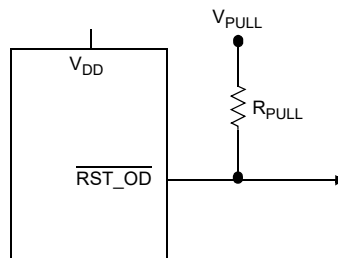

ISL7x6CxH, ISL7x5CxH

Figure 40.  $\overline{\text{RST\_OD}}$  Pull-Up Connection

$$(EQ. 4) \quad R_{PULL} = \frac{V_{PULL}}{I_{SINK}}$$

### 8.5 Adding Hysteresis to the PFI Comparator

The PFI comparator has no built-in hysteresis, however, the designer can add hysteresis by connecting a resistor from the  $\overline{\text{PFO}}$  pin to the PFI pin, essentially adding positive feedback to the comparator (see Figure 41).

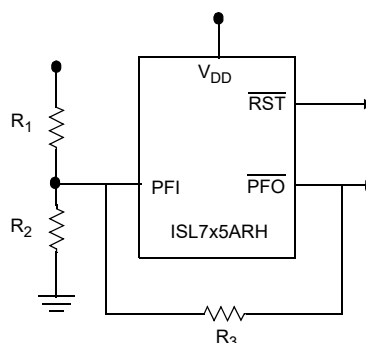

Figure 41. Positive Feedback for Hysteresis

The following procedure allows the system designer to calculate the components based on the requirements and on given data, such as supply rail voltages, hysteresis band voltage ( $V_{HB}$ ), and reference voltage ( $V_{PFI}$ ).

The comparator has only two states of operation. When it is low, the current through  $R_3$  is  $I_{R3} = V_{PFI}/R_3$ . When the output is high,  $I_{R3} = (V_{DD} - V_{PFI})/R_3$ . The feedback current needs to be very small so it does not induce oscillations; 200nA is a good starting point. Now two values of  $R_3$  can be calculated with  $V_{DD} = 5V$  and  $V_{PFI} = 1.25V$ ;  $R_3 = 6.25M\Omega$  or  $11.25M\Omega$ . Select the lowest value of the two.

With  $R_3$  selected as  $6.2M\Omega$  (closest standard 1% resistor), use [Equation 5](#) to calculate  $R_1$ .

$$(EQ. 5) \quad R_1 = R_3 \left( \frac{V_{HB}}{V_{DD}} \right) = 124k\Omega$$

With  $V_{HB}$  selected at 100mV. The closest standard value for  $R_1$  is  $124k\Omega$ . Then, select the rising trip voltage ( $V_{TR}$ ) such that:

$$(EQ. 6) \quad V_{TR} > V_{PFI} \left( 1 + \frac{V_{HB}}{V_{DD}} \right)$$

The rising threshold voltage is selected at 3.0V. Use [Equation 7](#) to calculate  $R_2$ .

$$(EQ. 7) \quad R_2 = 1 / \left[ \left( \frac{V_{TR}}{V_{PFI} \times R_1} \right) - \left( \frac{1}{R_1} \right) - \left( \frac{1}{R_3} \right) \right]$$

Plugging in all the variables in [Equation 7](#) and solving for  $R_2$  yields  $90.9k\Omega$ . *Note:* The  $90.9k\Omega$  solution includes rounding to the closest standard 1% resistor value. The final step is to verify the trip voltages.

$$(EQ. 8) \quad V_{TR} = (V_{PFI}) \times R_1 \left[ \left( \frac{1}{R_1} \right) + \left( \frac{1}{R_2} \right) + \left( \frac{1}{R_3} \right) \right]$$

$$(EQ. 9) \quad V_{TF} = V_{TR} - \left( \frac{R_1 \times V_{DD}}{R_3} \right)$$

The rising voltage,  $V_{TR}$ , is calculated as 2.98V and the falling voltage,  $V_{TF}$ , is calculated as 2.88V, so 100mV hysteresis is achieved.

An additional item to consider is that the output voltage is equal to  $V_{DD}$ , however, according to the [Electrical Specifications](#), the output of the PFI comparator is guaranteed to be at least  $(V_{DD} - 1.5)$  volts. When you take this worst case into account, the hysteresis can be as low as 70mV.

## 8.6 Special Application Considerations

Using good decoupling practices will prevent transients (for example, due to switching noises and short duration droops in the supply voltage) from causing unwanted resets and reduce the power-fail circuit's sensitivity to high-frequency noise on the line being monitored.

When the WDI input is left unconnected, it is recommended to place a  $10\mu F$  capacitor to ground to reduce single event transients from arising in the  $\overline{WDO}$  pin.

As described in the [Electrical Specifications](#) table, there is a delay ( $t_{FPFI}$ ) on the  $\overline{PFO}$  pin whenever PFI crosses the threshold. This delay is due to internal filters on the PFI comparator circuitry which were added to mitigate single event transients. If the PFI input transitions below or above the threshold and the duration of the transition is less than the delay, the PFO pin does not change states.

## 9. Die and Assembly Characteristics

Table 1. Die and Assembly Related Information

Die Information	
Dimensions	2030 $\mu$ m $\times$ 2030 $\mu$ m (79.9 mils $\times$ 79.9 mils) Thickness: 483 $\mu$ m $\pm$ 25.4 $\mu$ m (19.0 mils $\pm$ 1 mil)
Interface Materials	
Glassivation	Type: Silicon Oxide and Silicon Nitride Thickness: 0.3 $\mu$ m $\pm$ 0.03 $\mu$ m to 1.2 $\mu$ m $\pm$ 0.12 $\mu$ m
Top Metallization	Type: AlCu (99.5%/0.5%) Thickness: 2.7 $\mu$ m $\pm$ 0.4 $\mu$ m
Backside Finish	Silicon
Process	0.6 $\mu$ m BiCMOS Junction Isolated
Assembly Information	
Substrate and Package Lid Potential	Unbiased
Additional Information	
Worst Case Current Density	$<2 \times 10^5$ A/cm <sup>2</sup>
Transistor Count	1400
Weight of Packaged Device	0.31 Grams typical
Lid Characteristics	Finish: Gold Lid Potential: Unbiased Case Isolation to Any Lead: $20 \times 10^9 \Omega$ (minimum)
Layout Characteristics	Step and Repeat: 2030 $\mu$ m $\times$ 2030 $\mu$ m

## 10. Metallization Mask Layout

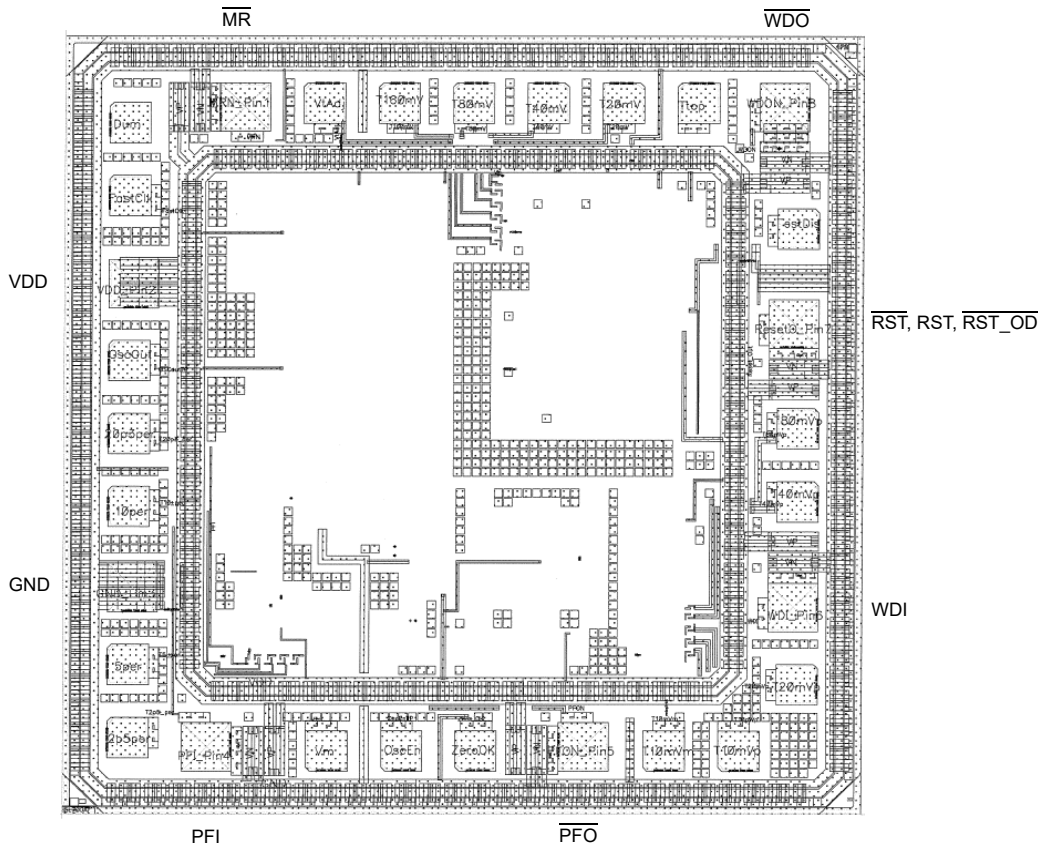

Table 2. Die Layout X-Y Coordinates

Pad Name	Pad Number	X (μm)	Y (μm)	dX (μm)	dY (μm)	Bond Wires Per Pad
$\overline{\text{MR}}$	1 <sup>[1]</sup>	0	0	110	110	1
V <sub>DD</sub>	2	-266.1	-435.35	110	110	1
GND	3	-266.1	-1184.75	110	110	1
PFI	4	-86.1	-1578	110	110	1
$\overline{\text{PFO}}$	5	818.85	-1578	110	110	1
WDI	6	1321.9	-1233.5	110	110	1
$\overline{\text{RST}}, \text{RST}, \text{RST\_OD}$	7	1321.9	-534.05	110	110	1
$\overline{\text{WDO}}$	8	1297	0	110	110	1

1. Origin of coordinates is the centroid of pad 1.

# 11. Package Outline Drawing

For the most recent package outline drawing, see [K8.A](#).

K8.A

8 Lead Ceramic Metal Seal Flatpack Package  
Rev 4, 12/14

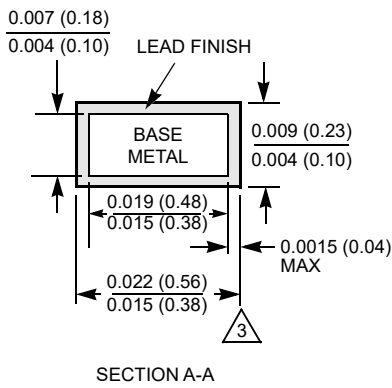
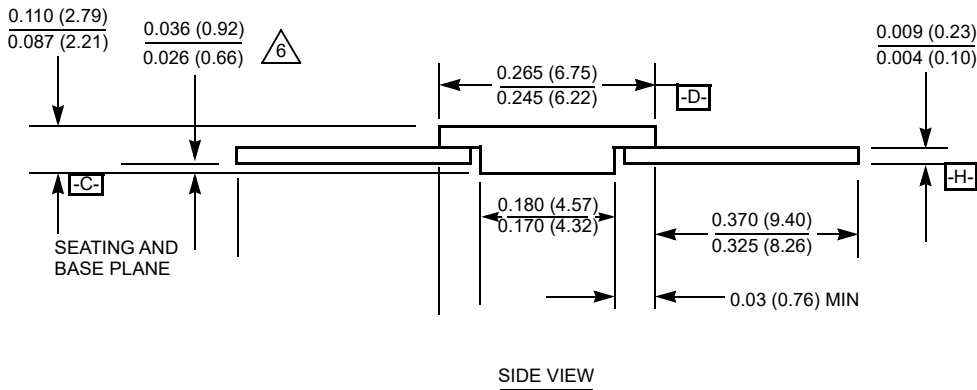
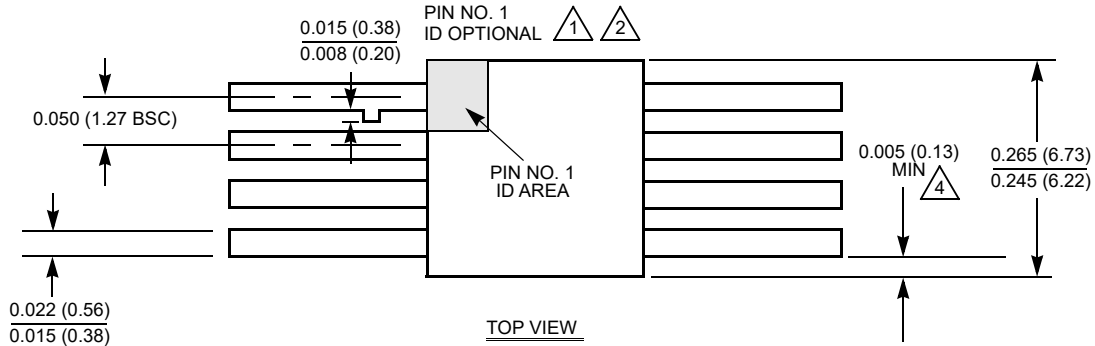

NOTES:

1. Index area: A notch or a pin one identification mark shall be located adjacent to pin one and shall be located within the shaded area shown. The manufacturer's identification shall not be used as a pin one identification mark. Alternately, a tab may be used to identify pin one.
2. If a pin one identification mark is used in addition to or instead of a tab, the limits of the tab dimension do not apply.
3. The maximum limits of lead dimensions (section A-A) shall be measured at the centroid of the finished lead surfaces, when solder dip or tin plate lead finish is applied.
4. Measure dimension at all four corners.
5. For bottom-brazed lead packages, no organic or polymeric materials shall be molded to the bottom of the package to cover the leads.
6. Dimension shall be measured at the point of exit (beyond the meniscus) of the lead from the body. Dimension minimum shall be reduced by 0.0015 inch (0.038mm) maximum when solder dip lead finish is applied.
7. Dimensioning and tolerancing per ANSI Y14.5M - 1982.
8. Controlling dimension: INCH.

## 12. Ordering Information

Ordering SMD Number <sup>[1]</sup>	Part Number <sup>[2]</sup>	Radiation Hardness (Total Ionizing Dose)	package description (RoHS Compliant)	Pkg. Dwg. #	Temp Range
5962R1121307VXC	ISL705AEHVF	HDR to 100krad(Si), LDR to 50krad(Si)	8 Ld Flatpack	K8.A	-55 to +125°C
5962R1121307V9A	ISL705AEHVX <sup>[3]</sup>		Die	N/A	
N/A	ISL705ARHF/PROTO <sup>[4]</sup>	N/A	8 Ld Flatpack	K8.A	
N/A	ISL705ARHX/SAMPLE <sup>[3][4]</sup>	N/A	Die	N/A	
5962R1121301QXC	ISL705ARHQF	HDR to 100krad(Si)	8 Ld Flatpack	K8.A	
5962R1121301VXC	ISL705ARHVF		8 Ld Flatpack	K8.A	
5962R1121301V9A	ISL705ARHVX <sup>[3]</sup>		Die	N/A	
5962R1121308VXC	ISL705BEHVF	HDR to 100krad(Si), LDR to 50krad(Si)	8 Ld Flatpack	K8.A	
5962R1121308V9A	ISL705BEHVX <sup>[3]</sup>		Die	N/A	
N/A	ISL705BRHF/PROTO <sup>[4]</sup>	N/A	8 Ld Flatpack	K8.A	
N/A	ISL705BRHX/SAMPLE <sup>[3][4]</sup>	N/A	Die	N/A	
5962R1121302QXC	ISL705BRHQF	HDR to 100krad(Si)	8 Ld Flatpack	K8.A	
5962R1121302VXC	ISL705BRHVF		8 Ld Flatpack	K8.A	
5962R1121302V9A	ISL705BRHVX <sup>[3]</sup>		Die	N/A	
5962R1121309VXC	ISL705CEHVF	HDR to 100krad(Si), LDR to 50krad(Si)	8 Ld Flatpack	K8.A	
5962R1121309V9A	ISL705CEHVX <sup>[3]</sup>		Die	N/A	
N/A	ISL705CRHF/PROTO <sup>[4]</sup>	N/A	8 Ld Flatpack	K8.A	
N/A	ISL705CRHX/SAMPLE <sup>[3][4]</sup>	N/A	Die	N/A	
5962R1121303QXC	ISL705CRHQF	HDR to 100krad(Si)	8 Ld Flatpack	K8.A	
5962R1121303VXC	ISL705CRHVF		8 Ld Flatpack	K8.A	
5962R1121303V9A	ISL705CRHVX <sup>[3]</sup>		Die	N/A	
5962R1121310VXC	ISL706AEHVF	HDR to 100krad(Si), LDR to 50krad(Si)	8 Ld Flatpack	K8.A	
5962R1121310V9A	ISL706AEHVX <sup>[3]</sup>		Die	N/A	
N/A	ISL706ARHF/PROTO <sup>[4]</sup>	N/A	8 Ld Flatpack	K8.A	
N/A	ISL706ARHX/SAMPLE <sup>[3][4]</sup>	N/A	Die	N/A	
5962R1121304QXC	ISL706ARHQF	HDR to 100krad(Si)	8 Ld Flatpack	K8.A	
5962R1121304VXC	ISL706ARHVF		8 Ld Flatpack	K8.A	
5962R1121304V9A	ISL706ARHVX <sup>[3]</sup>		Die	N/A	
5962R1121311VXC	ISL706BEHVF	HDR to 100krad(Si), LDR to 50krad(Si)	8 Ld Flatpack	K8.A	
5962R1121311V9A	ISL706BEHVX <sup>[3]</sup>		Die	N/A	
N/A	ISL706BRHF/PROTO <sup>[4]</sup>	N/A	8 Ld Flatpack	K8.A	

Ordering SMD Number <sup>[1]</sup>	Part Number <sup>[2]</sup>	Radiation Hardness (Total Ionizing Dose)	package description (RoHS Compliant)	Pkg. Dwg. #	Temp Range
N/A	ISL706BRHX/SAMPLE <sup>[3][4]</sup>	N/A	Die	N/A	-55 to +125°C
5962R1121305QXC	ISL706BRHQF	HDR to 100krad(Si)	8 Ld Flatpack	K8.A	
5962R1121305VXC	ISL706BRHVF		8 Ld Flatpack	K8.A	
5962R1121305V9A	ISL706BRHVX <sup>[3]</sup>		Die	N/A	
5962R1121312VXC	ISL706CEHVF	HDR to 100krad(Si), LDR to 50krad(Si)	8 Ld Flatpack	K8.A	
5962R1121312V9A	ISL706CEHVX <sup>[3]</sup>		Die	N/A	
N/A	ISL706CRHF/PROTO <sup>[4]</sup>	N/A	8 Ld Flatpack	K8.A	
N/A	ISL706CRHX/SAMPLE <sup>[3][4]</sup>	N/A	Die	N/A	
5962R1121306QXC	ISL706CRHQF	HDR to 100krad(Si)	8 Ld Flatpack	K8.A	
5962R1121306VXC	ISL706CRHVF		8 Ld Flatpack	K8.A	
5962R1121306V9A	ISL706CRHVX <sup>[3]</sup>		Die	N/A	
5962L1121317V9A	ISL735AEHVX <sup>[3]</sup>	LDR to 50krad(Si)	Die	N/A	
5962L1121317VXC	ISL735AEHVF		8 Ld Flatpack	K8.A	
N/A	ISL735AEHF/PROTO <sup>[4]</sup>	N/A	8 Ld Flatpack	K8.A	
N/A	ISL735AEHX/SAMPLE <sup>[3][4]</sup>	N/A	Die	N/A	
5962L1121318V9A	ISL735BEHVX <sup>[3]</sup>	LDR to 50krad(Si)	Die	N/A	
5962L1121318VXC	ISL735BEHVF		8 Ld Flatpack	K8.A	
N/A	ISL735BEHF/PROTO <sup>[4]</sup>	N/A	8 Ld Flatpack	K8.A	
N/A	ISL735BEHX/SAMPLE <sup>[3][4]</sup>	N/A	Die	N/A	
5962L1121319V9A	ISL735CEHVX <sup>[3]</sup>	LDR to 50krad(Si)	Die	N/A	
5962L1121319VXC	ISL735CEHVF		8 Ld Flatpack	K8.A	
N/A	ISL735CEHF/PROTO <sup>[4]</sup>	N/A	8 Ld Flatpack	K8.A	
N/A	ISL735CEHX/SAMPLE <sup>[3][4]</sup>	N/A	Die	N/A	
5962L1121320V9A	ISL736AEHVX <sup>[3]</sup>	LDR to 50krad(Si)	Die	N/A	
5962L1121320VXC	ISL736AEHVF		8 Ld Flatpack	K8.A	
N/A	ISL736AEHF/PROTO <sup>[4]</sup>	N/A	8 Ld Flatpack	K8.A	
N/A	ISL736AEHX/SAMPLE <sup>[3][4]</sup>	N/A	Die	N/A	
5962L1121321V9A	ISL736BEHVX <sup>[3]</sup>	LDR to 50krad(Si)	Die	N/A	
5962L1121321VXC	ISL736BEHVF		8 Ld Flatpack	K8.A	
N/A	ISL736BEHF/PROTO <sup>[4]</sup>	N/A	8 Ld Flatpack	K8.A	
N/A	ISL736BEHX/SAMPLE <sup>[3][4]</sup>	N/A	Die	N/A	
5962L1121322V9A	ISL736CEHVX <sup>[3]</sup>	LDR to 50krad(Si)	Die	N/A	
5962L1121322VXC	ISL736CEHVF		8 Ld Flatpack	K8.A	
N/A	ISL736CEHF/PROTO <sup>[4]</sup>	N/A	8 Ld Flatpack	K8.A	
N/A	ISL736CEHX/SAMPLE <sup>[3][4]</sup>	N/A	Die	N/A	

Ordering SMD Number <sup>[1]</sup>	Part Number <sup>[2]</sup>	Radiation Hardness (Total Ionizing Dose)	package description (RoHS Compliant)	Pkg. Dwg. #	Temp Range
N/A	ISL705XRHEVAL1Z <sup>[5]</sup>	ISL705xRH Evaluation Board			
N/A	ISL706XRHEVAL1Z <sup>[5]</sup>	ISL706xRH Evaluation Board			

- Specifications for Rad Hard QML devices are controlled by the Defense Logistics Agency Land and Maritime (DLA). The SMD numbers listed must be used when ordering.
- These Pb-free Hermetic packaged products employ 100% Au plate - e4 termination finish, which is RoHS compliant and compatible with both SnPb and Pb-free soldering operations.
- Die product tested at TA = + 25°C. The wafer probe test includes functional and parametric testing sufficient to make the die capable of meeting the electrical performance outlined in the [Electrical Specifications](#).
- The /PROTO and /SAMPLE are not rated or certified for Total Ionizing Dose (TID) or Single Event Effect (SEE) immunity. These parts are intended for engineering evaluation purposes only. The /PROTO parts meet the electrical limits and conditions across temperature specified in the DLA SMD and are in the same form and fit as the qualified device. The /SAMPLE parts are capable of meeting the electrical limits and conditions specified in the DLA SMD. The /SAMPLE parts do not receive 100% screening across temperature to the DLA SMD electrical limits. These part types do not come with a Certificate of Conformance because they are not DLA qualified devices.
- Evaluation board uses the /PROTO parts. The /PROTO parts are not rated or certified for Total Ionizing Dose (TID) or Single Event Effect (SEE) immunity.

### 13. Revision History

Revision	Date	Description
6.04	Jun 21, 2024	Applied latest template. Updated Features section. Updated Selecting Pull-Up Resistor Values section.
6.03	Apr 4, 2024	Added PFI pin description text to clarify function vs VDD bias voltage.
6.02	Feb 7, 2024	Updated Figures 3A, 3B, and 3C. Updated Watchdog Output pin description.
6.01	Mar 2, 2022	Updated the ordering information table by changing the rad level in the DLA SMD part number from 5962R to 5962L for the ISL735xEH and ISL736xEH parts. Removed Related Literature section.
6.00	Apr 23, 2020	Added ISL735xEH and ISL736xEH product information throughout datasheet. Updated Rad Hard information on page 1 and ordering information table. Updated Note 4 and added Note 3. Removed About Intersil section. Updated Disclaimer.
5.00	Feb 21, 2017	Updated Figure 5 on page 5.
4.00	July 29, 2016	Added ISL705EH and ISL706xEH product information throughout datasheet. Updated Figure 4 on page 5. Added Figures 13 and 14. Removed Post Radiation Characteristics table. Updated "Watchdog Timer" on page 15 by removing (1.0s min) reference. Updated "Interface Materials" on page 19 by removing second "Top Metallization" section.
3.00	Feb 10, 2015	Added part number ISL706CRH to the header of pages 2 through 12, (It had been mistakenly covered up).



Revision	Date	Description
2.00	Dec 9, 2014	<p>Added SEE, ELDRS, and SPICE Model reports to Related Literature on page 1.</p> <p>Added to Ordering Information table:            "Specifications for Rad Hard QML devices are controlled by the Defense Logistics Agency Land and Maritime (DLA). The SMD numbers listed in the "Ordering Information" table on page 2 must be used when ordering."</p> <p>Updated POD to most recent revision with following changes:</p> <p>a) Package tkn, Changed            From: 0.115/0.070 (2.92/1.18)            To: 0.110/0.087 (2.79/2.21)</p> <p>b) Bottom of lead to bottom of package, Changed            From: 0.045/0.026" (1.14/0.66)            To: 0.036/0.026 (0.92/0.66)</p> <p>c) Lead length, Changed:            From: 0.370/0.250 (9.40/6.35)            To: 0.370/0.325 (9.40/8.26)</p> <p>d) Lead tkn: On the side view there was a typo on lead tkn, corrected:            From: 0.09/0.04 (0.23/0.10)            To: 0.009/0.004 (0.23/0.10)</p> <p>Modified Note 2 by adding the words ..."in addition to or instead of"...</p>
1.00	Nov 1, 2011	<p>Page 13: Updated the transistor count to 1400 from 25000.</p> <p>Pages 7, 9: Removed erroneous overline bars in Figures 8-11.</p>
0.00	Sep 15, 2011	Initial release

## IMPORTANT NOTICE AND DISCLAIMER

RENESAS ELECTRONICS CORPORATION AND ITS SUBSIDIARIES (“RENESAS”) PROVIDES TECHNICAL SPECIFICATIONS AND RELIABILITY DATA (INCLUDING DATASHEETS), DESIGN RESOURCES (INCLUDING REFERENCE DESIGNS), APPLICATION OR OTHER DESIGN ADVICE, WEB TOOLS, SAFETY INFORMATION, AND OTHER RESOURCES “AS IS” AND WITH ALL FAULTS, AND DISCLAIMS ALL WARRANTIES, EXPRESS OR IMPLIED, INCLUDING, WITHOUT LIMITATION, ANY IMPLIED WARRANTIES OF MERCHANTABILITY, FITNESS FOR A PARTICULAR PURPOSE, OR NON-INFRINGEMENT OF THIRD-PARTY INTELLECTUAL PROPERTY RIGHTS.

These resources are intended for developers who are designing with Renesas products. You are solely responsible for (1) selecting the appropriate products for your application, (2) designing, validating, and testing your application, and (3) ensuring your application meets applicable standards, and any other safety, security, or other requirements. These resources are subject to change without notice. Renesas grants you permission to use these resources only to develop an application that uses Renesas products. Other reproduction or use of these resources is strictly prohibited. No license is granted to any other Renesas intellectual property or to any third-party intellectual property. Renesas disclaims responsibility for, and you will fully indemnify Renesas and its representatives against, any claims, damages, costs, losses, or liabilities arising from your use of these resources. Renesas' products are provided only subject to Renesas' Terms and Conditions of Sale or other applicable terms agreed to in writing. No use of any Renesas resources expands or otherwise alters any applicable warranties or warranty disclaimers for these products.

(Disclaimer Rev.1.01 Jan 2024)

### Corporate Headquarters

TOYOSU FORESIA, 3-2-24 Toyosu,  
Koto-ku, Tokyo 135-0061, Japan  
[www.renesas.com](http://www.renesas.com)

### Trademarks

Renesas and the Renesas logo are trademarks of Renesas Electronics Corporation. All trademarks and registered trademarks are the property of their respective owners.

### Contact Information

For further information on a product, technology, the most up-to-date version of a document, or your nearest sales office, please visit [www.renesas.com/contact-us/](http://www.renesas.com/contact-us/).