

ISL98608

High Efficiency Power Supply for Small Size Displays

FN8711
Rev.1.00
Mar 29, 2017

The **ISL98608** is a high efficiency power supply for small size displays, such as smart phones and tablets requiring \pm supply rails. It integrates a boost regulator, LDO and inverting charge pump that are used to generate two output rails: +5.5V (default) and -5.5V (default). The \pm 5.5V output voltages can be adjusted from \pm 4.5V up to \pm 7V with 50mV steps using the I²C interface.

The device integrates synchronous rectification MOSFETs for the boost regulator and inverting charge pump, which maximizes conversion efficiency.

ISL98608 integrates all compensation and feedback components, which minimizes BOM count and reduces the solution PCB size to 18mm².

The input voltage range, high efficiency operation and very low shutdown current make the device ideal for use in single cell Li-ion battery operated applications.

The ISL98608 is offered in a 1.744mm x1.744mm WLCSP package, and the device is specified for operation across the -40 °C to +85 °C ambient temperature range.

Features

- Two outputs:
 - VP = +5.5V (default)
 - VN = -5.5V (default)
- 2.5V to 5V input voltage range
- \pm 4.5 to \pm 7V wide output range
- >89% efficiency with 12mA load between VP and VN
- 18mm² solution PCB area
- Fully integrated FETs for synchronous rectification
- Integrated compensation and feedback circuits
- I²C adjustable output voltages and settings
- Integrated VP/VN discharge resistors
- 1 μ A shutdown supply current
- Programmable turn-on and turn-off sequencing
- 1.744mm x1.744mm, 4x4 array WLCSP with 0.4mm pitch

Applications

- TFT-LCD smart phone displays
- Small size/handheld displays

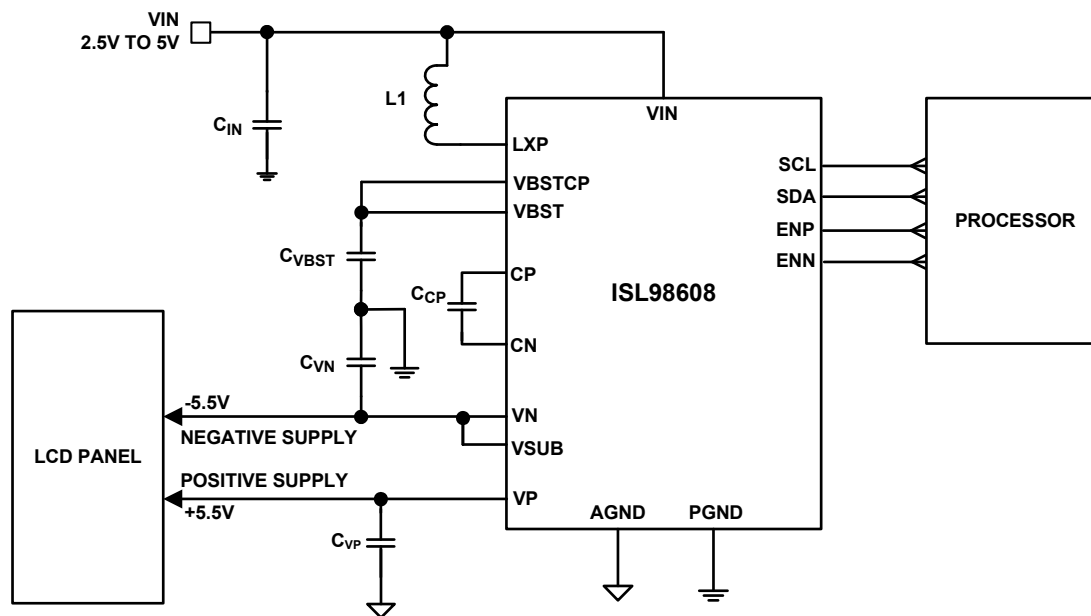

FIGURE 1. TYPICAL APPLICATION CIRCUIT: TFT-LCD SMART PHONE DISPLAY

Table of Contents

Block Diagram	3
Application Circuit Diagram	4
Ordering Information	4
Pin Configuration	5
Pin Descriptions	5
Absolute Maximum Ratings	6
Thermal Information	6
Recommended Operating Conditions	6
Electrical Specifications	6
Typical Performance Curves	8
Application Information	20
Description	20
Modes of Operation	20
I ² C Digital Interface	22
Write Operation	23
Read Operation	23
Register Descriptions and Addresses	24
Register Functions	24
Register Map	26
Display Power Supply Function Description	28
Regulator Output Enable/Disable	28
VP and VN Headroom Voltage and Output Current	28
Negative Charge Pump Operation (VN)	28
VN and VBST PFM	28
VP Output Hi-Z Mode	29
Power-On/Off Sequence	29
Enable Timing Control Options for VP and VN Regulators	32
Fault Protection and Monitoring	34
Component Selection	34
Input Capacitor	34
Inductor	34
Output Capacitor	35
General Layout Guidelines	35
ISL98608 Specific Layout Guidelines	36
ISL98608 Layout	37
Revision History	38
About Intersil	38
Package Outline Drawing	39

Block Diagram

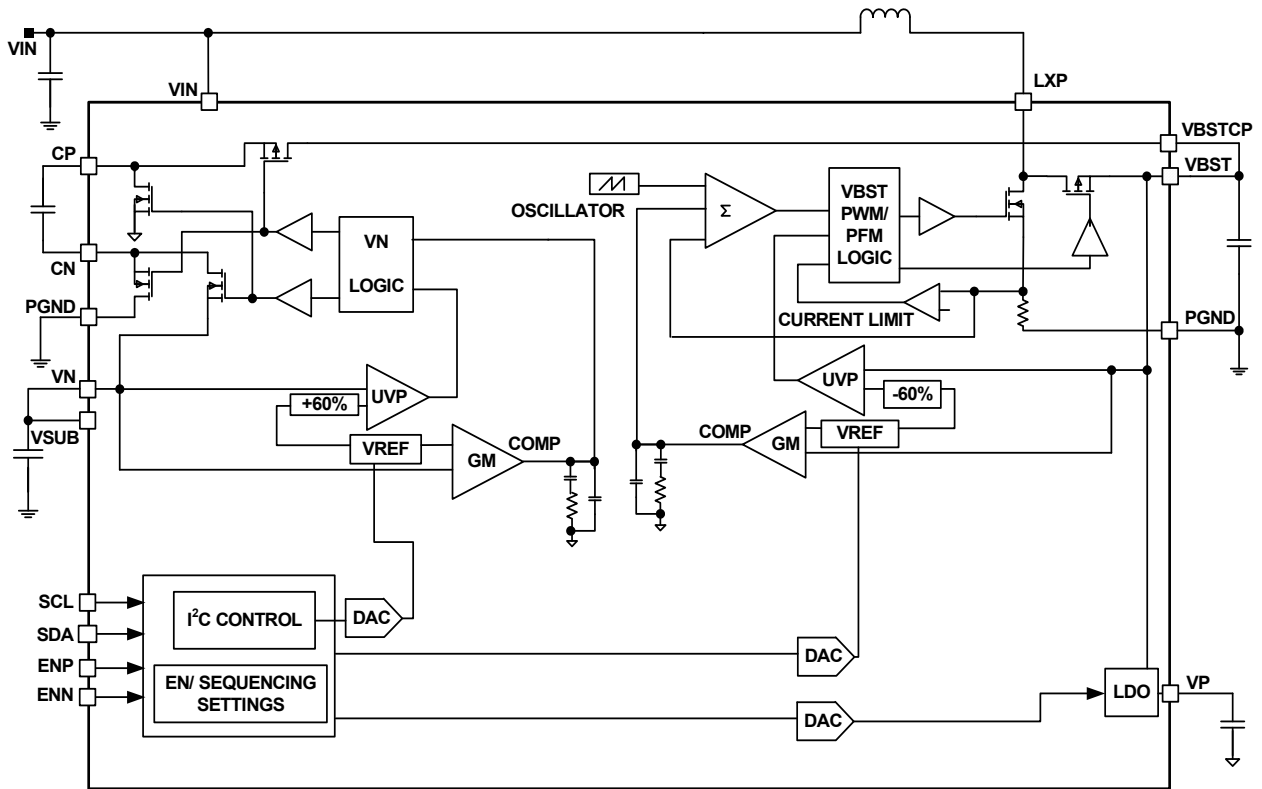

FIGURE 2. BLOCK DIAGRAM

Application Circuit Diagram

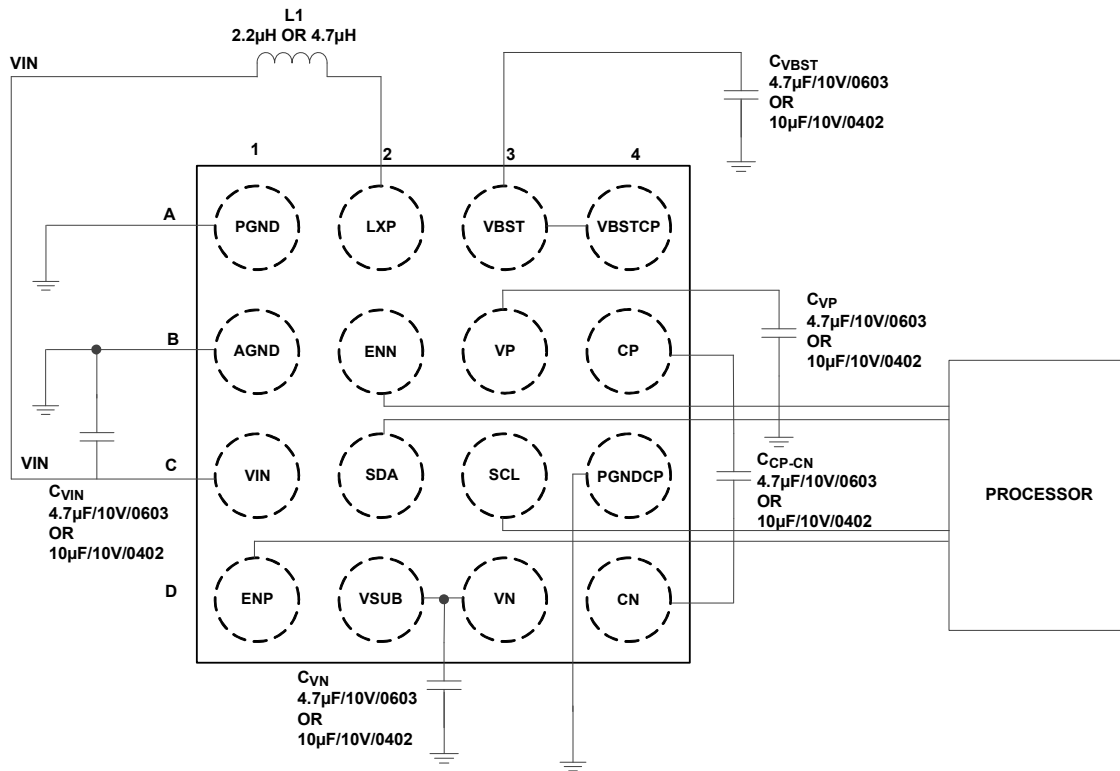

FIGURE 3. APPLICATION CIRCUIT DIAGRAM

Ordering Information

PART NUMBER (Notes 1, 2, 3)	PART MARKING	TEMP RANGE (°C)	TAPE AND REEL (UNITS)	PACKAGE (RoHS COMPLIANT)	PKG. DWG. #
ISL98608II55Z-T	6085	-40 to +85	3k	16 Ball (4x4 bump, 0.4mm pitch) WLCSP	W4x4.16G
ISL98608IIZ-EVZ	Evaluation Board				

NOTES:

- Please refer to [TB347](#) for details on reel specifications.
- These Intersil Pb-free WLCSP packaged products employ special Pb-free material sets; molding compounds/die attach materials and SnAgCu - e1 solder ball terminals, which are RoHS compliant and compatible with both SnPb and Pb-free soldering operations. Intersil Pb-free WLCSP packaged products are MSL classified at Pb-free peak reflow temperatures that meet or exceed the Pb-free requirements of IPC/JEDEC J STD-020.
- For Moisture Sensitivity Level (MSL), please see product information page for [ISL98608](#). For more information on MSL, please see tech brief [TB363](#).

Pin Configuration

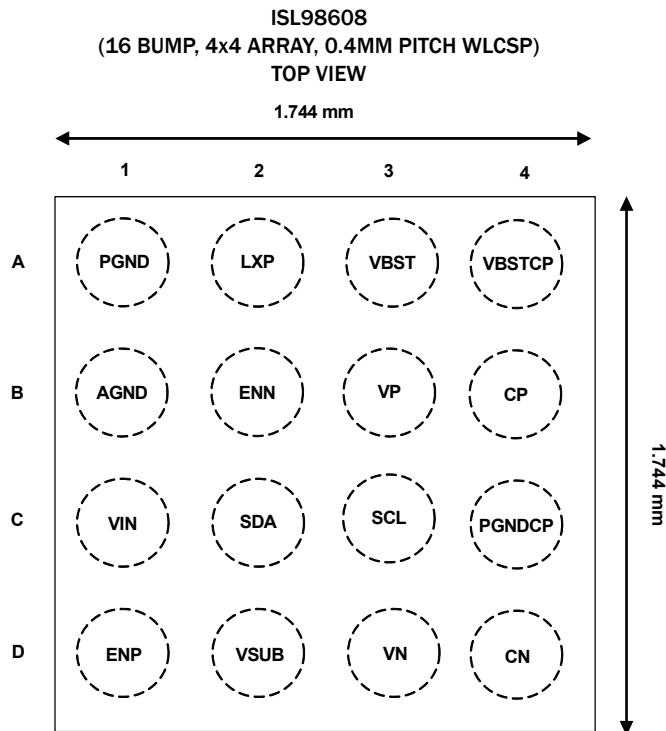

Pin Descriptions

PIN NUMBER	PIN NAME	DESCRIPTION
A1	PGND	Power ground for the boost converter.
A2	LXP	Switch node for boost converter. Connect an inductor between the VIN and LXP pins for boost converter operation.
A3	VBST	Boost converter output. The boost converter output supplies the power to the negative charge pump and LDO. Connect a 4.7µF/0603 or 10µF/0402 capacitor to ground.
A4	VBSTCP	Charge pump input. This pin must be connected to VBST on the PCB, so that the boost regulator provides the input voltage supply for the charge pump.
B1	AGND	Analog ground
B2	ENN	VBST and VN enable input. (Note 4)
B3	VP	Positive regulator output. Connect a 4.7µF/0603 or 10µF/0402 capacitor to ground.
B4	CP	Charge pump flying capacitor positive connection. Place a capacitor between CP and CN.
C1	VIN	Input supply voltage. Connect a 4.7µF/0603 or 10µF/0402 bypass capacitor from VIN to ground.
C2	SDA	Serial data connection for I ² C Interface. If this pin not used, connect this pin to VIN.
C3	SCL	Serial data connection for I ² C Interface. If this pin not used, connect this pin to VIN.
C4	PGNDCP	Power ground for the VN regulator.
D1	ENP	VBST and VP enable input. (Note 4)
D2	VSUB	Substrate connection. VSUB must be the most negative potential on the IC, connect VSUB to VN.
D3	VN	Negative charge pump output. Connect a 4.7µF/0603 or 10µF/0402 capacitor to ground. Connecting either two 4.7µF/0603 or 10µF/0402 capacitors to ground will lower the negative charge pump output voltage ripple.
D4	CN	Charge pump flying capacitor negative connection. Place a capacitor between CP and CN.

NOTE:

4. This pin has 1MΩ (typical) pull-down to AGND.

Absolute Maximum Ratings

VBST, VBSTCP, CP, VP to AGND	-0.3V to 8.5V
VN to AGND	+0.3V to -8.5V
VIN, SCL, SDA, ENN, ENP to AGND	-0.3V to 6V
LXP to AGND	-0.3V to VBST + 0.3V
CN to AGND	(VN - 0.3V) to PGND + 0.3V
Maximum Average Current Out of VBST Pin	1A
Maximum Average Current Into LXP Pin	1A
Maximum Average Current Into CN, CP Pin	-1A
ESD Rating	
Human Body Model (Tested per JESD22-A114F)	3kV
Machine Model (Tested per JESD22-A115C)	300V
Charged Device Model (Tested per JESD22-C101F)	1kV
Latch-Up (Tested per JESD78D; Class II)	100mA

Thermal Information

Thermal Resistance (Typical)	θ_{JA} (°C/W)	θ_{JB} (°C/W)
4x4 Bump 0.4mm pitch WLCSP (Notes 5, 6)	76	18
Maximum Junction Temperature	+125°C	
Storage Temperature Range	-65°C to +150°C	
Pb-Free Reflow Profile	see TB493	

Recommended Operating Conditions

Ambient Temperature Range	-40°C to +85°C
VIN	2.5V to 5V
VP	+4.5V to +7V
VN	-4.5V to -7V
VBST	+4.65V to +7.3V
Output Current Maximum (between VP and VN)	100mA

CAUTION: Do not operate at or near the maximum ratings listed for extended periods of time. Exposure to such conditions may adversely impact product reliability and result in failures not covered by warranty.

NOTES:

- θ_{JA} is measured in free air with the component mounted on a high effective thermal conductivity test board with "direct attach" features. See Tech Brief [TB379](#).
- For θ_{JB} , the "board temp" is taken on the board near the edge of the package, on a copper trace at the center of one side. See tech brief [TB379](#).

Electrical Specifications $V_{IN} = 3.7V$, unless otherwise noted. Typical specifications are characterized at $T_A = +25^\circ C$ unless otherwise noted. **Boldface limits apply across the operating temperature range, -40°C to +85°C.**

PARAMETER	SYMBOL	TEST CONDITIONS	MIN (Note 7)	TYP	MAX (Note 7)	UNIT
GENERAL						
V _{IN} Supply Voltage Range	V _{IN}		2.5		5.0	V
V _{IN} Supply Current	I _{IN}	ENP = ENN = SDA = SCL = 3.7V Enabled, LXP not switching		700		μA
V _{IN} Supply Current When Shutdown	I _{SHUTDOWN}	ENP = ENN = SDA = SCL = 0V		1		μA
Undervoltage Lockout Threshold	V _{UVLO}	V _{IN} rising		2.32	2.44	V
Undervoltage Lockout Hysteresis	V _{UVLO_HYS}			216		mV
BOOST REGULATOR (VBST)						
VBST Output Voltage	V _{VBST}	Register 0x06 = 0x00, no load		5.65		V
VBST Output Voltage Accuracy	V _{VBSTA}	2.5V < V _{IN} < 4.6V, Register 0x06 = 0x00	-2.5		2.5	%
VBST Output Voltage Programmable Range	V _{VBSTR}	Programmable in 50mV steps	4.65		7.30	V
Boost nFET Current Limit	I _{LIM_VBST}		1.1	1.4	1.6	A
VBST Output Current	I _{VBSTO}	2.5V < V _{IN} < 5V, VBST = 5.65V, Register 0x06 = 0x00	350			mA
Low-Side Switch ON-Resistance	r _{ON_VBSTL}	T _A = +25°C, I _{LOAD_VBST} = 100mA, LXP to PGND		110		mΩ
High-Side Switch ON-Resistance	r _{ON_VBSTH}	T _A = +25°C, I _{LOAD_VBST} = 100mA, LXP to VBST		145		mΩ
LXP Leakage Current	I _{L_LXP}	VLXP = 6V, ENP = ENN = 0V			10	μA
Boost Minimum Duty Cycle	D _{MIN}	Boost frequency = 1.45MHz		12.5		%
Boost Maximum Duty Cycle	D _{MAX}	Boost frequency = 1.45MHz		91		%
Boost Switching Frequency	f _{SWV_VBST}	Boost frequency = default	1.30	1.45	1.60	MHz
Boost Soft-Start Time	t _{SS_VBST}	C _{VBST} = 10μF (not derated), V _{IN} > V _{UVLO}		0.59	0.85	ms

Electrical Specifications $V_{IN} = 3.7V$, unless otherwise noted. Typical specifications are characterized at $T_A = +25^\circ C$ unless otherwise noted. **Boldface limits apply across the operating temperature range, $-40^\circ C$ to $+85^\circ C$.** (Continued)

PARAMETER	SYMBOL	TEST CONDITIONS	MIN (Note 7)	TYP	MAX (Note 7)	UNIT
NEGATIVE REGULATOR (VN)						
VN Output Voltage	V_{VN}	VN = -5.5V, Register 0x08 = 0x00, No Load		-5.5		V
VN Output Voltage Programmable Range	V_{VNR}	Programmable in 50mV steps	-7.0		-4.5	V
VN Output Voltage Accuracy	V_{ACC_VN}	VN = -5.5V, Register 0x08 = 0x00, Register 0x06 = 0x00, $-100mA < I_{LOAD_VN} < 0mA$	-2		2	%
Charge Pump Switching Frequency	f_{SW_VN}	CP Frequency = default, 50% duty cycle	1.30	1.45	1.60	MHz
Charge Pump Leakage Current	I_{L_CP}	CP pin, CP = 6V, ENN = 0V			10	μA
VN Discharge Resistance	R_{DCH_VN}	VN = -1V		35		Ω
VN Soft-Start Time	t_{SS_VN}	$C_{VN} = 10\mu F$ (not derated), VN = -5.5V, Register 0x08 = 0x00, Register 0x05 b ₇ = 0		1.96	2.39	ms
POSITIVE REGULATOR (VP)						
VP Output Voltage	V_{VP}	VP = 5.5V, Register 0x09 = 0x00, no load		5.5		V
VP Output Voltage Programmable Range	V_{VPR}	Programmable in 50mV steps	4.5		7.0	V
VP Output Voltage Accuracy	V_{ACC_VP}	VP = 5.5V, Register 0x09 = 0x00, Register 0x06 = 0x00, $0mA < I_{LOAD_VP} < 100mA$	-2		2	%
VP Dropout Voltage	V_{DRP_VP}	$I_{LOAD_VP} = 100mA$			100	mV
VP Leakage Current	I_{L_VP}	VP pin, VP = 0V, ENP = 0V			2	μA
VP Discharge Resistance	R_{DCH_VP}	VP = 1V		80		Ω
VP Soft-Start	t_{SS_VP}	$C_{VP} = 10\mu F$ (not derated), VP = 5.5V, Register 0x05 b ₇ = 0		1.23	1.53	ms
PROTECTION						
Thermal Shutdown Temperature	T_{OFF}	Die temperature (rising) when the device will disable/shutdown all outputs until it cools by $T_{HYS}^\circ C$		150		$^\circ C$
Thermal Shutdown Hysteresis	T_{HYS}	Die temperature below $T_{OFF}^\circ C$ when the device will re-enable the outputs after shutdown		20		$^\circ C$
VBST Undervoltage Limit	V_{UVP_VBST}			70% of VBST		V
VP Undervoltage Protection Threshold	V_{UVP_VP}			60% of VP		V
VN Undervoltage Protection Threshold	V_{UVP_VN}			60% of VN		V
Undervoltage Delay	$V_{UVDelay}$	Undervoltage delay for VBST, VN, VP		100		μs
LOGIC/DIGITAL						
Logic Input Low Voltage	V_{IL}	ENN, ENP, SCL, SDA			0.4	V
Logic Input High Voltage	V_{IH}	ENN, ENP, SCL, SDA	1.1			V
I ² C SCL Clock Frequency	f_{CLK}	(Note 8)			400	kHz
Debounce Time	t_d	ENN, ENP		10		μs
Internal Pull-Down Resistance	R_{EN}	ENN, ENP		1		M Ω

NOTES:

- Parameters with MIN and/or MAX limits are 100% tested at $+25^\circ C$, unless otherwise specified. Temperature limits established by characterization and are not production tested.
- For more detailed information regarding I²C timing characteristics refer to [Table 1 on page 22](#).

Typical Performance Curves

$T_A = +25^\circ\text{C}$, $V_{IN} = 3.7\text{V}$, $L_1 = 1239\text{AS-H-2R2M}$ (2.5mmx2mm), $C_{VBST} = 10\mu\text{F}/0402$, $C_{VP} = 10\mu\text{F}/0402$, $C_{VN} = 2 \times 10\mu\text{F}/0402$, $C_{CP} = 10\mu\text{F}/0402$ unless otherwise noted.

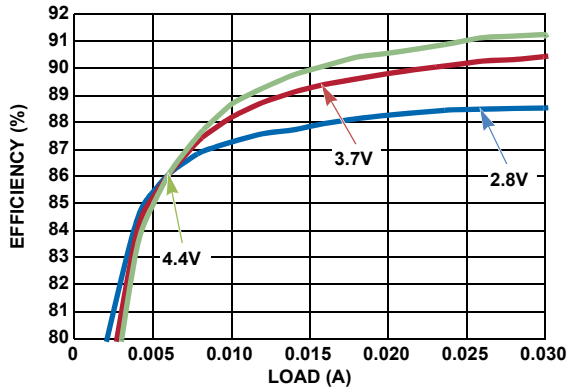

FIGURE 4. DISPLAY POWER SYSTEM EFFICIENCY, $V_P/V_N = \pm 5\text{V}$

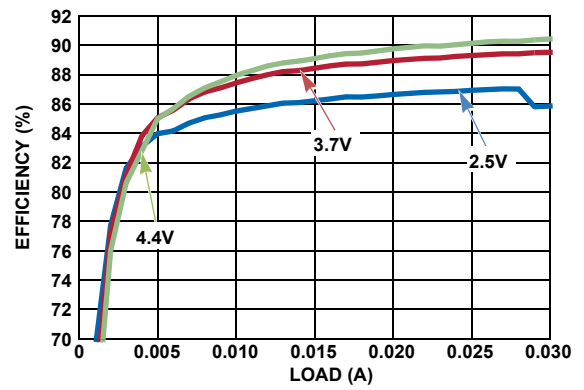

FIGURE 5. DISPLAY POWER SYSTEM EFFICIENCY, $V_P/V_N = \pm 5.5\text{V}$

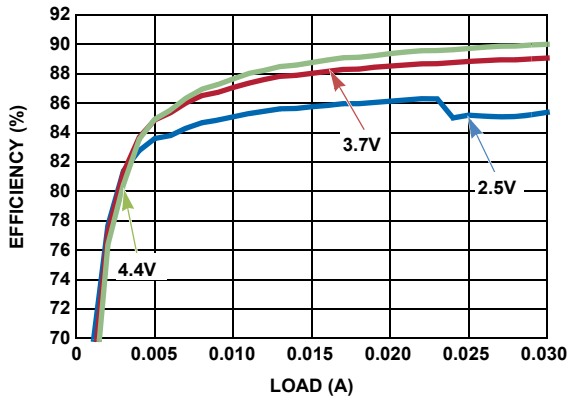

FIGURE 6. DISPLAY POWER SYSTEM EFFICIENCY, $V_P/V_N = \pm 6\text{V}$

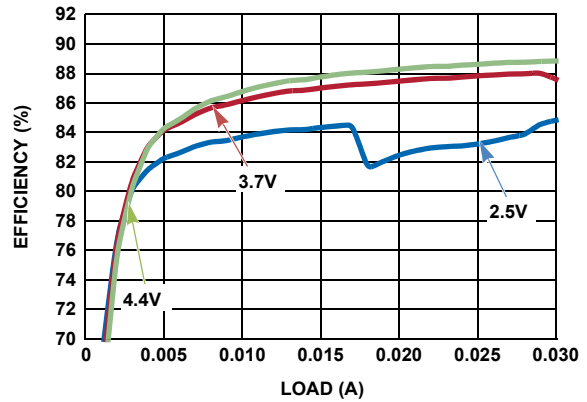

FIGURE 7. DISPLAY POWER SYSTEM EFFICIENCY, $V_P/V_N = \pm 7\text{V}$

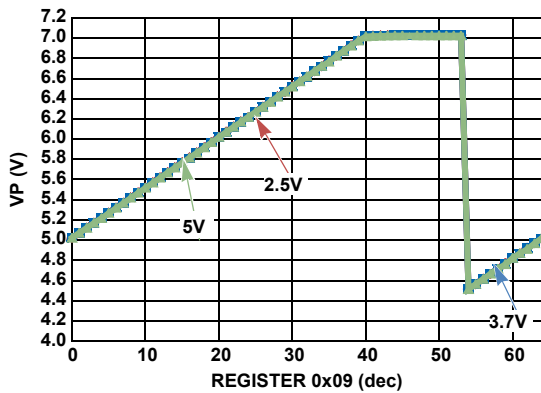

FIGURE 8. V_P OUTPUT VOLTAGE RANGE

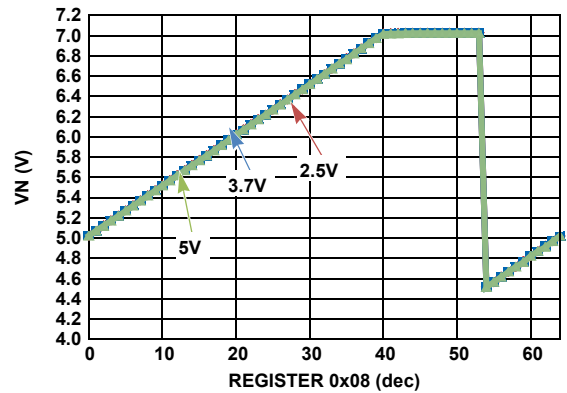

FIGURE 9. V_N OUTPUT VOLTAGE RANGE

Typical Performance Curves

$T_A = +25^\circ\text{C}$, $V_{IN} = 3.7\text{V}$, $L_1 = 1239\text{AS-H-2R2M}$ (2.5mmx2mm), $C_{VBST} = 10\mu\text{F}/0402$, $C_{VP} = 10\mu\text{F}/0402$, $C_{VN} = 2 \times 10\mu\text{F}/0402$, $C_{CP} = 10\mu\text{F}/0402$ unless otherwise noted. (Continued)

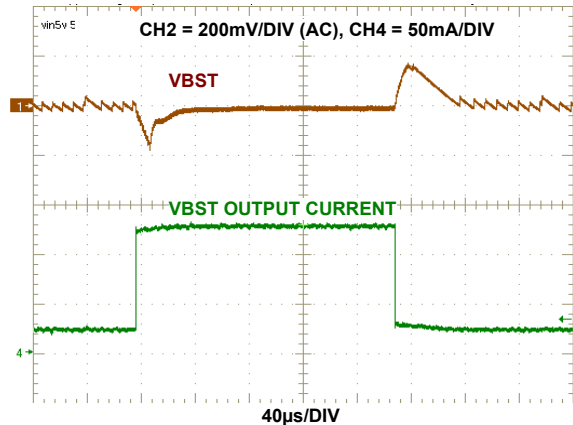

FIGURE 10. VBST LOAD TRANSIENT, VBST = 5.15V

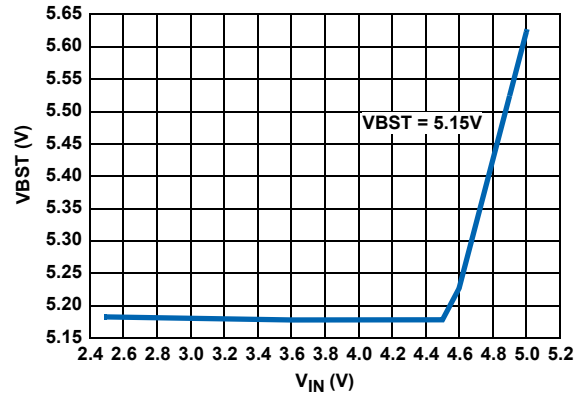

FIGURE 11. VBST, LINE REGULATION, VBST = 5.15V



FIGURE 12. VBST, V_{IN} HEADROOM TRACKING, VBST = 5.65V

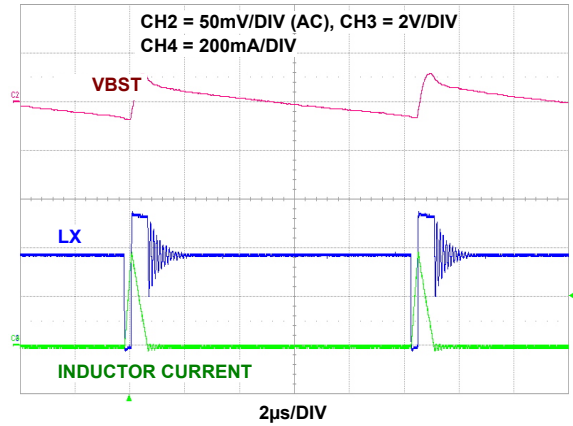

FIGURE 13. VBST RIPPLE, 10mA LOAD, VBST = 5.15V

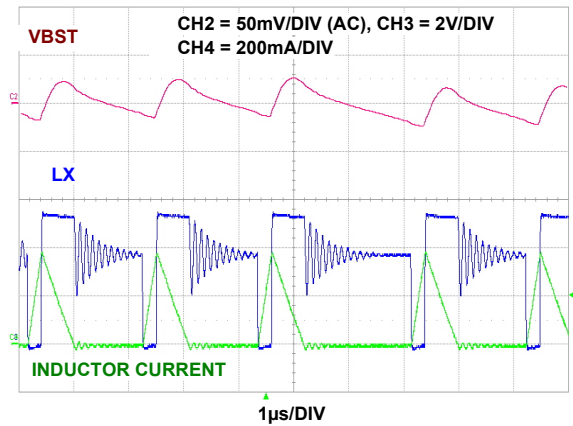

FIGURE 14. VBST RIPPLE, 50mA LOAD, VBST = 5.15V

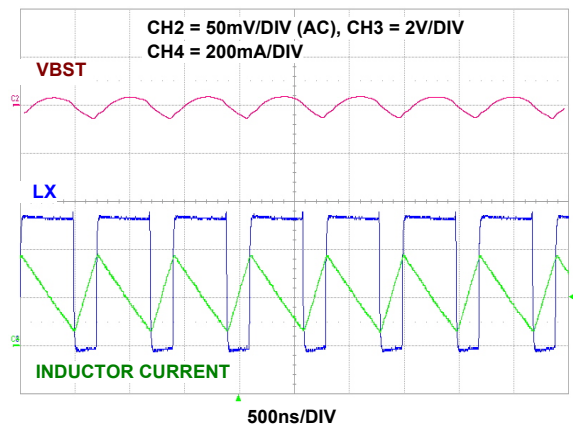

FIGURE 15. VBST RIPPLE, 150mA LOAD, VBST = 5.15V

Typical Performance Curves

$T_A = +25^\circ\text{C}$, $V_{IN} = 3.7\text{V}$, $L_1 = 1239\text{AS-H-2R2M}$ (2.5mmx2mm), $C_{VBST} = 10\mu\text{F}/0402$, $C_{VP} = 10\mu\text{F}/0402$, $C_{VN} = 2 \times 10\mu\text{F}/0402$, $C_{CP} = 10\mu\text{F}/0402$ unless otherwise noted. **(Continued)**

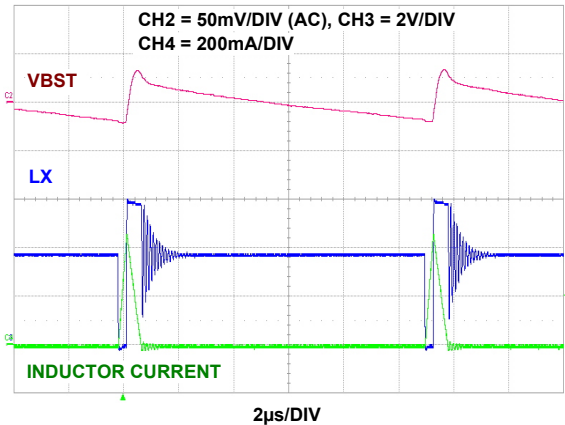

FIGURE 16. VBST RIPPLE, 10mA LOAD, VBST = 5.65V

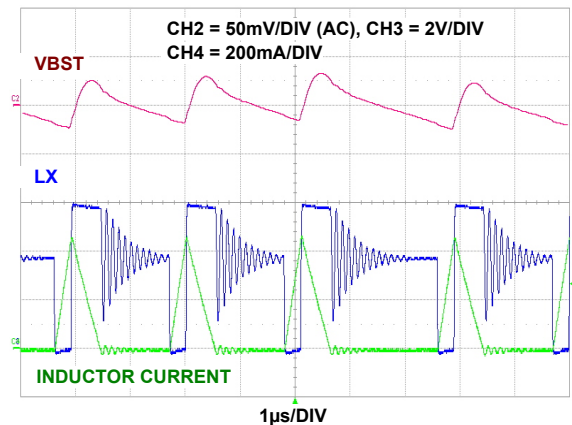

FIGURE 17. VBST RIPPLE, 50mA LOAD, VBST = 5.65V

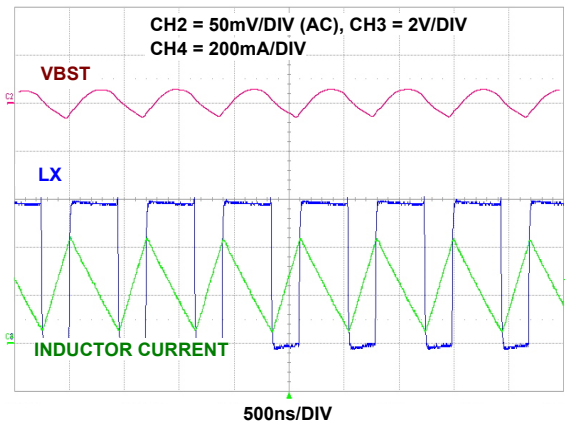

FIGURE 18. VBST RIPPLE, 150mA LOAD, VBST = 5.65V

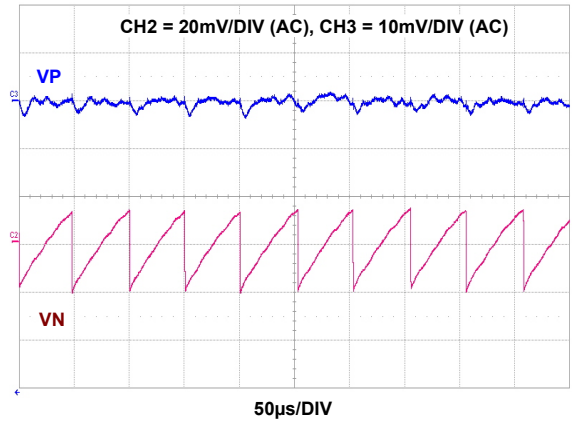

FIGURE 19. VP/VN (±5V) OUTPUT VOLTAGE RIPPLE, 2mA LOAD

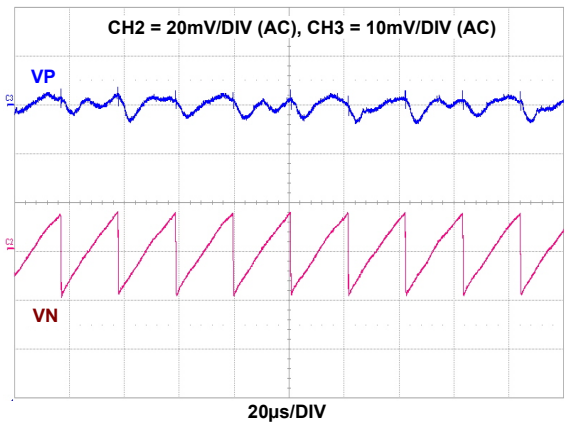

FIGURE 20. VP/VN (±5V) OUTPUT VOLTAGE RIPPLE, 5mA LOAD

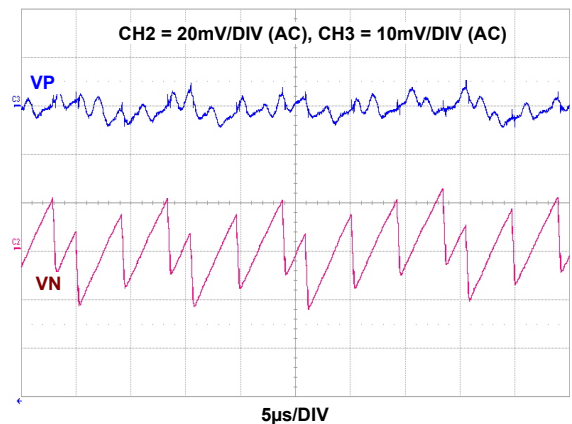

FIGURE 21. VP/VN (±5V) OUTPUT VOLTAGE RIPPLE, 30mA LOAD

Typical Performance Curves

$T_A = +25^\circ\text{C}$, $V_{IN} = 3.7\text{V}$, $L_1 = 1239\text{AS-H-2R2M}$ (2.5mmx2mm), $C_{V_{BST}} = 10\mu\text{F}/0402$, $C_{VP} = 10\mu\text{F}/0402$, $C_{VN} = 2 \times 10\mu\text{F}/0402$, $C_{CP} = 10\mu\text{F}/0402$ unless otherwise noted. (Continued)

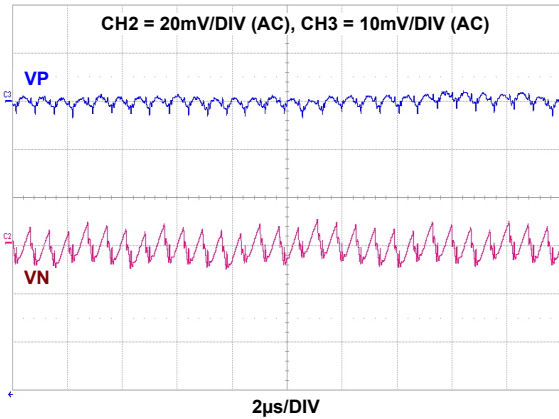

FIGURE 22. VP/VN ($\pm 5\text{V}$) OUTPUT VOLTAGE RIPPLE, 100mA LOAD

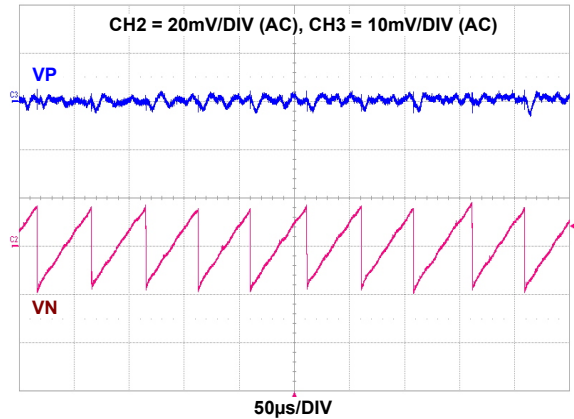

FIGURE 23. VP/VN ($\pm 5.5\text{V}$) OUTPUT VOLTAGE RIPPLE, 2mA LOAD

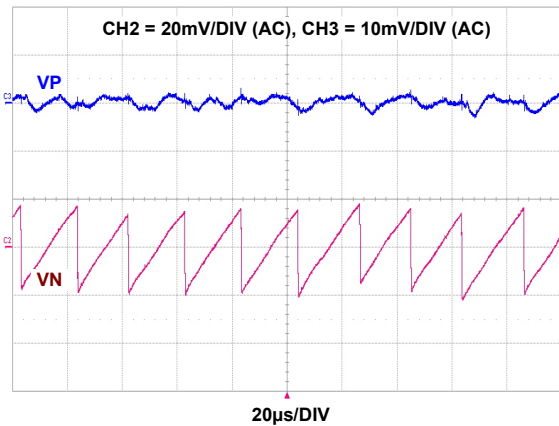

FIGURE 24. VP/VN ($\pm 5.5\text{V}$) OUTPUT VOLTAGE RIPPLE, 5mA LOAD

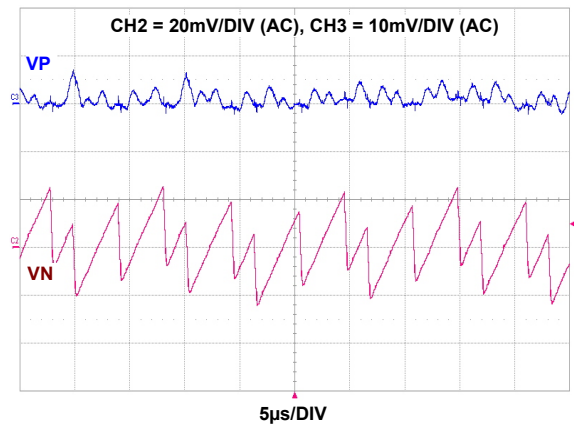

FIGURE 25. VP/VN ($\pm 5.5\text{V}$) OUTPUT VOLTAGE RIPPLE, 30mA LOAD

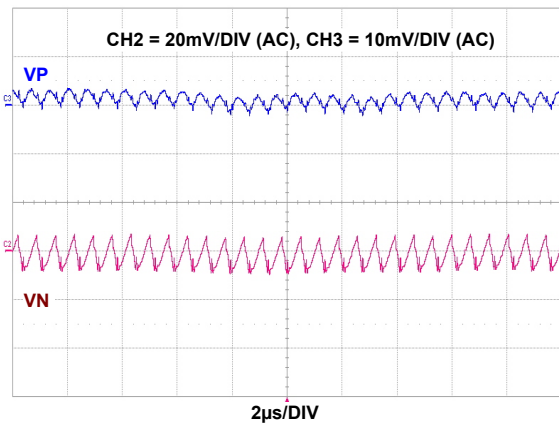

FIGURE 26. VP/VN ($\pm 5.5\text{V}$) OUTPUT VOLTAGE RIPPLE, 100mA LOAD

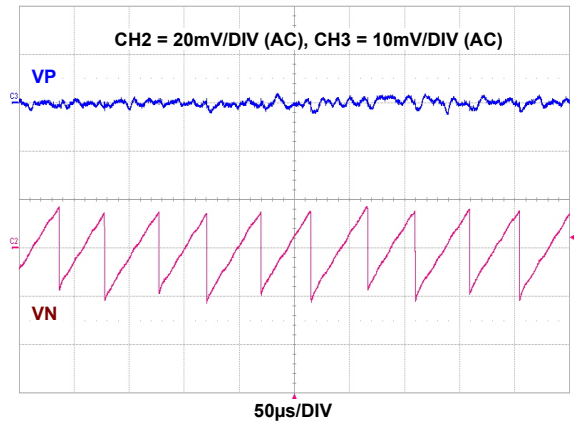

FIGURE 27. VP/VN ($\pm 6\text{V}$) OUTPUT VOLTAGE RIPPLE, 2mA LOAD

Typical Performance Curves

$T_A = +25^\circ\text{C}$, $V_{IN} = 3.7\text{V}$, $L_1 = 1239\text{AS-H-2R2M}$ (2.5mmx2mm), $C_{V_{BST}} = 10\mu\text{F}/0402$, $C_{VP} = 10\mu\text{F}/0402$, $C_{VN} = 2 \times 10\mu\text{F}/0402$, $C_{CP} = 10\mu\text{F}/0402$ unless otherwise noted. (Continued)

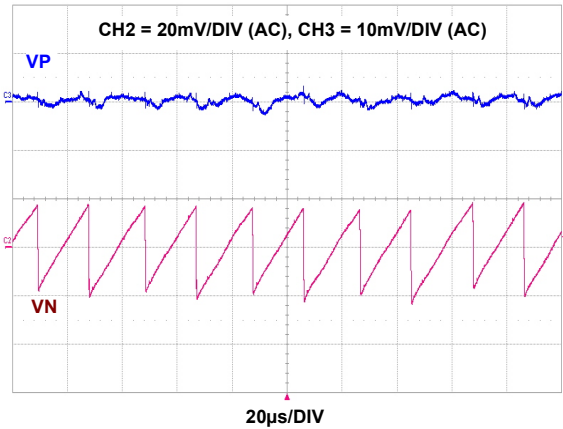

FIGURE 28. VP/VN ($\pm 6\text{V}$) OUTPUT VOLTAGE RIPPLE, 5mA LOAD

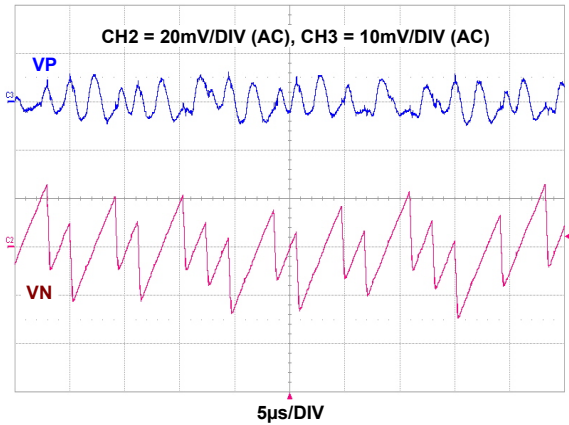

FIGURE 29. VP/VN ($\pm 6\text{V}$) OUTPUT VOLTAGE RIPPLE, 30mA LOAD

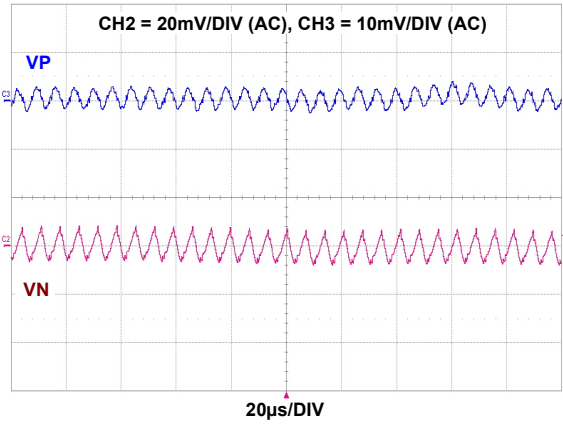

FIGURE 30. VP/VN ($\pm 6\text{V}$) OUTPUT VOLTAGE RIPPLE, 100mA LOAD

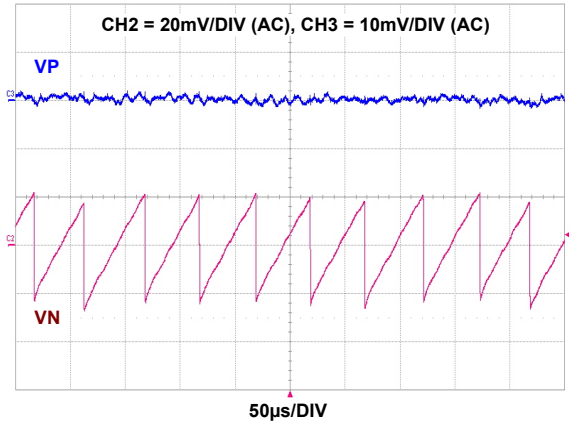

FIGURE 31. VP/VN ($\pm 7\text{V}$) OUTPUT VOLTAGE RIPPLE, 2mA LOAD

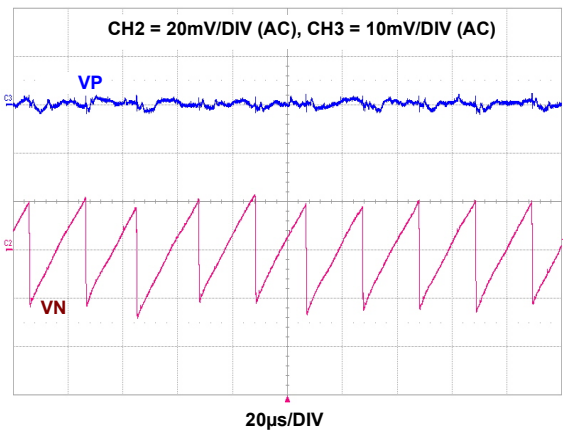

FIGURE 32. VP/VN ($\pm 7\text{V}$) OUTPUT VOLTAGE RIPPLE, 5mA LOAD

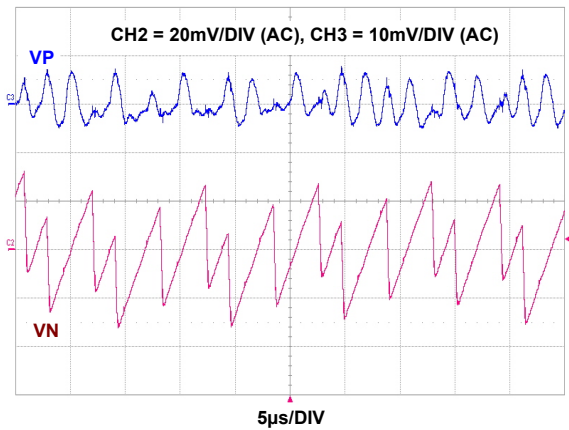

FIGURE 33. VP/VN ($\pm 7\text{V}$) OUTPUT VOLTAGE RIPPLE, 30mA LOAD

Typical Performance Curves

$T_A = +25^\circ\text{C}$, $V_{IN} = 3.7\text{V}$, $L_1 = 1239\text{AS-H-2R2M}$ (2.5mmx2mm), $C_{V_{BST}} = 10\mu\text{F}/0402$, $C_{VP} = 10\mu\text{F}/0402$, $C_{VN} = 2 \times 10\mu\text{F}/0402$, $C_{CP} = 10\mu\text{F}/0402$ unless otherwise noted. (Continued)

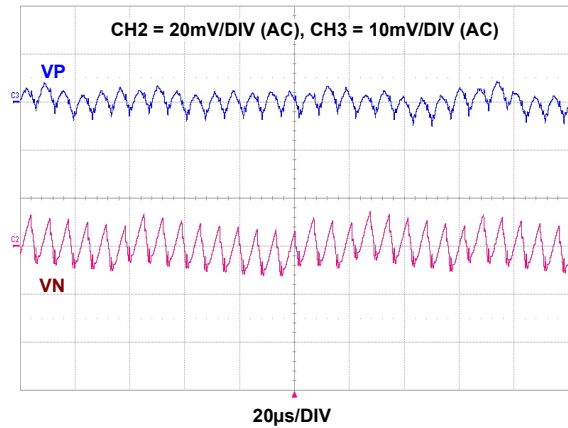

FIGURE 34. VP/VN ($\pm 7\text{V}$) OUTPUT VOLTAGE RIPPLE, 100mA LOAD

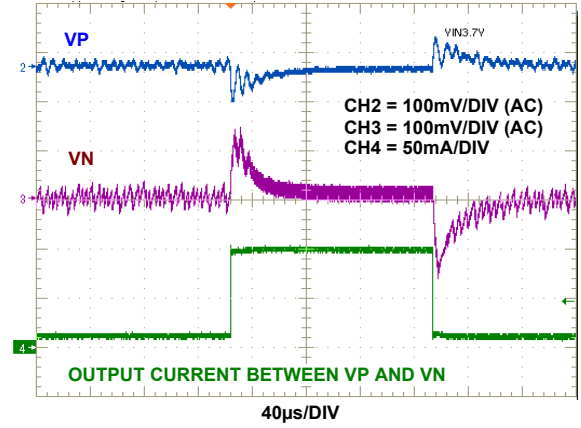

FIGURE 35. VP AND VN LOAD TRANSIENT, VP/VN = $\pm 5\text{V}$

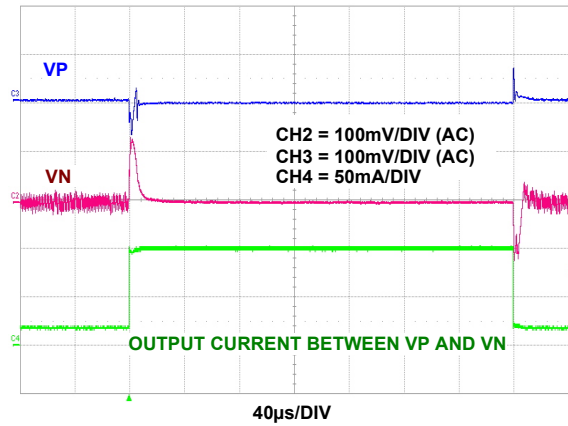

FIGURE 36. VP AND VN ($\pm 5\text{V}$) LOAD TRANSIENT, VP/VN = $\pm 5.5\text{V}$

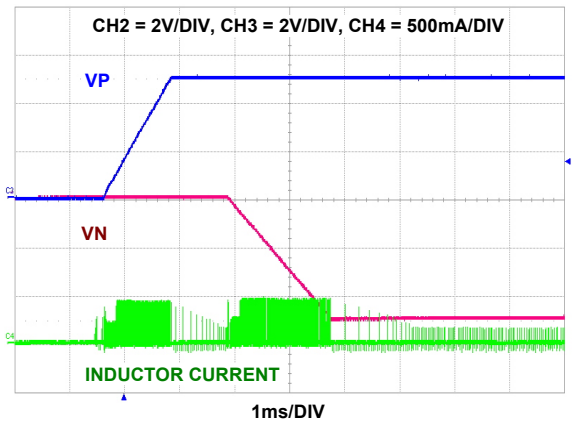

FIGURE 37. VP AND VN ($\pm 5\text{V}$) SOFT-START AT 2.5V INPUT VOLTAGE, VP/VN SEQUENCED (Reg 0x04 <b₄> = 0)

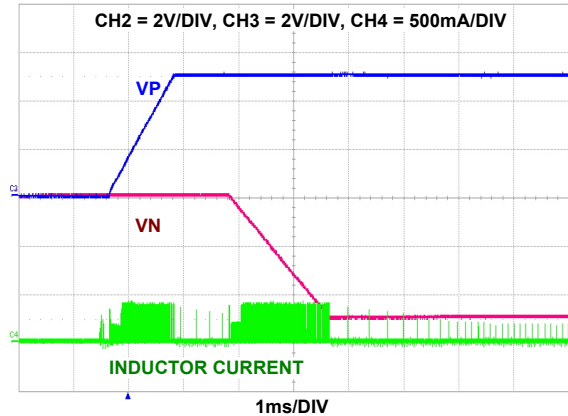

FIGURE 38. VP AND VN ($\pm 5\text{V}$) SOFT-START AT 3.7V INPUT VOLTAGE, VP/VN SEQUENCED (Reg 0x04 <b₄> = 0)

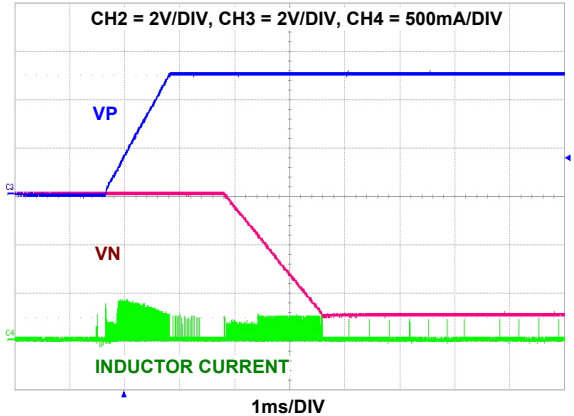

FIGURE 39. VP AND VN ($\pm 5\text{V}$) SOFT-START AT 5V INPUT VOLTAGE, VP/VN SEQUENCED (Reg 0x04 <b₄> = 0)

Typical Performance Curves

$T_A = +25^\circ\text{C}$, $V_{IN} = 3.7\text{V}$, $L_1 = 1239\text{AS-H-2R2M}$ (2.5mmx2mm), $C_{V_{BST}} = 10\mu\text{F}/0402$, $C_{VP} = 10\mu\text{F}/0402$, $C_{VN} = 2 \times 10\mu\text{F}/0402$, $C_{CP} = 10\mu\text{F}/0402$ unless otherwise noted. (Continued)

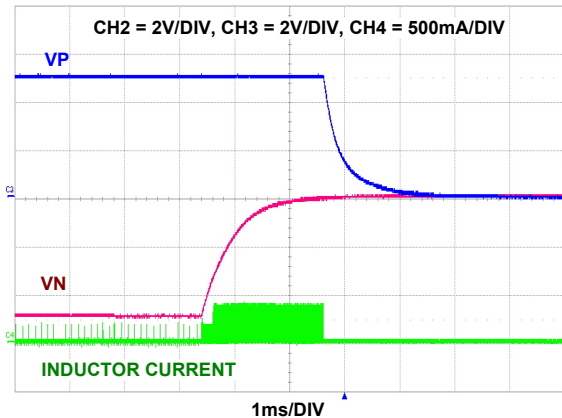

FIGURE 40. VP AND VN ($\pm 5\text{V}$) SHUTDOWN, VP/VN SEQUENCED (Reg 0x05 b_4 = 0)

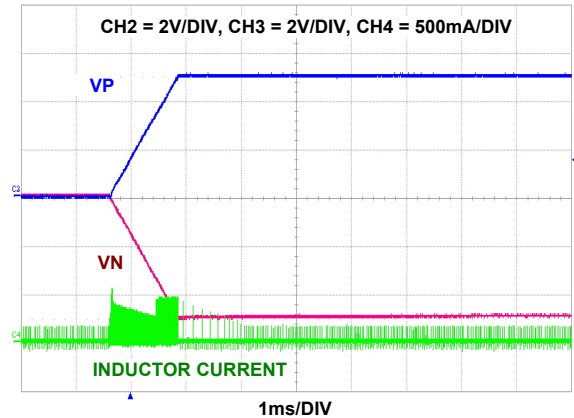

FIGURE 41. VP AND VN ($\pm 5\text{V}$) SOFT-START AT 2.5V INPUT VOLTAGE, VP/VN START TOGETHER (Reg 0x04 b_4 = 1)

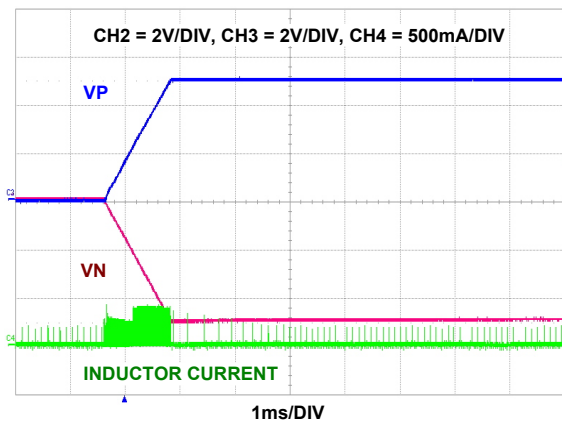

FIGURE 42. VP AND VN ($\pm 5\text{V}$) SOFT-START AT 3.7V INPUT VOLTAGE, VP/VN START TOGETHER (Reg 0x04 b_4 = 1)

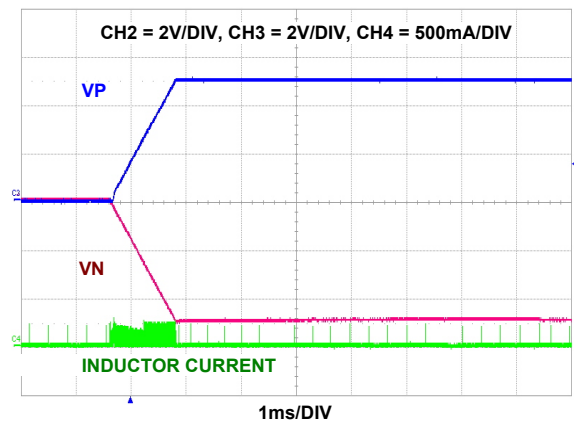

FIGURE 43. VP AND VN ($\pm 5\text{V}$) SOFT-START AT 5V INPUT VOLTAGE, VP/VN START TOGETHER (Reg 0x04 b_4 = 1)

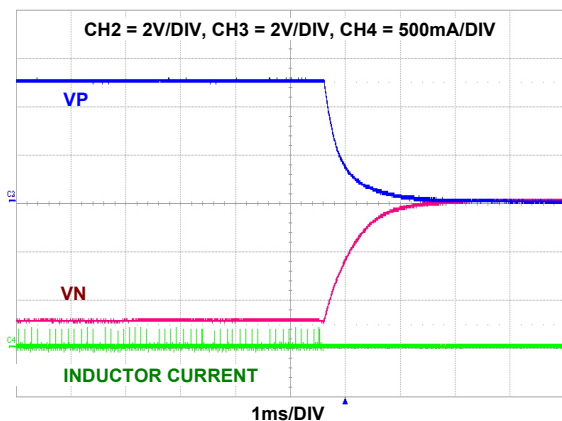

FIGURE 44. VP AND VN ($\pm 5\text{V}$) SHUTDOWN, VP/VN SHUTDOWN TOGETHER (Reg 0x05 b_4 = 1)

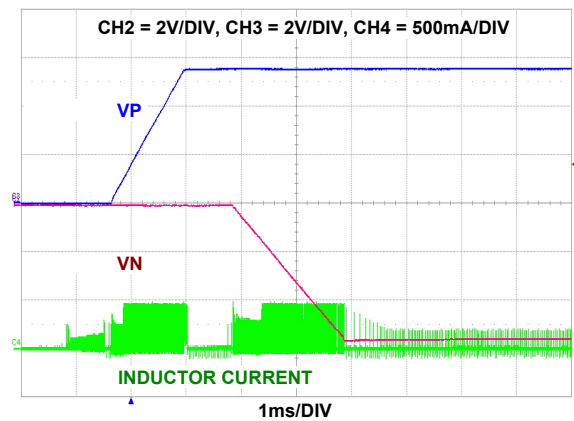

FIGURE 45. VP AND VN ($\pm 5\text{V}$) SOFT-START AT 2.5V INPUT VOLTAGE, VP/VN SEQUENCED (Reg 0x04 b_4 = 0)

Typical Performance Curves

$T_A = +25^\circ\text{C}$, $V_{IN} = 3.7\text{V}$, $L_1 = 1239\text{AS-H-2R2M}$ (2.5mmx2mm), $C_{V_{BST}} = 10\mu\text{F}/0402$, $C_{V_P} = 10\mu\text{F}/0402$, $C_{V_N} = 2 \times 10\mu\text{F}/0402$, $C_{C_P} = 10\mu\text{F}/0402$ unless otherwise noted. (Continued)

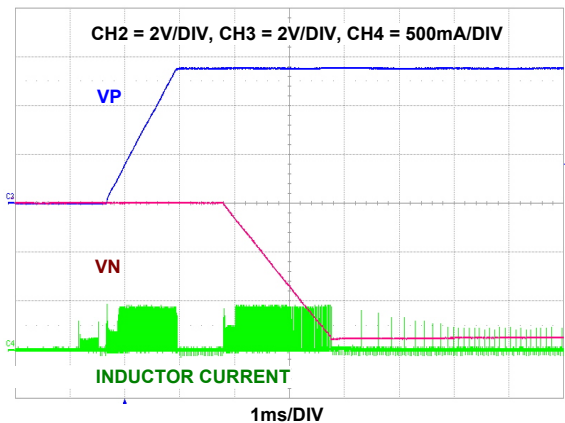

FIGURE 46. VP AND VN ($\pm 5.5\text{V}$) SOFT-START AT 3.7V INPUT VOLTAGE, VP/VN SEQUENCED (Reg 0x04 <b₄> = 0)

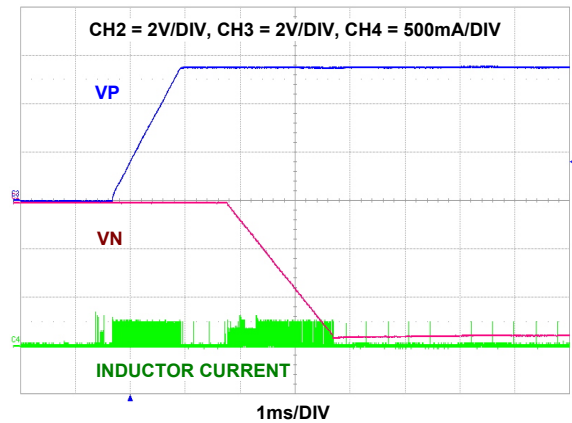

FIGURE 47. VP AND VN ($\pm 5.5\text{V}$) SOFT-START AT 5V INPUT VOLTAGE, VP/VN SEQUENCED (Reg 0x04 <b₄> = 0)

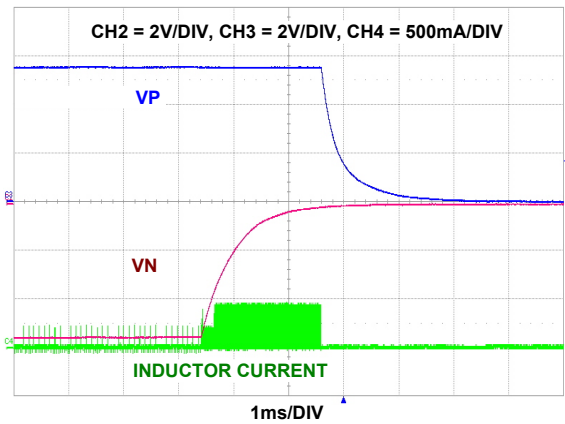

FIGURE 48. VP AND VN ($\pm 5.5\text{V}$) SHUTDOWN, VP/VN SEQUENCED (Reg 0x05 <b₄> = 0)

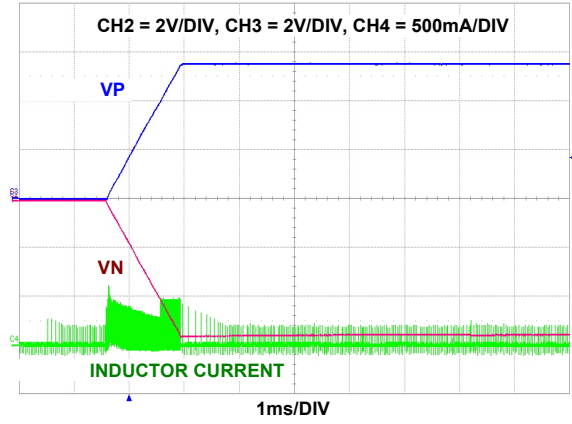

FIGURE 49. VP AND VN ($\pm 5.5\text{V}$) SOFT-START AT 2.5V INPUT VOLTAGE, VP/VN START TOGETHER (Reg 0x04 <b₄> = 1)

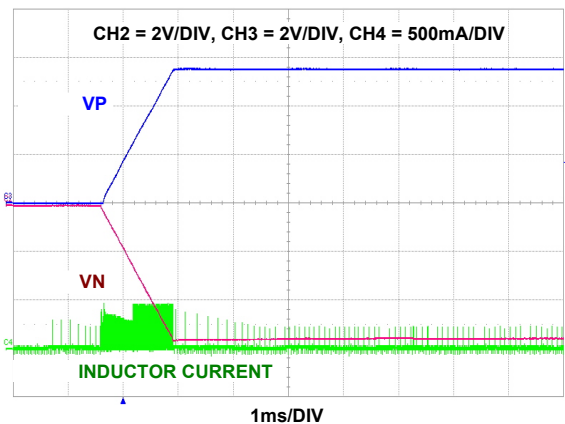

FIGURE 50. VP AND VN ($\pm 5.5\text{V}$) SOFT-START AT 3.7V INPUT VOLTAGE, VP/VN START TOGETHER (Reg 0x04 <b₄> = 1)

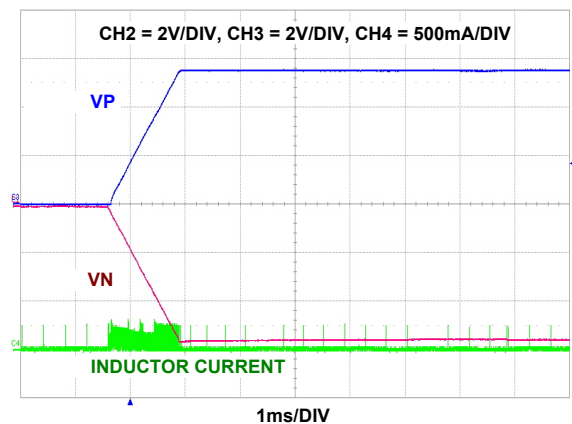

FIGURE 51. VP AND VN ($\pm 5.5\text{V}$) SOFT-START AT 5V INPUT VOLTAGE, VP/VN START TOGETHER (Reg 0x04 <b₄> = 1)

Typical Performance Curves

$T_A = +25^\circ\text{C}$, $V_{IN} = 3.7\text{V}$, $L_1 = 1239\text{AS-H-2R2M}$ (2.5mmx2mm), $C_{V_{BST}} = 10\mu\text{F}/0402$, $C_{VP} = 10\mu\text{F}/0402$, $C_{VN} = 2 \times 10\mu\text{F}/0402$, $C_{CP} = 10\mu\text{F}/0402$ unless otherwise noted. (Continued)

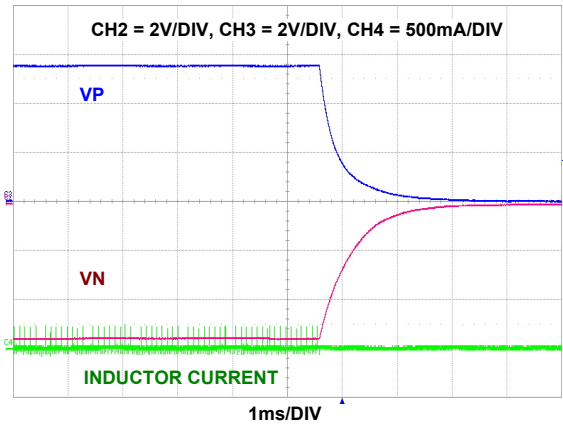

FIGURE 52. VP AND VN ($\pm 5.5\text{V}$) SHUTDOWN, VP/VN SHUTDOWN TOGETHER (Reg 0x05 b_4 = 1)

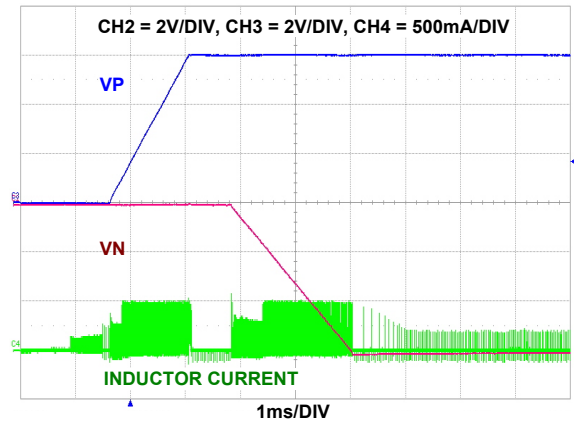

FIGURE 53. VP AND VN ($\pm 6\text{V}$) SOFT-START AT 2.5V INPUT VOLTAGE, VP/VN SEQUENCED (Reg 0x04 b_4 = 0)

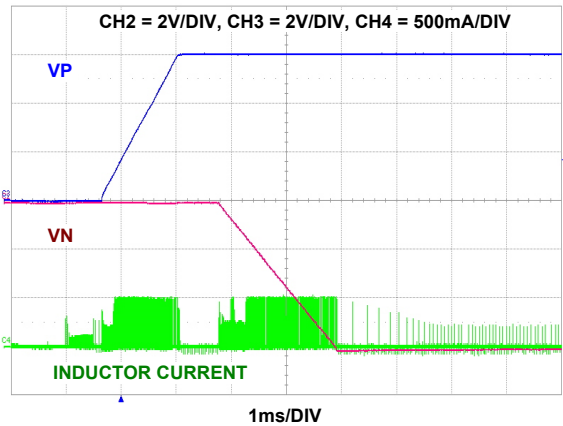

FIGURE 54. VP AND VN ($\pm 6\text{V}$) SOFT-START AT 3.7V INPUT VOLTAGE, VP/VN SEQUENCED (Reg 0x04 b_4 = 0)

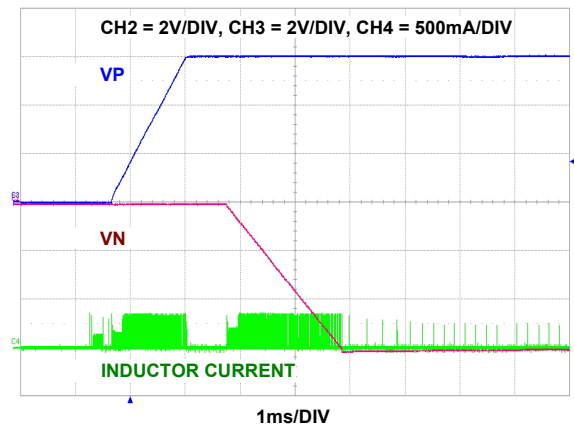

FIGURE 55. VP AND VN ($\pm 6\text{V}$) SOFT-START AT 5V INPUT VOLTAGE, VP/VN SEQUENCED (Reg 0x04 b_4 = 0)

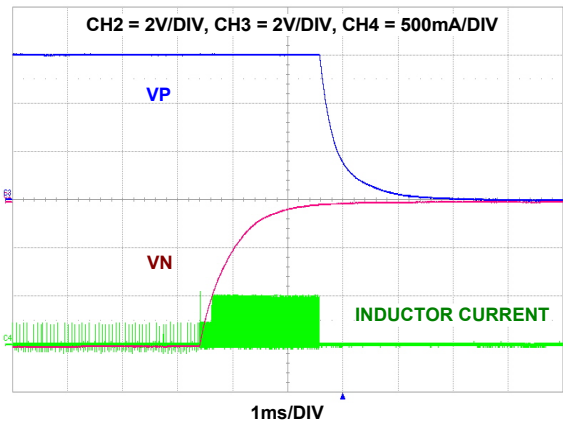

FIGURE 56. VP AND VN ($\pm 6\text{V}$) SHUTDOWN, VP/VN SEQUENCED (Reg 0x05 b_4 = 0)

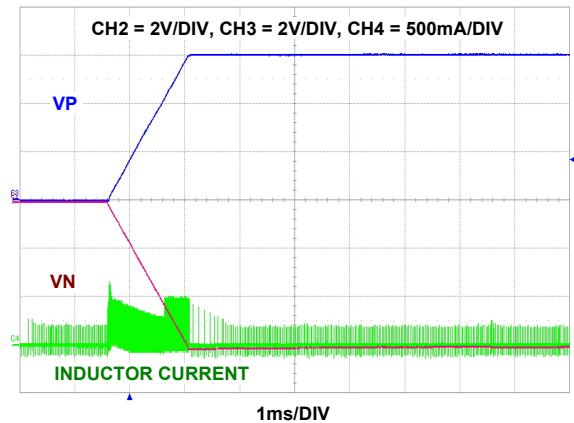

FIGURE 57. VP AND VN ($\pm 6\text{V}$) SOFT-START AT 2.5V INPUT VOLTAGE, VP/VN START TOGETHER (Reg 0x04 b_4 = 1)

Typical Performance Curves

$T_A = +25^\circ\text{C}$, $V_{IN} = 3.7\text{V}$, $L_1 = 1239\text{AS-H-2R2M}$ (2.5mmx2mm), $C_{VST} = 10\mu\text{F}/0402$, $C_{VP} = 10\mu\text{F}/0402$, $C_{VN} = 2 \times 10\mu\text{F}/0402$, $C_{CP} = 10\mu\text{F}/0402$ unless otherwise noted. (Continued)

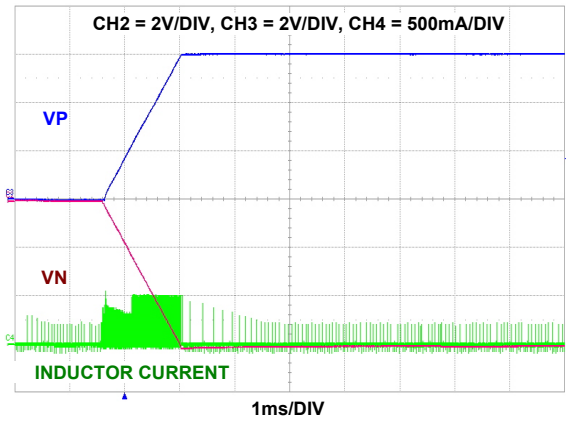

FIGURE 58. VP AND VN ($\pm 6\text{V}$) SOFT-START AT 3.7V INPUT VOLTAGE, VP/VN START TOGETHER (Reg 0x04 <b₄> = 1)

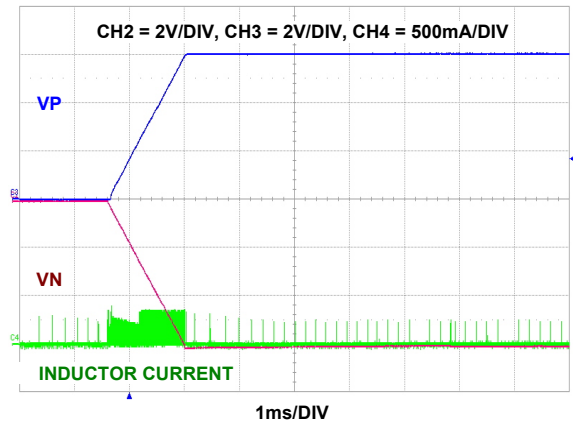

FIGURE 59. VP AND VN ($\pm 6\text{V}$) SOFT-START AT 5V INPUT VOLTAGE, VP/VN START TOGETHER (Reg 0x04 <b₄> = 1)

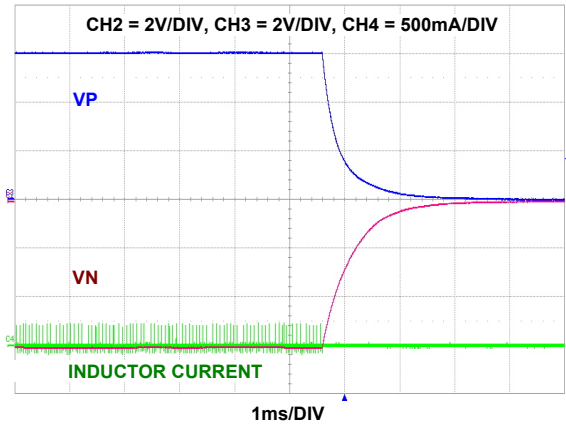

FIGURE 60. VP AND VN ($\pm 6\text{V}$) SHUTDOWN, VP/VN SHUTDOWN TOGETHER (Reg 0x05 <b₄> = 1)

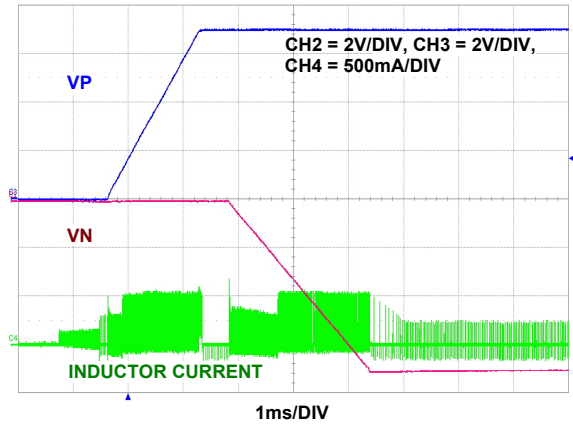

FIGURE 61. VP AND VN ($\pm 7\text{V}$) SOFT-START AT 2.5V INPUT VOLTAGE, VP/VN SEQUENCED (Reg 0x04 <b₄> = 0)

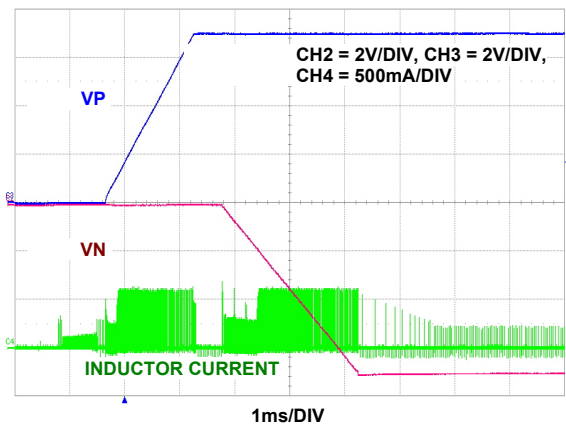

FIGURE 62. VP AND VN ($\pm 7\text{V}$) SOFT-START AT 3.7V INPUT VOLTAGE, VP/VN SEQUENCED (Reg 0x04 <b₄> = 0)

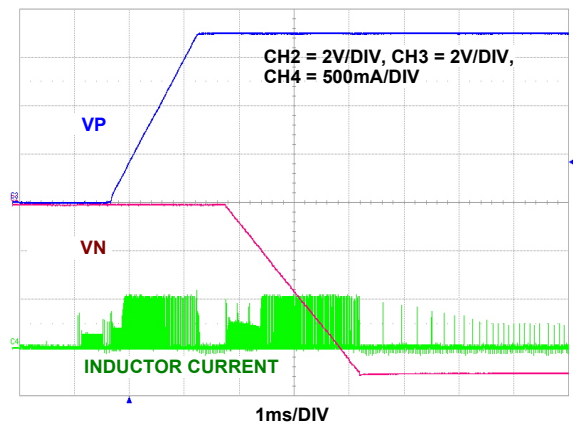

FIGURE 63. VP AND VN ($\pm 7\text{V}$) SOFT-START AT 5V INPUT VOLTAGE, VP/VN SEQUENCED (Reg 0x04 <b₄> = 0)

Typical Performance Curves

$T_A = +25^\circ\text{C}$, $V_{IN} = 3.7\text{V}$, $L_1 = 1239\text{AS-H-2R2M}$ (2.5mmx2mm), $C_{V_{BST}} = 10\mu\text{F}/0402$, $C_{VP} = 10\mu\text{F}/0402$, $C_{VN} = 2 \times 10\mu\text{F}/0402$, $C_{CP} = 10\mu\text{F}/0402$ unless otherwise noted. (Continued)

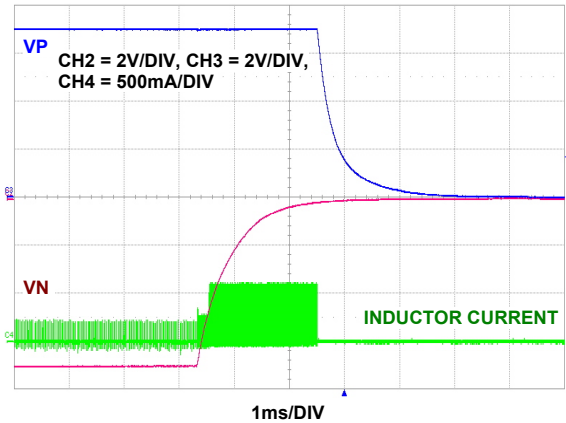

FIGURE 64. VP AND VN ($\pm 7\text{V}$) SHUTDOWN, VP/VN SEQUENCED (Reg 0x05 b_4 = 0)

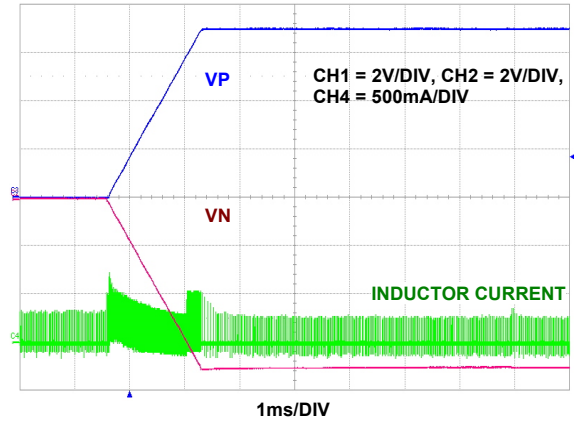

FIGURE 65. VP AND VN ($\pm 7\text{V}$) SOFT-START AT 2.5V INPUT VOLTAGE, VP/VN START TOGETHER (Reg 0x04 b_4 = 1)

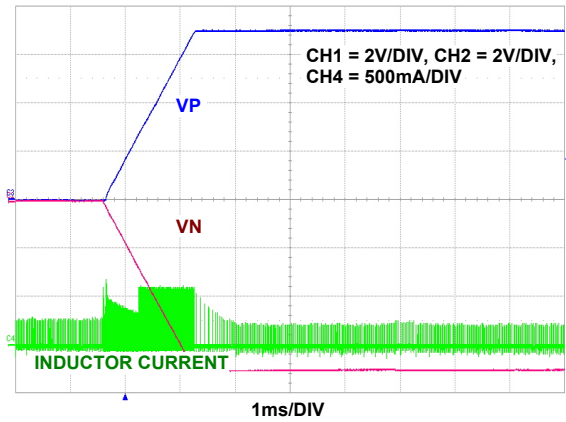

FIGURE 66. VP AND VN ($\pm 7\text{V}$) SOFT-START AT 3.7V INPUT VOLTAGE, VP/VN START TOGETHER (Reg 0x02 b_6 = 1)

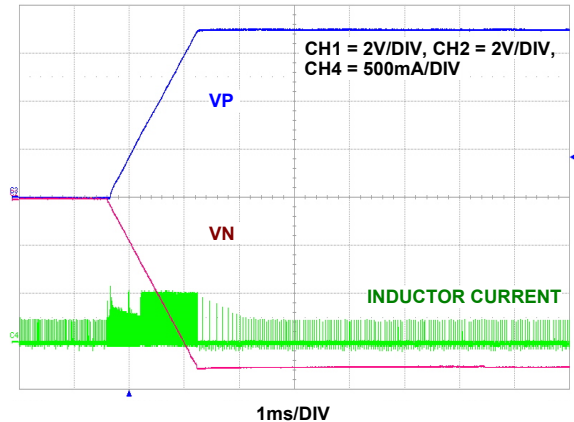

FIGURE 67. VP AND VN ($\pm 7\text{V}$) SOFT-START AT 5V INPUT VOLTAGE, VP/VN START TOGETHER (Reg 0x02 b_6 = 1)

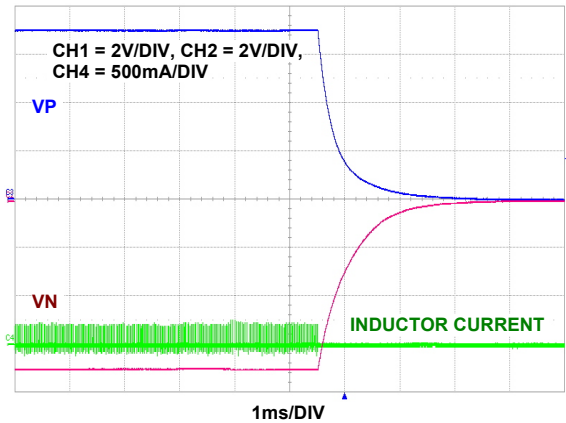

FIGURE 68. VP AND VN ($\pm 7\text{V}$) SHUTDOWN, VP/VN SHUTDOWN TOGETHER (Reg 0x05 b_4 = 1)

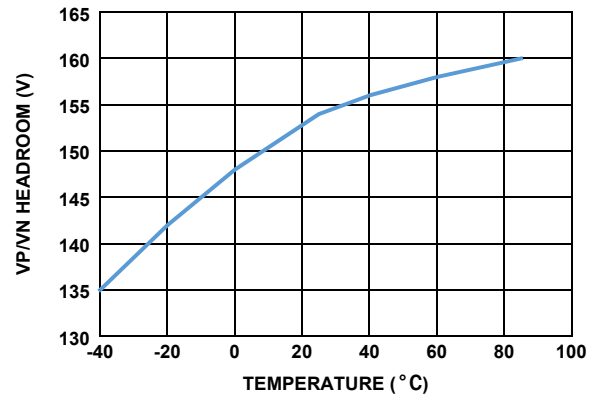

FIGURE 69. VP/VN HEADROOM vs TEMPERATURE

Typical Performance Curves

$T_A = +25^\circ\text{C}$, $V_{IN} = 3.7\text{V}$, $L_1 = 1239\text{AS-H-2R2M}$ (2.5mmx2mm), $C_{V_{BST}} = 10\mu\text{F}/0402$, $C_{V_P} = 10\mu\text{F}/0402$, $C_{V_N} = 2 \times 10\mu\text{F}/0402$, $C_{C_P} = 10\mu\text{F}/0402$ unless otherwise noted. (Continued)

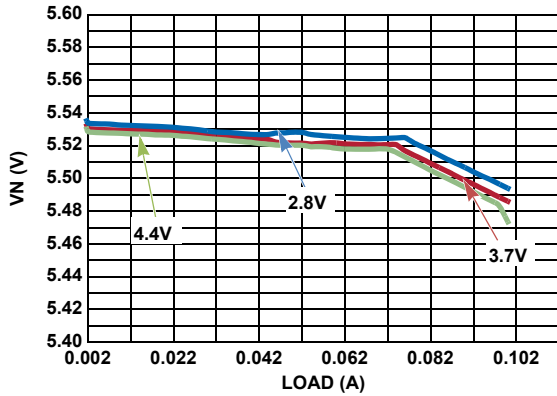

FIGURE 70. VN LOAD REGULATION, -5.5V

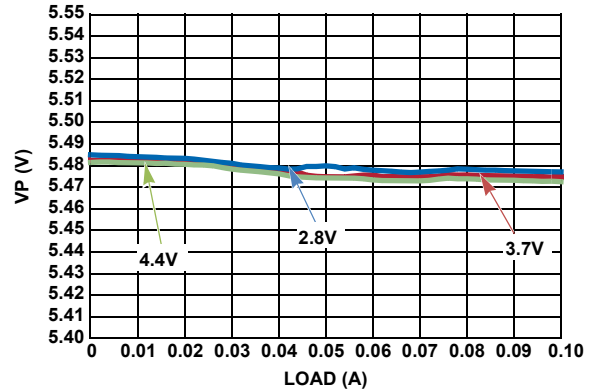

FIGURE 71. VP LOAD REGULATION, 5.5V

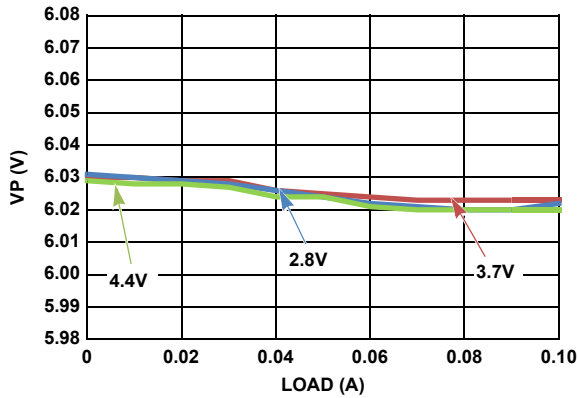

FIGURE 72. VP LOAD REGULATION, VP = 6V

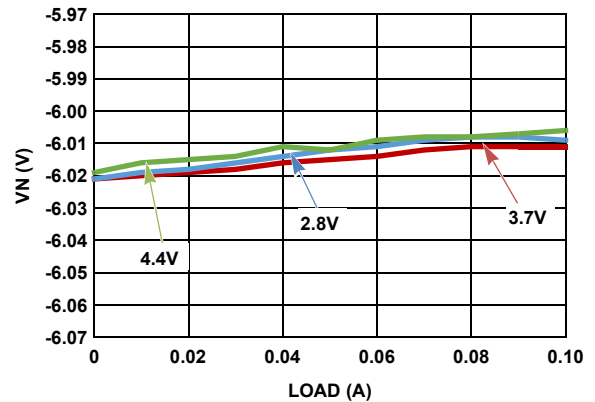

FIGURE 73. VN LOAD REGULATION, VN = -6V

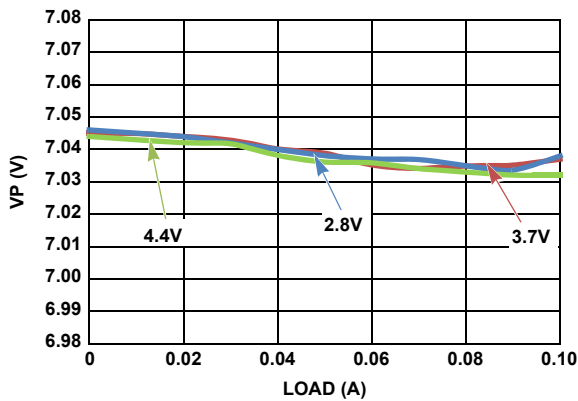

FIGURE 74. VP LOAD REGULATION, VP = 7V

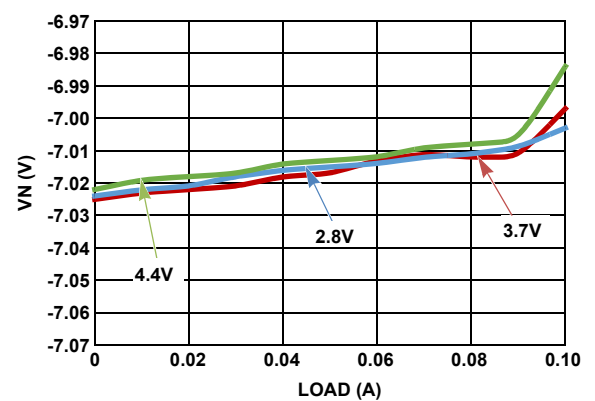

FIGURE 75. VN LOAD REGULATION, VN = -7V

Application Information

Description

The ISL98608 is a display PMIC and can be used to supply power to an LCD display. [Figure 76](#) shows the typical system application block diagram. For display power, the ISL98608 integrates a boost regulator (VBST), low dropout linear regulator (VP) and an inverting charge pump regulator (VN). The boost voltage is generated from a battery voltage ranging from 2.5V to 5V, and boost regulator output can be programmed from 4.60V to 7.3V. The VBST regulator integrates low-side NFET and high-side PFET MOSFETs for synchronous rectification.

The output voltage of VBST is the input to the linear regulator (VP). The VBST output and VP regulator input are connected internally in the IC. The VP regulator supplies a positive voltage in the range of +4.5V to +7V with 50mV resolution. The output load capability of the VP regulator is 150mA. 80Ω discharge resistor discharges residual voltage when the power-OFF sequence is initiated, which helps avoid ghost image issues. The LDO is an ideal solution for the positive supply for TFT-LCD panel due to its low ripple, fast load transient response, higher efficiency and low dropout voltage.

The VN voltage is generated by a regulated inverting charge pump topology. VBSTCP is the input to the inverting charge pump, which should be connected to the VBST pin on the PCB. The VN regulator supplies negative voltage from -7V to -4.5V with

50mV resolution. The output load capability of the VN regulator is 150mA. Similar to the VP regulator, the VN regulator also integrates a discharge resistor and the value of discharge resistor is 35Ω. The VN is an ideal solution for negative supply for TFT-LCD panel due to low ripple, fast load transient response and higher efficiency.

Modes of Operation

SHUTDOWN MODE

The ISL98608 is in shutdown mode when the enable pins, namely ENN and ENP are pulled low. When the ENN and ENP pins are all pulled low, all the regulators are powered off and the IC is placed in shutdown mode where the current consumed from the battery is only 1μA (typical).

OPERATING MODE

The IC is in normal operating mode when the ENN and ENP are pulled high, and the current consumed from the battery is only 1mA (excluding VBST and VN switching current). After the ENN/ENP signals are pulled high, VBST, VP and VN go through power-on sequencing. Refer to [“Power-On/Off Sequence” on page 29](#) for more details.

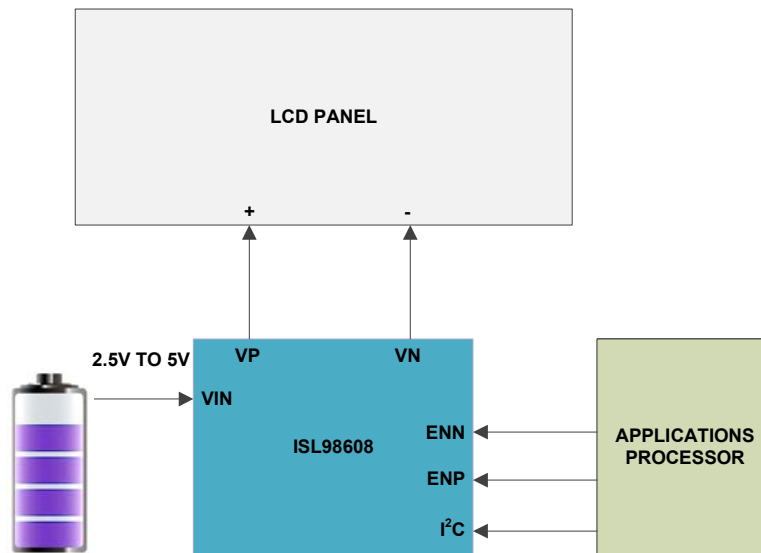
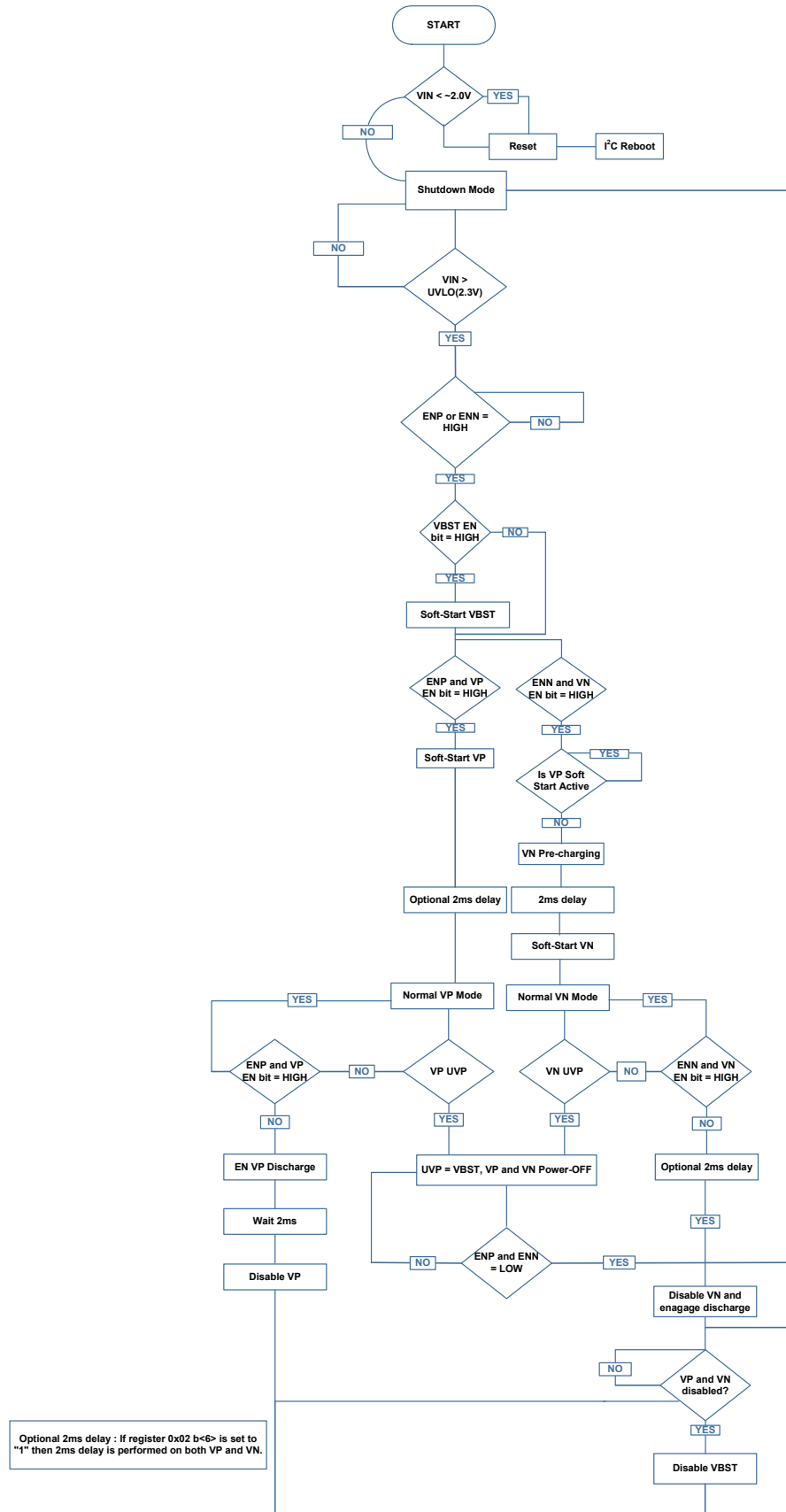

FIGURE 76. TYPICAL SYSTEM APPLICATION BLOCK DIAGRAM



Optional 2ms delay : If register 0x02 b<6> is set to "1" then 2ms delay is performed on both VP and VN.

FIGURE 77. START-UP FUNCTIONAL BLOCK DIAGRAM

I²C Digital Interface

The ISL98608 uses a standard I²C interface bus for communication. The two-wire interface links a master(s) and uniquely addressable slave devices. The master generates clock signals and is responsible for initiating data transfers. The serial clock is on the SCL line and the serial data (bidirectional) is on the SDA line. The ISL98608 supports clock rates up to 400kHz (Fast mode), and is backwards compatible with standard 100kHz clock rates (Standard mode).

The SDA and SCL lines must be HIGH when the bus is free - not in use. An external pull-up resistor (typically 2.2kΩ to 4.7kΩ) or current-source is required for SDA and SCL.

The ISL98608 meets standard I²C timing specifications, see [Figure 78](#) and [Table 1](#), which show the standard timing definitions and specifications for I²C communication.

START AND STOP CONDITION

All I²C communication begins with a START condition - indicating the beginning of a transaction and ends with a STOP condition - signaling the end of the transaction.

A START condition is signified by a HIGH to LOW transition on the serial data line (SDA) while the serial clock line (SCL) is HIGH. A

STOP condition is signified by a LOW to HIGH transition on the SDA line while SCL is HIGH. See timing specifications in [Table 1](#).

The master always initiates START and STOP conditions. After a START condition, the bus is considered “busy.” After a STOP condition, the bus is considered “free.” The ISL98608 also supports repeated STARTs, where the bus will remain busy for continued transaction(s).

DATA VALIDITY

The data on the SDA line must be stable (clearly defined as HIGH or LOW) during the HIGH period of the clock signal. The state of the SDA line can only change when the SCL line is LOW (except to create a START or STOP condition). See timing specifications in [Table 1](#).

The voltage levels used to indicate a logical ‘0’ (LOW) and logical ‘1’ (HIGH) are determined by the V_{IL} and V_{IH} thresholds, respectively, see the “Electrical Specifications” table on [page 7](#).

BYTE FORMAT

Every byte transferred on SDA must be 8 bits in length. After every byte of data sent by the transmitter there must be an Acknowledge bit (from the receiver) to signify that the previous 8 bits were transferred successfully. Data is always transferred on SDA with the most significant bit (MSB) first. See [“Acknowledge \(ACK\)” on page 23](#)

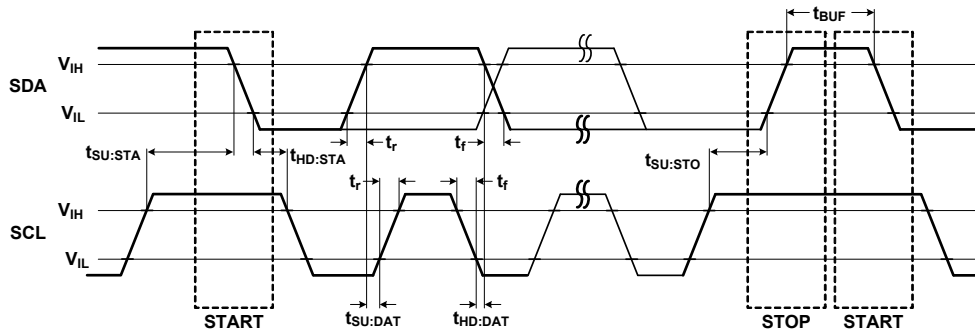

FIGURE 78. I²C TIMING DEFINITIONS

TABLE 1. I²C TIMING CHARACTERISTICS

PARAMETER	SYMBOL	FAST-MODE		STANDARD-MODE		UNIT
		MIN	MAX	MIN	MAX	
SCL Clock Frequency	f _{SCL}	0	400	0	100	kHz
Set-up Time for a START Condition	t _{SU:STA}	0.6	-	4.7	-	μs
Hold Time for a START Condition	t _{HD:STA}	0.6	-	4.0	-	μs
Set-up Time for a STOP Condition	t _{SU:STO}	0.6	-	4.0	-	μs
Bus Free Time between a STOP and START Condition	t _{BUF}	1.3	-	4.7	-	μs
Data Set-up Time	t _{SU:DAT}	100	-	250	-	ns
Data Hold Time	t _{HD:DAT}	0	-	0	-	μs
Rise Time of SDA and SCL (Note 9)	t _r	20 + 0.1C _b	300	-	1000	ns
Fall Time of SDA and SCL (Note 9)	t _f	20 + 0.1C _b	300	-	300	ns
Capacitive Load on Each Bus Line (SDA/SCL)	C _b	-	400	-	400	pF

NOTE:

9. C_b = Total capacitance of one bus line in pF.

ACKNOWLEDGE (ACK)

Each 8-bit data transfer is followed by an Acknowledge (ACK) bit from the receiver. The Acknowledge bit signifies that the previous 8 bits of data was transferred successfully (master to slave or slave to master).

When the master sends data to the slave (e.g., during a WRITE transaction), after the 8th bit of a data byte is transmitted, the master tri-states the SDA line during the 9th clock. The slave device acknowledges that it received all 8 bits by pulling down the SDA line, generating an ACK bit.

When the master receives data from the slave (e.g. during a data READ transaction), after the 8th bit is transmitted, the slave tri-states the SDA line during the 9th clock. The master acknowledges that it received all 8 bits by pulling down the SDA line, generating an ACK bit.

NOT ACKNOWLEDGE (NACK)

A Not Acknowledge (NACK) is generated when the receiver does not pull-down the SDA line during the acknowledge clock (i.e., SDA line remains HIGH during the 9th clock). This indicates to the master that it can generate a STOP condition to end the transaction and free the bus.

A NACK can be generated for various reasons, for example:

- After an I²C device address is transmitted, there is NO receiver with that address on the bus to respond.
- The receiver is busy performing an internal operation (e.g., reset, recall, etc) and cannot respond.
- The master (acting as a receiver) needs to indicate the end of a transfer with the slave (acting as a transmitter).

DEVICE ADDRESS AND R/ \bar{W} BIT

Data transfers follow the format shown in [Figures 80](#) and [81](#). After a valid START condition, the first byte sent in a transaction contains the 7-bit Device (slave) Address plus a direction (R/ \bar{W}) bit. The Device Address identifies which device (of up to 127 devices on the I²C bus) the master wishes to communicate with.

After a START condition, the ISL98608 monitors the first 8 bits (Device Address Byte) and checks for its 7-bit Device Address in the MSBs. If it recognizes the correct Device Address it will ACK, and becomes ready for further communication. If it does not see its Device Address, it will sit idle until another START condition is issued on the bus.

To access the ISL98608, the 7-bit Device Address is 0x29 (0101001x), located in MSB bits <b₇:b₁>. The eighth bit of the Device Address byte (LSB Bit <b₀>) indicates the direction of transfer, Read or Write (R/ \bar{W}). A “0” indicates a Write operation - the master will transmit data to the ISL98608 (receiver). A “1” indicates a Read operation - the master will receive data from the ISL98608 (transmitter) (see [Figure 79](#)).

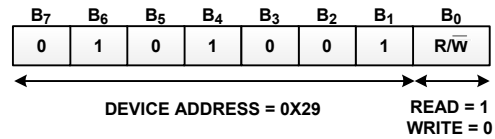

FIGURE 79. DEVICE ADDRESS BYTE FORMAT

Write Operation

A Write sequence requires an I²C START condition, followed by a valid Device Address Byte with the R/ \bar{W} bit set to '0', a valid Register Address Byte, a Data Byte and a STOP condition. After each valid byte is sent, the ISL98608 (slave) responds with an ACK. When the Write transaction is completed, the master should generate a STOP condition. For sent data to be latched by the ISL98608, the STOP condition should occur after a full byte (8 bits) is sent and ACK. If a STOP is generated in the middle of a byte transaction, the data will be ignored. See [Figure 80 on page 24](#) for the ISL98608 I²C Write protocol.

Read Operation

A READ sequence requires the master to first write to the ISL98608 to indicate the Register Address/pointer to read from. Send a START condition, followed by a valid Device Address Byte with the R/ \bar{W} set to '0' and then a valid Register Address Byte. Then the master generates either a Repeat START condition, or a STOP condition followed by a new START condition and a valid Device Address Byte with the R/ \bar{W} bit set to '1'. Then the ISL98608 is ready to send data to the master from the requested Register Address.

The ISL98608 sends out the Data Byte by asserting control of the SDA pin while the master generates clock pulses on the SCL pin. When transmission of the desired data is complete, the master generates a NACK condition followed by a STOP condition and this completes the I²C Read sequence. See [Figure 81 on page 24](#) for the ISL98608 I²C Read protocol.

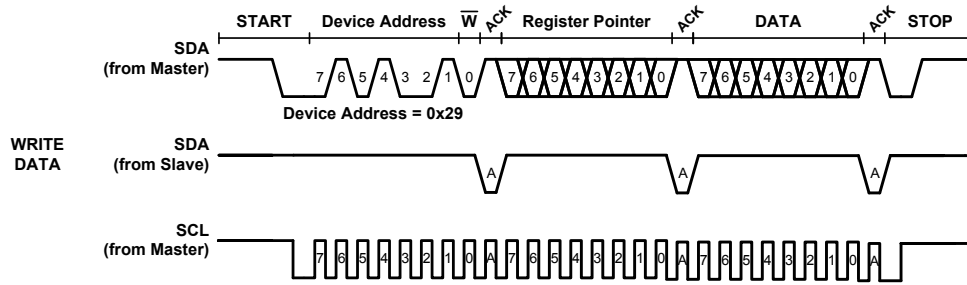

FIGURE 80. I²C WRITE TIMING DIAGRAM

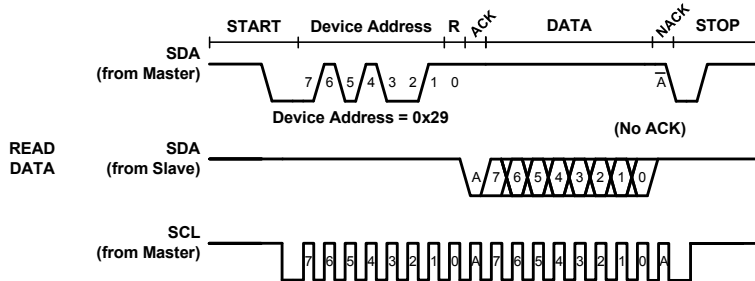
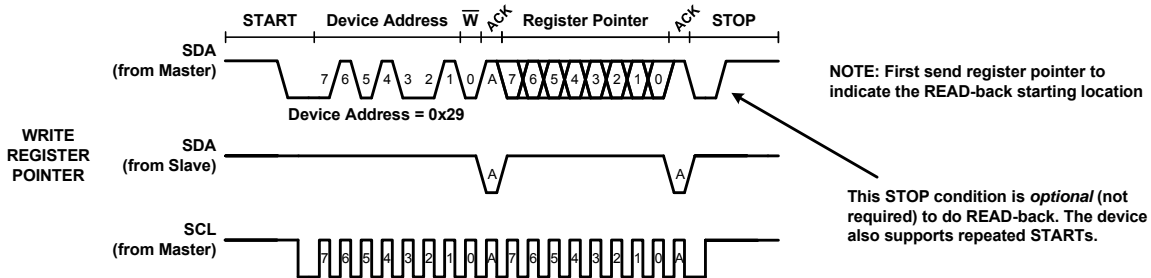

FIGURE 81. I²C READ TIMING DIAGRAM

Register Descriptions and Addresses

“[Register Map](#)” on page 26 contains the detailed register map, with descriptions and addresses for ISL98608 registers. Each volatile register is one byte (8-bit) in size. When writing data to adjust register settings using I²C, the data is latched-in after the 8th bit (LSB) is received.

The ISL98608 has default register settings that are applied at IC power-up, and in some cases, updated based on fuse values at first enable. The default register settings are indicated with **BOLD** face text.

NOTE: To clear/reset all the volatile registers to the default values, power cycle VIN or clear the register 0x04 Bit <b₇>.

Register Functions

The ISL98608 has various registers that can be used to adjust and control IC operating voltages, modes, thresholds and sequences.

FAULT

The “FAULT” register (Register Address 0x04) can be used to read back the current fault status of the IC. The fault conditions that can be read back by I²C are VBST undervoltage fault, VP undervoltage fault, VN undervoltage fault and over-temperature protection (OTP) fault.

If FAULT register Bit <b₀> (OTP status bit) is latched high for an OTP fault, it can be reset by simultaneously cycling ENP and ENN.

If FAULT register Bit <b₁> (VBST status bit) is latched high for a VBST undervoltage fault, it can be reset by cycling ENP and ENN together.

If FAULT register Bit <b₂> (VN status bit) is latched high for a VN undervoltage fault, it can be reset by cycling ENN.

If FAULT register Bit <b₃> (VP status bit) is latched high for a VP undervoltage fault, it can be reset by cycling ENP.

All fault bits can be cleared by cycling VIN or with a software reboot (clearing register 0x04 bit<b₇>). This will reset the entire part to default settings and disable all outputs until they have sequenced up again.

ENABLE

The “ENABLE” register (Register Address 0x05) can be used to control the enable/disable state of the boost (VBST), positive LDO (VP) and negative charge pump (VN). This can also be used to sequence the regulators. Refer to [“Enable Timing Control Options for VP and VN Regulators” on page 32](#) for details regarding the control of output regulators using the enable and I²C control. Using this register the VP and VN pull-down resistor can be enabled or disabled, soft-start time of VP and VN can be adjusted and the timing of VP sequencing can be adjusted.

Bit<4> of ENABLE register controls the delay between the ENP signal going low and the VP regulator power-off. If Bit<4> is set to 0, the VP regulator is disabled 2ms after ENP going low. If Bit<4> is set to 1, the VP regulator is disabled as soon as ENP goes low.

Bit<5> of ENABLE register controls shutdown behavior of VBST, VP and VN regulators after OTP or UV event. If Bit<5> is set to 1, then VBST, VP and VN regulators are shut off after OTP or UV event. To turn on the regulators, IC should be out of fault condition and ENP and ENN signals are recycled. Regulators can also be turned on by recycling the enable bit in the I²C register. If Bit<5> is set to 0, then regulators will turn back on as soon as fault condition is removed.

Bit<6> controls the VN and VP discharge resistor. If bit<6> is programmed to “0” then it will enable the discharge resistor where as “1” will disable the discharge resistor.

Bit<7> controls the soft-start time of VN and VP regulators. If bit<7> is set to “0” then soft-start time of VN is 1.8ms and for VP is 1.2ms whereas when set to “1”, soft-start time of both VP and VN regulator is 0.7ms.

VBST/VN/VN VOLTAGE

The output voltages of VBST, VP and VN regulators can be changed using the registers “VBST Voltage”, “VP Voltage” and “VN Voltage”, respectively. VBST Voltage is at Register Address 0x06, VN Voltage is at Register Address 0x08 and VP Voltage is at Register Address 0x09. The output voltages of all regulators can be changed from their default values using I²C.

- The VBST regulator can be programmed from +4.65V to +7.3V
- The VP regulator can be programmed from +4.5V to +7V
- The VN regulator can be programmed from -7V to -4.5V
- All are adjustable with 50mV step size.

Once the maximum VBST voltage (7.3V) is reached the algorithm will wrap around to give VBST voltage from 4.65V to 5.1V. Similarly, when maximum VP and VN voltage are reached ($\pm 7V$), the algorithm will wrap around to give VP/VN voltage from $\pm 4.5V$ to $\pm 4.95V$.

To determine the expected output voltage for a specific register value, see the following section [“Output Voltage Calculation for VBST, VP and VN”](#).

NOTE: Output voltage registers should not be changed during their respective soft-start sequence.

Output Voltage Calculation for VBST, VP and VN

The expected output voltage for each regulator can be determined using [Equations 1](#) through [3](#). Note, N is the 5-bit register settings from 0x06, 0x08 and 0x09 in decimal.

The expected VBST voltage can be determined using [Equation 1](#).

$$VBST(V) = VBST(\text{Default}) + N \times 50\text{mV} \quad (\text{EQ. 1})$$

Once the maximum VBST voltage is reached, the algorithm will wrap around to give VBST voltage from 4.65V to 5.1V.

The expected VP voltage can be determined using [Equation 2](#).

$$VP(V) = VP(\text{Default}) + N \times 50\text{mV} \quad (\text{EQ. 2})$$

Once the maximum VP voltage is reached, the algorithm will wrap around to give VP voltage from 4.50V to 4.95V.

The expected VN voltage can be determined using [Equation 3](#).

$$VN(V) = VN(\text{Default}) - N \times 50\text{mV} \quad (\text{EQ. 3})$$

Once the minimum VN voltage is reached, the algorithm will wrap around to give VN voltage from -4.50V to -4.95V.

Example Calculations:

If N = 10 (decimal) VBST (Default) = 5.65V,
VP/VN (Default) = $\pm 5.5V$:

$$VBST(V) = 5.65V + 10 \times 50\text{mV} = 6.15V$$

$$VP(V) = 5.5V + 10 \times 50\text{mV} = 6.0V$$

$$VN(V) = -5.5V - 10 \times 50\text{mV} = -6.0V$$

The output voltage of the VBST, VP and VN regulators can be changed using non-I²C control by blowing fuses or I²C control. When powered up, Registers 0x06, 0x08 and 0x09 read a value of 0x00 and the VBST, VN, VP voltage levels are at respective default voltage. Using I²C control, the voltage can be changed by changing the value of Registers 0x06, 0x08 and 0x09. As $V_{IN} < \text{POR}$ (Power-On Reset) voltage, Registers 0x06, 0x08 and 0x09 read 0x00. Non-I²C control can also be used to change the default voltage of VBST, VN and VP by blowing fuses and still Registers 0x06, 0x08 and 0x09 read 0x00 on POR. Then, VBST, VN and VP voltage can be changed using I²C by changing Registers 0x06, 0x08 and 0x09, respectively.

VBST CONTROL

In addition to output voltage adjustments, key operation parameters can be changed using I²C to optimize the ISL98608 performance.

The “VBST CNTRL and VBST/VN Frequency” register (Register Address 0x0D) can be used to control boost PFM mode, boost FET slew rate and switching frequency of the boost and charge pump.

Register Map

REGISTER ADDRESS (HEX)	REGISTER NAME	R/W	FUNCTION	BIT <b ₇ >	BIT <b ₆ >	BIT <b ₅ >	BIT <b ₄ >	BIT <b ₃ >	BIT <b ₂ >	BIT <b ₁ >	BIT <b ₀ >	DEFAULT VALUE (HEX)	IC RESET	
0x04	FAULT/STATUS	R/W[7] R[6:0]	Fault Status Read-back	Reboot 1 = Reset all digital (reverts to 0 once reboot completes) 0 = Normal operation	Not used			Start VP and VN together 0 = Sequenced 1 = Start together	VP UVP 0 = Output Voltage OK 1 = UVP Detect if VP <60% for >100µs	VN UVP 0 = Output Voltage OK 1 = UVP Detect if VN <60% for >100µs	VBST UVP 0 = Output Voltage OK 1 = UVP Detect if VBST <70% for >100µs	OTP 0 = Temp Ok 1 = OTP detected. Temp =130 °C for >10µs	0x00	Cycle VIN or Bit 0 - cycle ENN and ENP Bit 1 - cycle ENN and ENP Bit 2 - cycle ENN Bit 3 - Cycle ENP
0x05	ENABLE	R/W	IC Enable/Sequencing	VP/VN soft-start times 0 = VP = 1.2ms VN = 1.8ms 1 = VP = VN = 0.7ms	VP/VN Discharge Resistor 0 = Enabled 1 = Disabled	Enable shut down of VBST/VP/VN at OTP or if any is UV after start-up. 0 = Disabled 1 = Enabled	Delay VP off 0 = VP off 2ms after ENP 1 = VP off with ENP	Reserved	VP Enable: 0 = Disable 1 = Enable	VN Enable: 0 = Disable 1 = Enable	VBST Enable: 0 = Disable 1 = Enable	0x27	Cycle VIN or clear the register 0x04 Bit <b ₇ >	
0x06	VBST VOLTAGE	R/W	VBST Voltage Adjustment	Not Used	VBST Voltage <5:0> VBST = VBST (Default) + N x 50mV Once the max voltage is reached the algorithm will wrap around to give 4.65 to 5.1 options default (dec 10) = 5.65V							0x00	Cycle VIN or clear the register 0x04 Bit <b ₇ >	
0x08	VN VOLTAGE	R/W	VN Voltage Adjustment	Not Used	VN Voltage <5:0> VN = VN (Default) - N x 50mV Once the min voltage is reached the algorithm will wrap around to give -4.5 to -4.95 options default (dec 10) = -5.5V							0x00	Cycle VIN or clear the register 0x04 Bit <b ₇ >	
0x09	VP VOLTAGE	R/W	VP Voltage Adjustment	Not Used	VP Voltage <5:0> VP = VP (Default) + N x 50mV Once the max voltage is reached the algorithm will wrap around to give 4.5 to 4.95 options default (dec 10) = 5.5V							0x00	Cycle VIN or clear the register 0x04 Bit <b ₇ >	

Register Map (Continued)

REGISTER ADDRESS (HEX)	REGISTER NAME	R/W	FUNCTION	BIT <b ₇ >	BIT <b ₆ >	BIT <b ₅ >	BIT <b ₄ >	BIT <b ₃ >	BIT <b ₂ >	BIT <b ₁ >	BIT <b ₀ >	DEFAULT VALUE (HEX)	IC RESET
0x0D	VBST control and VBST/VN FREQUENCY	R/W	VBST Control and VBST/VN Frequency	Reserved	Reserved	Power FET slew rate control 00 = Slowest 01 = Slow 10 = Fast 11 = Fastest		PFM mode 0 = Enabled 1 = Disabled	VBST and VN switching frequency 000 = 1.00MHz 001 = 1.07MHz 010 = 1.23MHz 011 = 1.33MHz 100 = 1.45MHz 101 = 1.60MHz 110 = 1.78MHz 111 = 2.00MHz			0xB4	Cycle VIN or clear the register 0x04 Bit <b ₇ >

Display Power Supply Function Description

Regulator Output Enable/Disable

The boost converter, VBST, will be enabled whenever either ENP or ENN is HIGH and the VBST enable Bit $\langle b_0 \rangle$ in the ENABLE register is set to '1'. To disable the boost (and effectively VP and VN), ENN and ENP must be LOW, or its enable bit set to '0'.

The negative charge pump, VN, is enabled whenever ENN is HIGH and the VN enable Bit $\langle b_1 \rangle$ in the ENABLE register is set to '1'. To disable, ENN must be LOW, or its enable bit set to '0'.

The LDO, VP, is enabled whenever ENP is HIGH and the VP enable Bit $\langle b_2 \rangle$ in the ENABLE register is set to '1'. To disable ENP must be LOW, or its enable bit set to '0'.

All the ENABLE register bits $\langle b_2:b_0 \rangle$ are set to '1' by default.

Note, ENP and ENN are logic level inputs with HIGH/LOW thresholds defined by the V_{IH}/V_{IL} specifications, respectively. These inputs also have $1M\Omega$ (typical) internal pull-down resistance to ground. If the pins are left high-impedance, they will default to a LOW logic state. Refer to the [“LOGIC/DIGITAL” on page 7](#) of the “Electrical Specifications” table for more information.

VP and VN Headroom Voltage and Output Current

The VP and VN headroom voltage is defined as the difference between the VBST target voltage and maximum of VP and |VN| target voltages.

The headroom voltage must be set high enough so that both the VP LDO and VN negative Charge Pump (CP) can maintain regulation. The VBST voltage must be greater than the absolute value of the VN regulation voltage (i.e., the headroom voltage has to be $>0V$). Primarily, the minimum headroom voltage is a function of the maximum application load current that the IC will need to support. Fast output current peaks of only a few microseconds should not be considered - those instantaneous current peaks will be supported by the output capacitors and not by the regulator. [Equation 4](#) shows the minimum headroom required depending upon the current.

$$\text{Headroom}(V) > I_{\max}(A) \times 2.7 \quad (\text{EQ. 4})$$

NOTE: The headroom voltage should not be set overly high, since increasing headroom generally yields lower efficiency performance due to increased conduction losses.

For very low duty cycle where the output voltage of the VBST is very close to the input voltage, VBST starts to track the input voltage with a fixed headroom of $\sim 600mV$. This feature avoids the minimum duty cycle limitation from producing increased ripple on VBST (which feeds through to VP/VN) and ensures proper regulation of the VBST, VP and VN regulators.

For most applications, the ISL98608 default 150mV headroom voltage setting provides optimal performance for DC output current up to 100mA (maximum). For DC output current between 100mA and 150mA (maximum), the headroom voltage should be adjusted to 250mV. For example, if a maximum VP to

VN load of 150mA is required, while $VP = 5.5V$ and $VN = -5.5V$, then the minimum boost voltage should be set to $VBST = 5.75V$.

Negative Charge Pump Operation (VN)

The ISL98608 uses a negative charge pump with internal switches to create the VN voltage rail. The charge pump input voltage VBSTCP comes from the boost regulator output, VBST.

Regulation is achieved through a classic voltage mode architecture where an internally compensated integrator output is compared with the voltage ramp to set a duty cycle. The duty cycle controls the amount of time the output capacitor is charged during each switching cycle. The maximum duty cycle is 50%. The charge pump output capacitor (placed on the VN pin) is charged and discharged through internal current source to minimize system noise.

VN and VBST PFM

The ISL98608 features light-load Pulse Frequency Modulation (PFM) mode for both the boost regulator and the charge pump, to maximize efficiency at light loads.

The device always uses PWM mode at heavy loading, but will automatically switch to PFM mode at light loads to optimize efficiency. PFM capability is enabled using the respective PFM mode enable/disable register bits.

VBST PFM

In PFM mode, the boost can be configured to either use a fixed peak current, or to automatically select the optimal peak current setting. The automatic, or “Auto” mode, is designed to dynamically adjust the peak current to maintain boost output voltage ripple at relatively fixed levels across input voltage, while improving efficiency at low input voltages. This patent pending architecture adjusts the peak current to keep the sum of inductor ramp-up and ramp-down times to a constant value of approximately $1.3 \times T_{pwm}$. This scheme also gives more consistent ripple part-to-part and keeps PWM/PFM hysteresis defined in a smaller and more optimal band across operating voltages. It is recommended to operate the part in this mode.

The VBST PFM mode features an ultrasonic Audio Band Suppression (ABS) mode, which prevents the switching frequency from falling below 30kHz to avoid audible noise. When the time interval between two consecutive switching cycles in PFM mode is more than 33ms (i.e., 30kHz frequency) the regulator reduces the peak inductor current, to maintain the frequency at 30kHz. If this is not sufficient, the regulator will add low current reverse current cycles.

VN PFM

The charge pump PFM mode works by increasing the minimum pump on-time, and thereby the charge delivered per cycle, when the load is low. This allows increased ripple to be traded off against switching losses.

VP Output Hi-Z Mode

The ISL98608 VP and VN regulator can be configured in a Hi-Z mode to prevent any leakage current flowing between VP and VN when the TFT-LCD is in sleep/standby mode. Using I²C register 0x05<b₆> can be used to disable the pull-down resistors on VP and VN giving a “Hi-Z” state of output.

Power-On/Off Sequence

The boost regulator used to generate VP/VN, VBST, is activated when the VIN input voltage is higher than the UVLO threshold, and either ENP or ENN is high, along with their respective I²C enable bits. To enable the VBST, Reg 0x05 <b₀> should be 1 (by default this bit is set to 1). The VP output is activated if ENP is high, VBST has completed its soft-start and Reg 0x05 <b₂> is 1 (by default this bit is set to 1). The VN charge pump is activated 2ms after VBST has completed soft-start, and the ENN has been pulled high, whichever comes later. To activate the VN regulator, Reg 0x05 <b₁> should also be 1 (by default this bit is set to 1).

[Figure 82](#) shows the power-on sequence for the case when the ENP and ENN all are tied together and VP/VN rail sequencing is enabled in register 0x04<b₄> by writing “0” and VP soft-start time is 1.2ms where as VN soft-start time is 1.8ms programmed from register 0x05<b₇> by writing “1”. The VBST soft-starts if the VIN voltage is higher than the UVLO threshold and either ENN or ENP is high. When the VBST soft-start is completed, the VP regulator soft-starts in 1.2ms. The VN power-on occurs 2ms after VBST soft-start completes. The VN soft-start time takes 1.8ms. The 2ms power-on delay between VP and VN can be disabled from register 0x04<b₄> by writing “1”.

[Figure 83](#) shows the power-on sequence for the case when the ENP and ENN all are tied together and VP/VN rail sequencing is enabled in register 0x04<b₄> by writing “0” and VP/VN soft-start time is programmed to 0.7ms from register 0x05<b₇> by writing “0”. The VBST soft-starts if the VIN voltage is higher than the UVLO threshold and either ENN or ENP is high. When the VBST soft-start is completed, the VP regulator soft-starts in 0.7ms. The VN power-on occurs 2ms after VBST soft-start completes. The VN soft-start time takes 0.7ms. The 2ms power-on delay between VP and VN can be disabled from register 0x04<b₄> by writing “1”.

[Figure 84](#) shows the power-on sequence for the case when the ENP and ENN all are tied together and VP/VN rail sequencing is disabled in register 0x04<b₄> by writing “1” and VP/VN soft-start time is programmed to 1.2ms from register 0x05<b₇> by writing “0”. The VBST soft-starts if the VIN voltage is higher than the UVLO threshold and either ENN or ENP is high. When the VBST soft-start is completed, the VP and VN regulator soft-starts in 1.2ms.

[Figure 85](#) shows the power-on sequence for the case when the ENP and ENN all are tied together and VP/VN rail sequencing is disabled in register 0x04<b₄> by writing “1” and VP/VN soft-start time is programmed to 0.7ms from register 0x05<b₇> by writing “1”. The VBST soft-starts if the VIN voltage is higher than the UVLO threshold and either ENN or ENP is high. When the VBST soft-start is completed, the VP and VN regulator soft-starts in 0.7ms.

The VP/VN/VBST soft-start times quoted above (VBST = 0.47ms, VP = 1.2ms and VN = 1.2ms or 1.8ms) are valid for the default voltage levels (VSBT = 5.15V, VP = 5V and VN = -5V). These will change with different voltages, as they are set to give a fixed dv/dt.

ENP or ENN going low will shut down VP or VN, respectively. If both ENP and ENN are pulled low, then VP, VN and VBST are all turned off. The VN regulator shuts off when ENN is pulled low. VP and VBST power-off occurs 2ms after the ENP signal goes low (Register 0x05<b₄> = 0), (see [Figure 87](#)). If Register 0x05<b₄> = 1, the VP and VN regulators will power off immediately when ENN and ENP are pulled low (see [Figure 88](#)).

If VIN falls below UVLO while the IC is active, all active regulators will be turned off at the same time (see [Figure 89](#)).

VP AND VN DISCHARGE RESISTOR

The integrated discharge resistors on the VP and VN outputs are 80Ω (typical) and 35Ω (typical), respectively. The VP discharge resistor is enabled for 2ms (by default) following when ENN goes low. If ENP is still high, the VP discharge resistor is disabled 2ms after ENN goes low. The VP discharge resistor will be re-enabled when ENP goes low. If the same output capacitor (value, size, rating) is used for VN and VP, the VN rail will discharge faster than VP if they are both turned off at the same time. This is ideal for applications that require the VN rail to go down before VP at power-off.

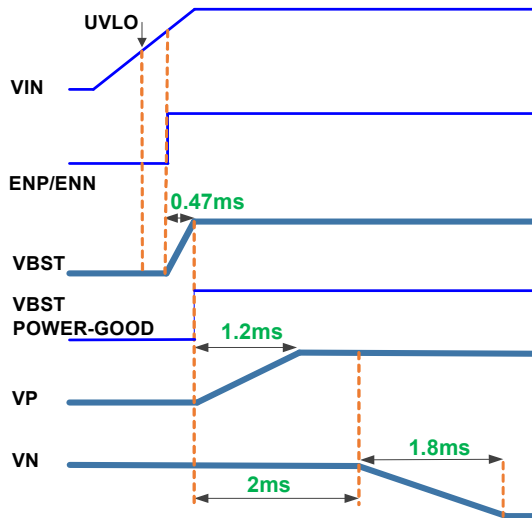

FIGURE 82. POWER-ON SEQUENCE - ACTIVATED BY ONE GPIO FOR ENN AND ENP, REGISTER 0x04 <b₄> = 0 AND 0x05 <b₇> = 0

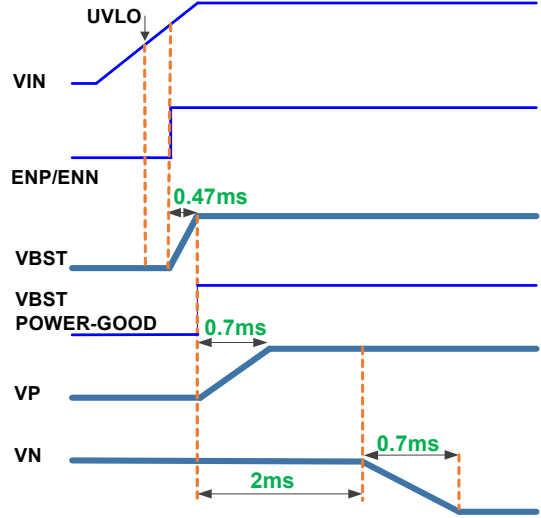

FIGURE 83. POWER-ON SEQUENCE - ACTIVATED BY ONE GPIO FOR ENN AND ENP, REGISTER 0x04 <b₄> = 0 AND 0x05 <b₇> = 1

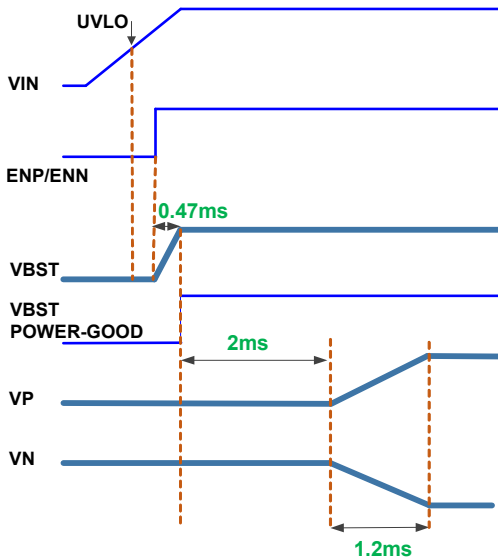

FIGURE 84. POWER-ON SEQUENCE - ACTIVATED BY ONE GPIO FOR ENN AND ENP, REGISTER 0x04 <b₄> = 1 AND 0x05 <b₇> = 0

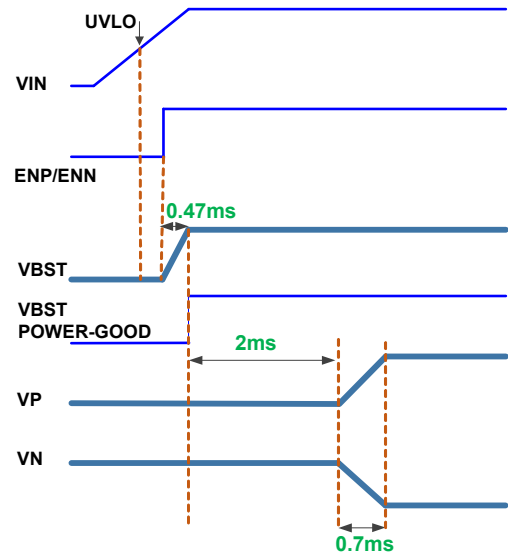

FIGURE 85. POWER-ON SEQUENCE - ACTIVATED BY ONE GPIO FOR ENN AND ENP, REGISTER 0x04 <b₄> = 1 AND 0x05 <b₇> = 1

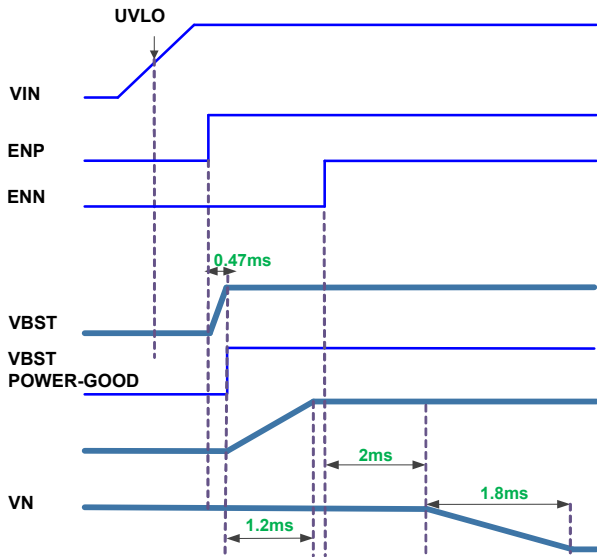

FIGURE 86. POWER-ON SEQUENCE - ACTIVATED BY TWO GPIOs FOR ENN AND ENP, REGISTER 0x04 <b₄> = 0 AND 0x05 <b₇> = 0

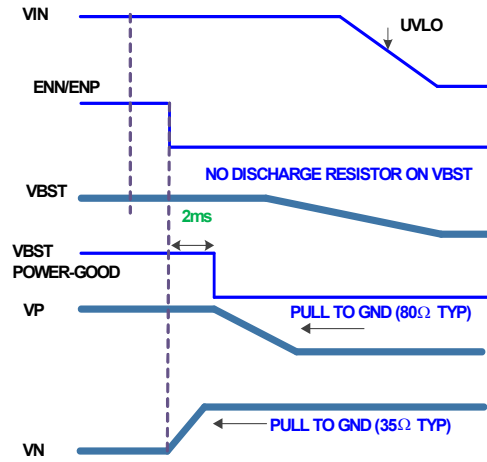

FIGURE 87. POWER-OFF SEQUENCE - ACTIVATED BY TWO GPIOs ENN AND ENP, REGISTER 0x05 <b₄> = 0

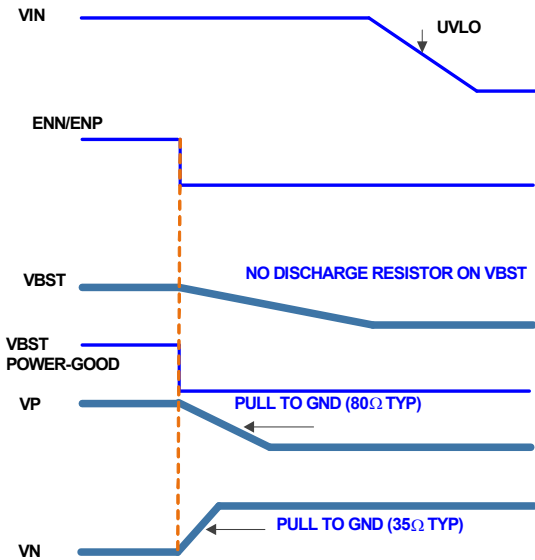

FIGURE 88. POWER-OFF SEQUENCE - ACTIVATED BY TWO GPIOs ENN AND ENP, REGISTER 0x05 <b₄> = 1

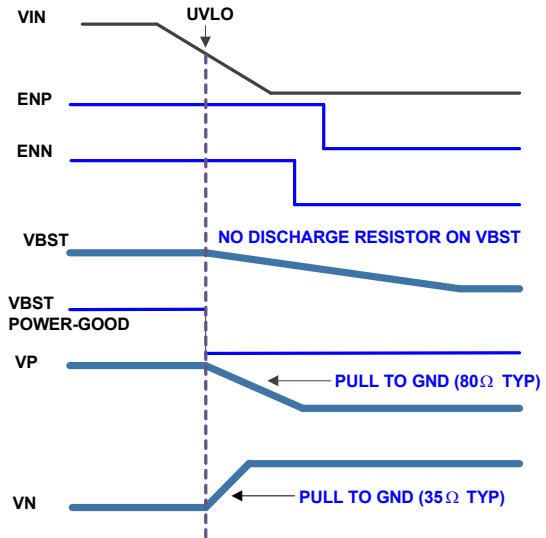

FIGURE 89. POWER-OFF SEQUENCE - ACTIVATED BY VIN FALLING BELOW UVLO

Enable Timing Control Options for VP and VN Regulators

There are several ways to control enable sequencing of the VP and VN regulators: I²C control, and dual or single GPIO control.

I²C CONTROL

By using I²C, the sequencing of the VP and VN regulator can be controlled by writing to register 0x02. Bit <b₁> controls the VN regulator and <b₂> controls the VP regulator. Setting the bits to '1' will enable the regulator and setting to '0' will shut off/disable the regulator. Delaying the writes for setting Bit <b₁> and <b₂> (using separate I²C transactions) will delay the turn-on/off sequence of VP and VN accordingly. When using I²C to control the sequencing, ENN and ENP should be pulled low before writing to the I²C register to disable the VP and VN regulators and then ENN and ENP can go high before the I²C is used to enable them.

Figure 90 shows a 14ms delay between when VP and VN turn-on. The 14ms time is an example delay to show the power-on sequencing possibility through I²C. This delay is set between the separate I²C writes to set the enable bits in register 0x02. If both enable bits were set to '1' in the same I²C transaction (same byte), and ENN and ENP are high, then both VP and VN regulators will start power-on sequencing at the same time (when the data is latched at the STOP condition). The VN will come up 2ms after VP if register 0x02<b₆> is low and with VP if high.

Figure 91 shows a 14ms delay between the VP and VN turn-off. The 14ms time is an example delay to show the power-off sequencing possibility using I²C.

Figures 92 (zoom in) and 93 (zoom out) show a typical I²C data transfer to the ENABLE register. In this example, VP and VN regulators are enabled by writing data 0x07 to register address 0x02. The VP regulator will be enabled first after the I²C STOP condition, followed by the VN regulator after the internal 2ms delay.

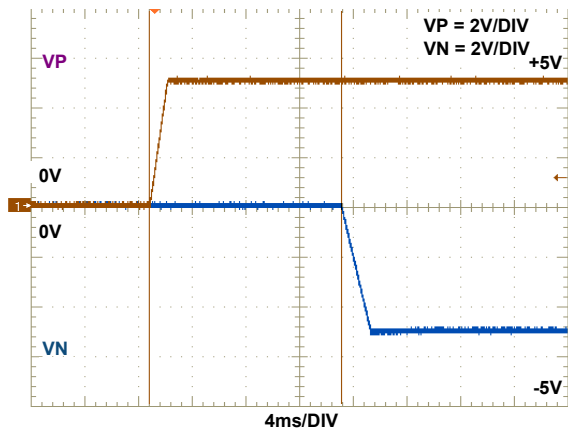

FIGURE 90. ON-SEQUENCE, I²C CONTROL

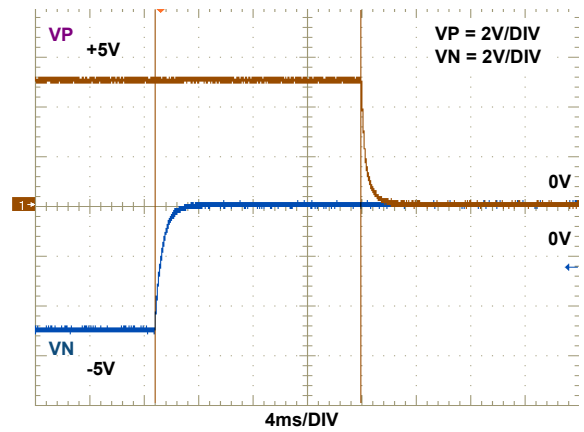

FIGURE 91. OFF-SEQUENCE, I²C CONTROL

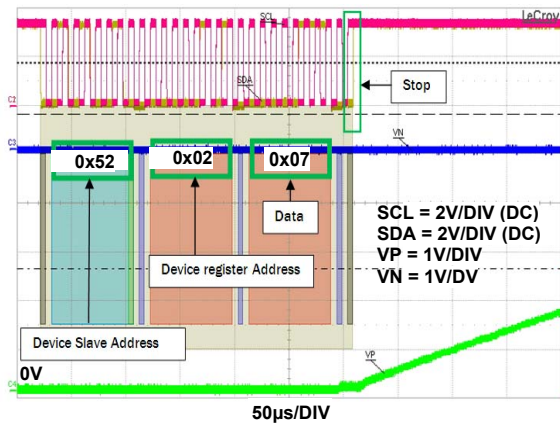

FIGURE 92. I²C SEQUENCE AND VP RESPONSE

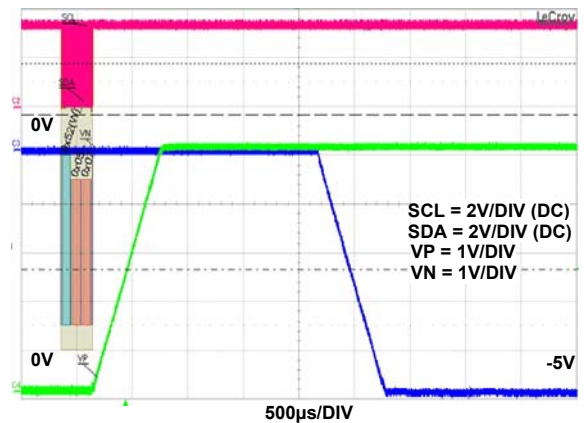

FIGURE 93. I²C SEQUENCE AND VP/VN RESPONSE

SEPARATE ENP AND ENN PINS (2 GPIO CONTROL)

Using two separate GPIO's, and controlling the timing between the ENP and ENN pins, the turn-on/off events can be controlled. The method to control turn-on/off by GPIO is valid when the respective enable bits in the ENABLE register at Register Address 0x02 are set to '1' (default). Thus, this method can be used with no I²C communication.

Figure 94 shows a 6ms delay (example) between the ENP and ENN rise.

Figure 95 shows a 13ms delay (example) between the ENP and ENN fall.

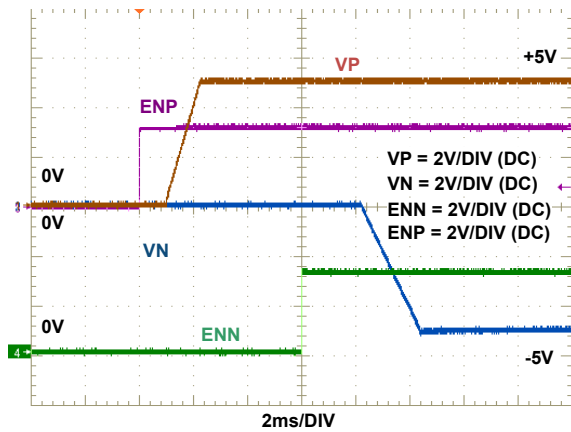

FIGURE 94. ON SEQUENCE, 2 GPIO CONTROL

TIE ENP AND ENN TOGETHER (1 GPIO CONTROL)

There is also an option to sequence the VN and VP regulators if there is only a single GPIO available in the system. The method to control turn-on/off by GPIO is valid when the respective enable bits in the ENABLE register at Register Address 0x02 are set to '1' (default). Therefore, this method can be used with no I²C communication.

If the ENP and ENN are tied together and both pulled high and register 0x02<b₆> = "0", then there is a default delay sequence in the IC. VP will come up first and after 2ms VN will soft-start. For turn off, VN will power-off first, and VP starts to shut down 2ms after VN starts to power-off.

Figure 96 shows turn-on when the ENN and ENP pins are tied together. There is a 2ms delay between VP and VN turning on.

Figure 97 shows turn-off when the ENN and ENP are tied together.

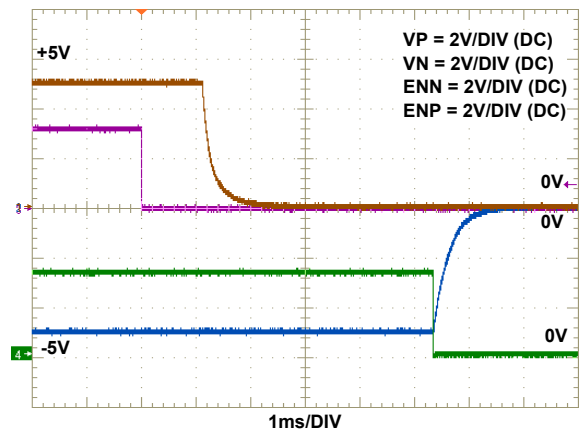

FIGURE 95. OFF SEQUENCE, 2 GPIO CONTROL

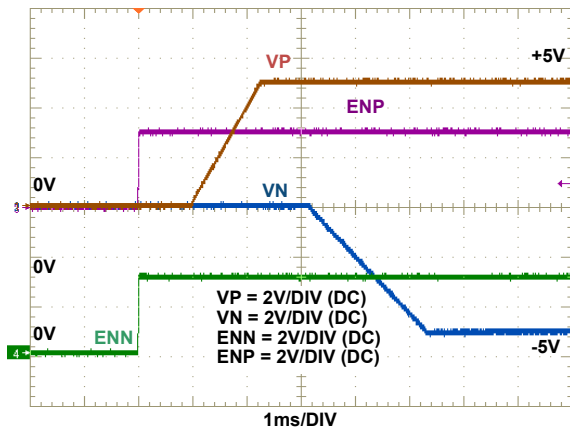

FIGURE 96. ON SEQUENCE, 1 GPIO CONTROL

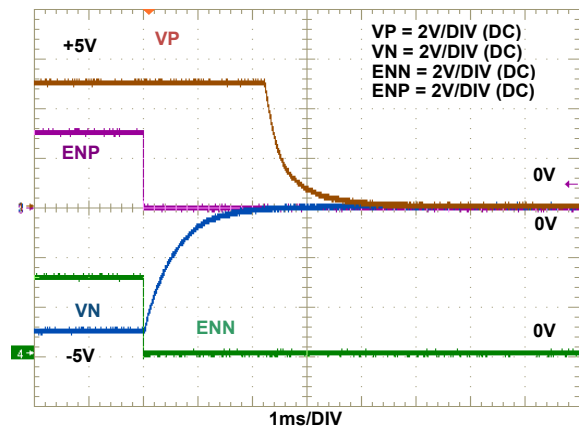

FIGURE 97. OFF SEQUENCE, 1 GPIO CONTROL

Fault Protection and Monitoring

The ISL98608 features extensive protections to automatically handle failure conditions, and protect the IC and application from damage.

OVERCURRENT PROTECTION (OCP)

The overcurrent protection limits the VBST nMOSFET current on a cycle-by-cycle basis. When the nMOSFET current reaches the current limit threshold, the nMOSFET is turned off for the remainder of that cycle. Overcurrent protection does not disable any of the regulators. Once the fault is removed, the IC will continue with normal operation.

UNDERVOLTAGE LOCKOUT (UVLO)

If the input voltage (V_{IN}) falls below the V_{UVLO_HYS} level of ~2.3V (typical), the VBST, VP and VN regulators will be disabled. All the rails will restart with normal soft-start operation when the V_{IN} input voltage is applied again (rising $V_{IN} > V_{UVLO}$). Refer to the "Electrical Specifications" table on [page 6](#) for the UVLO specifications.

NOTE: The I²C registers (logic) are not cleared/reset to default by the falling V_{IN} UVLO. The logic states are retained if V_{IN} remains above 2V (typical). Once V_{IN} falls below 2V, all logic is reset. V_{IN} should fall below 2V (ideally to GND) before power is reapplied to ensure a full power cycle/reset of the device.

OVER-TEMPERATURE PROTECTION (OTP)

The ISL98608 has a hysteretic over-temperature protection threshold set at +150 °C (typical). If this threshold is reached, the VBST, VP and VN regulators are disabled immediately. As soon as temperature falls by 20 °C (typical) then all the regulators automatically restart.

All register bits, except for Bit $\langle b_0 \rangle$ of the FAULT register (Register Address 0x04), remain unaffected during an OTP fault event. When an OTP event occurs, FAULT register Bit $\langle b_0 \rangle$ is latched to '1'. This bit is reset/cleared by cycling both ENN and ENP (set LOW, then HIGH) at the same time, or by cycling VIN power. Bit $\langle b_0 \rangle$ can also be reset after it is read twice by I²C. A single I²C read will return the bit value (status), and a second read will reset *only* the OTP bit.

Output undervoltage protection is disabled during an OTP event. Since the output voltages decrease during an OTP event because the regulators are disabled, this will not trigger a UVP fault.

UNDERVOLTAGE PROTECTION (UVP)

The ISL98608 includes output undervoltage protection. Undervoltage protection disables the regulator whenever the output voltage of VBST or VP falls below 60% of its set/regulated voltage, or the output voltage of VN goes above 60% of its set/regulated voltage, for 100μs or more. If the output voltage exceeds the 60% condition for less than 100μs, no fault will occur.

Depending on which regulator(s) fault, bit(s) $\langle b_3 \rangle$, $\langle b_2 \rangle$, or $\langle b_1 \rangle$ in the FAULT register will be latched to '1' for VP, VN and VBST faults, respectively. The bit(s) are reset/cleared by cycling both ENN and ENP (set LOW, then HIGH) at the same time, or by cycling VIN power.

Undervoltage protection can be disabled by making selection from register 0x05 $\langle b_5 \rangle$.

Component Selection

The design of the boost converter is simplified by an internal compensation scheme, which allows an easy system design without complicated calculations. Select component values using the following recommendations.

Input Capacitor

It is recommended that a 10μF X5R/X7R or equivalent ceramic capacitor is placed on the VIN input supply to ground.

Inductor

First, determine the minimum inductor saturation current required for the application.

The ISL98608 operates in Continuous Conduction Mode (CCM) at higher load current, and in Discontinuous Conduction Mode (DCM) at lighter loads. In CCM, we can calculate the peak inductor current using [Equations 5](#) through [9](#).

Given these parameters:

- Input Voltage = V_{IN}
- Output Voltage = V_O
- Duty Cycle = D
- Switching Frequency = f_{SW}
- $t_{SW} = 1/f_{SW}$

Then the inductor ripple can be calculated as:

$$\Delta I_{P-P} = (V_{IN}) * (D) / (L * f_{SW}) \quad (\text{EQ. 5})$$

where $D = 1 - (V_{IN}/V_O)$, then rewrite [Equation 5](#):

$$\Delta I_{P-P} = (V_{IN}) * (V_O - V_{IN}) / (L * f_{SW} * V_O) \quad (\text{EQ. 6})$$

The average inductor current is equal to the average input current, where I_{AVG} can be calculated from the efficiency of the converter.

$$I_{AVG} = (V_O * I_O) / (V_{IN} * \text{Efficiency}) \quad (\text{EQ. 7})$$

To find the peak inductor current write the expression as:

$$I_{PK} = \Delta I_{P-P} / 2 + I_{AVG} \quad (\text{EQ. 8})$$

Substituting [Equations 6](#) and [7](#) in [Equation 8](#) to calculate I_{PK} :

$$I_{PK} = 0.5 * V_{IN} * (V_O - V_{IN}) / (L * f_{SW} * V_O) + (V_O * I_O) / (V_{IN} * \text{EFF}) \quad (\text{EQ. 9})$$

EXAMPLE FOR VBST REGULATOR

Consider the following parameters in the steady state VLED boost regulator operating in CCM mode.

$$V_{IN} = 2.5V$$

$$V_O = 5.3V$$

$$I_O = 0.100A$$

$$f_{SW} = 1.45MHz$$

$$\text{Efficiency} = 80\%$$

$$L = 2.2\mu H$$

Substituting previous parameters in [Equation 9](#) gives us:

$$I_{PK} = 0.472A$$

The VBST regulator can be configured to either use a fixed peak current, or to automatically select the optimal peak current setting. The automatic mode is designed to dynamically adjust the peak current to maintain boost output voltage ripple at a relatively fixed value across input voltage, while improving efficiency at low input voltages.

In order to avoid the inductor core saturation, the saturation current of the inductor selected should be higher than the greater of the peak inductor current (for CCM) and the peak current in PFM mode and current limit of the regulators. It is recommended to use an inductor that has saturation current rating higher than current limit of the boost regulator.

Auto PFM mode provides maximum efficiency using 2.2 μ H for the VBST regulator. L = 2.2 μ H is the optimal value for the VBST regulator.

[Table 2](#) shows the recommended inductors for the VBST boost regulator.

TABLE 2. RECOMMENDED INDUCTORS FOR VBST REGULATOR

INDUCTOR PART NUMBER	INDUCTANCE (μ H)	DCR (m Ω)	I _{SAT} (A)	FOOTPRINT SIZE
VLF302510MT-2R2M (TDK)	2.2	70	1.23	3025
DFE252012C (Toko)	2.2	90	2.00	2520
TFM201610G-2R2M (TDK)	2.2	150	1.20	2016

Output Capacitor

The output capacitor supplies current to the load during transient conditions, and reduces the ripple voltage at the output. Output ripple voltage consists of two components:

1. The voltage drop due to the inductor ripple current flowing through the ESR of the output capacitor.
2. Charging and discharging of the output capacitor.

For low ESR ceramic capacitors, the output ripple is dominated by the charging and discharging of the output capacitor. The voltage rating of the output capacitor should be greater than the maximum output voltage.

The effective capacitance at the nominal output voltage should be $\geq 2.2\mu$ F for VBST and VP regulators, and $\geq 4.4\mu$ F for VN. It is recommended to use a 10 μ F X5R 10V or equivalent ceramic output capacitor for both VBST and VP outputs to provide a minimum of 2.2 μ F effective capacitance. For the VN output, it is recommended to use one or two 10 μ F X5R 10V or equivalent ceramic output capacitors. Using two VN output capacitors results in <50mV peak-to-peak output voltage ripple with input voltages from 2.5V to 5V.

[Table 3](#) shows the recommended capacitors for various regulators in ISL98608.

NOTE: Capacitors have a voltage coefficient. The effective capacitance will reduce (derate) as the operating voltage/bias increases. Always refer to the manufacturer's derating information to determine effective capacitance for the operating conditions.

TABLE 3. RECOMMENDED OUTPUT CAPACITORS

CAPACITOR PART NUMBER	VALUE (μ F)	SIZE	QUANTITY
GRM155R61A106ME11 (Murata)	10	0402	x5: C _{IN} , C _{VBST} , C _{VP} , C _{VN} , C _{CP} x1: C _{VN} (x2 for minimum ripple)
GRM188R61C475KAAJ (Murata)	4.7	0603	x5: C _{IN} , C _{VBST} , C _{VP} , C _{VN} , C _{CP} x1: C _{VN} (x2 for minimum ripple)

General Layout Guidelines

When designing the Printed Circuit Board (PCB) layout for the ISL98608, it is very important to understand the power requirements of the system. Some general best practices should be adhered to in order to create an optimal PCB layout:

1. Careful consideration should be taken with any traces carrying AC signals. AC current loops should be kept as short and tight as possible. The current loop generates a magnetic field, which can couple to another conductor, inducing unwanted voltage. Components should be placed such that current flows through them in a straight line as much as possible. This will help reduce size of loops and reduce the EMI from the PCB.
2. If trace lengths are long, the resistance of the trace increases and can cause some reduction in IC efficiency, and can also cause system instability. Traces carrying power should be made wide and short.
3. In discontinuous conduction mode, the direction of the current is interrupted every few cycles. This may result in large di/dt (transient load current). When injected in the ground plane the current may cause voltage drops, which can interfere with sensitive circuitry. The analog ground and power ground of the IC should be connected very close to the IC to mitigate this issue.
4. One plane/layer in the PCB is recommended to be a dedicated ground plane. A large area of metal will have lower resistance, which reduces the return current impedance. More ground plane area minimizes parasitics and avoids corruption of the ground reference.

5. Low frequency digital signals should be isolated from any high frequency signals generated by switching frequency and harmonics. PCB traces should not cross each other. If they must cross due to the layout restriction, then they must cross perpendicularly to reduce the magnetic field interaction.
6. The amount of copper that should be poured (thickness) depends upon the power requirement of the system. Insufficient copper will increase resistance of the PCB, which will increase heat dissipation.
7. Generally, vias should not be used to route high current paths.
8. While designing the layout of switched controllers, do not use the auto routing function of the PCB layout software. Auto routing connects the nets with the same electrical name and does not account for ideal trace lengths and positioning.
8. Digital input pins ENN, ENP, SDA and SCL should be isolated from the high di/dt and dv/dt signals. Otherwise, it may cause a glitch on those inputs.
9. I²C signals, if not used, should be tied to VIN.
10. Analog ground (AGND) and power ground (PGND) of the IC should be connected to each other. It is crucial to connect these two grounds at the location very close to the IC. The regulator should be referenced to the correct ground plane with the short and thick traces. For example, PGND is the power ground for VBST regulator, a capacitor should be placed between VBST and PGND with short and thick trace. All the ground bumps namely PGND, AGND and PGNDPCP should be connected with a network of ground plane.

ISL98608 Specific Layout Guidelines

1. The input capacitor should be connected to the VIN pin (C1) with the smallest trace possible. This helps reject high frequency disturbances and promotes good regulation of the VBST, VP and VN regulators.
2. The inductor for VBST regulator should be connected between VIN and LXP pin with a short and wide trace to reduce the board parasitics. Careful consideration should be made in selecting the inductor as it may cause electromagnetic interference, which could affect IC functionality. A shielded inductor is recommended.
3. Bump VBSTCP is input to the charge pump regulator. This pin must be connected to VBST on the PCB, so that the boost regulator provides the input voltage supply for the charge pump. The CSP bumps for VBST and VBSTCP are A3 and A4 respectively. These two bumps should be connected/shorted to each other on the PCB with a short and thick trace to avoid parasitic inductance and resistance. A 10 μ F/10V capacitor should be used on trace connecting bump A3 and A4 to PGND. The distance of the capacitor from the bump A3 and A4 is critical - it should be placed very close to the IC with a short and thick trace.
4. The current return path for VBST boost regulator should be small as possible. The bump A1 is PGND. It is power ground for VBST regulator. A 10 μ F/10V capacitor should be placed between VBST and PGND.
5. Bump D3 is output of the negative charge pump (VN) and bump D2 is its substrate connection (VSUB). It is highly recommended that D3 and D2 are shorted together with a short and thick trace. It is recommended that 2x10 μ F/10V capacitors are placed on VN to minimize output ripple. Additionally, it will help minimize noise that may be coupled from the high frequency ripple of the charge pump.
6. Bumps B3 is output of the VP regulator. A 10 μ F/10V capacitor should be placed between VP and power ground.
7. Bump B4 is charge pump positive connection and bump D4 is charge pump negative connection. A 10 μ F/10V capacitor should be placed between bump B4 and D4. The capacitor between bump B4 and D4 charges and discharges every cycle and handles high current surges. The capacitor should be placed between CP and CN using short and thick trace.

11. One plane/layer in the PCB is recommended to be a dedicated ground plane.
12. The solder pad on the PCB should not be larger than the solder mask opening for the ball pad on the package. The optimal solder joint strength, it is recommended a 1:1 ratio for the two pads.

[Figure 98 on page 37](#) shows the recommended PCB layout for a typical ISL98608 application.

ISL98608 Layout

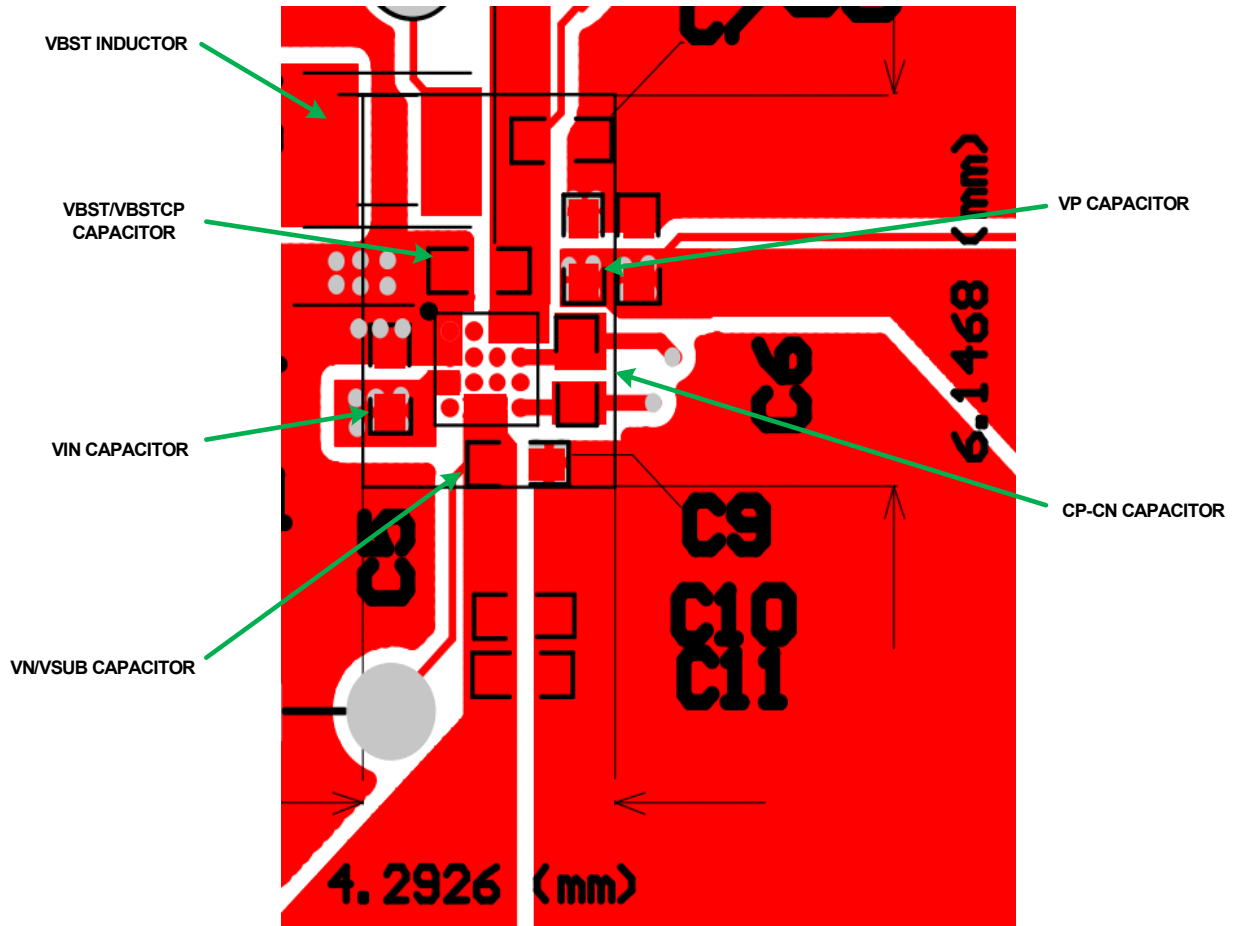

FIGURE 98. ISL98608 RECOMMENDED PCB LAYOUT

Revision History The revision history provided is for informational purposes only and is believed to be accurate, however, not warranted. Please go to the web to make sure that you have the latest revision.

DATE	REVISION	CHANGE
Mar 29, 2017	FN8711.1	<p>Updated Register 0x06, 0x08, and 0x09 default values from 0x0A to 0x00 throughout datasheet. Updated Notes 2 and 3. Added Tape and Reel QTY column to ordering information table. Updated VP Soft-Start and Soft-start Time test conditions on page 7. Updated LXLED labels on curves to LX. Added last paragraph in "Output Voltage Calculation for VBST, VP and VN" on page 25. Updated Equations 1, 2, and 3 on page 25 and in the "Register Map" on page 26. Updated Example Calculations on page 25 and added default information. Updated POD W4x4.16G to the latest revision changes are as follows: Updated Typical Recommended Land Pattern Ball values: -Changed inner measurement from "0.240" to "0.215" -Changed outer measurement from "0.290" to "0.265" Added 4, 5, and 6 note markers. Added Notes 1 and 6. Switched order of Notes 3 and 4. Removed old Note 5.</p>
December 23, 2014	FN8711.0	Initial Release

About Intersil

Intersil Corporation is a leading provider of innovative power management and precision analog solutions. The company's products address some of the largest markets within the industrial and infrastructure, mobile computing and high-end consumer markets.

For the most updated datasheet, application notes, related documentation and related parts, please see the respective product information page found at www.intersil.com.

For a listing of definitions and abbreviations of common terms used in our documents, visit: www.intersil.com/glossary.

You may report errors or suggestions for improving this datasheet by visiting www.intersil.com/ask.

Reliability reports are also available from our website at www.intersil.com/support.

© Copyright Intersil Americas LLC 2014-2017. All Rights Reserved.
All trademarks and registered trademarks are the property of their respective owners.

For additional products, see www.intersil.com/en/products.html

Intersil products are manufactured, assembled and tested utilizing ISO9001 quality systems as noted in the quality certifications found at www.intersil.com/en/support/qualandreliability.html

Intersil products are sold by description only. Intersil may modify the circuit design and/or specifications of products at any time without notice, provided that such modification does not, in Intersil's sole judgment, affect the form, fit or function of the product. Accordingly, the reader is cautioned to verify that datasheets are current before placing orders. Information furnished by Intersil is believed to be accurate and reliable. However, no responsibility is assumed by Intersil or its subsidiaries for its use; nor for any infringements of patents or other rights of third parties which may result from its use. No license is granted by implication or otherwise under any patent or patent rights of Intersil or its subsidiaries.

For information regarding Intersil Corporation and its products, see www.intersil.com

Package Outline Drawing

For the most recent package outline drawing, see [W4x4.16G](#).

W4x4.16G

16 BALL WLCSP WITH 0.4mm PITCH 4x4 ARRAY (1.740mm x 1.740mm)

Rev 1, 9/16

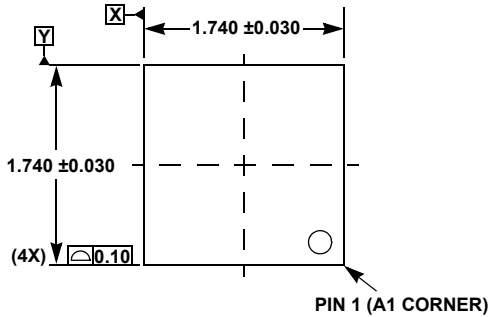

TOP VIEW

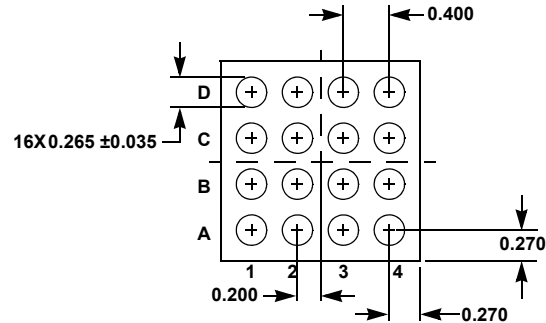

BOTTOM VIEW

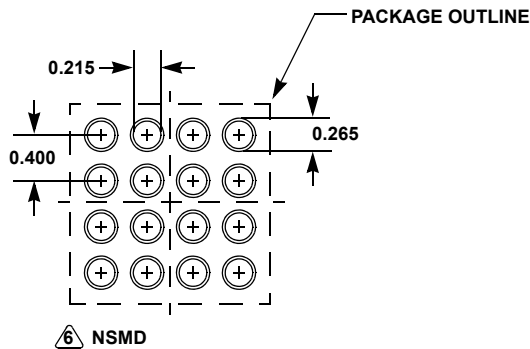

TYPICAL RECOMMENDED LAND PATTERN

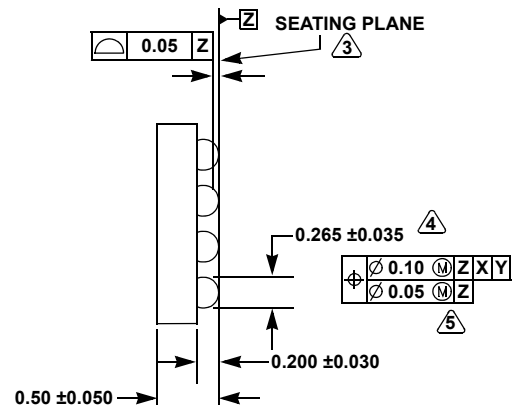

SIDE VIEW

NOTES:

1. All dimensions are in millimeters.
2. Dimensions and tolerances per ASMEY 14.5-1994.
3. Primary datum Z and seating plane are defined by the spherical crowns of the bump.
4. Dimension is measured at the maximum bump diameter parallel to primary datum Z.
5. Bump position designation per JESD 95-1, SPP-010.
6. NSMD refers to non-solder mask defined pad design per Intersil techbrief, [TB451](#).