

To our customers,

Old Company Name in Catalogs and Other Documents

On April 1st, 2010, NEC Electronics Corporation merged with Renesas Technology Corporation, and Renesas Electronics Corporation took over all the business of both companies. Therefore, although the old company name remains in this document, it is a valid Renesas Electronics document. We appreciate your understanding.

Renesas Electronics website: <http://www.renesas.com>

April 1st, 2010
Renesas Electronics Corporation

Issued by: Renesas Electronics Corporation (<http://www.renesas.com>)

Send any inquiries to <http://www.renesas.com/inquiry>.

Not recommended
for new design

Notice

1. All information included in this document is current as of the date this document is issued. Such information, however, is subject to change without any prior notice. Before purchasing or using any Renesas Electronics products listed herein, please confirm the latest product information with a Renesas Electronics sales office. Also, please pay regular and careful attention to additional and different information to be disclosed by Renesas Electronics such as that disclosed through our website.
2. Renesas Electronics does not assume any liability for infringement of patents, copyrights, or other intellectual property rights of third parties by or arising from the use of Renesas Electronics products or technical information described in this document. No license, express, implied or otherwise, is granted hereby under any patents, copyrights or other intellectual property rights of Renesas Electronics or others.
3. You should not alter, modify, copy, or otherwise misappropriate any Renesas Electronics product, whether in whole or in part.
4. Descriptions of circuits, software and other related information in this document are provided only to illustrate the operation of semiconductor products and application examples. You are fully responsible for the incorporation of these circuits, software, and information in the design of your equipment. Renesas Electronics assumes no responsibility for any losses incurred by you or third parties arising from the use of these circuits, software, or information.
5. When exporting the products or technology described in this document, you should comply with the applicable export control laws and regulations and follow the procedures required by such laws and regulations. You should not use Renesas Electronics products or the technology described in this document for any purpose relating to military applications or use by the military, including but not limited to the development of weapons of mass destruction. Renesas Electronics products and technology may not be used for or incorporated into any products or systems whose manufacture, use, or sale is prohibited under any applicable domestic or foreign laws or regulations.
6. Renesas Electronics has used reasonable care in preparing the information included in this document, but Renesas Electronics does not warrant that such information is error free. Renesas Electronics assumes no liability whatsoever for any damages incurred by you resulting from errors in or omissions from the information included herein.
7. Renesas Electronics products are classified according to the following three quality grades: “Standard”, “High Quality”, and “Specific”. The recommended applications for each Renesas Electronics product depends on the product’s quality grade, as indicated below. You must check the quality grade of each Renesas Electronics product before using it in a particular application. You may not use any Renesas Electronics product for any application categorized as “Specific” without the prior written consent of Renesas Electronics. Further, you may not use any Renesas Electronics product for any application for which it is not intended without the prior written consent of Renesas Electronics. Renesas Electronics shall not be in any way liable for any damages or losses incurred by you or third parties arising from the use of any Renesas Electronics product for an application categorized as “Specific” or for which the product is not intended where you have failed to obtain the prior written consent of Renesas Electronics. The quality grade of each Renesas Electronics product is “Standard” unless otherwise expressly specified in a Renesas Electronics data sheets or data books, etc.
 - “Standard”: Computers; office equipment; communications equipment; test and measurement equipment; audio and visual equipment; home electronic appliances; machine tools; personal electronic equipment; and industrial robots.
 - “High Quality”: Transportation equipment (automobiles, trains, ships, etc.); traffic control systems; anti-disaster systems; anti-crime systems; safety equipment; and medical equipment not specifically designed for life support.
 - “Specific”: Aircraft; aerospace equipment; submersible repeaters; nuclear reactor control systems; medical equipment or systems for life support (e.g. artificial life support devices or systems), surgical implantations, or healthcare intervention (e.g. excision, etc.), and any other applications or purposes that pose a direct threat to human life.
8. You should use the Renesas Electronics products described in this document within the range specified by Renesas Electronics, especially with respect to the maximum rating, operating supply voltage range, movement power voltage range, heat radiation characteristics, installation and other product characteristics. Renesas Electronics shall have no liability for malfunctions or damages arising out of the use of Renesas Electronics products beyond such specified ranges.
9. Although Renesas Electronics endeavors to improve the quality and reliability of its products, semiconductor products have specific characteristics such as the occurrence of failure at a certain rate and malfunctions under certain use conditions. Further, Renesas Electronics products are not subject to radiation resistance design. Please be sure to implement safety measures to guard them against the possibility of physical injury, and injury or damage caused by fire in the event of the failure of a Renesas Electronics product, such as safety design for hardware and software including but not limited to redundancy, fire control and malfunction prevention, appropriate treatment for aging degradation or any other appropriate measures. Because the evaluation of microcomputer software alone is very difficult, please evaluate the safety of the final products or system manufactured by you.
10. Please contact a Renesas Electronics sales office for details as to environmental matters such as the environmental compatibility of each Renesas Electronics product. Please use Renesas Electronics products in compliance with all applicable laws and regulations that regulate the inclusion or use of controlled substances, including without limitation, the EU RoHS Directive. Renesas Electronics assumes no liability for damages or losses occurring as a result of your noncompliance with applicable laws and regulations.
11. This document may not be reproduced or duplicated, in any form, in whole or in part, without prior written consent of Renesas Electronics.
12. Please contact a Renesas Electronics sales office if you have any questions regarding the information contained in this document or Renesas Electronics products, or if you have any other inquiries.

(Note 1) “Renesas Electronics” as used in this document means Renesas Electronics Corporation and also includes its majority-owned subsidiaries.

(Note 2) “Renesas Electronics product(s)” means any product developed or manufactured by or for Renesas Electronics.

NPN SILICON GERMANIUM RF TRANSISTOR
NESG250134

NPN SiGe RF TRANSISTOR FOR
 MEDIUM OUTPUT POWER AMPLIFICATION (800 mW)
 3-PIN POWER MINIMOLD (34 PKG)

FEATURES

- This product is suitable for medium output power (800 mW) amplification
 $P_o = 29 \text{ dBm TYP. @ } V_{CE} = 3.6 \text{ V, } P_{in} = 15 \text{ dBm, } f = 460 \text{ MHz}$
 $P_o = 29 \text{ dBm TYP. @ } V_{CE} = 3.6 \text{ V, } P_{in} = 20 \text{ dBm, } f = 900 \text{ MHz}$
- MSG (Maximum Stable Gain) = 23 dB TYP., @ $V_{CE} = 3.6 \text{ V, } I_c = 100 \text{ mA, } f = 460 \text{ MHz}$
- Using UHS2-HV process (SiGe technology), V_{CBO} (ABSOLUTE MAXIMUM RATINGS) = 20 V
- 3-pin power minimold (34 PKG)

★ **ORDERING INFORMATION**

Part Number	Order Number	Package	Quantity	Supplying Form
NESG250134	NESG250134-AZ	3-pin power minimold (Pb-Free) ^{Note1, 2}	25 pcs (Non reel)	• Magazine case
NESG250134-T1	NESG250134-T1-AZ		1 kpcs/reel	• 12 mm wide embossed taping • Pin 2 (Emitter) face the perforation side of the tape

Notes 1. Contains lead in the part except the electrode terminals.

2. With regards to terminal solder (the solder contains lead) plated products (conventionally plated), contact your nearby sales office.

Remark To order evaluation samples, contact your nearby sales office.

Unit sample quantity is 25 pcs.

ABSOLUTE MAXIMUM RATINGS (T_A = +25°C)

Parameter	Symbol	Ratings	Unit
Collector to Base Voltage	V_{CBO}	20	V
Collector to Emitter Voltage	V_{CEO}	9.2	V
Emitter to Base Voltage	V_{EBO}	2.8	V
Collector Current	I_c	500	mA
★ Total Power Dissipation	P_{tot} ^{Note}	1.9	W
Junction Temperature	T_j	150	°C
Storage Temperature	T_{stg}	-65 to +150	°C

Note Mounted on $34.2 \text{ cm}^2 \times 0.8 \text{ mm}$ (t) glass epoxy PWB

Caution Observe precautions when handling because these devices are sensitive to electrostatic discharge.

The information in this document is subject to change without notice. Before using this document, please confirm that this is the latest version.
 Not all devices/types available in every country. Please check with local NEC Compound Semiconductor Devices representative for availability and additional information.

★ THERMAL RESISTANCE (T_A = +25°C)

Parameter	Symbol	Ratings	Unit
Thermal Resistance from Junction to Ambient ^{Note}	R _{thj-a}	65	°C/W

Note Mounted on 34.2 cm² × 0.8 mm (t) glass epoxy PWB

RECOMMENDED OPERATING RANGE (T_A = +25°C)

Parameter	Symbol	MIN.	TYP.	MAX.	Unit
Collector to Emitter Voltage	V _{CE}	–	3.6	4.5	V
Collector Current	I _c	–	400	500	mA
Input Power ^{Note}	P _{in}	–	12	17	dBm

Note Input power under conditions of V_{CE} ≤ 4.5 V, f = 460 MHz

Not recommended for new design

ELECTRICAL CHARACTERISTICS (T_A = +25°C)

Parameter	Symbol	Test Conditions	MIN.	TYP.	MAX.	Unit
DC Characteristics						
Collector Cut-off Current	I _{CBO}	V _{CB} = 5 V, I _E = 0 mA	–	–	1	μA
Emitter Cut-off Current	I _{EBO}	V _{EB} = 0.5 V, I _C = 0 mA	–	–	1	μA
DC Current Gain	h _{FE} ^{Note 1}	V _{CE} = 3 V, I _C = 100 mA	80	120	180	–
RF Characteristics						
Gain Bandwidth Product	f _T	V _{CE} = 3.6 V, I _C = 100 mA, f = 460 MHz	–	10	–	GHz
Insertion Power Gain	S _{21e} ²	V _{CE} = 3.6 V, I _C = 100 mA, f = 460 MHz	–	19	–	dB
Maximum Satble Gain	MSG ^{Note 2}	V _{CE} = 3.6 V, I _C = 100 mA, f = 460 MHz	–	23	–	dB
Linner gain (1)	G _L	V _{CE} = 3.6 V, I _{C (set)} = 30 mA (RF OFF), f = 460 MHz, P _{in} = 0 dBm	16	19	–	dB
Linner gain (2)	G _L	V _{CE} = 3.6 V, I _{C (set)} = 30 mA (RF OFF), f = 900 MHz, P _{in} = 0 dBm	–	16	–	dB
Output Power (1)	P _O	V _{CE} = 3.6 V, I _{C (set)} = 30 mA (RF OFF), f = 460 MHz, P _{in} = 15 dBm	27	29	–	dBm
Output Power (2)	P _O	V _{CE} = 3.6 V, I _{C (set)} = 30 mA (RF OFF), f = 900 MHz, P _{in} = 20 dBm	–	29	–	dBm
Collector Efficiency (1)	η _c	V _{CE} = 3.6 V, I _{C (set)} = 30 mA (RF OFF), f = 460 MHz, P _{in} = 15 dBm	–	60	–	%
Collector Efficiency (2)	η _c	V _{CE} = 3.6 V, I _{C (set)} = 30 mA (RF OFF), f = 900 MHz, P _{in} = 20 dBm	–	60	–	%

Notes 1. Pulse measurement: PW ≤ 350 μs, Duty Cycle ≤ 2%

2. $MSG = \left| \frac{S_{21}}{S_{12}} \right|$

h_{FE} CLASSIFICATION

Rank	FB
Marking	SN
h _{FE} Value	80 to 180

★ **S-PARAMETERS**

S-parameters/Noise parameters are provided on the NEC Compound Semiconductor Devices Web site in a form (S2P) that enables direct import to a microwave circuit simulator without keyboard input.

Click here to download S-parameters.

[RF and Microwave] → [Device Parameters]

URL <http://www.ncsd.necel.com/>

★ TYPICAL CHARACTERISTICS (TA = +25°C, unless otherwise specified)

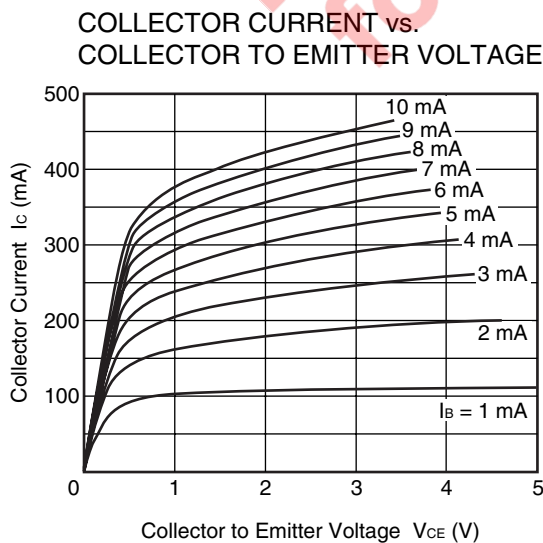
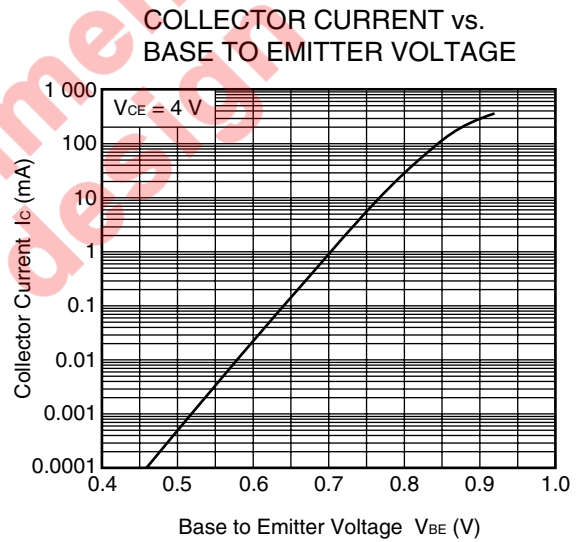
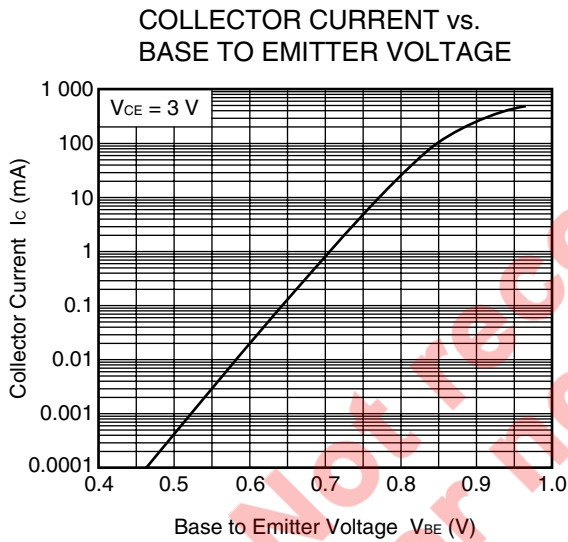
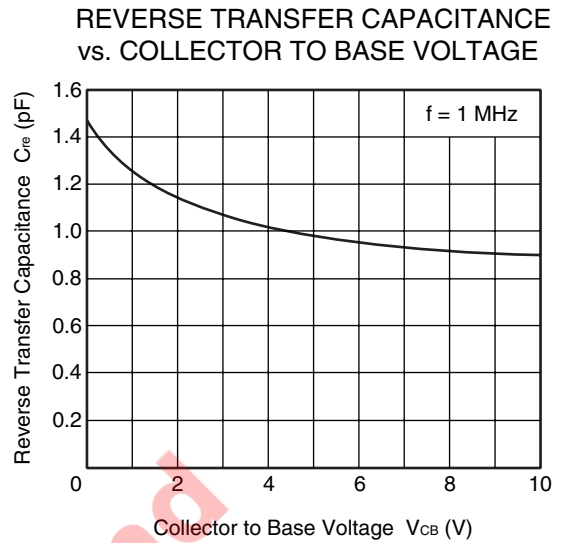
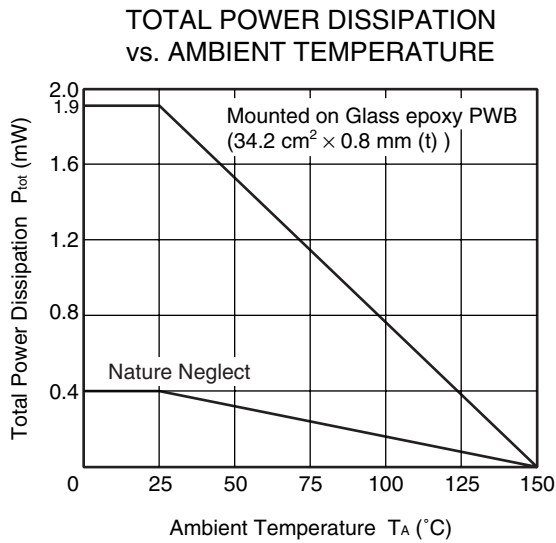

Remark The graphs indicate nominal characteristics.

DC CURRENT GAIN vs. COLLECTOR CURRENT

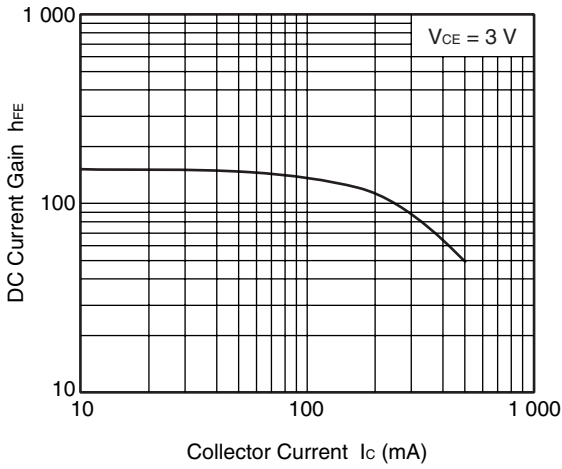

DC CURRENT GAIN vs. COLLECTOR CURRENT

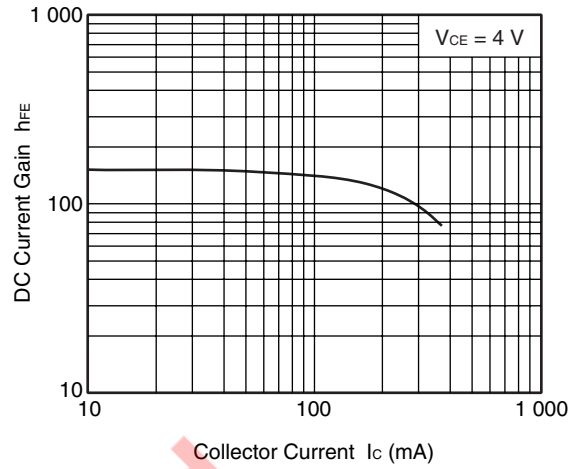

GAIN BANDWIDTH PRODUCT vs. COLLECTOR CURRENT

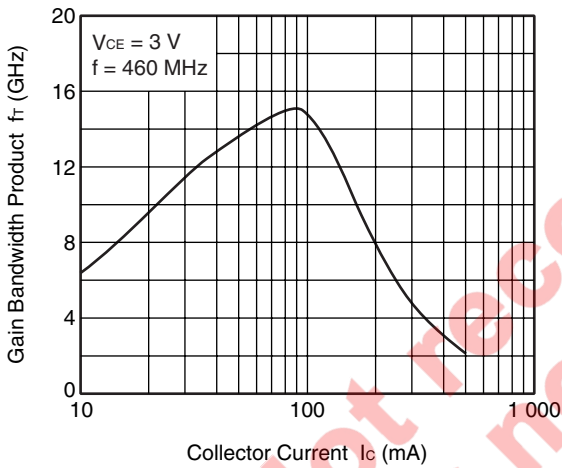

GAIN BANDWIDTH PRODUCT vs. COLLECTOR CURRENT

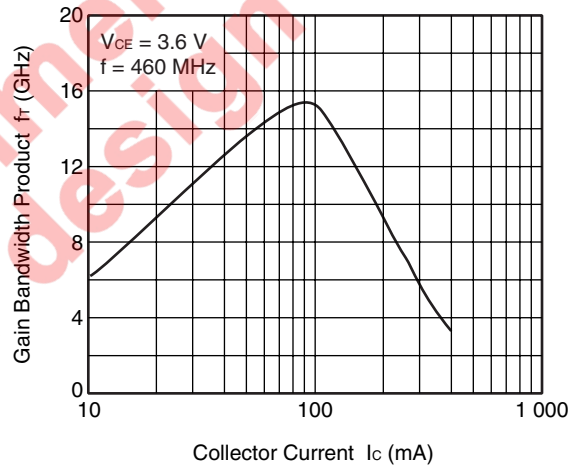

GAIN BANDWIDTH PRODUCT vs. COLLECTOR CURRENT

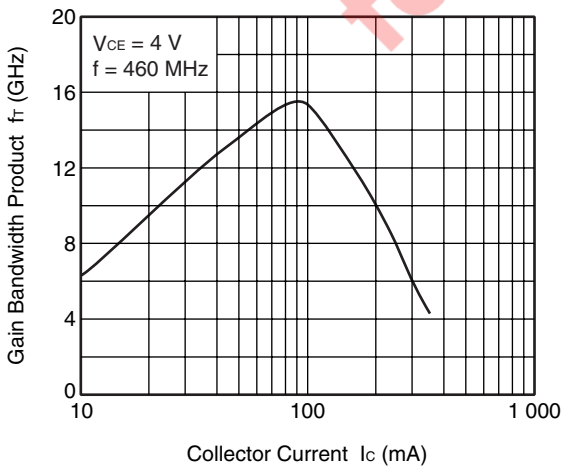

INSERTION POWER GAIN, MAG, MSG vs. FREQUENCY

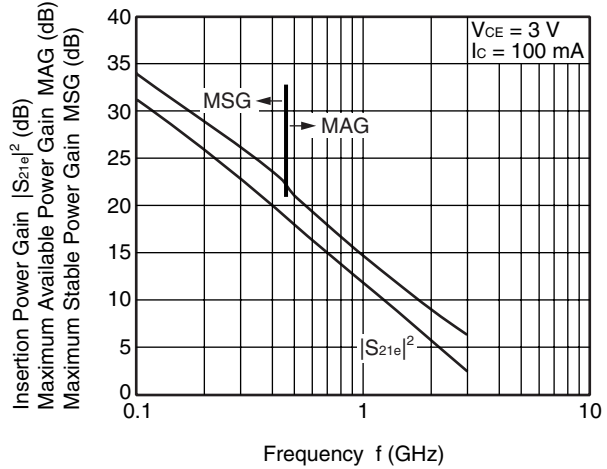

Remark The graphs indicate nominal characteristics.

INSERTION POWER GAIN, MAG, MSG vs. FREQUENCY

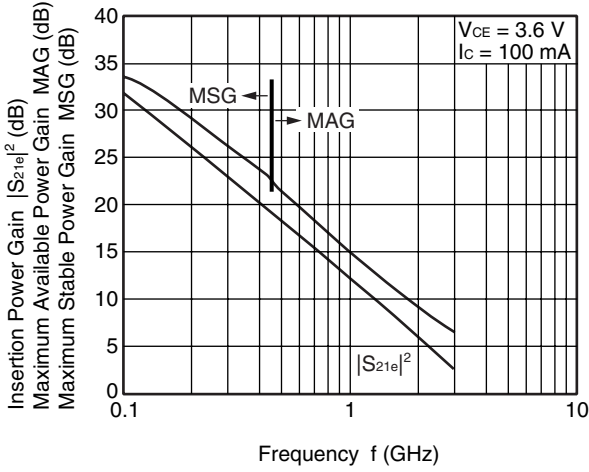

INSERTION POWER GAIN, MAG, MSG vs. FREQUENCY

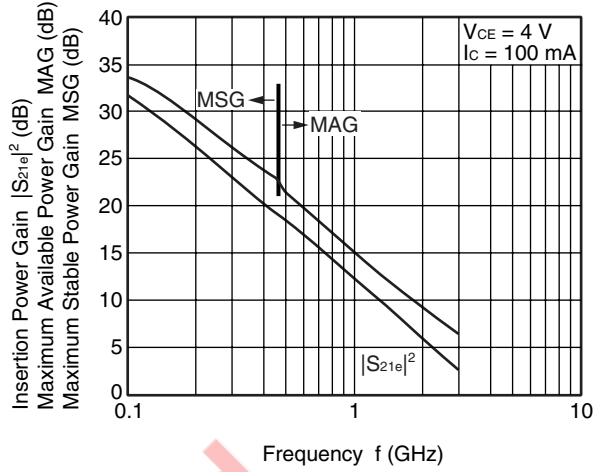

INSERTION POWER GAIN, MAG, MSG vs. COLLECTOR CURRENT

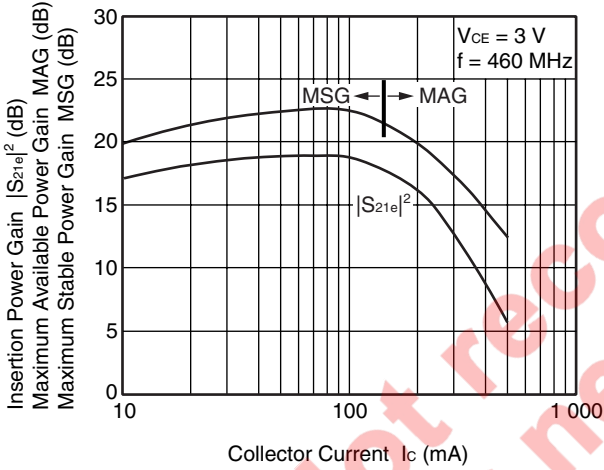

INSERTION POWER GAIN, MAG, MSG vs. COLLECTOR CURRENT

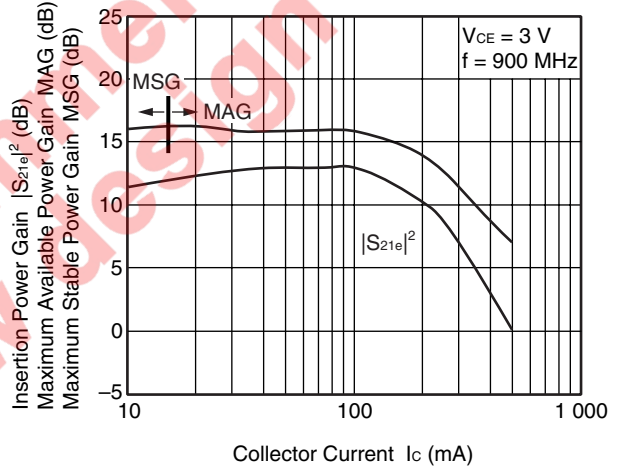

INSERTION POWER GAIN, MAG, MSG vs. COLLECTOR CURRENT

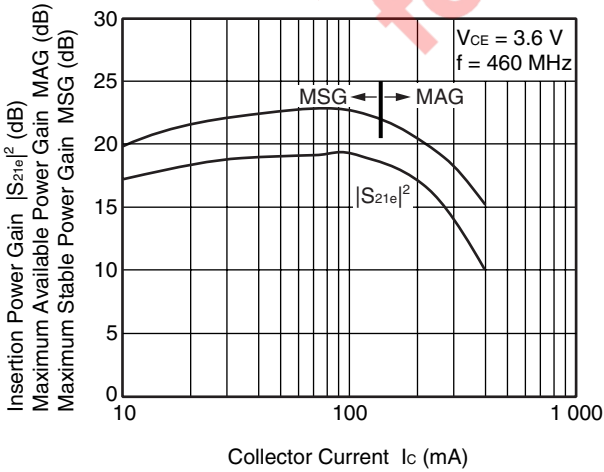

INSERTION POWER GAIN, MAG, MSG vs. COLLECTOR CURRENT

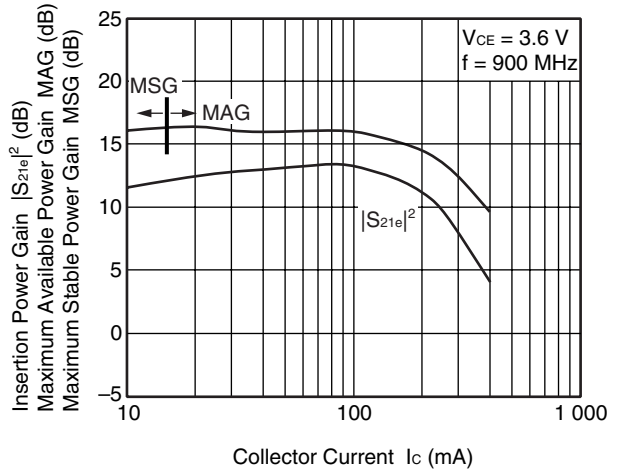

Remark The graphs indicate nominal characteristics.

INSERTION POWER GAIN, MAG, MSG vs. COLLECTOR CURRENT

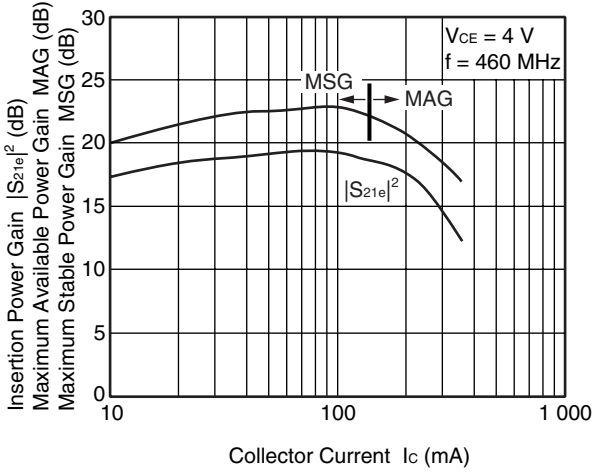

INSERTION POWER GAIN, MAG, MSG vs. COLLECTOR CURRENT

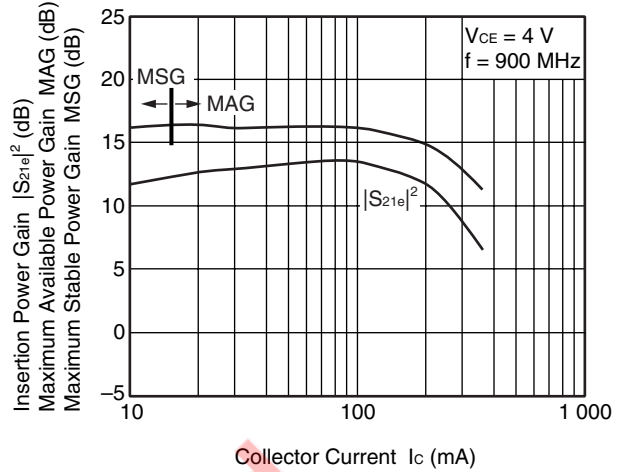

OUTPUT POWER, POWER GAIN, COLLECTOR CURRENT, COLLECTOR EFFICIENCY vs. INPUT POWER

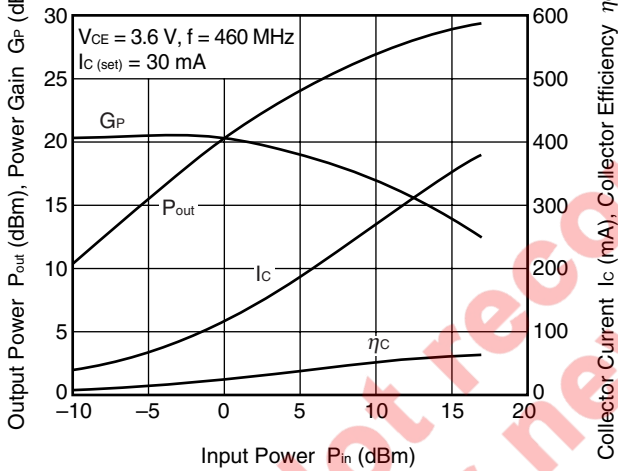

OUTPUT POWER, POWER GAIN, COLLECTOR CURRENT, COLLECTOR EFFICIENCY vs. INPUT POWER

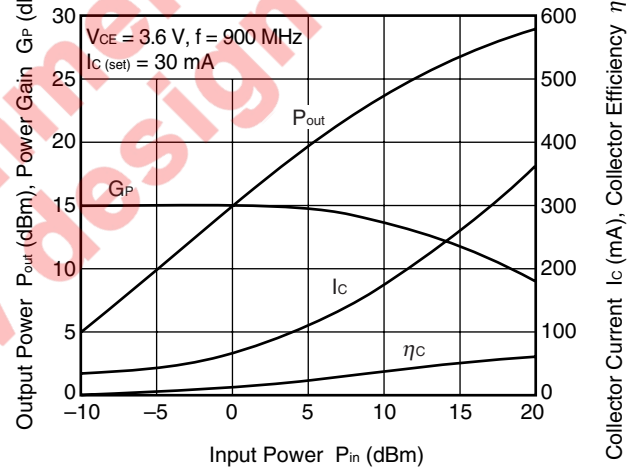

NOISE FIGURE, ASSOCIATED GAIN vs. COLLECTOR CURRENT

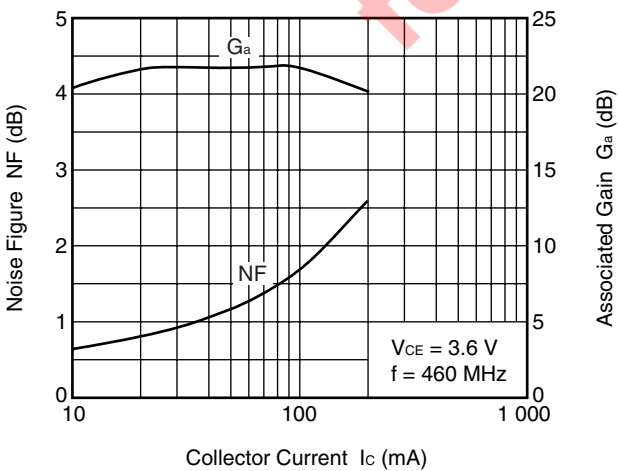

Remark The graphs indicate nominal characteristics.

PA EVALUATION BOARD (f = 460 MHz)

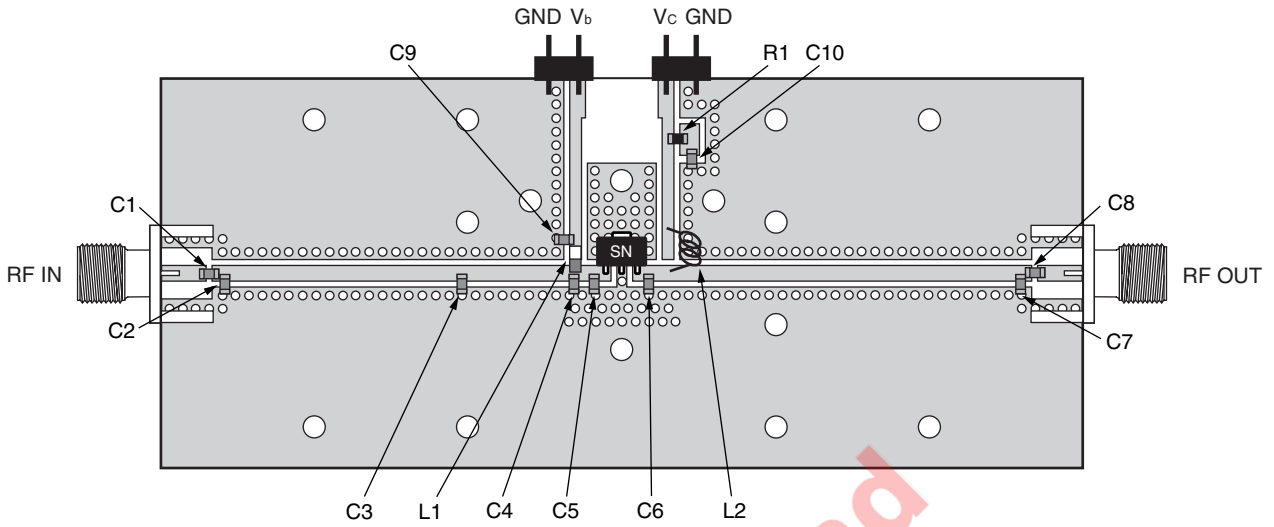

Notes

1. 38 × 90 mm, t = 0.8 mm double sided copper clad glass epoxy PWB.
2. Back side: GND pattern
3. Solder gold plated on pattern
4. o○: Through holes

PA EVALUATION CIRCUIT (f = 460 MHz)

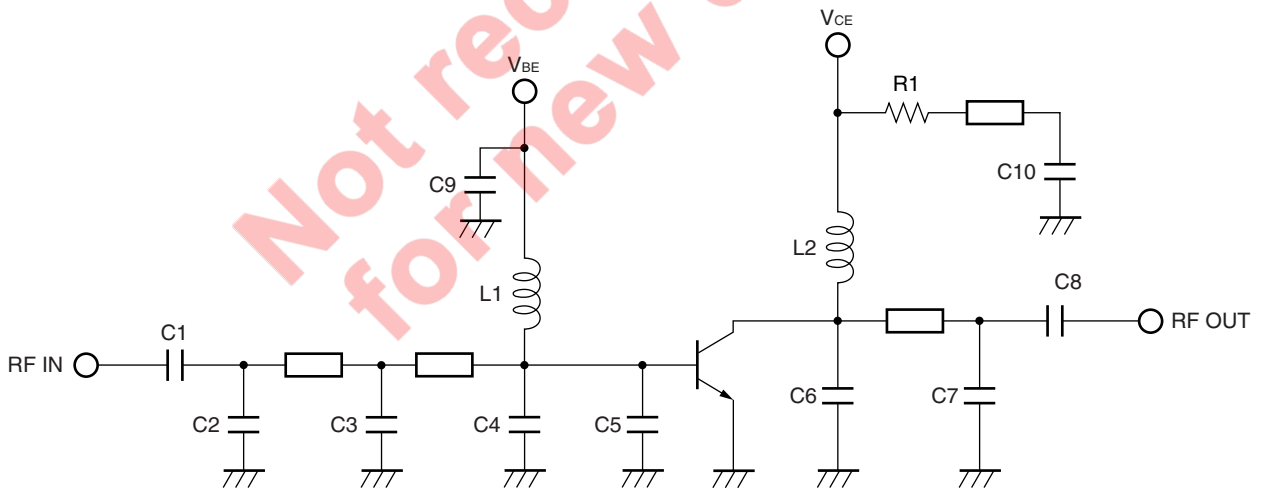

The application circuits and their parameters are for reference only and are not intended for use in actual design-ins.

COMPONENT LIST

	Value	Maker
C1	30 pF	Murata
C2	6 pF	Murata
C3, C4	7 pF	Murata
C5	3 pF	Murata
C6	0.5 pF	Murata
C7	5 pF	Murata
C8	10 pF	Murata
C9, C10	100 nF	Murata
L1	100 nH	Toko
L2	3 nH	Toko
R1	30 Ω	SSM

PA EVALUATION CIRCUIT TYPICAL CHARACTERISTICS

OUTPUT POWER, POWER GAIN, COLLECTOR CURRENT, COLLECTOR EFFICIENCY vs. INPUT POWER

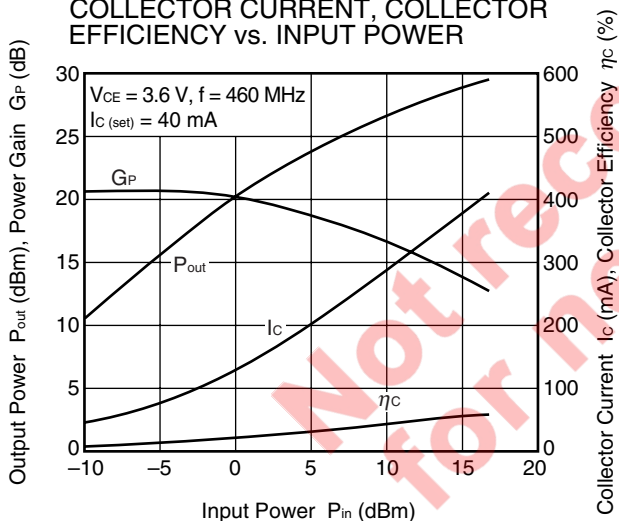

Remark The graph indicates nominal characteristics.

DISTORTION EVALUATION BOARD (f = 460 MHz)

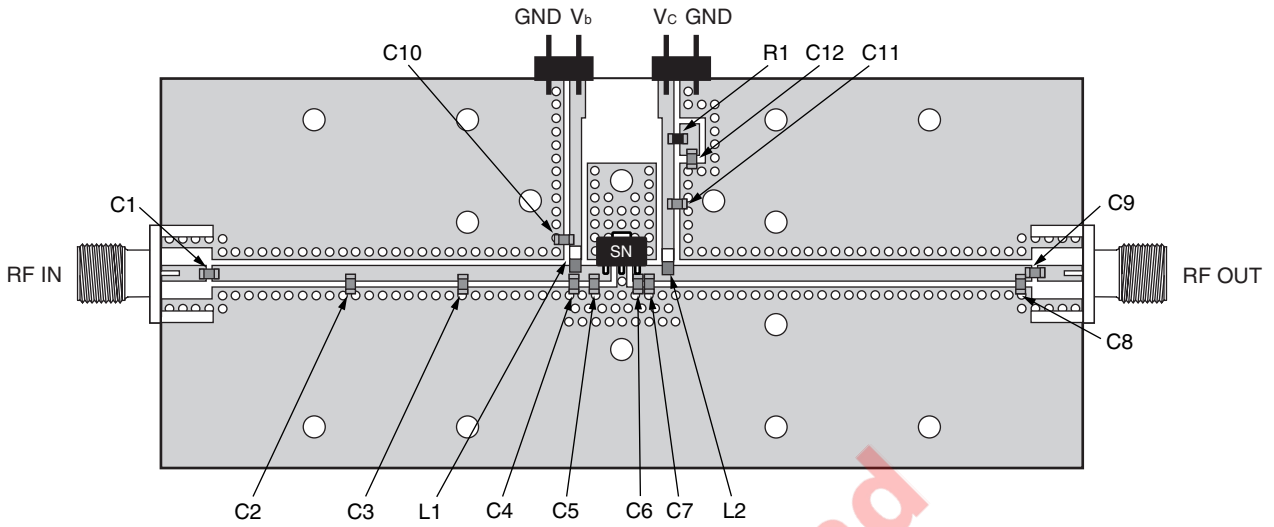

Notes

1. 38 × 90 mm, t = 0.8 mm, double sided copper clad glass epoxy PWB.
2. Back side: GND pattern
3. Solder gold plated on pattern
4. ○○: Through holes

DISTORTION EVALUATION CIRCUIT (f = 460 MHz)

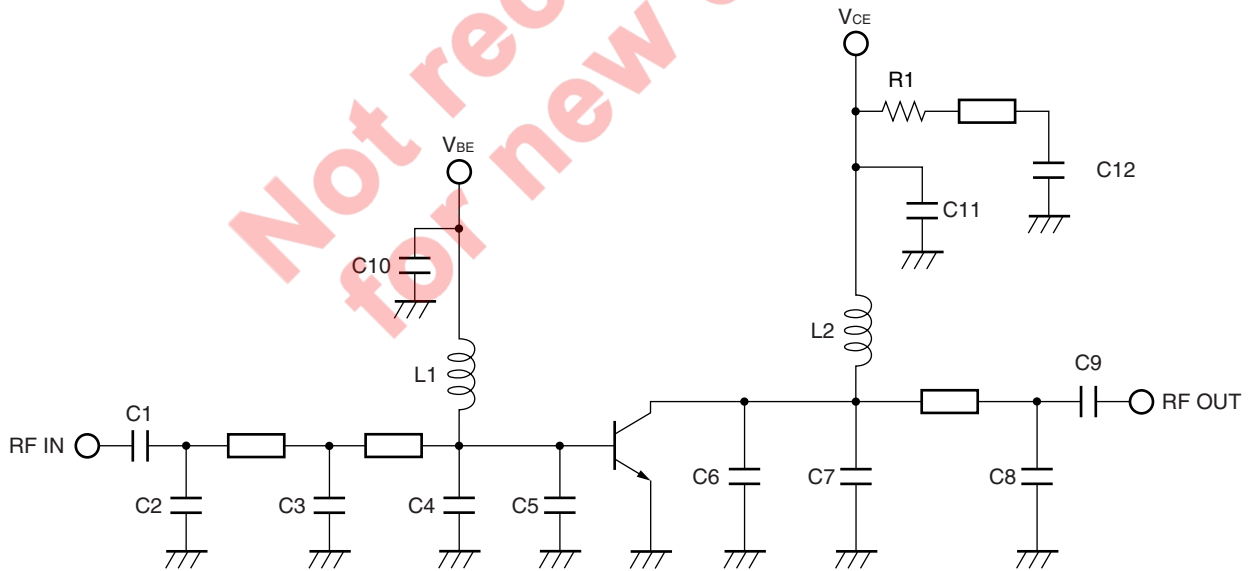

The application circuits and their parameters are for reference only and are not intended for use in actual design-ins.

COMPONENT LIST

	Value	Maker
C1	47 pF	Murata
C2	12 pF	Murata
C3, C4	7 pF	Murata
C5	3 pF	Murata
C6	6 pF	Murata
C7	0.5 pF	Murata
C8	5 pF	Murata
C9	51 pF	Murata
C10, C12	100 nF	Murata
C11	1 μ F	Murata
L1	100 nH	Toko
L2	15 nH	Toko
R1	30 Ω	SSM

DISTORTION EVALUATION CIRCUIT TYPICAL CHARACTERISTICS

3RD ORDER
INTERMODULATION DISTORTION
vs. 1 TONE OUTPUT POWER

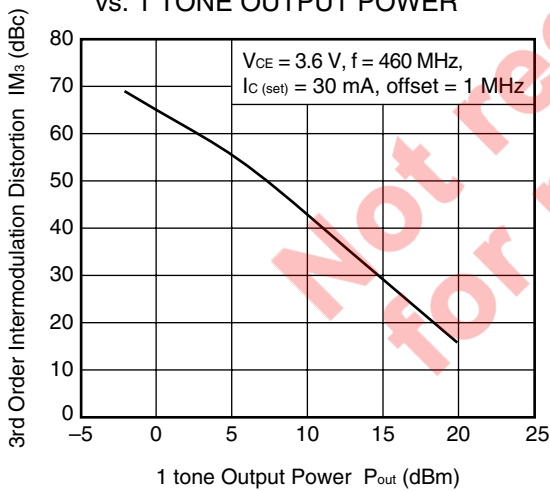

Remark The graph indicates nominal characteristics.

PACKAGE DIMENSIONS

3-PIN POWER MINIMOLD (34 PKG) (UNIT: mm)

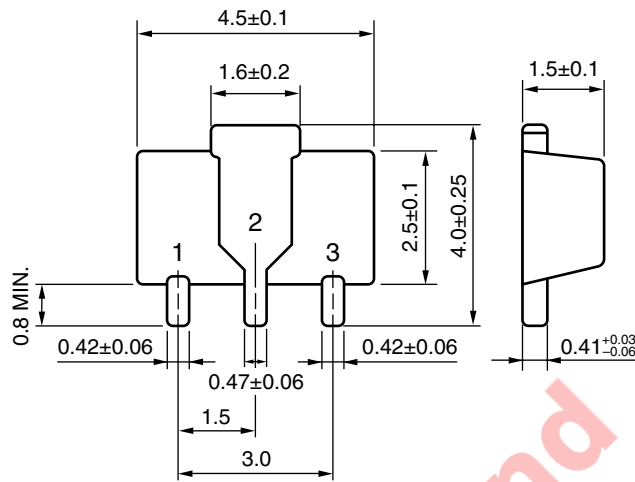

PIN CONNECTIONS

- 1. Collector
- 2. Emitter
- 3. Base

Not recommend
for new design

- **The information in this document is current as of October, 2004. The information is subject to change without notice. For actual design-in, refer to the latest publications of NEC's data sheets or data books, etc., for the most up-to-date specifications of NEC semiconductor products. Not all products and/or types are available in every country. Please check with an NEC sales representative for availability and additional information.**
 - No part of this document may be copied or reproduced in any form or by any means without prior written consent of NEC. NEC assumes no responsibility for any errors that may appear in this document.
 - NEC does not assume any liability for infringement of patents, copyrights or other intellectual property rights of third parties by or arising from the use of NEC semiconductor products listed in this document or any other liability arising from the use of such products. No license, express, implied or otherwise, is granted under any patents, copyrights or other intellectual property rights of NEC or others.
 - Descriptions of circuits, software and other related information in this document are provided for illustrative purposes in semiconductor product operation and application examples. The incorporation of these circuits, software and information in the design of customer's equipment shall be done under the full responsibility of customer. NEC assumes no responsibility for any losses incurred by customers or third parties arising from the use of these circuits, software and information.
 - While NEC endeavours to enhance the quality, reliability and safety of NEC semiconductor products, customers agree and acknowledge that the possibility of defects thereof cannot be eliminated entirely. To minimize risks of damage to property or injury (including death) to persons arising from defects in NEC semiconductor products, customers must incorporate sufficient safety measures in their design, such as redundancy, fire-containment, and anti-failure features.
 - NEC semiconductor products are classified into the following three quality grades:
 "Standard", "Special" and "Specific". The "Specific" quality grade applies only to semiconductor products developed based on a customer-designated "quality assurance program" for a specific application. The recommended applications of a semiconductor product depend on its quality grade, as indicated below. Customers must check the quality grade of each semiconductor product before using it in a particular application.
 "Standard": Computers, office equipment, communications equipment, test and measurement equipment, audio and visual equipment, home electronic appliances, machine tools, personal electronic equipment and industrial robots
 "Special": Transportation equipment (automobiles, trains, ships, etc.), traffic control systems, anti-disaster systems, anti-crime systems, safety equipment and medical equipment (not specifically designed for life support)
 "Specific": Aircraft, aerospace equipment, submersible repeaters, nuclear reactor control systems, life support systems and medical equipment for life support, etc.
- The quality grade of NEC semiconductor products is "Standard" unless otherwise expressly specified in NEC's data sheets or data books, etc. If customers wish to use NEC semiconductor products in applications not intended by NEC, they must contact an NEC sales representative in advance to determine NEC's willingness to support a given application.
- (Note)
- (1) "NEC" as used in this statement means NEC Corporation, NEC Compound Semiconductor Devices, Ltd. and also includes its majority-owned subsidiaries.
 - (2) "NEC semiconductor products" means any semiconductor product developed or manufactured by or for NEC (as defined above).

M8E 00.4-0110

Not recommend
for new design

► For further information, please contact

NEC Compound Semiconductor Devices, Ltd. <http://www.ncsd.necel.com/>

E-mail: salesinfo@ml.ncsd.necel.com (sales and general)

techinfo@ml.ncsd.necel.com (technical)

Sales Division TEL: +81-44-435-1588 FAX: +81-44-435-1579

NEC Compound Semiconductor Devices Hong Kong Limited

E-mail: ncsd-hk@elhk.nec.com.hk (sales, technical and general)

Hong Kong Head Office TEL: +852-3107-7303 FAX: +852-3107-7309

Taipei Branch Office TEL: +886-2-8712-0478 FAX: +886-2-2545-3859

Korea Branch Office TEL: +82-2-558-2120 FAX: +82-2-558-5209

NEC Electronics (Europe) GmbH <http://www.ee.nec.de/>

TEL: +49-211-6503-0 FAX: +49-211-6503-1327

California Eastern Laboratories, Inc. <http://www.cel.com/>

TEL: +1-408-988-3500 FAX: +1-408-988-0279