

R1EV24002ASAS0A

Two-wire serial interface
2k EEPROM (256-word × 8-bit)

R10DS0101EJ0100
Rev.1.00
Apr. 25, 2012

Description

R1EV24xxx series are two-wire serial interface EEPROM (Electrically Erasable and Programmable ROM). They realize high speed, low power consumption and a high level of reliability by employing advanced MONOS memory technology and CMOS process and low voltage circuitry technology. They also have a 8-byte page programming function to make their write operation faster.

Note: Renesas Electronics' serial EEPROM are authorized for using consumer applications such as cellular phone, camcorders, audio equipment. Therefore, please contact Renesas Electronics' sales office before using industrial applications such as automotive systems, embedded controllers, and meters.

Features

- Single supply: 2.5 V to 5.5 V
- Two-wire serial interface (I²C serial bus)
- Clock frequency: 400 kHz
- Power dissipation:
 - Standby: 2 μA (max)
 - Active (Read): 1 mA (max)
 - Active (Write): 2.5 mA (max)
- Automatic page write: 8-byte/page
- Write cycle time: 5 ms
- Endurance: 1,000k Cycles @25°C
- Data retention: 100 Years @25°C
- Small size packages: SOP-8pin
- Shipping tape and reel
 - SOP 8-pin: 4,000 IC/reel
- Temperature range: -40 to +85°C
- Lead free products.

Not recommend
for new design

Ordering Information

Orderable Part Numbers	Internal organization	Package	Shipping tape and reel
R1EV24002ASAS0A#K0	2k bit (256 × 8-bit)	150 mil 8-pin plastic SOP PRSP0008DF-B (FP-8DBV) Lead free	4,000 IC/reel

Pin Arrangement

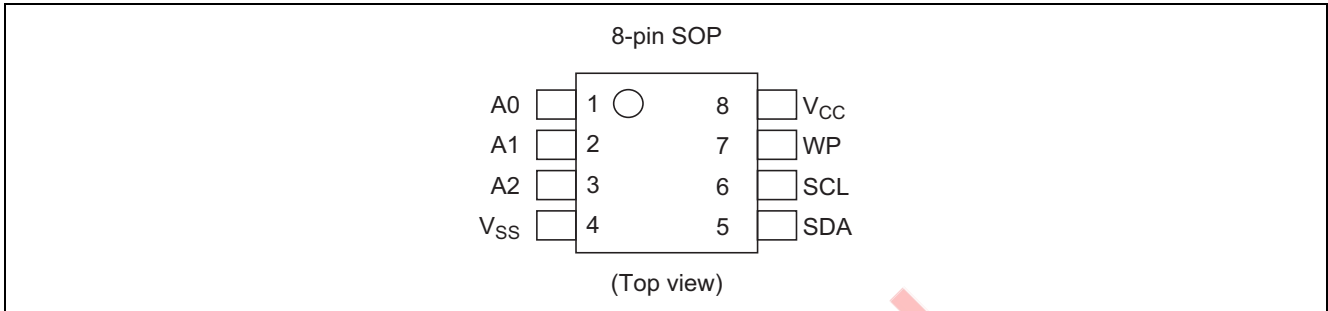

Pin Description

Pin name	Function
A0 to A2	Device address
SCL	Serial clock input
SDA	Serial data input/output
WP	Write protect
V _{CC}	Power supply
V _{SS}	Ground

Block Diagram

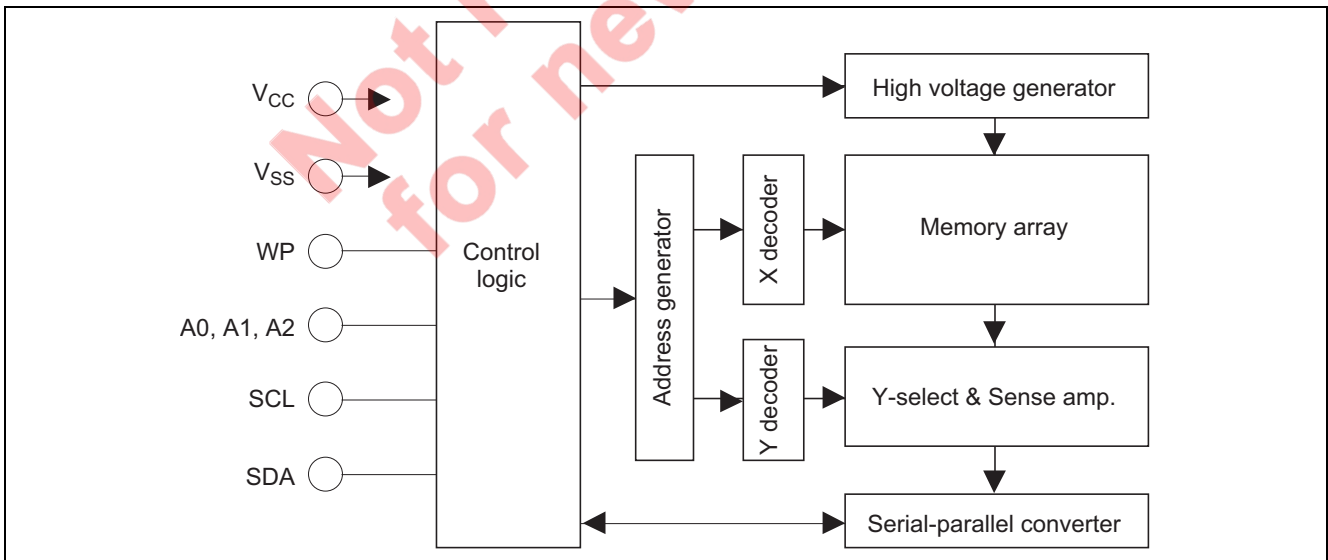

Absolute Maximum Ratings

Parameter	Symbol	Value	Unit
Supply voltage relative to V_{SS}	V_{CC}	-0.6 to +7.0	V
Input voltage relative to V_{SS}	V_{in}	-0.5* ² to +7.0* ³	V
Operating temperature range* ¹	T_{opr}	-40 to +85	°C
Storage temperature range	T_{stg}	-55 to +125	°C

- Notes: 1. Including electrical characteristics and data retention.
 2. V_{in} (min): -3.0 V for pulse width \leq 50 ns.
 3. Should not exceed $V_{CC} + 1.0$ V.

DC Operating Conditions

Parameter	Symbol	Min	Typ	Max	Unit
Supply voltage	V_{CC}	2.5	—	5.5	V
	V_{SS}	0	0	0	V
Input high voltage	V_{IH}	$V_{CC} \times 0.7$	—	$V_{CC} + 0.5$	V
Input low voltage	V_{IL}	-0.3* ¹	—	$V_{CC} \times 0.3$	V
Operating temperature	T_{opr}	-40	—	+85	°C

- Note: 1. V_{IL} (min): -1.0 V for pulse width \leq 50 ns.

DC Characteristics

($T_a = -40$ to $+85^\circ\text{C}$, $V_{CC} = 2.5$ V to 5.5 V)

Parameter	Symbol	Min	Typ	Max	Unit	Test conditions
Input leakage current	I_{LI}	—	—	2.0	μA	$V_{CC} = 5.5$ V, $V_{in} = 0$ to 5.5 V
Output leakage current	I_{LO}	—	—	2.0	μA	$V_{CC} = 5.5$ V, $V_{out} = 0$ to 5.5 V
Standby V_{CC} current	I_{SB}	—	1.0	2.0	μA	$V_{in} = V_{SS}$ or V_{CC}
Read V_{CC} current	I_{CC1}	—	—	1.0	mA	$V_{CC} = 5.5$ V, Read at 400 kHz
Write V_{CC} current	I_{CC2}	—	—	2.5	mA	$V_{CC} = 5.5$ V, Write at 400 kHz
Output low voltage	V_{OL}	—	—	0.4	V	$I_{OL} = 3.0$ mA

Capacitance

($T_a = +25^\circ\text{C}$, $f = 1$ MHz)

Parameter	Symbol	Min	Typ	Max	Unit	Test conditions
Input capacitance (A0 to A2, SCL, WP)	C_{in}^{*1}	—	—	6.0	pF	$V_{in} = 0$ V
Output capacitance (SDA)	$C_{I/O}^{*1}$	—	—	6.0	pF	$V_{out} = 0$ V

- Note: 1. Not 100% tested.

Memory cell characteristics

($V_{CC} = 2.5$ V to 5.5 V)

	$T_a = 25^\circ\text{C}$	$T_a = 85^\circ\text{C}$	Notes
Endurance	1,000k Cycles min.	100k Cycles min	1
Data retention	100 Years min.	10 Years min.	1

- Note: 1. Not 100% tested.

AC Characteristics

($T_a = -40$ to $+85^\circ\text{C}$, $V_{CC} = 2.5$ to 5.5 V)

Test Conditions

- Input pules levels:
 - $V_{IL} = 0.2 \times V_{CC}$
 - $V_{IH} = 0.8 \times V_{CC}$
- Input rise and fall time: ≤ 20 ns
- Input and output timing reference levels: $0.5 \times V_{CC}$
- Output load: TTL Gate + 100 pF

Parameter	Symbol	Min	Typ	Max	Unit	Notes
Clock frequency	f_{SCL}	—	—	400	kHz	
Clock pulse width low	t_{LOW}	1200	—	—	ns	
Clock pulse width high	t_{HIGH}	600	—	—	ns	
Noise suppression time	t_i	—	—	50	ns	1
Access time	t_{AA}	100	—	900	ns	
Bus free time for next mode	t_{BUF}	1200	—	—	ns	
Start hold time	$t_{HD.STA}$	600	—	—	ns	
Start setup time	$t_{SU.STA}$	600	—	—	ns	
Data in hold time	$t_{HD.DAT}$	0	—	—	ns	
Data in setup time	$t_{SU.DAT}$	100	—	—	ns	
Input rise time	t_R	—	—	300	ns	1
Input fall time	t_F	—	—	300	ns	1
Stop setup time	$t_{SU.STO}$	600	—	—	ns	
Data out hold time	t_{DH}	50	—	—	ns	
Write protect hold time	$t_{HD.WP}$	1200	—	—	ns	
Write protect setup time	$t_{SU.WP}$	0	—	—	ns	
Write cycle time	t_{WC}	—	—	5	ms	2

Notes: 1. Not 100% tested.

2. t_{WC} is the time from a stop condition to the end of internally controlled write cycle.

Timing Waveforms

Bus Timing

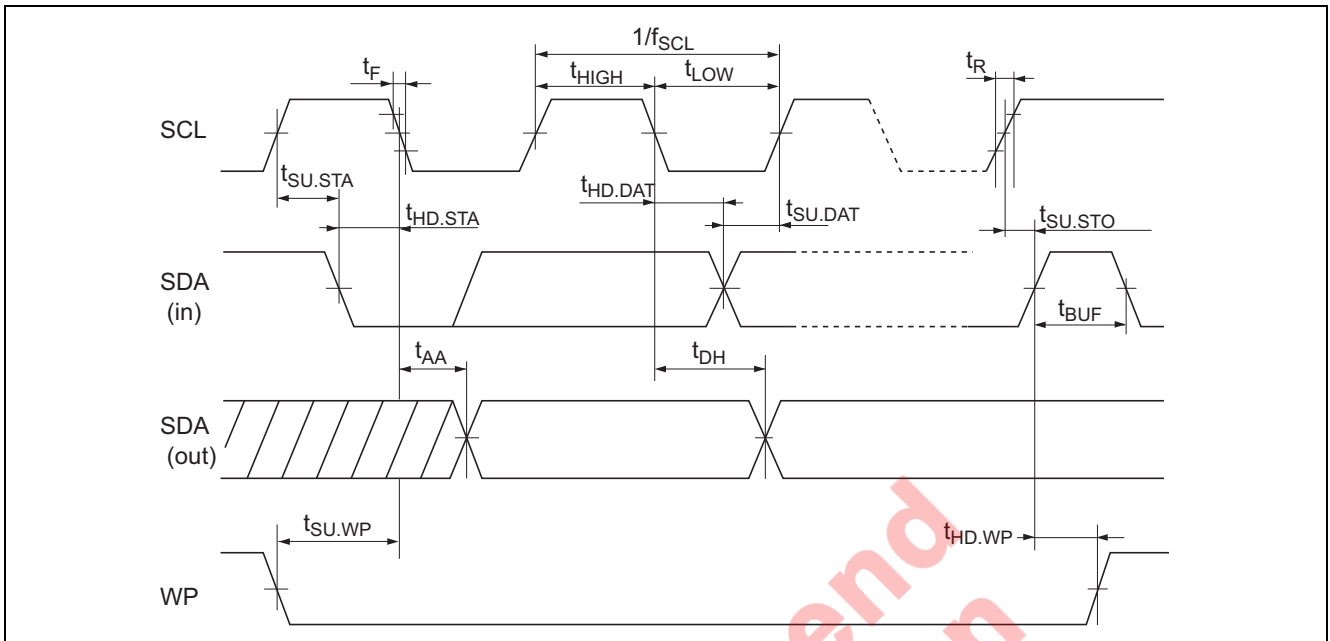

Write Cycle Timing

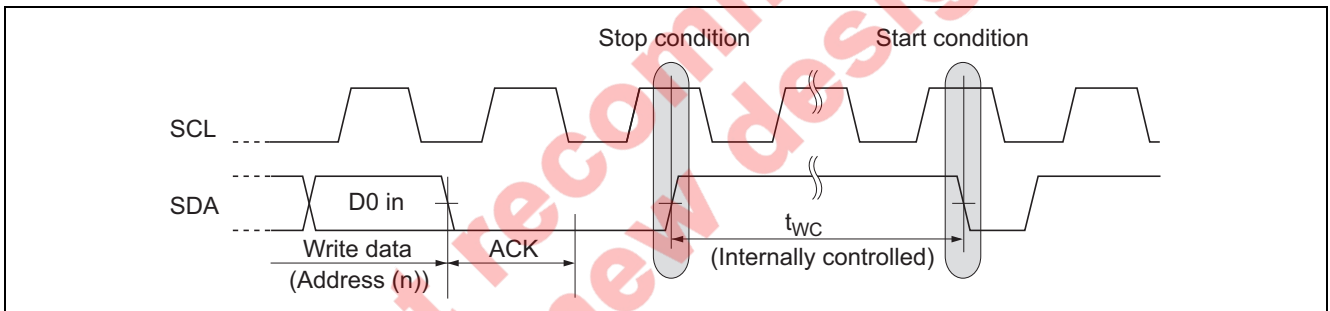

Pin Function

Serial Clock (SCL)

The SCL pin is used to control serial input/output data timing. The SCL input is used to positive edge clock data into EEPROM device and negative edge clock data out of each device. Maximum clock rate is 400 kHz.

Serial Input/Output Data (SDA)

The SDA pin is bidirectional for serial data transfer. The SDA pin needs to be pulled up by resistor as that pin is open-drain driven structure. Use proper resistor value for your system by considering V_{OL} , I_{OL} and the SDA pin capacitance. Except for a start condition and a stop condition which will be discussed later, the SDA transition needs to be completed during the SCL low period.

Data Validity (SDA data change timing waveform)

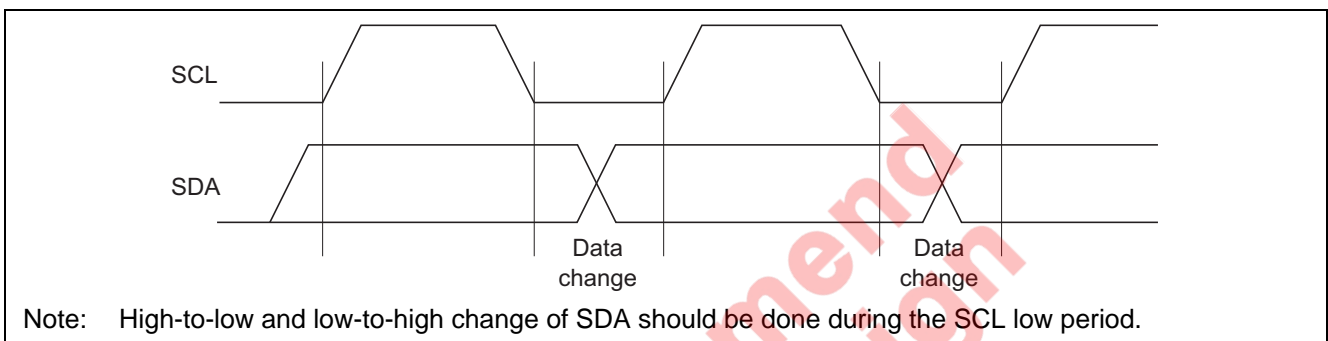

Device Address (A0, A1, A2)

Eight devices can be wired for one common data bus line as maximum. Device address pins are used to distinguish each device and device address pins should be connected to V_{CC} or V_{SS} . When device address code provided from SDA pin matches corresponding hard-wired device address pins A0 to A2, that one device can be activated.

Pin Connections for A0 to A2

Memory size	Max connect number	Pin connection			Note
		A2	A1	A0	
2k bit	8	V_{CC}/V_{SS}	V_{CC}/V_{SS}	V_{CC}/V_{SS}	

Note: 1. During floating, " V_{CC}/V_{SS} " are fixed to V_{SS} .

Write Protect (WP)

When the Write Protect pin (WP) is high, the write protection feature is enabled and operates as shown in the following table.

Also, acknowledgment "0" is outputted after inputting device address and memory address. After inputting write data, acknowledgment "1" (**NO ACK**) is outputted.

When the WP is low, write operation for all memory arrays are allowed. The read operation is always activated irrespective of the WP pin status.

Write Protect Area

WP pin status	Write protect area
	2k bit
V_{IH}	Full (2k bit)
V_{IL}	Normal read/write operation

Functional Description

Start Condition

A high-to-low transition of the SDA with the SCL high is needed in order to start read, write operation (See start condition and stop condition).

Stop Condition

A low-to-high transition of the SDA with the SCL high is a stop condition. The stand-by operation starts after a read sequence by a stop condition. In the case of write operation, a stop condition terminates the write data inputs and place the device in a internally-timed write cycle to the memories. After the internally-timed write cycle which is specified as t_{WC} , the device enters a standby mode (See write cycle timing).

Start Condition and Stop Condition

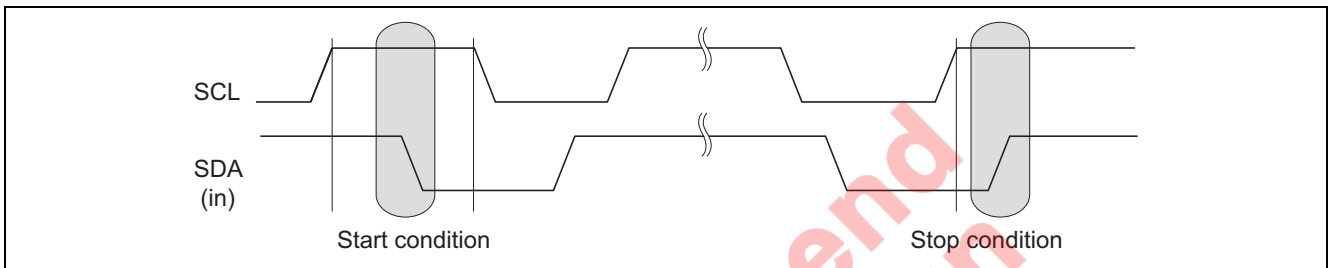

Acknowledge

All addresses and data words are serially transmitted to and from in 8-bit words. The receiver sends a zero to acknowledge that it has received each word. This happens during ninth clock cycle. The transmitter keeps bus open to receive acknowledgment from the receiver at the ninth clock. In the write operation, EEPROM sends a zero to acknowledge after receiving every 8-bit words. In the read operation, EEPROM sends a zero to acknowledge after receiving the device address word. After sending read data, the EEPROM waits acknowledgment by keeping bus open. If the EEPROM receives zero as an acknowledge, it sends read data of next address. If the EEPROM receives acknowledgment "1" (no acknowledgment) and a following stop condition, it stops the read operation and enters a stand-by mode. If the EEPROM receives neither acknowledgment "0" nor a stop condition, the EEPROM keeps bus open without sending read data.

Acknowledge Timing Waveform

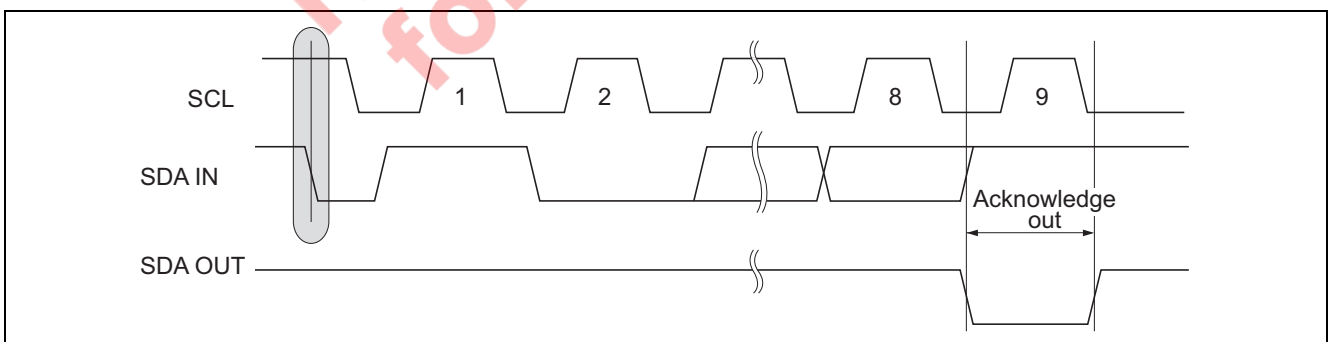

Device Addressing

The EEPROM device requires an 8-bit device address word following a start condition to enable the chip for a read or a write operation. The device address word consists of 4-bit device code, 3-bit device address code and 1-bit read/write(R/W) code. The most significant 4-bit of the device address word are used to distinguish device type and this EEPROM uses “1010” fixed code. The device address word is followed by the 3-bit device address code A2, A1, A0. The device address code selects one device out of eight devices which are connected to the bus. This means that the device is selected if the inputted 3-bit device address code is equal to the corresponding hard-wired A2 to A0 pins status. The eighth bit of the device address word is the read/write(R/W) bit. A write operation is initiated if this bit is “0” and a read operation is initiated if this bit is “1”. The EEPROM turns to a stand-by state if the device code is not “1010” or device address code doesn’t coincide with status of the correspond hard-wired device address pins.

Device Address Word

Device address word (8-bit)								
Device code (fixed)				Device address code			R/W code*1	
2k	1	0	1	0	A2	A1	A0	R/W

Note: 1. R/W=“1” is read and R/W = “0” is write.

Not recommend
for new design

Write Operations (WP=Low)

Byte Write: (Write operation during WP=Low status)

A write operation requires an 8-bit device address word with R/W = "0". Then the EEPROM sends acknowledgment "0" at the ninth clock cycle. After these, the 2k bit EEPROM receives 8-bit memory address words. Upon receipt of this memory address, the EEPROM outputs acknowledgment "0" and receives a following 8-bit write data. After receipt of write data, the EEPROM outputs acknowledgment "0". If the EEPROM receives a stop condition, the EEPROM enters an internally-timed write cycle and terminates receipt of SCL, SDA inputs until completion of the write cycle. The EEPROM returns to a standby mode after completion of the write cycle.

Byte Write Operation

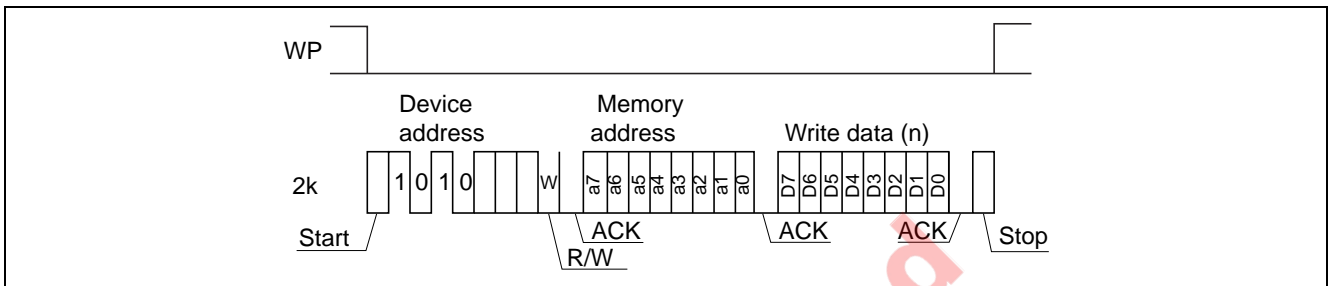

Page Write:

The EEPROM is capable of the page write operation which allows any number of bytes up to 8 bytes to be written in a single write cycle. The page write is the same sequence as the byte write except for inputting the more write data. The page write is initiated by a start condition, device address word, memory address(n) and write data (Dn) with every ninth bit acknowledgment. The EEPROM enters the page write operation if the EEPROM receives more write data (Dn+1) instead of receiving a stop condition. The a0 to a2 address bits are automatically incremented upon receiving write data (Dn+1). The EEPROM can continue to receive write data up to 8 bytes. If the a0 to a2 address bits reaches the last address of the page, the a0 to a2 address bits will roll over to the first address of the same page and previous write data will be overwritten. Upon receiving a stop condition, the EEPROM stops receiving write data and enters internally-timed write cycle.

Page Write Operation

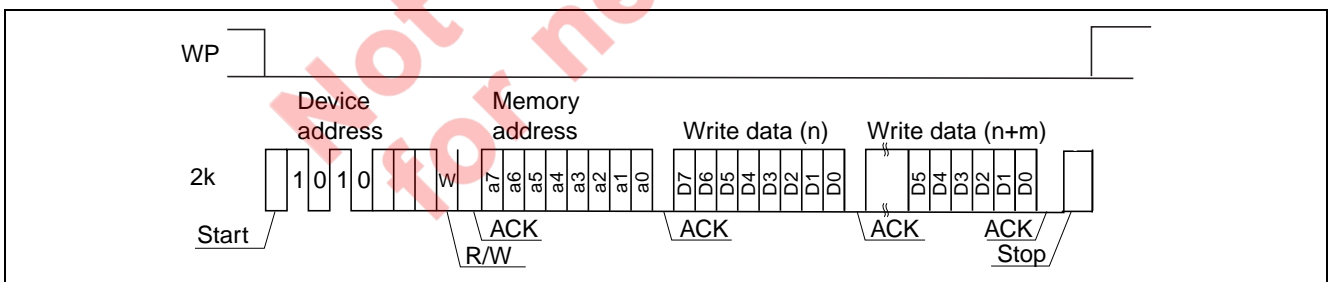

Write Operations (WP=High)

Byte Write: (Write operation during WP=High status)

A write operation requires an 8-bit device address word with R/W = "0". Then the EEPROM sends acknowledgment "0" at the ninth clock cycle. After these, the 2k bit EEPROM receives 8-bit memory address. Upon receipt of this memory address, the EEPROM outputs acknowledgment "0". After receipt of 8-bit write data, the EEPROM outputs acknowledgment "1"(NO ACK). Then the EEPROM write operations are not allowed.

Byte Write Operation

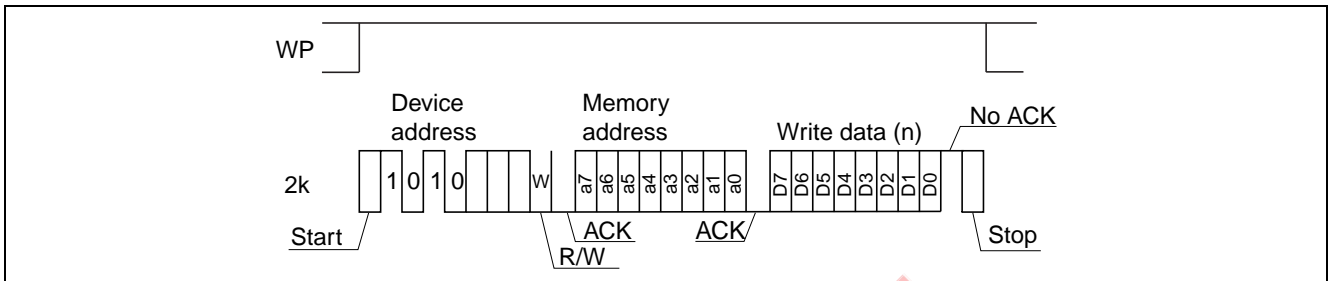

Page Write:

The page write is the same sequence as the byte write. The page write is initiated by a start condition, device address word and memory address(n) with every ninth bit acknowledgment"0". But after inputting write data(Dn) , the EEPROM outputs acknowledgment "1"(NO ACK). Then the EEPROM write operations are not allowed.

Page Write Operation

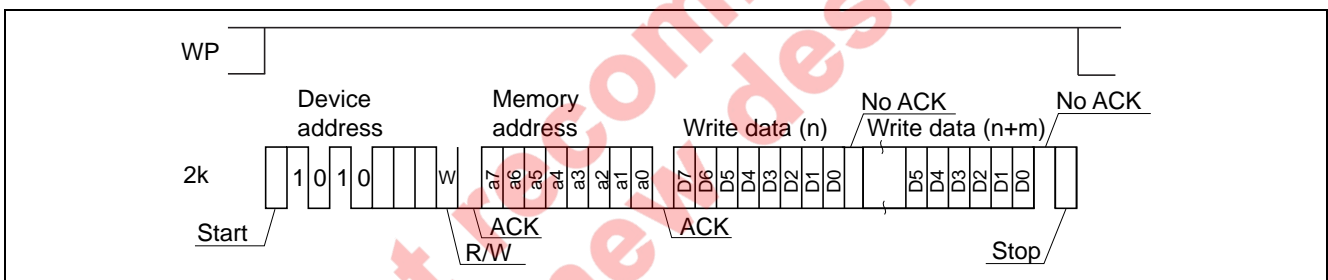

Acknowledge Polling:

Acknowledge polling feature is used to show if the EEPROM is in a internally-timed write cycle or not. This feature is initiated by the stop condition after inputting write data. This requires the 8-bit device address word following the start condition during a internally-timed write cycle. Acknowledge polling will operate when the R/W code = "0". Acknowledgment "1" (no acknowledgment) shows the EEPROM is in a internally-timed write cycle and acknowledgment "0" shows that the internally-timed write cycle has completed. See Write Cycle Polling using ACK.

Write Cycle Polling Using ACK

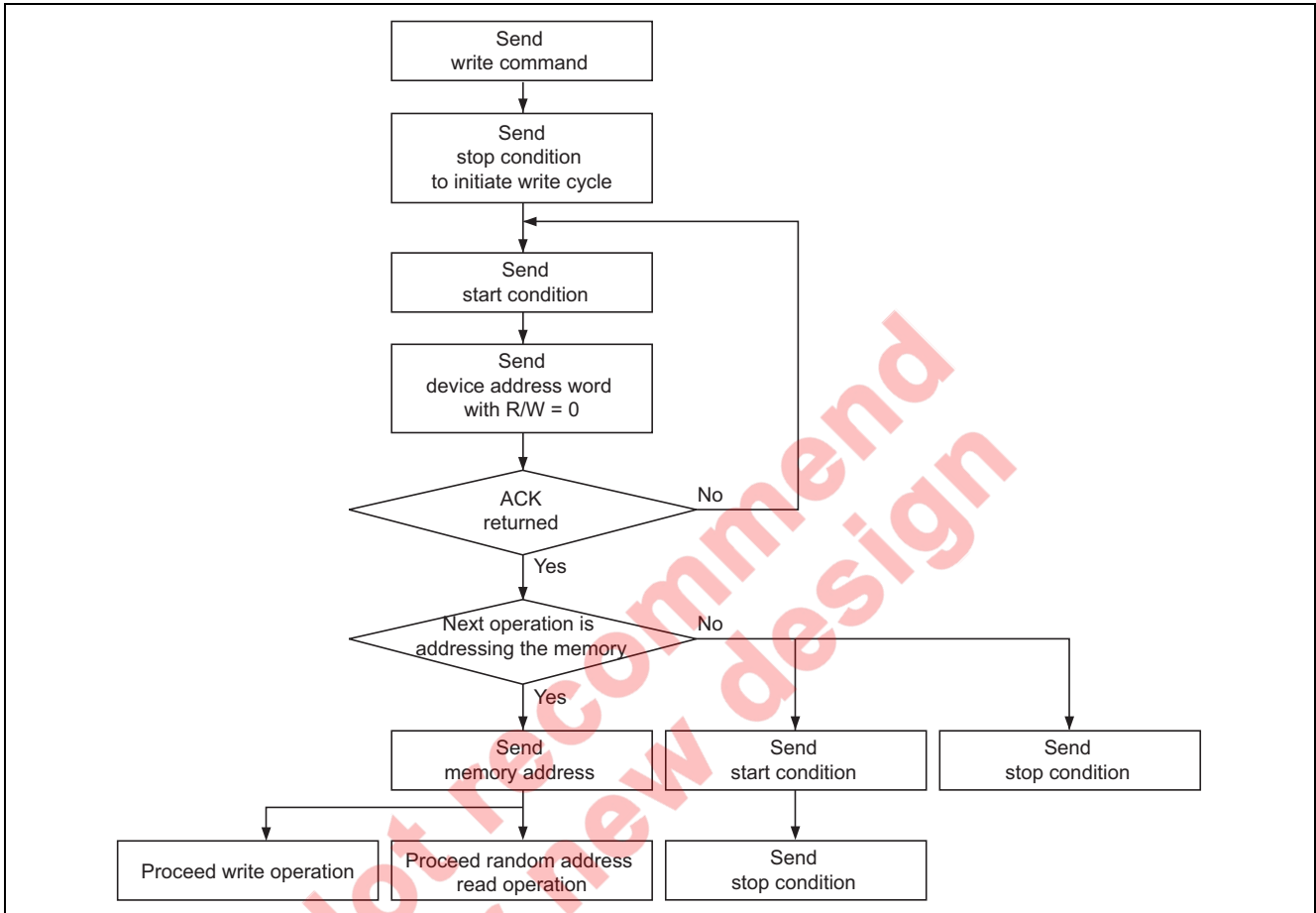

Read Operation

There are three read operations: current address read, random read, and sequential read. Read operations are initiated the same way as write operations with the exception of R/W = "1".

Current Address Read:

The internal address counter maintains the last address accessed during the last read or write operation, with incremented by one. Current address read accesses the address kept by the internal address counter. After receiving a start condition and the device address word (R/W is "1"), the EEPROM outputs the 8-bit current address data from the most significant bit following acknowledgment "0". If the EEPROM receives acknowledgment "1" (no acknowledgment) and a following stop condition, the EEPROM stops the read operation and is turned to a standby state. In case the EEPROM has accessed the last address of the last page at previous read operation, the current address will roll over and returns to zero address. In case the EEPROM has accessed the last address of the page at previous write operation, the current address will roll over within page addressing and returns to the first address in the same page. The current address is valid while power is on. The current address after power on will be indefinite. The random read operation described below is necessary to define the memory address.

Current Address Read Operation

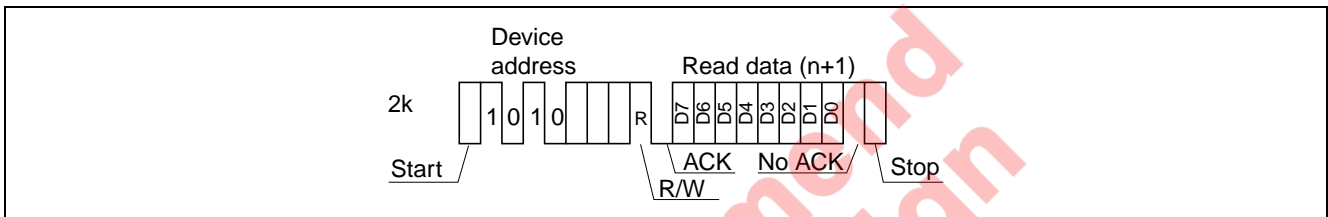

Random Read:

This is a read operation with defined read address. A random read requires a dummy write to set read address. The EEPROM receives a start condition, device address word (R/W=0) and memory address 8-bit sequentially. The EEPROM outputs acknowledgment “0” after receiving memory address then enters a current address read with receiving a start condition. The EEPROM outputs the read data of the address which was defined in the dummy write operation. After receiving acknowledgment “1”(no acknowledgment) and a following stop condition, the EEPROM stops the random read operation and returns to a standby state.

Random Read Operation

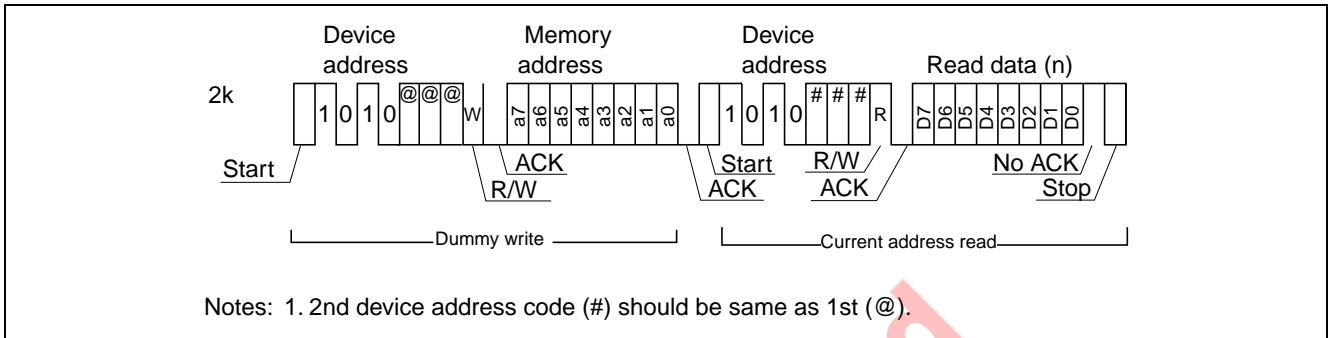

Sequential Read:

Sequential reads are initiated by either a current address read or a random read. If the EEPROM receives acknowledgment “0” after 8-bit read data, the read address is incremented and the next 8-bit read data are coming out. This operation can be continued as long as the EEPROM receives acknowledgment “0”. The address will roll over and returns address zero if it reaches the last address of the last page. The sequential read can be continued after roll over. The sequential read is terminated if the EEPROM receives acknowledgment “1” (no acknowledgment) and a following stop condition.

Sequential Read Operation

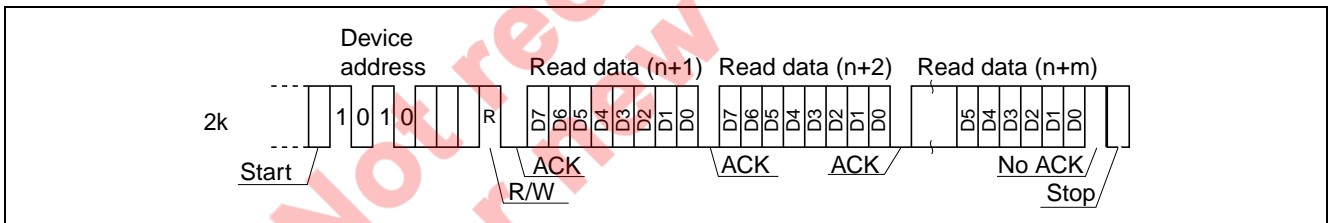

Notes

Data Protection at V_{CC} On/Off

When V_{CC} is turned on or off, noise on the SCL and SDA inputs generated by external circuits (CPU, etc) may act as a trigger and turn the EEPROM to unintentional program mode. To prevent this unintentional programming, this EEPROM has a power on reset function. Be careful of the notices described below in order for the power on reset function to operate correctly.

- SCL and SDA should be fixed to V_{CC} or V_{SS} during V_{CC} on/off. Low to high or high to low transition during V_{CC} on/off may cause the trigger for the unintentional programming.
- V_{CC} should be turned off after the EEPROM is placed in a standby state.
- V_{CC} should be turned on from the ground level(V_{SS}) in order for the EEPROM not to enter the unintentional programming mode.
- V_{CC} turn on rate should be slower than 2 μs/V.

Noise Suppression Time

This EEPROM have a noise suppression function at SCL and SDA inputs, that cut noise of width less than 50 ns. Be careful not to allow noise of width more than 50 ns.

Power Source Noise Countermeasures

In order to suppress power-source-noise which causes malfunction of the device, it is recommended to put 0.1μF bypass-capacitor (such as a monolithic ceramic capacitor which has good high-frequency characteristics) between V_{CC} and V_{SS}, and shorten the wiring length between the capacitor and V_{CC}/V_{SS} terminals as much as possible.

Not recommended
for new design

Package Dimensions

R1EV24002ASAS0A (PRSP0008DF-B / Previous Code: FP-8DBV)

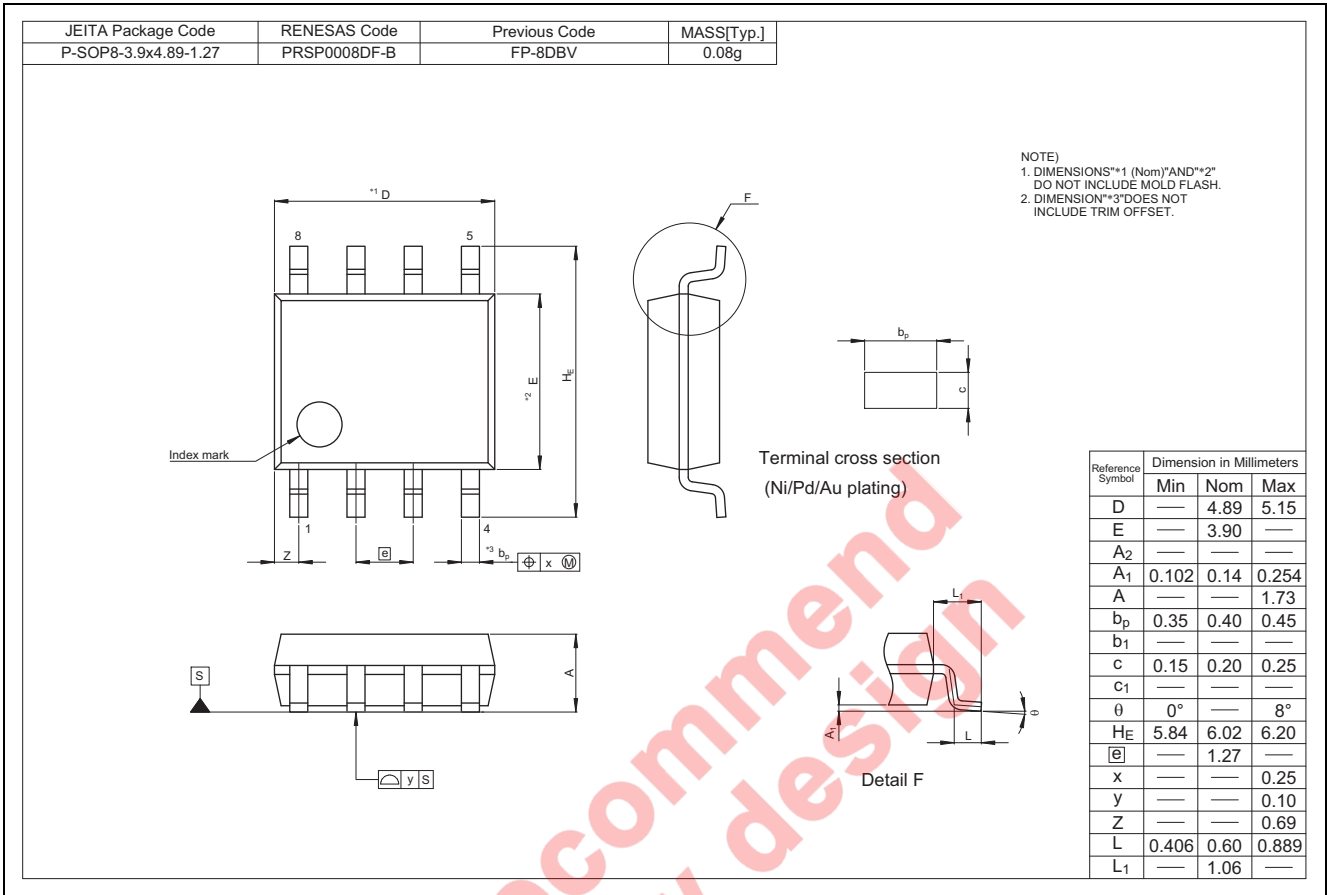

Not recommended for new design

Revision History	R1EV24002ASAS0A Data Sheet
-------------------------	-----------------------------------

Rev.	Date	Description	
		Page	Summary
0.01	Oct. 11, 2011		Initial issue
0.02	Jan. 13, 2012	15	Corrected typo. 2 $\mu\text{s/s}$ \rightarrow 2 $\mu\text{s/V}$
1.00	Apr. 25, 2012	All	Delete Preliminary

Not recommend
for new design

Notice

- All information included in this document is current as of the date this document is issued. Such information, however, is subject to change without any prior notice. Before purchasing or using any Renesas Electronics products listed herein, please confirm the latest product information with a Renesas Electronics sales office. Also, please pay regular and careful attention to additional and different information to be disclosed by Renesas Electronics such as that disclosed through our website.
- Renesas Electronics does not assume any liability for infringement of patents, copyrights, or other intellectual property rights of third parties by or arising from the use of Renesas Electronics products or technical information described in this document. No license, express, implied or otherwise, is granted hereby under any patents, copyrights or other intellectual property rights of Renesas Electronics or others.
- You should not alter, modify, copy, or otherwise misappropriate any Renesas Electronics product, whether in whole or in part.
- Descriptions of circuits, software and other related information in this document are provided only to illustrate the operation of semiconductor products and application examples. You are fully responsible for the incorporation of these circuits, software, and information in the design of your equipment. Renesas Electronics assumes no responsibility for any losses incurred by you or third parties arising from the use of these circuits, software, or information.
- When exporting the products or technology described in this document, you should comply with the applicable export control laws and regulations and follow the procedures required by such laws and regulations. You should not use Renesas Electronics products or the technology described in this document for any purpose relating to military applications or use by the military, including but not limited to the development of weapons of mass destruction. Renesas Electronics products and technology may not be used for or incorporated into any products or systems whose manufacture, use, or sale is prohibited under any applicable domestic or foreign laws or regulations.
- Renesas Electronics has used reasonable care in preparing the information included in this document, but Renesas Electronics does not warrant that such information is error free. Renesas Electronics assumes no liability whatsoever for any damages incurred by you resulting from errors in or omissions from the information included herein.
- Renesas Electronics products are classified according to the following three quality grades: "Standard", "High Quality", and "Specific". The recommended applications for each Renesas Electronics product depends on the product's quality grade, as indicated below. You must check the quality grade of each Renesas Electronics product before using it in a particular application. You may not use any Renesas Electronics product for any application categorized as "Specific" without the prior written consent of Renesas Electronics. Further, you may not use any Renesas Electronics product for any application for which it is not intended without the prior written consent of Renesas Electronics. Renesas Electronics shall not be in any way liable for any damages or losses incurred by you or third parties arising from the use of any Renesas Electronics product for an application categorized as "Specific" or for which the product is not intended where you have failed to obtain the prior written consent of Renesas Electronics. The quality grade of each Renesas Electronics product is "Standard" unless otherwise expressly specified in a Renesas Electronics data sheets or data books, etc.
"Standard": Computers; office equipment; communications equipment; test and measurement equipment; audio and visual equipment; home electronic appliances; machine tools; personal electronic equipment; and industrial robots.
"High Quality": Transportation equipment (automobiles, trains, ships, etc.); traffic control systems; anti-disaster systems; anti-crime systems; safety equipment; and medical equipment not specifically designed for life support.
"Specific": Aircraft; aerospace equipment; submersible repeaters; nuclear reactor control systems; medical equipment or systems for life support (e.g. artificial life support devices or systems), surgical implantations, or healthcare intervention (e.g. excision, etc.), and any other applications or purposes that pose a direct threat to human life.
- You should use the Renesas Electronics products described in this document within the range specified by Renesas Electronics, especially with respect to the maximum rating, operating supply voltage range, movement power voltage range, heat radiation characteristics, installation and other product characteristics. Renesas Electronics shall have no liability for malfunctions or damages arising out of the use of Renesas Electronics products beyond such specified ranges.
- Although Renesas Electronics endeavors to improve the quality and reliability of its products, semiconductor products have specific characteristics such as the occurrence of failure at a certain rate and malfunctions under certain use conditions. Further, Renesas Electronics products are not subject to radiation resistance design. Please be sure to implement safety measures to guard them against the possibility of physical injury, and injury or damage caused by fire in the event of the failure of a Renesas Electronics product, such as safety design for hardware and software including but not limited to redundancy, fire control and malfunction prevention, appropriate treatment for aging degradation or any other appropriate measures. Because the evaluation of microcomputer software alone is very difficult, please evaluate the safety of the final products or system manufactured by you.
- Please contact a Renesas Electronics sales office for details as to environmental matters such as the environmental compatibility of each Renesas Electronics product. Please use Renesas Electronics products in compliance with all applicable laws and regulations that regulate the inclusion or use of controlled substances, including without limitation, the EU RoHS Directive. Renesas Electronics assumes no liability for damages or losses occurring as a result of your noncompliance with applicable laws and regulations.
- This document may not be reproduced or duplicated, in any form, in whole or in part, without prior written consent of Renesas Electronics.
- Please contact a Renesas Electronics sales office if you have any questions regarding the information contained in this document or Renesas Electronics products, or if you have any other inquiries.
(Note 1) "Renesas Electronics" as used in this document means Renesas Electronics Corporation and also includes its majority-owned subsidiaries.
(Note 2) "Renesas Electronics product(s)" means any product developed or manufactured by or for Renesas Electronics.



SALES OFFICES

Renesas Electronics Corporation

<http://www.renesas.com>

Refer to "<http://www.renesas.com/>" for the latest and detailed information.

Renesas Electronics America Inc.
2880 Scott Boulevard Santa Clara, CA 95050-2554, U.S.A.
Tel: +1-408-588-6000, Fax: +1-408-588-6130

Renesas Electronics Canada Limited
1101 Nicholson Road, Newmarket, Ontario L3Y 9C3, Canada
Tel: +1-905-898-5441, Fax: +1-905-898-3220

Renesas Electronics Europe Limited
Dukes Meadow, Millboard Road, Bourne End, Buckinghamshire, SL8 5FH, U.K.
Tel: +44-1628-585-100, Fax: +44-1628-585-900

Renesas Electronics Europe GmbH
Arcadiastrasse 10, 40472 Düsseldorf, Germany
Tel: +49-211-65030, Fax: +49-211-6503-1327

Renesas Electronics (China) Co., Ltd.
7th Floor, Quantum Plaza, No.27 ZhiChunLu Haidian District, Beijing 100083, P.R.China
Tel: +86-10-8235-1155, Fax: +86-10-8235-7679

Renesas Electronics (Shanghai) Co., Ltd.
Unit 204, 205, AZIA Center, No.1233 Lujiazui Ring Rd., Pudong District, Shanghai 200120, China
Tel: +86-21-5877-1818, Fax: +86-21-6887-7858 / -7898

Renesas Electronics Hong Kong Limited
Unit 1601-1613, 16/F., Tower 2, Grand Century Place, 193 Prince Edward Road West, Mongkok, Kowloon, Hong Kong
Tel: +852-2886-9318, Fax: +852 2886-9022/9044

Renesas Electronics Taiwan Co., Ltd.
13F, No. 363, Fu Shing North Road, Taipei, Taiwan
Tel: +886-2-8175-9600, Fax: +886 2-8175-9670

Renesas Electronics Singapore Pte. Ltd.
1 HarbourFront Avenue, #06-10, Keppel Bay Tower, Singapore 098632
Tel: +65-6213-0200, Fax: +65-6278-8001

Renesas Electronics Malaysia Sdn.Bhd.
Unit 906, Block B, Menara Amcorp, Amcorp Trade Centre, No. 18, Jln Persiaran Barat, 46050 Petaling Jaya, Selangor Darul Ehsan, Malaysia
Tel: +60-3-7955-9390, Fax: +60-3-7955-9510

Renesas Electronics Korea Co., Ltd.
11F., Samik Lavied' or Bldg., 720-2 Yeoksam-Dong, Kangnam-Ku, Seoul 135-080, Korea
Tel: +82-2-558-3737, Fax: +82-2-558-5141