

R2J25953SP

H-Bridge Control High Speed Power Switching with Built-in Driver IC and Power MOS FET

R07DS0044EJ0400

Rev.4.00

May 09, 2013

Description

The R2J25953 multi-chip module incorporates high-side Pch MOS FET, low-side Nch MOS FET, and Bi-CMOS driver in a single HSOP-36 package.

Features

- For Automotive application
- Built-in low on state resistance MOS FET.
(Pch: 16 mΩ Max., Nch: 11 mΩ Max.)
- Pch MOS FET is adopted on the high-side, and the charge pump noise was lost.
- Built-in protection circuit of Thermal shut-down (TSD), Low Voltage Inhibit (LVI), Overvoltage Detection (OVD) and Overcurrent Detection.
- Built-in diagnostic function.
- Built-in cross-conduction protection.
- Small Surface mounting package: HSOP-36

Block Diagram

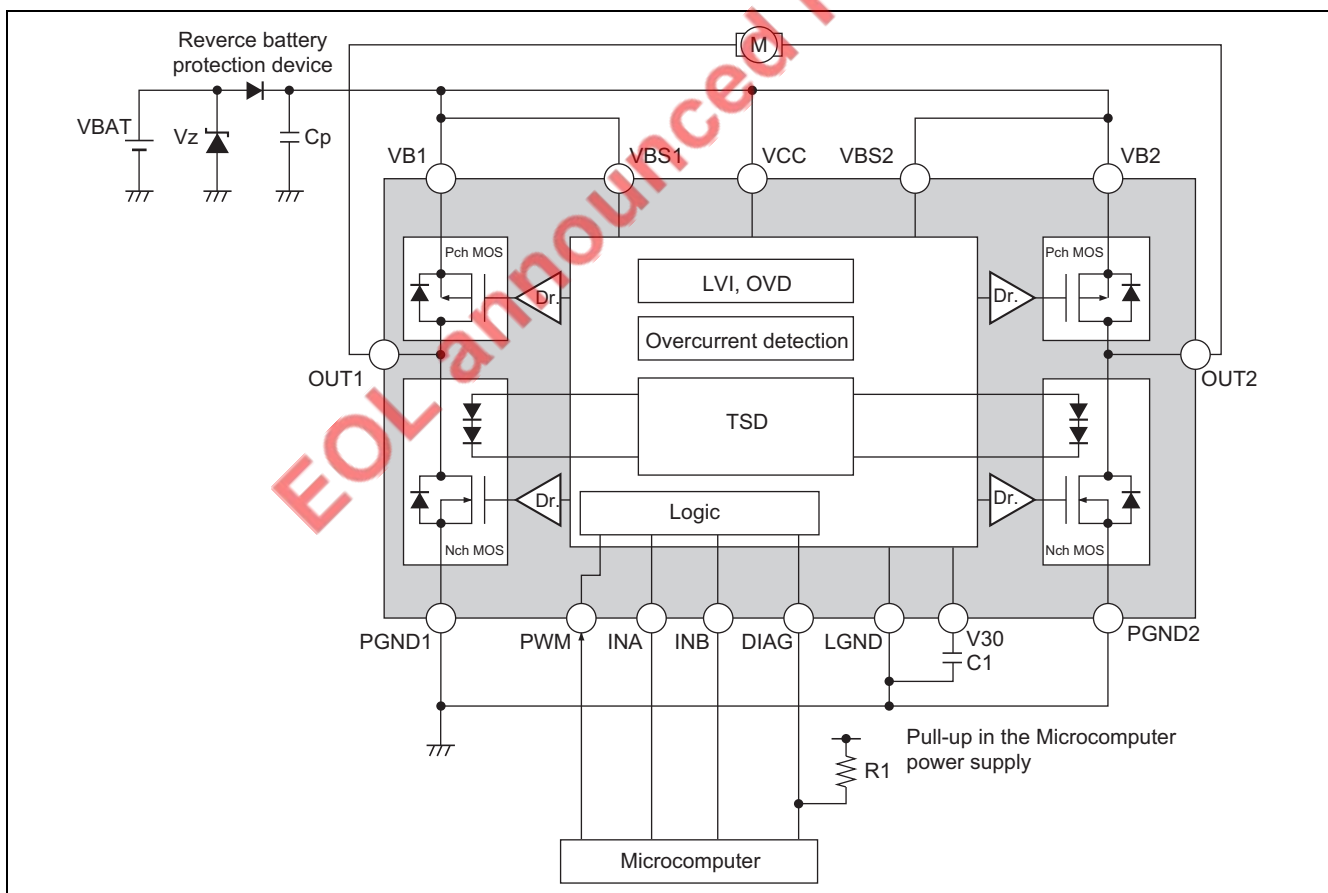

Outline

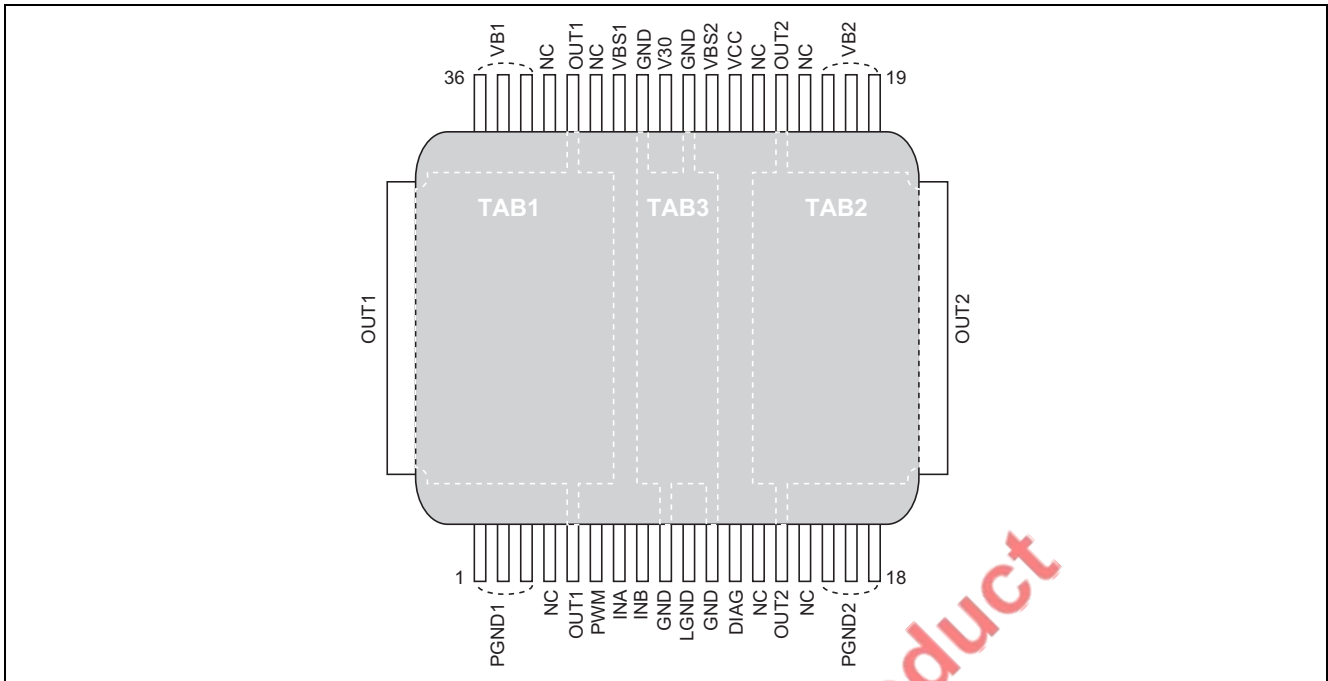

Pin Description

Pin No.	Pin name	Description	Pin No.	Pin name	Description
1 to 3	PGND1	Power GND1	22	NC	No connect
4	NC	No connect	23	OUT2	Internally corrected to TAB2
5	OUT1	Internally corrected to TAB1	24	NC	No connect
6	PWM	PWM input	25	VCC	IC power supply
7	INA	A input	26	VBS2	VB2 sense
8	INB	B input	27	GND	Internally corrected to TAB3
9	GND	Internally corrected to TAB3	28	V30	IC bias voltage (3.3 V)
10	LGND	IC GND	29	GND	Internally corrected to TAB3
11	GND	Internally corrected to TAB3	30	VBS1	VB1 sense
12	DIAG	Diagnostic output (open drain)	31	NC	No connect
13	NC	No connect	32	OUT1	Internally corrected to TAB1
14	OUT2	Internally corrected to TAB2	33	NC	No connect
15	NC	No connect	34 to 36	VB1	MOS FET power supply 1
16 to 18	PGND2	Power GND2	TAB1	OUT1	MOS FET output 1
19 to 21	VB2	MOS FET power supply 2	TAB2	OUT2	MOS FET output 2
			TAB3	GND	IC tab GND

Absolute Maximum Ratings

(Ta = 25°C)

Item	Symbol	Ratings	Unit	Note
Supply voltage	VB	18	V	1
Input voltage	Vin	-0.3 to VB	V	2
Diag voltage	Vdiag	-0.3 to VB	V	3
Output current	Iout	50	A	
Diag current	Idiag	5	mA	3
Junction temperature	Tj	-40 to +150	°C	
Storage temperature	Tstg	-55 to +150	°C	
Power temperature	Pt	40	W	4

Notes: 1. 28 V at 25°C, 1 min.
40 V at 25°C, 1 sec.

2. Applies to INA, INB, and PWM. Clamps it with 19 V typ.
3. Applies to DIAG
4. One element operation: Tc = 25°C

EOL announced Product

Electrical Characteristics

(Ta = 25°C, VB = VCC = 12 V)

Item		Symbol	Min	Typ	Max	Unit	Condition	Application terminal	Note
Supply current		Icc0	—	30	50	μA	Standby	VCC	1
		Icc	—	3.5	10	mA	ACTIVE		1
VB	Input current	IinVB	—	—	±1	μA	Standby	VB1/VB2	1
MOS	Static High-side resistance	RonH	—	9	16	mΩ	Iout = 15 A Pulse test		
	Static Low-side resistance	RonL	—	7	11	mΩ	Iout = 15 A Pulse test		
	Off state current	Ioff	—	10	20	μA			
IN	Input current	IinL	—	—	±10	μA	Vin = 0 V	INA/INB /PWM	
		IinH	—	—	±10	μA	Vin = VB		
	High threshold	Vthin	3.0	—	—	V			
	Low threshold	Vtlin	—	—	1.5	V			
Delay time		tpLH	—	1.5	4.0	μs	OUT/IN (PWM)	OUT, PWM	2
		tpHL	—	3.0	6.0	μs			
Rise time		tr	—	1.0	3.0	μs	OUT	OUT1/2	
Fall time		tf	—	1.0	3.0	μs			
DIAG	Output voltage	VDiag	—	0.4	0.6	V	I = 2 mA, DIAG = Low Vdiag = 0 V	DIAG	
	Leak current	IDiag	—	—	±10	μA			
TSD	Shut-down temperature	Tsd	150	175	—	°C			3
	Hysteresis	Thys	7	25	—	°C			
OVD	Shut-down voltage	VtvH	28.9	34	39.1	V		VCC	
	Return voltage	VtvL	21.3	25	28.7	V			
LVI	Return voltage	VRLVI	5.0	5.35	5.6	V		VCC	
	Hysteresis	VHLVI	0.3	0.5	0.7	V			
Overcurrent detection	Shut-down current	IcL	35	—	—	A		OUT1/2	
	Detection time	tcL	60	10	20	μs			
MOS FET Body-diode	Pch forward voltage	VDFp	—	1.0	1.3	V	IF = 50 A, Pulse test		
	Nch forward voltage	VDFn	—	1.0	1.3	V			

Notes: 1. Refer to truth table.

2. Refer to the input condition to the truth table.

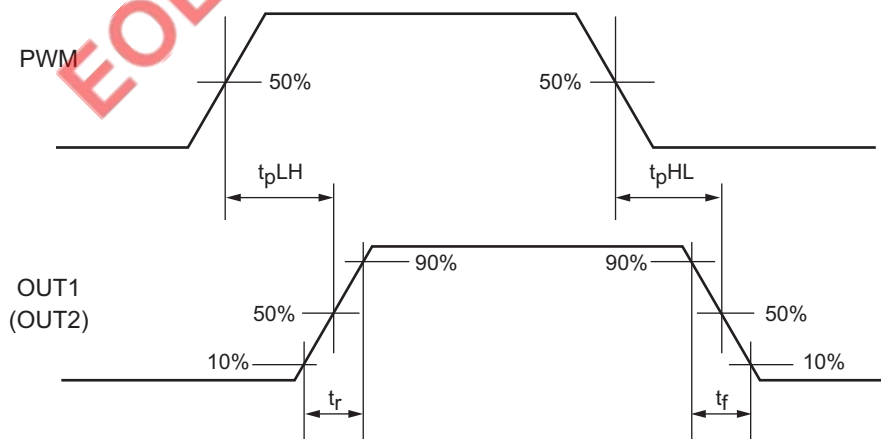

3. It is a design guaranteed value, and it doesn't apply to the final test.

Truth table

The operation of OUT1, OUT2, and DIAG is shown in the following.

Input			Status				Output			State
PWM	INA	INB	LVI	TSD	Overcurrent detection	OVD	OUT1	OUT2	DIAG	
High	High	High	off				High	High	High	ACTIVE
		Low	off				High	Low	High	
	Low	High	off				Low	High	High	
		Low	off				Low	Low	High	
Low	High	High	off				Hi-z	Hi-z	High	STANDBY
		Low	off				Hi-z	Low	High	
	Low	High	off				Low	Hi-z	High	
		Low	Protection circuit doesn't operate				Low	Low	High	
Excluding All = Low At least one of PWM, INA, and INB is high.			on	x	x	x	Hi-z	Hi-z	High	LVI
			off	on	x	x	Hi-z	Hi-z	Low	TSD
			off	x	on	x	Hi-z (Latch)	Hi-z (Latch)	Low (Latch)	Overcurrent detection
			off	x	x	on	Hi-z	Hi-z	Low	OVD

Notes 1. x: Regardless of High, Low, on and off.

2. Protect circuit

off = undetection

on = detection

3. State of pin OUT

Low: Nch MOS FET ON, High: Pch MOS FET ON, Hi-z: Nch and Pch MOS FET OFF

4. The latch of overcurrent detection is released when LVI = on or INA = INB = Low.

External Parts List

Parts No.	Recommended value	Purpose
Cp	10 μ F	Power supply bypass capacitor
R1	> 10 k Ω	Pull up Pin DIAG
C1	0.033 μ F	Pin V30 bypass capacitor

Equivalent Circuit

Pin name	Pin No.	Equivalent circuit
PGND1 PGND2	1, 2, 3, 16, 17, 18	
OUT1 OUT2	5, 32, TAB1 14, 23, TAB2	
PWM INA INB	6 7 8	
DIAG	12	
VB1 VB2	34, 35, 36 19, 20, 21	

EOL announced Product

Pin name	Pin No.	Equivalent circuit
VCC LGND	25 10	
VBS1 VBS2	30 26	
V30	28	

EOL announced Product

Main Characteristics

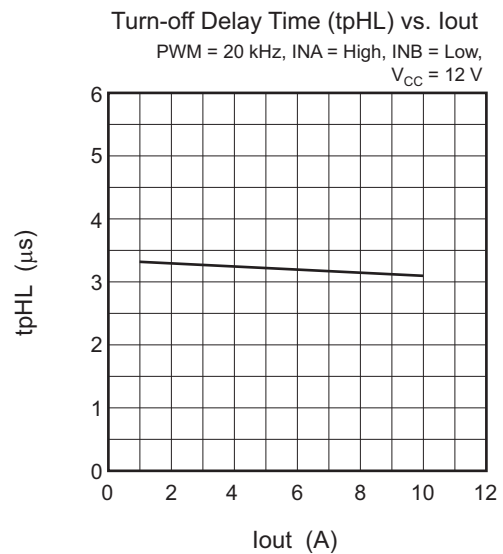
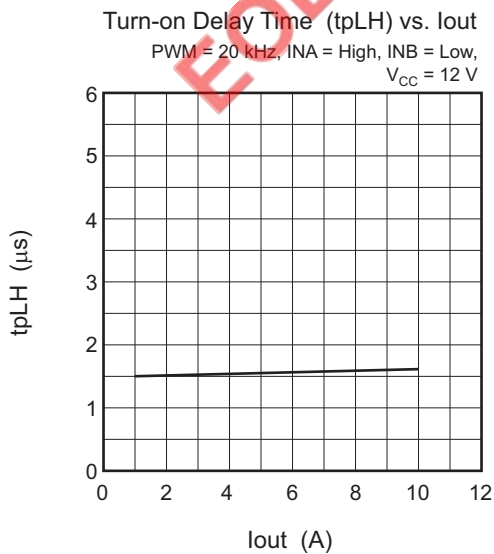
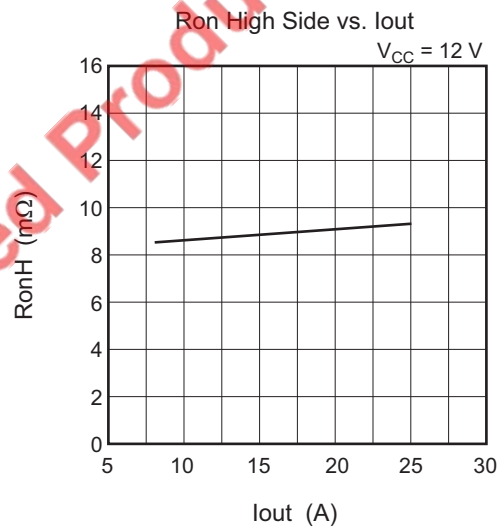
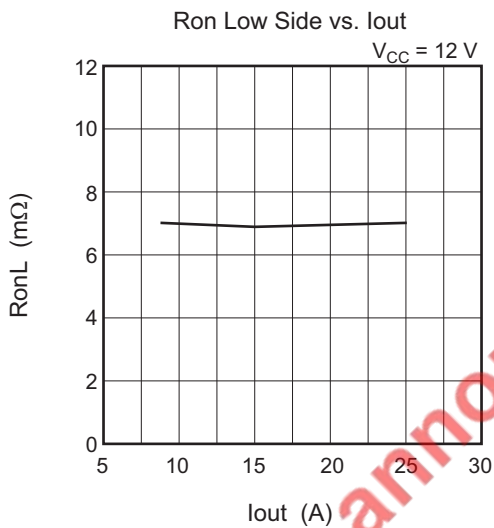
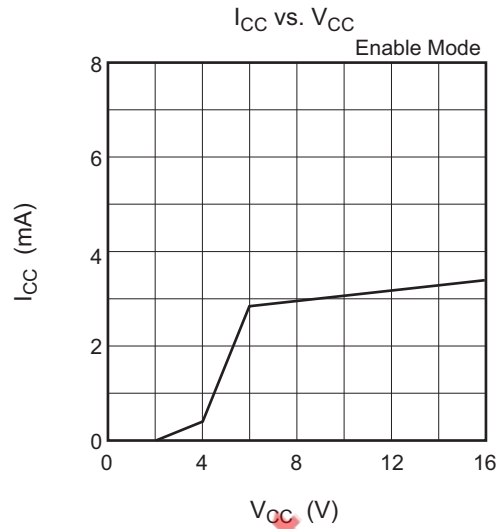
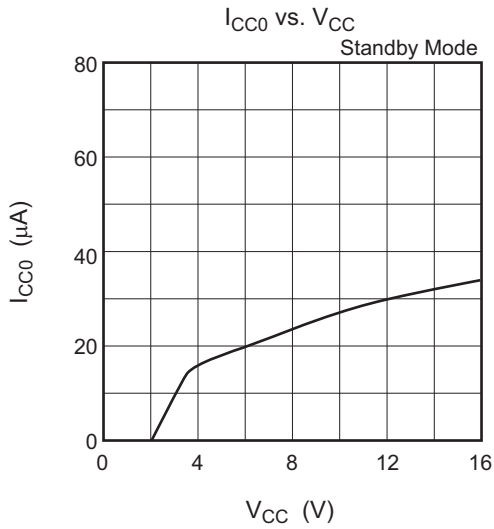

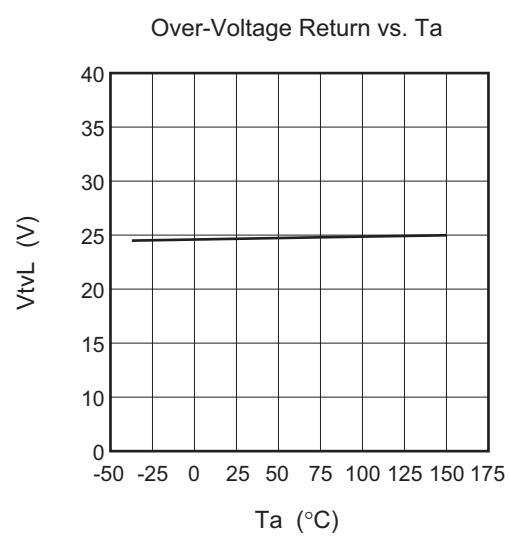
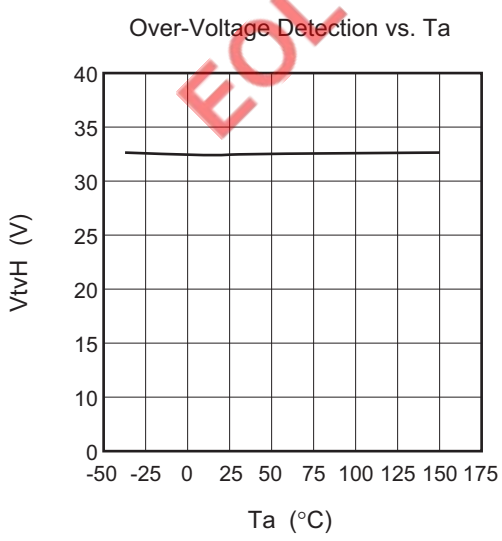
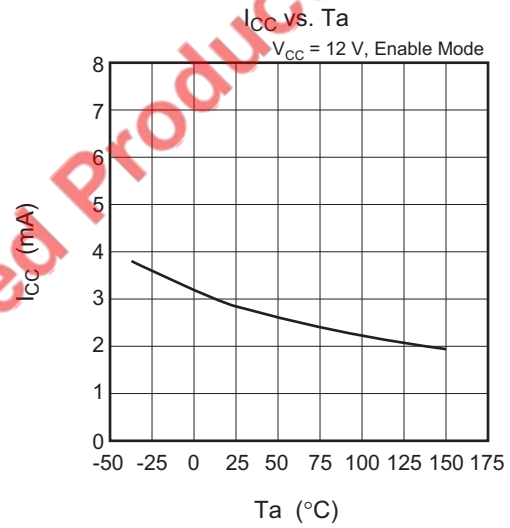
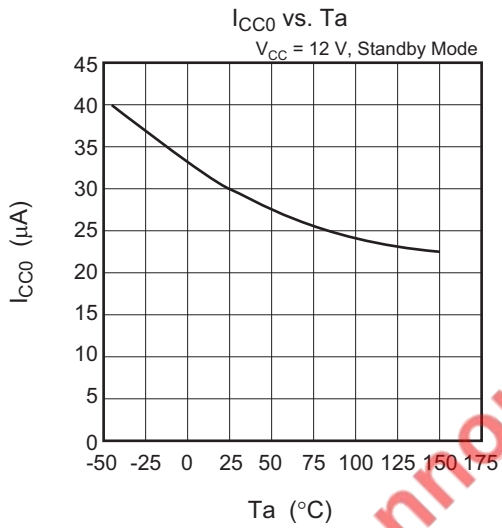
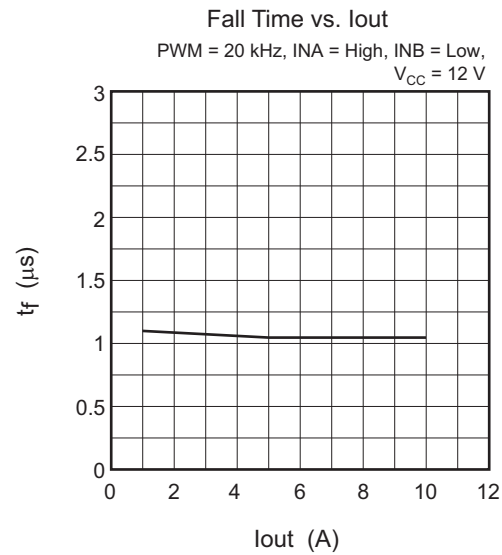
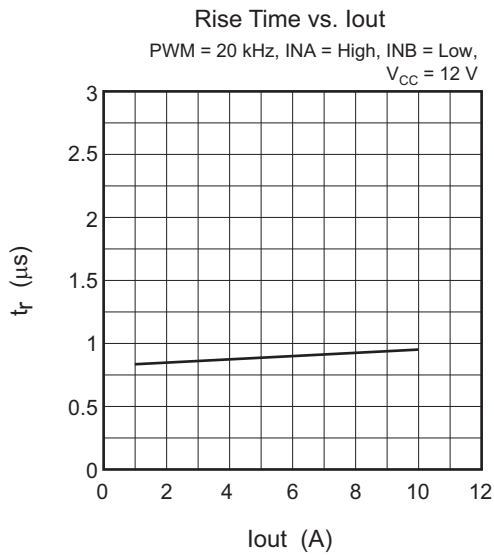

Low-Voltage Inhibit Return vs. Ta

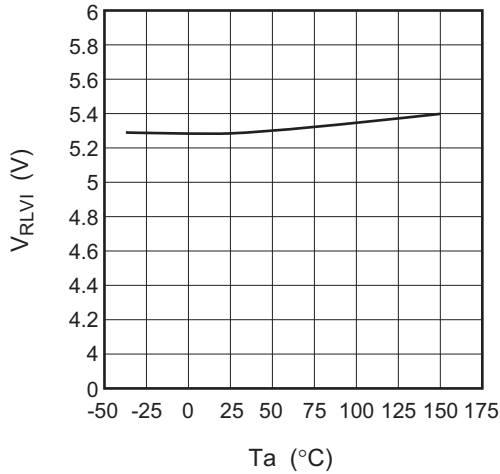

Low-Voltage Inhibit Hysteresis vs. Ta

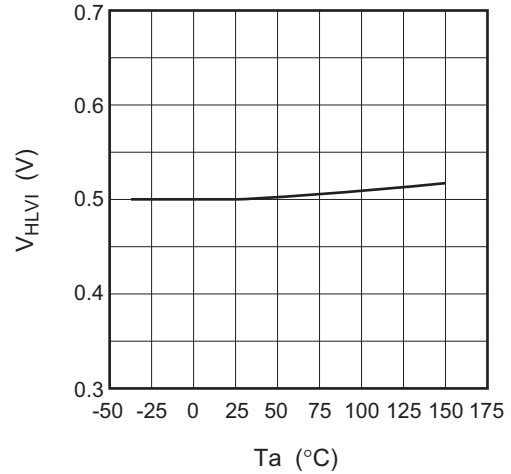

High Level Input Voltage vs. Ta
(PWM/INA/INB)

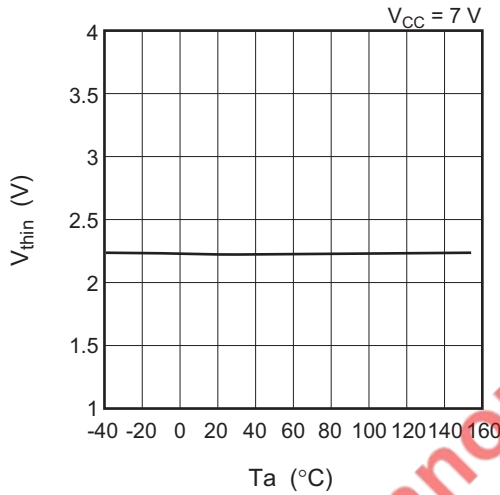

Low Level Input Voltage vs. Ta
(PWM/INA/INB)

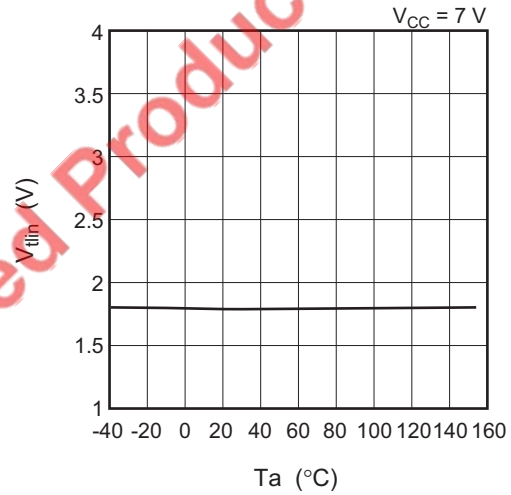

High Level Input Voltage vs. Ta
(PWM/INA/INB)

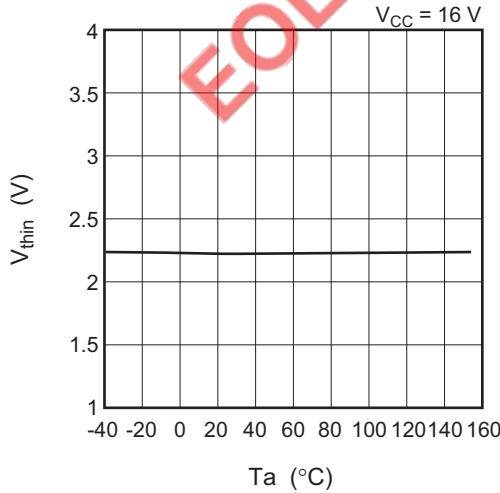

Low Level Input Voltage vs. Ta
(PWM/INA/INB)

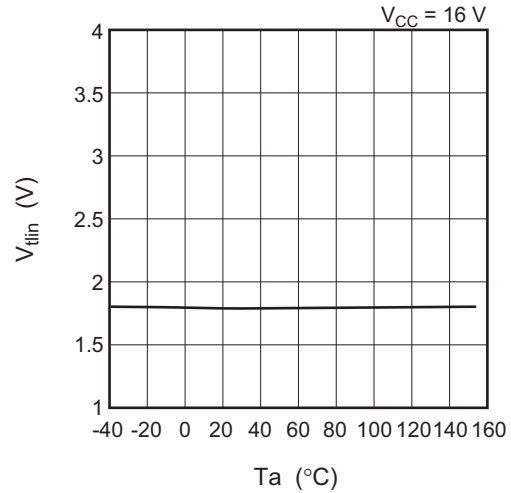

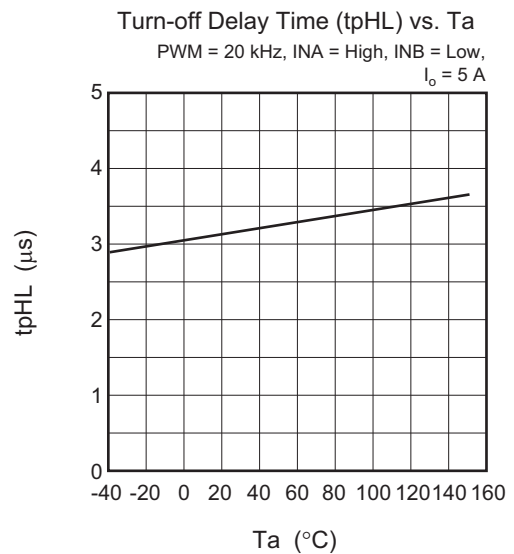
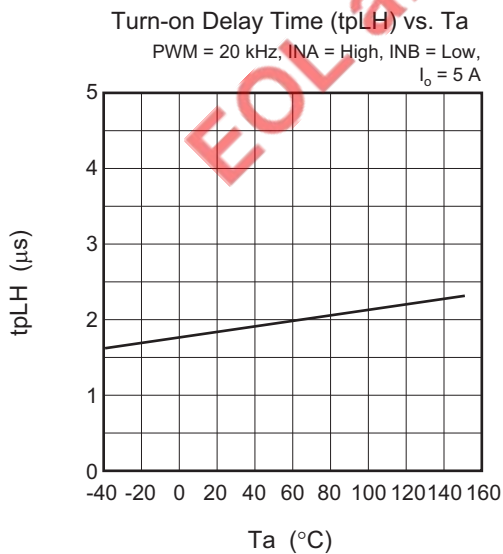
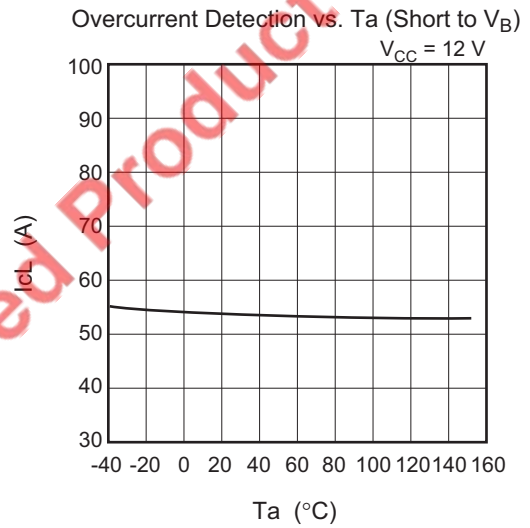
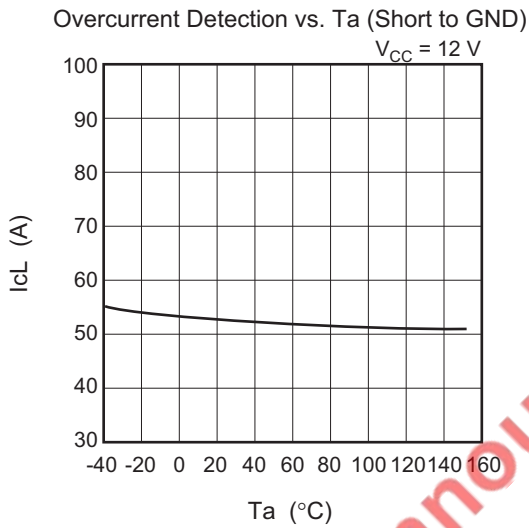
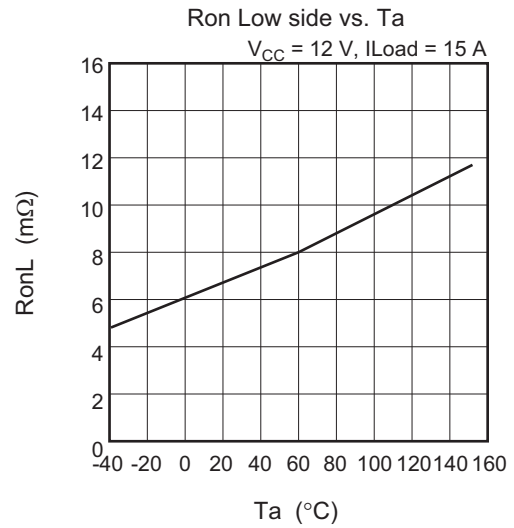
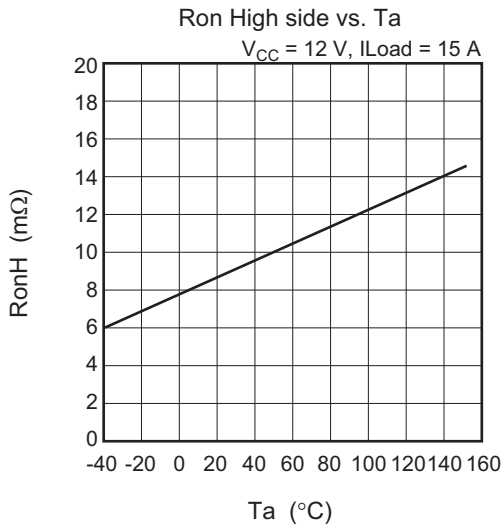

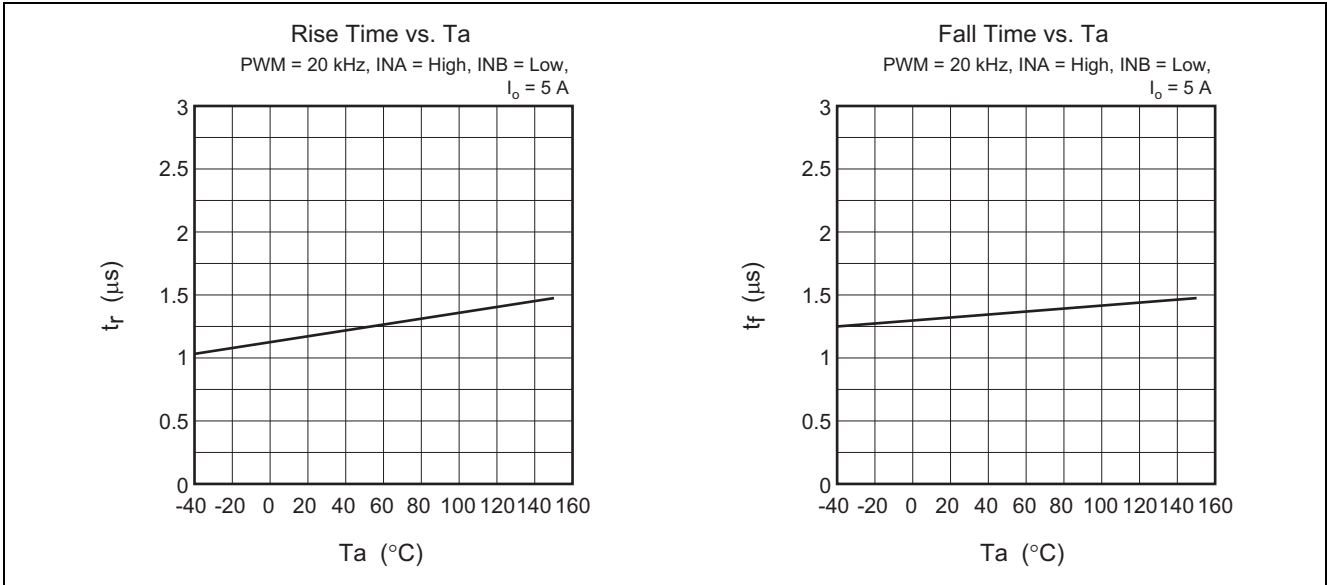

Recommended Wiring Pattern

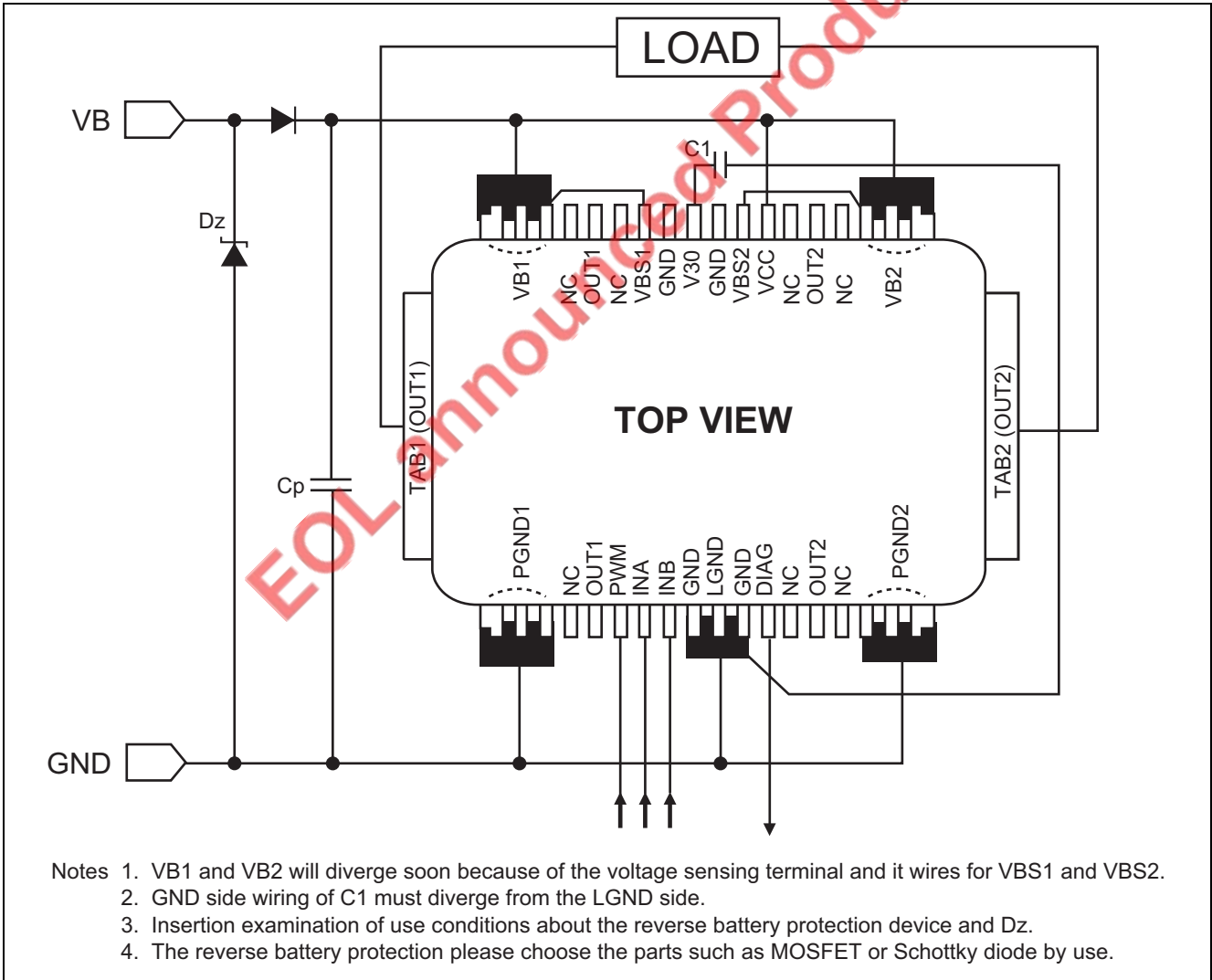

Operational Mode

When PWM is controlled, recovery control can be selected because of the low loss. However, please note that reverse-brake hangs at acceleration of the motor.

Operational mode	Circuit operational
<p>Example 1. Forward mode (Recovery control)</p> <p>INA = PWM on/off</p> <p>INB = Low</p> <p>PWM = High</p>	
<p>Example 2. Reverse mode (Recovery control)</p> <p>INA = Low</p> <p>INB = PWM on/off</p> <p>PWM = High</p>	
<p>Example 3. Forward mode (No recovery control)</p> <p>INA = High</p> <p>INB = Low</p> <p>PWM = PWM on/off</p>	
<p>Example 4. Reverse mode (No recovery control)</p> <p>INA = Low</p> <p>INB = High</p> <p>PWM = PWM on/off</p>	

Timing Chart (Normal operation)

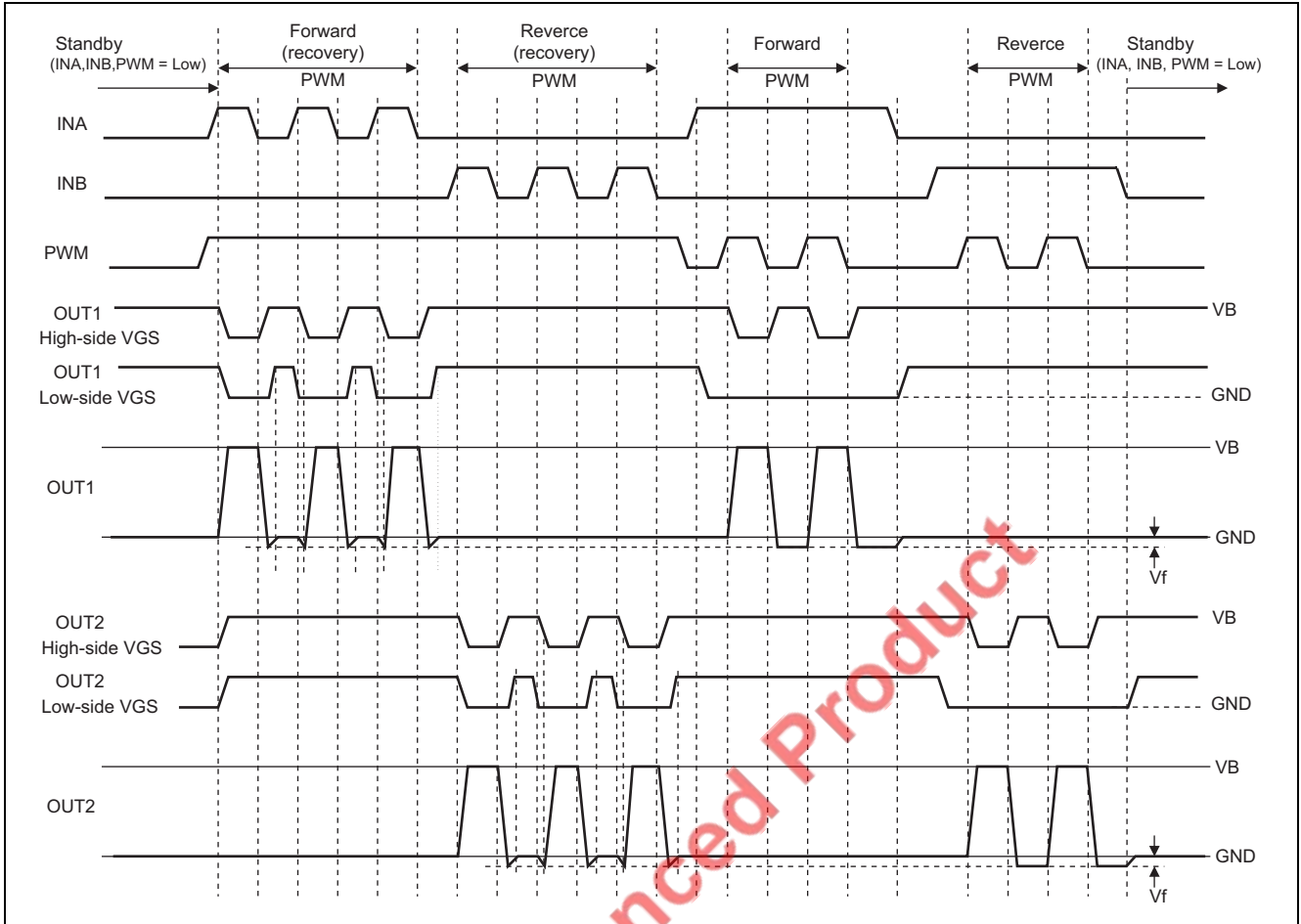

EOL announced Product

Timing Chart (Protection operation)

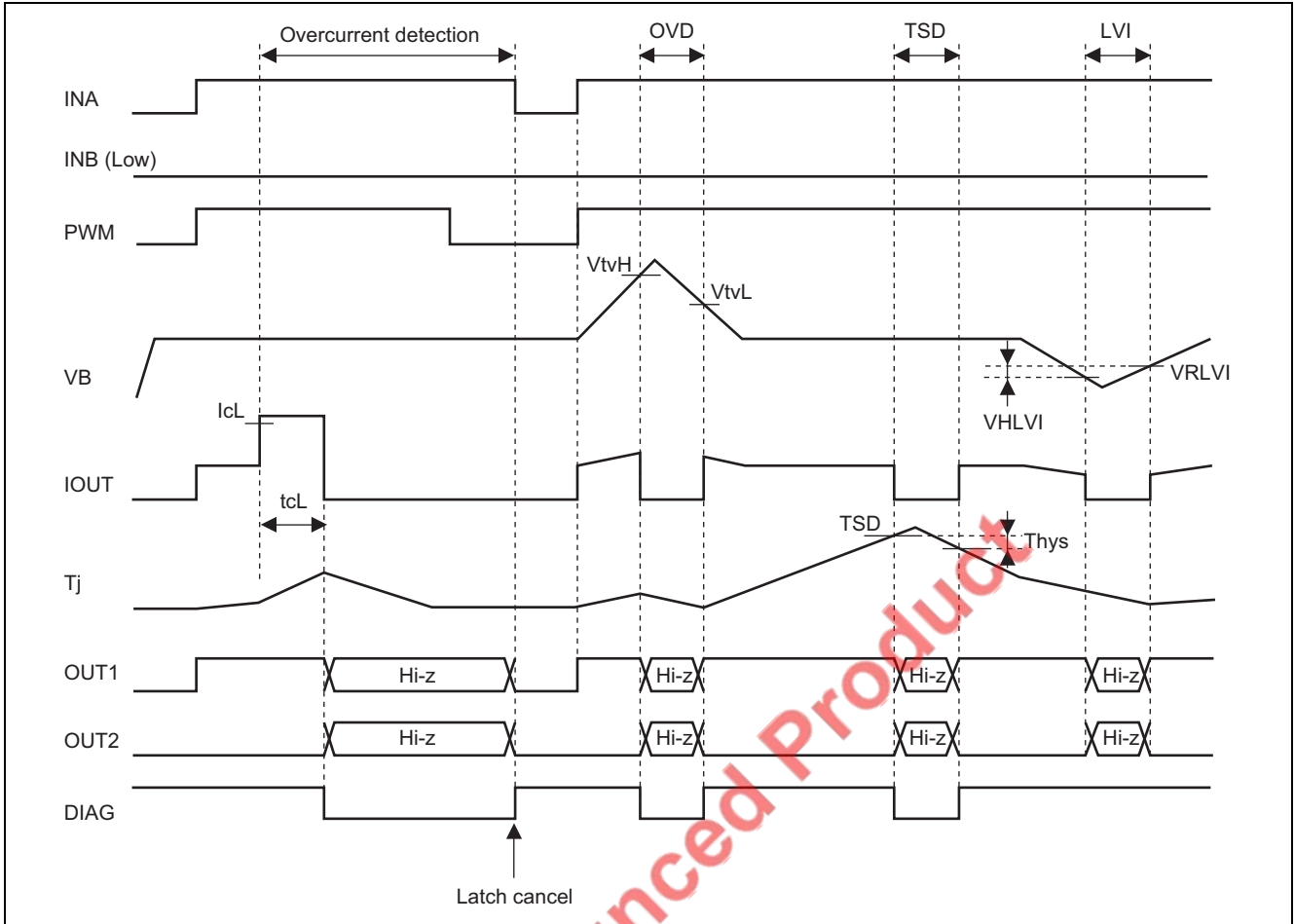

EOL announced Product

Package Dimensions

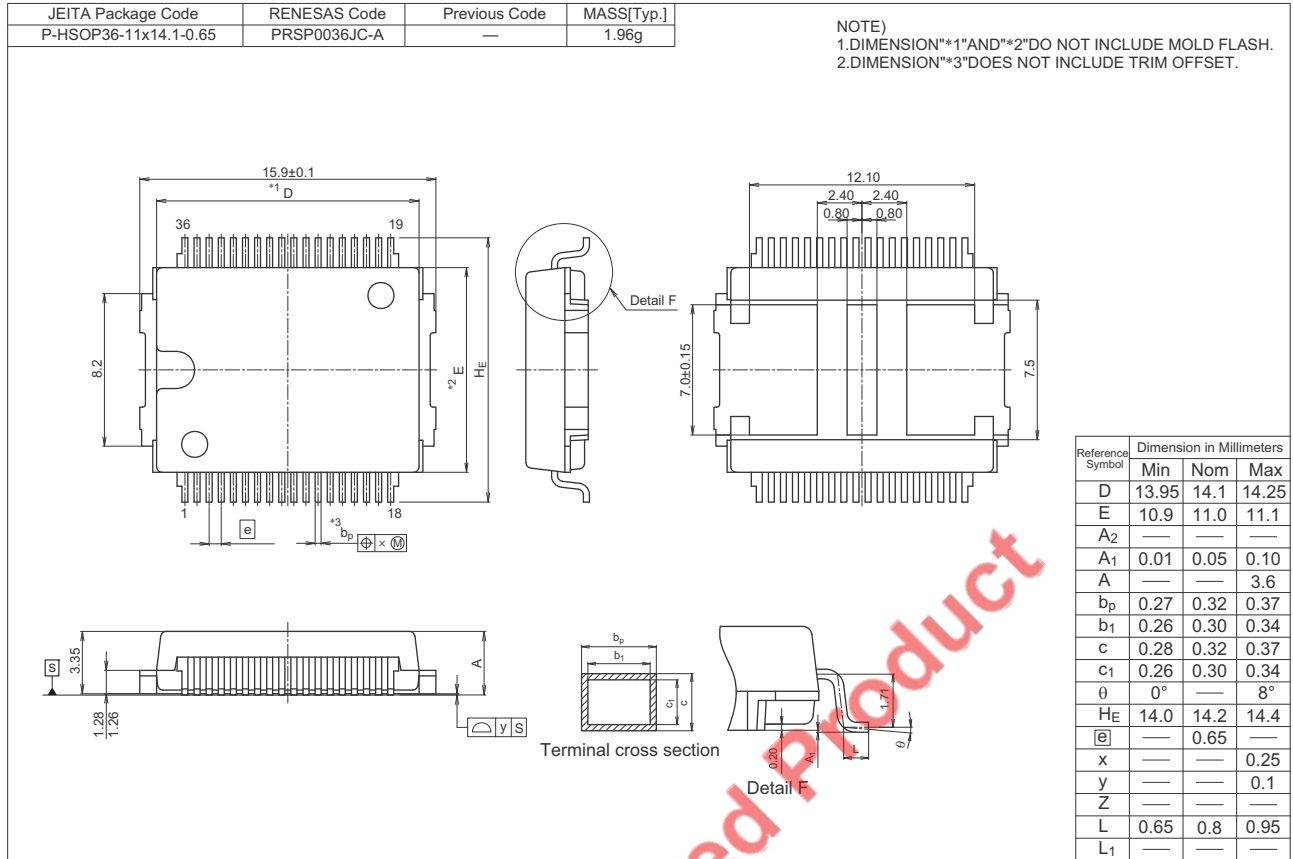

Ordering Information

Orderable Part Number	Quantity	Shipping Container
R2J25953SP-00-Q2	700 pcs/ box	Taping

Note: The symbol of 2nd "-" is occasionally presented as "#".

EOL announced product

Notice

1. Descriptions of circuits, software and other related information in this document are provided only to illustrate the operation of semiconductor products and application examples. You are fully responsible for the incorporation of these circuits, software, and information in the design of your equipment. Renesas Electronics assumes no responsibility for any losses incurred by you or third parties arising from the use of these circuits, software, or information.
 2. Renesas Electronics has used reasonable care in preparing the information included in this document, but Renesas Electronics does not warrant that such information is error free. Renesas Electronics assumes no liability whatsoever for any damages incurred by you resulting from errors in or omissions from the information included herein.
 3. Renesas Electronics does not assume any liability for infringement of patents, copyrights, or other intellectual property rights of third parties by or arising from the use of Renesas Electronics products or technical information described in this document. No license, express, implied or otherwise, is granted hereby under any patents, copyrights or other intellectual property rights of Renesas Electronics or others.
 4. You should not alter, modify, copy, or otherwise misappropriate any Renesas Electronics product, whether in whole or in part. Renesas Electronics assumes no responsibility for any losses incurred by you or third parties arising from such alteration, modification, copy or otherwise misappropriation of Renesas Electronics product.
 5. Renesas Electronics products are classified according to the following two quality grades: "Standard" and "High Quality". The recommended applications for each Renesas Electronics product depends on the product's quality grade, as indicated below.
"Standard": Computers; office equipment; communications equipment; test and measurement equipment; audio and visual equipment; home electronic appliances; machine tools; personal electronic equipment; and industrial robots etc.
"High Quality": Transportation equipment (automobiles, trains, ships, etc.); traffic control systems; anti-disaster systems; anti-crime systems; and safety equipment etc.
Renesas Electronics products are neither intended nor authorized for use in products or systems that may pose a direct threat to human life or bodily injury (artificial life support devices or systems, surgical implantations etc.), or may cause serious property damages (nuclear reactor control systems, military equipment etc.). You must check the quality grade of each Renesas Electronics product before using it in a particular application. You may not use any Renesas Electronics product for any application for which it is not intended. Renesas Electronics shall not be in any way liable for any damages or losses incurred by you or third parties arising from the use of any Renesas Electronics product for which the product is not intended by Renesas Electronics.
 6. You should use the Renesas Electronics products described in this document within the range specified by Renesas Electronics, especially with respect to the maximum rating, operating supply voltage range, movement power voltage range, heat radiation characteristics, installation and other product characteristics. Renesas Electronics shall have no liability for malfunctions or damages arising out of the use of Renesas Electronics products beyond such specified ranges.
 7. Although Renesas Electronics endeavors to improve the quality and reliability of its products, semiconductor products have specific characteristics such as the occurrence of failure at a certain rate and malfunctions under certain use conditions. Further, Renesas Electronics products are not subject to radiation resistance design. Please be sure to implement safety measures to guard them against the possibility of physical injury, and injury or damage caused by fire in the event of the failure of a Renesas Electronics product, such as safety design for hardware and software including but not limited to redundancy, fire control and malfunction prevention, appropriate treatment for aging degradation or any other appropriate measures. Because the evaluation of microcomputer software alone is very difficult, please evaluate the safety of the final products or systems manufactured by you.
 8. Please contact a Renesas Electronics sales office for details as to environmental matters such as the environmental compatibility of each Renesas Electronics product. Please use Renesas Electronics products in compliance with all applicable laws and regulations that regulate the inclusion or use of controlled substances, including without limitation, the EU RoHS Directive. Renesas Electronics assumes no liability for damages or losses occurring as a result of your noncompliance with applicable laws and regulations.
 9. Renesas Electronics products and technology may not be used for or incorporated into any products or systems whose manufacture, use, or sale is prohibited under any applicable domestic or foreign laws or regulations. You should not use Renesas Electronics products or technology described in this document for any purpose relating to military applications or use by the military, including but not limited to the development of weapons of mass destruction. When exporting the Renesas Electronics products or technology described in this document, you should comply with the applicable export control laws and regulations and follow the procedures required by such laws and regulations.
 10. It is the responsibility of the buyer or distributor of Renesas Electronics products, who distributes, disposes of, or otherwise places the product with a third party, to notify such third party in advance of the contents and conditions set forth in this document, Renesas Electronics assumes no responsibility for any losses incurred by you or third parties as a result of unauthorized use of Renesas Electronics products.
 11. This document may not be reproduced or duplicated in any form, in whole or in part, without prior written consent of Renesas Electronics.
 12. Please contact a Renesas Electronics sales office if you have any questions regarding the information contained in this document or Renesas Electronics products, or if you have any other inquiries.
- (Note 1) "Renesas Electronics" as used in this document means Renesas Electronics Corporation and also includes its majority-owned subsidiaries.
(Note 2) "Renesas Electronics product(s)" means any product developed or manufactured by or for Renesas Electronics.



SALES OFFICES

Renesas Electronics Corporation

<http://www.renesas.com>

Refer to "<http://www.renesas.com/>" for the latest and detailed information.

Renesas Electronics America Inc.
2880 Scott Boulevard Santa Clara, CA 95050-2554, U.S.A.
Tel: +1-408-886-6000, Fax: +1-408-886-6130

Renesas Electronics Canada Limited
1101 Nicholson Road, Newmarket, Ontario L3Y 9C3, Canada
Tel: +1-905-898-5441, Fax: +1-905-898-3220

Renesas Electronics Europe Limited
Dukes Meadow, Millboard Road, Bourne End, Buckinghamshire, SL8 5FH, U.K.
Tel: +44-1628-651-700, Fax: +44-1628-651-804

Renesas Electronics Europe GmbH
Arcadiastrasse 10, 40472 Düsseldorf, Germany
Tel: +49-211-65030, Fax: +49-211-6503-1327

Renesas Electronics (China) Co., Ltd.
7th Floor, Quantum Plaza, No.27 ZhiChunLu Haidian District, Beijing 100083, P.R.China
Tel: +86-10-8235-1155, Fax: +86-10-8235-7679

Renesas Electronics (Shanghai) Co., Ltd.
Unit 204, 205, AZIA Center, No.1233 Lujiazui Ring Rd., Pudong District, Shanghai 200120, China
Tel: +86-21-5877-1818, Fax: +86-21-6887-7858 / -7898

Renesas Electronics Hong Kong Limited
Unit 1601-1613, 16/F., Tower 2, Grand Century Place, 193 Prince Edward Road West, Mongkok, Kowloon, Hong Kong
Tel: +852-2886-9318, Fax: +852 2886-9022/9044

Renesas Electronics Taiwan Co., Ltd.
13F, No. 363, Fu Shing North Road, Taipei, Taiwan
Tel: +886-2-8175-9600, Fax: +886 2-8175-9670

Renesas Electronics Singapore Pte. Ltd.
80 Bendemeer Road, Unit #06-02, Hyflux Innovation Centre Singapore 339949
Tel: +65-6213-0200, Fax: +65-6213-0300

Renesas Electronics Malaysia Sdn.Bhd.
Unit 906, Block B, Menara Amcorp, Amcorp Trade Centre, No. 18, Jln Persiaran Barat, 46050 Petaling Jaya, Selangor Darul Ehsan, Malaysia
Tel: +60-3-7955-3390, Fax: +60-3-7955-9510

Renesas Electronics Korea Co., Ltd.
11F., Samik Laved' or Bldg., 720-2 Yeoksam-Dong, Kangnam-Ku, Seoul 135-080, Korea
Tel: +82-2-558-3737, Fax: +82-2-558-5141