

REAC842J

Low Input Offset Voltage $V_{IO} \leq 1\text{mV} (@ -40^\circ\text{C to } +125^\circ\text{C})$

Single Power Supply, High Speed, Wide Band,

Dual Bipolar Operational Amplifier

DESCRIPTION

The REAC842J is a single power and dual operational amplifiers which has features low input offset voltage $V_{IO} \leq \pm 1\text{mV}$ and low input offset voltage temperature drift in $T_A = -40^\circ\text{C to } +125^\circ\text{C}$.

A high speed PNP transistor is used in the circuit which improves the characteristics such as slew rate, gain-bandwidth product, stabilization of the withstand load capacitance, with no crossover distortion compared to REAC1251.

As this is a high slew rate product, it is able to provide high-speed signal amplification and can be applied to a wide range of sensor applications such as motors. Moreover, due to its small package (MSOP), mounting on the vicinity of the sensor becomes possible, which makes the board smaller and increases design freedom.

FEATURES

AEC-Q100 Compliant

Absolute Maximum Ratings

- Power Supply Voltage -0.1 to +36 V
- Operating Ambient Temperature Range -40 °C to +125 °C

Electrical Characteristics

- Power Supply Voltage +3 V to +32 V (MIN. MAX.)
- Input Offset Voltage ($T_A @ -40^\circ\text{C to } +125^\circ\text{C}$) $\pm 1\text{ mV (MAX.)}$
- Input Offset Voltage Temperature Drift $\pm 1\ \mu\text{V}/^\circ\text{C (TYP.)}$
- Gain Bandwidth Product ($f = 100\text{ kHz}$) 4 MHz (TYP.)
- Slew Rate ($V^\pm = \pm 15\text{ V}$) 7 V/ $\mu\text{s (TYP.)}$
- Stability to capacitive load (Capacitive load, 1000 pF)
- Build-in phase correction circuit.
- Built-in output short-circuit protection circuit.

The package line-up is MSOP

PRODUCT LINEUP

Package	SOP	MSOP
Product Name ⁽¹⁾	REAC842JSM#GCB REAC842JSM#HCB	REAC842JSN#GC1 REAC842JSN#HC1
Quality Level	High Quality Level	
Outline	<p style="text-align: right;">Unit : mm</p>	<p style="text-align: right;">Unit : mm</p>

(1) The taping directions are different between GC and HC. Please refer to the delivery specifications in detail.

PIN CONFIGURATION (Marking Side)

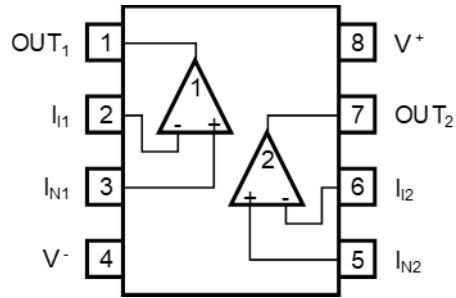

EQUIVALENT CIRCUIT (1/2 CIRCUIT)

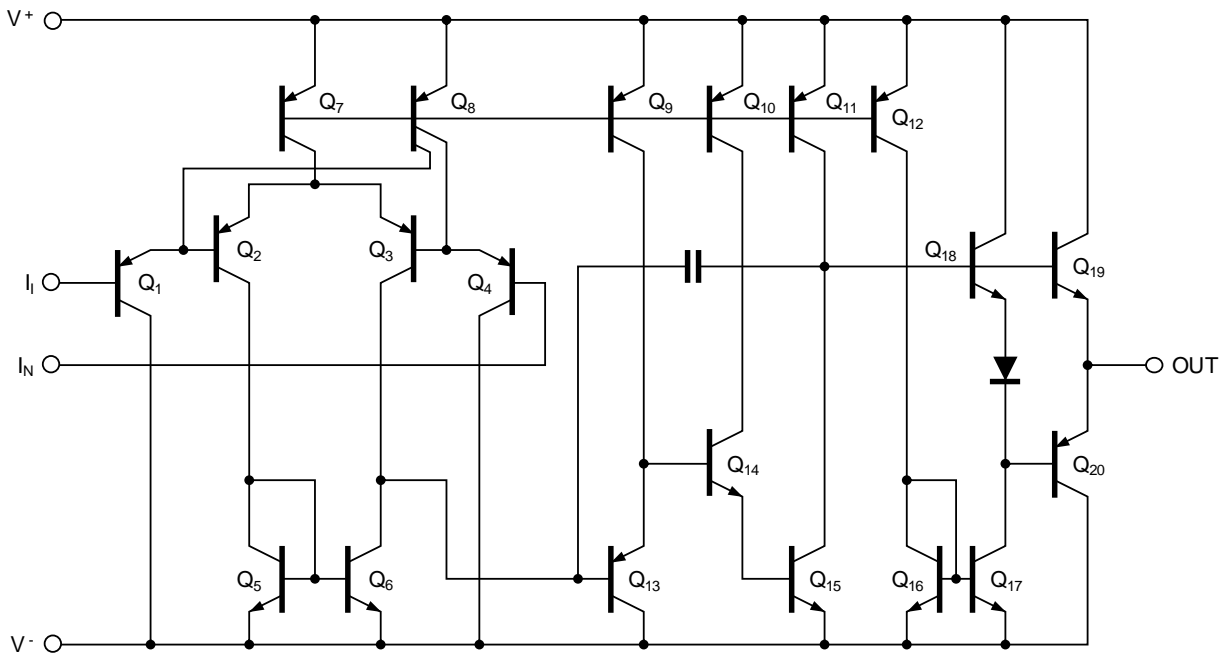

ABSOLUTE MAXIMUM RATINGS(T_A = -40 to +125 °C)

Parameter	Symbol	REAC842JSM	REAC842JSN	Unit
Power Supply Voltage ^{Note 1}	V ⁺ - V ⁻	-0.1 to +36		V
Differential Input Voltage	V _{ID}	±36		V
Input Voltage ^{Note 2}	V _I	V ⁻ -0.1 to V ⁻ +36		V
Output Applied Voltage ^{Note 3}	V _O	V ⁻ -0.1 to V ⁺ +0.1		V
Total Power Dissipation ^{Note 4}	P _T	440		mW
Output Short Circuit Duration ^{Note 5}	t _s	Indefinite		s
Operating Ambient Temperature	T _A	-40 to +125		°C
Operating Junction Temperature	T _J	-40 to +150		°C
Storage Temperature	T _{stg}	-55 to +150		°C

- Notes:
- Note that reverse connections of the power supply may damage the ICs.
 - The allowable input voltage range without damaging or destructing the device. Independent to power supply voltage range.
Do not apply voltage equivalent to V⁻ (GND) -0.1 V or less.
The input voltage for normal operation as operational amplifier is within the Common Mode Input Voltage Range of electrical characteristics.
 - The input voltage range that can be applied to the output pin externally without deteriorating or damaging the device characteristic.
Note that the rating should not be exceeded including transient state such as power supply ON/OFF, etc.
The output voltage that can be obtained as operational amplifier is within the Output Voltage Swing of electrical characteristics.
 - This is the value when the glass epoxy substrate (size: 100 mm x 100 mm, thickness: 1 mm, 15% of the substrate area where only one side is copper foiled is filling wired) is mounted.
Note that restrictions will be made to the following conditions for each product, and the de-rating ratio depending on the operating ambient temperature.
REAC842JSM : Temperature condition is 50 °C or less. De-rate 4.4 mW/°C when T_A > 50 °C.
Junction - ambient thermal resistance R_{th(j-a)} = 227 °C/W
REAC842JSN : Temperature condition is 58 °C or less. De-rate 4.8 mW/°C when T_A > 58 °C.
Junction - ambient thermal resistance R_{th(j-a)} = 208 °C/W
 - Please use below the Total Power Dissipation and the de-rating of Note 4.

RECOMMENDED OPERATING CONDITIONS

Parameter	Symbol	MIN.	MAX.	Unit
Power Supply Voltage (V ⁻ = GND)	V ⁺	+3	+32	V
Power Supply Voltage (Dual Supply)	V [±]	±1.5	±16	V
Output Current	I _o		±10	mA
Capacitive Load (A _v = +1)	C _L		1000 ^{Note 6}	pF

- Notes:
- This is the value when feedback resistor (R_f) = 0.

ELECTRICAL CHARACTERISTICS

(T_A = 25 °C, V[±] = ±15 V)

Parameter	Symbol	MIN.	TYP.	MAX.	Unit	Test Condition
Input Offset Voltage	V _{IO}		±0.3	±1	mV	V _{IN} = 1/2 V _{CC} , R _S ≤ 50 Ω
Input Offset Current	I _{IO}		±6	±75	nA	
Input Bias Current ^{Note 7}	I _B		75	200	nA	
Large Signal Voltage Gain	A _V	25,000	1,000,000			R _L ≥ 2 kΩ, V _O = ±10 V
Circuit Current ^{Note 8}	I _{CC}		4.3	6	mA	I _O = 0 A
Common Mode Rejection Ratio	CMR	70	100		dB	
Supply Voltage Rejection Ratio	SVR	70	110		dB	
Output Voltage (High)	V _{OH1}	13.7	-	-	V	R _L = 10 kΩ
	V _{OH2}	13.5	-	-	V	R _L = 2 kΩ
Output Voltage (Low)	V _{OL1}	-	-	-13.7	V	R _L = 10 kΩ
	V _{OL2}	-	-	-13.5	V	R _L = 2 kΩ
Common Mode Input Voltage Range	V _{ICM}	V ⁻		V ⁺ -1.8	V	
Slew Rate	SR		7		V/μs	A _V = +1 (Rise Edge)
Gain Bandwidth Product	GBW		4		MHz	f = 100 kHz
Channel Separation			120		dB	f = 20 Hz to 20 kHz

(T_A = 25 °C, V⁺ = +5 V, V⁻ = GND)

Parameter	Symbol	MIN.	TYP.	MAX.	Unit	Test Condition
Input Offset Voltage	V _{IO}		±0.3	±1	mV	V _{IN} = 1/2 V _{CC} , R _S ≤ 50 Ω
Input Offset Current	I _{IO}		±6	±75	nA	
Input Bias Current ^{Note 7}	I _B		75	200	nA	
Large Signal Voltage Gain	A _V	25,000	600,000			R _L ≥ 2 kΩ
Circuit Current ^{Note 8}	I _{CC}		3.3	5	mA	I _O = 0 A
Common Mode Rejection Ratio	CMR	70	95		dB	
Supply Voltage Rejection Ratio	SVR	70	95		dB	
Output Voltage (High)	V _{OH1}	3.8	-	-	V	R _L = 10 kΩ (Connected to GND)
	V _{OH2}	3.7	-	-	V	R _L = 2 kΩ (Connected to GND)
Output Voltage (Low)	V _{OL1}	-	-	30	mV	R _L = 10 kΩ (Connected to GND)
	V _{OL2}	-	-	30	mV	R _L = 2 kΩ (Connected to GND)
Common Mode Input Voltage Range	V _{ICM}	0		V ⁺ -1.8	V	
Output Source Current	I _{O SOURCE}	10	30		mA	V _{IN (+)} = +1 V, V _{IN (-)} = 0 V
Output Sink Current	I _{O SINK}	10	30		mA	V _{IN (+)} = 0 V, V _{IN (-)} = +1 V
Slew Rate	SR		5.5		V/μs	A _V = +1 (Rise Edge)

(T_A = -40 to +125 °C, V⁺ = +5 V, V⁻ = GND)

Parameter	Symbol	MIN.	TYP.	MAX.	Unit	Test Condition
Input Offset Voltage	V _{IO}		±0.3	±1	mV	V _{IN} = 1/2 V _{CC} , R _S ≤ 50 Ω
Input Offset Current	I _{IO}			±90	nA	
Input Bias Current ^{Note 7}	I _B			200	nA	
Large Signal Voltage Gain	A _V	5,000				R _L ≥ 2 kΩ
Circuit Current ^{Note 8}	I _{CC}			6	mA	I _O = 0 A
Common Mode Rejection Ratio	CMR	50			dB	
Supply Voltage Rejection Ratio	SVR	60			dB	
Output Voltage (High)	V _{OH1}	3.7	-	-	V	R _L = 10 kΩ (Connected to GND)
	V _{OH2}	3,6	-	-	V	R _L = 2 kΩ (Connected to GND)
Output Voltage (Low)	V _{OL1}	-	-	60	mV	R _L = 10 kΩ (Connected to GND)
	V _{OL2}	-	-	60	mV	R _L = 2 kΩ (Connected to GND)
Common Mode Input Voltage Range	V _{ICM}	0		V ⁺ -2.5	V	
Output Source Current	I _{O SOURCE}	5			mA	V _{IN (+)} = +1 V, V _{IN (-)} = 0 V
Output Sink Current	I _{O SINK}	5			mA	V _{IN (+)} = 0 V, V _{IN (-)} = +1 V

- Notes:
7. The current flow direction of the input bias is out from the IC because the first stage of the IC composed of PNP transistor.
 8. Current flowing through the internal circuit of this IC. This current flow regardless of the channel used.

CHARACTERISTICS CURVE ($T_A = 25\text{ }^\circ\text{C}$, TYP.) (REFERENCE VALUE)

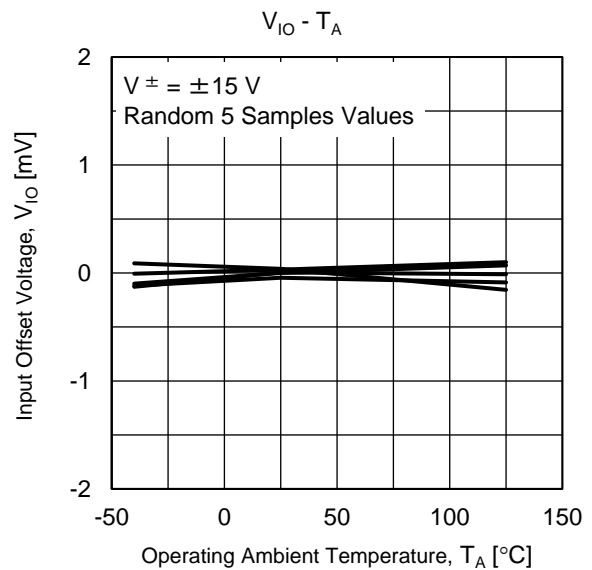
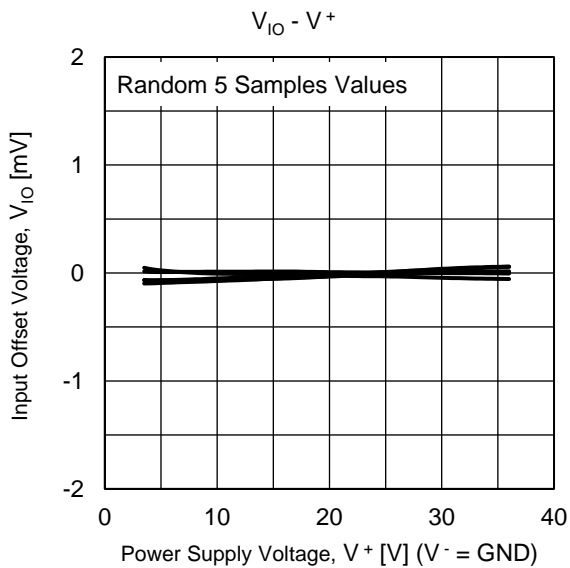
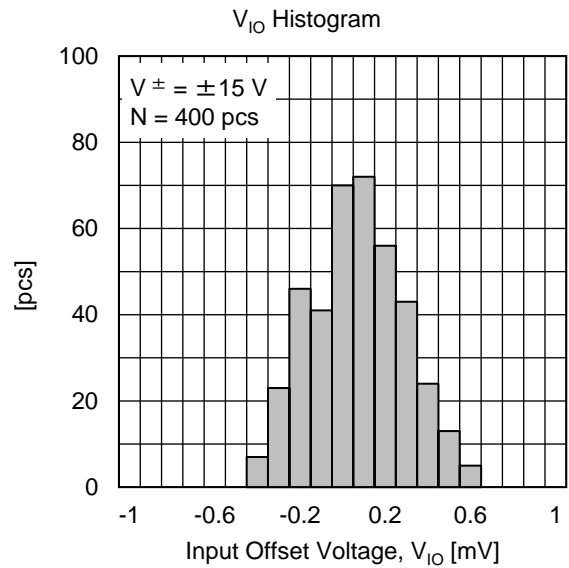
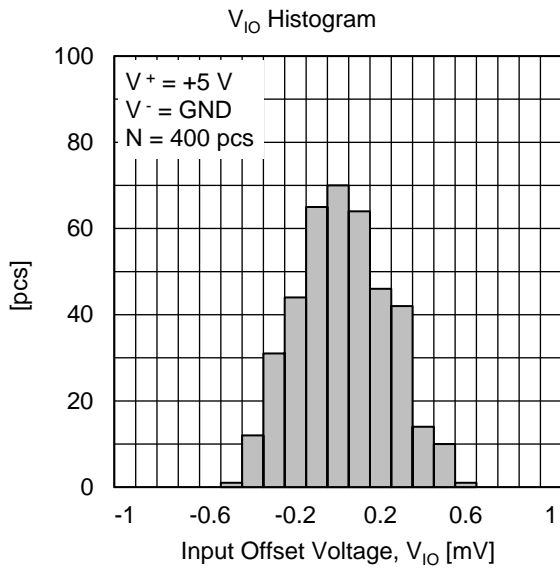
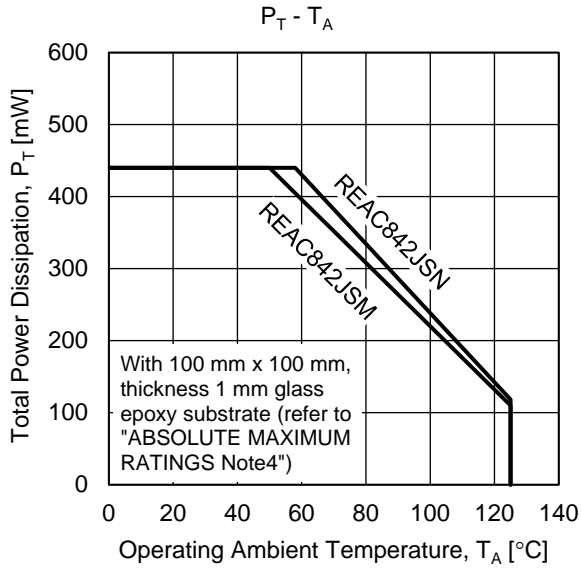

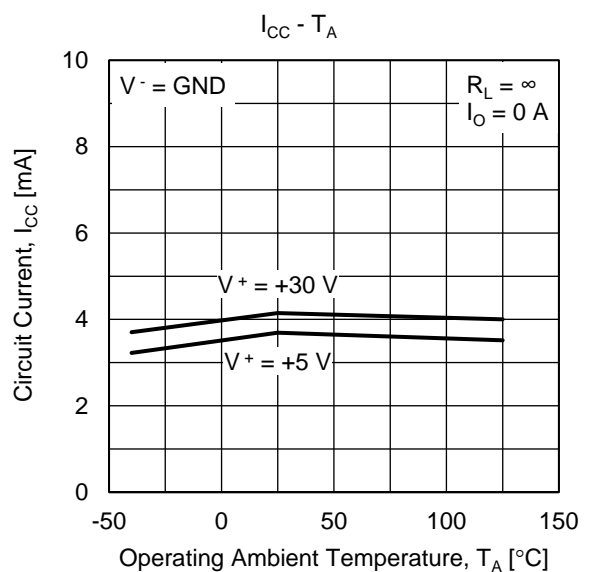
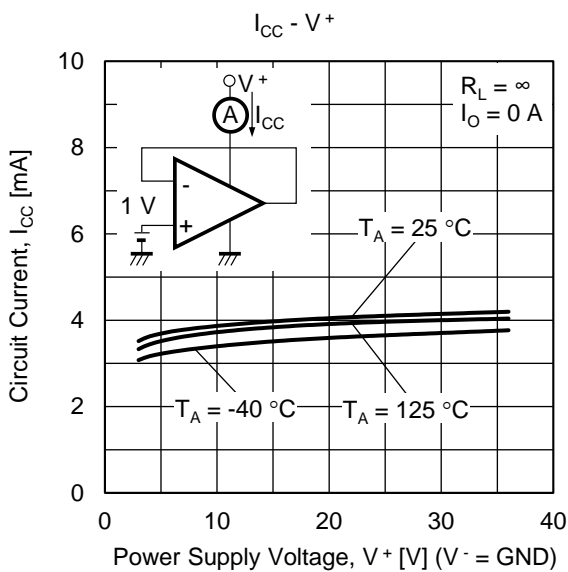
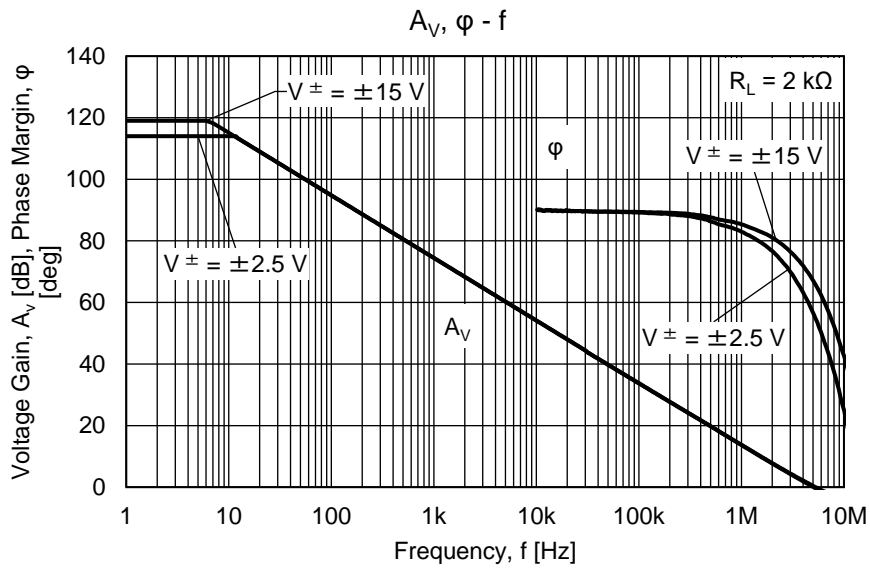
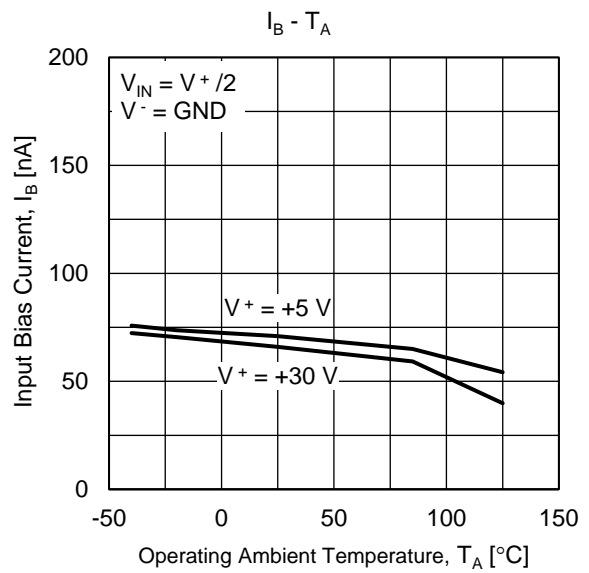
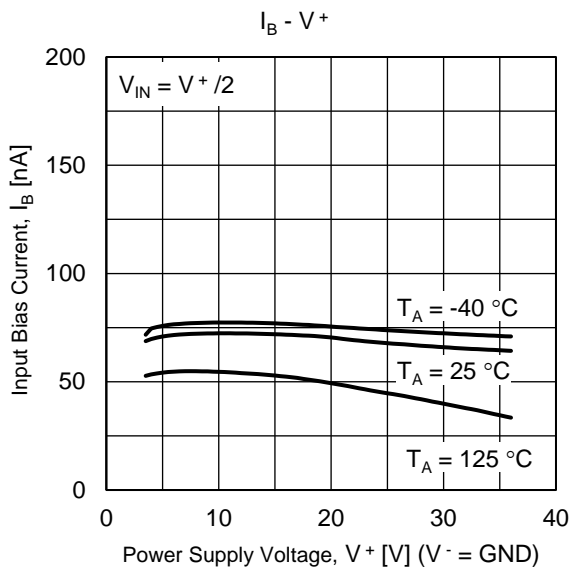

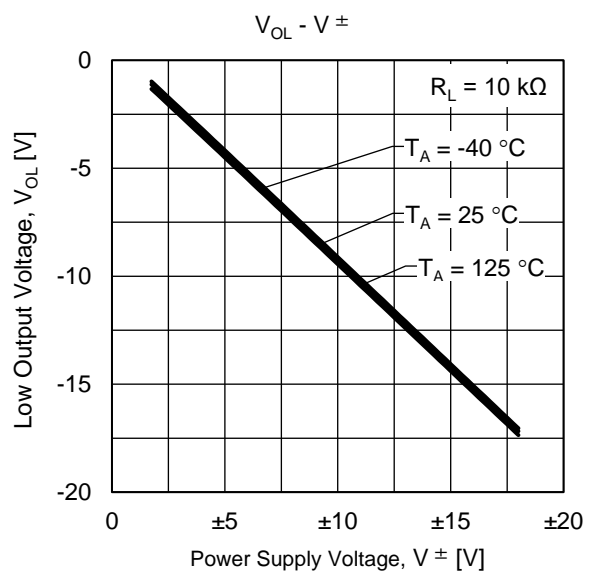
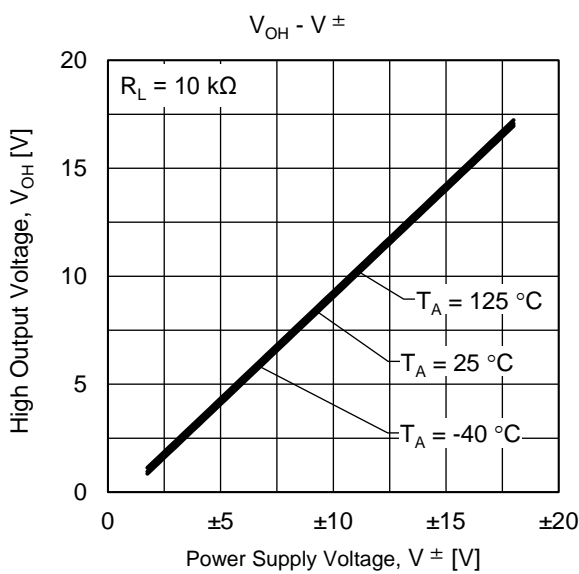
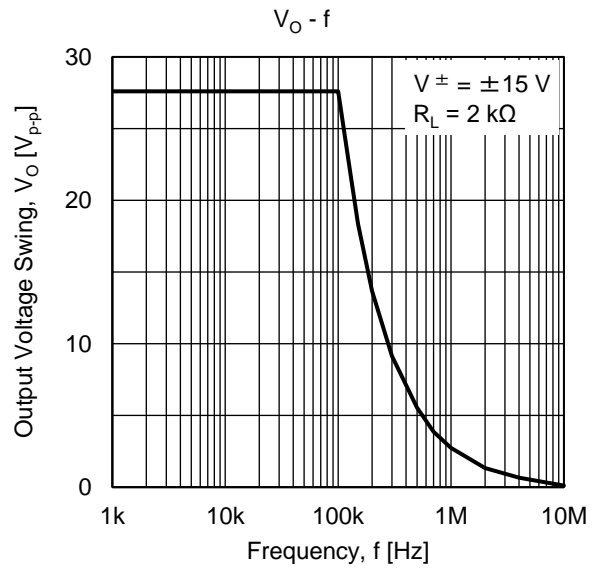
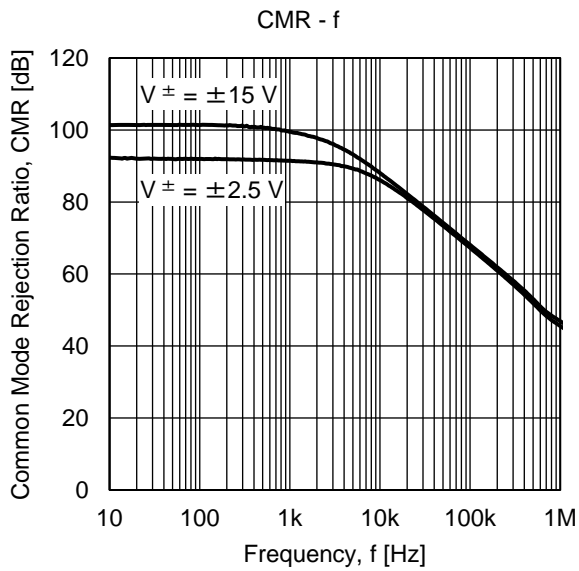
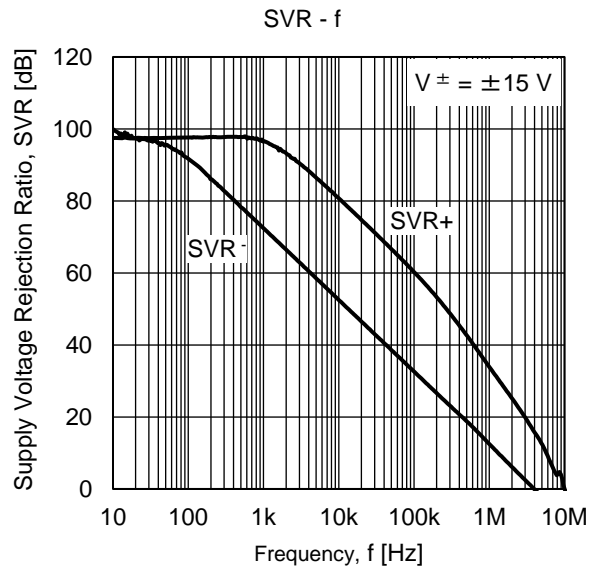
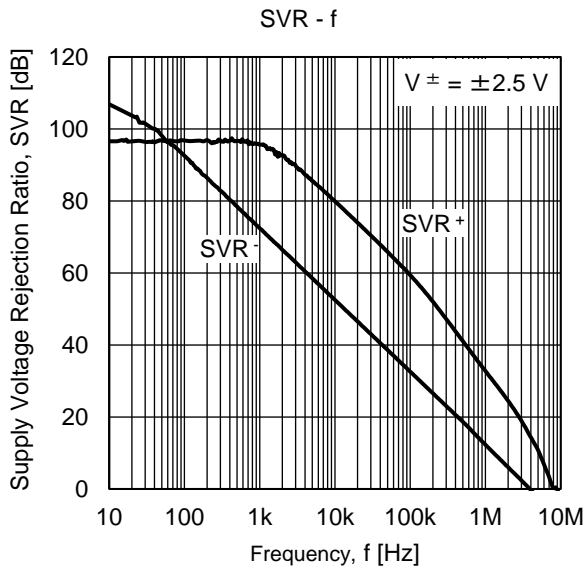

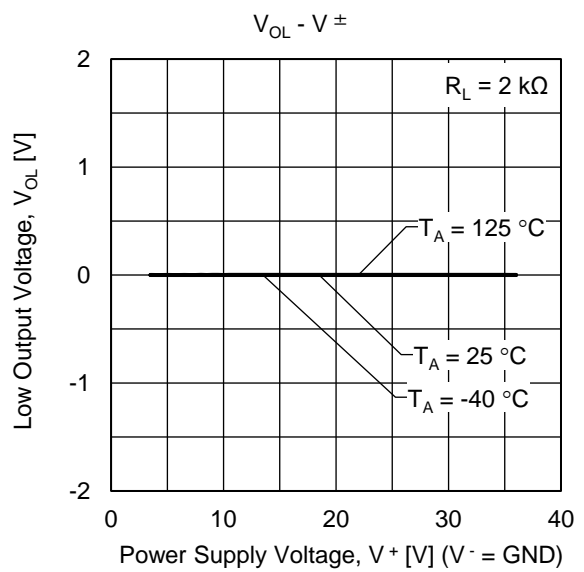
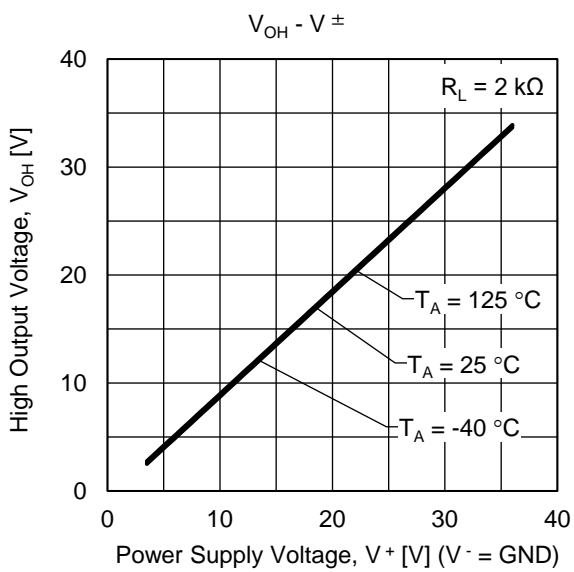
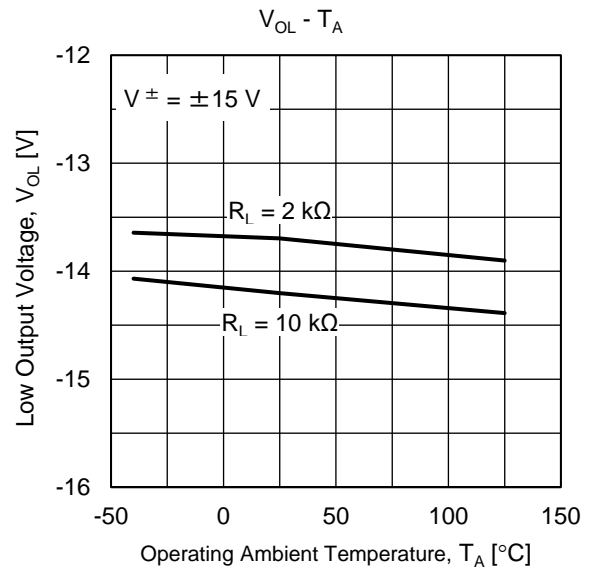
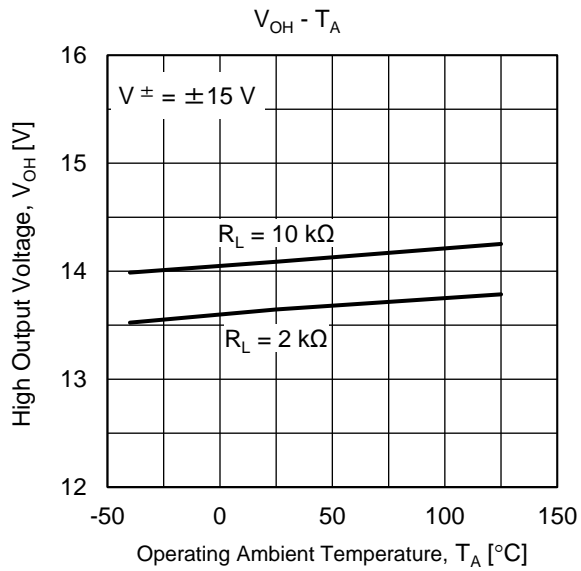
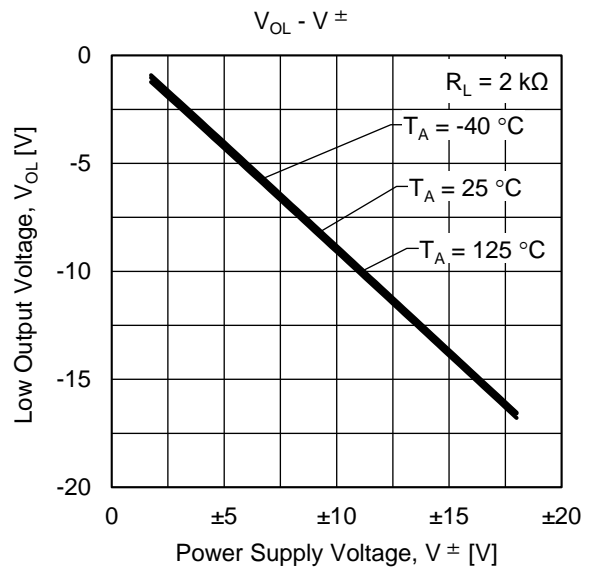
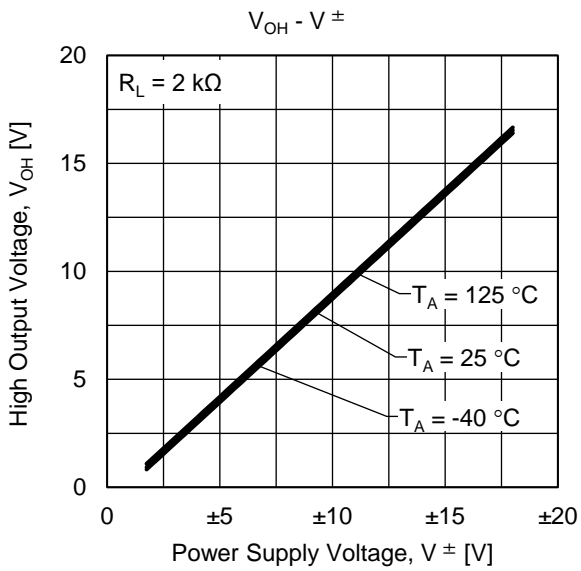

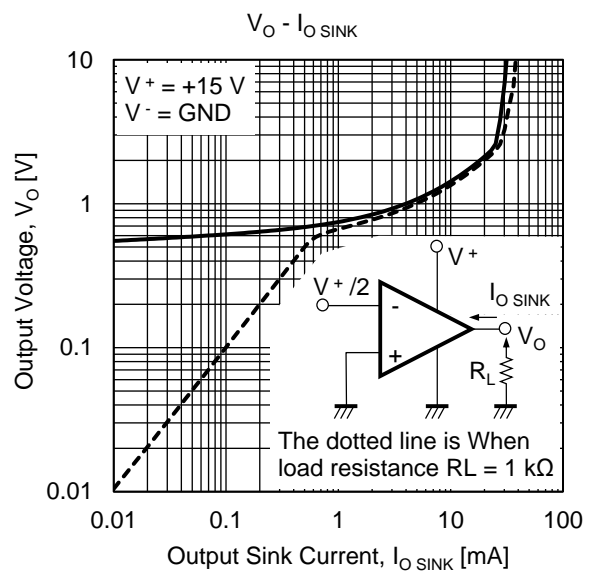
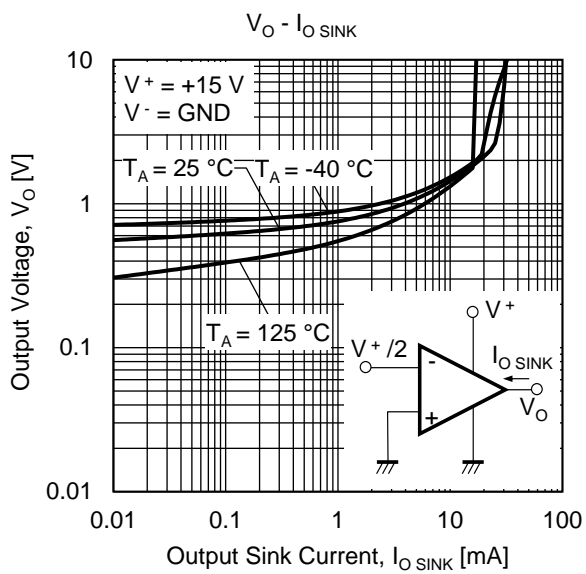
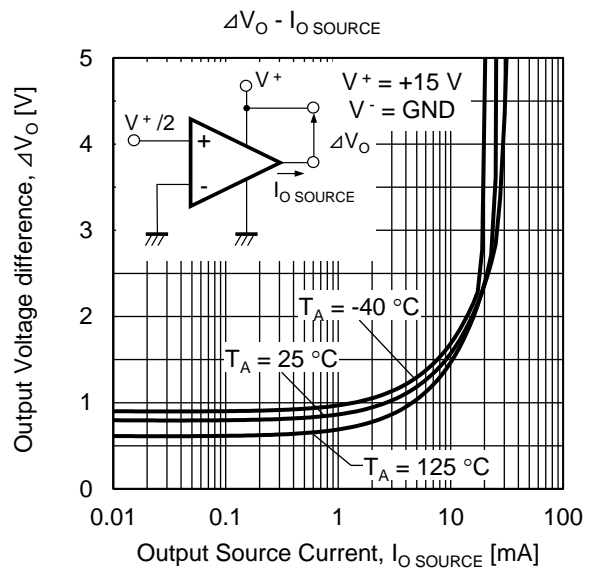
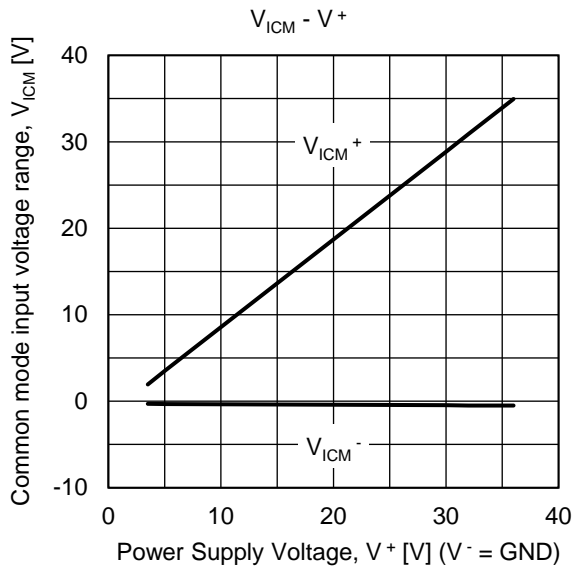
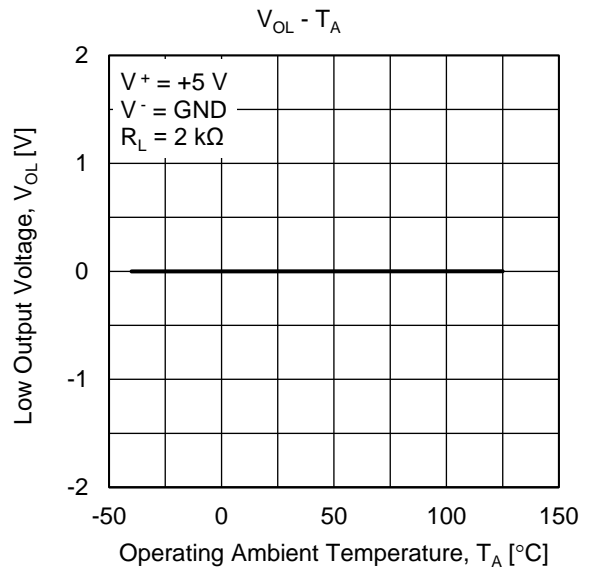
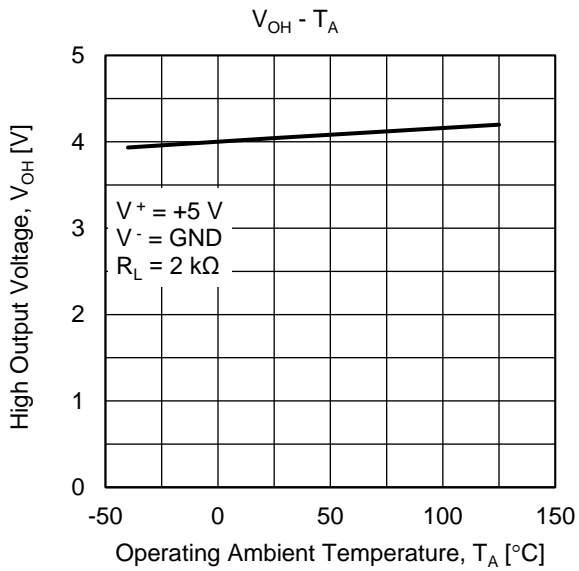

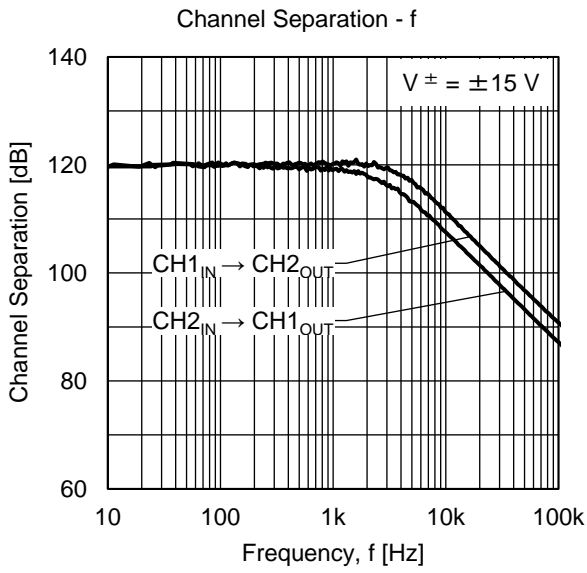
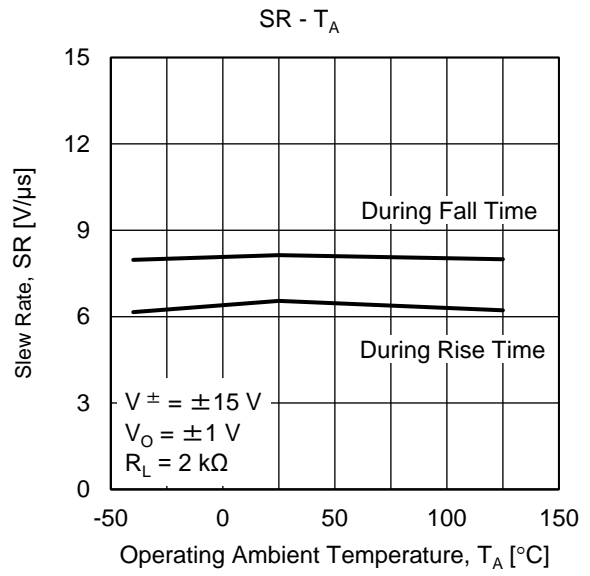
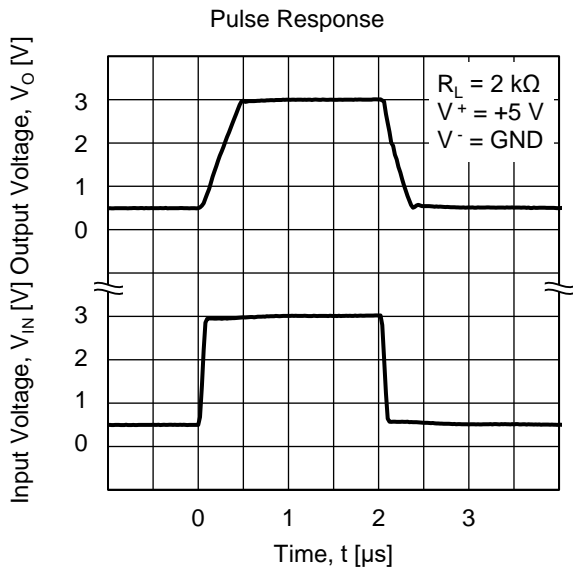

PACKAGE DRAWINGS:

8-PIN PLASTIC SOP

JEITA Package code	RENESAS code	MASS(TYP.)[g]
P-LSOP8-4.4x5.2-1.27	PLSP0008DE-A	0.09[g]

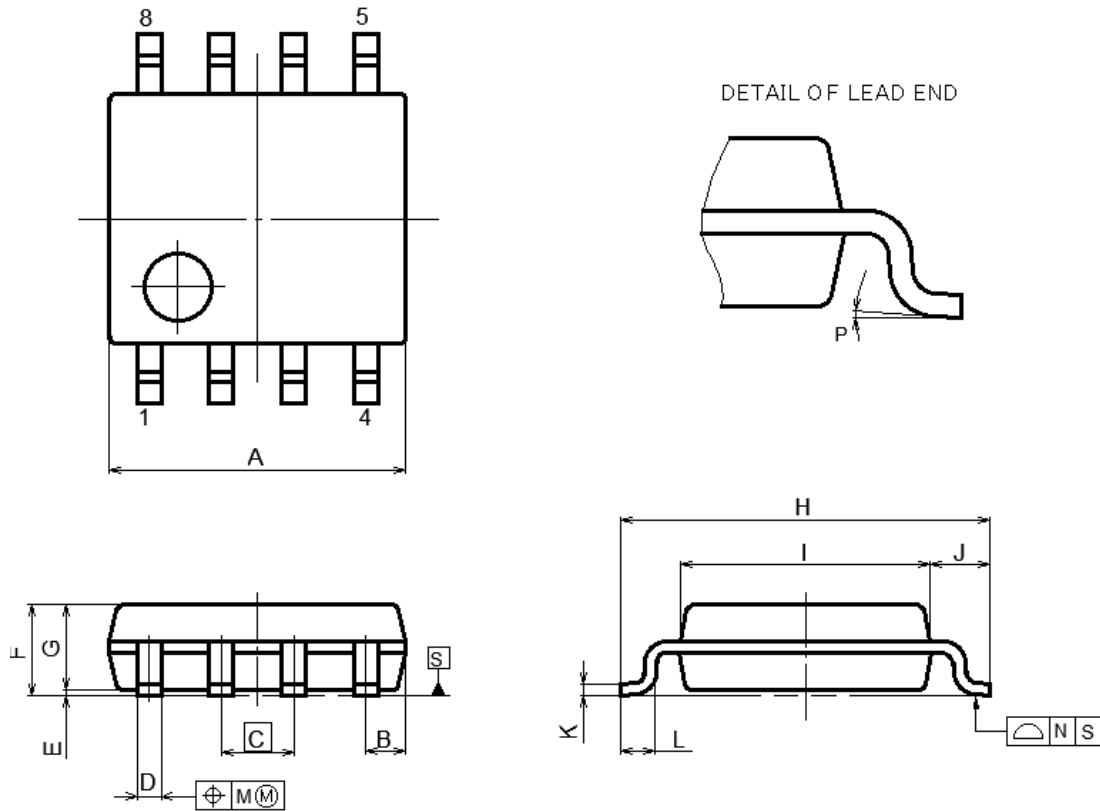

NOTE
 EACH LEAD CENTERLINE IS LOCATED WITHIN 0.12 MM OF ITS TRUE POSITION(T.P.) AT MAXIMUM MATERIAL CONDITION.

(UNIT:mm)

ITEM	DIMENSIONS
A	5.2±0.17
B	0.78MAX
C	1.27(T.P)
D	0.40±0.05
E	0.1±0.1
F	1.59±0.21
G	1.49
H	6.5±0.3
I	4.4±0.1
J	1.05±0.15
K	0.2±0.07
L	0.6±0.20
M	0.1MAX
N	0.1MAX
P	4°±4°

8-PIN PLASTIC MSOP

JEITA Package code	RENESAS code	Previous code	MASS(TYP.)[g]
P-VSSOP8-2.75x2.8-0.65	PVSP0008JA-A	—	0.02[g]

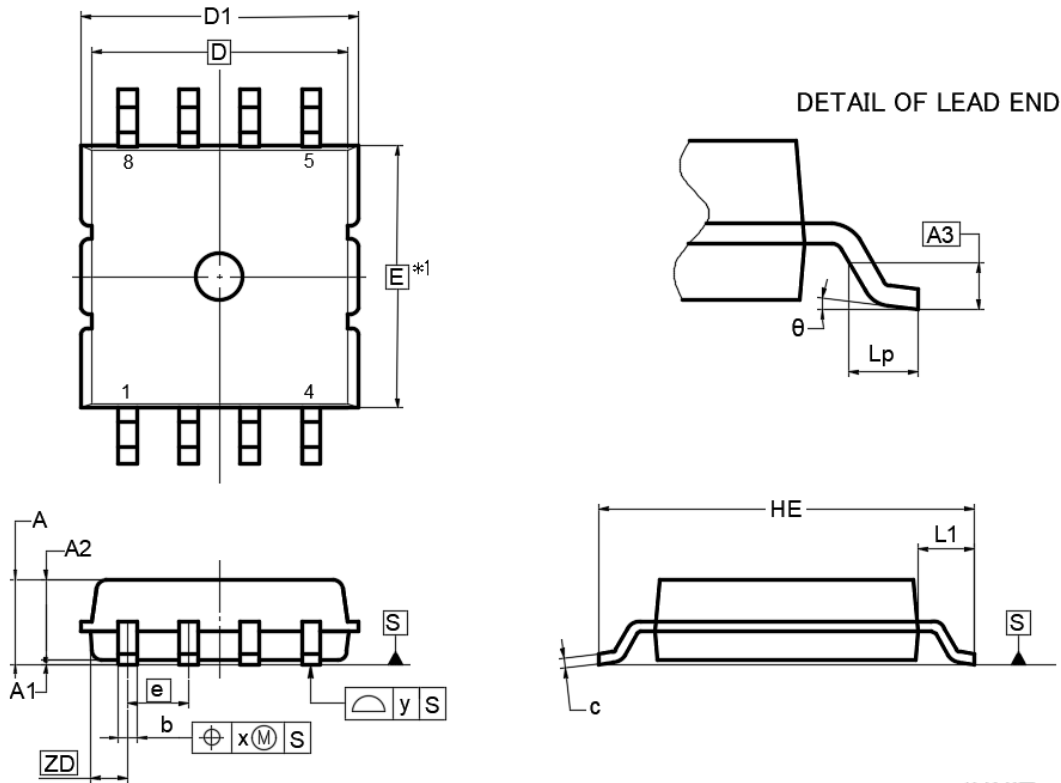

NOTE) .
 1. DIMENSIONS "*1"
 DO NOT INCLUDE MOLD FLASH.
 2. EACH LEAD CENTERLINE IS LOCATED WITHIN 0.10 MM OF
 ITS TRUE POSITION AT MAXIMUM MATERIAL CONDITION.

(UNIT:mm)

ITEM	DIMENSIONS
D	2.75
D1	2.95±0.20
E	2.80
HE	4.00±0.30
e	0.65
b	0.20 ^{+0.10} _{-0.05}
A	1.00MAX
A1	0.05±0.05
A2	0.85±0.10
A3	0.25
L1	0.60±0.20
c	0.13 ^{+0.10} _{-0.05}
Lp	0.37±0.12
x	0.10
y	0.10
θ	7±7°
ZD	0.50

USE WITH PRECAUTIONS

Managing unused circuits

If there is an unused circuit, the following connection is recommended.

Process example of unused circuits

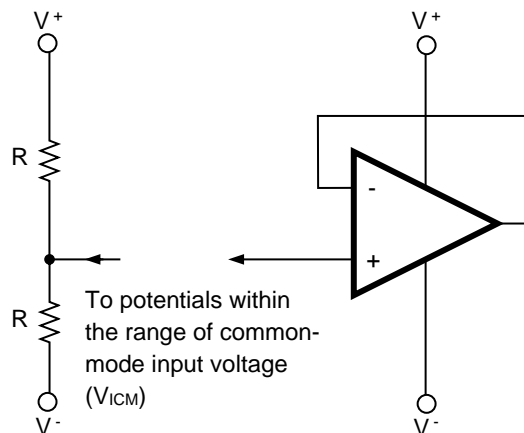

Remark: In this example, an intermediate potential between V^+ and V^- is applied.

Ratings of input/output pin voltage

When the voltage of input/output pin exceeds the absolute maximum rating, the parasitic diode within the IC may conduct, causing characteristics degradation or damage. In addition, if the input pin is lower than V^- , or the output pin exceeds the power supply voltage, it is recommended to make a clamping circuit using a diode with low forward voltage (e.g.: Schottky diode) as protection.

Range of common-mode input voltage

When the supply voltage does not meet the condition of electrical characteristics, the range of common-mode input voltage is as follows.

$$V_{ICM} \text{ (TYP.) : } V^- \text{ to } V^+ - 1.8 \text{ [V] (} T_A = 25 \text{ }^\circ\text{C)}$$

During designing, do include some tolerance by considering temperature characteristics etc.

Maximum Output Voltage

The TYP. value range of the maximum output voltage when the supply voltage does not meet the condition of electrical characteristics is as follows:

$$V_{Om^+} \text{ (TYP.) : } V^+ - 1 \text{ [V] (} T_A = 25 \text{ }^\circ\text{C)}, V_{Om^-} \text{ (TYP.) : } V^- + 0.7 \text{ [V] (} T_A = 25 \text{ }^\circ\text{C)}$$

During designing, do include some tolerance by considering characteristics variation, temperature characteristics and so on. In addition, also note that the output voltage range (V_{Om^+} to V_{Om^-}) will become narrow when the output current increases.

Output Operation

This IC will not be able to sink output current when the output voltage is $V^- + 0.7 \text{ V}$ and below. In this case, the output voltage level can be improved to the V^- side by connecting the load resistor between the output terminal and V^- to sink the current at the load resistor. (The effect will differ depending on the flow of current in the load resistance.)

Handling of ICs

When stress is added to the ICs due to warpage or bending of a board, the characteristic may fluctuates due to piezoelectric effect. Therefore, pay attention to warpage or bending of a board.

Notice

1. Descriptions of circuits, software and other related information in this document are provided only to illustrate the operation of semiconductor products and application examples. You are fully responsible for the incorporation or any other use of the circuits, software, and information in the design of your product or system. Renesas Electronics disclaims any and all liability for any losses and damages incurred by you or third parties arising from the use of these circuits, software, or information.
2. Renesas Electronics hereby expressly disclaims any warranties against and liability for infringement or any other claims involving patents, copyrights, or other intellectual property rights of third parties, by or arising from the use of Renesas Electronics products or technical information described in this document, including but not limited to, the product data, drawings, charts, programs, algorithms, and application examples.
3. No license, express, implied or otherwise, is granted hereby under any patents, copyrights or other intellectual property rights of Renesas Electronics or others.
4. You shall be responsible for determining what licenses are required from any third parties, and obtaining such licenses for the lawful import, export, manufacture, sales, utilization, distribution or other disposal of any products incorporating Renesas Electronics products, if required.
5. You shall not alter, modify, copy, or reverse engineer any Renesas Electronics product, whether in whole or in part. Renesas Electronics disclaims any and all liability for any losses or damages incurred by you or third parties arising from such alteration, modification, copying or reverse engineering.
6. Renesas Electronics products are classified according to the following two quality grades: "Standard" and "High Quality". The intended applications for each Renesas Electronics product depends on the product's quality grade, as indicated below.
 - "Standard": Computers; office equipment; communications equipment; test and measurement equipment; audio and visual equipment; home electronic appliances; machine tools; personal electronic equipment; industrial robots; etc.
 - "High Quality": Transportation equipment (automobiles, trains, ships, etc.); traffic control (traffic lights); large-scale communication equipment; key financial terminal systems; safety control equipment; etc.
- Unless expressly designated as a high reliability product or a product for harsh environments in a Renesas Electronics data sheet or other Renesas Electronics document, Renesas Electronics products are not intended or authorized for use in products or systems that may pose a direct threat to human life or bodily injury (artificial life support devices or systems; surgical implantations; etc.), or may cause serious property damage (space system; undersea repeaters; nuclear power control systems; aircraft control systems; key plant systems; military equipment; etc.). Renesas Electronics disclaims any and all liability for any damages or losses incurred by you or any third parties arising from the use of any Renesas Electronics product that is inconsistent with any Renesas Electronics data sheet, user's manual or other Renesas Electronics document.
7. No semiconductor product is absolutely secure. Notwithstanding any security measures or features that may be implemented in Renesas Electronics hardware or software products, Renesas Electronics shall have absolutely no liability arising out of any vulnerability or security breach, including but not limited to any unauthorized access to or use of a Renesas Electronics product or a system that uses a Renesas Electronics product. RENESAS ELECTRONICS DOES NOT WARRANT OR GUARANTEE THAT RENESAS ELECTRONICS PRODUCTS, OR ANY SYSTEMS CREATED USING RENESAS ELECTRONICS PRODUCTS WILL BE INVULNERABLE OR FREE FROM CORRUPTION, ATTACK, VIRUSES, INTERFERENCE, HACKING, DATA LOSS OR THEFT, OR OTHER SECURITY INTRUSION ("Vulnerability Issues"). RENESAS ELECTRONICS DISCLAIMS ANY AND ALL RESPONSIBILITY OR LIABILITY ARISING FROM OR RELATED TO ANY VULNERABILITY ISSUES. FURTHERMORE, TO THE EXTENT PERMITTED BY APPLICABLE LAW, RENESAS ELECTRONICS DISCLAIMS ANY AND ALL WARRANTIES, EXPRESS OR IMPLIED, WITH RESPECT TO THIS DOCUMENT AND ANY RELATED OR ACCOMPANYING SOFTWARE OR HARDWARE, INCLUDING BUT NOT LIMITED TO THE IMPLIED WARRANTIES OF MERCHANTABILITY, OR FITNESS FOR A PARTICULAR PURPOSE.
8. When using Renesas Electronics products, refer to the latest product information (data sheets, user's manuals, application notes, "General Notes for Handling and Using Semiconductor Devices" in the reliability handbook, etc.), and ensure that usage conditions are within the ranges specified by Renesas Electronics with respect to maximum ratings, operating power supply voltage range, heat dissipation characteristics, installation, etc. Renesas Electronics disclaims any and all liability for any malfunctions, failure or accident arising out of the use of Renesas Electronics products outside of such specified ranges.
9. Although Renesas Electronics endeavors to improve the quality and reliability of Renesas Electronics products, semiconductor products have specific characteristics, such as the occurrence of failure at a certain rate and malfunctions under certain use conditions. Unless designated as a high reliability product or a product for harsh environments in a Renesas Electronics data sheet or other Renesas Electronics document, Renesas Electronics products are not subject to radiation resistance design. You are responsible for implementing safety measures to guard against the possibility of bodily injury, injury or damage caused by fire, and/or danger to the public in the event of a failure or malfunction of Renesas Electronics products, such as safety design for hardware and software, including but not limited to redundancy, fire control and malfunction prevention, appropriate treatment for aging degradation or any other appropriate measures. Because the evaluation of microcomputer software alone is very difficult and impractical, you are responsible for evaluating the safety of the final products or systems manufactured by you.
10. Please contact a Renesas Electronics sales office for details as to environmental matters such as the environmental compatibility of each Renesas Electronics product. You are responsible for carefully and sufficiently investigating applicable laws and regulations that regulate the inclusion or use of controlled substances, including without limitation, the EU RoHS Directive, and using Renesas Electronics products in compliance with all these applicable laws and regulations. Renesas Electronics disclaims any and all liability for damages or losses occurring as a result of your noncompliance with applicable laws and regulations.
11. Renesas Electronics products and technologies shall not be used for or incorporated into any products or systems whose manufacture, use, or sale is prohibited under any applicable domestic or foreign laws or regulations. You shall comply with any applicable export control laws and regulations promulgated and administered by the governments of any countries asserting jurisdiction over the parties or transactions.
12. It is the responsibility of the buyer or distributor of Renesas Electronics products, or any other party who distributes, disposes of, or otherwise sells or transfers the product to a third party, to notify such third party in advance of the contents and conditions set forth in this document.
13. This document shall not be reprinted, reproduced or duplicated in any form, in whole or in part, without prior written consent of Renesas Electronics.
14. Please contact a Renesas Electronics sales office if you have any questions regarding the information contained in this document or Renesas Electronics products.

(Note1) "Renesas Electronics" as used in this document means Renesas Electronics Corporation and also includes its directly or indirectly controlled subsidiaries.

(Note2) "Renesas Electronics product(s)" means any product developed or manufactured by or for Renesas Electronics.

(Rev.5.0-1 October 2020)

Corporate Headquarters

TOYOSU FORESIA, 3-2-24 Toyosu,
Koto-ku, Tokyo 135-0061, Japan
www.renesas.com

Trademarks

Renesas and the Renesas logo are trademarks of Renesas Electronics Corporation. All trademarks and registered trademarks are the property of their respective owners.

Contact information

For further information on a product, technology, the most up-to-date version of a document, or your nearest sales office, please visit:
www.renesas.com/contact/.