

# SLG59M1685C

## A Low Power, 10 mΩ, 2 A, 0.82 mm<sup>2</sup> WLCSP Load Switch with Multiple Protection Features

### General Description

The SLG59M1685C is a self-powered, high-performance, 2 A capable, single-channel load switch designed for high-side power control applications up to 2 A. This feature-rich nFET load switch has been performance-optimized for all small form-factor, battery-powered applications including smartphones, tablet/notebook PCs, and GPS devices.

Operating from 1.3 V to 3.6 V supplies, the SLG59M1685C's RDS<sub>ON</sub> is 10 mΩ and its protection-feature set includes V<sub>IN</sub> undervoltage lockout, two-level current-limit, thermal shutdown, and fast V<sub>OUT</sub> discharge. With a fixed V<sub>OUT</sub> slew rate of 2.7 V/ms (adjustable via metal mask from 0.3 V/ms to 10 V/ms), inrush currents at V<sub>IN</sub> are predictable and the load switch is designed to drive C<sub>LOADS</sub> up to 500 μF.

Using Renesas's proprietary MOSFET IP, the SLG59M1685C achieves a stable RDS<sub>ON</sub> across a wide input voltage range. Fully specified over the -40 °C to 85 °C temperature range, this advanced nFET load switch is available in a 6-ball WLCSP measuring 0.71 mm x 1.16 mm x 0.5 mm with 0.35mm pitch.

### Pin Configuration

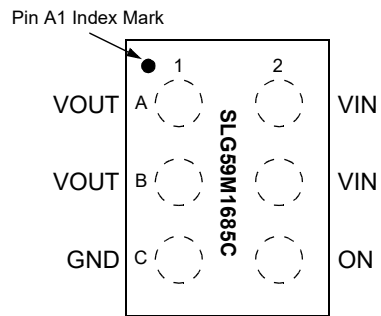

**6L WLCSP**  
(Laser Marking View)

### Features

- High-performance nFET Design:
  - Low Typical RDS<sub>ON</sub>: 10 mΩ
- Steady-state Operating Current: 2 A
- Operating V<sub>IN</sub> Range: 1.3 V ≤ V<sub>IN</sub> ≤ 3.6 V
- Fixed V<sub>OUT</sub> Slew Rate: 2.7 V/ms at V<sub>IN</sub> = 3.6 V
- Two-stage Overcurrent Protection
  - Fixed 2.7 A Active Current Limit
  - Fixed 0.7 A Short-circuit Current Limit
- Fast V<sub>OUT</sub> Discharge
- Thermal Shutdown Protection
- ON/OFF Control: Active HIGH
- Pb-Free / Halogen-Free / RoHS compliant WLCSP
  - 6 pin 0.71 mm x 1.16 mm, 0.35 mm pitch

### Applications

- Smartphones
- Tablet and Notebook PCs
- GPS Devices
- Portable POS Terminals
- Portable Bar-code Scanners

### Block Diagram

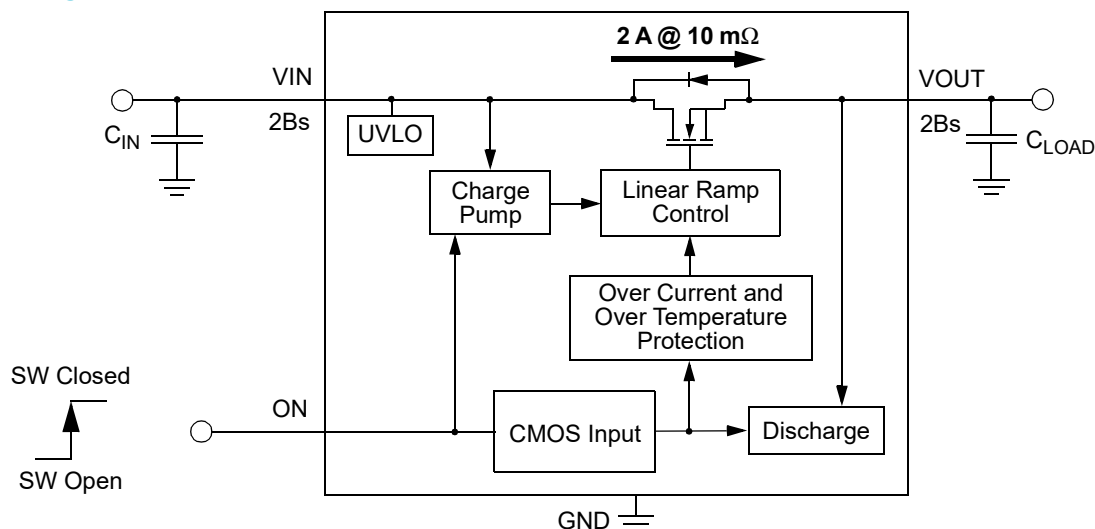

## SLG59M1685C

A Low Power, 10 mΩ, 2 A, 0.82 mm<sup>2</sup> WLCSP  
Load Switch with Multiple Protection Features

### Pin Description

Pin #	Pin Name	Type	Pin Description
A2, B2	VIN	Power/ MOSFET	With an internal 1.07 V $V_{IN(UVLO)}$ threshold, VIN supplies the power for the operation of the IC's internal control circuitry. This terminal is also the drain terminal connection of the n-channel MOSFET. Connect a 1 μF (or larger) low-ESR capacitor from this pin to ground. Capacitors used at the VIN terminal should be rated at 10 V or higher.
A1, B1	VOUT	MOSFET	Source terminal connections of the n-channel MOSFET. Connect a low-ESR capacitor from this pin to ground and consult the Electrical Characteristics table for recommended $C_{LOAD}$ range. Capacitors used at VOUT should be rated at 10 V or higher.
C2	ON	Input	A low-to-high transition on this pin initiates the operation of the SLG59M1685C's state machine. ON is an asserted HIGH, level-sensitive CMOS input with $ON_{V_{IL}} < 0.25$ V and $ON_{V_{IH}} > 0.85$ V. While there is an internal pull-down circuit to GND (~6 MΩ), connect this pin to a general-purpose output (GPO) of a microcontroller, an application processor, or a system controller.
C1	GND	GND	Ground connection. Connect this pin to system analog or power ground plane.

### Ordering Information

Part Number	Type	Production Flow
SLG59M1685C	WLCSP 6L	Industrial, -40 °C to 85 °C
SLG59M1685CTR	WLCSP 6L (Tape and Reel)	Industrial, -40 °C to 85 °C

## SLG59M1685C

A Low Power, 10 mΩ, 2 A, 0.82 mm<sup>2</sup> WLCSP  
Load Switch with Multiple Protection Features

### Absolute Maximum Ratings

Parameter	Description	Conditions	Min.	Typ.	Max.	Unit
V <sub>IN</sub> to GND	Load Switch Input Voltage to GND		-0.3	--	5	V
V <sub>OUT</sub> to GND	Load Switch Output Voltage to GND		-0.3	--	5	V
ON to GND	ON Pin Voltage to GND		-0.3	--	5	V
T <sub>S</sub>	Storage Temperature		-65	--	150	°C
ESD <sub>HBM</sub>	ESD Protection	Human Body Model	TBD	--	--	V
ESD <sub>CDM</sub>	ESD Protection	Charged Device Model	TBD	--	--	V
MSL	Moisture Sensitivity Level		1			
θ <sub>JA</sub>	Package Thermal Resistance, Junction-to-Ambient	0.71 x 1.16 mm 6L WLCSP; Determined using 0.5 in <sup>2</sup> , 1 oz .copper pads under each VIN and VOUT terminal and FR4 pcb material.	--	84	--	°C/W
T <sub>J,MAX</sub>	Maximum Junction Temperature		--	150	--	°C
MOSFET IDS <sub>PK</sub>	Peak Current from VIN to VOUT	Maximum pulsed switch current, pulse width < 1 ms, 1% duty cycle	--	--	4	A

Note: Stresses greater than those listed under "Absolute Maximum Ratings" may cause permanent damage to the device. This is a stress rating only and functional operation of the device at these or any other conditions above those indicated in the operational sections of this specification is not implied. Exposure to absolute maximum rating conditions for extended periods may affect reliability.

### Electrical Characteristics

1.3 V ≤ V<sub>IN</sub> ≤ 3.6 V; T<sub>A</sub> = -40 °C to 85 °C, unless otherwise noted. Typical values are at T<sub>A</sub> = 25 °C

Parameter	Description	Conditions	Min.	Typ.	Max.	Unit
V <sub>IN</sub>	Power Supply and MOSFET Input (Drain) Voltage		1.3	--	3.6	V
V <sub>IN(UVLO)</sub>	V <sub>IN</sub> Rising Undervoltage Lockout Threshold	V <sub>IN</sub> ↑	0.95	1.07	1.29	V
	V <sub>IN</sub> Falling Undervoltage Lockout Threshold	V <sub>IN</sub> ↓	0.90	1.04	1.22	V
I <sub>IN</sub>	Quiescent Supply Current	V <sub>IN</sub> = 1.3 V; ON = HIGH; No load	--	66	83	μA
		V <sub>IN</sub> = 3.6 V; ON = HIGH; No load	--	83	100	μA
I <sub>IN(OFF)</sub>	OFF Mode Supply Current	1.3 ≤ V <sub>IN</sub> ≤ 3.6 V; ON = LOW; No load	--	0.005	2.2	μA
MOSFET IDS	Current from VIN to VOUT	Continuous	--	--	2	A
RDS <sub>ON</sub>	ON Resistance	T <sub>A</sub> = 25 °C; 1.3 ≤ V <sub>IN</sub> ≤ 3.6 V; I <sub>DS</sub> = 0.1 A	--	10	13	mΩ
		T <sub>A</sub> = 85 °C; 1.3 ≤ V <sub>IN</sub> ≤ 3.6 V; I <sub>DS</sub> = 0.1 A	--	12	16	mΩ
I <sub>FET_OFF</sub>	MOSFET OFF Leakage Current	1.3 ≤ V <sub>IN</sub> ≤ 3.6 V; V <sub>OUT</sub> = GND; ON = LOW	--	0.005	2.2	μA
I <sub>LIMIT</sub>	Active Current Limit, I <sub>ACL</sub>	V <sub>OUT</sub> > 0.25 V	2.05	2.7	3.5	A
	Short-circuit Current Limit, I <sub>SCL</sub>	V <sub>OUT</sub> < 0.25 V	--	0.7	--	A
T <sub>ACL</sub>	Active Current Limit Response Time	I <sub>DS</sub> > I <sub>ACL</sub>	--	10	--	μs

## SLG59M1685C

A Low Power, 10 mΩ, 2 A, 0.82 mm<sup>2</sup> WLCSP  
Load Switch with Multiple Protection Features

### Electrical Characteristics (continued)

1.3 V ≤ V<sub>IN</sub> ≤ 3.6 V; T<sub>A</sub> = -40 °C to 85 °C, unless otherwise noted. Typical values are at T<sub>A</sub> = 25 °C

Parameter	Description	Conditions	Min.	Typ.	Max.	Unit
T <sub>SCL</sub>	Short-Circuit Current Limit Response Time	I <sub>DS</sub> > I <sub>SCL</sub>	--	1.5	--	μs
T <sub>ON_Delay</sub>	ON Delay Time	50% ON to 10% V <sub>OUT</sub> ↑; V <sub>IN</sub> = 1.3 V; R <sub>LOAD</sub> = 10 Ω, C <sub>LOAD</sub> = 30 μF	0.75	1.05	1.5	ms
		50% ON to 10% V <sub>OUT</sub> ↑; V <sub>IN</sub> = 3.6 V; R <sub>LOAD</sub> = 10 Ω, C <sub>LOAD</sub> = 30 μF	0.65	1.0	1.4	ms
V <sub>OUT(SR)</sub>	Slew Rate	10% V <sub>OUT</sub> to 90% V <sub>OUT</sub> ↑; V <sub>IN</sub> = 1.3 V; R <sub>LOAD</sub> = 10 Ω, C <sub>LOAD</sub> = 30 μF	0.98	1.7	2.65	V/ms
		10% V <sub>OUT</sub> to 90% V <sub>OUT</sub> ↑; V <sub>IN</sub> = 3.6 V; R <sub>LOAD</sub> = 10 Ω, C <sub>LOAD</sub> = 30 μF	1.55	2.7	4.2	V/ms
T <sub>Total_ON</sub>	Total Turn On Time	50% ON to 90% V <sub>OUT</sub> ↑; V <sub>IN</sub> = 1.3 V; R <sub>LOAD</sub> = 10 Ω, C <sub>LOAD</sub> = 30 μF	1.1	1.6	2.2	ms
		50% ON to 90% V <sub>OUT</sub> ↑; V <sub>IN</sub> = 3.6 V; R <sub>LOAD</sub> = 10 Ω, C <sub>LOAD</sub> = 30 μF	1.45	2.1	2.7	ms
T <sub>OFF_Delay</sub>	OFF Delay Time	50% ON to V <sub>OUT</sub> Fall Start; V <sub>IN</sub> = 1.3 V; R <sub>LOAD</sub> = 10 Ω, no C <sub>LOAD</sub>	9.5	25	40	μs
		50% ON to V <sub>OUT</sub> Fall Start; V <sub>IN</sub> = 3.6 V; R <sub>LOAD</sub> = 10 Ω, no C <sub>LOAD</sub>	5.5	9	12	μs
C <sub>LOAD</sub>	Output Load Capacitance	C <sub>LOAD</sub> connected from V <sub>OUT</sub> to GND	--	30	500	μF
R <sub>DISCHRG</sub>	Output Discharge Resistance	1.3 ≤ V <sub>IN</sub> ≤ 3.6 V; V <sub>OUT</sub> < 0.4 V	--	160	210	Ω
ON_V <sub>IH</sub>	ON Pin Input High Voltage		0.85	--	V <sub>IN</sub>	V
ON_V <sub>IL</sub>	ON Pin Input Low Voltage		-0.3	0	0.25	V
THERM <sub>ON</sub>	Thermal Protection Shutdown Threshold		--	135	--	°C
THERM <sub>OFF</sub>	Thermal Protection Restart Threshold		--	115	--	°C
THERM <sub>OFF</sub>	Thermal Protection Hysteresis		--	20	--	°C

SLG59M1685C

A Low Power, 10 mΩ, 2 A, 0.82 mm<sup>2</sup> WLCSP Load Switch with Multiple Protection Features

$T_{Total\_ON}$ ,  $T_{ON\_Delay}$  and Slew Rate Measurement

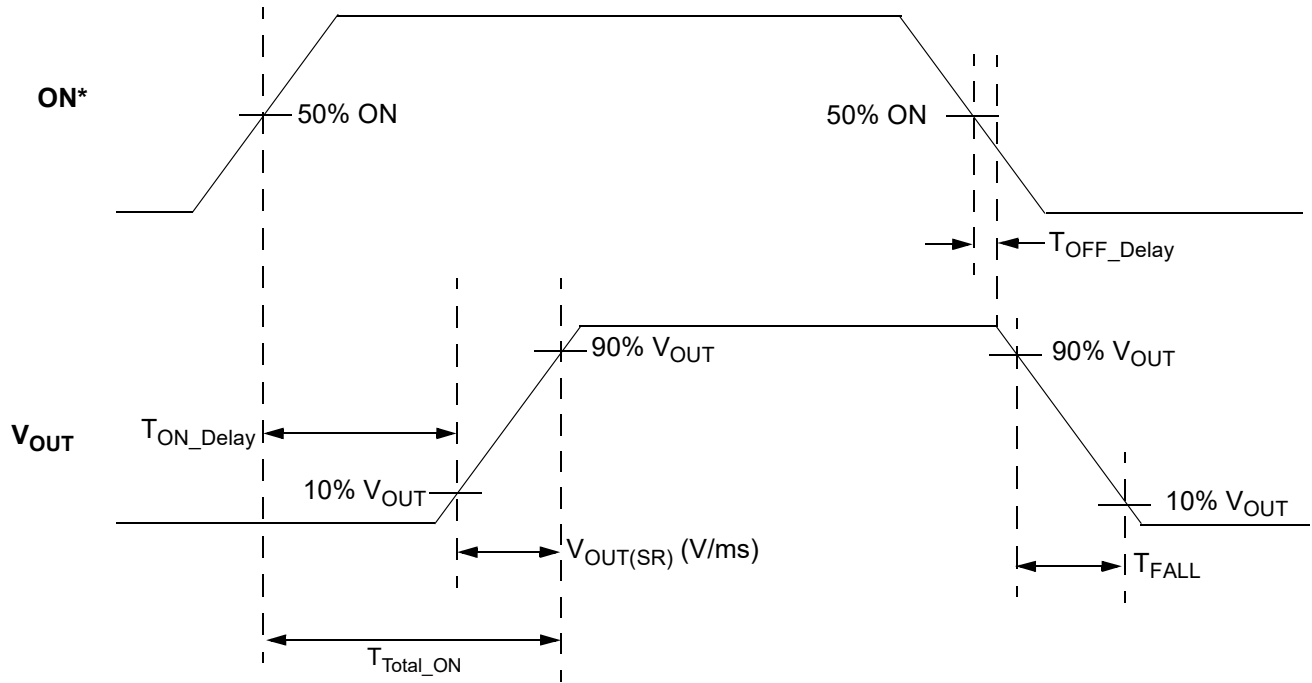

# SLG59M1685C

A Low Power, 10 mΩ, 2 A, 0.82 mm<sup>2</sup> WLCSP Load Switch with Multiple Protection Features

## Typical Performance Characteristics

### RDS<sub>ON</sub> vs. Temperature, and V<sub>IN</sub>

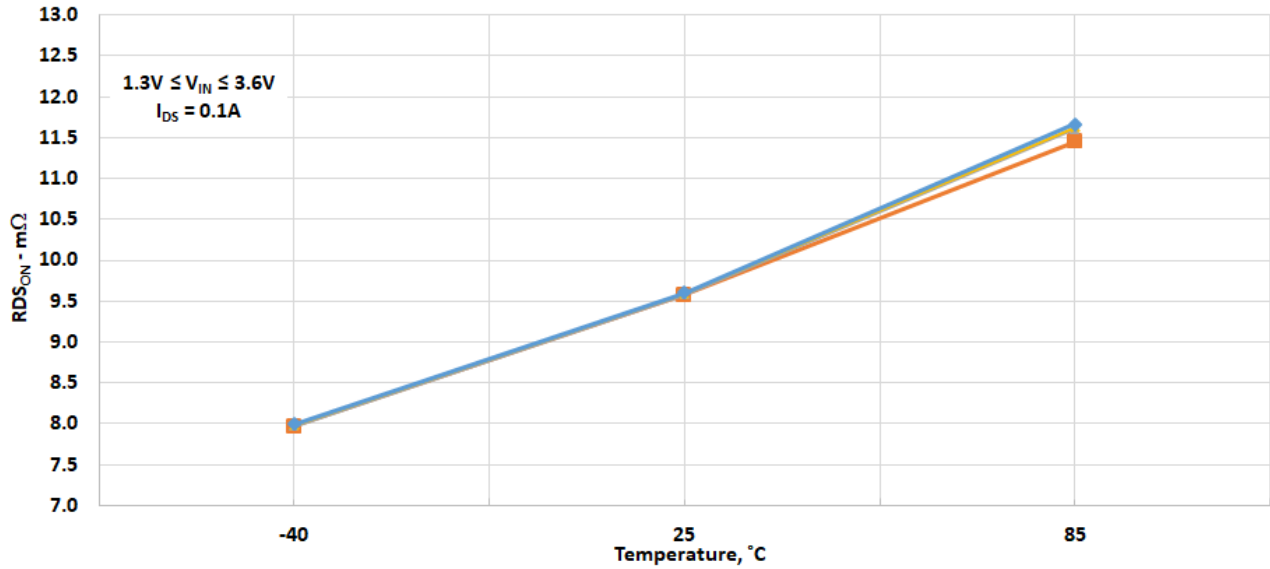

### RDS<sub>ON</sub> vs. I<sub>DS</sub>, and V<sub>IN</sub>

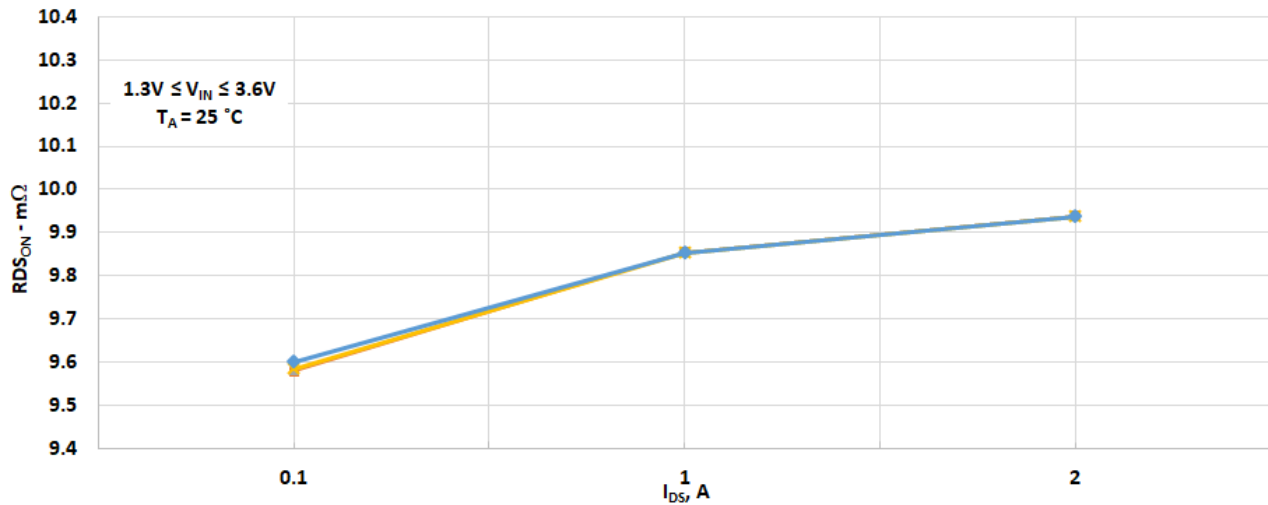

SLG59M1685C

A Low Power, 10 mΩ, 2 A, 0.82 mm<sup>2</sup> WLCSP Load Switch with Multiple Protection Features

I<sub>IN</sub> vs. V<sub>IN</sub> and Temperature

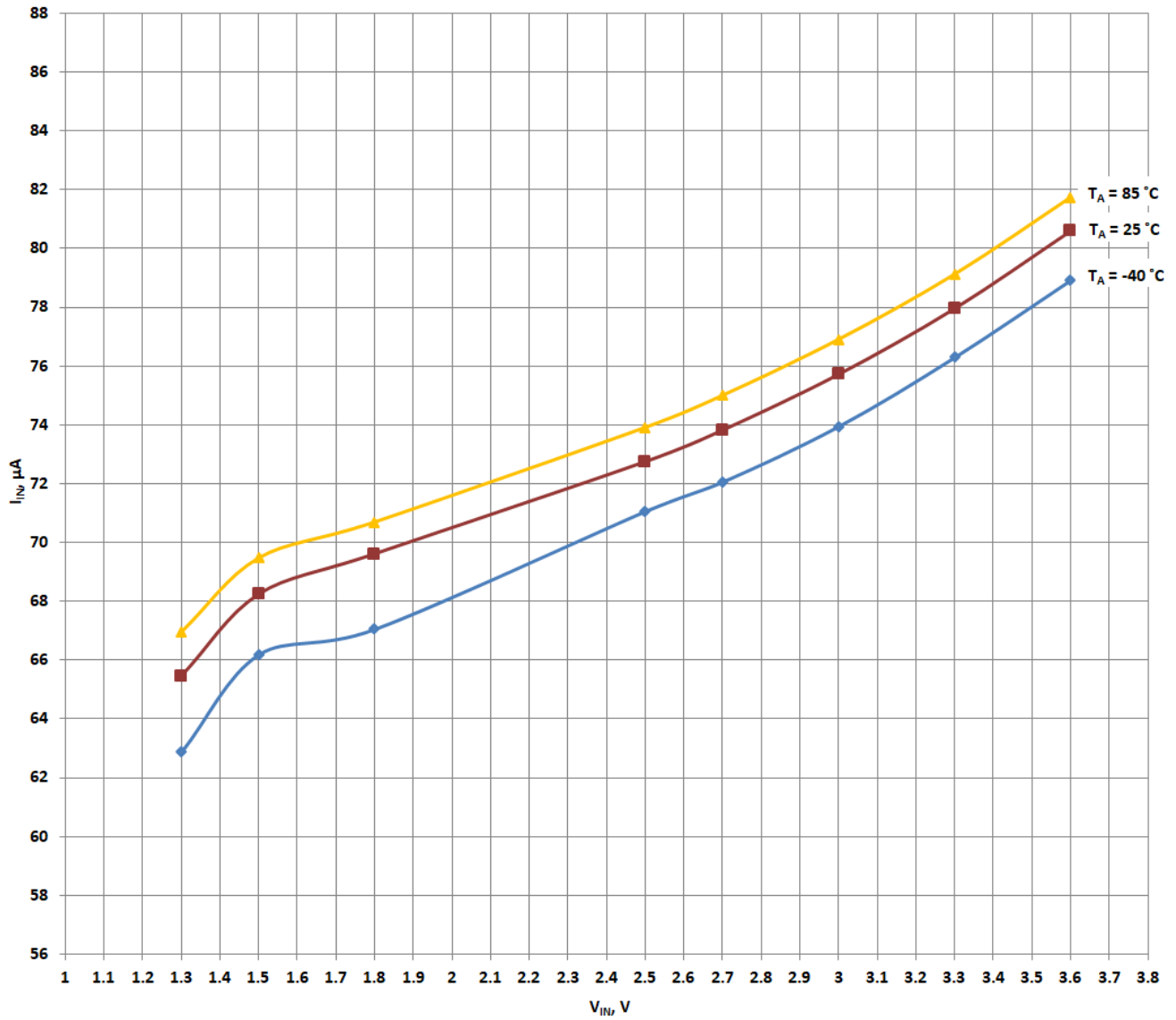

SLG59M1685C

A Low Power, 10 mΩ, 2 A, 0.82 mm<sup>2</sup> WLCSP Load Switch with Multiple Protection Features

$I_{IN(OFF)}$  vs.  $V_{IN}$  and Temperature

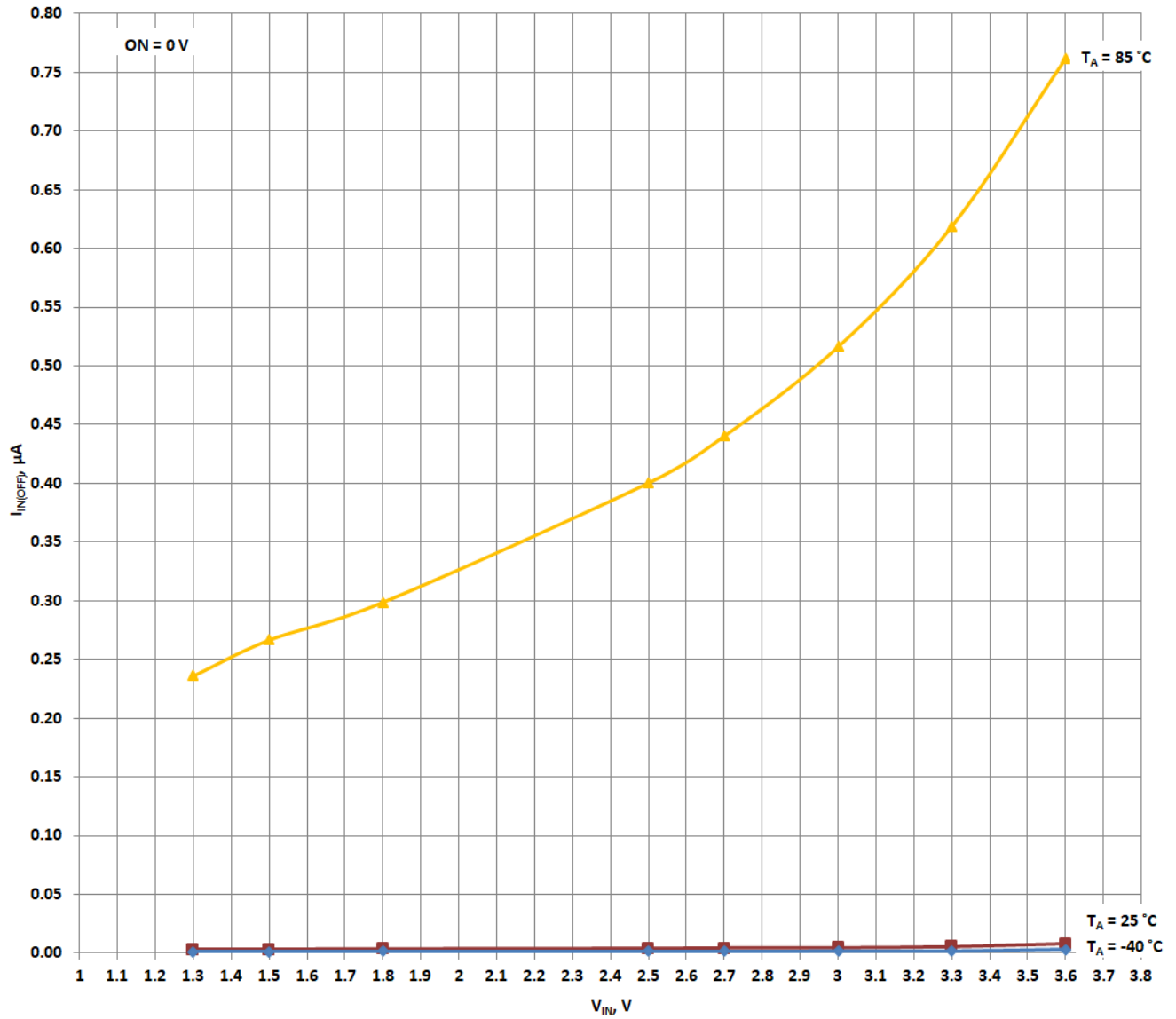



SLG59M1685C

A Low Power, 10 mΩ, 2 A, 0.82 mm<sup>2</sup> WLCSP Load Switch with Multiple Protection Features

Timing Diagram - Active Current Limit & Thermal Protection Operation

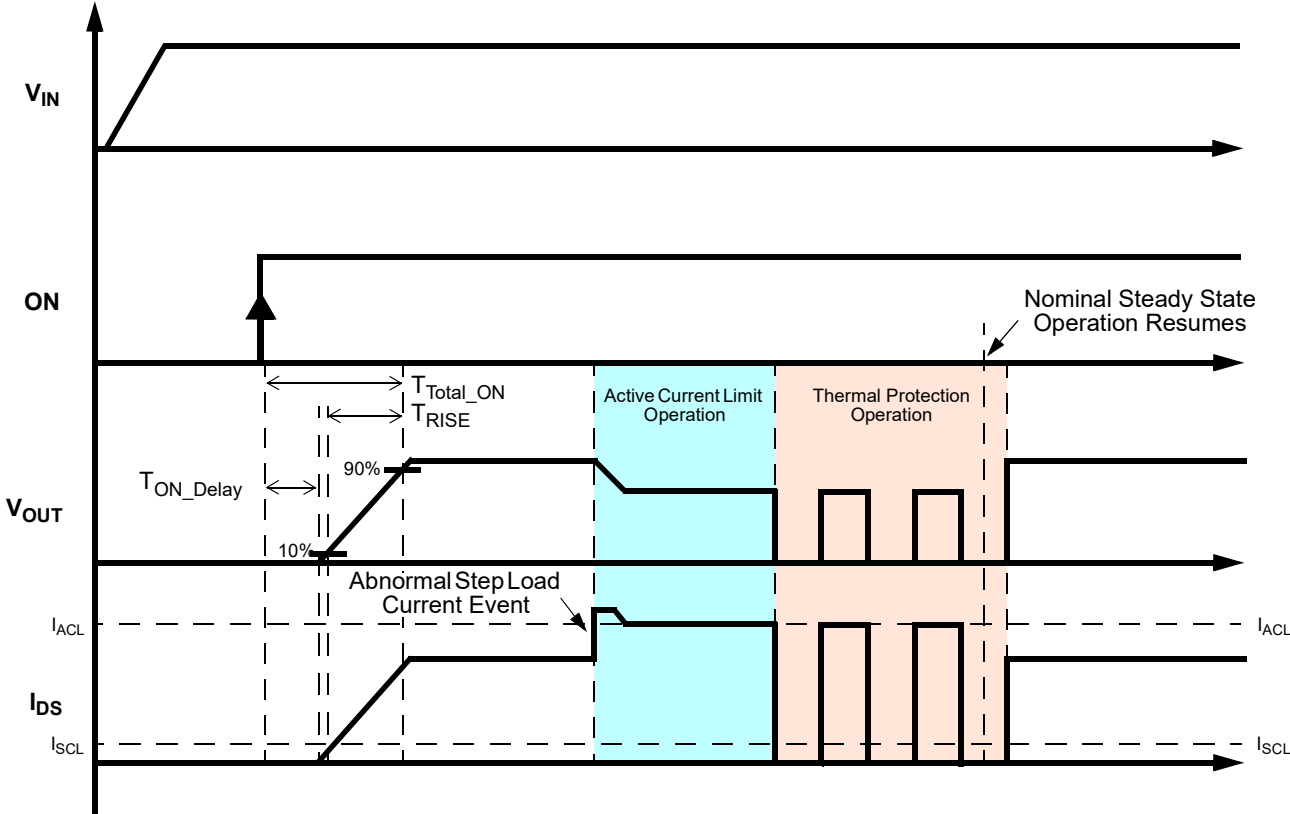

SLG59M1685C

A Low Power, 10 mΩ, 2 A, 0.82 mm<sup>2</sup> WLCSP Load Switch with Multiple Protection Features

Typical Turn-on Waveforms

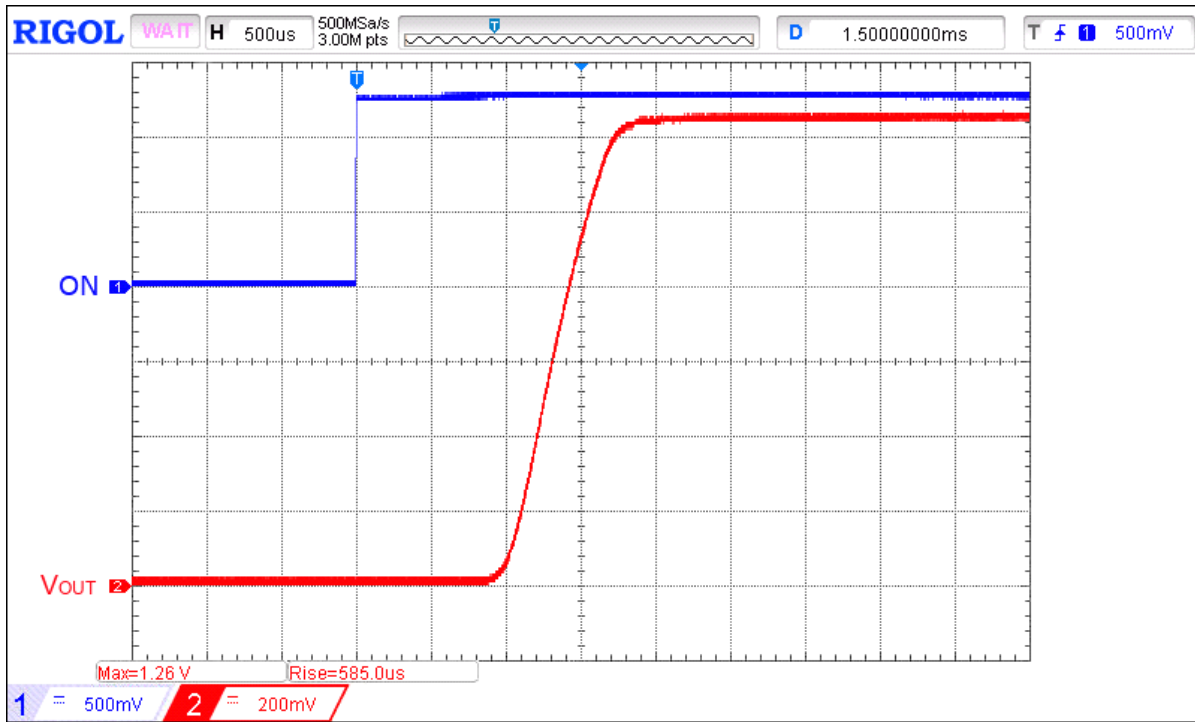

Figure 1. Typical Turn ON operation waveform for  $V_{IN} = 1.3\text{ V}$ ,  $C_{LOAD} = 30\ \mu\text{F}$ ,  $R_{LOAD} = 10\ \Omega$

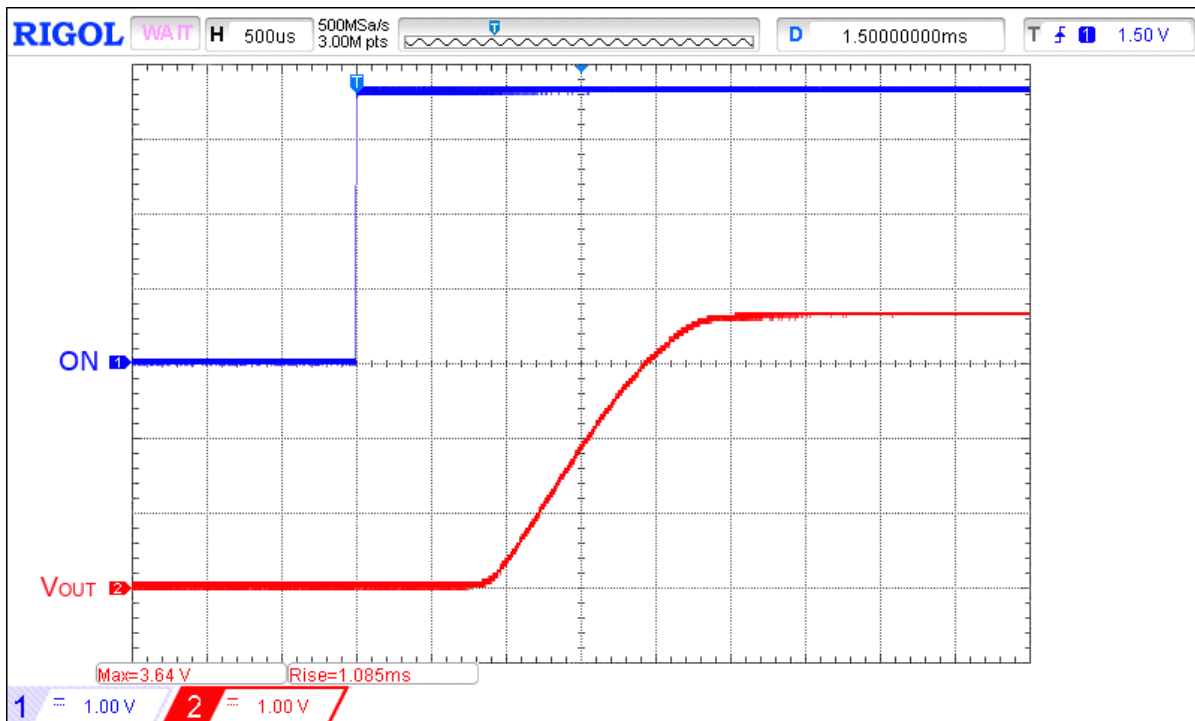

Figure 2. Typical Turn ON operation waveform for  $V_{IN} = 3.6\text{ V}$ ,  $C_{LOAD} = 30\ \mu\text{F}$ ,  $R_{LOAD} = 10\ \Omega$

SLG59M1685C

A Low Power, 10 mΩ, 2 A, 0.82 mm<sup>2</sup> WLCSP Load Switch with Multiple Protection Features

Typical Turn-off Waveforms

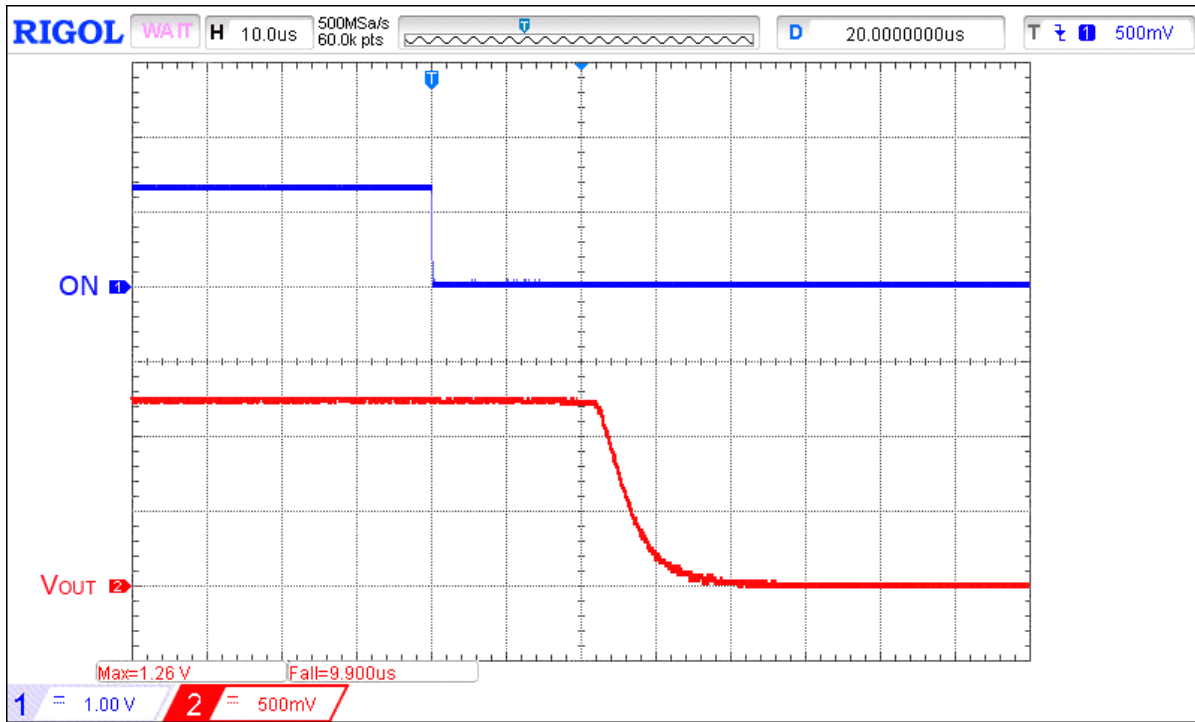

Figure 3. Typical Turn OFF operation waveform for  $V_{IN} = 1.3\text{ V}$ ,  $R_{LOAD} = 10\ \Omega$ , no  $C_{LOAD}$ .

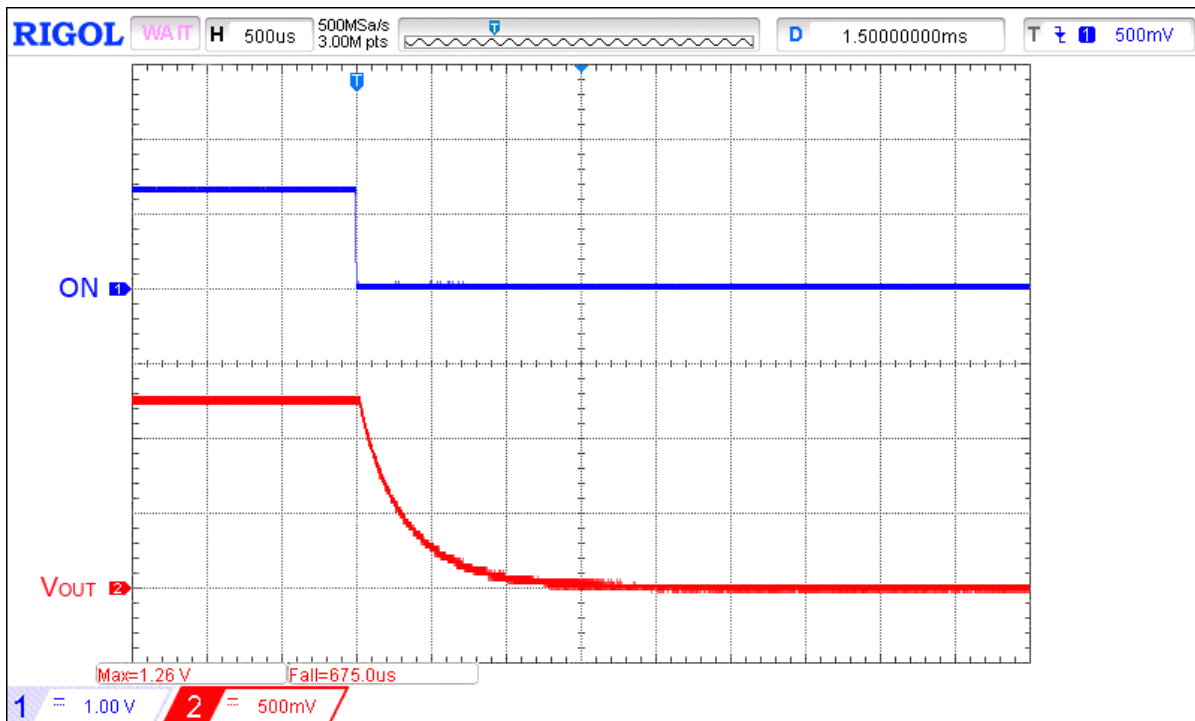

Figure 4. Typical Turn OFF operation waveform for  $V_{IN} = 1.3\text{ V}$ ,  $C_{LOAD} = 30\ \mu\text{F}$ ,  $R_{LOAD} = 10\ \Omega$

SLG59M1685C

A Low Power, 10 mΩ, 2 A, 0.82 mm<sup>2</sup> WLCSP Load Switch with Multiple Protection Features

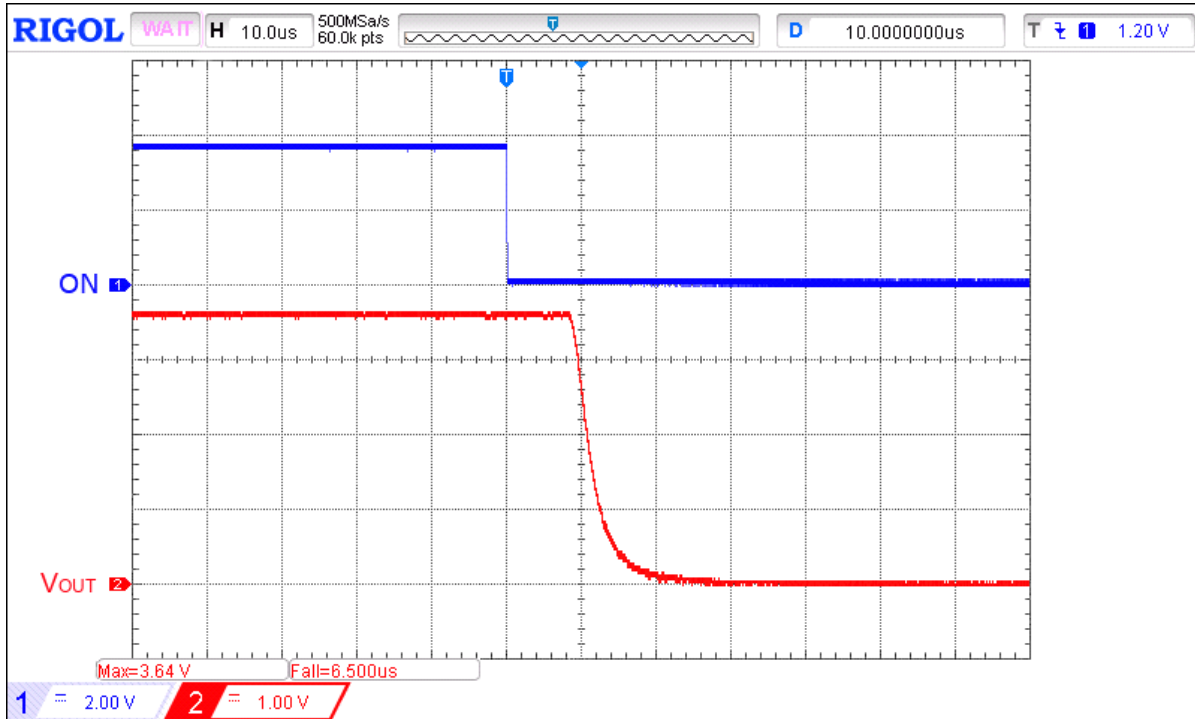

Figure 5. Typical Turn OFF operation waveform for  $V_{IN} = 3.6\text{ V}$ ,  $R_{LOAD} = 10\ \Omega$ , no  $C_{LOAD}$ .

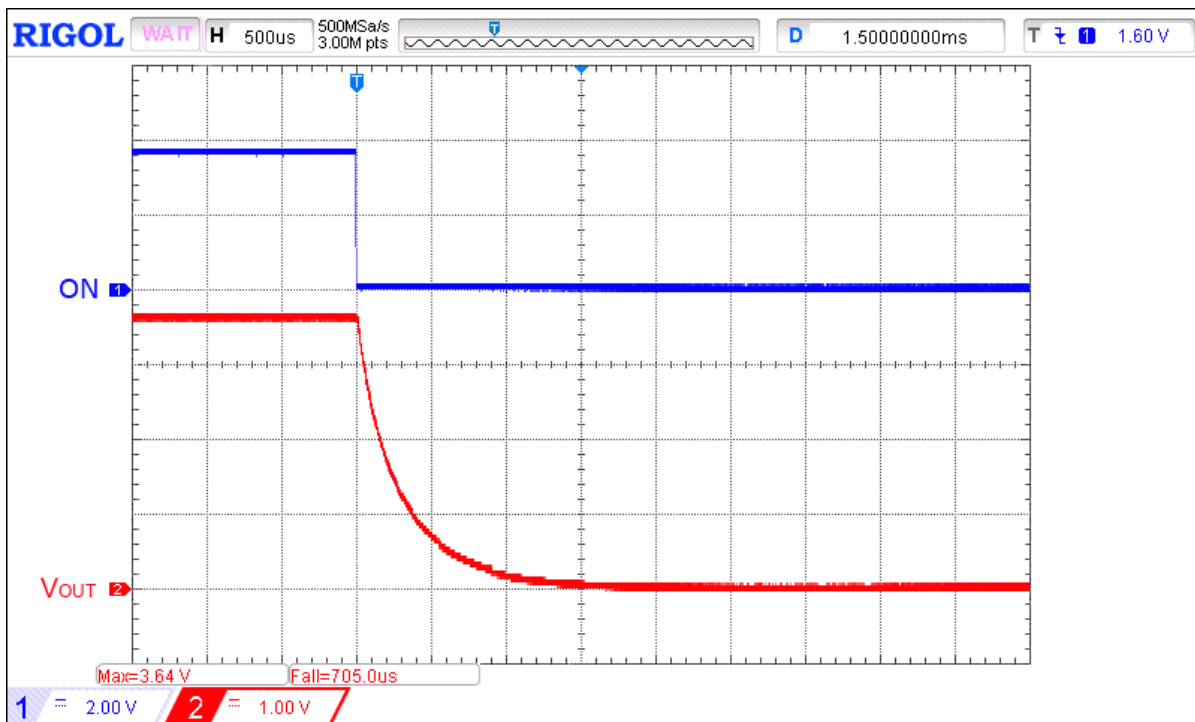

Figure 6. Typical Turn OFF operation waveform for  $V_{IN} = 3.6\text{ V}$ ,  $C_{LOAD} = 30\ \mu\text{F}$ ,  $R_{LOAD} = 10\ \Omega$

SLG59M1685C

A Low Power, 10 mΩ, 2 A, 0.82 mm<sup>2</sup> WLCSP Load Switch with Multiple Protection Features

Typical ACL and Thermal Protection Operation Waveform

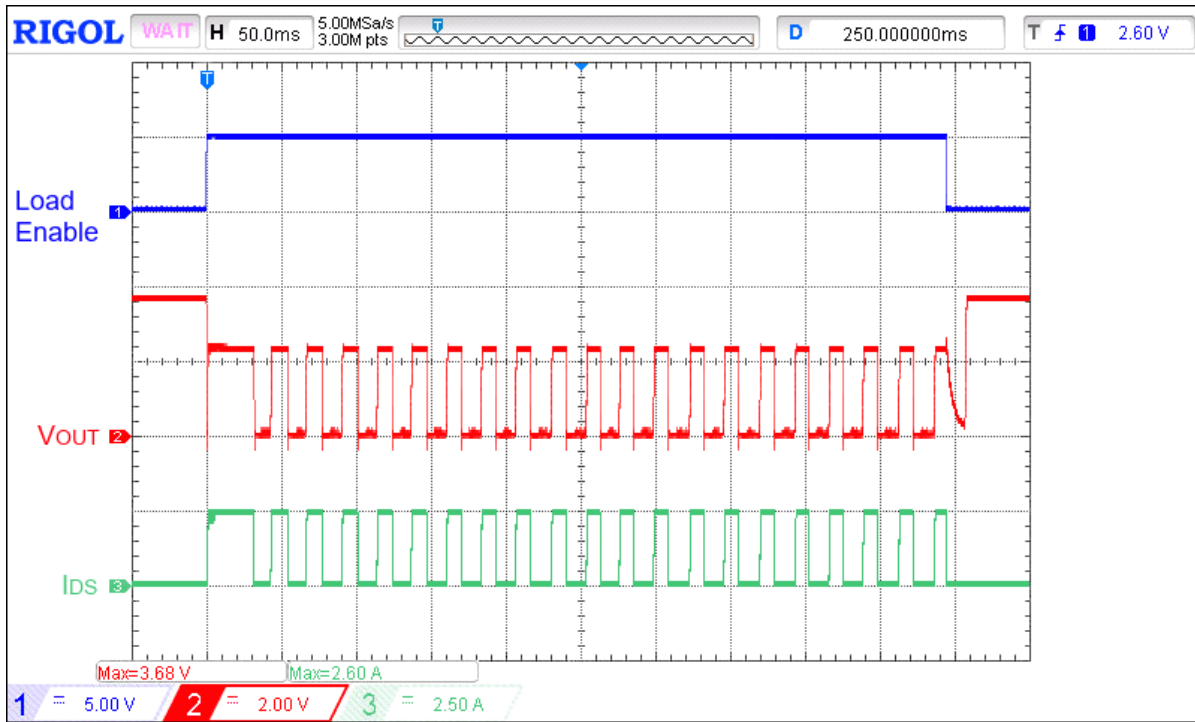

Figure 7. Typical ACL and Thermal Protection operation waveform for  $V_{IN} = 3.6\text{ V}$ ,  $C_{LOAD} = 30\text{ }\mu\text{F}$ ,  $R_{LOAD} = 0.5\text{ }\Omega$

## SLG59M1685C

A Low Power, 10 m $\Omega$ , 2 A, 0.82 mm<sup>2</sup> WLCSP Load Switch with Multiple Protection Features

### Applications Information

#### SLG59M1685C Power-Up/Power-Down Sequence Considerations

During power-up operation, the SLG59M1685C's internal circuitry is activated once  $V_{IN}$  reaches 1.07 V. Once  $V_{IN}$  has reached 90% of its steady-state value (and within the SLG59M1685C's nominal supply voltage range of 1.3 V to 3.6 V), the ON pin can then be toggled LOW-to-HIGH to close the switch.

A nominal power-up sequence is to apply  $V_{IN}$  first and then toggling the ON pin LOW-to-HIGH after  $V_{IN}$  is (at a minimum) > 1.07 V or at least 90% of its final value.

A nominal power-down sequence is the power-up sequence in reverse order.

If  $V_{IN}$  and ON are applied at the same time, a voltage glitch may appear on the output pin at  $V_{OUT}$ . To prevent glitches at the output, it is recommended to connect at least 1  $\mu$ F capacitor from the  $V_{OUT}$  pin to GND and to keep  $V_{IN}$  ramp times higher than 2 ms.

As illustrated in the typical performance transient scope captures, the  $V_{OUT}$  output follows a linear ramp when the load switch is turned on.

If ON and  $V_{IN}$  are tied together and powered up, the load switch can be turned on, but the behavior may differ from datasheet specifications.

#### SLG59M1685C Current Limiting Operation

The SLG59M1685C has two types of current limiting triggered by the output ( $V_{OUT}$ ) pin voltage.

##### 1. Standard Current Limiting Mode (with Thermal Shutdown Protection)

When  $V_{OUT} > 250$  mV, the output current is initially limited to the Active Current Limit ( $I_{ACL}$ ) specification listed in the Electrical Characteristics table. The ACL monitor's response time is very fast and is triggered within a few microseconds to sudden (transient) changes in load current. When a load current overload is detected, the ACL monitor increases the FET resistance to keep the current from exceeding the load switch's  $I_{ACL}$  threshold.

However, if a load-current overload condition persists where the die temperature rises because of the increased FET resistance, the load switch's internal Thermal Shutdown Protection circuit can be activated. If the die temperature exceeds the listed  $THERM_{ON}$  specification, the FET is shut OFF completely, thereby allowing the die to cool. When the die cools to the listed  $THERM_{OFF}$  temperature threshold, the FET is allowed to turn back on. This process may repeat as long as the output current overload condition persists.

##### 2. Short Circuit Current Limiting Mode (with Thermal Shutdown Protection)

When  $V_{OUT} < 250$  mV (which is the case with a hard short, such as a solder bridge on the power rail), the load switch's internal Short-circuit Current Limit (SCL) monitor limits the FET current to approximately 500 mA (the  $I_{SCL}$  threshold). While the internal Thermal Shutdown Protection circuit remains activated and since the  $I_{SCL}$  threshold is much lower than the  $I_{ACL}$  threshold, thermal shutdown protection may become activated only at higher ambient temperatures.

For more information on GreenFET load switch features, please visit our website and see App Note "AN-1068 GreenFET and High Voltage GreenFET Load Switch Basics".

## SLG59M1685C

A Low Power, 10 mΩ, 2 A, 0.82 mm<sup>2</sup> WLCSP  
Load Switch with Multiple Protection Features

### Power Dissipation

The junction temperature of the SLG59M1685C depends on different factors such as board layout, ambient temperature, and other environmental factors. The primary contributor to the increase in the junction temperature of the SLG59M1685C is the power dissipation of its power MOSFET. Its power dissipation and the junction temperature in nominal operating mode can be calculated using the following equations:

$$P_D = R_{DS(ON)} \times I_{DS}^2$$

$$P_D = R_{DS(ON)} \times I_{DS}^2 + V_{IN} \times I_{IN}$$

where:

$P_D$  = Power dissipation, in Watts (W)

$R_{DS(ON)}$  = Power MOSFET ON resistance, in Ohms (Ω)

$I_{DS}$  = Output current, in Amps (A)

$V_{IN}$  = Applied Supply Voltage, in Volts (V)

$I_{IN}$  = IC's Supply Current, in Amps (A)

and

$$T_J = P_D \times \theta_{JA} + T_A$$

where:

$T_J$  = Junction temperature, in Celsius degrees (°C)

$\theta_{JA}$  = Package thermal resistance, in Celsius degrees per Watt (°C/W)

$T_A$  = Ambient temperature, in Celsius degrees (°C)

In current-regulation mode, SLG59M1685C power dissipation can be calculated by taking into account the voltage drop across the load switch ( $V_{IN} - V_{OUT}$ ) and the magnitude of the output current in current-regulation mode ( $I_{ACL}$ ):

$$P_D = (V_{IN} - V_{OUT}) \times I_{ACL}$$

$$P_D = (V_{IN} - (R_{LOAD} \times I_{ACL})) \times I_{ACL}$$

where:

$P_D$  = Power dissipation, in Watts (W)

$V_{IN}$  = Input Voltage, in Volts (V)

$R_{LOAD}$  = Load Resistance, in Ohms (Ω)

$I_{ACL}$  = Output regulated current, in Amps (A)

$V_{OUT} = R_{LOAD} \times I_{ACL}$ , in Volts (V)

## SLG59M1685C

A Low Power, 10 mΩ, 2 A, 0.82 mm<sup>2</sup> WLCSP Load Switch with Multiple Protection Features

### Layout Guidelines:

1. Since the VIN and VOUT pins dissipate most of the heat generated during high-load current operation, it is highly recommended to make power traces as short, direct, and wide as possible. A good practice is to make power traces with an absolute minimum widths of 15 mils (0.381 mm) per Ampere. A representative layout, shown in [Figure 8](#), illustrates proper techniques for heat to transfer as efficiently as possible out of the device;
2. To minimize the effects of parasitic trace inductance on normal operation, it is recommended to connect input C<sub>IN</sub> and output C<sub>LOAD</sub> low-ESR capacitors as close as possible to the SLG59M1685C's VIN and VOUT pins;
3. The GND pin should be connected to system analog or power ground plane.

### SLG59M1685C Evaluation Board:

A GreenFET Evaluation Board for SLG59M1685C is designed according to the statements above and is illustrated on [Figure 8](#). Please note that evaluation board has D\_Sense and S\_Sense pads. They cannot carry high currents and dedicated only for RDS<sub>ON</sub> evaluation.

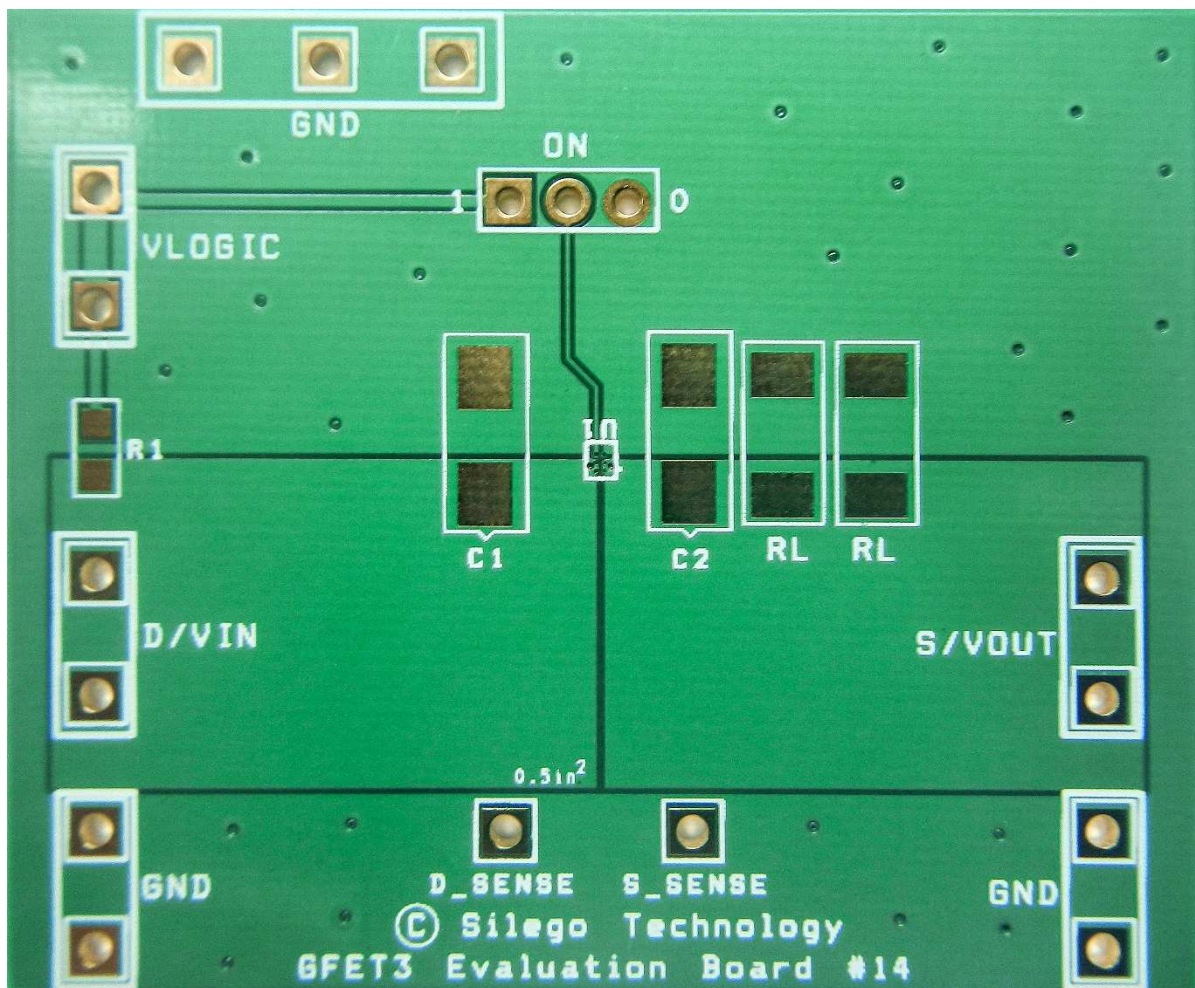

Figure 8. SLG59M1685C Evaluation Board.



## SLG59M1685C

A Low Power, 10 mΩ, 2 A, 0.82 mm<sup>2</sup> WLCSP Load Switch with Multiple Protection Features

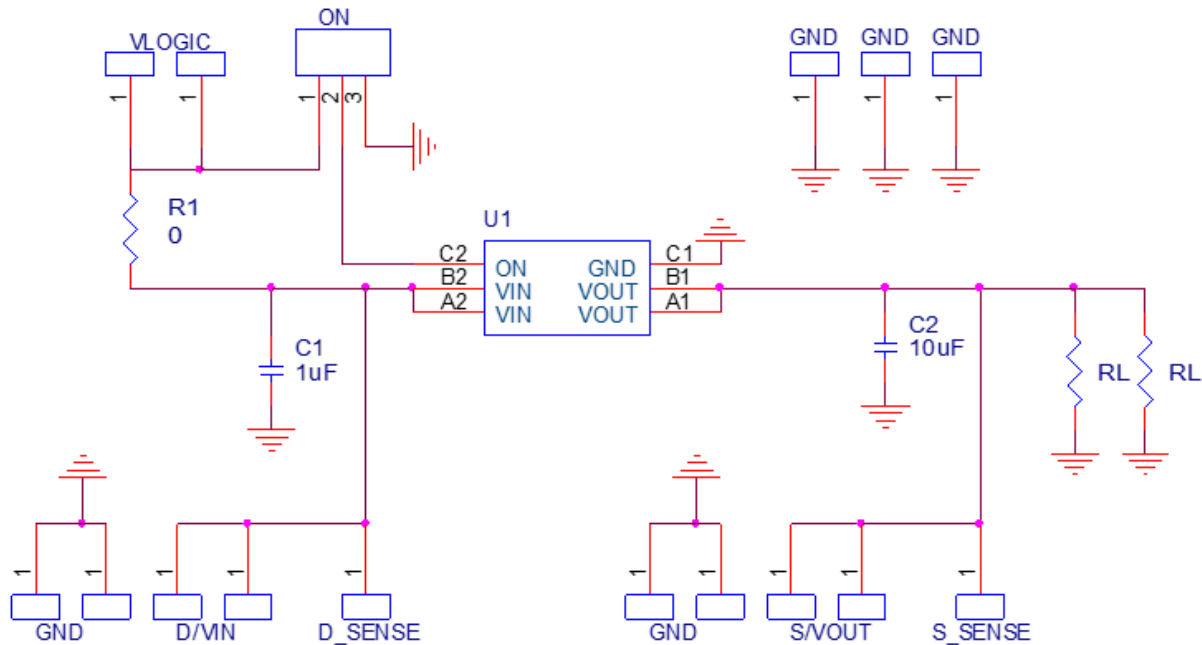

Figure 9. SLG59M1685C Evaluation Board Connection Circuit.

### Basic Test Setup and Connections

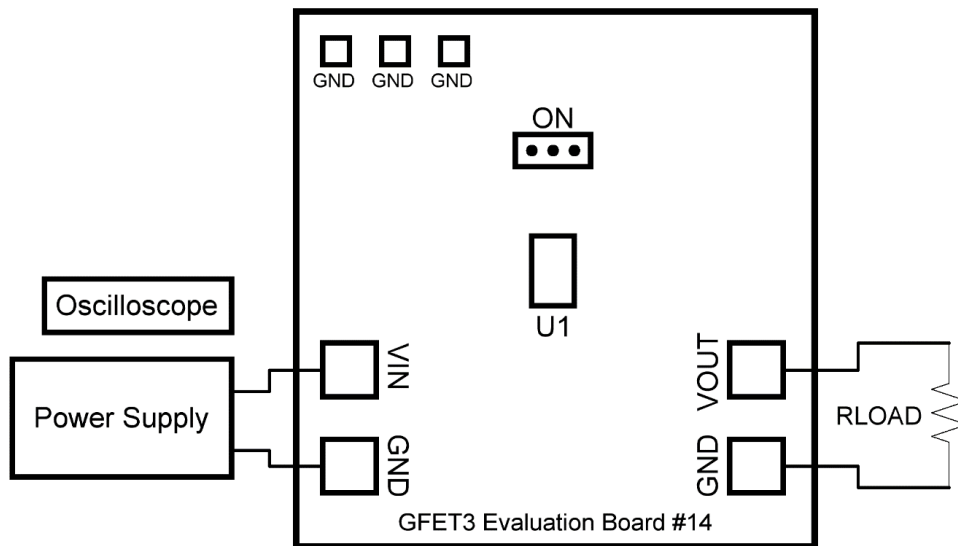

Figure 10. Typical connections for GreenFET Evaluation.

#### EVB Configuration

1. Connect oscilloscope probes to VIN, VOUT, ON, etc.;
2. Turn on Power Supply and set desired  $V_{IN}$  from 1.3 V...3.6 V range;
3. Toggle the ON signal High or Low to observe SLG59M1685C operation.

**SLG59M1685C**

A Low Power, 10 mΩ, 2 A, 0.82 mm<sup>2</sup> WLCSP  
Load Switch with Multiple Protection Features

**Package Top Marking System Definition**



NNN - Serial Number Code Field<sup>1</sup>

Note 1: Each character in code field can be alphanumeric A-Z and 0-9

# SLG59M1685C

A Low Power, 10 mΩ, 2 A, 0.82 mm<sup>2</sup> WLCSP  
Load Switch with Multiple Protection Features

## Package Drawing and Dimensions

6 Pin WLCSP Green Package 0.71 x 1.16 mm

### Laser Marking View

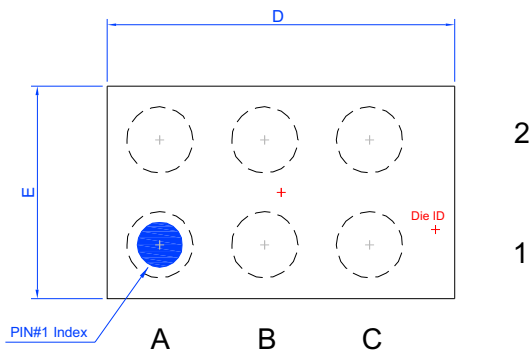

### Bump View

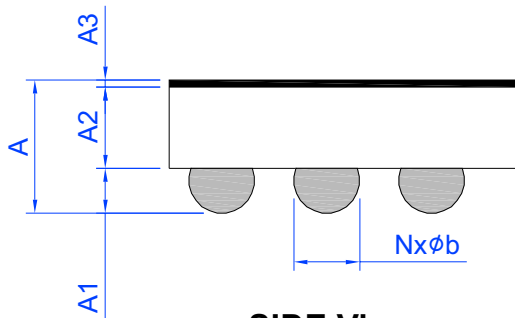
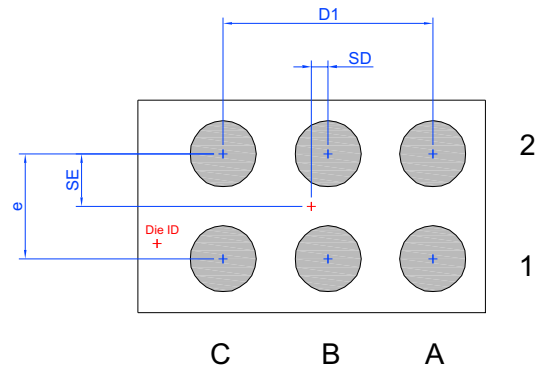

### SIDE View

UNIT: mm							
Symbol	Min.	Nom.	Max.	Symbol	Min.	Nom.	Max.
A	0.390	0.445	0.500	D	1.130	1.160	1.190
A1	0.125	0.150	0.175	E	0.680	0.710	0.740
A2	0.245	0.270	0.295	e	0.35 BSC		
A3	0.020	0.025	0.030	D1	0.70 BSC		
b	0.195	0.220	0.245	SD	0.055 BSC		
N	6 (bump)			SE	0.175 BSC		

**SLG59M1685C**

A Low Power, 10 mΩ, 2 A, 0.82 mm<sup>2</sup> WLCSP  
Load Switch with Multiple Protection Features

**SLG59M1685C 6 Pin WLCSP PCB Landing Pattern**

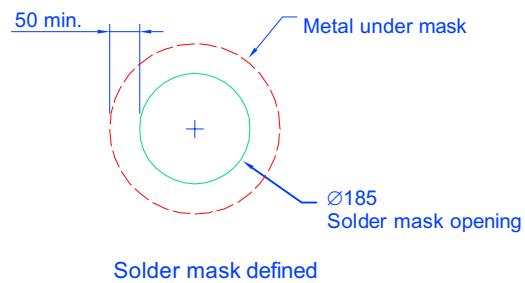
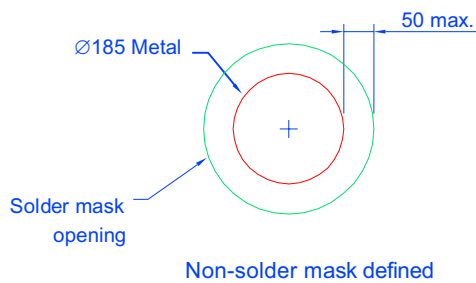
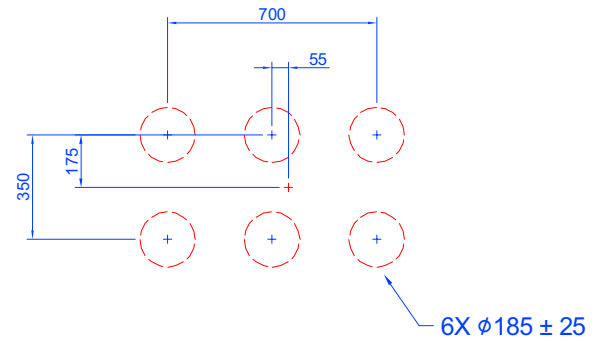
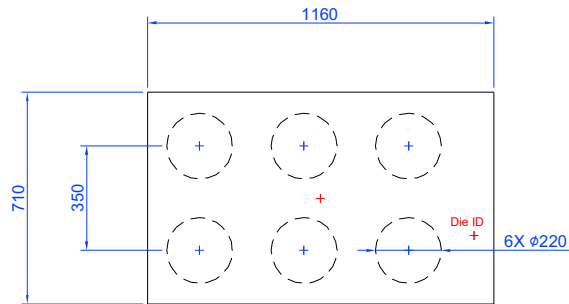
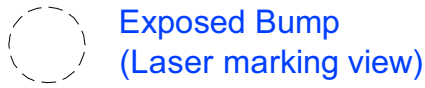

Solder mask detail (not to scale)

**Unit: μm**

## SLG59M1685C

A Low Power, 10 mΩ, 2 A, 0.82 mm<sup>2</sup> WLCSP Load Switch with Multiple Protection Features

### Recommended Reflow Soldering Profile

For successful reflow of the SLG59M1685C a recommended thermal profile is illustrated below:

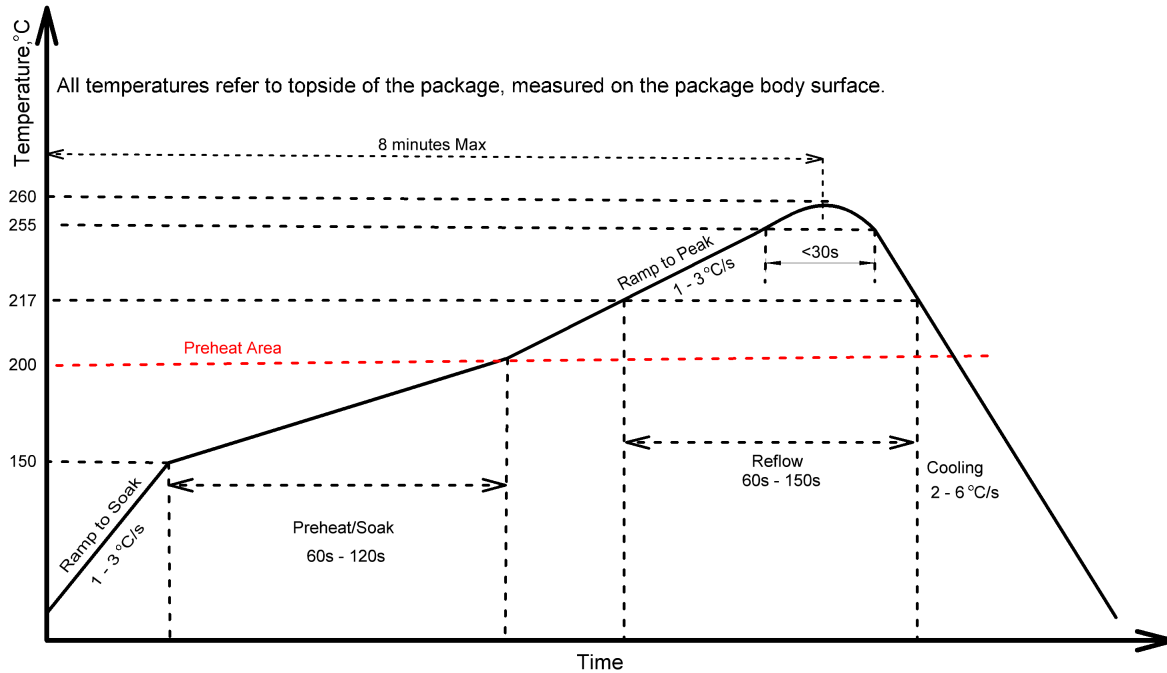

Note: This reflow profile is for classification/preconditioning and are not meant to specify board assembly profile. Actual board assembly profiles should be developed based on specific process needs and board designs and should not exceed parameters depicted on figure above.

Please see more information on IPC/JEDEC J-STD-020: latest revision for reflow profile based on package volume of 0.243 mm<sup>3</sup> (nominal).

## SLG59M1685C

A Low Power, 10 mΩ, 2 A, 0.82 mm<sup>2</sup> WLCSP  
Load Switch with Multiple Protection Features

### Tape and Reel Specifications

Package Type	# of Pins	Nominal Package Size [mm]	Max Units		Reel & Hub Size [mm]	Leader (min)		Trailer (min)		Tape Width [mm]	Part Pitch [mm]
			per Reel	per Box		Pockets	Length [mm]	Pockets	Length [mm]		
WLCSP 6L 0.71 x 1.16 mm 0.35P Green	6	0.71 x 1.16	3000	3000	178/60	100	400	100	400	8	4

### Carrier Tape Drawing and Dimensions

Package Type	Pocket BTM Length	Pocket BTM Width	Pocket Depth	Index Hole Pitch	Pocket Pitch	Index Hole Diameter	Index Hole to Tape Edge	Index Hole to Pocket Center	Tape Width
	A0	B0	K0	P0	P1	D0	E	F	W
WLCSP 6L 0.71 x 1.16 mm 0.35P Green	0.77	1.22	0.53	4	4	1.5	1.75	3.5	0.2

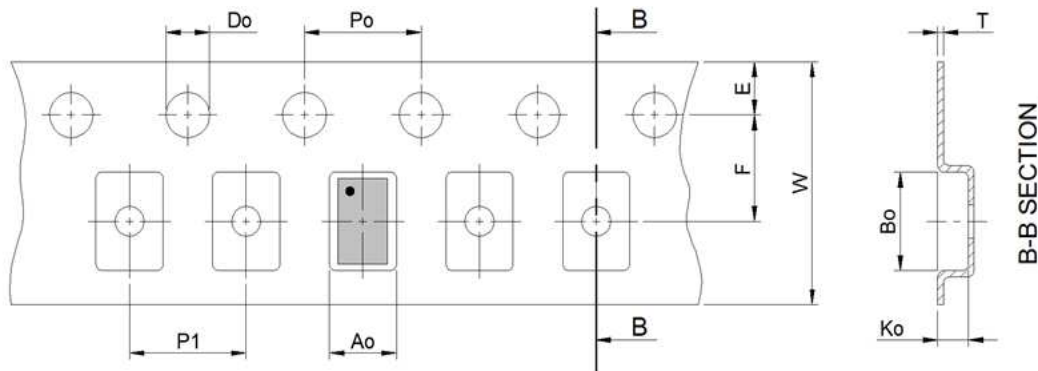

Refer to EIA-481 specification

## SLG59M1685C

A Low Power, 10 mΩ, 2 A, 0.82 mm<sup>2</sup> WLCSP  
Load Switch with Multiple Protection Features

### Revision History

Date	Version	Change
2/3/2022	1.01	Updated Company name and logo Fixed typos
10/23/2018	1.00	Production Release

## IMPORTANT NOTICE AND DISCLAIMER

RENESAS ELECTRONICS CORPORATION AND ITS SUBSIDIARIES (“RENESAS”) PROVIDES TECHNICAL SPECIFICATIONS AND RELIABILITY DATA (INCLUDING DATASHEETS), DESIGN RESOURCES (INCLUDING REFERENCE DESIGNS), APPLICATION OR OTHER DESIGN ADVICE, WEB TOOLS, SAFETY INFORMATION, AND OTHER RESOURCES “AS IS” AND WITH ALL FAULTS, AND DISCLAIMS ALL WARRANTIES, EXPRESS OR IMPLIED, INCLUDING, WITHOUT LIMITATION, ANY IMPLIED WARRANTIES OF MERCHANTABILITY, FITNESS FOR A PARTICULAR PURPOSE, OR NON-INFRINGEMENT OF THIRD-PARTY INTELLECTUAL PROPERTY RIGHTS.

These resources are intended for developers who are designing with Renesas products. You are solely responsible for (1) selecting the appropriate products for your application, (2) designing, validating, and testing your application, and (3) ensuring your application meets applicable standards, and any other safety, security, or other requirements. These resources are subject to change without notice. Renesas grants you permission to use these resources only to develop an application that uses Renesas products. Other reproduction or use of these resources is strictly prohibited. No license is granted to any other Renesas intellectual property or to any third-party intellectual property. Renesas disclaims responsibility for, and you will fully indemnify Renesas and its representatives against, any claims, damages, costs, losses, or liabilities arising from your use of these resources. Renesas' products are provided only subject to Renesas' Terms and Conditions of Sale or other applicable terms agreed to in writing. No use of any Renesas resources expands or otherwise alters any applicable warranties or warranty disclaimers for these products.

(Disclaimer Rev.1.01 Jan 2024)

### Corporate Headquarters

TOYOSU FORESIA, 3-2-24 Toyosu,  
Koto-ku, Tokyo 135-0061, Japan  
[www.renesas.com](http://www.renesas.com)

### Trademarks

Renesas and the Renesas logo are trademarks of Renesas Electronics Corporation. All trademarks and registered trademarks are the property of their respective owners.

### Contact Information

For further information on a product, technology, the most up-to-date version of a document, or your nearest sales office, please visit [www.renesas.com/contact-us/](http://www.renesas.com/contact-us/).