

Features

- Power Supply: 4.4 V to 5.25 V
- SLG5NT021 Drain Voltage Range 1.0 V to 24 V
- Internal Gate Voltage Charge Pump
- Controlled Turn on Delay
- Controlled Turn on Slew Rate
- Stable Slew Rate ($\pm 2\%$ typ) over Temperature Range
- RoHS Compliant / Halogen-Free
- Pb-Free TDFN-8 Package

Pin Configuration

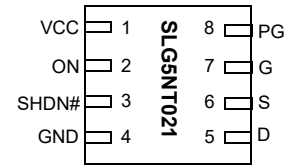

TDFN-8
(Top View)

Applications

- Power Rail Switches
- Hot Plugging Applications
- Soft Switching
- Personal computers and Servers
- Data Communications Equipment

Block Diagram

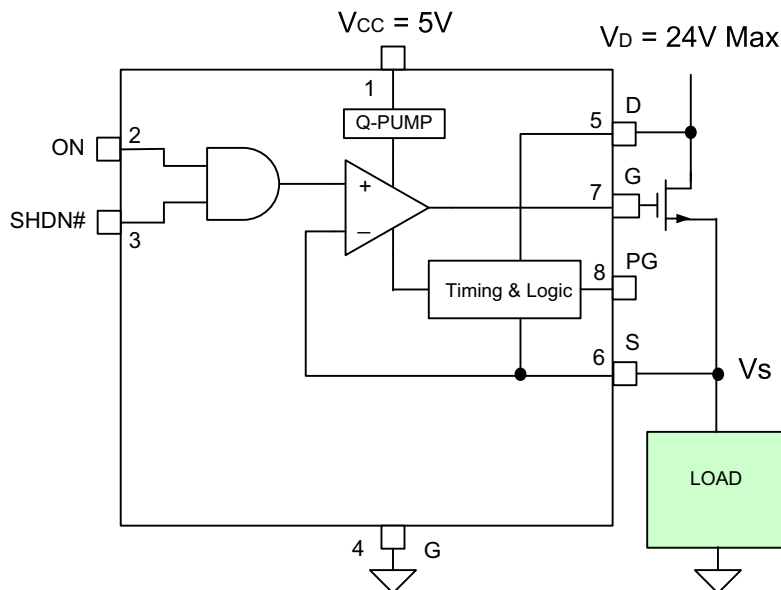

SLG5NT021
For N-MOSFETS with $V_{GS} < 20\text{ V}$

Pin Description

Pin Name	Pin Number	Type	Pin Description
VCC	1	Power	Supply Voltage
ON	2	Input	CMOS Logic Level. High True
SHDN#	3	Input	Shut Down# - Low True Signal which immediately turns FET off
GND	4	GND	Ground
D	5	Input	FET Drain Connection
S	6	Input	Source Connection
G	7	Output	FET Gate Drive
PG	8	Output	Output CMOS Open Drain - Power Good, indicates external FET fully on

Overview

The SLG5NT021 N-Channel FET Gate Driver is used for controlling a delayed turn on and ramping slew rate of the source voltage on N-Channel FET switches from a CMOS logic level input. The SLG5NT021 is intended as a supporting control element for switched voltage rails in energy efficient, advanced power management systems. The gate driver is available in a variety of configurations supporting a range of turn-on slew rates from 0.80 V/ms up to 4V/ms which, depending on load supplying source voltages in the range of 1.0 V to 20 V results in ramp times from 200 μ s up to over 20 ms (see Application Section). Delays until the ramp begins are source voltage independent and range from 250 μ s to 5ms. A power good condition is output to indicate that the ramp-up slew of the source voltage is finished. The SLG5NT021 gate drive is packaged in an 8 pin DFN package.

When used with external N-Channel FETs, the SLG5NT021 supports low transient, energy efficient switching of high current loads at source voltages ranging from 1.0 V to 20 V.

Ordering Information

Part Number	Ramp Slew Rate (Volts/ms)	Delay Time (ms)	Discharge Resistor (ohms)	Package Type
SLG5NT021-200000V	2.0	0.15	Open	TDFN-8
SLG5NT021-200000VTR	2.0	0.15	Open	TDFN-8 - Tape and Reel (3k units)

Absolute Maximum Conditions

Parameter	Min.	Max.	Unit
V_D or V_S to GND	-0.3	40.0	V
Voltage at Logic Input pins	-0.3	6.5	V
Current at input pin	-1.0	1.0	mA
Storage temperature range	-65	150	°C
Operating temperature range	-55	125	°C
Junction temperature	--	150	°C
ESD Human Body Model	--	2000	V
ESD Machine Model	--	200	V

Electrical Characteristics (-10°C to 75°C)

Symbol	Parameter	Condition/Note	Min.	Typ.	Max.	Unit
V_{CC}	Supply Voltage		4.4	5.0	5.25	V
I_q	Quiescent Current	V_G not ramping FET = ON	--	<7	15	μA
		V_G not ramping FET = OFF	--	0.1	1	μA
V_D	FET Drain Voltage		1.0	--	24	V
V_{GS}	Gate-Source Voltage		7.0	11.5	20	V
C_G	FET Gate Capacitance		500	--	8000	pF
T_{DELAY}	Ramp Delay Range	1.5ms Default, 500μs step	0.105	0.15	0.195	ms
T_{SLEW}	FET Turn on Slew Rate		1.4	2.0	2.6	V/ms
$I_{DISCHARGE}$	Internal Discharge Resistor		Open			Ω
V_{IH}	HIGH-level input voltage	ON, SHDN# (200mV Hysteresis)	2.4	--	5.5	V
V_{IL}	LOW-level Input voltage	ON, SHDN# (200mV Hysteresis)	--	--	0.4	V
V_{OH}	HIGH-level output voltage	PG Open Drain	--	--	5.5	V
I_{OL_LOGIC}	Logic LOW level output	PG Sink Current	1	2	3	mA
I_{IH}^*	SHDN#	$V_{IH} = 3.3V$	--	--	<1.0	μA
I_{G_OL}	Gate Drive Sink Current		400	--	--	μA
I_{G_OH}	Gate Drive Source Current		32	--	--	μA
I_{D_IH}	Drain Pin Current	$V_D = 20V$ in Standby	--	--	<1.0	μA
I_{S_IH}	Source Pin Current Quiescent	$V_S = 20V$	--	--	<1.0	μA

* If using an open drain to drive SHDN#; pull up with 10 kΩ to V_{CC}

Application Example

In a typical application, de-asserting ON (low) or asserting the low true Shut Down signal (SHDN#) turns off the external power N-FET. SHDN# is provided as an asynchronous override to the ON signal. When ON is asserted (high), gate voltage is not applied to the gate of the external power N-FET until after DLY_t then the gate source (Vgs) voltage is ramped up to 11.5 V above the source voltage V_S at a slew rate determined by the internal slew rate control element internal to the SLG5NT021. Monotonic rise of V_S is maintained even as I_D increases dramatically after the load device turn on threshold voltage is reached. After the source voltage has ramped up to its maximum steady state value, the Open Drain PG (Power Good) signal is asserted. PG may be used as the ON control of a second SLG5NT021 thereby providing power on sequence control of a number of switched power rails, or used in a 'wired and' with other PG signals to indicate all switched power rails are in a power good condition.

The devices will not operate if V_{CC} is below 3.5 V.

The waveforms shown illustrate the monotonic rise of the source voltage of a FET as gate voltage is controlled to accommodate for variations in load current as the voltage is applied.

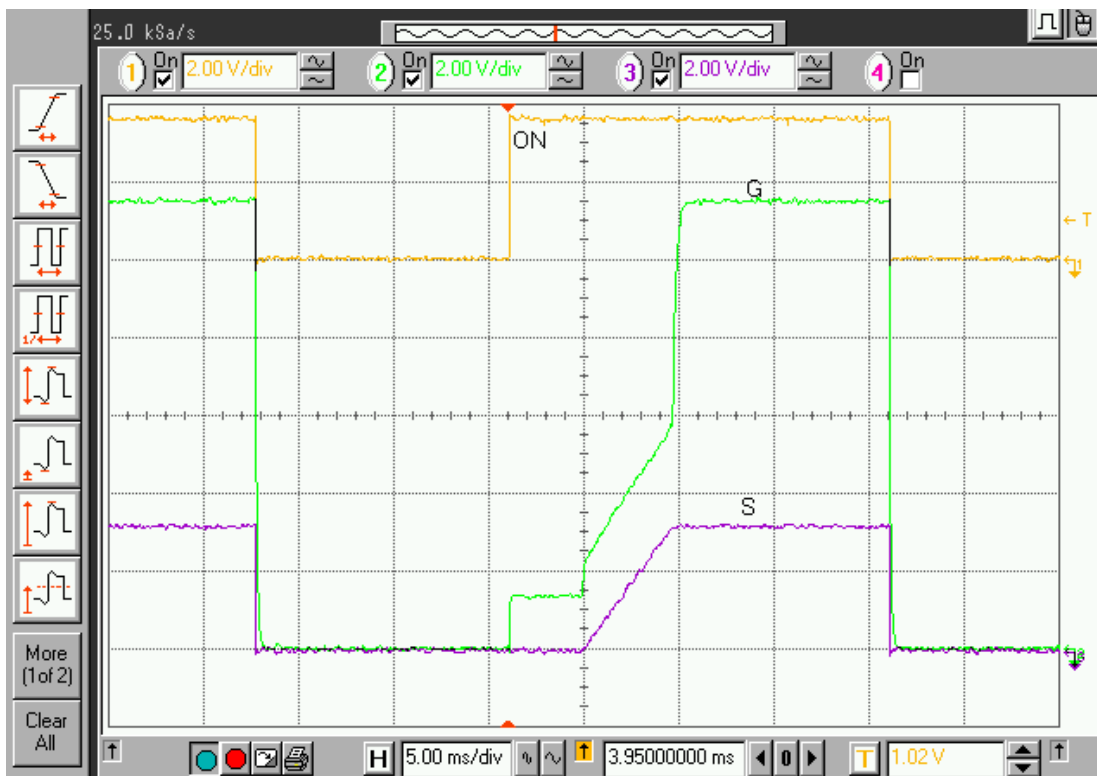

Package Top Marking System Definition

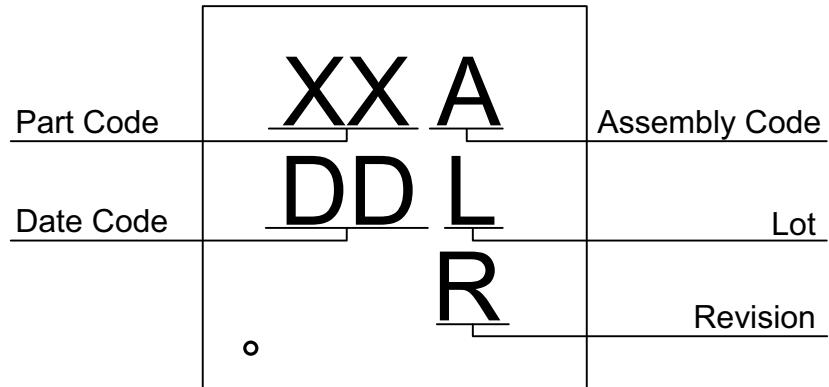

- XX – Part Code Field: identifies the specific device configuration
- A – Assembly Code Field: Assembly Location of the device.
- DD – Date Code Field: Coded date of manufacture
- L – Lot Code: Designates Lot #
- R – Revision Code: Device Revision

Package Drawing and Dimensions

8 Lead TDFN Package JEDEC MO-229, Variation WCCD

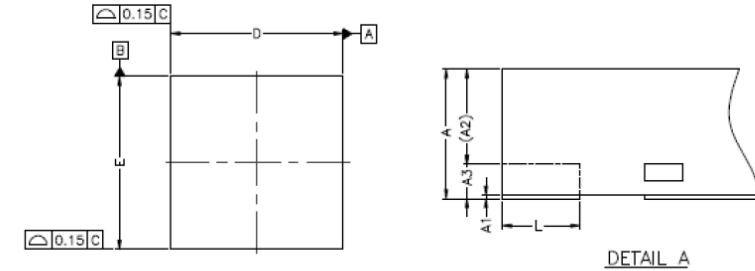

SYMBOL	DIMENSION (MM)			DIMENSION (MIL)		
	MIN.	NOM.	MAX.	MIN.	NOM.	MAX.
A	0.70	0.75	0.80	28	30	31
A1	0.00	0.02	0.05	0	1	2
A2	0	0.55	0.80	0	22	31
A3	—	0.20	—	—	8	—
b	0.18	0.25	0.30	7	10	12
D	1.90	2.00	2.10	74	79	83
D1	—			—		
D2	0.75	0.90	1.05	30	35	41
E	1.90	2.00	2.10	75	79	83
E1	—			—		
E2	1.50	1.65	1.70	53	59	65
e	0.50 BSC			20 BSC		
L	0.25	0.30	0.35	10	12	14

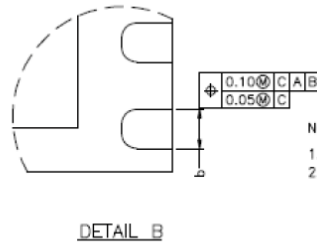
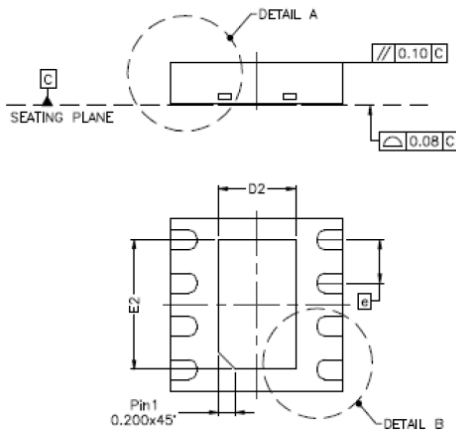

NOTE :

1. REFER TO JEDEC STD: MO-229.
2. DIMENSION "b" APPLIES TO METALLIZED TERMINAL AND IS MEASURED BETWEEN 0.15MM AND 0.30MM FROM THE TERMINAL TIP. IF THE TERMINAL HAS OPTIONAL RADIUS ON THE OTHER END OF THE TERMINAL, THE DIMENSION B SHOULD NOT BE MEASURED IN THAT RADIUS AREA.

Tape and Reel Specifications

Package Type	# of Pins	Nominal Package Size [mm]	Max Units		Reel & Hub Size [mm]	Leader (min)		Trailer (min)		Tape Width [mm]	Part Pitch [mm]
			per Reel	per Box		Pockets	Length [mm]	Pockets	Length [mm]		
TDFN 8L Green	8	2 x 2 x 0.75	3,000	3,000	178 / 60	100	400	100	400	8	4

Carrier Tape Drawing and Dimensions

Package Type	Pocket BTM Length	Pocket BTM Width	Pocket Depth	Index Hole Pitch	Pocket Pitch	Index Hole Diameter	Index Hole to Tape Edge	Index Hole to Pocket Center	Tape Width
	A0	B0	K0	P0	P1	D0	E	F	W
TDFN 8L Green	2.3	2.3	1.05	4	4	1.55	1.75	3.5	8

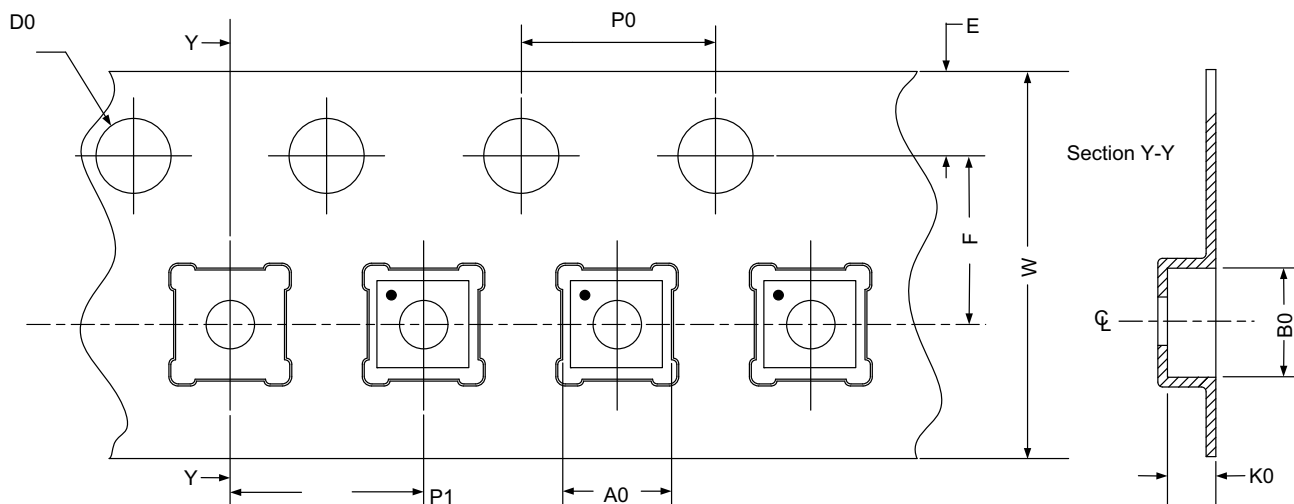

Refer to EIA-481 specification

Recommended Reflow Soldering Profile

Please see IPC/JEDEC J-STD-020: latest revision for reflow profile based on package volume of 3.00 mm³ (nominal). More information can be found at www.jedec.org.

Revision History

Date	Version	Change
2/9/2022	1.01	Updated Company name and logo Fixed typos

IMPORTANT NOTICE AND DISCLAIMER

RENESAS ELECTRONICS CORPORATION AND ITS SUBSIDIARIES (“RENESAS”) PROVIDES TECHNICAL SPECIFICATIONS AND RELIABILITY DATA (INCLUDING DATASHEETS), DESIGN RESOURCES (INCLUDING REFERENCE DESIGNS), APPLICATION OR OTHER DESIGN ADVICE, WEB TOOLS, SAFETY INFORMATION, AND OTHER RESOURCES “AS IS” AND WITH ALL FAULTS, AND DISCLAIMS ALL WARRANTIES, EXPRESS OR IMPLIED, INCLUDING, WITHOUT LIMITATION, ANY IMPLIED WARRANTIES OF MERCHANTABILITY, FITNESS FOR A PARTICULAR PURPOSE, OR NON-INFRINGEMENT OF THIRD-PARTY INTELLECTUAL PROPERTY RIGHTS.

These resources are intended for developers who are designing with Renesas products. You are solely responsible for (1) selecting the appropriate products for your application, (2) designing, validating, and testing your application, and (3) ensuring your application meets applicable standards, and any other safety, security, or other requirements. These resources are subject to change without notice. Renesas grants you permission to use these resources only to develop an application that uses Renesas products. Other reproduction or use of these resources is strictly prohibited. No license is granted to any other Renesas intellectual property or to any third-party intellectual property. Renesas disclaims responsibility for, and you will fully indemnify Renesas and its representatives against, any claims, damages, costs, losses, or liabilities arising from your use of these resources. Renesas' products are provided only subject to Renesas' Terms and Conditions of Sale or other applicable terms agreed to in writing. No use of any Renesas resources expands or otherwise alters any applicable warranties or warranty disclaimers for these products.

(Disclaimer Rev.1.01 Jan 2024)

Corporate Headquarters

TOYOSU FORESIA, 3-2-24 Toyosu,
Koto-ku, Tokyo 135-0061, Japan
www.renesas.com

Trademarks

Renesas and the Renesas logo are trademarks of Renesas Electronics Corporation. All trademarks and registered trademarks are the property of their respective owners.

Contact Information

For further information on a product, technology, the most up-to-date version of a document, or your nearest sales office, please visit www.renesas.com/contact-us/.