

To our customers,

Old Company Name in Catalogs and Other Documents

On April 1st, 2010, NEC Electronics Corporation merged with Renesas Technology Corporation, and Renesas Electronics Corporation took over all the business of both companies. Therefore, although the old company name remains in this document, it is a valid Renesas Electronics document. We appreciate your understanding.

Renesas Electronics website: <http://www.renesas.com>

April 1st, 2010
Renesas Electronics Corporation

Issued by: Renesas Electronics Corporation (<http://www.renesas.com>)

Send any inquiries to <http://www.renesas.com/inquiry>.

Not recommended
for new design

Notice

1. All information included in this document is current as of the date this document is issued. Such information, however, is subject to change without any prior notice. Before purchasing or using any Renesas Electronics products listed herein, please confirm the latest product information with a Renesas Electronics sales office. Also, please pay regular and careful attention to additional and different information to be disclosed by Renesas Electronics such as that disclosed through our website.
2. Renesas Electronics does not assume any liability for infringement of patents, copyrights, or other intellectual property rights of third parties by or arising from the use of Renesas Electronics products or technical information described in this document. No license, express, implied or otherwise, is granted hereby under any patents, copyrights or other intellectual property rights of Renesas Electronics or others.
3. You should not alter, modify, copy, or otherwise misappropriate any Renesas Electronics product, whether in whole or in part.
4. Descriptions of circuits, software and other related information in this document are provided only to illustrate the operation of semiconductor products and application examples. You are fully responsible for the incorporation of these circuits, software, and information in the design of your equipment. Renesas Electronics assumes no responsibility for any losses incurred by you or third parties arising from the use of these circuits, software, or information.
5. When exporting the products or technology described in this document, you should comply with the applicable export control laws and regulations and follow the procedures required by such laws and regulations. You should not use Renesas Electronics products or the technology described in this document for any purpose relating to military applications or use by the military, including but not limited to the development of weapons of mass destruction. Renesas Electronics products and technology may not be used for or incorporated into any products or systems whose manufacture, use, or sale is prohibited under any applicable domestic or foreign laws or regulations.
6. Renesas Electronics has used reasonable care in preparing the information included in this document, but Renesas Electronics does not warrant that such information is error free. Renesas Electronics assumes no liability whatsoever for any damages incurred by you resulting from errors in or omissions from the information included herein.
7. Renesas Electronics products are classified according to the following three quality grades: “Standard”, “High Quality”, and “Specific”. The recommended applications for each Renesas Electronics product depends on the product’s quality grade, as indicated below. You must check the quality grade of each Renesas Electronics product before using it in a particular application. You may not use any Renesas Electronics product for any application categorized as “Specific” without the prior written consent of Renesas Electronics. Further, you may not use any Renesas Electronics product for any application for which it is not intended without the prior written consent of Renesas Electronics. Renesas Electronics shall not be in any way liable for any damages or losses incurred by you or third parties arising from the use of any Renesas Electronics product for an application categorized as “Specific” or for which the product is not intended where you have failed to obtain the prior written consent of Renesas Electronics. The quality grade of each Renesas Electronics product is “Standard” unless otherwise expressly specified in a Renesas Electronics data sheets or data books, etc.
 - “Standard”: Computers; office equipment; communications equipment; test and measurement equipment; audio and visual equipment; home electronic appliances; machine tools; personal electronic equipment; and industrial robots.
 - “High Quality”: Transportation equipment (automobiles, trains, ships, etc.); traffic control systems; anti-disaster systems; anti-crime systems; safety equipment; and medical equipment not specifically designed for life support.
 - “Specific”: Aircraft; aerospace equipment; submersible repeaters; nuclear reactor control systems; medical equipment or systems for life support (e.g. artificial life support devices or systems), surgical implantations, or healthcare intervention (e.g. excision, etc.), and any other applications or purposes that pose a direct threat to human life.
8. You should use the Renesas Electronics products described in this document within the range specified by Renesas Electronics, especially with respect to the maximum rating, operating supply voltage range, movement power voltage range, heat radiation characteristics, installation and other product characteristics. Renesas Electronics shall have no liability for malfunctions or damages arising out of the use of Renesas Electronics products beyond such specified ranges.
9. Although Renesas Electronics endeavors to improve the quality and reliability of its products, semiconductor products have specific characteristics such as the occurrence of failure at a certain rate and malfunctions under certain use conditions. Further, Renesas Electronics products are not subject to radiation resistance design. Please be sure to implement safety measures to guard them against the possibility of physical injury, and injury or damage caused by fire in the event of the failure of a Renesas Electronics product, such as safety design for hardware and software including but not limited to redundancy, fire control and malfunction prevention, appropriate treatment for aging degradation or any other appropriate measures. Because the evaluation of microcomputer software alone is very difficult, please evaluate the safety of the final products or system manufactured by you.
10. Please contact a Renesas Electronics sales office for details as to environmental matters such as the environmental compatibility of each Renesas Electronics product. Please use Renesas Electronics products in compliance with all applicable laws and regulations that regulate the inclusion or use of controlled substances, including without limitation, the EU RoHS Directive. Renesas Electronics assumes no liability for damages or losses occurring as a result of your noncompliance with applicable laws and regulations.
11. This document may not be reproduced or duplicated, in any form, in whole or in part, without prior written consent of Renesas Electronics.
12. Please contact a Renesas Electronics sales office if you have any questions regarding the information contained in this document or Renesas Electronics products, or if you have any other inquiries.

(Note 1) “Renesas Electronics” as used in this document means Renesas Electronics Corporation and also includes its majority-owned subsidiaries.

(Note 2) “Renesas Electronics product(s)” means any product developed or manufactured by or for Renesas Electronics.

PROGRAMMABLE OPERATIONAL AMPLIFIER

DESCRIPTION

The μ PC4250 is a highly versatile monolithic operational amplifier. The quiescent power dissipation, input offset and bias current, slew rate and gain-bandwidth products are determined by a single external programming resistor. Since the μ PC4250 is in effect different op amps for each externally programmed set current, it is possible to use a single stock item for a variety of circuit function in a system.

FEATURES

- Wide supply voltage range: ± 1 V to ± 18 V
- Programmable electrical characteristics
Power consumption, slew rate, etc.
- Internal frequency compensation
- Offset voltage null capability
- Output short circuit protection

★ ORDERING INFORMATION

Part Number	Package
μ PC4250C	8-pin plastic DIP (7.62 mm (300))
μ PC4250G2	8-pin plastic SOP (5.72 mm (225))

EQUIVALENT CIRCUIT

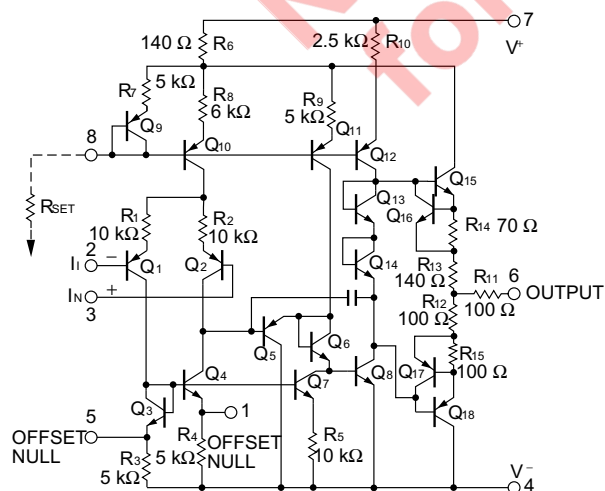

PIN CONFIGURATION (Top View)

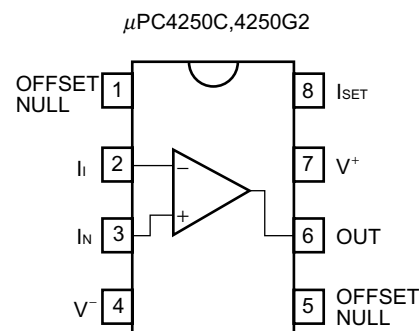

The information in this document is subject to change without notice. Before using this document, please confirm that this is the latest version.
Not all devices/types available in every country. Please check with local NEC representative for availability and additional information.

ABSOLUTE MAXIMUM RATINGS (T_A = 25°C)

Parameter		Symbol	Ratings	Unit
Voltage between V ⁺ and V ⁻ ^{Note 1}		V ⁺ - V ⁻	-0.3 to +36	V
Differential Input Voltage		V _{ID}	±30	V
Input Voltage ^{Note 2}		V _I	V ⁻ -0.3 to V ⁺ +0.3	V
Output Voltage ^{Note 3}		V _O	V ⁻ -0.3 to V ⁺ +0.3	V
I _{SET} Current		I _{SET}	150	μA
Power Dissipation	C Package ^{Note 4}	P _T	350	mW
	G2 Package ^{Note 5}		440	mW
Output Short Circuit Duration ^{Note 6}			Indefinite	sec
Operating Ambient Temperature		T _A	-20 to +80	°C
Storage Temperature		T _{stg}	-55 to +125	°C

- Notes**
- Reverse connection of supply voltage can cause destruction.
 - The input voltage should be allowed to input without damage or destruction. Even during the transition period of supply voltage, power on/off etc., this specification should be kept. The normal operation will establish when the both inputs are within the Common Mode Input Voltage Range of electrical characteristics.
 - This specification is the voltage which should be allowed to supply to the output terminal from external without damage or destruction. Even during the transition period of supply voltage, power on/off etc., this specification should be kept. The output voltage of normal operation will be the Output Voltage Swing of electrical characteristics.
 - Thermal derating factor is -5.0 mV/°C when operating ambient temperature is higher than 55°C.
 - Thermal derating factor is -4.4 mV/°C when operating ambient temperature is higher than 25°C.
 - Pay careful attention to the total power dissipation not to exceed the absolute maximum ratings, Note 4 and Note 5.

RECOMMENDED OPERATING CONDITIONS

Parameter	Symbol	MIN.	TYP.	MAX.	Unit
Supply Voltage	V [±]	±1		±16	V
I _{SET} Current	I _{SET}	0.1		50	μA

TYPICAL CONNECTIONS

I_{SET}

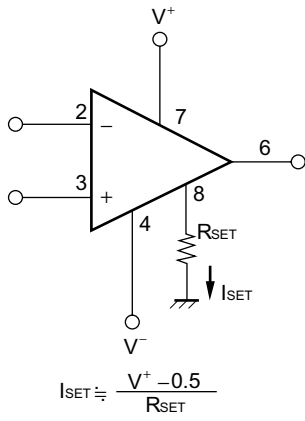
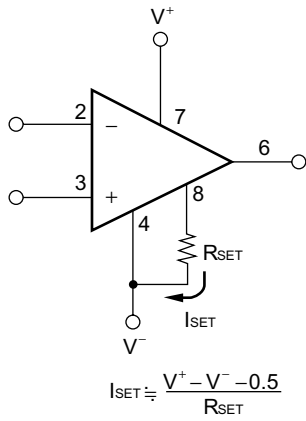

OFFSET VOLTAGE NULL CIRCUIT

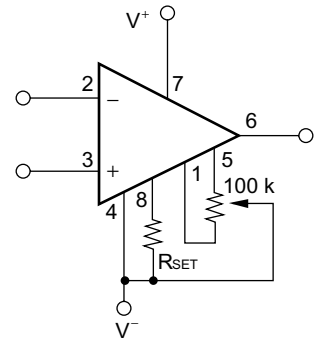

Remark I_{SET} is indispensable to operate.

Not recommend
for new design

ELECTRICAL CHARACTERISTICS (T_A = 25°C, V[±] = ±15 V)

Parameter	Symbol	Conditions	I _{SET} = 1 μA		I _{SET} = 10 μA		Unit
			MIN.	MAX.	MIN.	MAX.	
Input Offset Voltage	V _{IO}	R _S ≤ 100 kΩ		±5		±6	mV
		V [±] = ±1.5 V, R _S ≤ 100 kΩ		±5		±6	
Input Offset Current ^{Note 7}	I _{IO}			±6		±20	nA
Input Bias Current ^{Note 7}	I _B			10		75	nA
		V [±] = ±1.5 V		10		75	
Large Signal Voltage Gain	A _v	V _O = ±10 V, R _L = 100 kΩ	60000				
		V _O = ±10 V, R _L = 10 kΩ			60000		
Supply Current	I _{CC}	I _O = 0 A		11		100	μA
		V [±] = ±1.5 V, I _O = 0 A		8		90	
Power Dissipation	P _d	I _O = 0 A		330		3000	μW
		V [±] = ±1.5 V, I _O = 0 A		24		270	
Common Mode Rejection Ratio	CMR	R _S ≤ 10 kΩ	70		70		dB
Supply Voltage Rejection Ratio	SVR	R _S ≤ 10 kΩ	74		74		dB
Output Voltage Swing	V _{om}	R _L = 100 kΩ	±12				V
		V [±] = ±1.5 V, R _L = 100 kΩ	±0.6				
Output Voltage Swing	V _{om}	R _L = 10 kΩ			±12		V
		V [±] = ±1.5 V, R _L = 10 kΩ			±0.6		
Common Mode Input Voltage Range	V _{ICM}		±13.5		±13.5		V
		V [±] = ±1.5 V	±0.6		±0.6		

Notes 7. Input bias currents flow out from IC. Because each currents are base current of PNP-transistor on input stage.

TYPICAL APPLICATION

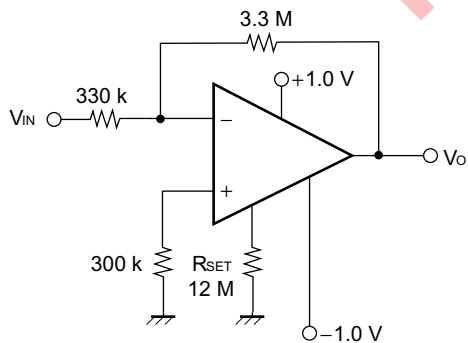

x10 Amplifier (500 nW)

TYPICAL PERFORMANCE CHARACTERISTICS ($T_A = 25^\circ\text{C}$, TYP.)

★ POWER DISSIPATION

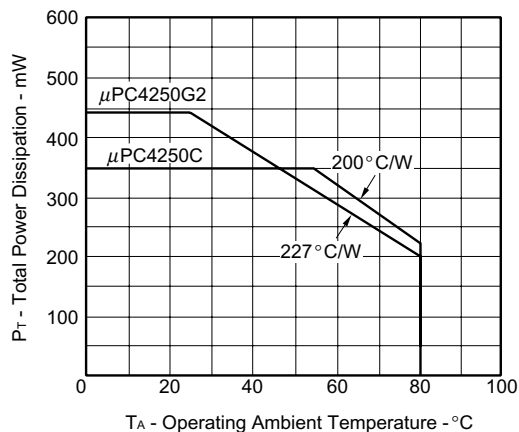

INPUT BIAS CURRENT

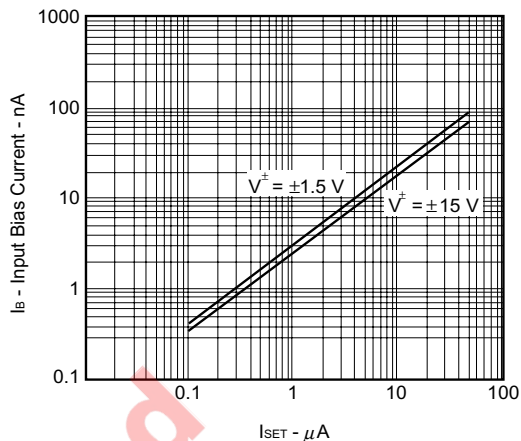

INPUT BIAS CURRENT

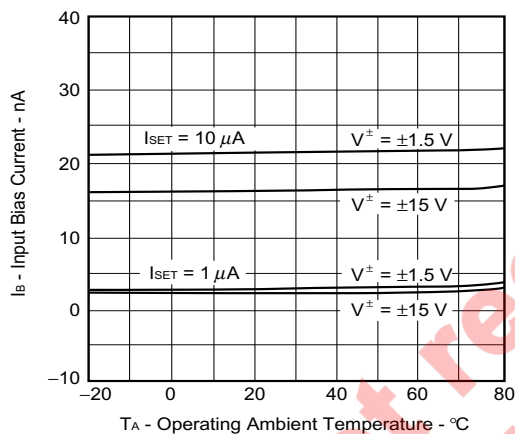

INPUT OFFSET CURRENT

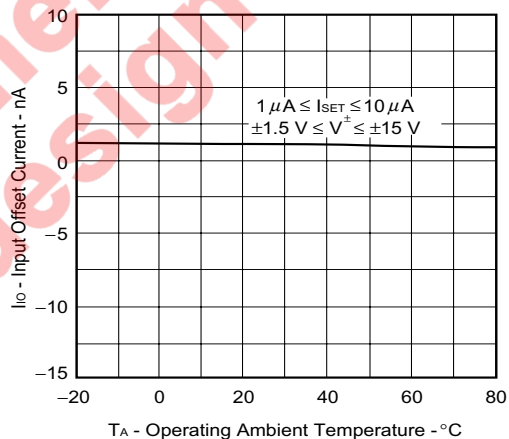

INPUT OFFSET VOLTAGE (unnull)

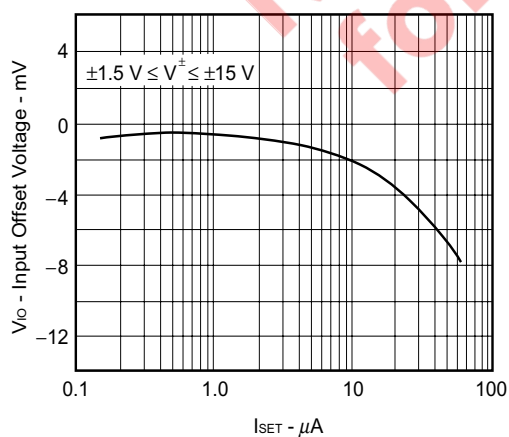

INPUT OFFSET VOLTAGE (unnull)

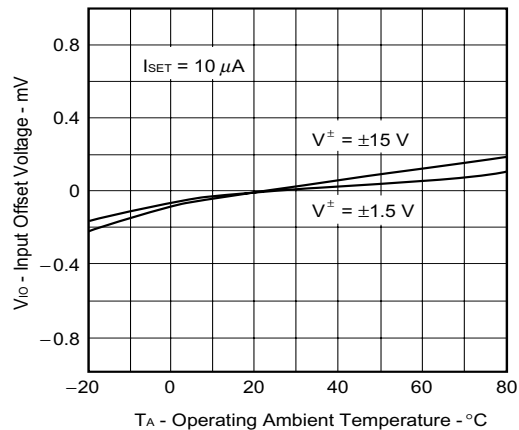

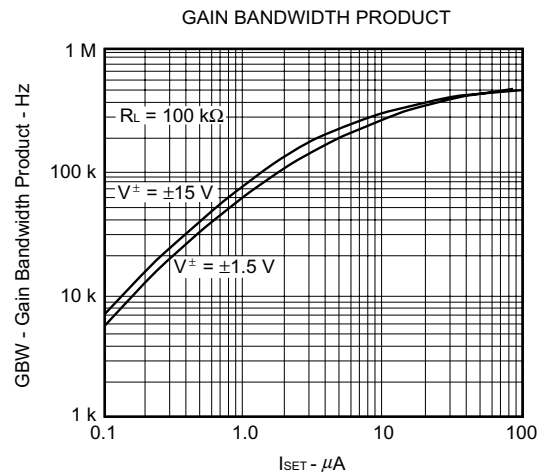
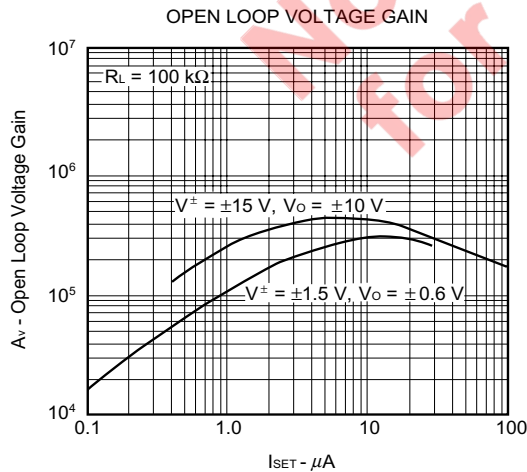
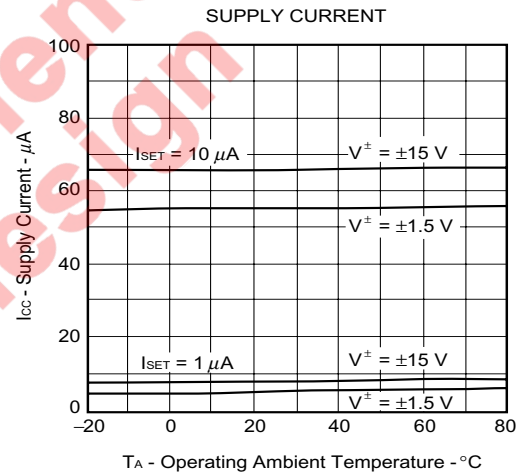
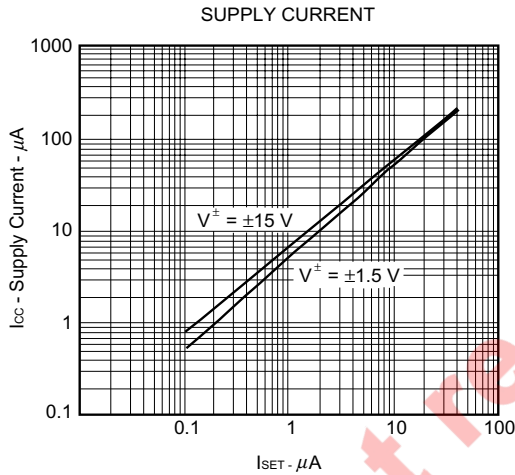
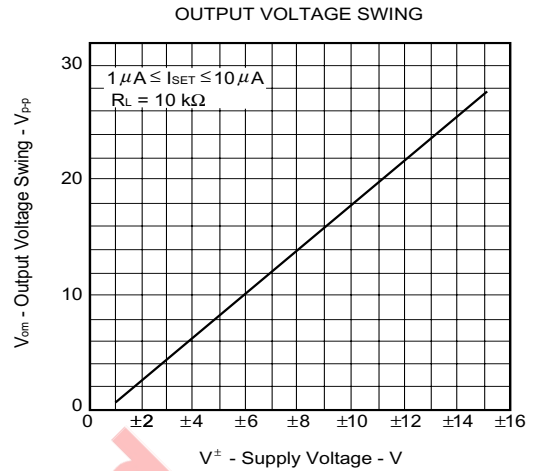
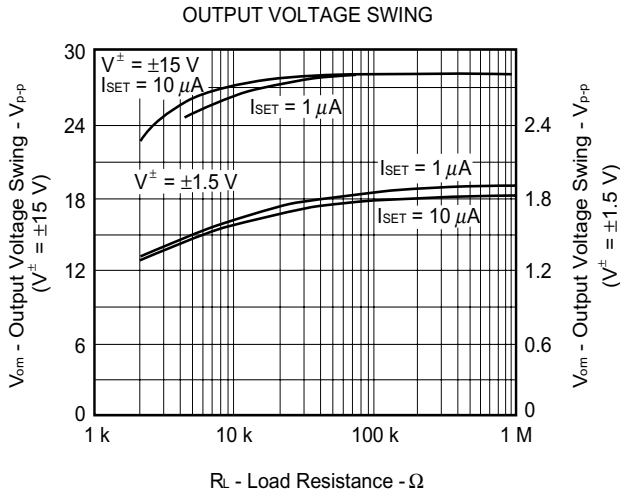

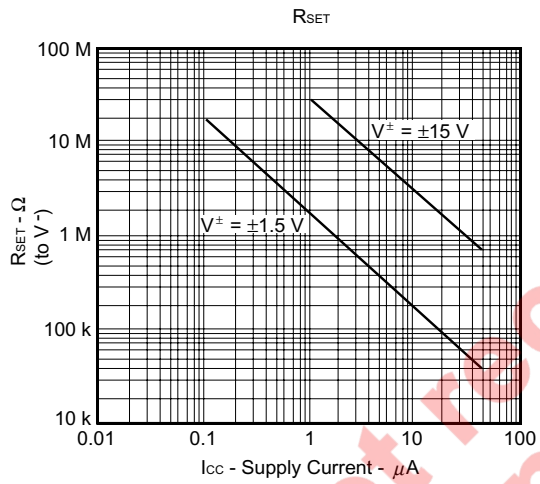
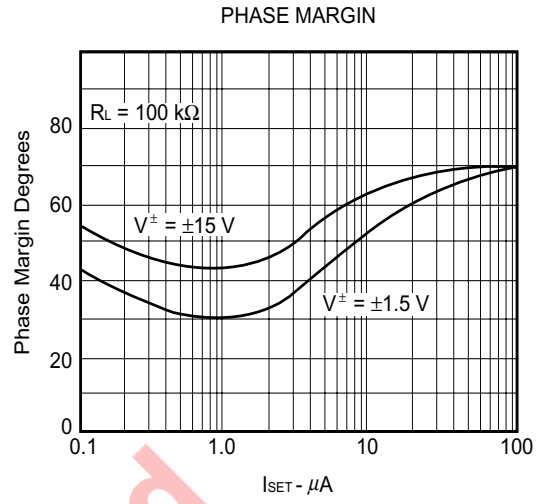
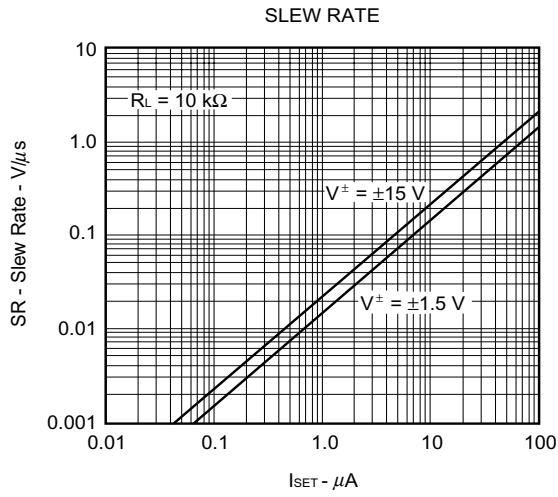

Not recommended for new design

★ PACKAGE DRAWINGS (Unit : mm)

8-PIN PLASTIC DIP (7.62mm(300))

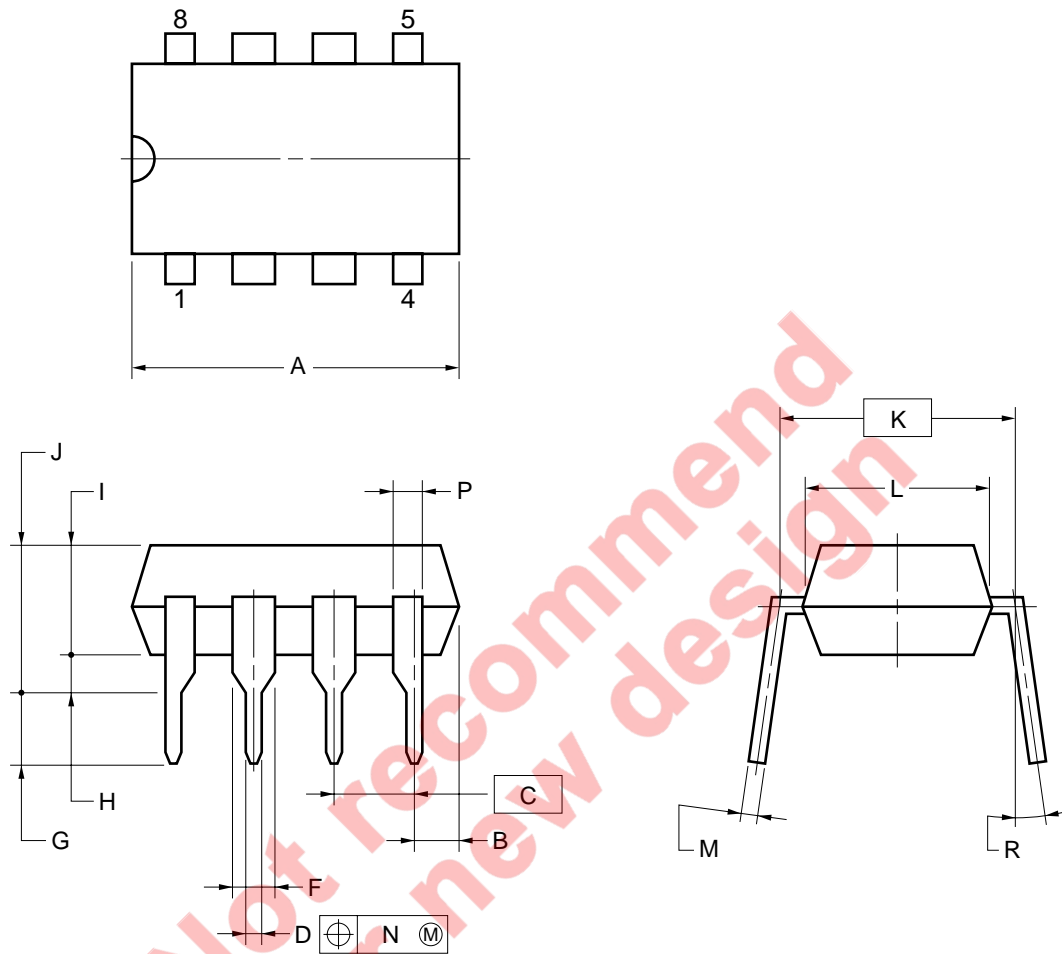

NOTES

1. Each lead centerline is located within 0.25 mm of its true position (T.P.) at maximum material condition.
2. Item "K" to center of leads when formed parallel.

ITEM	MILLIMETERS
A	10.16 MAX.
B	1.27 MAX.
C	2.54 (T.P.)
D	0.50±0.10
F	1.4 MIN.
G	3.2±0.3
H	0.51 MIN.
I	4.31 MAX.
J	5.08 MAX.
K	7.62 (T.P.)
L	6.4
M	0.25 ^{+0.10} _{-0.05}
N	0.25
P	0.9 MIN.
R	0~15°

P8C-100-300B,C-2

8-PIN PLASTIC SOP (5.72 mm (225))

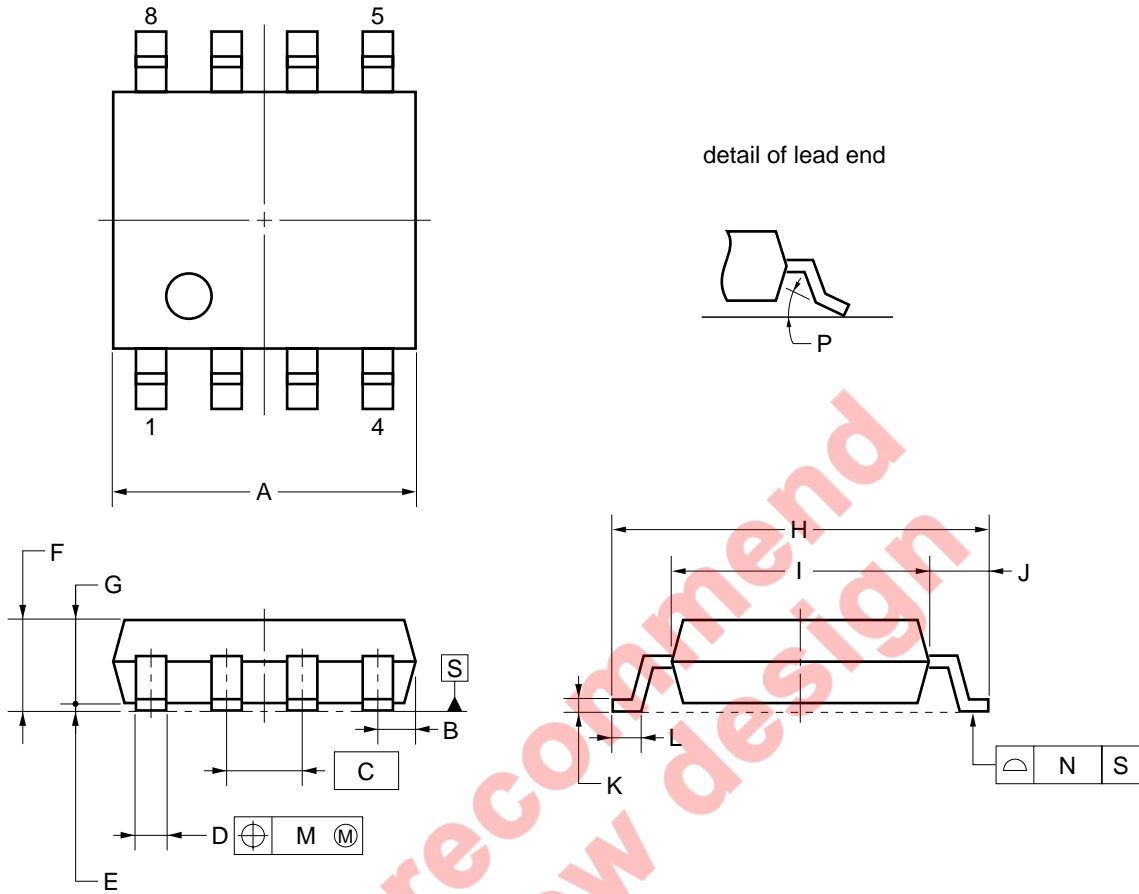

NOTE

Each lead centerline is located within 0.12 mm of its true position (T.P.) at maximum material condition.

ITEM	MILLIMETERS
A	5.2 ^{+0.17} / _{-0.20}
B	0.78 MAX.
C	1.27 (T.P.)
D	0.42 ^{+0.08} / _{-0.07}
E	0.1±0.1
F	1.59±0.21
G	1.49
H	6.5±0.3
I	4.4±0.15
J	1.1±0.2
K	0.17 ^{+0.08} / _{-0.07}
L	0.6±0.2
M	0.12
N	0.10
P	3° ^{+7°} / _{-3°}

S8GM-50-225B-6

★ RECOMMENDED SOLDERING CONDITIONS

When soldering this product, it is highly recommended to observe the conditions as shown below. If other soldering processes are used, or if the soldering is performed under different conditions, please make sure to consult with our sales offices.

For more details, refer to our document "SEMICONDUCTOR DEVICE MOUNTING TECHNOLOGY MANUAL"(C10535E).

Type of Surface Mount Device

μPC4250G2: 8-pin plastic SOP (5.72 mm (225))

Process	Conditions	Symbol
Infrared Ray Reflow	Peak temperature: 235°C or below (Package surface temperature), Reflow time: 30 seconds or less (at 210°C or higher), Maximum number of reflow processes: 3 time.	IR35-00-3
Vapor Phase Soldering	Peak temperature: 215°C or below (Package surface temperature), Reflow time: 40 seconds or less (at 200°C or higher), Maximum number of reflow processes: 3 time.	VP15-00-3
Wave Soldering	Solder temperature: 260°C or below, Flow time: 10 seconds or less, Maximum number of flow processes: 1 time, Pre-heating temperature: 120°C or below (Package surface temperature).	WS60-00-1
Partial Heating Method	Pin temperature: 300°C or below, Heat time: 3 seconds or less (Per each side of the device).	—

Caution Apply only one kind of soldering condition to a device, except for "partial heating method", or the device will be damaged by heat stress.

Type of Through-hole Device

μPC4250C: 8-pin plastic DIP (7.62 mm (300))

Process	Conditions
Wave Soldering (only to leads)	Solder temperature: 260°C or below, Flow time: 10 seconds or less.
Partial Heating Method	Pin temperature: 300°C or below, Heat time: 3 seconds or less (per each lead).

Caution For through-hole device, the wave soldering process must be applied only to leads, and make sure that the package body does not get jet soldered.

[MEMO]

**Not recommend
for new design**

- **The information in this document is current as of June, 2001. The information is subject to change without notice. For actual design-in, refer to the latest publications of NEC's data sheets or data books, etc., for the most up-to-date specifications of NEC semiconductor products. Not all products and/or types are available in every country. Please check with an NEC sales representative for availability and additional information.**
 - No part of this document may be copied or reproduced in any form or by any means without prior written consent of NEC. NEC assumes no responsibility for any errors that may appear in this document.
 - NEC does not assume any liability for infringement of patents, copyrights or other intellectual property rights of third parties by or arising from the use of NEC semiconductor products listed in this document or any other liability arising from the use of such products. No license, express, implied or otherwise, is granted under any patents, copyrights or other intellectual property rights of NEC or others.
 - Descriptions of circuits, software and other related information in this document are provided for illustrative purposes in semiconductor product operation and application examples. The incorporation of these circuits, software and information in the design of customer's equipment shall be done under the full responsibility of customer. NEC assumes no responsibility for any losses incurred by customers or third parties arising from the use of these circuits, software and information.
 - While NEC endeavours to enhance the quality, reliability and safety of NEC semiconductor products, customers agree and acknowledge that the possibility of defects thereof cannot be eliminated entirely. To minimize risks of damage to property or injury (including death) to persons arising from defects in NEC semiconductor products, customers must incorporate sufficient safety measures in their design, such as redundancy, fire-containment, and anti-failure features.
 - NEC semiconductor products are classified into the following three quality grades:
"Standard", "Special" and "Specific". The "Specific" quality grade applies only to semiconductor products developed based on a customer-designated "quality assurance program" for a specific application. The recommended applications of a semiconductor product depend on its quality grade, as indicated below. Customers must check the quality grade of each semiconductor product before using it in a particular application.
 - "Standard": Computers, office equipment, communications equipment, test and measurement equipment, audio and visual equipment, home electronic appliances, machine tools, personal electronic equipment and industrial robots
 - "Special": Transportation equipment (automobiles, trains, ships, etc.), traffic control systems, anti-disaster systems, anti-crime systems, safety equipment and medical equipment (not specifically designed for life support)
 - "Specific": Aircraft, aerospace equipment, submersible repeaters, nuclear reactor control systems, life support systems and medical equipment for life support, etc.
- The quality grade of NEC semiconductor products is "Standard" unless otherwise expressly specified in NEC's data sheets or data books, etc. If customers wish to use NEC semiconductor products in applications not intended by NEC, they must contact an NEC sales representative in advance to determine NEC's willingness to support a given application.
- (Note)
- (1) "NEC" as used in this statement means NEC Corporation and also includes its majority-owned subsidiaries.
 - (2) "NEC semiconductor products" means any semiconductor product developed or manufactured by or for NEC (as defined above).