

μPC4572MF-DAA

Low Supply Voltage, Ultra Low-Noise, High Speed,
Wide Band, Low I_B Dual Operational Amplifier
 $V_n = 0.8 \mu V_{r.m.s.}$, $SR = 6 V/\mu s$, $GBW = 16 MHz$, $V_{IO} = \pm 0.3 mV$

R03DS0059EJ0100
Rev.1.00
Jul 25, 2012

Description

The μPC4572MF-DAA is a dual wide band, ultra low noise operational amplifier designed for low supply voltage operation of +4 V to +14 V single supply and ±2 V to ±7 V split supplies. Using high h_{FE} PNP transistors for the input circuit, Input bias current and input equivalent noise are better than conventional wide band operational amplifier.

The μPC4572 MF-DAA is an excellent choice for preamplifiers and active filters in audio, instrumentation, and communication circuit.

Features

- Ultra low noise ($f = 1 kHz$): $4.0 nV/\sqrt{Hz}$ (TYP.)
- Input equivalent noise voltage: $0.8 \mu V_{r.m.s.}$ (TYP.)
- Total harmonic distortion: 0.002% (TYP.)
- High slew rate : $6 V/\mu s$ (TYP.)
- Gain bandwidth product ($f = 100 kHz$): 16 MHz (TYP.)
- Low input bias current: 100 nA (TYP.)
- Input offset voltage : $\pm 0.3 mV$ (TYP.)
- Low supply voltage: $\pm 2 V$ to $\pm 7 V$ (Split)
+4 V to +14 V (Single, $V^- = GND$)
- Internal frequency compensation

Ordering Information

Part Number	Package	Package Code (Previous Package Code)	Package Abbreviation	Supplying Form
μPC4572MF-DAA-E1-AT ^{*1}	8-pin plastic SOP (3.9 × 4.9)	PRSP0008DM-A (-)	MF	<ul style="list-style-type: none"> • 12 mm wide embossed taping • Pin 1 on draw-out side • 2500 p/reel

Note: *1. Pb-free (This product does not contain Pb in the external electrode and other parts.)

Caution: Do not use the products in applications such as the transportation equipment (a car, a train, a ship, etc.) where “Special quality grade” is required, because the products are placed in a quality grade “standard” to be required at general devices.

Pin Configuration (Top View)

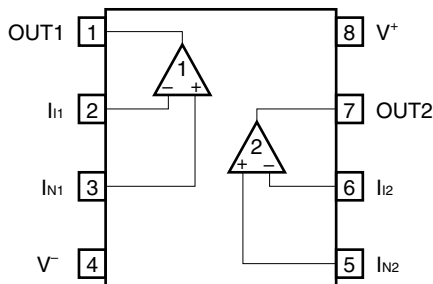

Equivalent Circuit (for Each Circuit)

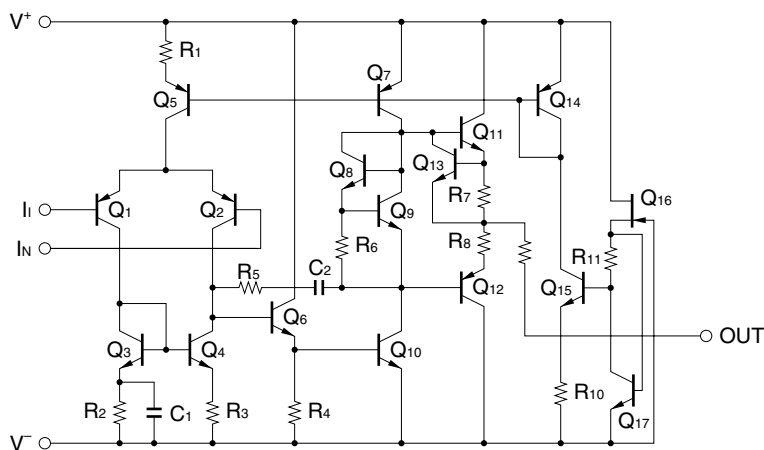

Absolute Maximum Ratings (T_A = 25°C)

Parameter	Symbol	Ratings	Unit
Voltage between V ⁺ and V ⁻ *1	V ⁺ - V ⁻	-0.3 to +15	V
Differential Input Voltage	V _{ID}	±10	V
Input Voltage *2	V _I	V ⁻ - 0.3 to V ⁺ + 0.3	V
Output Applied Voltage *3	V _O	V ⁻ - 0.3 to V ⁺ + 0.3	V
Total Power Dissipation *4	P _T	440	mW
Output Short Circuit Duration (vs. GND) *5	t _s	10	s
Operating Ambient Temperature	T _A	-40 to +85	°C
Storage Temperature	T _{stg}	-55 to +125	°C

Notes: *1. Note that reverse connections of the power supply may damage ICs.

*2. The input voltage is allowed to input without damage or destruction independent of the magnitude of V⁺. Either input signal is not allowed to go negative by more than 0.3 V. In addition, the input voltage that operates normally as an operational amplifier is within the Common Mode Input Voltage range of an electrical characteristic.

*3. A range where input voltage can be applied to an output pin externally with no deterioration or damage to the feature (characteristic). The input voltage can be applied regardless of the electric supply voltage. This specification which includes the transition state such as electric power ON/OFF must be kept.

*4. This is the value in T_A ≤ 56°C of when the glass epoxy substrate (size: 100 mm x 100 mm, thickness: 1 mm, 15% of the substrate area where only one side is copper foiled is filling wired) is mounted. Derate at -6.4 mW/°C when T_A > 56°C. In the condition same as the above, Junction - ambient thermal resistance R_{th(J-A)} = 156°C/W.

*5. Only as for V⁺ ≤ 15V and any 1 channel. Please use the product within the derating condition or Total Power Dissipation, which are showed in Note 4.

Recommended Operating Conditions

Parameter	Symbol	MIN.	TYP.	MAX.	Unit
Power Supply Voltage (Split)	V^{\pm}	±2	±5	±7	V
Supply Voltage ($V^- = \text{GND}$)	V^+	+4	+5 to +12	±14	V
Output Current	I_O			±10	mA
Capacitive Load ($A_V = +1$)	C_L			100	pF

Electrical Characteristics ($V^{\pm} = \pm 5 \text{ V}$, $T_A = 25^{\circ}\text{C}$)

Parameter	Symbol	MIN.	TYP.	MAX.	Unit	Conditions
Input Offset Voltage	V_{IO}		±0.3	±5	mV	$R_S \leq 50 \Omega$
Input Offset Current	I_{IO}		±10	±100	nA	
Input Bias Current *1	I_B		100	400	nA	
Large Signal Voltage Gain	A_V	10000	100000			$R_L \geq 2 \text{ k}\Omega$, $V_O = \pm 2 \text{ V}$
Supply Current *2	I_{CC}		4.5	7	mA	$I_O = 0 \text{ A}$
Common Mode Rejection Ratio	CMR	70	90		dB	
Supply Voltage Rejection Ratio	SVR	70	85		dB	
Output Voltage (High)	V_{OH}	±3.3	±3.7		V	$R_L \geq 10 \text{ k}\Omega$
Output Voltage (Low)	V_{OL}	±3.0	±3.5		V	$R_L \geq 2 \text{ k}\Omega$
Common Model Input Voltage Range	V_{ICM}	±3.5	±4		V	
Output Short Circuit Current	I_O	±15	±20		mA	$R_L = 0 \Omega$
Slew Rate	SR	3.5	6		V/ μs	$R_L \geq 2 \text{ k}\Omega$, $A_V = +1$
Gain Bandwidth Product	GBW	10	16		MHz	$f_O = 100 \text{ kHz}$
Unity Gain Frequency	f_{unity}		9		MHz	open loop
Phase Margin	ϕ_{unity}		60		degree	open loop
Total Harmonic Distortion	THD		0.002		%	$V_O = 1 \text{ V}_{r.m.s.}$, $f = 20 \text{ Hz to } 20 \text{ kHz}$ (Fig.1)
Input Equivalent Noise Voltage	V_n		0.8		$\mu\text{V}_{r.m.s.}$	RIAA (Fig.2)
			0.5	0.65	$\mu\text{V}_{r.m.s.}$	FLAT+JIS A, $R_S = 100 \Omega$ (Fig.3)
Input Equivalent Noise Voltage Density	e_n		4.5		nV/ $\sqrt{\text{Hz}}$	$f_O = 10 \text{ Hz}$
			4.0		nV/ $\sqrt{\text{Hz}}$	$f_O = 1 \text{ kHz}$
Input Equivalent Noise Current Density	i_n		0.7		pA/ $\sqrt{\text{Hz}}$	$f_O = 1 \text{ kHz}$
Channel Separation			120		dB	$f = 20 \text{ Hz to } 20 \text{ kHz}$
Average V_{IO} Temperature Drift	$\Delta V_{IO}/\Delta T$		±2		$\mu\text{V}/^{\circ}\text{C}$	

Notes: *1. Input bias currents flow out from IC. Because each current is base current of PNP-transistor on input stage.

*2. This is a current that flows in the internal circuit. This current flows irrespective of the existence of use.

Electrical Characteristics ($V^+ = +5\text{ V}$, $V^- = \text{GND}$, $T_A = 25^\circ\text{C}$)

Parameter	Symbol	MIN.	TYP.	MAX.	Unit	Conditions
Input Offset Voltage	V_{IO}		± 0.3	± 5	mV	$R_S \leq 50\ \Omega$
Input Offset Current	I_{IO}		± 10	± 100	nA	
Input Bias Current ^{*1}	I_B		100	400	nA	
Large Signal Voltage Gain	A_V	8000	80000			
Supply Current ^{*2}	I_{CC}		4	6	mA	$I_O = 0\ \text{A}$
Common Mode Rejection Ratio	CMR	60	75		dB	
Supply Voltage Rejection Ratio	SVR	60	70		dB	
Output Voltage (High)	V_{OH}	3.2	3.5		V	$R_L \geq 2\ \text{k}\Omega$ (R_L to $1/2\ V^+$)
Output Voltage (Low)	V_{OL}		1.3	1.6	V	$R_L \geq 2\ \text{k}\Omega$ (R_L to $1/2\ V^+$)
Common Model Input Voltage Range	V_{ICM}	1.5		3.5	V	
Slew Rate	SR		4		V/ μs	$R_L \geq 2\ \text{k}\Omega$, $A_V = +1$
Gain Band Width Product	GBW		12		MHz	

Notes: *1. Input bias currents flow out from IC. Because each current is base current of PNP-transistor on input stage.

*2. This is a current that flows in the internal circuit. This current flows irrespective of the existence of use.

MEASUREMENT CIRCUIT

Figure1 Total Harmonic Distortion Measurement Circuit

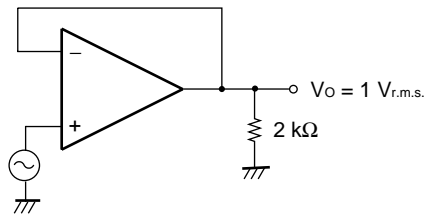

Figure2 Noise Measurement Circuit (RIAA)

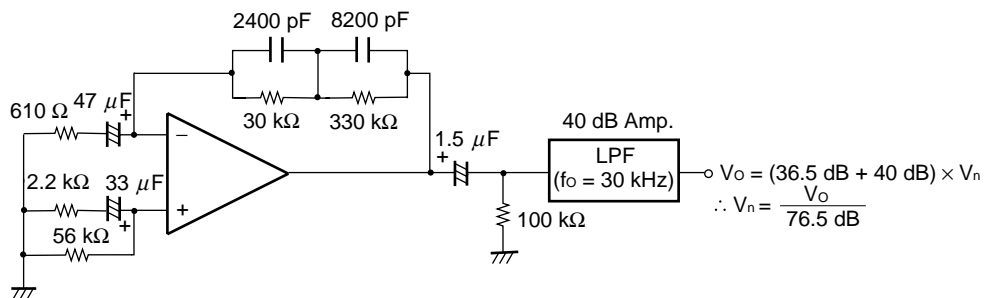
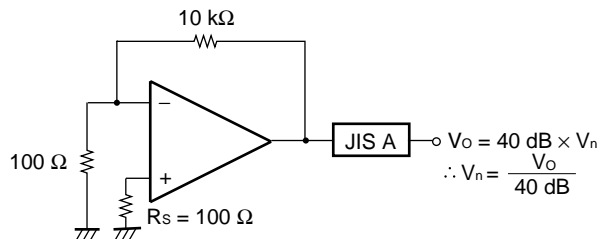
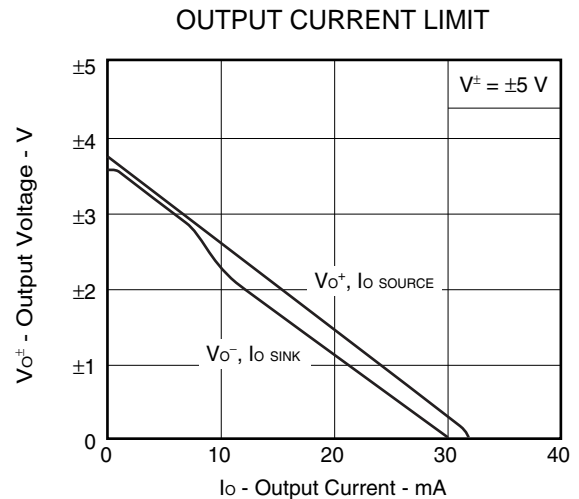
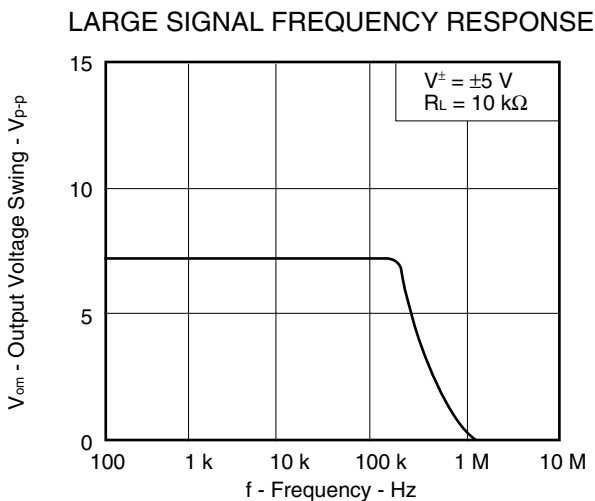
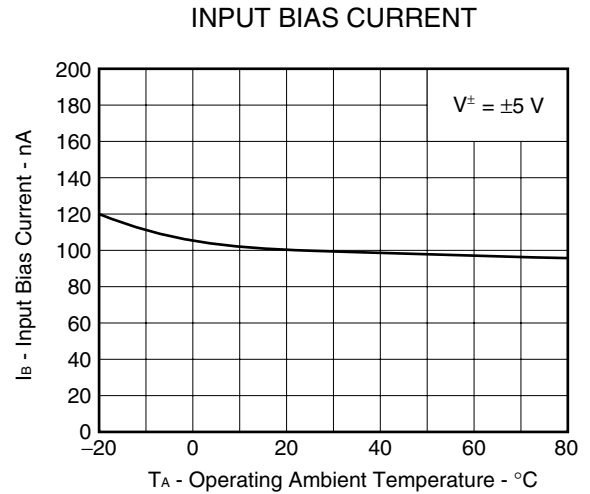
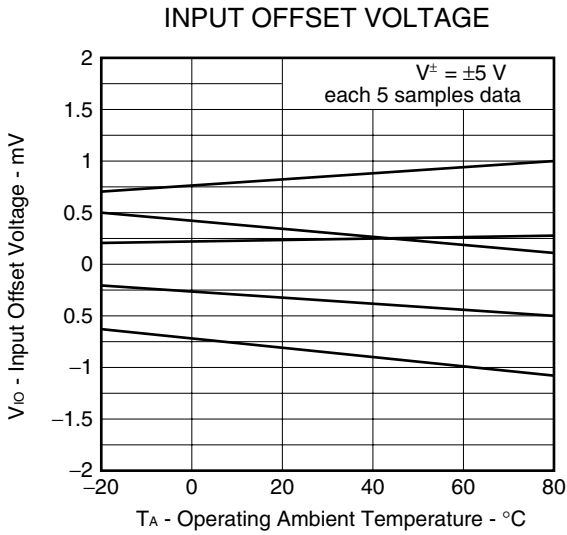
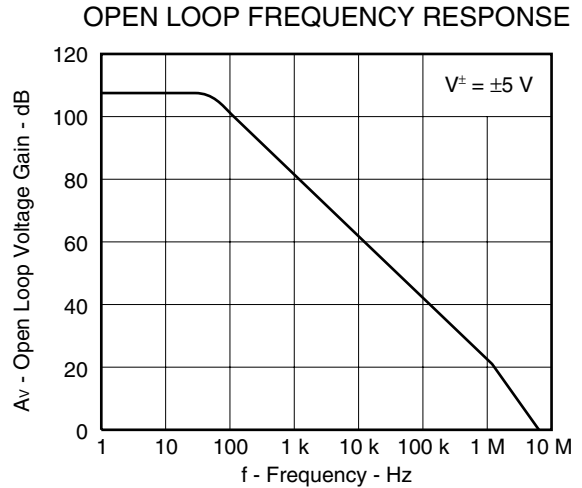
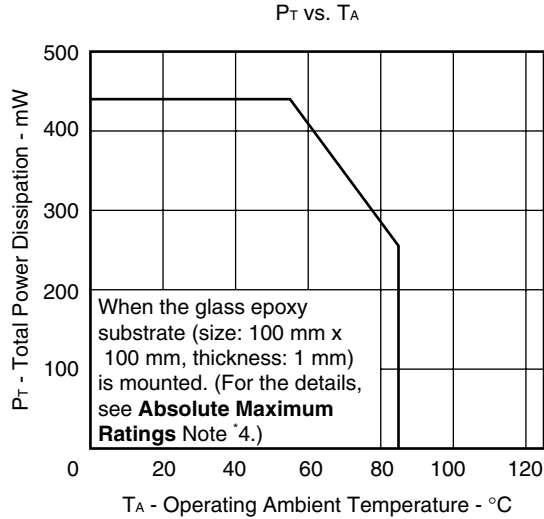

Figure3 Noise Measurement Circuit (FLAT+JIS A)



Typical Characteristics (T_A = 25°C, TYP.) (Reference value)



SUPPLY CURRENT vs. TEMPERATURE

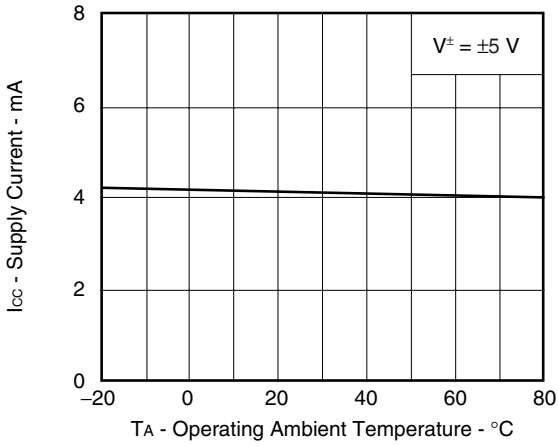

SUPPLY CURRENT vs. SUPPLY VOLTAGE

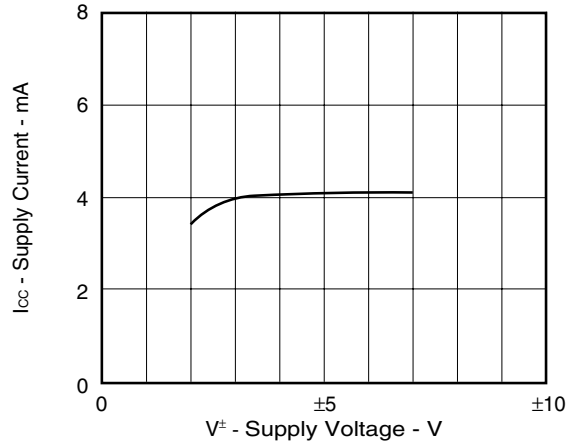

COMMON MODE INPUT VOLTAGE RANGE

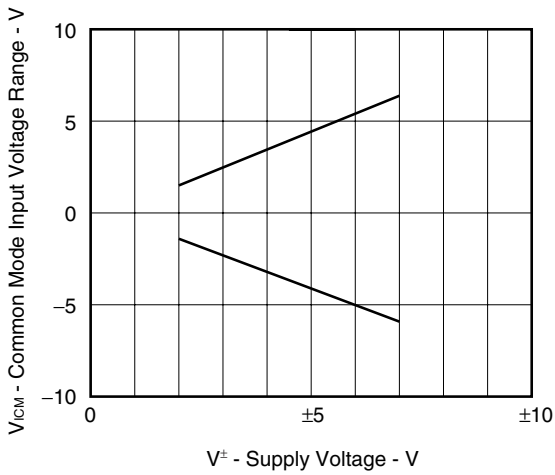

VOLTAGE FOLLOWER PULSE RESPONSE

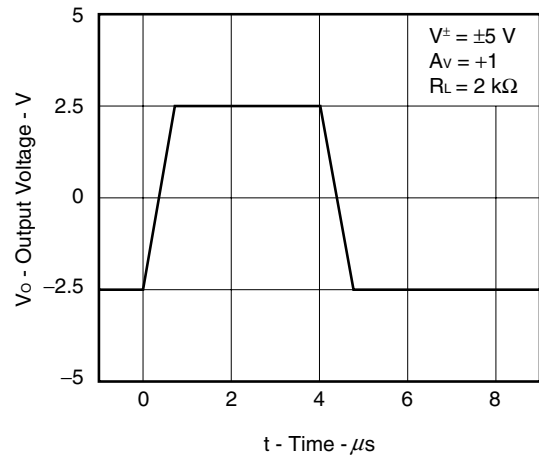

INPUT EQUIVALENT NOISE VOLTAGE (FLAT+JIS A)

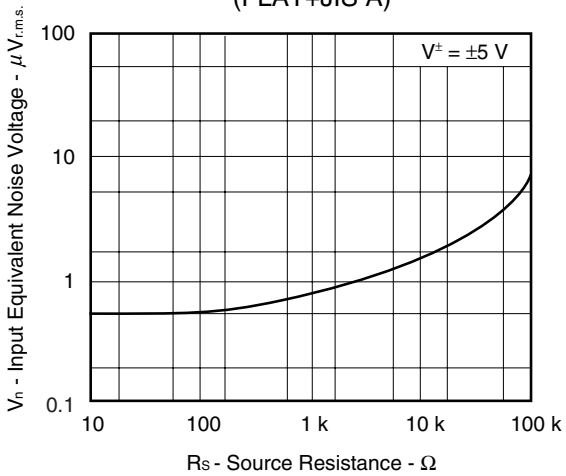

INPUT EQUIVALENT NOISE VOLTAGE DENSITY

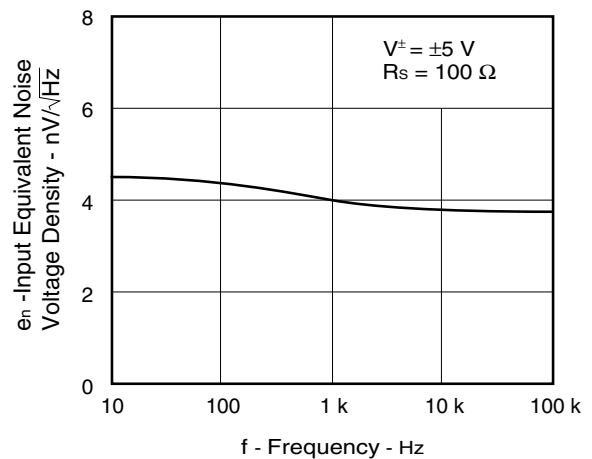

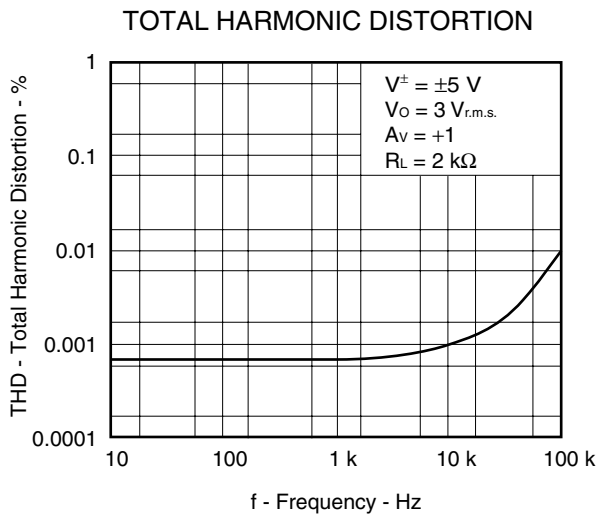

PRECAUTIONS FOR USE

- **The process of unused circuits**

If there is an unused circuit, the following connection is recommended.

Process example of unused circuits

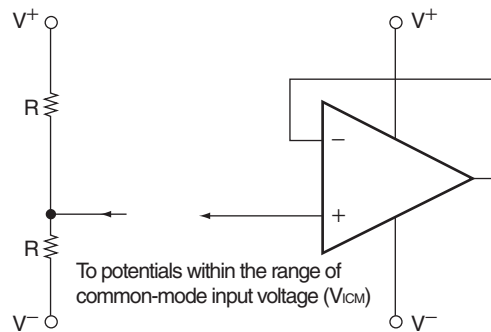

Remark A midpoint potential of V⁺ and V⁻ is applied to this example.

- **Power supply used (Split/Single)**

The input voltage should be allowed to input without damage or destruction. Even during the transition period of supply voltage, power on/off etc., this specification should be kept. The normal operation will establish when the both inputs are within the Common Mode Input Voltage Range of electrical characteristics.

- **Ratings of input/output pin voltage**

When the voltage of input/output pin exceeds the absolute maximum rating, it may cause degradation of characteristics or damages, by a conduction of a parasitic diode within an IC. In addition, when the input pin may be lower than V⁻, or the output pin may exceed the power supply voltage, it is recommended to make a clamp circuit by a diode whose forward voltage is low (e.g.: Schottky diode) for protection.

- **Range of common-mode input voltage**

When the supply voltage does not meet the condition of electrical characteristics, the range of common-mode input voltage is as follows.

V_{ICM} (TYP.): V⁻ + 1 (V) to V⁺ - 1 (V) (T_A = 25°C)

During designing, temperature characteristics for use with allowance.

- **The maximum output voltage**

The range of the TYP. value of the maximum output voltage when the supply voltage does not meet the condition of electrical characteristics is as follows:

V_{om⁺} (TYP.): V⁺ - 1.3 (V) (T_A = 25°C), V_{om⁻} (TYP.): V⁻ + 1.3 (V) (T_A = 25°C)

During designing, consider variations in characteristics and temperature characteristics for use with allowance.

In addition, also note that the output voltage range (V_{om⁺} - V_{om⁻}) becomes narrow when an output current increases.

- **Handling of ICs**

When stress is added to ICs due to warpage or bending of a board, the characteristic fluctuates due to piezoelectric effect. Therefore, pay attention to warpage or bending of a board.

Package Drawings

8-pin Plastic SOP (3.9 × 4.9)

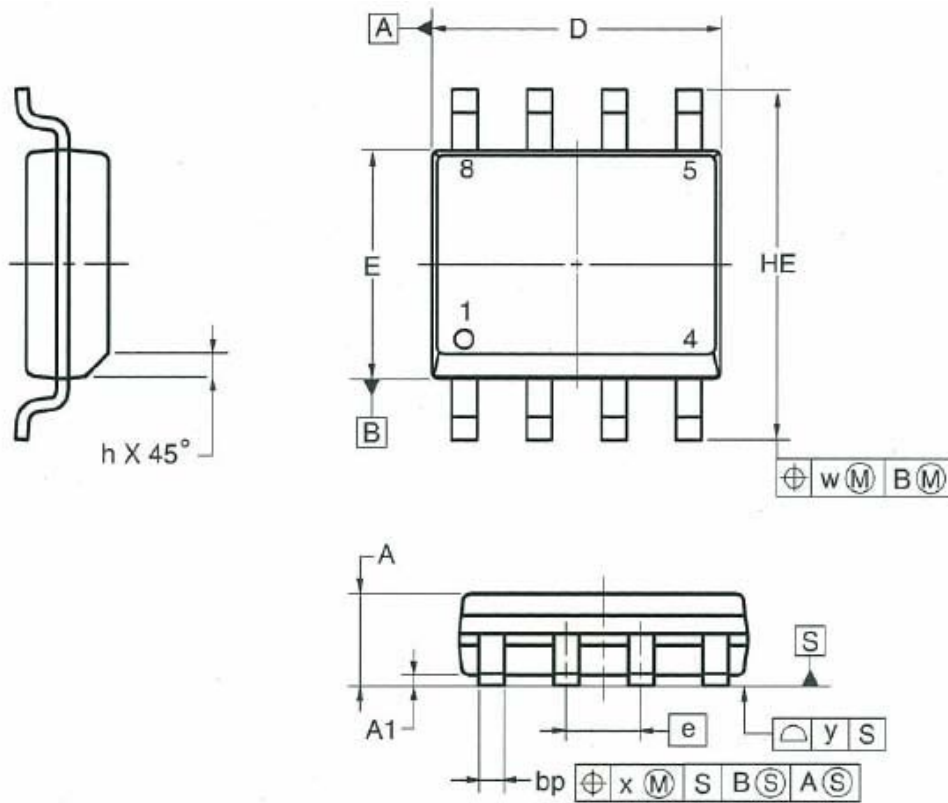

detail of lead end

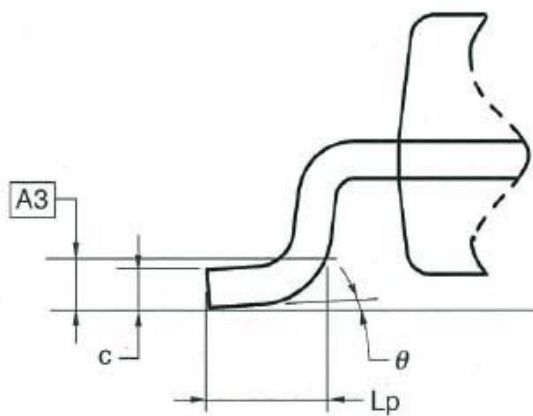

(UNIT:mm)

ITEM	DIMENSIONS
D	4.80 to 5.00
E	3.80 to 4.00
HE	5.80 to 6.20
e	1.27
bp	0.35 to 0.49
A	1.35 to 1.75
A1	0.10 to 0.25
A3	0.25
c	0.19 to 0.25
Lp	0.40 to 1.25
h	0.25 to 0.50
w	0.25
x	0.25
y	0.10
θ	0° to 7°

Revision History	μPC4572MF-DAA Data Sheet
-------------------------	--

Rev.	Date	Description	
		Page	Summary
1.00	Jul 25, 2012	–	First Edition Issued

All trademarks and registered trademarks are the property of their respective owners.

Notice

1. Descriptions of circuits, software and other related information in this document are provided only to illustrate the operation of semiconductor products and application examples. You are fully responsible for the incorporation of these circuits, software, and information in the design of your equipment. Renesas Electronics assumes no responsibility for any losses incurred by you or third parties arising from the use of these circuits, software, or information.
 2. Renesas Electronics has used reasonable care in preparing the information included in this document, but Renesas Electronics does not warrant that such information is error free. Renesas Electronics assumes no liability whatsoever for any damages incurred by you resulting from errors in or omissions from the information included herein.
 3. Renesas Electronics does not assume any liability for infringement of patents, copyrights, or other intellectual property rights of third parties by or arising from the use of Renesas Electronics products or technical information described in this document. No license, express, implied or otherwise, is granted hereby under any patents, copyrights or other intellectual property rights of Renesas Electronics or others.
 4. You should not alter, modify, copy, or otherwise misappropriate any Renesas Electronics product, whether in whole or in part. Renesas Electronics assumes no responsibility for any losses incurred by you or third parties arising from such alteration, modification, copy or otherwise misappropriation of Renesas Electronics product.
 5. Renesas Electronics products are classified according to the following two quality grades: "Standard" and "High Quality". The recommended applications for each Renesas Electronics product depends on the product's quality grade, as indicated below.
"Standard": Computers; office equipment; communications equipment; test and measurement equipment; audio and visual equipment; home electronic appliances; machine tools; personal electronic equipment; and industrial robots etc.
"High Quality": Transportation equipment (automobiles, trains, ships, etc.); traffic control systems; anti-disaster systems; anti-crime systems; and safety equipment etc.
Renesas Electronics products are neither intended nor authorized for use in products or systems that may pose a direct threat to human life or bodily injury (artificial life support devices or systems, surgical implantations etc.), or may cause serious property damages (nuclear reactor control systems, military equipment etc.). You must check the quality grade of each Renesas Electronics product before using it in a particular application. You may not use any Renesas Electronics product for any application for which it is not intended. Renesas Electronics shall not be in any way liable for any damages or losses incurred by you or third parties arising from the use of any Renesas Electronics product for which the product is not intended by Renesas Electronics.
 6. You should use the Renesas Electronics products described in this document within the range specified by Renesas Electronics, especially with respect to the maximum rating, operating supply voltage range, movement power voltage range, heat radiation characteristics, installation and other product characteristics. Renesas Electronics shall have no liability for malfunctions or damages arising out of the use of Renesas Electronics products beyond such specified ranges.
 7. Although Renesas Electronics endeavors to improve the quality and reliability of its products, semiconductor products have specific characteristics such as the occurrence of failure at a certain rate and malfunctions under certain use conditions. Further, Renesas Electronics products are not subject to radiation resistance design. Please be sure to implement safety measures to guard them against the possibility of physical injury, and injury or damage caused by fire in the event of the failure of a Renesas Electronics product, such as safety design for hardware and software including but not limited to redundancy, fire control and malfunction prevention, appropriate treatment for aging degradation or any other appropriate measures. Because the evaluation of microcomputer software alone is very difficult, please evaluate the safety of the final products or systems manufactured by you.
 8. Please contact a Renesas Electronics sales office for details as to environmental matters such as the environmental compatibility of each Renesas Electronics product. Please use Renesas Electronics products in compliance with all applicable laws and regulations that regulate the inclusion or use of controlled substances, including without limitation, the EU RoHS Directive. Renesas Electronics assumes no liability for damages or losses occurring as a result of your noncompliance with applicable laws and regulations.
 9. Renesas Electronics products and technology may not be used for or incorporated into any products or systems whose manufacture, use, or sale is prohibited under any applicable domestic or foreign laws or regulations. You should not use Renesas Electronics products or technology described in this document for any purpose relating to military applications or use by the military, including but not limited to the development of weapons of mass destruction. When exporting the Renesas Electronics products or technology described in this document, you should comply with the applicable export control laws and regulations and follow the procedures required by such laws and regulations.
 10. It is the responsibility of the buyer or distributor of Renesas Electronics products, who distributes, disposes of, or otherwise places the product with a third party, to notify such third party in advance of the contents and conditions set forth in this document, Renesas Electronics assumes no responsibility for any losses incurred by you or third parties as a result of unauthorized use of Renesas Electronics products.
 11. This document may not be reproduced or duplicated in any form, in whole or in part, without prior written consent of Renesas Electronics.
 12. Please contact a Renesas Electronics sales office if you have any questions regarding the information contained in this document or Renesas Electronics products, or if you have any other inquiries.
- (Note 1) "Renesas Electronics" as used in this document means Renesas Electronics Corporation and also includes its majority-owned subsidiaries.
(Note 2) "Renesas Electronics product(s)" means any product developed or manufactured by or for Renesas Electronics.



SALES OFFICES

Renesas Electronics Corporation

<http://www.renesas.com>

Refer to "<http://www.renesas.com/>" for the latest and detailed information.

Renesas Electronics America Inc.
2880 Scott Boulevard Santa Clara, CA 95050-2554, U.S.A.
Tel: +1-408-588-6000, Fax: +1-408-588-6130

Renesas Electronics Canada Limited
1101 Nicholson Road, Newmarket, Ontario L3Y 9C3, Canada
Tel: +1-905-898-5441, Fax: +1-905-898-3220

Renesas Electronics Europe Limited
Dukes Meadow, Millboard Road, Bourne End, Buckinghamshire, SL8 5FH, U.K.
Tel: +44-1628-585-100, Fax: +44-1628-585-900

Renesas Electronics Europe GmbH
Arcadiastrasse 10, 40472 Düsseldorf, Germany
Tel: +49-211-65030, Fax: +49-211-6503-1327

Renesas Electronics (China) Co., Ltd.
7th Floor, Quantum Plaza, No.27 ZhiChunLu Haidian District, Beijing 100083, P.R.China
Tel: +86-10-8235-1155, Fax: +86-10-8235-7679

Renesas Electronics (Shanghai) Co., Ltd.
Unit 204, 205, AZIA Center, No.1233 Lujiazui Ring Rd., Pudong District, Shanghai 200120, China
Tel: +86-21-5877-1818, Fax: +86-21-6887-7858 / -7898

Renesas Electronics Hong Kong Limited
Unit 1601-1613, 16/F., Tower 2, Grand Century Place, 193 Prince Edward Road West, Mongkok, Kowloon, Hong Kong
Tel: +852-2886-9318, Fax: +852 2886-9022/9044

Renesas Electronics Taiwan Co., Ltd.
13F, No. 363, Fu Shing North Road, Taipei, Taiwan
Tel: +886-2-8175-9600, Fax: +886 2-8175-9670

Renesas Electronics Singapore Pte. Ltd.
1 HarbourFront Avenue, #06-10, Keppel Bay Tower, Singapore 098632
Tel: +65-6213-0200, Fax: +65-6278-8001

Renesas Electronics Malaysia Sdn.Bhd.
Unit 906, Block B, Menara Amcorp, Amcorp Trade Centre, No. 18, Jln Persiaran Barat, 46050 Petaling Jaya, Selangor Darul Ehsan, Malaysia
Tel: +60-3-7955-9390, Fax: +60-3-7955-9510

Renesas Electronics Korea Co., Ltd.
11F., Samik Laved or Bldg., 720-2 Yeoksam-Dong, Kangnam-Ku, Seoul 135-080, Korea
Tel: +82-2-558-3737, Fax: +82-2-558-5141