

UPC811

High Stability,

Low Offset Voltage J-FET Input Operational Amplifier

DESCRIPTION

UPC811 is a unique J-FET input operational amplifier that uses a high-speed PNP transistor ($f_T = 300 \text{ MHz}$) for the output stage to achieve fast response and high stability.

The resistor-trimming method proven in other Renesas High-Precision Op-Amp and High-Precision reference voltage is incorporate in this Op-Amp input stage, thus producing an excellent low offset voltage characteristics that has surpasses conventional general purpose op-amp in spite of being J-FET input.

Along with this series of lineup, the dual type operational amplifier, UPC812 and 4092 with the same circuit configuration are also available.

FEATURES

- Input Offset Voltage $\pm 1 \text{ mV (TYP.) (}\pm 2.5 \text{ mV MAX.)}$
- V_{IO} Temperature Drift $\pm 7 \mu\text{V}/^\circ\text{C (TYP.)}$
- Input Bias Current 50 pA (TYP.)
- Slew Rate $15 \text{ V}/\mu\text{s (TYP.)}$
- Unity Gain Frequency 4 MHz (TYP.)
- Input Equivalent Noise Voltage Density $19 \text{ nV}/\sqrt{\text{Hz}} \text{ (TYP.) (}f = 1 \text{ kHz)}$
- Stable operation against capacitive load (Capacitive Load at 10000 pF , $AV = +1$)
- Built-In Phase Compensation Circuit
- Built-In Output Short Circuit Protection
- Standard Single Op-Amp terminal connection (pin compatible)

ORDERING INFORMATION

Order Name ⁽¹⁾	Package
UPC811G2-AP	8-Pin plastic SOP (5.72 mm (225))

(1) Order names containing E1 or E2 indicate that the packaging format is embossed taping.
Pin 1 of E1 is on draw-out side, and pin 1 of E2 is at take-up side.

EQUIVALENT CIRCUIT

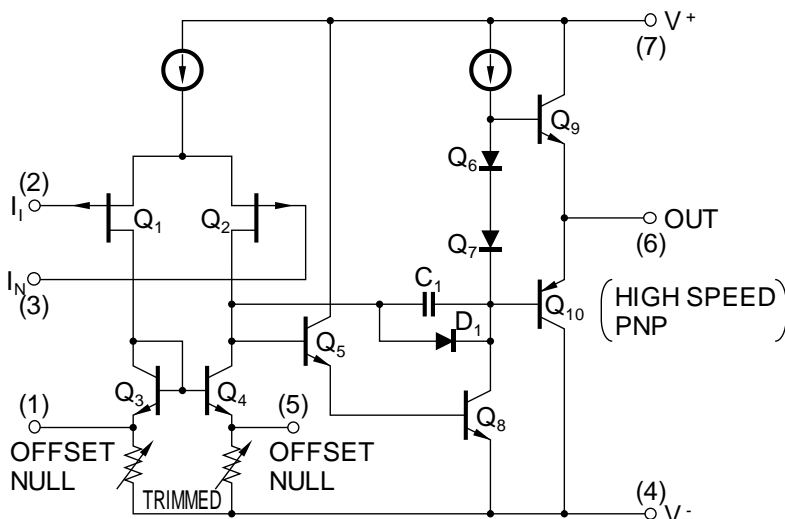

PIN CONFIGURATION (Top View)

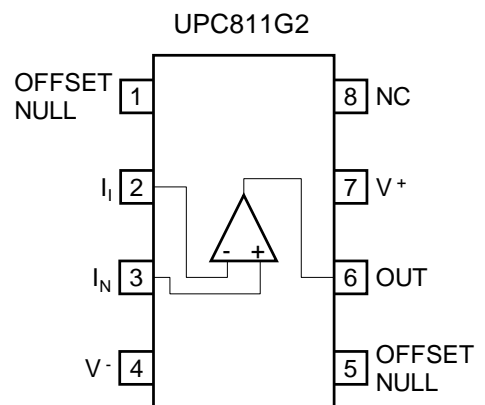

Note NC : No Connection

ABSOLUTE MAXIMUM RATINGS (T_A = 25 °C)

Parameter	Symbol	UPC811G2	Unit
Supply Voltage ^{Note1}	V ⁺ - V ⁻	-0.3 ~ +36	V
Differential Input Voltage	V _{ID}	±30	V
Input Voltage ^{Note2}	V _I	V ⁻ -0.3 ~ V ⁺ +0.3	V
Output Applied Voltage ^{Note3}	V _O	V ⁻ -0.3 ~ V ⁺ +0.3	V
Total Power Dissipation ^{Note4}	P _T	440	mW
Output Short Circuit Duration ^{Note5}		Indefinite	s
Operating Ambient Temperature	T _A	-40 ~ +85	°C
Storage Temperature	T _{stg}	-55 ~ +125	°C

- [Note]**
- Note that reverse connections of the power supply may damage the ICs.
 - The input terminal must be apply within the input voltage range to avoid deteriorating or damaging the device characteristic. Do not exceed the ratings including during transition state such as ON/OFF, etc. The Op-Amp input voltage must operates within the electrical characteristics range of input common-mode voltage.
 - The output terminal must be apply within the output voltage range to avoid deteriorating or damaging the device characteristic. Do not exceed the ratings including during transition state such as ON/OFF, etc. The Op-Amp output voltage must operates within the electrical characteristics range of maximum output voltage.
 - This is the value at T_A ≤ +25 °C. De-rate value at -4.4 mW/°C when T_A > 25 °C.
 - Please use the total loss and the de-rating value from Note 4.

RECOMMENDED OPERATING CONDITIONS

Parameter	Symbol	MIN.	TYP.	MAX.	Unit
Power Supply Voltage	V [±]	±5		±16	V
Load Current	I _o			±10	mA
Load Capacitance (When A _v = +1)	C _L			10000 ^{Note6}	pF

- [Note]** 6. This is the value when the feedback resistor (R_f) = 0 Ω. The higher the R_f value, the more likely it is to oscillate due to the influence of the input capacitance. So connect a capacitor of about 100 pF in parallel with R_f.

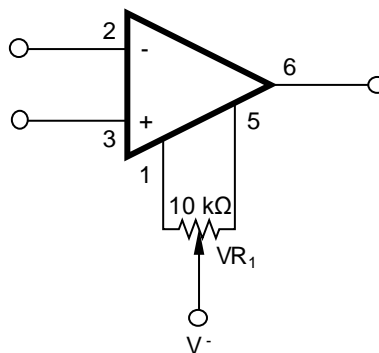
OFFSET ADJUSTMENT METHOD

- [Note]** OFFSET NULL pin should be open or connected to V⁻ via a resistor as shown above. Any connection other than V⁻ may cause malfunction, characteristics degradation or damage.

ELECTRICAL CHARACTERISTICS (T_A = 25 °C, V[±] = ±15 V)

Parameter	Symbol	MIN.	TYP.	MAX.	Unit	Test Condition
Input Offset Voltage	V _{IO}		±1	±2.5	mV	R _S ≤ 50 Ω
Input Offset Current ^{Note7}	I _{IO}		±25	±100	pA	
Input Bias Current ^{Note7}	I _B		50	200	pA	
Large Signal Voltage Gain	A _V	25	200		V/mV	R _L ≥ 2 kΩ, V _O = ±10 V
Circuit Current	I _{CC}		2.5	3.4	mA	I _O = 0 A
Common Mode Rejection Ratio	CMR	70	100		dB	
Supply Voltage Rejection Ratio	SVR	70	100		dB	
Output Voltage Swing	V _{om}	±12	+14.0 -13.3		V	R _L ≥ 10 kΩ
Output Voltage Swing	V _{om}	±10	+13.5 -12.8		V	R _L ≥ 2 kΩ
Common Model Input Voltage Range	V _{ICM}	±11	+14 -12		V	
Slew Rate	SR		15		V/μs	A _V = 1
Unity Gain Frequency	f _{unity}		4		MHz	
Input Equivalent Noise Voltage Density	e _n		19		nV/√Hz	R _S = 100 Ω, f = 1 kHz
Input Offset Voltage	V _{IO}			±5	mV	R _S ≤ 50 Ω, T _A = -20 ~ +70 °C
Average V _{IO} Temperature Drift	ΔV _{IO} /ΔT		±7		μV/°C	T _A = -20 ~ +70 °C
Input Offset Current ^{Note7}	I _{IO}			±2	nA	T _A = -20 ~ +70 °C
Input Bias Current ^{Note7}	I _B			7	nA	T _A = -20 ~ +70 °C

[Note] 7. The direction of the input bias current is the same direction that flows into the IC because the first stage is composed of Pch J-FET. When T_J = 25°C or higher, it increases exponentially with increase in temperature (please see I_B - T_A characteristics). During measurement, please kindly take care of T_J ≐ T_A.

Caution

Since UPC811 has high input impedance characteristics, please be careful of insulation between the terminals on the board.

ELECTRICAL CHARACTERISTICS CURVE (T_A = 25 °C, TYP.)

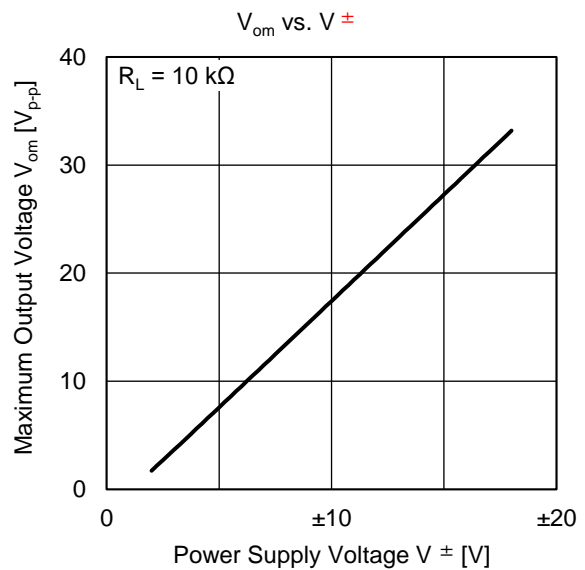
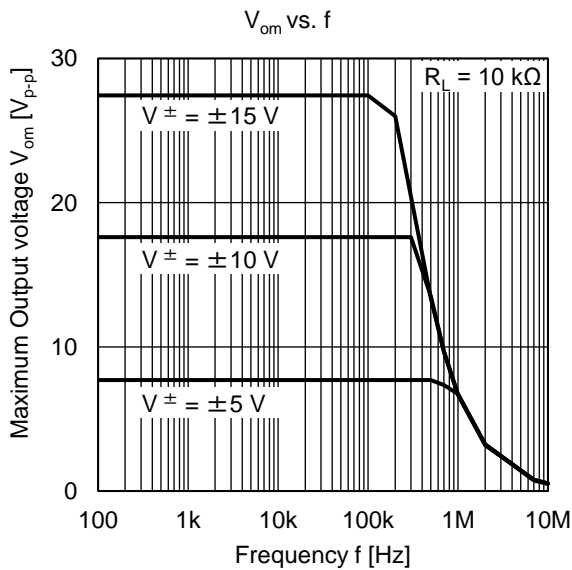
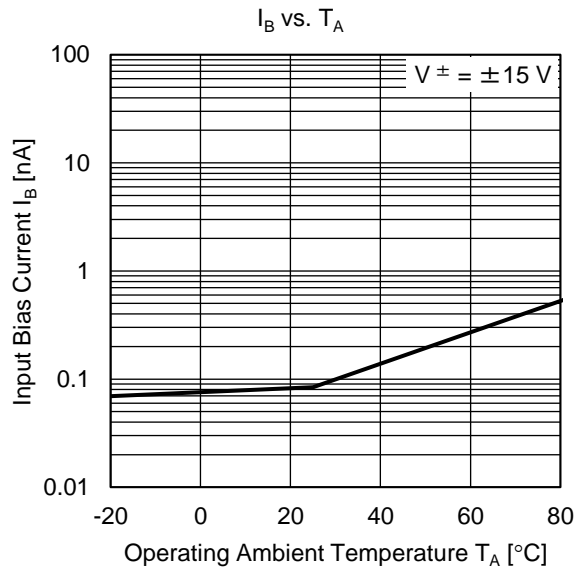
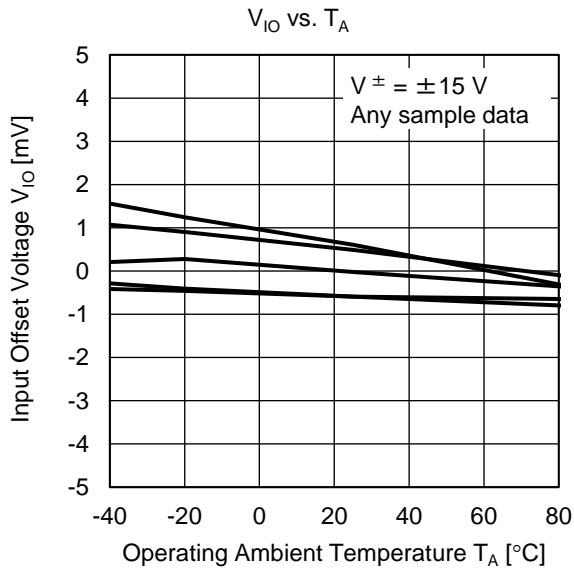
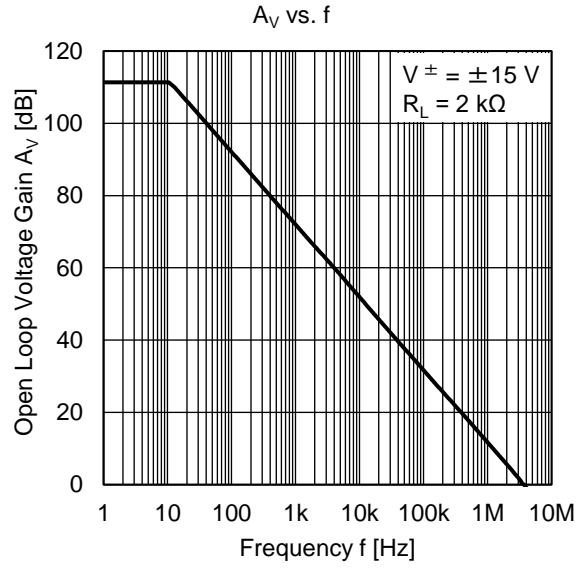
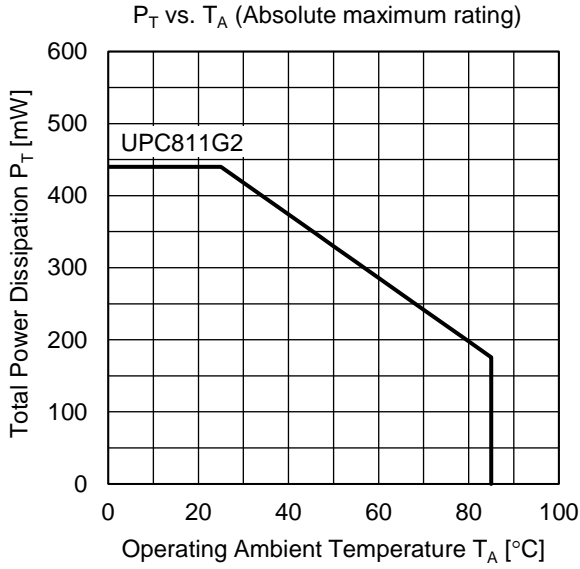

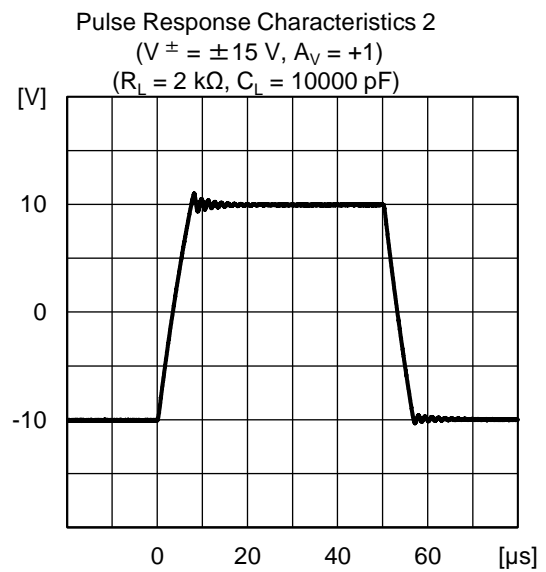
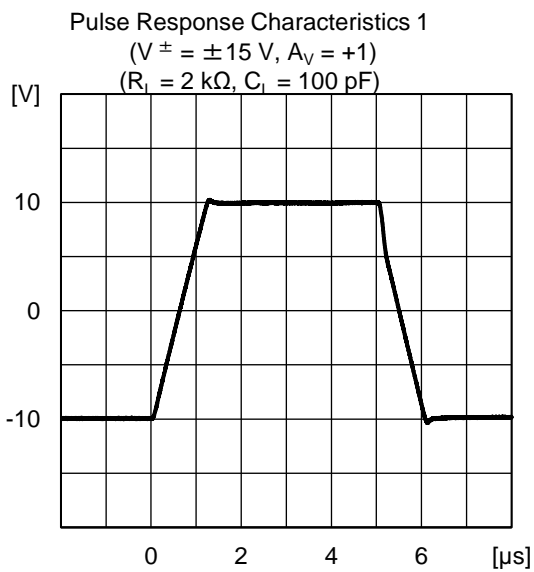
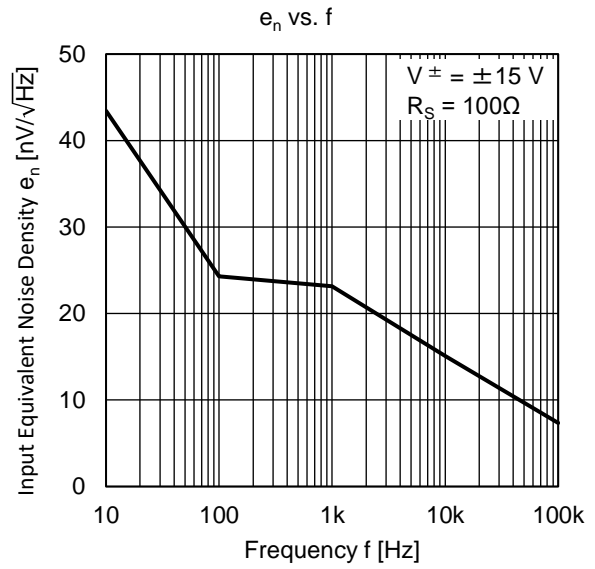
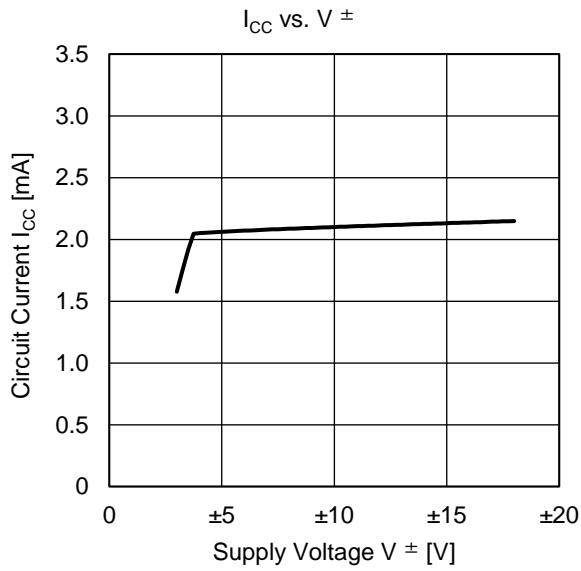
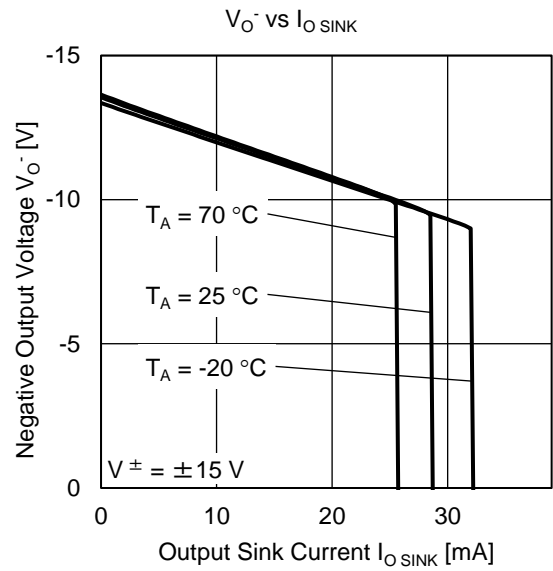
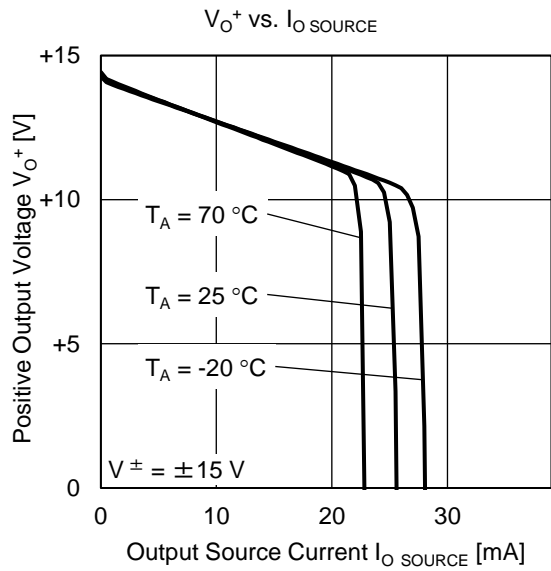

USE WITH PRECAUTIONS

- **Power Supply (Dual Power Supply / Single Power Supply)**

The op amp operates when a predetermine voltage is applied between V^+ - V^- . Therefore, while it operates from a single power supply ($V^- = \text{GND}$), it is not possible to operate the input and output near GND. So please be careful of the common-mode input voltage range and maximum output voltage.

- **Ratings of input/output pin voltage**

When the voltage of input/output pin exceeds the absolute maximum rating, the parasitic diode within the IC may conduct, causing characteristics degradation or damage. In addition, if the input pin is lower than V^- , or the output pin exceeds the power supply voltage, it is recommended to make a clamping circuit using a diode with low forward voltage (e.g.: Schottky diode) as protection.

- **Range of common-mode input voltage**

When the supply voltage does not meet the condition of electrical characteristics, the range of common-mode input voltage is as follows.

$$V_{\text{ICM}} (\text{TYP.}): V^- + 3 \sim V^+ - 1 \text{ [V]} (T_A = 25^\circ\text{C}).$$

During designing, do include some margin by considering characteristics variation, temperature characteristics etc.

- **Maximum output voltage**

The TYP. value range of the maximum output voltage when the supply voltage does not meet the condition of electrical characteristics is as follows:

$$V_{\text{om}^+} (\text{TYP.}): V^+ - 1 \text{ [V]} (T_A = 25^\circ\text{C}), \quad V_{\text{om}^-} (\text{TYP.}): V^- + 1.7 \text{ [V]} (T_A = 25^\circ\text{C})$$

During designing, do include some margin by considering characteristics variation, temperature characteristics and so on. In addition, also note that the output voltage range ($V_{\text{om}^+} - V_{\text{om}^-}$) will become narrow when the output current increases.

- **Handling of ICs**

When stress is added to the ICs due to warpage or bending of a board, the characteristic may fluctuates due to piezoelectric (piezo) effect. Therefore, pay attention to warpage or bending of a board.

PACKAGE DRAWINGS

8-PIN PLASTIC SOP

JEITA Package code	RENESAS code	MASS (TYP.) [g]
P-LSOP8-4.4x5.2-1.27	PLSP0008DE-A	0.09[g]

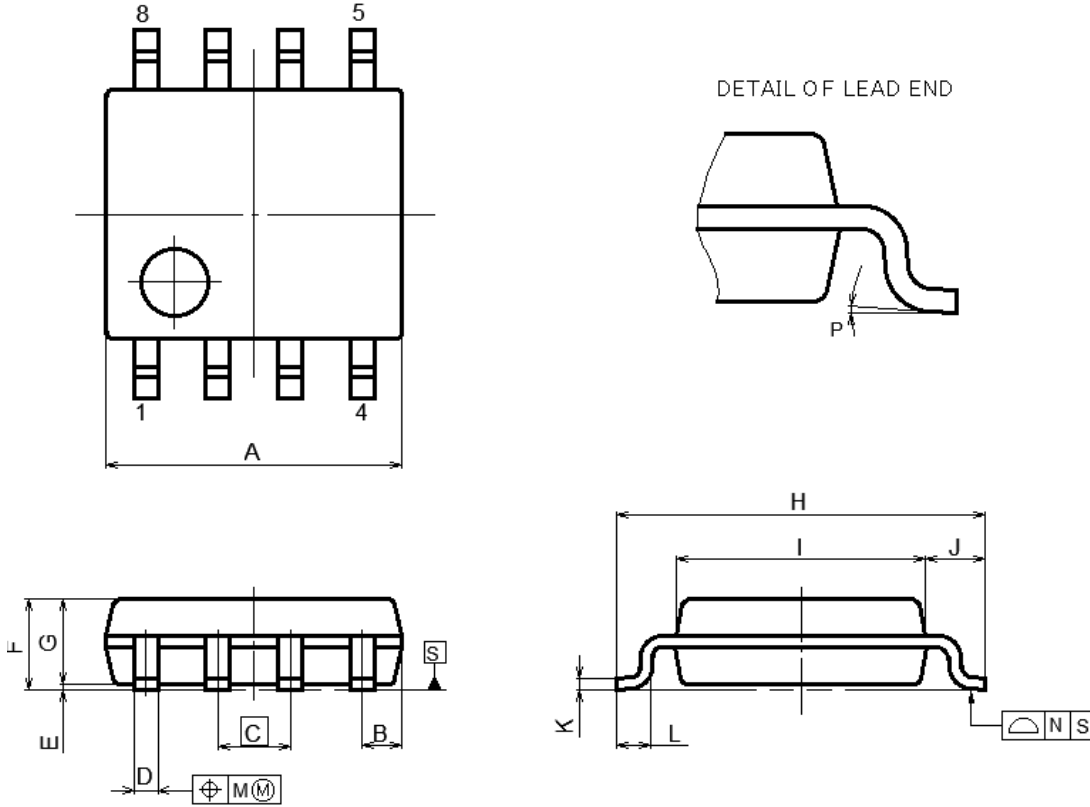

NOTE
 EACH LEAD CENTERLINE IS LOCATED WITHIN 0.12 MM OF
 ITS TRUE POSITION(T.P.) AT MAXIMUM MATERIAL CONDITION.

(UNIT:mm)

ITEM	DIMENSIONS
A	5.2±0.17
B	0.78MAX
C	1.27(T.P)
D	0.40±0.05
E	0.1±0.1
F	1.59±0.21
G	1.49
H	6.5±0.3
I	4.4±0.1
J	1.05±0.15
K	0.2±0.07
L	0.6±0.20
M	0.1MAX
N	0.1MAX
P	4°±4°

Notice

1. Descriptions of circuits, software and other related information in this document are provided only to illustrate the operation of semiconductor products and application examples. You are fully responsible for the incorporation or any other use of the circuits, software, and information in the design of your product or system. Renesas Electronics disclaims any and all liability for any losses and damages incurred by you or third parties arising from the use of these circuits, software, or information.
 2. Renesas Electronics hereby expressly disclaims any warranties against and liability for infringement or any other claims involving patents, copyrights, or other intellectual property rights of third parties, by or arising from the use of Renesas Electronics products or technical information described in this document, including but not limited to, the product data, drawings, charts, programs, algorithms, and application examples.
 3. No license, express, implied or otherwise, is granted hereby under any patents, copyrights or other intellectual property rights of Renesas Electronics or others.
 4. You shall be responsible for determining what licenses are required from any third parties, and obtaining such licenses for the lawful import, export, manufacture, sales, utilization, distribution or other disposal of any products incorporating Renesas Electronics products, if required.
 5. You shall not alter, modify, copy, or reverse engineer any Renesas Electronics product, whether in whole or in part. Renesas Electronics disclaims any and all liability for any losses or damages incurred by you or third parties arising from such alteration, modification, copying or reverse engineering.
 6. Renesas Electronics products are classified according to the following two quality grades: "Standard" and "High Quality". The intended applications for each Renesas Electronics product depends on the product's quality grade, as indicated below.
 - "Standard": Computers; office equipment; communications equipment; test and measurement equipment; audio and visual equipment; home electronic appliances; machine tools; personal electronic equipment; industrial robots; etc.
 - "High Quality": Transportation equipment (automobiles, trains, ships, etc.); traffic control (traffic lights); large-scale communication equipment; key financial terminal systems; safety control equipment; etc.
- Unless expressly designated as a high reliability product or a product for harsh environments in a Renesas Electronics data sheet or other Renesas Electronics document, Renesas Electronics products are not intended or authorized for use in products or systems that may pose a direct threat to human life or bodily injury (artificial life support devices or systems; surgical implantations; etc.), or may cause serious property damage (space system; undersea repeaters; nuclear power control systems; aircraft control systems; key plant systems; military equipment; etc.). Renesas Electronics disclaims any and all liability for any damages or losses incurred by you or any third parties arising from the use of any Renesas Electronics product that is inconsistent with any Renesas Electronics data sheet, user's manual or other Renesas Electronics document.
7. No semiconductor product is absolutely secure. Notwithstanding any security measures or features that may be implemented in Renesas Electronics hardware or software products, Renesas Electronics shall have absolutely no liability arising out of any vulnerability or security breach, including but not limited to any unauthorized access to or use of a Renesas Electronics product or a system that uses a Renesas Electronics product. RENESAS ELECTRONICS DOES NOT WARRANT OR GUARANTEE THAT RENESAS ELECTRONICS PRODUCTS, OR ANY SYSTEMS CREATED USING RENESAS ELECTRONICS PRODUCTS WILL BE INVULNERABLE OR FREE FROM CORRUPTION, ATTACK, VIRUSES, INTERFERENCE, HACKING, DATA LOSS OR THEFT, OR OTHER SECURITY INTRUSION ("Vulnerability Issues"). RENESAS ELECTRONICS DISCLAIMS ANY AND ALL RESPONSIBILITY OR LIABILITY ARISING FROM OR RELATED TO ANY VULNERABILITY ISSUES. FURTHERMORE, TO THE EXTENT PERMITTED BY APPLICABLE LAW, RENESAS ELECTRONICS DISCLAIMS ANY AND ALL WARRANTIES, EXPRESS OR IMPLIED, WITH RESPECT TO THIS DOCUMENT AND ANY RELATED OR ACCOMPANYING SOFTWARE OR HARDWARE, INCLUDING BUT NOT LIMITED TO THE IMPLIED WARRANTIES OF MERCHANTABILITY, OR FITNESS FOR A PARTICULAR PURPOSE.
 8. When using Renesas Electronics products, refer to the latest product information (data sheets, user's manuals, application notes, "General Notes for Handling and Using Semiconductor Devices" in the reliability handbook, etc.), and ensure that usage conditions are within the ranges specified by Renesas Electronics with respect to maximum ratings, operating power supply voltage range, heat dissipation characteristics, installation, etc. Renesas Electronics disclaims any and all liability for any malfunctions, failure or accident arising out of the use of Renesas Electronics products outside of such specified ranges.
 9. Although Renesas Electronics endeavors to improve the quality and reliability of Renesas Electronics products, semiconductor products have specific characteristics, such as the occurrence of failure at a certain rate and malfunctions under certain use conditions. Unless designated as a high reliability product or a product for harsh environments in a Renesas Electronics data sheet or other Renesas Electronics document, Renesas Electronics products are not subject to radiation resistance design. You are responsible for implementing safety measures to guard against the possibility of bodily injury, injury or damage caused by fire, and/or danger to the public in the event of a failure or malfunction of Renesas Electronics products, such as safety design for hardware and software, including but not limited to redundancy, fire control and malfunction prevention, appropriate treatment for aging degradation or any other appropriate measures. Because the evaluation of microcomputer software alone is very difficult and impractical, you are responsible for evaluating the safety of the final products or systems manufactured by you.
 10. Please contact a Renesas Electronics sales office for details as to environmental matters such as the environmental compatibility of each Renesas Electronics product. You are responsible for carefully and sufficiently investigating applicable laws and regulations that regulate the inclusion or use of controlled substances, including without limitation, the EU RoHS Directive, and using Renesas Electronics products in compliance with all these applicable laws and regulations. Renesas Electronics disclaims any and all liability for damages or losses occurring as a result of your noncompliance with applicable laws and regulations.
 11. Renesas Electronics products and technologies shall not be used for or incorporated into any products or systems whose manufacture, use, or sale is prohibited under any applicable domestic or foreign laws or regulations. You shall comply with any applicable export control laws and regulations promulgated and administered by the governments of any countries asserting jurisdiction over the parties or transactions.
 12. It is the responsibility of the buyer or distributor of Renesas Electronics products, or any other party who distributes, disposes of, or otherwise sells or transfers the product to a third party, to notify such third party in advance of the contents and conditions set forth in this document.
 13. This document shall not be reprinted, reproduced or duplicated in any form, in whole or in part, without prior written consent of Renesas Electronics.
 14. Please contact a Renesas Electronics sales office if you have any questions regarding the information contained in this document or Renesas Electronics products.

(Note1) "Renesas Electronics" as used in this document means Renesas Electronics Corporation and also includes its directly or indirectly controlled subsidiaries.

(Note2) "Renesas Electronics product(s)" means any product developed or manufactured by or for Renesas Electronics.

(Rev.5.0-1 October 2020)

Corporate Headquarters

TOYOSU FORESIA, 3-2-24 Toyosu,
Koto-ku, Tokyo 135-0061, Japan
www.renesas.com

Trademarks

Renesas and the Renesas logo are trademarks of Renesas Electronics Corporation. All trademarks and registered trademarks are the property of their respective owners.

Contact information

For further information on a product, technology, the most up-to-date version of a document, or your nearest sales office, please visit:
www.renesas.com/contact/.