

Description

The XU devices are low phase noise quartz-based PLL oscillators supporting a large range of frequencies and output interface types. These devices are designed to operate at three different power supplies and are available in multiple package sizes as well as temperature grades.

With a patented one-time program (OTP) allowing for infinite memory shelf life, the XU devices can be programmed to generate an output frequency from 16kHz to 1500MHz with a resolution as low as 1Hz accuracy. The configuration capability of this family of devices allows for fast delivery times for both sample and large production orders.

Pin Assignments

Note: To minimize power supply line noise, a 0.01μF bypass capacitor should be placed between V_{DD} (Pin 6) and GND (Pin 3).

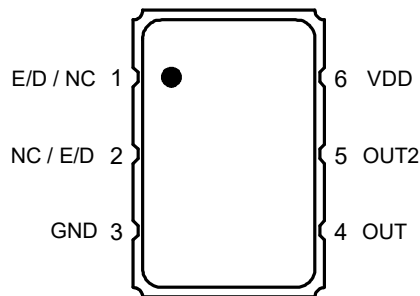

Table 1. Pin Description

Pin #	Name	Description
1	E/D NC	Enable/Disable ^{[a][b]} No connect
2	NC E/D	No connect Enable/Disable ^{[a][b]}
3	GND	Connect to ground
4	OUT	Output
5	OUT2	Complementary output ^[c]
6	V _{DD}	Supply voltage

[a] Pulled high internally = output enabled.

[b] Low = output disabled.

[c] Do not connect for LVCMOS. For XLVCMOS both OUT and OUT2 are ON and in opposite phase.

See [Ordering Information](#) for more details.

Features

- Frequency range: 0.016MHz to 1500MHz^[1]
- Output types: LVDS, LVPECL, HCSL, LVCMOS
- Supply voltage options: 1.8V, 2.5V, or 3.3V
- Phase jitter (1.875MHz to 20MHz): 100fs typical
- Phase jitter (12kHz to 20MHz): 300fs typical
- Package options:
 - 5.0 × 3.2 × 1.2 mm
 - 7.0 × 5.0 × 1.3 mm
- Operating temperature: -20°C to +70°C
 - Frequency stability options: ±20, ±25, ±50, or ±100 ppm
- Operating temperature: -40°C to +85°C
 - Frequency stability options: ±25, ±50, or ±100 ppm
- Operating temperature: -40°C to +105°C
 - Frequency stability options: ±50 or ±100 ppm

[1] There is a dead zone between 1037.5MHz to 1300MHz. Contact [support](#) for frequencies above 1300MHz.

Ordering Information

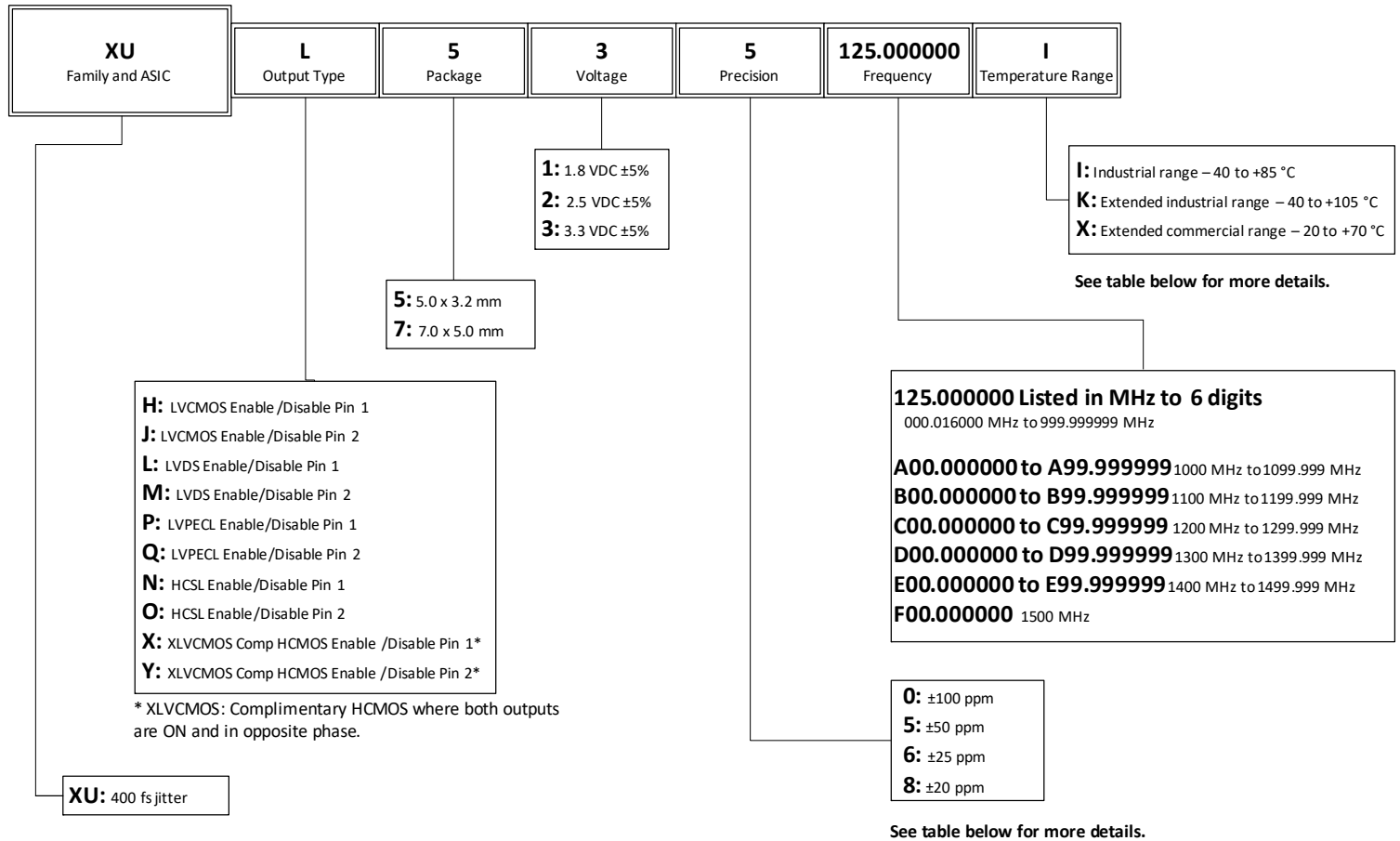

Table 2. Frequency Stability and Operating Temperature Decoder

"Precision" and "Temperature Range" Codes	Operating Temperature	Frequency Stability		
		Minimum	Maximum	Unit
"8" and "X"	-20°C to +70°C	-20	+20	ppm
"6" and "X"	-20°C to +70°C	-25	+25	ppm
"5" and "X"	-20°C to +70°C	-50	+50	ppm
"0" and "X"	-20°C to +70°C	-100	+100	ppm
"6" and "I"	-40°C to +85°C	-25	+25	ppm
"5" and "I"	-40°C to +85°C	-50	+50	ppm
"0" and "I"	-40°C to +85°C	-100	+100	ppm
"5" and "K"	-40° to +105°C	-50	+50	ppm
"0" and "K"	-40° to +105°C	-100	+100	ppm

Contents

Description	1
Pin Assignments	1
Features	1
Ordering Information	2
Absolute Maximum Ratings	4
Mechanical Testing	4
Solder Reflow Profile	4
DC Electrical Characteristics	5
AC Electrical Characteristics	8
Output Waveforms	12
Package Outline Drawings	14
Marking Diagrams	14
Revision History	15

Absolute Maximum Ratings

Stresses above the ratings listed below can cause permanent damage to the device. The ratings, which are standard values for Renesas commercially rated parts, are stress ratings only. Functional operation of the device at these or any other conditions above those indicated in the operational sections of the specifications is not implied. Exposure to absolute maximum rating conditions for extended periods can affect product reliability. Electrical parameters are guaranteed only over the recommended operating temperature range.

Table 3. Absolute Maximum Ratings

Item	Rating			
V _{DD}	-0.5 to +5.0V			
E/D	-0.5V to V _{DD} + 0.5V			
OUT	-0.5V to V _{DD} + 0.5V			
Storage Temperature	-55°C to 125°C			
Maximum Junction Temperature	125°C			
Core Current	65mA maximum			
Theta J _A	JU6	75.9 °C/W	JS6	89.6 °C/W
Theta J _B		48.6 °C/W		54.3 °C/W
ESD Rating–Human Body Model	1000V			

Mechanical Testing

Table 4. Mechanical Testing *

Parameter	Test Method
Mechanical Shock	Half-sine wave with 0.3ms 3000G. X, Y, Z each direction 1 time.
Mechanical Vibration	Frequency: 10 – 55MHz amplitude: 1.5mm. Frequency: 55 – 2000Hz peak value: 20G. Duration time: 4H for each X,Y,Z axis; total 12hours.
High Temp Operating Life (HTOL)	2000 hours at 125°C (under power).
Hermetic Seal	Gross leak (air leak test). Fine leak (Helium leak test) He-pressure: 6kgf/cm ² 2 hours.

* MSL level does not apply.

Solder Reflow Profile

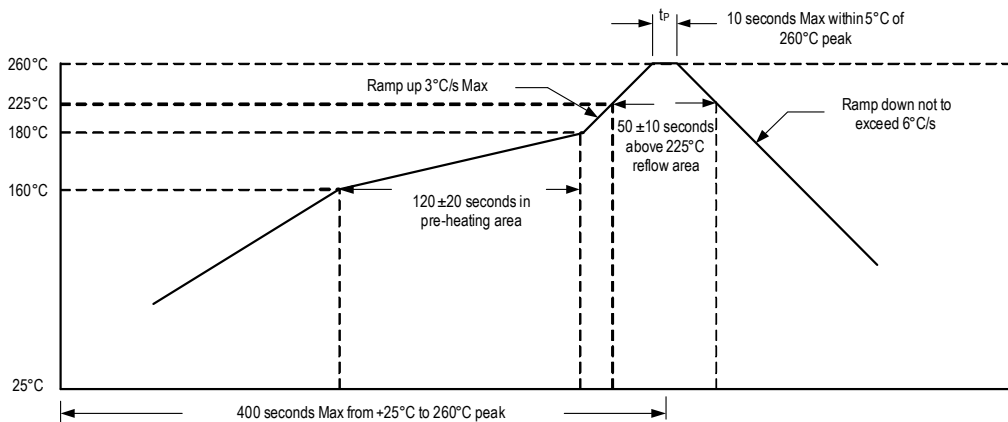

DC Electrical Characteristics

Note for all DC Electrical Characteristics tables: A pull-up resistor from V_{DD} to E/D enables output when pin 1 is left open.

Table 5. 3.3V IDD DC Electrical Characteristics

$V_{DD} = 3.3V \pm 5\%$, $T_A = -20^\circ C$ to $+70^\circ C$; $-40^\circ C$ to $+85^\circ C$, $-40^\circ C$ to $+105^\circ C$.

Symbol	Parameter	Output Type	Conditions	Minimum	Typical	Maximum	Unit
I_{DD}	Current Consumption	LVDS	0.016MHz to 400MHz.	-	-	97	mA
			400.000+MHz to 1.5GHz.	-	-	122	
		LVPECL	0.016MHz to 212.5MHz.	-	-	115	
			212.5+MHz to 400MHz.	-	-	128	
			400+MHz to 670MHz.	-	-	142	
		HCSL	0.016MHz to 670MHz.	-	-	145	
		LVCMOS	0.016MHz to 62.5MHz.	-	-	98	
			62.5+MHz to 167MHz.	-	-	108	

Table 6. 2.5V IDD DC Electrical Characteristics

$V_{DD} = 2.5V \pm 5\%$, $T_A = -20^\circ C$ to $+70^\circ C$; $-40^\circ C$ to $+85^\circ C$, $-40^\circ C$ to $+105^\circ C$.

Symbol	Parameter	Output Type	Conditions	Minimum	Typical	Maximum	Unit
I_{DD}	Current Consumption	LVDS	0.016MHz to 400MHz.	-	-	90	mA
			400.000+MHz to 1.35GHz.	-	-	103	
		LVPECL	0.016MHz to 156.25MHz.	-	-	102	
			156.25+MHz to 400MHz.	-	-	112	
			400+MHz to 670MHz.	-	-	118	
		HCSL	0.016MHz to 400MHz.	-	-	102	
			400.000+MHz to 670MHz.	-	-	112	
		LVCMOS	0.016MHz to 62.5MHz.	-	-	80	
			62.5+MHz to 125MHz.	-	-	85	
			125+MHz to 167MHz.	-	-	92	

Table 7. 1.8V IDD DC Electrical Characteristics

$V_{DD} = 3.3V \pm 5\%$, $T_A = -20^{\circ}C$ to $+70^{\circ}C$; $-40^{\circ}C$ to $+85^{\circ}C$, $-40^{\circ}C$ to $+105^{\circ}C$.

Symbol	Parameter	Output Type	Conditions	Minimum	Typical	Maximum	Unit
I_{DD}	Current Consumption	LVDS	0.016MHz to 400MHz.	-	-	65	mA
			400.000+MHz to 1.0GHz.	-	-	72	
		LVPECL	0.016MHz to 250MHz.	-	-	75	
			250.000+MHz to 670MHz.	-	-	97	
		HCSL	0.016MHz to 400MHz.	-	-	68	
			400.000+MHz to 670MHz.	-	-	77	
LVC MOS	0.016MHz to 125MHz.	-	-	58			

Table 8. LVDS DC Electrical Characteristics

$V_{DD} = 3.3V, 2.5V, 1.8V \pm 5\%$, $T_A = -20^{\circ}C$ to $+70^{\circ}C$; $-40^{\circ}C$ to $+85^{\circ}C$, $-40^{\circ}C$ to $+105^{\circ}C$. Below are guaranteed for listed standard frequencies.

Symbol	Parameter	Conditions	Minimum	Typical	Maximum	Unit
V_{OD}	Differential Output Voltage	-	0.25	0.4	0.5	V
V_{OS}	Output Offset Voltage	-	1	1.17	1.375	
V_{IH}	Enable/Disable Input High Voltage	-	$70\%V_{DD}$	-	-	
V_{IL}	Enable/Disable Input Low Voltage	-	-	-	$30\%V_{DD}$	

Table 9. LVPECL DC Electrical Characteristics

$V_{DD} = 3.3V, 2.5V, 1.8V \pm 5\%$, $T_A = -20^{\circ}C$ to $+70^{\circ}C$; $-40^{\circ}C$ to $+85^{\circ}C$, $-40^{\circ}C$ to $+105^{\circ}C$. Below are guaranteed for listed standard frequencies.

Symbol	Parameter	Conditions	Minimum	Typical	Maximum	Unit
V_{OH}	Output High Voltage	$V_{DD} = 3.3V \pm 5\%$.	1.85	-	2.3	V
		$V_{DD} = 2.5V \pm 5\%$.	1.1	-	1.45	
		$V_{DD} = 1.8V \pm 5\%$.	0.5	-	0.8	
V_{OL}	Output Low Voltage	$V_{DD} = 3.3V \pm 5\%$.	1.1	-	1.65	
		$V_{DD} = 2.5V \pm 5\%$.	0.35	-	0.85	
		$V_{DD} = 1.8V \pm 5\%$.	0	-	0.25	
V_{IH}	Enable/Disable Input High Voltage	-	$70\%V_{DD}$	-	-	
V_{IL}	Enable/Disable Input Low Voltage	-	-	-	$30\%V_{DD}$	

Table 10. HCSL DC Electrical Characteristics

$V_{DD} = 3.3V, 2.5V, 1.8V \pm 5\%$, $T_A = -20^\circ C$ to $+70^\circ C$; $-40^\circ C$ to $+85^\circ C$, $-40^\circ C$ to $+105^\circ C$. Below are guaranteed for listed standard frequencies.

Symbol	Parameter	Conditions	Minimum	Typical	Maximum	Unit
V_{OH}	Output High Voltage	$V_{DD} = 3.3V \pm 5\%$.	0.6	-	1.1	V
		$V_{DD} = 2.5V \pm 5\%$.	0.55	-	0.95	
		$V_{DD} = 1.8V \pm 5\%$.	0.45	-	0.7	
V_{OL}	Output Low Voltage	-	0	-	0.2	
V_{IH}	Enable/Disable Input High Voltage	-	$70\%V_{DD}$	-	-	
V_{IL}	Enable/Disable Input Low Voltage	-	-	-	$30\%V_{DD}$	

Table 11. LVCMOS DC Electrical Characteristics

$V_{DD} = 3.3V, 2.5V, 1.8V \pm 5\%$, $T_A = -20^\circ C$ to $+70^\circ C$; $-40^\circ C$ to $+85^\circ C$, $-40^\circ C$ to $+105^\circ C$. Below are guaranteed for listed standard frequencies.

Symbol	Parameter	Conditions	Minimum	Typical	Maximum	Unit
V_{OH}	Output High Voltage	-	$90\%V_{DD}$	-	-	V
V_{OL}	Output Low Voltage	-	-	-	$10\%V_{DD}$	
V_{IH}	Enable/Disable Input High Voltage	-	$70\%V_{DD}$	-	-	
V_{IL}	Enable/Disable Input Low Voltage	-	-	-	$30\%V_{DD}$	

AC Electrical Characteristics

Table 12. 3.3V AC Electrical Characteristics

$V_{DD} = 3.3V \pm 5\%$, $T_A = -20^\circ C$ to $+70^\circ C$; $-40^\circ C$ to $+85^\circ C$, $-40^\circ C$ to $+105^\circ C$.

Symbol	Parameter	Test Condition		Minimum	Typical	Maximum	Unit
F	Output Frequency Range	LVDS.		0.016	-	1500	MHz
		LVPECL, HCSL.		0.016	-	670	
		LVCMOS.		0.016	-	167	
Frequency Stability	Frequency Stability	Temperature = $-20^\circ C$ to $+70^\circ C$.		-20 -25 -50 -100	-	+20 +25 +50 +100	ppm
		Temperature = $-40^\circ C$ to $+85^\circ C$.		-25 -50 -100	-	+25 +50 +100	ppm
		Temperature = $-40^\circ C$ to $+105^\circ C$.		-50 -100	-	+50 +100	ppm
Output Load	Output Load	LVDS.	Differential.	-	100	-	Ω
		LVPECL.	$V_{DD} - 2.0V$.	-	50	-	
		HCSL.	To GND.	-	50	-	
		LVCMOS.	To GND.	-	15	-	pF
T_{ST}	Start-up Time	Output valid time after V_{DD} meets minimum specified level.		-	-	10	ms
t_R	Output Rise Time	LVDS.	20% to 80% Vpk-pk.	-	275	380	ps
		LVPECL.		-	-	400	
		HCSL.		-	-	330	
		LVCMOS.	10% to 90% V_{DD} .	-	-	3	ns
t_F	Output Fall Time	LVDS.	80% to 20% Vpk-pk.	-	275	380	ps
		LVPECL.		-	-	400	
		HCSL.		-	-	330	
		LVCMOS.	90% to 10% V_{DD} .	-	-	3	ns
O_{DC}	Output Clock Duty Cycle	LVDS.		45	-	55	%
		LVPECL.	$F_{OUT} \leq 312.5MHz$.	45	-	55	
			$F_{OUT} > 312.5MHz$.	40	-	60	
		HCSL.		45	-	55	
		LVCMOS.	$F_{OUT} \leq 62.5MHz$.	45	-	55	
$F_{OUT} > 62.5MHz$.	40		-	60			
T_{OE}	Output Enable/ Disable Time			-	-	100	ns

Table 12. 3.3V AC Electrical Characteristics (Cont.)

$V_{DD} = 3.3V \pm 5\%$, $T_A = -20^\circ C$ to $+70^\circ C$; $-40^\circ C$ to $+85^\circ C$, $-40^\circ C$ to $+105^\circ C$.

Symbol	Parameter	Test Condition	Minimum	Typical	Maximum	Unit
f_{JITTER}	Phase Jitter (12kHz–20MHz)	LVDS.	-	300	400	fsec
		LVPECL.	-	300	400	
		HCSL.	-	300	400	
		LVC MOS.	$F_{OUT} = 100MHz.$	-	300	

Table 13. 2.5V AC Electrical Characteristics

$V_{DD} = 2.5V \pm 5\%$, $T_A = -20^\circ C$ to $+70^\circ C$; $-40^\circ C$ to $+85^\circ C$, $-40^\circ C$ to $+105^\circ C$.

Symbol	Parameter	Test Condition	Minimum	Typical	Maximum	Unit	
F	Output Frequency Range	LVDS.	0.016	-	1350	MHz	
		LVPECL.	0.016	-	670		
		HCSL.	0.016	-	670		
		LVC MOS.	0.016	-	167		
	Frequency Stability	Temperature = $-20^\circ C$ to $+70^\circ C$.	-20 -25 -50 -100	-	+20 +25 +50 +100	ppm	
		Temperature = $-40^\circ C$ to $+85^\circ C$.	-25 -50 -100	-	+25 +50 +100	ppm	
		Temperature = $-40^\circ C$ to $+105^\circ C$.	-50 -100	-	+50 +100	ppm	
	Output Load	LVDS.	Differential.	-	100	-	Ω
		LVPECL.	$V_{DD} - 2.0V.$	-	50	-	
		HCSL.	To GND.	-	50	-	
		LVC MOS.	To GND.	-	15	-	pF
T_{ST}	Start-up Time	Output valid time after V_{DD} meets minimum specified level.	-	-	10	ms	
t_R	Output Rise Time	LVDS.	20% to 80% Vpk-pk.	-	300	400	ps
		LVPECL.		-	250	630	
		HCSL.		-	-	315	
		LVC MOS.	10% to 90% V_{DD} .	-	-	3	ns
t_F	Output Fall Time	LVDS.	80% to 20% Vpk-pk.	-	300	400	ps
		LVPECL.		-	360	630	
		HCSL.		-	-	315	
		LVC MOS.	90% to 10% V_{DD} .	-	-	3	ns

Table 13. 2.5V AC Electrical Characteristics (Cont.)

$V_{DD} = 2.5V \pm 5\%$, $T_A = -20^\circ C$ to $+70^\circ C$; $-40^\circ C$ to $+85^\circ C$, $-40^\circ C$ to $+105^\circ C$.

Symbol	Parameter	Test Condition	Minimum	Typical	Maximum	Unit	
O _{DC}	Output Clock Duty Cycle	LVDS.	45	-	55	%	
		LVPECL.	F _{OUT} ≤ 156.25MHz.	45	-		55
			F _{OUT} ≤ 156.25MHz.	40	-		60
		HCSL.	45	-	55		
		LVCMOS.	F _{OUT} ≤ 62.5MHz.	45	-		55
F _{OUT} > 62.5MHz.	40		-	60			
T _{OE}	Output Enable/ Disable Time		-	-	100	ns	
f _{JITTER}	Phase Jitter (12kHz–20MHz)	LVDS.	-	400	500	fsec	
		LVPECL.	-	350	500		
		HCSL.	-	350	500		
		LVCMOS.	F _{OUT} = 100MHz.	-	350		500

Table 14. 1.8V AC Electrical Characteristics

$V_{DD} = 1.8V \pm 5\%$, $T_A = -20^\circ C$ to $+70^\circ C$; $-40^\circ C$ to $+85^\circ C$, $-40^\circ C$ to $+105^\circ C$.

Symbol	Parameter	Test Condition	Minimum	Typical	Maximum	Unit	
F	Output Frequency Range	LVDS.	0.016	-	1000	MHz	
		LVPECL, HCSL.	0.016	-	670		
		LVCMOS.	0.016	-	125		
	Frequency Stability	Temperature = $-20^\circ C$ to $+70^\circ C$.	-20 -25 -50 -100	-	+20 +25 +50 +100	ppm	
		Temperature = $-40^\circ C$ to $+85^\circ C$.	-25 -50 -100	-	+25 +50 +100	ppm	
		Temperature = $-40^\circ C$ to $+105^\circ C$.	-50 -100	-	+50 +100	ppm	
	Output Load	LVDS.	Differential.	-	100	-	Ω
		LVPECL, HCSL.	To GND.	-	50	-	
		LVCMOS.	To GND.	-	10	-	pF
T _{ST}	Start-up Time	Output valid time after V_{DD} meets minimum specified level.	-	-	10	ms	
t _R	Output Rise Time	LVDS.	20% to 80% V _{pk-pk} .	-	250	315	ps
		LVPECL.		-	250	350	
		HCSL.		-	-	320	
		LVCMOS.	10% to 90% V _{DD} .	-	5	-	ns

Table 14. 1.8V AC Electrical Characteristics (Cont.)

$V_{DD} = 1.8V \pm 5\%$, $T_A = -20^\circ C$ to $+70^\circ C$; $-40^\circ C$ to $+85^\circ C$, $-40^\circ C$ to $+105^\circ C$.

Symbol	Parameter	Test Condition		Minimum	Typical	Maximum	Unit	
t_F	Output Fall Time	LVDS.	80% to 20% V_{pk-pk} .	-	250	315	ps	
		LVPECL.		-	250	350		
		HCSL.		-	-	320		
		LVC MOS.	90% to 10% V_{DD} .	-	5	-	ns	
O_{DC}	Output Clock Duty Cycle	LVDS.	$F_{OUT} \leq 156.25MHz.$	45	-	55	%	
			$F_{OUT} \leq 156.25MHz.$	40	-	60		
		LVPECL.	$F_{OUT} \leq 312.5MHz.$	45	-	55		
			$F_{OUT} > 312.5MHz.$	40	-	60		
		HCSL.			40	-		60
		LVC MOS.	$F_{OUT} \leq 62.5MHz.$	45	-	55		
$F_{OUT} > 62.5MHz.$	40		-	60				
T_{OE}	Output Enable/ Disable Time			-	-	100	ns	
f_{JITTER}	Phase Jitter (12kHz–20MHz)	LVDS.		-	800	1200	fsec	
		LVPECL.		-	750	1200		
		HCSL.		-	100	1200		
		LVC MOS.	$F_{OUT} = 100MHz.$	-	800	1200		

Notes for all AC Electrical Characteristics tables:

- ¹ A pull-up resistor from V_{DD} to E/D enables output when pin 1 is left open.
- ² Installation should include a 0.01 μF bypass capacitor placed between V_{DD} and GND to minimize power supply line noise.
- ³ Stability is inclusive of 25 $^\circ C$ tolerance, operating temperature range, input voltage change, load change, aging, shock and vibration.
- ⁴ Standard LVC MOS frequencies include 10MHz, 12MHz, 12.288MHz, 16MHz, 20MHz, 24MHz, 24.576MHz, 25MHz, 33.333MHz, 40MHz, 48MHz, 50MHz, 100MHz, 125MHz and 156.25MHz.
- ⁵ Standard differential frequencies include 100MHz, 106.25MHz, 125MHz, 150MHz, 155.52MHz, 156.25MHz, 200MHz, 212.5MHz, 250MHz, 300MHz, 312.5MHz and 400MHz.

Output Waveforms

Figure 1. LVDS Output Waveforms

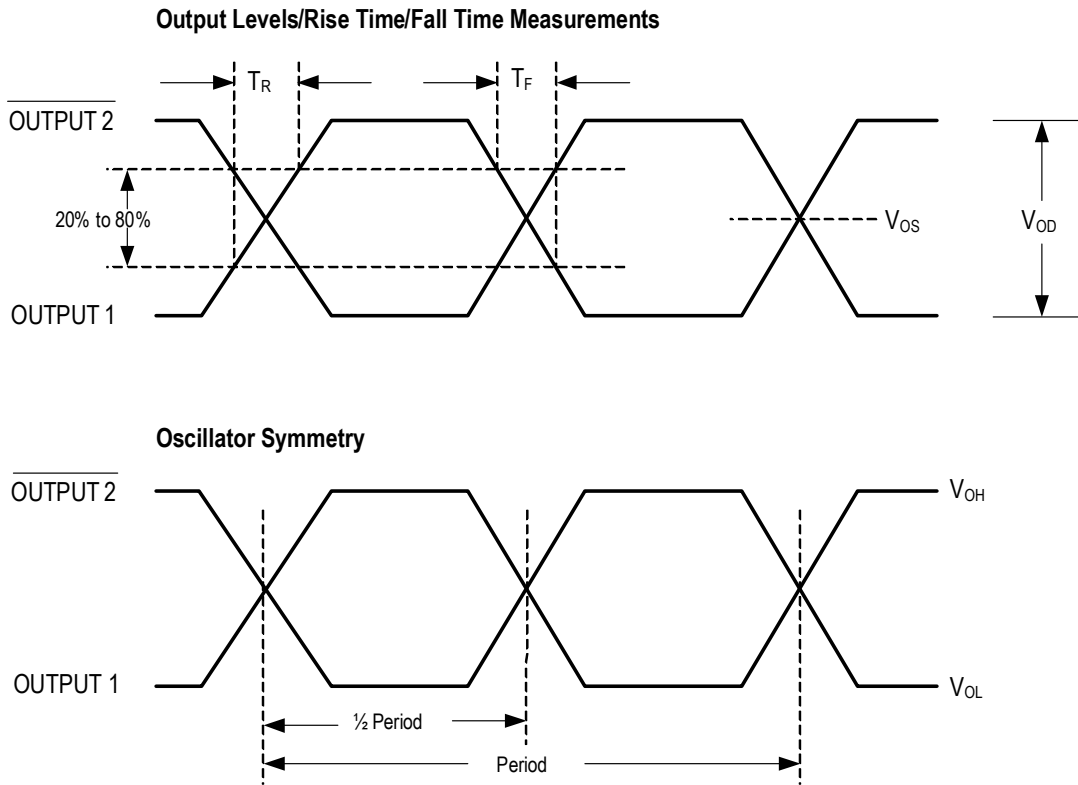

Figure 2. LVPECL Output Waveforms

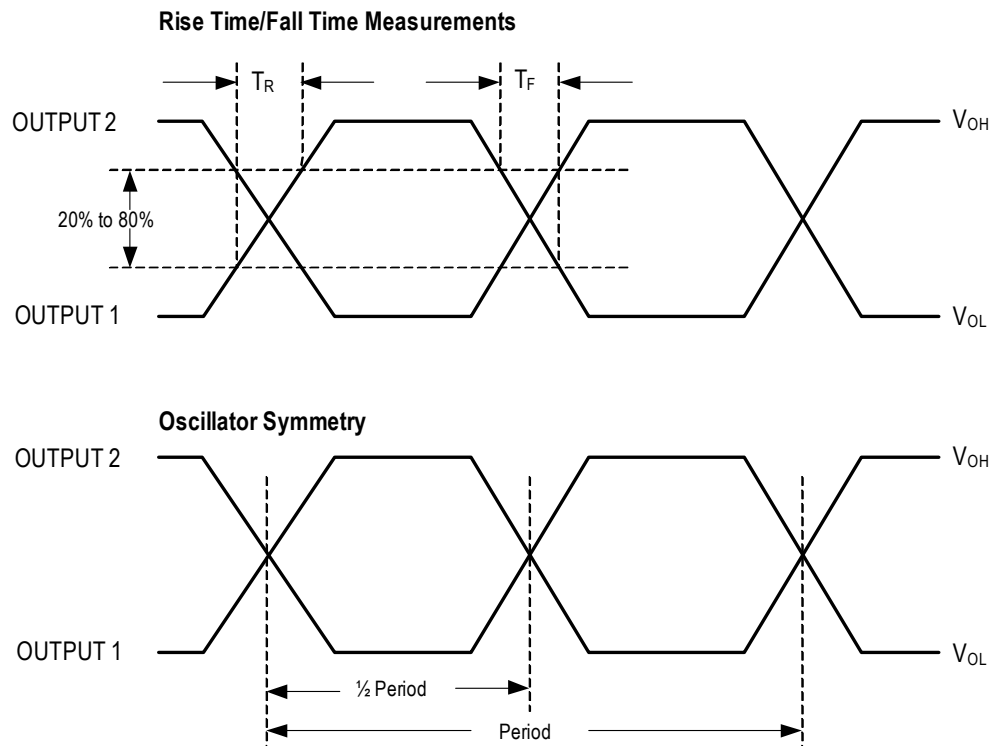

Figure 3. HCSL Output Waveforms

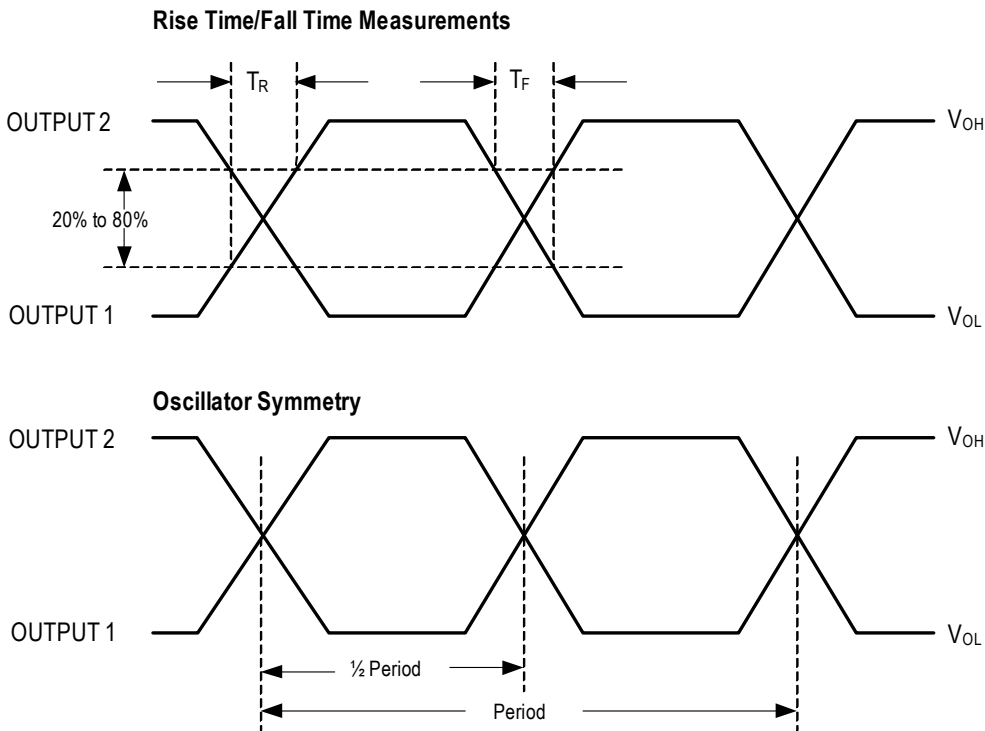
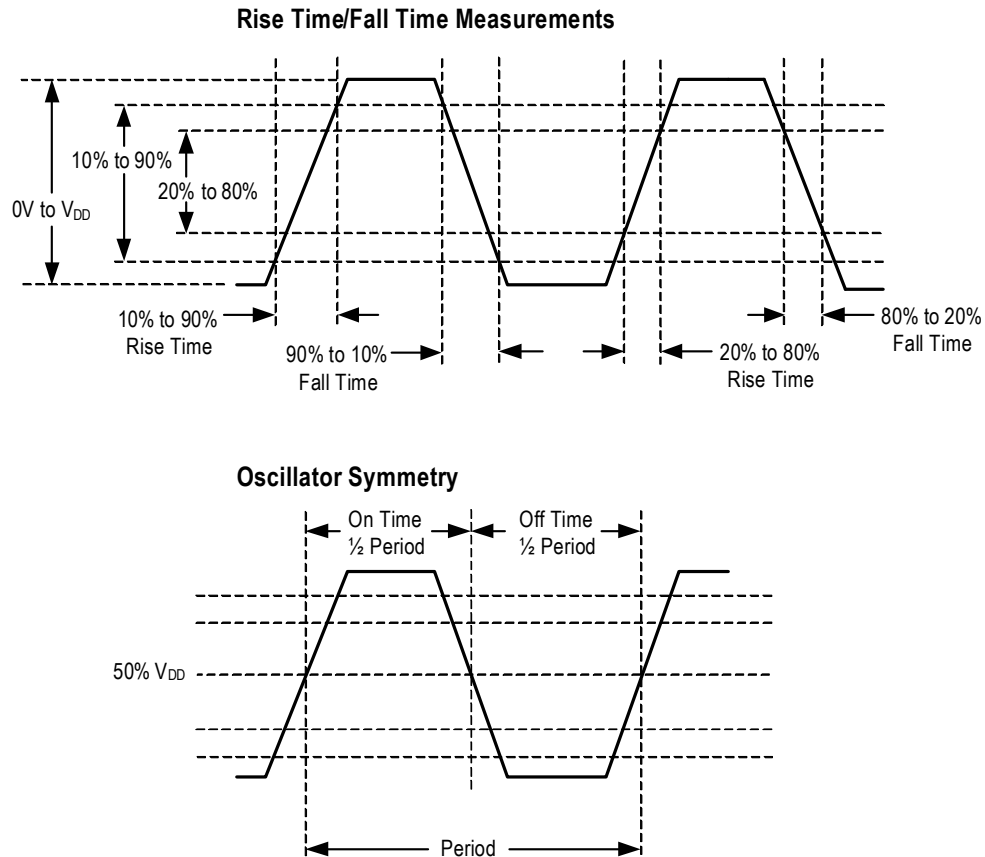

Figure 4. LVCMOS Output Waveforms



Package Outline Drawings

The package outline drawings (JS6, JU6) are appended at the end of this document. The package information is the most current data available.

Marking Diagrams

JS6 5.0 × 3.2 mm Package Option (example based on XUH510040.000000I)

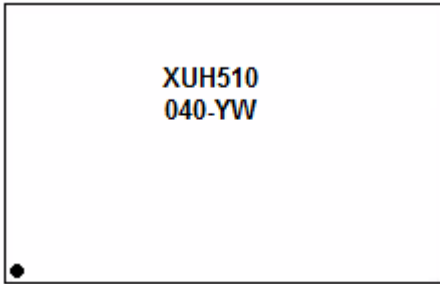

- Line 1:
 - “XU” = family; “H” = output type; “5” = package size; “1” = voltage; “0” = precision level. This number will vary depending upon the output type, voltage, and precision values selected in the orderable part number.
- Line 2:
 - “040” denotes last three digits to the left of the decimal point as shown in the above example. This number will vary depending upon the frequency value selected in the orderable part number.
 - “YW” denotes the last digit of the year and work week the part was assembled.

JU6 7.0 × 5.0 mm Package Option (example based on XUH738044.736000X)

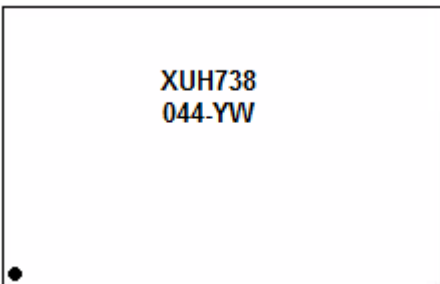

- Line 1:
 - “XU” = family; “H” = output type; “7” = package size; “3” = voltage; “8” = precision level. This number will vary depending upon the output type, voltage, and precision values selected in the orderable part number.
- Line 2:
 - “044” denotes last three digits to the left of the decimal point as shown in the above example. This number will vary depending upon the frequency value selected in the orderable part number.
 - “YW” denotes the last digit of the year and work week the part was assembled.

Revision History

Revision Date	Description of Change
November 21, 2024	Updated Table 11 .
November 1, 2023	Updated values in Table 11 .
January 11, 2022	<ul style="list-style-type: none"> ▪ Updated Frequency Stability values in Table 14. ▪ Removed Aging parameters in Table 12, Table 13 and Table 14.
December 7, 2021	<ul style="list-style-type: none"> ▪ Updated Frequency Stability values in Table 12 and Table 13. ▪ Removed I2C section.
November 23, 2021	Added Frequency Stability and Operating Temperature Decoder table after Ordering Information.
August 18, 2021	Moved Ordering Information table to just after Pin Descriptions.
January 19, 2021	<ul style="list-style-type: none"> ▪ Removed 4-pin package description table, figure, and package drawing references. ▪ Added footnote for pin 5 in Table 1. ▪ Added footnote under “Output Type” in Ordering Information.
January 12, 2021	Added Marking Diagrams section and updated Package Outline Drawings links.
February 11, 2020	Added I2C Bus Characteristics tables.
June 28, 2019	<ul style="list-style-type: none"> ▪ Added footnote to frequency range bullet under front page Features.
June 25, 2018	<ul style="list-style-type: none"> ▪ Updated Package Outline Drawings section.
November 22, 2017	<ul style="list-style-type: none"> ▪ Updated Theta JA and JB in Absolute Maximum Ratings table. ▪ Added MSL statement under Mechanical Testing table. ▪ Updated ordering information.
October 19, 2017	<ul style="list-style-type: none"> ▪ Updated document title. ▪ Updated Features bullets. ▪ Updated Absolute Maximum Ratings and ESD Compliance tables. ▪ Added -40°C to +105°C rating to all electrical tables. ▪ Removed phase noise charts. ▪ Updated Ordering Information table.
May 12, 2017	<ul style="list-style-type: none"> ▪ Reformatted embedded tables. ▪ Removed “Jitter Performance” tables and moved the “Phase Jitter (12kHz–20MHz)” parameter to its respective AC Electrical Characteristics table. ▪ Updated all Output Waveform drawings.
December 1, 2016	Initial release.

REVISIONS			
REV	DESCRIPTION	DATE	APPROVED
00	INITIAL RELEASE	04/2/12	DP
01	ADDED LID IN TOP VIEW	07/12/12	KS
02	UPDATED LID TOLERANCES	12/03/12	KS
03	UPDATE PACKAGE DRAWING	8/8/14	JHUA

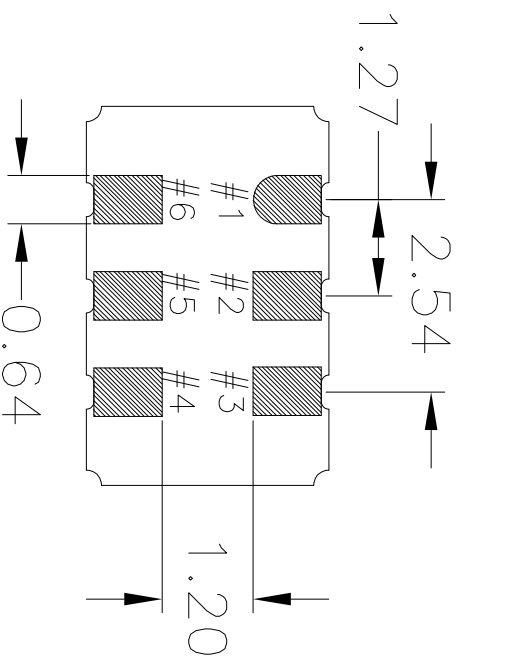

BOTTOM VIEW

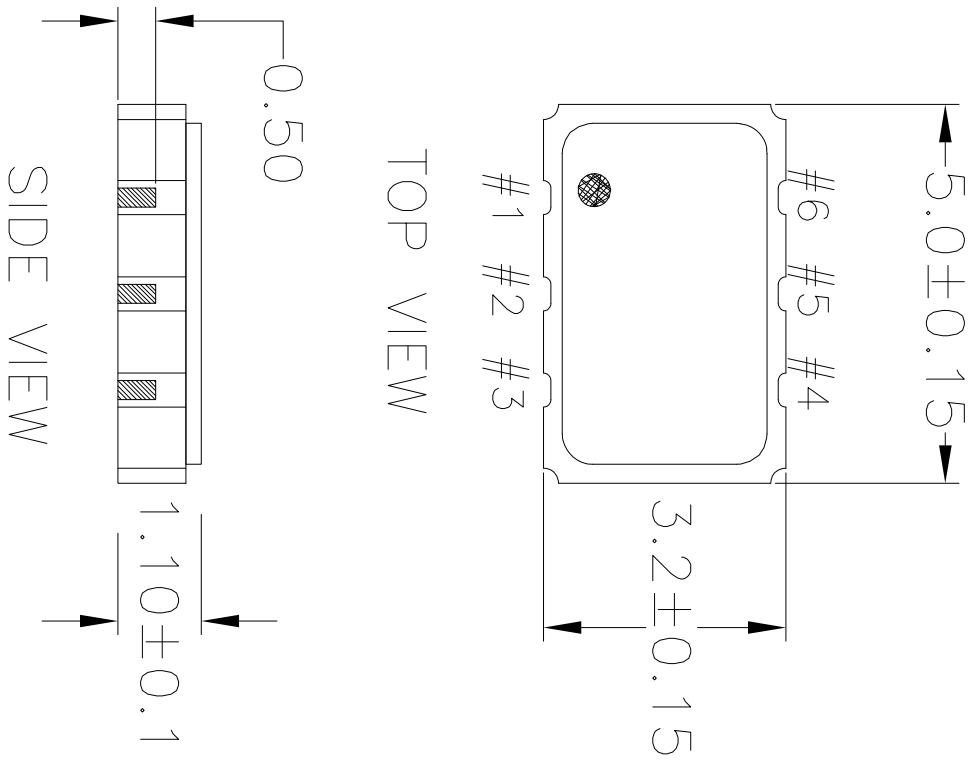

TOP VIEW

SIDE VIEW

NOTES:
1. ALL DIMENSIONS IN MM.

TOLERANCES UNLESS SPECIFIED		6024 Silver Creek Valley Rd	
DECIMAL	ANGULAR	Son Jose, CA 95138	
XXX±	±	PHONE: (408) 727-6116	
XXXX±		FAX: (408) 492-8874	
XXXX±			
APPROVALS	DATE	TITLE	SIZE
DRAWN <i>QAC</i>	04/2/12	JS6 PACKAGE OUTLINE	C
CHECKED		5.0 x 3.2 mm BODY	DRAWING No.
		1.1 mm Thick	PSC-4411
			DO NOT SCALE DRAWING
			SHEET 1 OF 2



REVISIONS			
REV	DESCRIPTION	DATE	APPROVED
00	INITIAL RELEASE	04/2/12	DP
01	ADDED LID IN TOP VIEW	07/12/12	KS
02	UPDATED LID TOLERANCES	12/03/12	KS
03	UPDATE PACKAGE DRAWING	8/8/14	JHUA

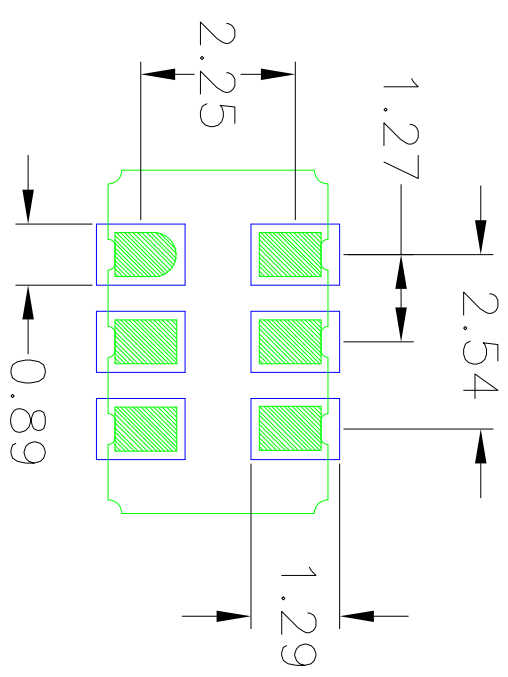

RECOMMENDED LAND PATTERN

- NOTES:
1. ALL DIMENSION ARE IN mm. ANGLES IN DEGREES.
 2. TOP DOWN VIEW. AS VIEWED ON PCB.
 3. COMPONENT OUTLINE SHOW FOR REFERENCE IN GREEN.
 4. LAND PATTERN IN BLUE. NSMD PATTERN ASSUMED.
 5. LAND PATTERN RECOMMENDATION PER IPC-7351B GENERIC REQUIREMENT FOR SURFACE MOUNT DESIGN AND LAND PATTERN.

TOLERANCES UNLESS SPECIFIED		6024 Silver Creek Valley Rd	
DECIMAL	ANGULAR	San Jose, CA 95138	
XXX±	±	PHONE: (408) 727-6176	
XXXX±		FAX: (408) 492-8674	
APPROVALS		www.IDT.com	
DRAWN	DATE	TITLE	
04/2/12		J56 PACKAGE OUTLINE	
CHECKED		5.0 x 3.2 mm BODY	
		1.1 mm Thick	
SIZE	DRAWING No.	REV	
C	PSC-4411	03	
DO NOT SCALE DRAWING			SHEET 2 OF 2

REVISIONS			
REV	DESCRIPTION	DATE	APPROVED
00	INITIAL RELEASE	10/5/12	KS
01	UPDATE PACKAGE DRWING	8/12/14	JHUA

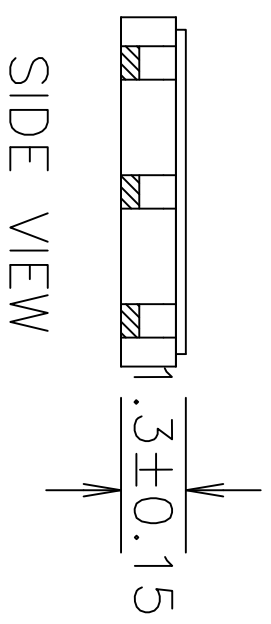
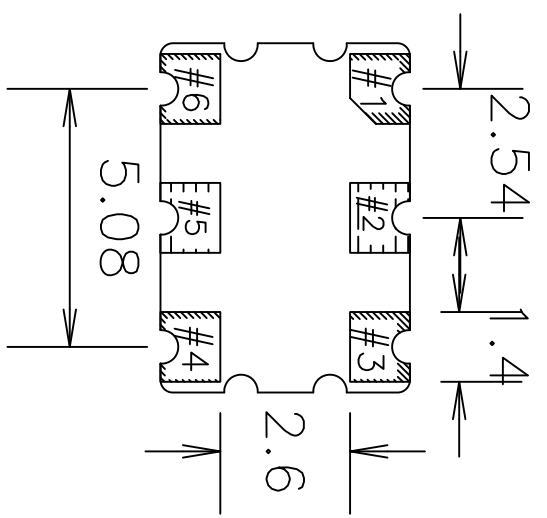
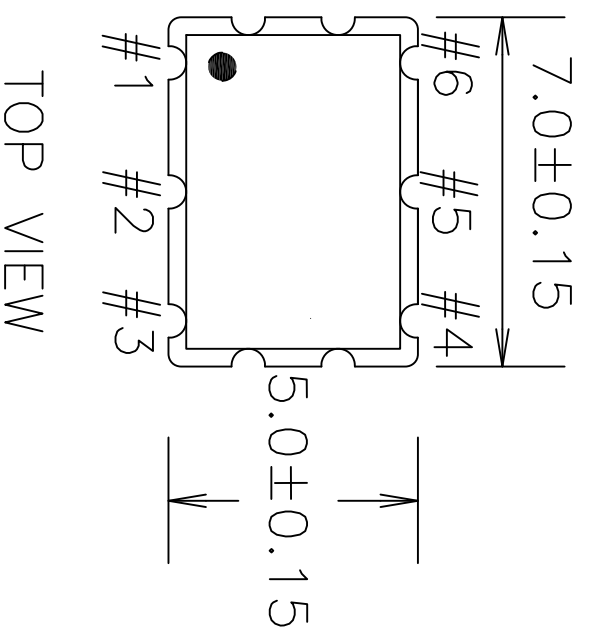

NOTES:
1. ALL DIMENSIONS IN MM.

TOLERANCES UNLESS SPECIFIED		www.IDT.com	
DECIMAL	ANGULAR	 IDT TM 6024 Silver Creek Valley Rd San Jose, CA 95138 PHONE: (408) 727-6116 FAX: (408) 482-9874	
XXX±	±		
XXXX±		TITLE J16 PACKAGE OUTLINE	
APPROVALS	DATE	SIZE	REV
DRAWN XJS	10/03/12	C	01
CHECKED		DRAWING No.	PSC-4430
		1.3 mm Thick	
DO NOT SCALE DRAWING		SHEET 1 OF 2	

REVISIONS			
REV	DESCRIPTION	DATE	APPROVED
00	INITIAL RELEASE	10/5/12	KS
01	UPDATE PACKAGE DRAWING	8/12/14	JLHUA

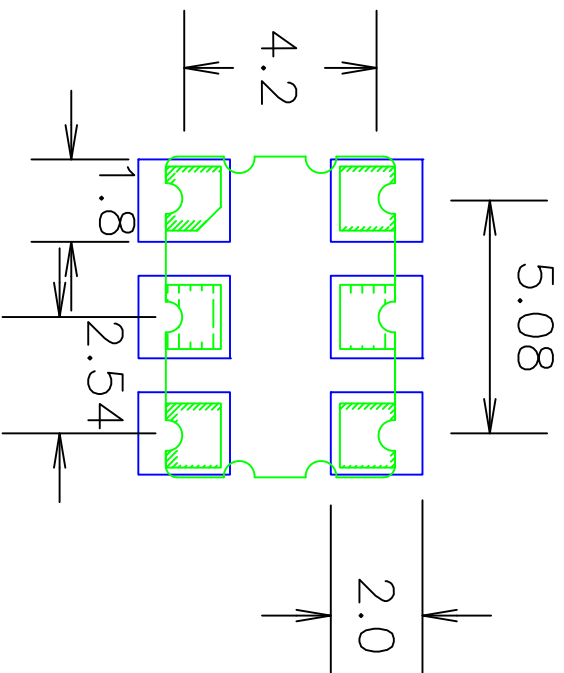

RECOMMENDED LAND PATTERN

- NOTES:
1. ALL DIMENSION ARE IN mm. ANGLES IN DEGREES.
 2. TOP DOWN VIEW. AS VIEWED ON PCB.
 3. COMPONENT OUTLINE SHOW FOR REFERENCE IN PCB.
 4. LAND PATTERN IN BLUE. NSMD PATTERN ASSUMED.
 5. LAND PATTERN RECOMMENDATION PER IPC-7351B. GENERIC REQUIREMENT FOR SURFACE MOUNT DESIGN AND LAND PATTERN.

TOLERANCES UNLESS SPECIFIED	
DECIMAL	ANGULAR
±0.005	±0.1
	
6024 Silver Creek Valley Rd San Jose, CA 95138 PHONE: (408) 757-6116 FAX: (408) 492-8874	
www.idt.com	
TITLE	J06 PACKAGE OUTLINE
DRAWN BY	7.0 x 5.0 mm BODY
CHECKED	1.3 mm Thick

APPROVALS	DATE	SIZE	DRAWING No.	REV
	10/05/12	C	FSC-4430	01
DO NOT SCALE DRAWING				
				SHEET 2 OF 2

IMPORTANT NOTICE AND DISCLAIMER

RENESAS ELECTRONICS CORPORATION AND ITS SUBSIDIARIES (“RENESAS”) PROVIDES TECHNICAL SPECIFICATIONS AND RELIABILITY DATA (INCLUDING DATASHEETS), DESIGN RESOURCES (INCLUDING REFERENCE DESIGNS), APPLICATION OR OTHER DESIGN ADVICE, WEB TOOLS, SAFETY INFORMATION, AND OTHER RESOURCES “AS IS” AND WITH ALL FAULTS, AND DISCLAIMS ALL WARRANTIES, EXPRESS OR IMPLIED, INCLUDING, WITHOUT LIMITATION, ANY IMPLIED WARRANTIES OF MERCHANTABILITY, FITNESS FOR A PARTICULAR PURPOSE, OR NON-INFRINGEMENT OF THIRD-PARTY INTELLECTUAL PROPERTY RIGHTS.

These resources are intended for developers who are designing with Renesas products. You are solely responsible for (1) selecting the appropriate products for your application, (2) designing, validating, and testing your application, and (3) ensuring your application meets applicable standards, and any other safety, security, or other requirements. These resources are subject to change without notice. Renesas grants you permission to use these resources only to develop an application that uses Renesas products. Other reproduction or use of these resources is strictly prohibited. No license is granted to any other Renesas intellectual property or to any third-party intellectual property. Renesas disclaims responsibility for, and you will fully indemnify Renesas and its representatives against, any claims, damages, costs, losses, or liabilities arising from your use of these resources. Renesas' products are provided only subject to Renesas' Terms and Conditions of Sale or other applicable terms agreed to in writing. No use of any Renesas resources expands or otherwise alters any applicable warranties or warranty disclaimers for these products.

(Disclaimer Rev.1.01)

Corporate Headquarters

TOYOSU FORESIA, 3-2-24 Toyosu,
Koto-ku, Tokyo 135-0061, Japan
www.renesas.com

Contact Information

For further information on a product, technology, the most up-to-date version of a document, or your nearest sales office, please visit www.renesas.com/contact-us/.

Trademarks

Renesas and the Renesas logo are trademarks of Renesas Electronics Corporation. All trademarks and registered trademarks are the property of their respective owners.