

Brief Description

ZSPM15xx family ICs are controllers designed for high-current, non-isolated DC/DC step-down point of load (POL) converters. The ZSPM15xx has a digital control loop that is optimized for maximum stability as well as load step and steady-state performance.

ZSPM15xx family ICs have a rich set of integrated fault protection features including over-voltage/under-voltage, output over-current, and over-temperature protections. To facilitate ease of use, the ZSPM15xx is pre-programmed and available for common output voltages. To provide flexibility for the end-customer, the over-current protection threshold and the control loop compensation are selectable by the end-customer to match a number of selected power stages.

ZSPM15xx family ICs have been optimized for maximum efficiency when used with IDT's DrMOS devices. Reference designs and application instructions enable a high performance turnkey solution without extensive engineering development.

Features

- Advanced digital control techniques
 - Tru-sample Technology™
 - State-Law Control™ (SLC)
- Preconfigured compensation for selected inductance values.
- Improved transient response and noise immunity
- Protection features
 - Configuration for over-current protection
 - Over-voltage protection (VIN, VOUT)
 - Under-voltage protection (VIN, VOUT)
 - Over-temperature protection
 - Overloaded startup
 - Restart and delay

Benefits

- Factory pre-configured for industry standard output voltages and currents enabling fast time-to-market
- Simplified design and integration
- FPGA designer-friendly solution
- Highest power density with smallest footprint
- Higher energy efficiency across all output loading conditions
- Operation from a single 5V supply

Available Support

- Reference designs
- Evaluation kits

Physical Characteristics

- Operation temperature: -40°C to +125°C
- VIN for POL application: 10.8V to 13.2V
- VDD50 voltage supply: 4.75 to 5.25V
- Available Output Voltages: 0.85V, 1.0V, 1.2V, 1.5V, 1.8V, 2.0V, 2.5V, 3.3V, and 5.0V
- Lead free (RoHS compliant) 24-pin QFN package (4mm x 4mm)

ZSPM15xx Typical Application Diagram

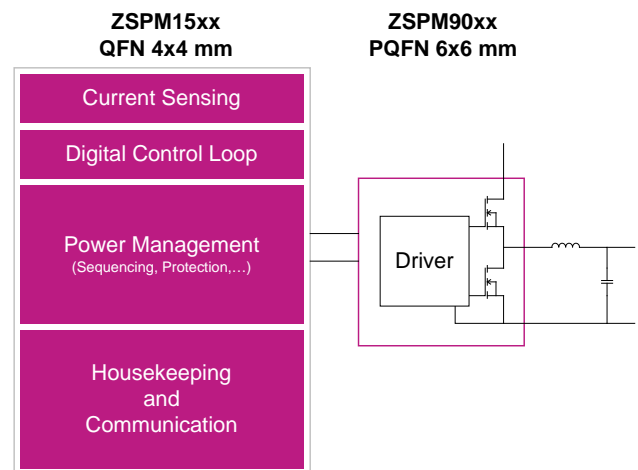

ZSPM15xx Block Diagram

- Typical Applications**
- ❖ Telecom Switches
 - ❖ Servers and Storage
 - ❖ Base Stations
 - ❖ Network Routers
 - ❖ Industrial Applications
 - ❖ Single-Rail/Single-Phase Supplies for Processors, ASICs, FPGAs, DSPs

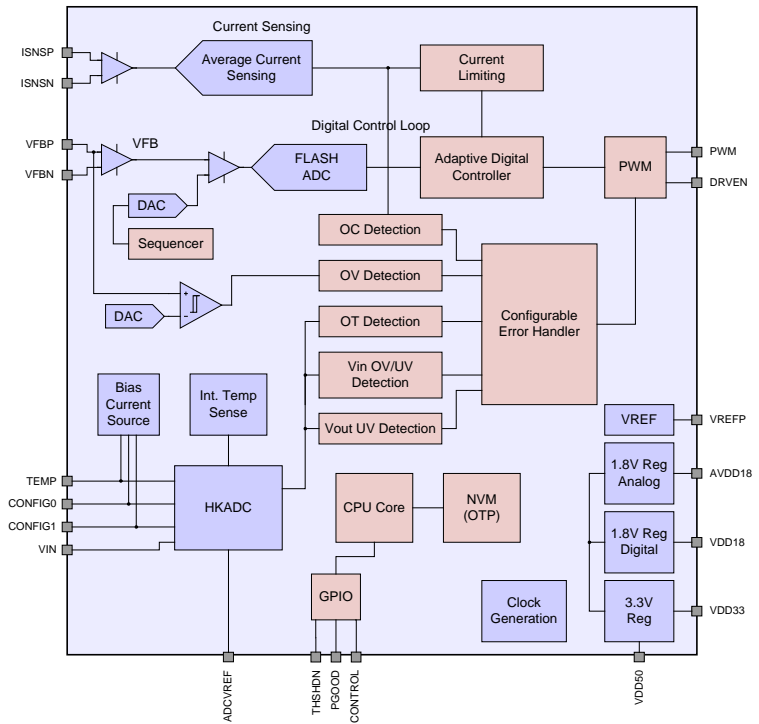

Ordering Information

Product Code	Description	Package
ZSPM1501ZA1W0	ZSPM1501 lead-free QFN24; output voltage: 0.85V; inductance: 330nH; temperature: -40°C to +125°C	Reel
ZSPM1502ZA1W0	ZSPM1502 lead-free QFN24; output voltage: 1.00V; inductance: 330nH; temperature: -40°C to +125°C	Reel
ZSPM1503ZA1W0	ZSPM1503 lead-free QFN24; output voltage: 1.20V; inductance: 330nH; temperature: -40°C to +125°C	Reel
ZSPM1504ZA1W0	ZSPM1504 lead-free QFN24; output voltage: 1.50V; inductance: 470nH; temperature: -40°C to +125°C	Reel
ZSPM1505ZA1W0	ZSPM1505 lead-free QFN24; output voltage: 1.80V; inductance: 470nH; temperature: -40°C to +125°C	Reel
ZSPM1506ZA1W0	ZSPM1506 lead-free QFN24; output voltage: 2.00V; inductance: 470nH; temperature: -40°C to +125°C	Reel
ZSPM1507ZA1W0	ZSPM1507 lead-free QFN24; output voltage: 2.50V; inductance: 1000nH; temperature: -40°C to +125°C	Reel
ZSPM1508ZA1W0	ZSPM1508 lead-free QFN24; output voltage: 3.30V; inductance: 2200nH; temperature: -40°C to +125°C	Reel
ZSPM1509ZA1W0	ZSPM1509 lead-free QFN24; output voltage: 5.00V; inductance: 2200nH; temperature: -40°C to +125°C	Reel
ZSPM1511ZA1W0	ZSPM1511 lead-free QFN24; output voltage: 0.85V; inductance: 680nH; temperature: -40°C to +125°C	Reel
ZSPM1512ZA1W0	ZSPM1512 lead-free QFN24; output voltage: 1.00V; inductance: 680nH; temperature: -40°C to +125°C	Reel
ZSPM1513ZA1W0	ZSPM1513 lead-free QFN24; output voltage: 1.20V; inductance: 680nH; temperature: -40°C to +125°C	Reel

Contents

1	IC Characteristics	14
1.1.	Absolute Maximum Ratings	14
1.2.	Recommended Operating Conditions	15
1.3.	Electrical Parameters	15
1.4.	Device-Specific System Parameters	18
1.4.1.	ZSPM1501	18
1.4.2.	ZSPM1502	18
1.4.3.	ZSPM1503	19
1.4.4.	ZSPM1504	20
1.4.5.	ZSPM1505	20
1.4.6.	ZSPM1506	21
1.4.7.	ZSPM1507	22
1.4.8.	ZSPM1508	22
1.4.9.	ZSPM1509	23
1.4.10.	ZSPM1511	23
1.4.11.	ZSPM1512	24
1.4.12.	ZSPM1513	24
2	Product Summary.....	25
2.1.	Overview.....	25
2.2.	Pin Description.....	27
2.3.	Available Packages	28
3	Functional Description.....	29
3.1.	Power Supply Circuitry, Reference Decoupling, and Grounding	29
3.2.	Reset/Start-up Behavior	29
3.3.	Digital Power Control.....	29
3.3.1.	Overview	29
3.3.2.	Output Voltage Feedback	29
3.3.3.	Digital Compensator	30
3.3.4.	Power Sequencing and the CONTROL Pin.....	31
3.4.	Fault Monitoring and Response Generation.....	32
3.4.1.	Output Over/Under-Voltage	32
3.4.2.	Output Current Protection	32
3.4.3.	Input Voltage Protection.....	33
3.4.4.	Over-Temperature Protection	33
4	Application Information.....	34
4.1.	Application Schematic	34
4.2.	Device-Specific Passive Components.....	36
4.3.	Output Voltage Feedback Components	38

4.4.	DCR Current Sensing Components	38
4.5.	Input Voltage Sensing	39
4.6.	External Temperature Sensing.....	39
4.7.	CONFIG0 – Over-Current Protection Threshold	40
4.8.	CONFIG1 – Compensation Loop and Output Voltage Slew Rate.....	41
5	Typical Performance Data.....	46
5.1.	ZSPM1501 – Typical Load Transient Response – Capacitor Range #1 – Comp0.....	47
5.2.	ZSPM1501 – Typical Load Transient Response – Capacitor Range #2 – Comp1.....	48
5.3.	ZSPM1501 – Typical Load Transient Response – Capacitor Range #3 – Comp2.....	49
5.4.	ZSPM1501 – Typical Load Transient Response – Capacitor Range #4 – Comp3.....	50
5.5.	ZSPM1502 – Typical Load Transient Response – Capacitor Range #1 – Comp0.....	51
5.6.	ZSPM1502 – Typical Load Transient Response – Capacitor Range #2 – Comp1.....	52
5.7.	ZSPM1502 – Typical Load Transient Response – Capacitor Range #3 – Comp2.....	53
5.8.	ZSPM1502 – Typical Load Transient Response – Capacitor Range #4 – Comp3.....	54
5.9.	ZSPM1503 – Typical Load Transient Response – Capacitor Range #1 – Comp0.....	55
5.10.	ZSPM1503 – Typical Load Transient Response – Capacitor Range #2 – Comp1.....	56
5.11.	ZSPM1503 – Typical Load Transient Response – Capacitor Range #3 – Comp2.....	57
5.12.	ZSPM1503 – Typical Load Transient Response – Capacitor Range #4 – Comp3.....	58
5.13.	ZSPM1504 – Typical Load Transient Response – Capacitor Range #1 – Comp0.....	59
5.14.	ZSPM1504 – Typical Load Transient Response – Capacitor Range #2 – Comp1.....	60
5.15.	ZSPM1504 – Typical Load Transient Response – Capacitor Range #3 – Comp2.....	61
5.16.	ZSPM1504 – Typical Load Transient Response – Capacitor Range #4 – Comp3.....	62
5.17.	ZSPM1505 – Typical Load Transient Response – Capacitor Range #1 – Comp0.....	63
5.18.	ZSPM1505 – Typical Load Transient Response – Capacitor Range #2 – Comp1.....	64
5.19.	ZSPM1505 – Typical Load Transient Response – Capacitor Range #3 – Comp2.....	65
5.20.	ZSPM1505 – Typical Load Transient Response – Capacitor Range #4 – Comp3.....	66
5.21.	ZSPM1506 – Typical Load Transient Response – Capacitor Range #1 – Comp0.....	67
5.22.	ZSPM1506 – Typical Load Transient Response – Capacitor Range #2 – Comp1.....	68
5.23.	ZSPM1506 – Typical Load Transient Response – Capacitor Range #3 – Comp2.....	69
5.24.	ZSPM1506 – Typical Load Transient Response – Capacitor Range #4 – Comp3.....	70
5.25.	ZSPM1507 – Typical Load Transient Response –Capacitor Range 1 – Comp0.....	71
5.26.	ZSPM1507 – Typical Load Transient Response –Capacitor Range 2 – Comp1.....	72
5.27.	ZSPM1507 – Typical Load Transient Response –Capacitor Range 3 – Comp2.....	73
5.28.	ZSPM1507 – Typical Load Transient Response –Capacitor Range 4 – Comp3.....	74
5.29.	ZSPM1508 – Typical Load Transient Response –Capacitor Range 1 – Comp0.....	75
5.30.	ZSPM1508 – Typical Load Transient Response –Capacitor Range 2 – Comp1.....	76
5.31.	ZSPM1508 – Typical Load Transient Response –Capacitor Range 3 – Comp2.....	77
5.32.	ZSPM1508 – Typical Load Transient Response –Capacitor Range 4 – Comp3.....	78
5.33.	ZSPM1509 – Typical Load Transient Response –Capacitor Range 1 – Comp0.....	79

5.34.	ZSPM1509 – Typical Load Transient Response –Capacitor Range 2 – Comp1.....	80
5.35.	ZSPM1509 – Typical Load Transient Response –Capacitor Range 3 – Comp2.....	81
5.36.	ZSPM1509 – Typical Load Transient Response –Capacitor Range 4 – Comp3.....	82
5.37.	ZSPM1511 – Typical Load Transient Response – Capacitor Range #1 – Comp0.....	83
5.38.	ZSPM1511 – Typical Load Transient Response – Capacitor Range #2 – Comp1.....	84
5.39.	ZSPM1511 – Typical Load Transient Response – Capacitor Range #3 – Comp2.....	85
5.40.	ZSPM1511 – Typical Load Transient Response – Capacitor Range #4 – Comp3.....	86
5.41.	ZSPM1512 – Typical Load Transient Response – Capacitor Range #1 – Comp0.....	87
5.42.	ZSPM1512 – Typical Load Transient Response – Capacitor Range #2 – Comp1.....	88
5.43.	ZSPM1512 – Typical Load Transient Response – Capacitor Range #3 – Comp2.....	89
5.44.	ZSPM1512 – Typical Load Transient Response – Capacitor Range #4 – Comp3.....	90
5.45.	ZSPM1513 – Typical Load Transient Response – Capacitor Range #1 – Comp0.....	91
5.46.	ZSPM1513 – Typical Load Transient Response – Capacitor Range #2 – Comp1.....	92
5.47.	ZSPM1513 – Typical Load Transient Response – Capacitor Range #3 – Comp2.....	93
5.48.	ZSPM1513 – Typical Load Transient Response – Capacitor Range #4 – Comp3.....	94
5.49.	Typical Efficiency Curves – ZSPM1502 with ZSPM9000, ZSPM9015, and ZSPM9060 DrMOS	95
5.50.	Typical Efficiency Curves – ZSPM9000 DrMOS with ZSPM1504, ZSPM1505, and ZSPM1506	96
5.51.	Typical Efficiency Curves – ZSPM9000 and ZSPM9060 DrMOS with ZSPM1508 and ZSPM1509	97
5.52.	Typical Efficiency Curves – ZSPM9000 and ZSPM9060 DrMOS with ZSPM1511, ZSPM1512, and ZSPM1513.....	98
6	Mechanical Specifications.....	99
7	Ordering Information	100
8	Related Documents.....	100
9	Glossary	101
10	Document Revision History.....	101

List of Figures

Figure 2.1	Typical Application Circuit with a 5V Supply Voltage.....	25
Figure 2.2	Block Diagram	26
Figure 2.3	Pin-out QFN24 Package	28
Figure 3.1	Simplified Block Diagram of the Digital Compensation.....	30
Figure 3.2	Power Sequencing.....	31
Figure 4.1	ZSPM15xx – Application Circuit with a 5V Supply Voltage	34
Figure 4.2	Output Voltage Sense Circuitry.....	38
Figure 4.3	Inductor Current Sensing Using the DCR Method.....	38
Figure 4.4	Input Voltage Sense Circuitry.....	39
Figure 4.5	External Temperature Sense Circuitry.....	39
Figure 5.1	ZSPM1501 with Comp0; 5A to 15A Load Step; and Min. Capacitance.....	47

Figure 5.2	ZSPM1501 with Comp0; 15A to 5A Load Step; and Min. Capacitance.....	47
Figure 5.3	ZSPM1501 with Comp0; 5A to 15A Load Step; and Max. Capacitance.....	47
Figure 5.4	ZSPM1501 with Comp0; 15A to 5A Load Step; and Max. Capacitance.....	47
Figure 5.5	Open Loop Bode Plots for ZSPM1501 with Comp0.....	47
Figure 5.6	ZSPM1501 with Comp1; 5A to 15A Load Step; and Min. Capacitance.....	48
Figure 5.7	ZSPM1501 with Comp1; 15A to 5A Load Step; and Min. Capacitance.....	48
Figure 5.8	ZSPM1501 with Comp1; 5A to 15A Load Step; and Max. Capacitance.....	48
Figure 5.9	ZSPM1501 with Comp1; 15A to 5A Load Step; and Max. Capacitance.....	48
Figure 5.10	Open Loop Bode Plots for ZSPM1501 with Comp1.....	48
Figure 5.11	ZSPM1501 with Comp2; 5A to 15A Load Step; and Min. Capacitance.....	49
Figure 5.12	ZSPM1501 with Comp2; 15A to 5A Load Step; and Min. Capacitance.....	49
Figure 5.13	ZSPM1501 with Comp2; 5A to 15A Load Step; and Max. Capacitance.....	49
Figure 5.14	ZSPM1501 with Comp2; 15A to 5A Load Step; and Max. Capacitance.....	49
Figure 5.15	Open Loop Bode Plots for ZSPM1501 with Comp2.....	49
Figure 5.16	ZSPM1501 with Comp3; 5A to 15A Load Step; and Min. Capacitance.....	50
Figure 5.17	ZSPM1501 with Comp3; 15A to 5A Load Step; and Min. Capacitance.....	50
Figure 5.18	ZSPM1501 with Comp3; 5A to 15A Load Step; and Max. Capacitance.....	50
Figure 5.19	ZSPM1501 with Comp3; 15A to 5A Load Step; and Max. Capacitance.....	50
Figure 5.20	Open Loop Bode Plots for ZSPM1501 with Comp3.....	50
Figure 5.21	ZSPM1502 with Comp0; 5A to 15A Load Step; and Min. Capacitance.....	51
Figure 5.22	ZSPM1502 with Comp0; 15A to 5A Load Step; and Min. Capacitance.....	51
Figure 5.23	ZSPM1502 with Comp0; 5A to 15A Load Step; and Max. Capacitance.....	51
Figure 5.24	ZSPM1502 with Comp0; 15A to 5A Load Step; and Max. Capacitance.....	51
Figure 5.25	Open Loop Bode Plots for ZSPM1502 with Comp0.....	51
Figure 5.26	ZSPM1502 with Comp1; 5A to 15A Load Step; and Min. Capacitance.....	52
Figure 5.27	ZSPM1502 with Comp1; 15A to 5A Load Step; and Min. Capacitance.....	52
Figure 5.28	ZSPM1502 with Comp1; 5A to 15A Load Step; and Max. Capacitance.....	52
Figure 5.29	ZSPM1502 with Comp1; 15A to 5A Load Step; and Max. Capacitance.....	52
Figure 5.30	Open Loop Bode Plots for ZSPM1502 with Comp1.....	52
Figure 5.31	ZSPM1502 with Comp2; 5A to 15A Load Step; and Min. Capacitance.....	53
Figure 5.32	ZSPM1502 with Comp2; 15A to 5A Load Step; and Min. Capacitance.....	53
Figure 5.33	ZSPM1502 with Comp2; 5A to 15A Load Step; and Max. Capacitance.....	53
Figure 5.34	ZSPM1502 with Comp2; 15A to 5A Load Step; and Max. Capacitance.....	53
Figure 5.35	Open Loop Bode Plots for ZSPM1502 with Comp2.....	53
Figure 5.36	ZSPM1502 with Comp3; 5A to 15A Load Step; and Min. Capacitance.....	54
Figure 5.37	ZSPM1502 with Comp3; 15A to 5A Load Step; and Min. Capacitance.....	54
Figure 5.38	ZSPM1502 with Comp3; 5A to 15A Load Step; and Max. Capacitance.....	54
Figure 5.39	ZSPM1502 with Comp3; 15A to 5A Load Step; and Max. Capacitance.....	54
Figure 5.40	Open Loop Bode Plots for ZSPM1502 with Comp3.....	54

Figure 5.41	ZSPM1503 with Comp0; 5A to 15A Load Step; and Min. Capacitance.....	55
Figure 5.42	ZSPM1503 with Comp0; 15A to 5A Load Step; and Min. Capacitance.....	55
Figure 5.43	ZSPM1503 with Comp0; 5A to 15A Load Step; and Max. Capacitance.....	55
Figure 5.44	ZSPM1503 with Comp0; 15A to 5A Load Step; and Max. Capacitance.....	55
Figure 5.45	Open Loop Bode Plots for ZSPM1503 with Comp0.....	55
Figure 5.46	ZSPM1503 with Comp1; 5A to 15A Load Step; and Min. Capacitance.....	56
Figure 5.47	ZSPM1503 with Comp1; 15A to 5A Load Step; and Min. Capacitance.....	56
Figure 5.48	ZSPM1503 with Comp1; 5 to 15A Load Step; and Max. Capacitance	56
Figure 5.49	ZSPM1503 with Comp1; 15 to 5A Load Step; and Max. Capacitance	56
Figure 5.50	Open Loop Bode Plots for ZSPM1503 with Comp1.....	56
Figure 5.51	ZSPM1503 with Comp2; 5A to 15A Load Step; and Min. Capacitance.....	57
Figure 5.52	ZSPM1503 with Comp2; 15A to 5A Load Step; and Min. Capacitance.....	57
Figure 5.53	ZSPM1503 with Comp2; 5A to 15A Load Step; and Max. Capacitance.....	57
Figure 5.54	ZSPM1503 with Comp2; 15A to 5A Load Step; and Max. Capacitance.....	57
Figure 5.55	Open Loop Bode Plots for ZSPM1503 with Comp2.....	57
Figure 5.56	ZSPM1503 with Comp3; 5A to 15A Load Step; and Min. Capacitance.....	58
Figure 5.57	ZSPM1503 with Comp3; 15A to 5A Load Step; and Min. Capacitance.....	58
Figure 5.58	ZSPM1503 with Comp3; 5A to 15A Load Step; and Max. Capacitance.....	58
Figure 5.59	ZSPM1503 with Comp3; 15A to 5A Load Step; and Max. Capacitance.....	58
Figure 5.60	Open Loop Bode Plots for ZSPM1503 with Comp3.....	58
Figure 5.61	ZSPM1504 with Comp0; 5A to 15A Load Step; and Min. Capacitance.....	59
Figure 5.62	ZSPM1504 with Comp0; 15A to 5A Load Step; and Min. Capacitance.....	59
Figure 5.63	ZSPM1504 with Comp0; 5A to 15A Load Step; and Max. Capacitance.....	59
Figure 5.64	ZSPM1504 with Comp0; 15A to 5A Load Step; and Max. Capacitance.....	59
Figure 5.65	Open Loop Bode Plots for ZSPM1504 with Comp0.....	59
Figure 5.66	ZSPM1504 with Comp1; 5A to 15A Load Step; and Min. Capacitance.....	60
Figure 5.67	ZSPM1504 with Comp1; 15A to 5A Load Step; and Min. Capacitance.....	60
Figure 5.68	ZSPM1504 with Comp1; 5A to 15A Load Step; and Max. Capacitance.....	60
Figure 5.69	ZSPM1504 with Comp1; 15A to 5A Load Step; and Max. Capacitance.....	60
Figure 5.70	Open Loop Bode Plots for ZSPM1504 with Comp1.....	60
Figure 5.71	ZSPM1504 with Comp2; 5A to 15A Load Step; and Min. Capacitance.....	61
Figure 5.72	ZSPM1504 with Comp2; 15A to 5A Load Step; and Min. Capacitance.....	61
Figure 5.73	ZSPM1504 with Comp2; 5A to 15A Load Step; and Max. Capacitance.....	61
Figure 5.74	ZSPM1504 with Comp2; 15A to 5A Load Step; and Max. Capacitance.....	61
Figure 5.75	Open Loop Bode Plots for ZSPM1504 with Comp2.....	61
Figure 5.76	ZSPM1504 with Comp3; 5A to 15A Load Step; and Min. Capacitance.....	62
Figure 5.77	ZSPM1504 with Comp3; 15A to 5A Load Step; and Min. Capacitance.....	62
Figure 5.78	ZSPM1504 with Comp3; 5A to 15A Load Step; and Max. Capacitance.....	62
Figure 5.79	ZSPM1504 with Comp3; 15A to 5A Load Step; and Max. Capacitance.....	62

Figure 5.80	Open Loop Bode Plots for ZSPM1504 with Comp3.....	62
Figure 5.81	ZSPM1505 with Comp0; 5A to 15A Load Step; and Min. Capacitance.....	63
Figure 5.82	ZSPM1505 with Comp0; 15A to 5A Load Step; and Min. Capacitance.....	63
Figure 5.83	ZSPM1505 with Comp0; 5A to 15A Load Step; and Max. Capacitance.....	63
Figure 5.84	ZSPM1505 with Comp0; 15A to 5A Load Step; and Max. Capacitance.....	63
Figure 5.85	Open Loop Bode Plots for ZSPM1505 with Comp0.....	63
Figure 5.86	ZSPM1505 with Comp1; 5A to 15A Load Step; and Min. Capacitance.....	64
Figure 5.87	ZSPM1505 with Comp1; 15A to 5A Load Step; and Min. Capacitance.....	64
Figure 5.88	ZSPM1505 with Comp1; 5A to 15A Load Step; and Max. Capacitance.....	64
Figure 5.89	ZSPM1505 with Comp1; 15A to 5A Load Step; and Max. Capacitance.....	64
Figure 5.90	Open Loop Bode Plots for ZSPM1505 with Comp1.....	64
Figure 5.91	ZSPM1505 with Comp2; 5A to 15A Load Step; and Min. Capacitance.....	65
Figure 5.92	ZSPM1505 with Comp2; 15A to 5A Load Step; and Min. Capacitance.....	65
Figure 5.93	ZSPM1505 with Comp2; 5A to 15A Load Step; and Max. Capacitance.....	65
Figure 5.94	ZSPM1505 with Comp2; 15A to 5A Load Step; and Max. Capacitance.....	65
Figure 5.95	Open Loop Bode Plots for ZSPM1505 with Comp2.....	65
Figure 5.96	ZSPM1505 with Comp3; 5A to 15A Load Step; and Min. Capacitance.....	66
Figure 5.97	ZSPM1505 with Comp3; 15A to 5A Load Step; and Min. Capacitance.....	66
Figure 5.98	ZSPM1505 with Comp3; 5A to 15A Load Step; and Max. Capacitance.....	66
Figure 5.99	ZSPM1505 with Comp3; 15A to 5A Load Step; and Max. Capacitance.....	66
Figure 5.100	Open Loop Bode Plots for ZSPM1505 with Comp3.....	66
Figure 5.101	ZSPM1506 with Comp0; 5A to 15A Load Step; and Min. Capacitance.....	67
Figure 5.102	ZSPM1506 with Comp0; 15A to 5A Load Step; and Min. Capacitance.....	67
Figure 5.103	ZSPM1506 with Comp0; 5A to 15A Load Step; and Max. Capacitance.....	67
Figure 5.104	ZSPM1506 with Comp0; 15A to 5A Load Step; and Max. Capacitance.....	67
Figure 5.105	Open Loop Bode Plots for ZSPM1506 with Comp0.....	67
Figure 5.106	ZSPM1506 with Comp1; 5A to 15A Load Step; and Min. Capacitance.....	68
Figure 5.107	ZSPM1506 with Comp1; 15A to 5A Load Step; and Min. Capacitance.....	68
Figure 5.108	ZSPM1506 with Comp1; 5A to 15A Load Step; and Max. Capacitance.....	68
Figure 5.109	ZSPM1506 with Comp1; 15A to 5A Load Step; and Max. Capacitance.....	68
Figure 5.110	Open Loop Bode Plots for ZSPM1506 with Comp1.....	68
Figure 5.111	ZSPM1506 with Comp2; 5A to 15A Load Step; and Min. Capacitance.....	69
Figure 5.112	ZSPM1506 with Comp2; 15A to 5A Load Step; and Min. Capacitance.....	69
Figure 5.113	ZSPM1506 with Comp2; 5A to 15A Load Step; and Max. Capacitance.....	69
Figure 5.114	ZSPM1506 with Comp2; 15A to 5A Load Step; and Max. Capacitance.....	69
Figure 5.115	Open Loop Bode Plots for ZSPM1506 with Comp2.....	69
Figure 5.116	ZSPM1506 with Comp3; 5A to 15A Load Step; and Min. Capacitance.....	70
Figure 5.117	ZSPM1506 with Comp3; 15A to 5A Load Step; and Min. Capacitance.....	70

Figure 5.118	ZSPM1506 with Comp3; 5A to 15A Load Step; and Max. Capacitance.....	70
Figure 5.119	ZSPM1506 with Comp3; 15A to 5A Load Step; and Max. Capacitance.....	70
Figure 5.120	Open Loop Bode Plots for ZSPM1506 with Comp3.....	70
Figure 5.121	ZSPM1507 with Comp0; 5 to 15A Load Step; and Min. Capacitance	71
Figure 5.122	ZSPM1507 with Comp0; 15 to 5A Load Step; and Min. Capacitance	71
Figure 5.123	ZSPM1507 with Comp0; 5 to 15A Load Step; and Max. Capacitance	71
Figure 5.124	ZSPM1507 with Comp0; 15 to 5A Load Step; and Max. Capacitance	71
Figure 5.125	Open Loop Bode Plots for ZSPM1507 with Comp0.....	71
Figure 5.126	ZSPM1507 with Comp1; 5 to 15A Load Step; and Min. Capacitance	72
Figure 5.127	ZSPM1507 with Comp1; 15 to 5A Load Step; and Min. Capacitance	72
Figure 5.128	ZSPM1507 with Comp1; 5 to 15A Load Step; and Max. Capacitance	72
Figure 5.129	ZSPM1507 with Comp1; 15 to 5A Load Step; and Max. Capacitance	72
Figure 5.130	Open Loop Bode Plots for ZSPM1507 with Comp1.....	72
Figure 5.131	ZSPM1507 with Comp2; 5 to 15A Load Step; and Min. Capacitance	73
Figure 5.132	ZSPM1507 with Comp2; 15 to 5A Load Step; and Min. Capacitance	73
Figure 5.133	ZSPM1507 with Comp2; 5 to 15A Load Step; and Max. Capacitance	73
Figure 5.134	ZSPM1507 with Comp2; 15 to 5A Load Step; and Max. Capacitance	73
Figure 5.135	Open Loop Bode Plots for ZSPM1507 with Comp2.....	73
Figure 5.136	ZSPM1507 with Comp3; 5 to 15A Load Step; and Min. Capacitance	74
Figure 5.137	ZSPM1507 with Comp3; 15 to 5A Load Step; and Min. Capacitance	74
Figure 5.138	ZSPM1507 with Comp3; 5 to 15A Load Step; and Max. Capacitance	74
Figure 5.139	ZSPM1507 with Comp3; 15 to 5A Load Step; and Max. Capacitance	74
Figure 5.140	Open Loop Bode Plots for ZSPM1507 with Comp3.....	74
Figure 5.141	ZSPM1508 with Comp0; 5A to 10A Load Step; and Min. Capacitance.....	75
Figure 5.142	ZSPM1508 with Comp0; 10A to 5A Load Step; and Min. Capacitance.....	75
Figure 5.143	ZSPM1508 with Comp0; 5A to 10A Load Step; and Max. Capacitance.....	75
Figure 5.144	ZSPM1508 with Comp0; 10A to 5A Load Step; and Max. Capacitance.....	75
Figure 5.145	Open Loop Bode Plots for ZSPM1508 with Comp0.....	75
Figure 5.146	ZSPM1508 with Comp1; 5A to 10A Load Step; and Min. Capacitance.....	76
Figure 5.147	ZSPM1508 with Comp1; 10A to 5A Load Step; and Min. Capacitance.....	76
Figure 5.148	ZSPM1508 with Comp1; 5A to 10A Load Step; and Max. Capacitance.....	76
Figure 5.149	ZSPM1508 with Comp1; 10A to 5A Load Step; and Max. Capacitance.....	76
Figure 5.150	Open Loop Bode Plots for ZSPM1508 with Comp1.....	76
Figure 5.151	ZSPM1508 with Comp2; 5A to 10A Load Step; and Min. Capacitance.....	77
Figure 5.152	ZSPM1508 with Comp2; 10A to 5A Load Step; and Min. Capacitance.....	77
Figure 5.153	ZSPM1508 with Comp2; 5A to 10A Load Step; and Max. Capacitance.....	77
Figure 5.154	ZSPM1508 with Comp2; 10A to 5A Load Step; and Max. Capacitance.....	77
Figure 5.155	Open Loop Bode Plots for ZSPM1508 with Comp2.....	77
Figure 5.156	ZSPM1508 with Comp3; 5A to 10A Load Step; and Min. Capacitance.....	78

Figure 5.157	ZSPM1508 with Comp3; 10A to 5A Load Step; and Min. Capacitance.....	78
Figure 5.158	ZSPM1508 with Comp3; 5A to 10A Load Step; and Max. Capacitance.....	78
Figure 5.159	ZSPM1508 with Comp3; 10A to 5A Load Step; and Max. Capacitance.....	78
Figure 5.160	Open Loop Bode Plots for ZSPM1508 with Comp3.....	78
Figure 5.161	ZSPM1509 with Comp0; 3A to 8A Load Step; and Min. Capacitance.....	79
Figure 5.162	ZSPM1509 with Comp0; 8A to 3A Load Step; and Min. Capacitance.....	79
Figure 5.163	ZSPM1509 with Comp0; 3A to 8A Load Step; and Max. Capacitance.....	79
Figure 5.164	ZSPM1509 with Comp0; 8A to 3A Load Step; and Max. Capacitance.....	79
Figure 5.165	Open Loop Bode Plots for ZSPM1509 with Comp0.....	79
Figure 5.166	ZSPM1509 with Comp1; 3A to 8A Load Step; and Min. Capacitance.....	80
Figure 5.167	ZSPM1509 with Comp1; 8A to 3A Load Step; and Min. Capacitance.....	80
Figure 5.168	ZSPM1509 with Comp1; 3A to 8A Load Step; and Max. Capacitance.....	80
Figure 5.169	ZSPM1509 with Comp1; 8A to 3A Load Step; and Max. Capacitance.....	80
Figure 5.170	Open Loop Bode Plots for ZSPM1509 with Comp1.....	80
Figure 5.171	ZSPM1509 with Comp2; 3A to 8A Load Step; and Min. Capacitance.....	81
Figure 5.172	ZSPM1509 with Comp2; 8A to 3A Load Step; and Min. Capacitance.....	81
Figure 5.173	ZSPM1509 with Comp2; 3A to 8A Load Step; and Max. Capacitance.....	81
Figure 5.174	ZSPM1509 with Comp2; 8A to 3A Load Step; and Max. Capacitance.....	81
Figure 5.175	Open Loop Bode Plots for ZSPM1509 with Comp2.....	81
Figure 5.176	ZSPM1509 with Comp3; 3A to 8A Load Step; and Min. Capacitance.....	82
Figure 5.177	ZSPM1509 with Comp3; 8A to 3A Load Step; and Min. Capacitance.....	82
Figure 5.178	ZSPM1509 with Comp3; 3A to 8A Load Step; and Max. Capacitance.....	82
Figure 5.179	ZSPM1509 with Comp3; 8A to 3A Load Step; and Max. Capacitance.....	82
Figure 5.180	Open Loop Bode Plots for ZSPM1509 with Comp3.....	82
Figure 5.181	ZSPM1511 with Comp0; 5A to 15A Load Step; and Min. Capacitance.....	83
Figure 5.182	ZSPM1511 with Comp0; 15A to 5A Load Step; and Min. Capacitance.....	83
Figure 5.183	ZSPM1511 with Comp0; 5A to 15A Load Step; and Max. Capacitance.....	83
Figure 5.184	ZSPM1511 with Comp0; 15A to 5A Load Step; and Max. Capacitance.....	83
Figure 5.185	Open Loop Bode Plots for ZSPM1511 with Comp0.....	83
Figure 5.186	ZSPM1511 with Comp1; 5A to 15A Load Step; and Min. Capacitance.....	84
Figure 5.187	ZSPM1511 with Comp1; 15A to 5A Load Step; and Min. Capacitance.....	84
Figure 5.188	ZSPM1511 with Comp1; 5A to 15A Load Step; and Max. Capacitance.....	84
Figure 5.189	ZSPM1511 with Comp1; 15A to 5A Load Step; and Max. Capacitance.....	84
Figure 5.190	Open Loop Bode Plots for ZSPM1511 with Comp1.....	84
Figure 5.191	ZSPM1511 with Comp2; 5A to 15A Load Step; and Min. Capacitance.....	85
Figure 5.192	ZSPM1511 with Comp2; 15A to 5A Load Step; and Min. Capacitance.....	85
Figure 5.193	ZSPM1511 with Comp2; 5A to 15A Load Step; and Max. Capacitance.....	85
Figure 5.194	ZSPM1511 with Comp2; 15A to 5A Load Step; and Max. Capacitance.....	85
Figure 5.195	Open Loop Bode Plots for ZSPM1511 with Comp2.....	85

Figure 5.196	ZSPM1511 with Comp3; 5A to 15A Load Step; and Min. Capacitance.....	86
Figure 5.197	ZSPM1511 with Comp3; 15A to 5A Load Step; and Min. Capacitance.....	86
Figure 5.198	ZSPM1511 with Comp3; 5A to 15A Load Step; and Max. Capacitance.....	86
Figure 5.199	ZSPM1511 with Comp3; 15A to 5A Load Step; and Max. Capacitance.....	86
Figure 5.200	Open Loop Bode Plots for ZSPM1511 with Comp3.....	86
Figure 5.201	ZSPM1512 with Comp0; 5A to 15A Load Step; and Min. Capacitance.....	87
Figure 5.202	ZSPM1512 with Comp0; 15A to 5A Load Step; and Min. Capacitance.....	87
Figure 5.203	ZSPM1512 with Comp0; 5A to 15A Load Step; and Max. Capacitance.....	87
Figure 5.204	ZSPM1512 with Comp0; 15A to 5A Load Step; and Max. Capacitance.....	87
Figure 5.205	Open Loop Bode Plots for ZSPM1512 with Comp0.....	87
Figure 5.206	ZSPM1512 with Comp1; 5A to 15A Load Step; and Min. Capacitance.....	88
Figure 5.207	ZSPM1512 with Comp1; 15A to 5A Load Step; and Min. Capacitance.....	88
Figure 5.208	ZSPM1512 with Comp1; 5A to 15A Load Step; and Max. Capacitance.....	88
Figure 5.209	ZSPM1512 with Comp1; 15A to 5A Load Step; and Max. Capacitance.....	88
Figure 5.210	Open Loop Bode Plots for ZSPM1512 with Comp1.....	88
Figure 5.211	ZSPM1512 with Comp2; 5A to 15A Load Step; and Min. Capacitance.....	89
Figure 5.212	ZSPM1512 with Comp2; 15A to 5A Load Step; and Min. Capacitance.....	89
Figure 5.213	ZSPM1512 with Comp2; 5A to 15A Load Step; and Max. Capacitance.....	89
Figure 5.214	ZSPM1512 with Comp2; 15A to 5A Load Step; and Max. Capacitance.....	89
Figure 5.215	Open Loop Bode Plots for ZSPM1512 with Comp2.....	89
Figure 5.216	ZSPM1512 with Comp3; 5A to 15A Load Step; and Min. Capacitance.....	90
Figure 5.217	ZSPM1512 with Comp3; 15A to 5A Load Step; and Min. Capacitance.....	90
Figure 5.218	ZSPM1512 with Comp3; 5A to 15A Load Step; and Max. Capacitance.....	90
Figure 5.219	ZSPM1512 with Comp3; 15A to 5A Load Step; and Max. Capacitance.....	90
Figure 5.220	Open Loop Bode Plots for ZSPM1512 with Comp3.....	90
Figure 5.221	ZSPM1513 with Comp0; 5A to 15A Load Step; and Min. Capacitance.....	91
Figure 5.222	ZSPM1513 with Comp0; 15A to 5A Load Step; and Min. Capacitance.....	91
Figure 5.223	ZSPM1513 with Comp0; 5A to 15A Load Step; and Max. Capacitance.....	91
Figure 5.224	ZSPM1513 with Comp0; 15A to 5A Load Step; and Max. Capacitance.....	91
Figure 5.225	Open Loop Bode Plots for ZSPM1513 with Comp0.....	91
Figure 5.226	ZSPM1513 with Comp1; 5A to 15A Load Step; and Min. Capacitance.....	92
Figure 5.227	ZSPM1513 with Comp1; 15A to 5A Load Step; and Min. Capacitance.....	92
Figure 5.228	ZSPM1513 with Comp1; 5 to 15A Load Step; and Max. Capacitance.....	92
Figure 5.229	ZSPM1513 with Comp1; 15 to 5A Load Step; and Max. Capacitance.....	92
Figure 5.230	Open Loop Bode Plots for ZSPM1513 with Comp1.....	92
Figure 5.231	ZSPM1513 with Comp2; 5A to 15A Load Step; and Min. Capacitance.....	93
Figure 5.232	ZSPM1513 with Comp2; 15A to 5A Load Step; and Min. Capacitance.....	93
Figure 5.233	ZSPM1513 with Comp2; 5A to 15A Load Step; and Max. Capacitance.....	93
Figure 5.234	ZSPM1513 with Comp2; 15A to 5A Load Step; and Max. Capacitance.....	93
Figure 5.235	Open Loop Bode Plots for ZSPM1513 with Comp2.....	93
Figure 5.236	ZSPM1513 with Comp3; 5A to 15A Load Step; and Min. Capacitance.....	94
Figure 5.237	ZSPM1513 with Comp3; 15A to 5A Load Step; and Min. Capacitance.....	94

Figure 5.238	ZSPM1513 with Comp3; 5A to 15A Load Step; and Max. Capacitance.....	94
Figure 5.239	ZSPM1513 with Comp3; 15A to 5A Load Step; and Max. Capacitance.....	94
Figure 5.240	Open Loop Bode Plots for ZSPM1513 with Comp3.....	94
Figure 5.241	Typical Efficiency Curves: ZSPM1502 with ZSPM9000, ZSPM9015, and ZSPM9060 DrMOS ($V_{IN} = 12V$; $V_{out} = 1.0V$).....	95
Figure 5.242	Typical Efficiency Curves: ZSPM9000 DrMOS with ZSPM1504, ZSPM1505, and ZSPM1506 ($V_{IN} = 12V$).....	96
Figure 5.243	Typical Efficiency Curves: ZSPM9000 and ZSPM9060 DrMOS with ZSPM1508 and ZSPM150997	
Figure 5.244	Typical Efficiency Curves: ZSPM9000 and ZSPM9060 DrMOS with ZSPM1511, ZSPM1512, and ZSPM1513	98
Figure 6.1	24-Pin QFN Package Drawing	99

List of Tables

Table 2.1	ZSPM15xx Pin Descriptions.....	27
Table 3.1	Fault Configuration Overview.....	32
Table 4.1	Passive Component Values for the Application Circuits.....	35
Table 4.2	Passive Components for the ZSPM1501, ZSPM1502, and ZSPM1503.....	36
Table 4.3	Passive Components for the ZSPM1504, ZSPM1505, and ZSPM1506.....	36
Table 4.4	Passive Components for the ZSPM1507.....	37
Table 4.5	Passive Components for the ZSPM1508 and ZSPM1509.....	37
Table 4.6	Passive Components for the ZSPM1511, ZSPM1512, and ZSPM1513.....	37
Table 4.7	ZSPM15xx – OCP Pin Strap Resistor Selection.....	40
Table 4.8	Recommended Output Capacitor Ranges.....	41
Table 4.9	Compensator and VOUT Slew Rate Pin Strap Resistor Selection for the ZSPM1501 to ZSPM1506 and the ZSPM1511 to ZSPM1513.....	42
Table 4.10	Compensator and VOUT Slew Rate Pin Strap Resistor Selection for the ZSPM1507.....	43
Table 4.11	Compensator and VOUT Slew Rate Pin Strap Resistor Selection for the ZSPM1508.....	44
Table 4.12	Compensator and VOUT Slew Rate Pin Strap Resistor Selection for the ZSPM1509.....	45

1 IC Characteristics

Note: The absolute maximum ratings are stress ratings only. The ZSPM15xx might not function or be operable above the recommended operating conditions. Stresses exceeding the absolute maximum ratings might also damage the device. In addition, extended exposure to stresses above the recommended operating conditions might affect device reliability. IDT does not recommend designing to the “Absolute Maximum Ratings.”

1.1. Absolute Maximum Ratings

PARAMETER	PINS	CONDITIONS	MIN	TYPICAL	MAX	UNITS
Supply voltages						
5V supply voltage	VDD50	dV/dt < 0.15V/μs	-0.3		5.5	V
Maximum slew rate					0.15	V/μs
3.3V supply voltage	VDD33		-0.3		3.6	V
1.8V supply voltage	VDD18 AVDD18		-0.3		2.0	V
Digital pins						
Digital I/O pins	THSHDN CONTROL PGOOD DRVEN PWM		-0.3		5.5	V
Analog pins						
Current sensing	ISNSP, ISNSN		-0.3		5.5	V
Voltage feedback	VFBP VFBN		-0.3		2.0	V
All other analog pins	ADCVREF VREFP TEMP VIN CONFIG0 CONFIG1		-0.3		2.0	V
Ambient Conditions						
Junction temperature T _J					125	°C
Storage temperature			-40		150	°C
Electrostatic discharge – Human Body Model		ESD testing is performed according to the respective JEDEC standard.			+/-2k	V
Electrostatic discharge – Charge Device Model		ESD testing is performed according to the respective JEDEC standard.			+/- 500	V

1.2. Recommended Operating Conditions

PARAMETER	SYMBOL	CONDITIONS	MIN	TYPICAL	MAX	UNITS
Ambient conditions						
Operation temperature	T_J		-40		125	°C
Thermal resistance junction to ambient	θ_{JA}			40		K/W

1.3. Electrical Parameters

PARAMETER	SYMBOL	CONDITIONS	MIN	TYPICAL	MAX	UNITS
Supply voltages						
5V supply voltage	V_{VDD50}		4.75	5.0	5.25	V
5V supply current	I_{VDD50}	VDD50=5.0V		23		mA
3.3V supply voltage	V_{VDD33}	Supply for both the VDD33 and VDD50 pins if the internal 3.3V regulator is not used.	3.0	3.3	3.6	V
3.3V supply current	I_{VDD33}	VDD50=VDD33=3.3V		23		mA
Internally generated supply voltages						
3.3V supply voltage	V_{VDD33}	VDD50=5.0V	3.0	3.3	3.6	V
3.3V output current	I_{VDD33}	VDD50=5.0V			2.0	mA
1.8V supply voltages	V_{AVDD18} V_{VDD18}	VDD50=5.0V	1.72	1.80	1.98	V
1.8V output current					0	mA
Power-on reset (POR)						
Power-on reset threshold – on	$V_{TH_POR_ON}$			2.8		V
Power-on reset threshold – off	$V_{TH_POR_OFF}$			2.6		V
Initialization period / internal startup time				5		ms
Digital IO pins (CONTROL, PGOOD, DRVEN, THSHDN)						
Input high voltage		VDD33=3.3V	2.0			V
Input low voltage		VDD33=3.3V			0.8	V
Output high voltage		VDD33=3.3V	2.4		VDD33	V
Output low voltage					0.5	V
Input leakage current					±1.0	μA
Output current – high					2.0	mA
Output current – low					2.0	mA

PARAMETER	SYMBOL	CONDITIONS	MIN	TYPICAL	MAX	UNITS
Digital IO pins with tri-state capability (PWM)						
Output high voltage		VDD33=3.3V	2.4		VDD33	V
Output low voltage					0.5	V
Output current – high					2.0	mA
Output current – low					2.0	mA
Tri-state leakage current					±1.0	µA
Output voltage						
Output voltage		The output voltage set-point is determined by product code.		(Refer to section 1.4)		
Set-point accuracy		VOUT=1.4V		1		%
Output voltage sequencing (see Figure 3.2)						
Turn-on delay -	t _{ON_DELAY}			1		ms
Turn-on rise time (slew rate)	t _{ON_RISE}	The rise time is configurable via pin strapping.	(Refer to section 4.8)			
Turn-on timeout	t _{ON_MAX}			10		ms
Turn-off delay	t _{OFF_DELAY}			0		ms
Turn-off fall time	t _{OFF_FALL}		6		10	ms
Turn-off timeout	t _{OFF_MAX}			500		ms
Power good turn-on level		The power good threshold is a percentage of the nominal output voltage (V _{OUT_NOM}), which is preconfigured for the ZSPM15xx part number (see section 1.4).		95%		V _{OUT_NOM}
Power good turn-off level				90%		V _{OUT_NOM}
Inductor current measurement						
Common mode voltage across ISNSP and ISNSN pins			0		5.0	V
Differential voltage range across ISNSP and ISNSN pins					±100	mV
Accuracy				5		%
Over-current protection threshold		The over-current protection threshold is configurable via pin strapping	(Refer to section 4.7)			

PARAMETER	SYMBOL	CONDITIONS	MIN	TYPICAL	MAX	UNITS
Digital pulse width modulator						
Switching frequency	f _{sw}			500		kHz
Resolution				163		ps
Frequency accuracy				2.0		%
Duty cycle			2.5		100	%
External temperature measurement (note: only PN-junction sense elements are supported)						
Offset voltage at 25°C				583		mV
Temperature coefficient				-2.2		mV/K
Bias currents for external temperature sensing				60		μA
Accuracy of measurement				±5.0		K
Over-temperature threshold				105		°C
Internal temperature measurement						
Accuracy of measurement				±5.0		K
Over-temperature threshold				95		°C

1.4. Device-Specific System Parameters

1.4.1. ZSPM1501

Note: In the following table, DNP (“do not place”) indicates the component is not used in the application circuit. Refer to Figure 2.1 for the components referenced below.

PARAMETER	SYMBOL	CONDITIONS	MIN	TYPICAL	MAX	UNITS
System power parameters						
Switching frequency	f_{SW}			500		kHz
Input voltage			10.8		13.2	V
Nominal output voltage	V_{OUT_NOM}	R5=1.0k Ω , R4=DNP		0.85		V
Output voltage under-voltage lockout threshold				0.764		V
Output voltage over-voltage lockout threshold				1.019		V
Input voltage over-voltage lockout threshold		R9=9.1k Ω , R8=1.0k Ω		13.80		V
Input voltage under-voltage lockout threshold		R9=9.1k Ω , R8=1.0k Ω		9.60		V
Application circuit						
Optimal output inductance: L1	L_{OUT}			330		nH
Feedback divider: R5				1.0		k Ω
Feedback divider: R4				DNP		

1.4.2. ZSPM1502

Note: In the following table, DNP (“do not place”) indicates the component is not used in the application circuit. Refer to Figure 2.1 for the components referenced below.

PARAMETER	SYMBOL	CONDITIONS	MIN	TYPICAL	MAX	UNITS
System power parameters						
Switching frequency	f_{SW}			500		kHz
Input voltage			10.8		13.2	V
Nominal output voltage	V_{OUT_NOM}	R5=1.0k Ω , R4=DNP		1.0		V
Output voltage under-voltage lockout threshold				0.90		V
Output voltage over-voltage lockout threshold				1.20		V
Input voltage over-voltage lockout threshold		R9=9.1k Ω , R8=1.0k Ω		13.80		V
Input voltage under-voltage lockout threshold		R9=9.1k Ω , R8=1.0k Ω		9.60		V

PARAMETER	SYMBOL	CONDITIONS	MIN	TYPICAL	MAX	UNITS
Application circuit						
Optimal output inductance – L1	L _{OUT}			330		nH
Feedback divider – R5				1.0		kΩ
Feedback divider – R4				DNP		

1.4.3. ZSPM1503

Note: In the following table, DNP (“do not place”) indicates the component is not used in the application circuit. Refer to Figure 2.1 for the components referenced below.

PARAMETER	SYMBOL	CONDITIONS	MIN	TYPICAL	MAX	UNITS
System power parameters						
Switching frequency	f _{SW}			500		kHz
Input voltage			10.8		13.2	V
Nominal output voltage	V _{OUT_NOM}	R5=1.0kΩ, R4=DNP		1.20		V
Output voltage under-voltage lockout threshold				1.08		V
Output voltage over-voltage lockout threshold				1.44		V
Input voltage over-voltage lockout threshold		R9=9.1kΩ, R8=1.0kΩ		13.80		V
Input voltage under-voltage lockout threshold		R9=9.1kΩ, R8=1.0kΩ		9.60		V
Application circuit						
Optimal output inductance – L1	L _{OUT}			330		nH
Feedback divider – R5				1.0		kΩ
Feedback divider – R4				DNP		

1.4.4. ZSPM1504

Note: Refer to Figure 2.1 for the components referenced below.

PARAMETER	SYMBOL	CONDITIONS	MIN	TYPICAL	MAX	UNITS
System power parameters						
Switching frequency	f_{sw}			500		kHz
Input voltage			10.8		13.2	V
Nominal output voltage	V_{OUT_NOM}	R5=750Ω, R4=1.0kΩ		1.5		V
Output voltage under-voltage lockout threshold				1.35		V
Output voltage over-voltage lockout threshold				1.80		V
Input voltage over-voltage lockout threshold		R9=9.1kΩ, R8=1.0kΩ		13.80		V
Input voltage under-voltage lockout threshold		R9=9.1kΩ, R8=1.0kΩ		9.60		V
Application circuit						
Optimal output inductance – L1	L_{OUT}			470		nH
Feedback divider – R5				750		Ω
Feedback divider – R4				1.0		kΩ

1.4.5. ZSPM1505

Note: Refer to Figure 2.1 for the components referenced below.

PARAMETER	SYMBOL	CONDITIONS	MIN	TYPICAL	MAX	UNITS
System power parameters						
Switching frequency	f_{sw}			500		kHz
Input voltage			10.8		13.2	V
Nominal output voltage	V_{OUT_NOM}	R5=750Ω, R4=1.0kΩ		1.8		V
Output voltage under-voltage lockout threshold				1.62		V
Output voltage over-voltage lockout threshold				2.16		V
Input voltage over-voltage lockout threshold		R9=9.1kΩ, R8=1.0kΩ		13.80		V
Input voltage under-voltage lockout threshold		R9=9.1kΩ, R8=1.0kΩ		9.60		V

PARAMETER	SYMBOL	CONDITIONS	MIN	TYPICAL	MAX	UNITS
Application circuit						
Optimal output inductance – L1	L _{OUT}			470		nH
Feedback divider – R5				750		Ω
Feedback divider – R4				1.0		kΩ

1.4.6. ZSPM1506

Note: Refer to Figure 2.1 for the components referenced below.

PARAMETER	SYMBOL	CONDITIONS	MIN	TYPICAL	MAX	UNITS
System power parameters						
Switching frequency	f _{SW}			500		kHz
Input voltage			10.8		13.2	V
Nominal output voltage	V _{OUT_NOM}	R5=750Ω, R4=1.0kΩ		2.0		V
Output voltage under-voltage lockout threshold				1.80		V
Output voltage over-voltage lockout threshold				2.40		V
Input voltage over-voltage lockout threshold		R9=9.1kΩ, R8=1.0kΩ		13.80		V
Input voltage under-voltage lockout threshold		R9=9.1kΩ, R8=1.0kΩ		9.60		V
Application circuit						
Optimal output inductance – L1	L _{OUT}			470		nH
Feedback divider – R5				750		Ω
Feedback divider – R4				1.0		kΩ

1.4.7. ZSPM1507

PARAMETER	SYMBOL	CONDITIONS	MIN	TYPICAL	MAX	UNITS
System power parameters						
Switching frequency	f_{SW}			500		kHz
Input voltage			10.8	12	13.2	V
Nominal output voltage	V_{OUT_NOM}	R5=1.0k Ω , R4=1.0k Ω		2.5V		V
Output voltage under-voltage lockout threshold				2.25		V
Output voltage over-voltage lockout threshold				3.0		V
Input voltage over-voltage lockout threshold		R9=9.1k Ω , R8=1.0k Ω		13.8		V
Input voltage under-voltage lockout threshold		R9=9.1k Ω , R8=1.0k Ω		9.6		V
Application circuit						
Optimal output inductance: L1	L_{OUT}			1000		nH
Feedback divider: R5				1.0		k Ω
Feedback divider: R4				1.0		k Ω

1.4.8. ZSPM1508

PARAMETER	SYMBOL	CONDITIONS	MIN	TYPICAL	MAX	UNITS
System power parameters						
Switching frequency	f_{SW}			500		kHz
Input voltage			10.8		13.2	V
Nominal output voltage	V_{OUT_NOM}	R5=3.3k Ω , R4=1.0k Ω		3.3		V
Output voltage under-voltage lockout threshold				2.97		V
Output voltage over-voltage lockout threshold				3.96		V
Input voltage over-voltage lockout threshold		R9=9.1k Ω , R8=1.0k Ω		13.80		V
Input voltage under-voltage lockout threshold		R9=9.1k Ω , R8=1.0k Ω		9.60		V
Application circuit						
Optimal output inductance: L1	L_{OUT}			2.20		μ H
Feedback divider: R5				3.3		k Ω
Feedback divider: R4				1.0		k Ω

1.4.9. ZSPM1509

PARAMETER	SYMBOL	CONDITIONS	MIN	TYPICAL	MAX	UNITS
System power parameters						
Switching frequency	f_{SW}			500		kHz
Input voltage			10.8		13.2	V
Nominal output voltage	V_{OUT_NOM}	R5=3.3k Ω , R4=1.0k Ω		5.0		V
Output voltage under-voltage lockout threshold				4.50		V
Output voltage over-voltage lockout threshold				5.50		V
Input voltage over-voltage lockout threshold		R9=9.1k Ω , R8=1.0k Ω		13.80		V
Input voltage under-voltage lockout threshold		R9=9.1k Ω , R8=1.0k Ω		9.60		V
Application circuit						
Optimal output inductance: L1	L_{OUT}			2.20		μ H
Feedback divider: R5				3.3		k Ω
Feedback divider: R4				1.0		k Ω

1.4.10. ZSPM1511

Note: In the following table, DNP (“do not place”) indicates the component is not used in the application circuit.

PARAMETER	SYMBOL	CONDITIONS	MIN	TYPICAL	MAX	UNITS
System power parameters						
Switching frequency	f_{SW}			500		kHz
Input voltage			10.8		13.2	V
Nominal output voltage	V_{OUT_NOM}	R5=1.0k Ω , R4=DNP		0.85		V
Output voltage under-voltage lockout threshold				0.764		V
Output voltage over-voltage lockout threshold				1.019		V
Input voltage over-voltage lockout threshold		R9=9.1 k Ω , R8=1.0k Ω		13.80		V
Input voltage under-voltage lockout threshold		R9=9.1 k Ω , R8=1.0k Ω		9.60		V
Application circuit						
Optimal output inductance – L1	L_{OUT}			680		η H
Feedback divider – R5				1.0		k Ω
Feedback divider – R4				DNP		

1.4.11. ZSPM1512

Note: In the following table, DNP (“do not place”) indicates the component is not used in the application circuit.

PARAMETER	SYMBOL	CONDITIONS	MIN	TYPICAL	MAX	UNITS
System power parameters						
Switching frequency	f_{sw}			500		kHz
Input voltage			10.8		13.2	V
Nominal output voltage	V_{OUT_NOM}	R5=1.0k Ω , R4=DNP		1.0		V
Output voltage under-voltage lockout threshold				0.90		V
Output voltage over-voltage lockout threshold				1.20		V
Input voltage over-voltage lockout threshold		R9=9.1 k Ω , R8=1.0k Ω		13.80		V
Input voltage under-voltage lockout threshold		R9=9.1 k Ω , R8=1.0k Ω		9.60		V
Application circuit						
Optimal output inductance – L1	L_{OUT}			680		η H
Feedback divider – R5				1.0		k Ω
Feedback divider – R4				DNP		k Ω

1.4.12. ZSPM1513

Note: In the following table, DNP (“do not place”) indicates the component is not used in the application circuit.

PARAMETER	SYMBOL	CONDITIONS	MIN	TYPICAL	MAX	UNITS
System power parameters						
Switching frequency	f_{sw}			500		kHz
Input voltage			10.8		13.2	V
Nominal output voltage	V_{OUT_NOM}	R5=1.0k Ω , R4=DNP		1.20		V
Output voltage under-voltage lockout threshold				1.08		V
Output voltage over-voltage lockout threshold				1.44		V
Input voltage over-voltage lockout threshold		R9=9.1 k Ω , R8=1.0k Ω		13.80		V
Input voltage under-voltage lockout threshold		R9=9.1 k Ω , R8=1.0k Ω		9.60		V
Application circuit						
Optimal output inductance – L1	L_{OUT}			680		η H
Feedback divider – R5				1.0		k Ω
Feedback divider – R4				DNP		k Ω

2 Product Summary

2.1. Overview

The ZSPM15xx is a configurable true-digital single-phase PWM controller for high-current, non-isolated DC/DC supplies. It incorporates a pre-configured digital control loop, which is optimized for different power stages, bundled with output voltage sensing, average inductor current sensing, and extensive fault monitoring and handling options.

Several different functional units are incorporated in the device. A dedicated digital control loop is used to provide fast loop response and optimal output voltage regulation. This includes output voltage sensing, average inductor current sensing, a digital control law, and a digital pulse-width modulator (DPWM). In parallel, a dedicated, configurable error handler allows fast detection of error signals and their appropriate handling. A housekeeping analog-to-digital converter (HKADC) ensures the reliable and efficient measurement of environmental signals, such as input voltage and temperature.

An application-specific, low-power integrated microcontroller is used to control the overall system. It manages configuration of the various logic units according to the preprogrammed configuration look-up tables and the external configuration resistors connected to the CONFIG0 and CONFIG1 pins. These pin-strapping resistors expedite configuration of the over-current protection threshold, compensation, and output voltage slew rate. A high-reliability, high-temperature one-time programmable memory (OTP) is used to store configuration parameters. All required bias and reference voltages are internally derived from the external supply voltage.

Figure 2.1 Typical Application Circuit with a 5V Supply Voltage

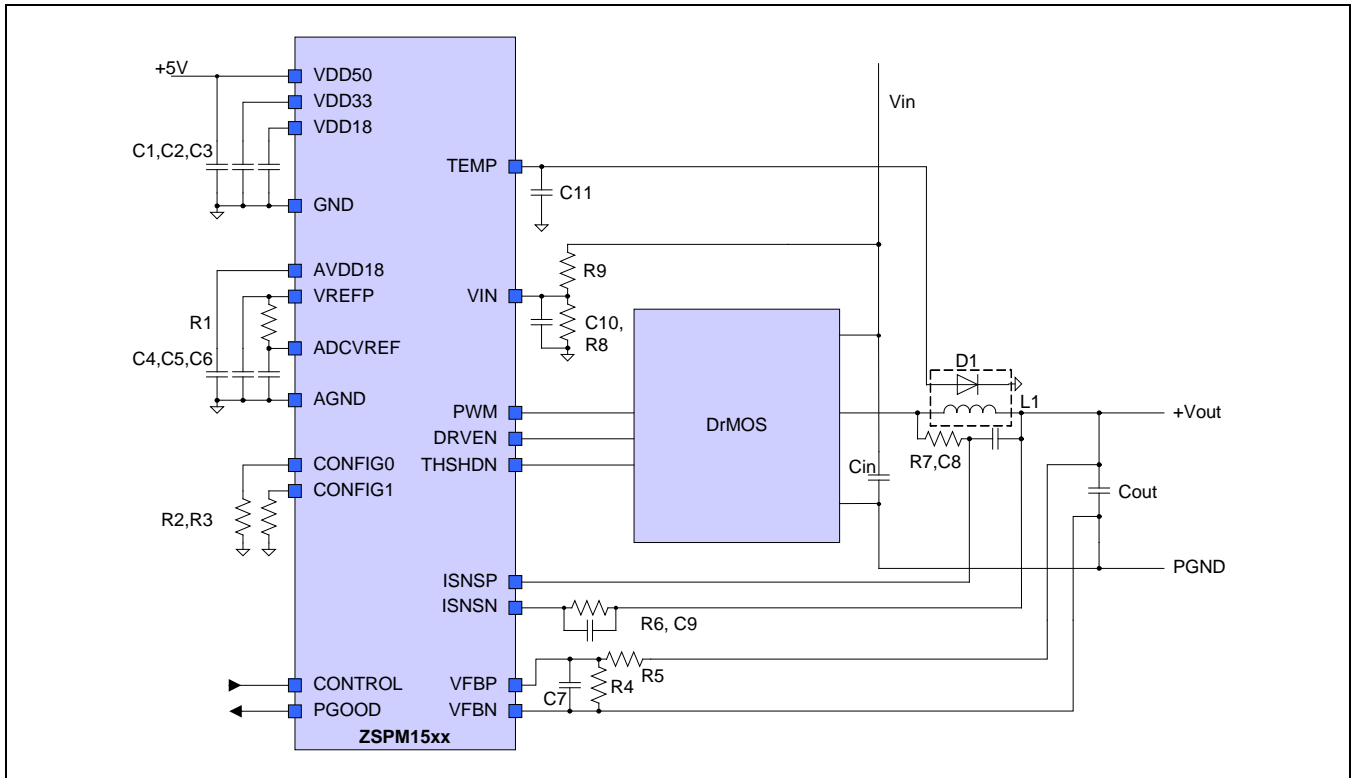
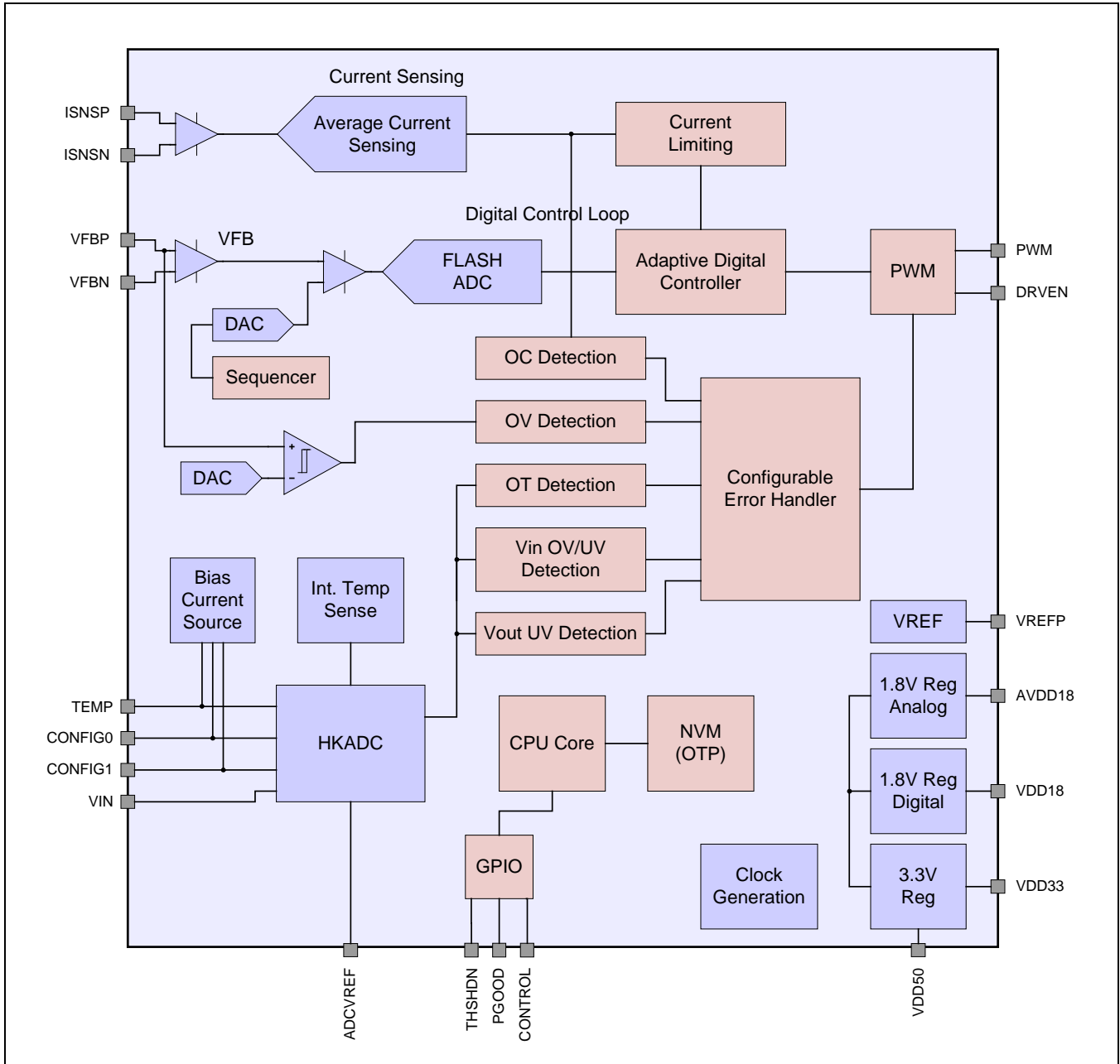

Figure 2.2 Block Diagram



2.2. Pin Description

Table 2.1 ZSPM15xx Pin Descriptions

Pin	Name	Direction	Type	Description
1	AGND	Input	Supply	Analog Ground
2	VREFP	Output	Supply	Reference Terminal
3	VFBP	Input	Analog	Positive Input of Differential Feedback Voltage Sensing
4	VFBN	Input	Analog	Negative Input of Differential Feedback Voltage Sensing
5	ISNSP	Input	Analog	Positive Input of Differential Current Sensing
6	ISNSN	Input	Analog	Negative Input of Differential Current Sensing
7	TEMP	Input	Analog	Connection to External Temperature Sensing Element
8	VIN	Input	Analog	Power Supply Input Voltage Sensing
9	CONFIG0	Input	Analog	Configuration Selection 0
10	CONFIG1	Input	Analog	Configuration Selection 1
11	PWM	Output	Digital	High-side FET Control Signal
12	DRVEN	Output	Digital	Driver Enable Signal
13	PGOOD	Output	Digital	PGOOD Output (Internal Pull-Down)
14	CONTROL	Input	Digital	Control Input
15	THSHDN	Input	Digital	Thermal-Shut Down Input from Power Stage
16	N.C.			No connection – pin must be allowed to float
17	N.C.			No connection – pin must be allowed to float
18	N.C.			No connection – pin must be allowed to float
19	GND	Input	Supply	Digital Ground
20	VDD18	Output	Supply	Internal 1.8V Digital Supply Terminal
21	VDD33	Input/Output	Supply	3.3V Supply Voltage Terminal
22	VDD50	Input	Supply	5.0V Supply Voltage Terminal
23	AVDD18	Output	Supply	Internal 1.8V Analog Supply Terminal
24	ADCVREF	Input	Analog	Analog-to-Digital Converter (ADC) Reference Terminal
PAD	PAD	Input	Supply	Exposed PAD, Digital Ground

2.3. Available Packages

The ZSPM15xx is available in a 24-pin QFN package. The pin-out is shown in Figure 2.3. The mechanical drawing of the package can be found in Figure 6.1.

Figure 2.3 Pin-out QFN24 Package

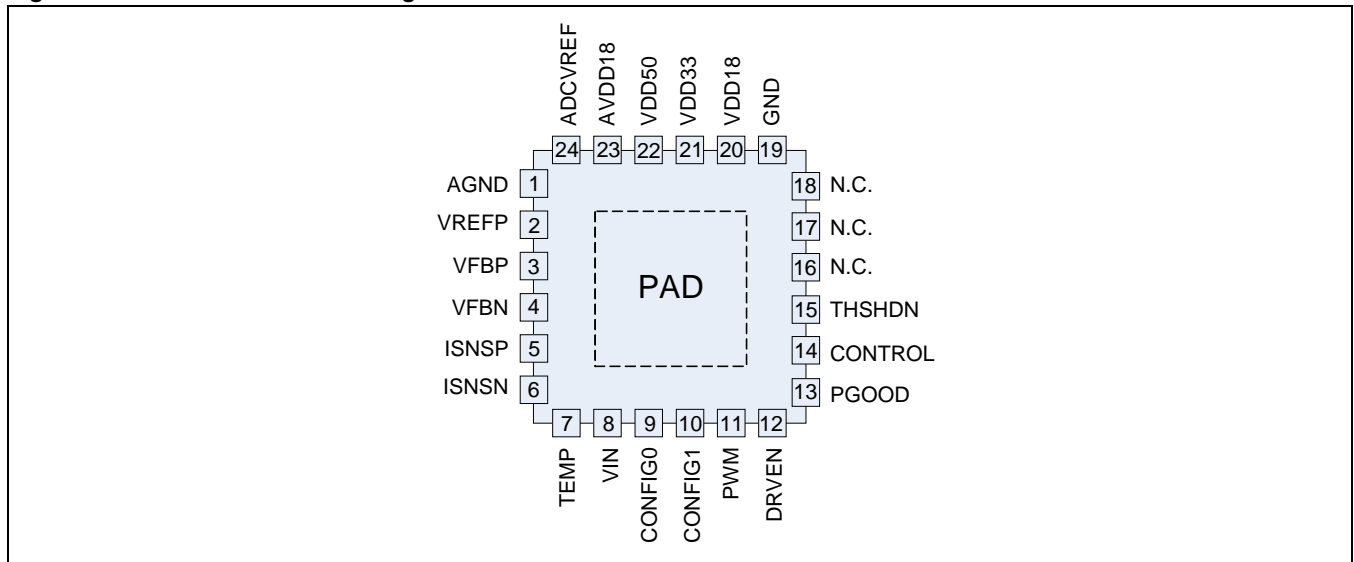

3 Functional Description

3.1. Power Supply Circuitry, Reference Decoupling, and Grounding

The ZSPM15xx incorporates several internal power regulators in order to derive all required supply and bias voltages from a single external supply voltage of 5.0V. Decoupling capacitors are required at the VDD33, VDD18, and AVDD18 pins (1.0 μ F minimum; 4.7 μ F recommended).

The reference voltages required for operation are generated within the ZSPM15xx. External decoupling must be provided between the VREFP and ADCVREF pins. Therefore, a 4.7 μ F capacitor is required at the VREFP pin and a 100nF capacitor at ADCVREF pin. The two pins should be connected with approximately 50 Ω resistance in order to provide sufficient decoupling between the pins.

Three different ground connections are available on the outside of the package. These should be connected together to a single ground tie. A differentiation between analog and digital ground is not required.

3.2. Reset/Start-up Behavior

The ZSPM15xx employs an internal power-on-reset (POR) circuit to ensure proper start-up and shut-down with a changing supply voltage. Once the supply voltage increases above the POR threshold voltage (see section 1.3), the ZSPM15xx begins the internal start-up process. Upon its completion, the device is ready for operation.

3.3. Digital Power Control

3.3.1. Overview

The digital power control loop consists of the integral parts required for the control functionality of the ZSPM15xx. A high-speed analog front-end is used to digitize the output voltage. A digital control core uses the acquired information to provide duty-cycle information to the PWM, which controls the drive signals to the power stage.

See section 7 for the pre-configured nominal output voltages for the different part codes available in the ZSPM15xx family.

3.3.2. Output Voltage Feedback

The voltage feedback signal is sampled with a high-speed analog front-end. The feedback voltage is differentially measured and subtracted from an internal voltage reference using an error amplifier. A flash ADC is then used to convert the voltage into its digital equivalent. This is followed by internal digital filtering to improve the system's noise rejection.

For some applications, an external feedback divider (R4 and R5; see Figure 4.1) is required to allow for output voltage operations above the internal reference voltage. For details, refer to the application section 4.3.

3.3.3. Digital Compensator

The sampled output voltage is processed by a digital control loop in order to modulate the DPWM output signals controlling the power stage. This digital control loop works as a voltage-mode controller using a PID-type compensation. The basic structure of the controller is shown in Figure 3.1. The proprietary State-Law™ Control (SLC) concept features two parallel compensators for steady-state operation and fast transient operation. This allows tuning the compensators individually for the respective needs; i.e., quiet steady state and fast transient performance. The ZSPM15xx implements fast, reliable switching between the different compensation modes in order to ensure good transient performance and a quiet steady state.

Figure 3.1 Simplified Block Diagram of the Digital Compensation

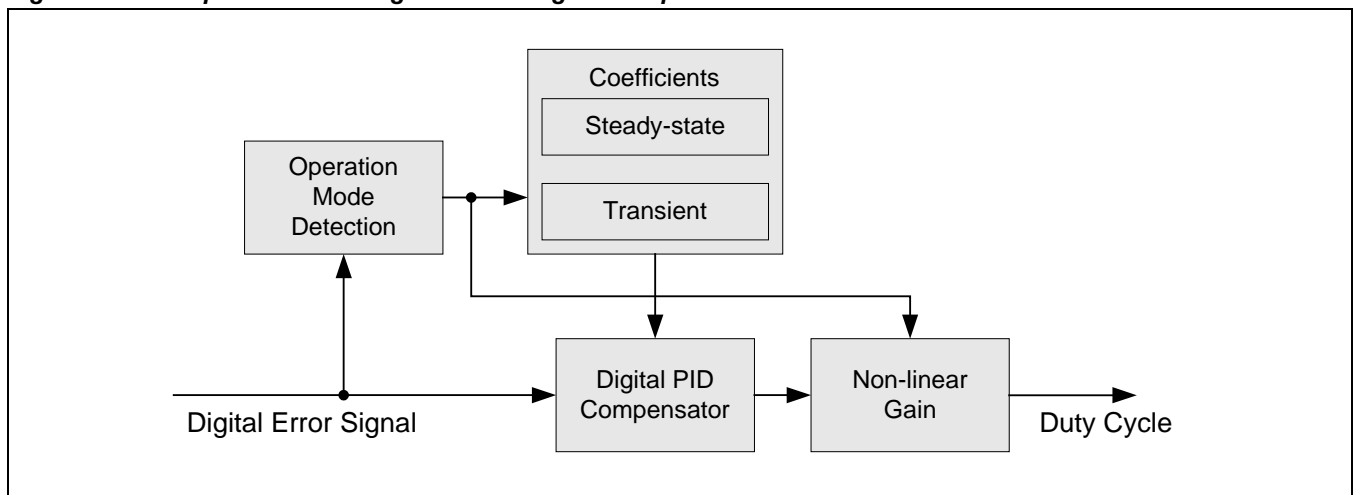

Two techniques are used to improve transient performance further:

- Tru-sample Technology™ is used to acquire fast, accurate, and continuous information about the output voltage so that the device can react quickly to any change in output voltage. Tru-sample Technology™ reduces phase-lag caused by sampling delays, reduces noise sensitivity, and improves transient performance.
- A nonlinear gain adjustment is used during large load transients to boost the loop gain and reduce the settling time.

The control loops in the ZSPM15xx are preconfigured and can be selected using a pin-strapping option. A range of different output capacitors is supported. Refer to section 4.8 for detailed information.

3.3.4. Power Sequencing and the CONTROL Pin

The ZSPM15xx has a set of pre-configured power-sequencing features. The typical sequence of events is shown in Figure 3.2. The individual values for the delay (t_{ON_DELAY} and t_{OFF_DELAY}), ramp time (t_{ON_RISE} and t_{OFF_FALL}) and time-outs (t_{ON_MAX} and t_{OFF_MAX}) are listed in section 1.3. Note that the device is slow-rate controlled for t_{ON_RISE} ramping via the pin-strapping options. The slew rate can be selected in the application circuit using the pin-strap options as explained in section 4.8.

The CONTROL pin is pre-configured for active high operation.

The ZSPM15xx features a power good (PGOOD) output, which can be used to indicate the state of the power rail. If the output voltage level is above the power good ON threshold, the pin is set to active, indicating a stable output voltage on the rail.

Figure 3.2 Power Sequencing

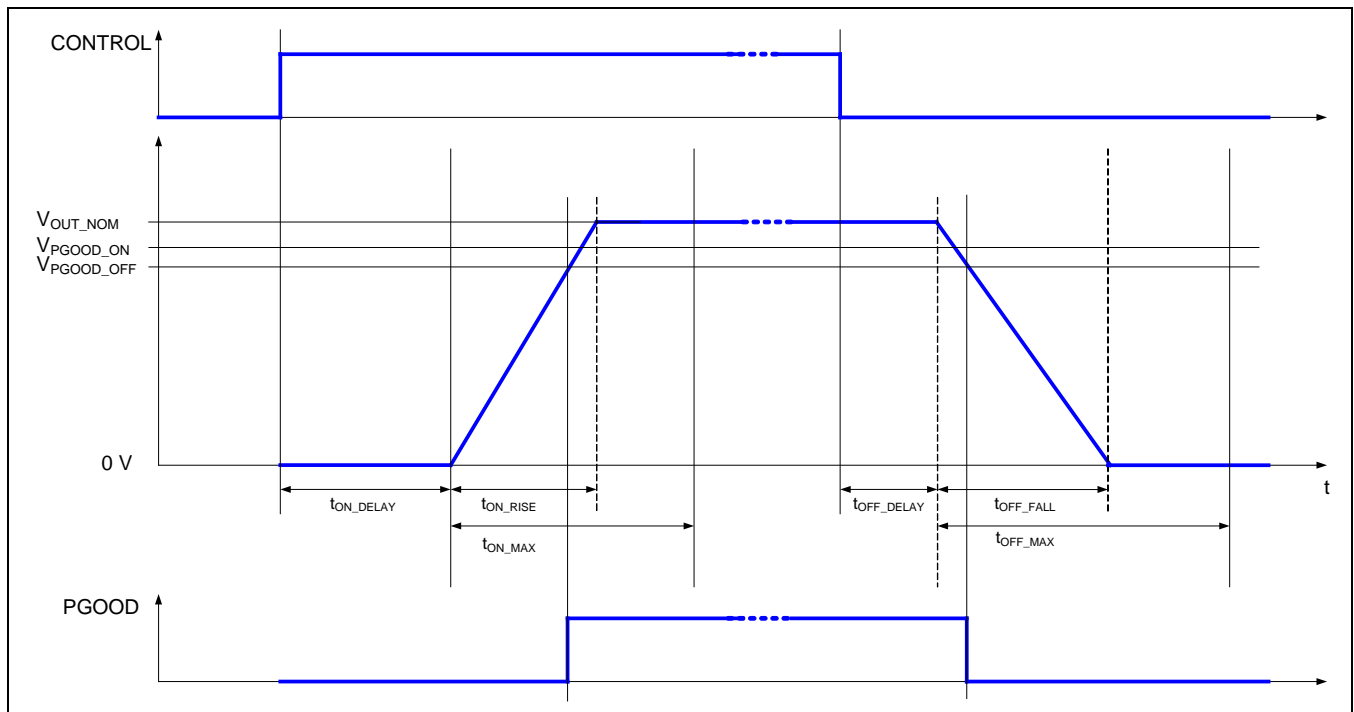

3.4. Fault Monitoring and Response Generation

The ZSPM15xx monitors various signals during operation and compares them with fault thresholds (see the “Threshold” column in Table 3.1). If a parameter exceeds a fault threshold, the respective fault signal is asserted and the ZSPM15xx will disable the output voltage as described below. Note that the ZSPM15xx features internal blanking times for voltage and temperature faults in order to improve noise-immunity.

Three different response types are supported by the ZSPM15xx. The “low-impedance” response turns off the top MOSFET and enables the low-side MOSFET; i.e., PWM=0. After t_{OFF_MAX} , both MOSFETs will be turned off, PWM=Z, DRVEN=0. A “high-impedance” response will disable both MOSFETs instantaneously, PWM=Z. A “soft-off” response ramps the output voltage down, similar to a power-down operation via the CONTROL pin. After t_{OFF_MAX} , the controller will disable the power stage by turning both switches off, PWM=Z, DRVEN=0. The ZSPM15xx features a “hiccup mode,” which allows it to re-enable its output voltage after the fault condition has been removed.

Table 3.1 Fault Configuration Overview

Fault	Response Type	Blanking	Threshold
Output Over-Voltage	Low-impedance	25 μ s	Preconfigured; see section 1.4.
Output Under-Voltage	High-impedance	450 μ s	Preconfigured; see section 1.4.
Input Over-Voltage	High-impedance	450 μ s	Preconfigured; see section 1.4.
Input Under-Voltage	High-impedance	450 μ s	Preconfigured; see section 1.4.
Over-Current	Low-impedance	None	Pin-strap selectable; see section 4.7.
Internal Over-Temperature	Soft-off	5ms	See specification in section 1.3.
External Over-Temperature	Soft-off	5ms	See specification in section 1.3.

3.4.1. Output Over/Under-Voltage

To prevent damage to the load, the ZSPM15xx utilizes an output over-voltage protection circuit. The voltage at VFBP is continuously compared with a preconfigured threshold using a high-speed analog comparator. If the voltage exceeds the configured threshold, the fault response is generated.

The ZSPM15xx also monitors the output voltage with a lower threshold. If the output voltage falls below the under-voltage fault level, a fault event is generated.

See section 1.4 for the device-specific threshold levels.

3.4.2. Output Current Protection

The ZSPM15xx offers cycle-by-cycle average current sensing with configurable over-current protection. A dedicated ADC is used to provide fast and accurate current information over the switching period. The acquired information is compared with a selectable over-current threshold to detect faults. DCR current sensing across the inductor is supported. Additionally, the device uses DCR temperature compensation via the external temperature sense element. This increases the accuracy of the current sense method by counteracting the significant change of the DCR over temperature.

The ZSPM15xx continuously monitors the average inductor current and utilizes this information to protect the power supply against excessive output current. If the average inductor current exceeds the selected over-current fault threshold, the fault response will be generated. See section 4.7 for instructions for configuring the threshold.

3.4.3. Input Voltage Protection

The ZSPM15xx continuously monitors the input voltage via the VIN pin. If the input voltage is outside an operation range defined by a lower and higher input voltage threshold, a fault is detected and a response generated. See section 1.4 for device-specific specifications for the thresholds.

3.4.4. Over-Temperature Protection

The ZSPM15xx features two independent temperature measurement units for internal and external temperature measurement. The internal temperature sensing measures the temperatures inside the ZSPM15xx. Place the external temperature sense element close to the inductor to measure its temperature. Use a PN-junction as the external temperature sense element. Small-signal transistors, such the 3904, are widely used for this application.

The ZSPM15xx monitors these internal and external temperature measurements. If either of the temperatures exceeds the over-temperature threshold (see section 1.3), the fault response will be generated. For additional information on the external temperature sensing, refer to section 4.6.

4 Application Information

4.1. Application Schematic

Figure 4.1 ZSPM15xx – Application Circuit with a 5V Supply Voltage

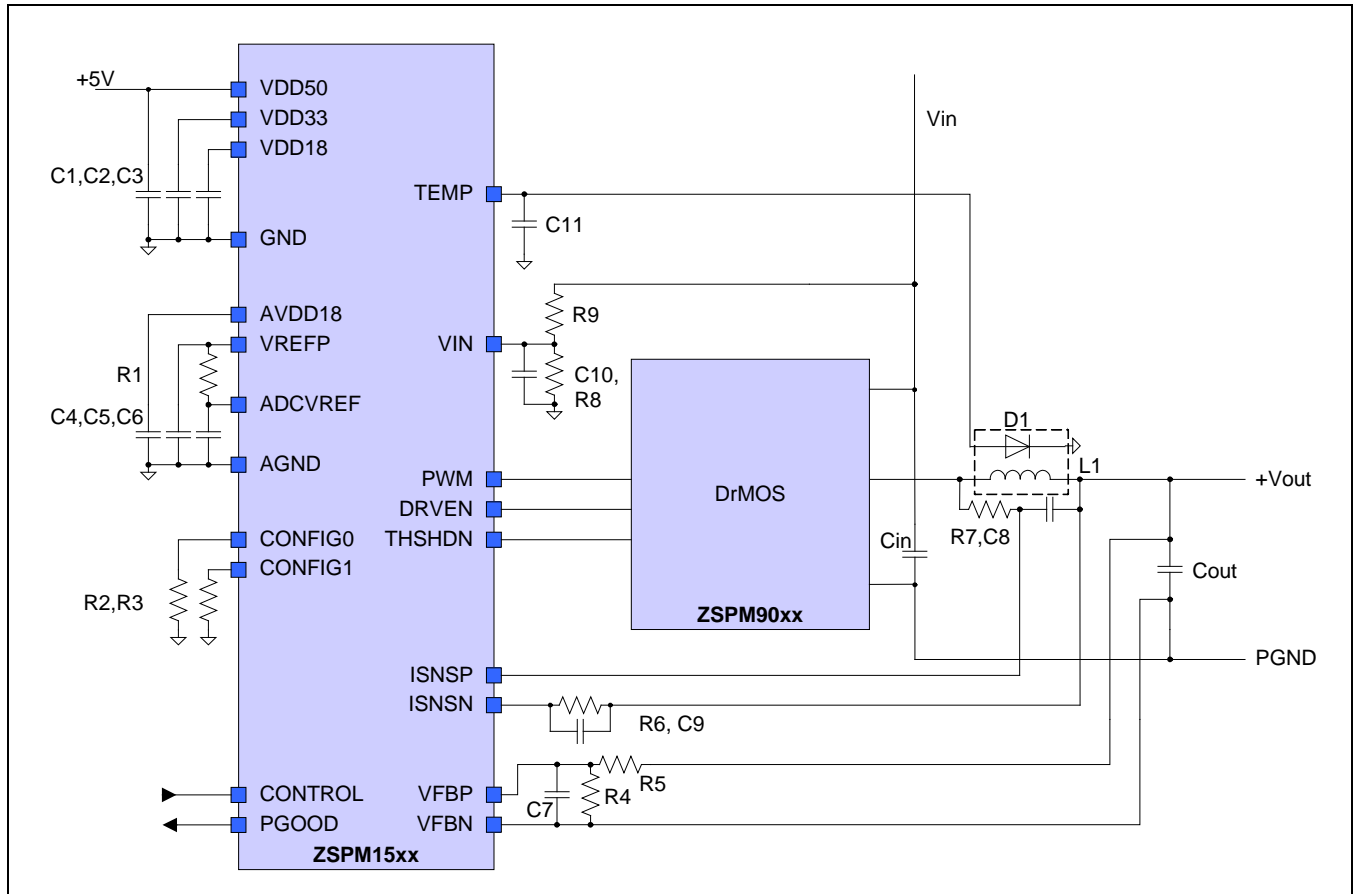

Table 4.1 *Passive Component Values for the Application Circuits*

Reference Designator	Component Value	Description
C1	1.0 μ F	Ceramic capacitor.
C2	4.7 μ F	Ceramic capacitor. Recommended: 4.7 μ F; minimum: 1.0 μ F.
C3	4.7 μ F	Ceramic capacitor. Recommended: 4.7 μ F; minimum: 1.0 μ F.
C4	4.7 μ F	Ceramic capacitor. Recommended: 4.7 μ F; minimum: 1.0 μ F.
C5	4.7 μ F*	Ceramic capacitor.
C6	100nF*	Ceramic capacitor.
C7	22pF	Output voltage sense filtering capacitor. Recommended: 22pF; maximum: 1nF.
C8, C9	**	DCR current-sense filter capacitor.
C10	100nF	Filter capacitor for input voltage – optional.
C11	100nF	Filter capacitor for external temperature – optional.
L1	**	Inductor.
Cin		Input filter capacitors. Can be a combination of ceramic and electrolytic capacitors.
Cout		Output filter capacitors. See section 4.8 for more information on the output capacitor selection.
R1	51 Ω *	Resistor.
R2, R3		Pin-strap configuration resistors. See sections 4.7 and 4.8.
R4	**	Output voltage feedback divider bottom resistor. Connect between the VFBN and VFBN pins. Important: Refer to section 1.4 to determine if R4 should be placed or not depending on the specific ZSPM15xx product code.
R5	**	Output voltage feedback divider top resistor. Connect between the output terminal and the VFBN pin.
R6, R7	**	DCR current-sense filter resistors.
R8	1.0k Ω *	Input voltage divider bottom resistor. Connect between the VIN and AGND pins of the ZSPM15xx.
R9	9.1k Ω *	Input voltage divider top resistor. Connect between the main power input and the VIN pin of the ZSPM15xx.
D1	3904	External temperature sense element (PN-junction). See section 4.6.
<p>* Fixed component values marked with an asterisk (*) must not be changed. ** Refer to section 4.2 for components marked with a double asterisk (**).</p>		

4.2. Device-Specific Passive Components

Each product in the ZSPM15xx family requires external device-specific passive components. These are listed in the following tables.

If specified in the following tables, the feedback divider (R4, R5) is mandatory to achieve the specified output voltage. The control loop has been optimized for the inductance specified, but inductors from different vendors can be used.

Note: The ZSPM15xx has been optimized for the specific Würth inductors recommended in the following tables depending on the ZSPM15xx product number. If a different inductor is used, its specifications should be comparable to the recommended Würth inductor; otherwise the full optimization provided by the ZSPM15xx might not be achieved. If a different inductor is used, the current sense components (R6, R7, C8) must be recalculated according to section 4.4.

Components specified as DNP must not be placed.

Table 4.2 *Passive Components for the ZSPM1501, ZSPM1502, and ZSPM1503*

Reference Designator	Component Value	Description
Feedback divider		
R4	DNP	Output voltage feedback divider bottom resistor. Important: Do not place R4 for the ZSPM1501, ZSPM1502, and ZSPM1503.
R5	1.0k Ω	Output voltage feedback divider top resistor. Connect between the output terminal and the VFBP pin.
Inductor and current sensing		
L1	L=330nH	Recommended inductor: Würth WE-HCM 744301033.
R6, R7	1050 Ω	DCR current-sense filter resistors.
C8, C9	1000nF	DCR current-sense filter capacitor.

Table 4.3 *Passive Components for the ZSPM1504, ZSPM1505, and ZSPM1506*

Reference Designator	Component Value	Description
Feedback divider		
R4	1k Ω	Output voltage feedback divider bottom resistor.
R5	750 Ω	Output voltage feedback divider top resistor. Connect between the output terminal and the VFBP pin.
Inductor and current sensing		
L1	L=470nH	Recommended inductor: Würth WE-HCM 744301047.
R6, R7	1000 Ω	DCR current-sense filter resistors.
C8, C9	1000nF	DCR current-sense filter capacitor.

Table 4.4 *Passive Components for the ZSPM1507*

Reference Designator	Component Value	Description
Feedback divider		
R4	1k Ω	Output voltage feedback divider bottom resistor.
R5	1k Ω	Output voltage feedback divider top resistor. Connect between the output terminal and the VFBP pin.
Inductor and current sensing		
L1	L=1000nH	Recommended inductor: Würth WE-HCM 7443310100.
R6, R7	1.05k Ω	DCR current-sense filter resistors.
C8, C9	820nF	DCR current-sense filter capacitor.

Table 4.5 *Passive Components for the ZSPM1508 and ZSPM1509*

Reference Designator	Component Value	Description
Feedback divider		
R4	1k Ω	Output voltage feedback divider bottom resistor.
R5	3.3k Ω	Output voltage feedback divider top resistor. Connect between the output terminal and the VFBP pin.
Inductor and current sensing		
L1	L=2.2 μ H	Recommended inductor: Würth WE-HCC 7443310220.
R6, R7	1180 Ω	DCR current-sense filter resistors.
C8, C9	470nF	DCR current-sense filter capacitor.

Table 4.6 *Passive Components for the ZSPM1511, ZSPM1512, and ZSPM1513*

Reference Designator	Component Value	Description
Feedback divider		
R4	DNP	Output voltage feedback divider bottom resistor. Important: Do not place R4 for the ZSPM1511, ZSPM1512, and ZSPM1513.
R5	1.0k Ω	Output voltage feedback divider top resistor. Connect between the output terminal and the VFBP pin.
Inductor and current sensing		
L1	L= 680nH	Recommended inductor: Würth WE-HCC 7443310068
R6, R7	1.0k Ω	DCR current-sense filter resistors.
C8, C9	1.0 μ F	DCR current-sense filter capacitor.

4.3. Output Voltage Feedback Components

The ZSPM15xx supports output voltage feedback via a resistive feedback divider. However, adding a high-frequency low-pass filter in the sense path is highly recommended to remove high-frequency disturbances from the sense signals. Placing these components as close as possible to the ZSPM15xx is recommended. For larger output voltages, a feedback divider is required. Using resistors with small tolerances is recommended to guarantee good output voltage accuracy.

Important: The feedback divider components specified in section 1.4 are mandatory if they are specified for the specific ZSPM15xx product. Components specified as DNP in section 1.4 must not be placed.

Figure 4.2 Output Voltage Sense Circuitry

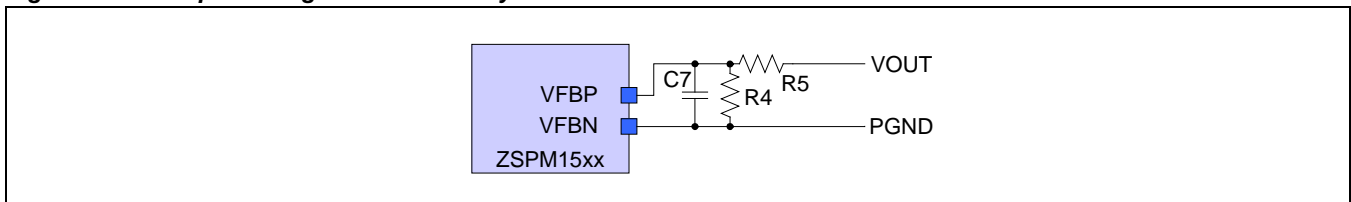

4.4. DCR Current Sensing Components

Figure 4.3 Inductor Current Sensing Using the DCR Method

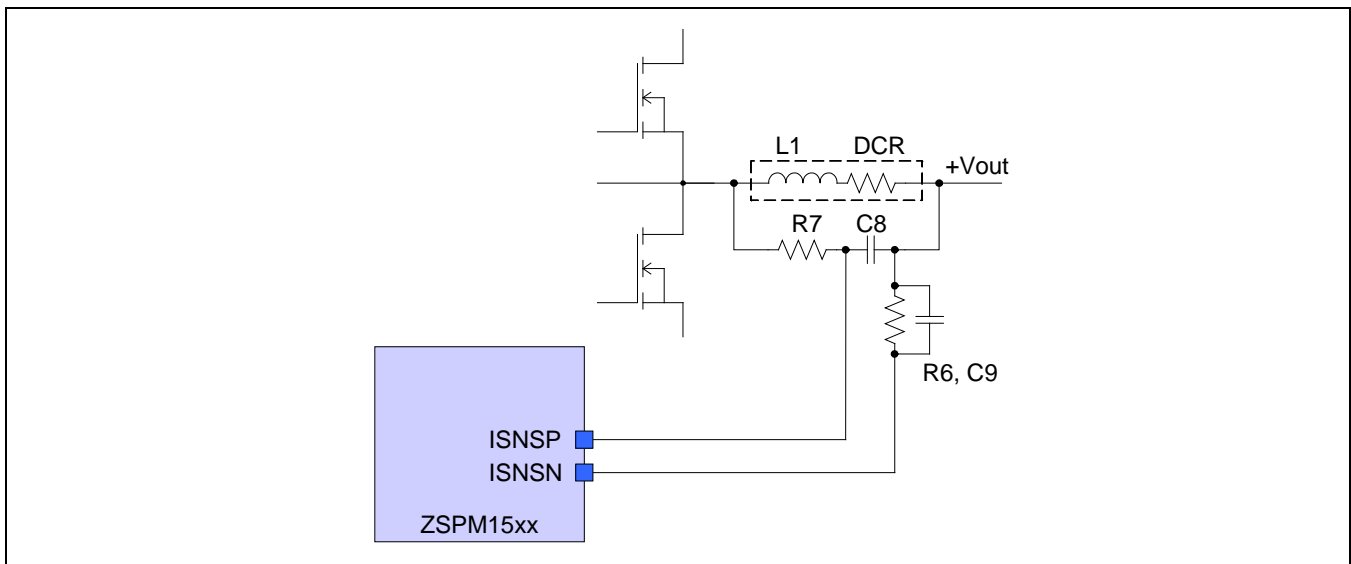

The ZSPM15xx supports the loss-less DCR current sense method. The equivalent DC resistance (DCR) of the inductor is used to measure the inductor current without adding any additional components in the power path. The technique is based on matching the time constants of the inductor and the parallel low-pass filter. Therefore the components (R6 and R7) and (C8 and C9) must be selected depending on the selected inductor.

For design guidance using one of the preselected power stages, refer to section 4.2.

Otherwise, the following procedure is recommended:

- 1.) Set $R7' = 1k\Omega$
- 2.) Calculate $C8' = L / (DCR * R7')$.
- 3.) Select capacitor $C8 = C9$ from the appropriate E-series close to $C8$.
- 4.) Recalculate $R6 = R7 = L / (DCR * C8)$ based on the capacitor selected for $C8$.

4.5. Input Voltage Sensing

The ZSPM15xx supports input voltage sensing for input voltage protection. Therefore a voltage divider between the input voltage and the VIN pin is required. An optional capacitor C10 can be connected to the VIN pin to help improve noise immunity. See Table 4.1 for the recommended values for R8, R9, and C10.

Figure 4.4 Input Voltage Sense Circuitry

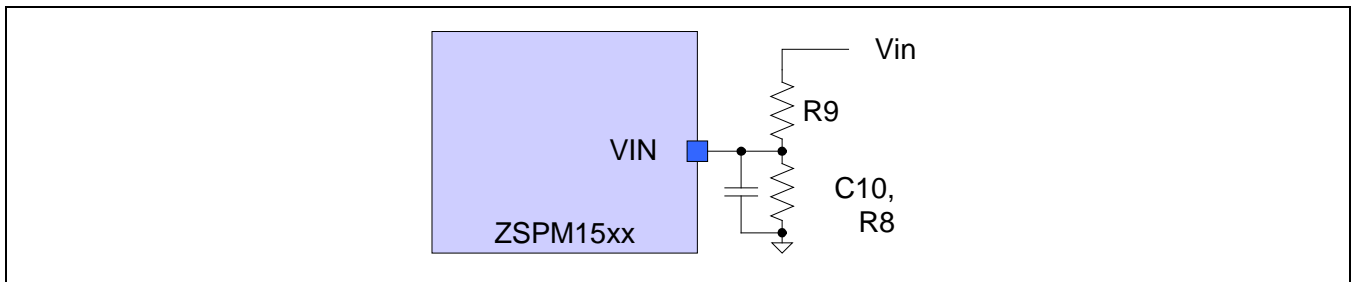

4.6. External Temperature Sensing

The ZSPM15xx features external temperature sensing via a PN-junction. Typically, a small signal transistor, such as the 3904, is used for this purpose. The sense elements should be placed thermally close to the inductor to allow accurate temperature measurement. For information about the required device parameters, refer to the electrical specification in section 1.3. An additional capacitor (C11, 100nF) can be used to improve noise performance.

Figure 4.5 External Temperature Sense Circuitry

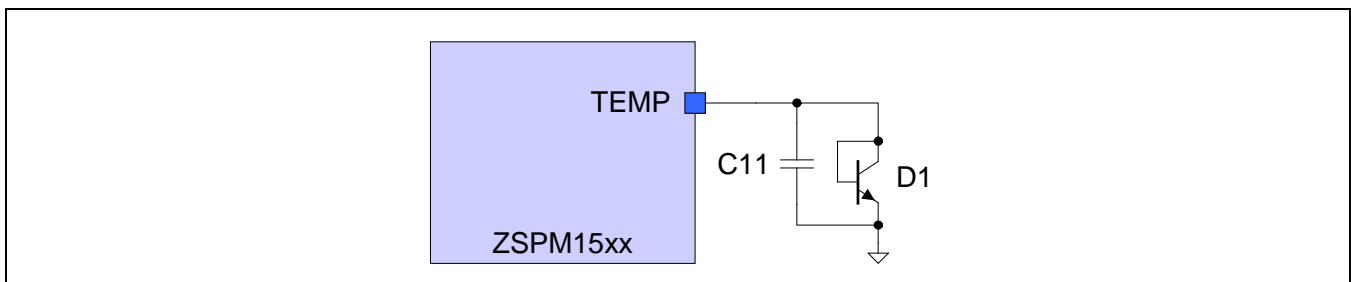

4.7. CONFIG0 – Over-Current Protection Threshold

The ZSPM15xx can be configured to support a wide range of different over-current protection (OCP) thresholds based on the user's selection for the inductor. The over-current threshold voltage between the ISNSP and ISNSN pins can be configured by using a pull-down resistor (R2) on the CONFIG0 pin. This voltage represents the over-current threshold because faults are detected by measuring the voltage across the DCR of the selected inductor. The different configuration options are listed in Table 4.7.

Table 4.7 ZSPM15xx – OCP Pin Strap Resistor Selection

Index	Resistor Value Using the E96 Series	OCP Voltage Selection at 25°C	Index	Resistor Value Using the E96 Series	OCP Voltage Selection at 25°C
0	0Ω	3.0mV	15	5.360kΩ	20.0mV
1	392Ω	4.0mV	16	6.040kΩ	22.5mV
2	576Ω	5.0mV	17	6.810kΩ	25.0mV
3	787Ω	6.0mV	18	7.680kΩ	27.5mV
4	1.000kΩ	7.0mV	19	8.660kΩ	30.0mV
5	1.240kΩ	8.0mV	20	9.530kΩ	32.5mV
6	1.500kΩ	9.0mV	21	10.50kΩ	35.0mV
7	1.780kΩ	10.0mV	22	11.80kΩ	37.5mV
8	2.100kΩ	11.25mV	23	13.00kΩ	40.0mV
9	2.430kΩ	12.5mV	24	14.30kΩ	45.0mV
10	2.800kΩ	13.75mV	25	15.80kΩ	50.0mV
11	3.240kΩ	15.0mV	26	17.40kΩ	55.0mV
12	3.740kΩ	16.25mV	27	19.10kΩ	60.0mV
13	4.220kΩ	17.5mV	28	21.00kΩ	65.0mV
14	4.750kΩ	18.75mV	29	23.20kΩ	70.0mV

Note that due to the temperature compensation feature, the ZSPM15xx over-current threshold should be based on the current sense signal at 25°C. Temperature drift is automatically compensated within the device.

Recommendation: For the selection of the over-current threshold voltage, include the tolerance of the inductor's DCR and take the parasitic effects of the circuit board layout into account.

4.8. CONFIG1 – Compensation Loop and Output Voltage Slew Rate

The ZSPM15xx controllers can be configured to operate over a wide range of output capacitance. Four ranges of output capacitance have been specified to match typical customer requirements (see Table 4.8). For each output capacitance range, an optimized compensation loop can be selected. The appropriate compensator should be selected based on the application requirements.

Typical performance measurements for both load transient performance and open-loop Bode plots can be found in section 5.

Note: Using less output capacitance than the minimum capacitance given in Table 4.8 is not recommended.

Table 4.8 Recommended Output Capacitor Ranges

Capacitor Range	Ceramic Capacitor	Bulk Electrolytic Capacitors	Suitable Compensator
#1	Minimum 200 μ F Maximum 500 μ F	None	Comp0
#2	Minimum 500 μ F Maximum 1000 μ F	None	Comp1
#3	Minimum 200 μ F Maximum 500 μ F	Minimum 2 x 470 μ F, 7m Ω ESR Maximum 4 x 470 μ F, 7m Ω ESR	Comp2
#4	Minimum 500 μ F Maximum 1000 μ F	Minimum 4 x 470 μ F, 7m Ω ESR Maximum 6 x 470 μ F, 7m Ω ESR	Comp3

To achieve the optimal performance for a given output capacitor range, one of four sets of compensation loop parameters, Comp0 to Comp3, should be selected with a resistor between the CONFIG1 and GND pins. The compensation loop parameters have been configured to ensure optimal transient performance and good control loop stability margins.

For each set of compensation loop parameters, there is a choice of seven slew rates for the output voltage during power-up. The selection of the slew rate can be used to limit the input current of the DC/DC converter while it is ramping up the output voltage. The current needed to charge the output capacitors increases in direct proportion to the slew rate.

Table 4.9 gives a complete list of the selectable compensation loop parameters and slew rates together with the equivalent pin-strap resistor values (R3) for the ZSPM1501 to ZSPM1506 and the ZSPM1511 to ZSPM1513. Table 4.10, Table 4.11, and Table 4.12 provide the values and settings for the ZSPM1507, ZSPM1508, and ZSPM1509 respectively.

Table 4.9 Compensator and VOUT Slew Rate Pin Strap Resistor Selection for the ZSPM1501 to ZSPM1506 and the ZSPM1511 to ZSPM1513

Index	Resistor Value Using the E96 Series	Compensator	Vout Slew Rate	Index	Resistor Value Using the E96 Series	Compensator	Vout Slew Rate
0	0Ω	Comp0 (Capacitor Range #1)	2.700 V/ms	14	4.750kΩ	Comp2 (Capacitor Range #3)	2.700 V/ms
1	392Ω		1.350 V/ms	15	5.360kΩ		1.350 V/ms
2	576Ω		0.675 V/ms	16	6.040kΩ		0.675 V/ms
3	787Ω		0.300 V/ms	17	6.810kΩ		0.300 V/ms
4	1.000kΩ		0.200 V/ms	18	7.680kΩ		0.200 V/ms
5	1.240kΩ		0.150 V/ms	19	8.660kΩ		0.150 V/ms
6	1.500kΩ		0.100 V/ms	20	9.530kΩ		0.100 V/ms
7	1.780kΩ	Comp1 (Capacitor Range #2)	2.700 V/ms	21	10.50kΩ	Comp3 (Capacitor Range #4)	2.700 V/ms
8	2.100kΩ		1.350 V/ms	22	11.80kΩ		1.350 V/ms
9	2.430kΩ		0.675 V/ms	23	13.00kΩ		0.675 V/ms
10	2.800kΩ		0.300 V/ms	24	14.30kΩ		0.300 V/ms
11	3.240kΩ		0.200 V/ms	25	15.80kΩ		0.200 V/ms
12	3.740kΩ		0.150 V/ms	26	17.40kΩ		0.150 V/ms
13	4.220kΩ		0.100 V/ms	27	19.10kΩ		0.100 V/ms

Table 4.10 Compensator and VOUT Slew Rate Pin Strap Resistor Selection for the ZSPM1507

Index	Resistor Value Using the E96 Series	Compensator	Vout Slew Rate	Index	Resistor Value Using the E96 Series	Compensator	Vout Slew Rate
0	0Ω	Comp0 (Capacitor Range #1)	6.756 V/ms	14	4.750kΩ	Comp2 (Capacitor Range #3)	6.756 V/ms
1	392Ω		3.378 V/ms	15	5.360kΩ		3.378 V/ms
2	576Ω		1.689 V/ms	16	6.040kΩ		1.689 V/ms
3	787Ω		0.750 V/ms	17	6.810kΩ		0.750 V/ms
4	1.000kΩ		0.517 V/ms	18	7.680kΩ		0.517 V/ms
5	1.240kΩ		0.374 V/ms	19	8.660kΩ		0.374 V/ms
6	1.500kΩ		0.250 V/ms	20	9.530kΩ		0.250 V/ms
7	1.780kΩ	Comp1 (Capacitor Range #2)	6.756 V/ms	21	10.50kΩ	Comp3 (Capacitor Range #4)	6.756 V/ms
8	2.100kΩ		3.378 V/ms	22	11.80kΩ		3.378 V/ms
9	2.430kΩ		1.689 V/ms	23	13.00kΩ		1.689 V/ms
10	2.800kΩ		0.750 V/ms	24	14.30kΩ		0.750 V/ms
11	3.240kΩ		0.517 V/ms	25	15.80kΩ		0.517 V/ms
12	3.740kΩ		0.374 V/ms	26	17.40kΩ		0.374 V/ms
13	4.220kΩ		0.250 V/ms	27	19.10kΩ		0.250 V/ms

Table 4.11 Compensator and VOUT Slew Rate Pin Strap Resistor Selection for the ZSPM1508

Index	Resistor Value Using the E96 Series	Compensator	Vout Slew Rate	Index	Resistor Value Using the E96 Series	Compensator	Vout Slew Rate
0	0Ω	Comp0 (Capacitor Range #1)	2.896 V/ms	14	4.750kΩ	Comp2 (Capacitor Range #3)	2.896 V/ms
1	392Ω		1.659 V/ms	15	5.360kΩ		1.659 V/ms
2	576Ω		1.051 V/ms	16	6.040kΩ		1.051 V/ms
3	787Ω		0.827 V/ms	17	6.810kΩ		0.827 V/ms
4	1.000kΩ		0.643 V/ms	18	7.680kΩ		0.643 V/ms
5	1.240kΩ		0.428 V/ms	19	8.660kΩ		0.428 V/ms
6	1.500kΩ		0.330 V/ms	20	9.530kΩ		0.330 V/ms
7	1.780kΩ	Comp1 (Capacitor Range #2)	2.896 V/ms	21	10.50kΩ	Comp3 (Capacitor Range #4)	2.896 V/ms
8	2.100kΩ		1.659 V/ms	22	11.80kΩ		1.659 V/ms
9	2.430kΩ		1.051 V/ms	23	13.00kΩ		1.051 V/ms
10	2.800kΩ		0.827 V/ms	24	14.30kΩ		0.827 V/ms
11	3.240kΩ		0.643 V/ms	25	15.80kΩ		0.643 V/ms
12	3.740kΩ		0.428 V/ms	26	17.40kΩ		0.428 V/ms
13	4.220kΩ		0.330 V/ms	27	19.10kΩ		0.330 V/ms

Table 4.12 Compensator and VOUT Slew Rate Pin Strap Resistor Selection for the ZSPM1509

Index	Resistor Value Using the E96 Series	Compensator	Vout Slew Rate	Index	Resistor Value Using the E96 Series	Compensator	Vout Slew Rate
0	0Ω	Comp0 (Capacitor Range #1)	2.907 V/ms	14	4.750kΩ	Comp2 (Capacitor Range #3)	2.907 V/ms
1	392Ω		1.938 V/ms	15	5.360kΩ		1.938 V/ms
2	576Ω		1.656 V/ms	16	6.040kΩ		1.656 V/ms
3	787Ω		1.160 V/ms	17	6.810kΩ		1.160 V/ms
4	1.000kΩ		0.967 V/ms	18	7.680kΩ		0.967 V/ms
5	1.240kΩ		0.683 V/ms	19	8.660kΩ		0.683 V/ms
6	1.500kΩ		0.504 V/ms	20	9.530kΩ		0.504 V/ms
7	1.780kΩ	Comp1 (Capacitor Range #2)	2.907 V/ms	21	10.50kΩ	Comp3 (Capacitor Range #4)	2.907 V/ms
8	2.100kΩ		1.938 V/ms	22	11.80kΩ		1.938 V/ms
9	2.430kΩ		1.656 V/ms	23	13.00kΩ		1.656 V/ms
10	2.800kΩ		1.160 V/ms	24	14.30kΩ		1.160 V/ms
11	3.240kΩ		0.967 V/ms	25	15.80kΩ		0.967 V/ms
12	3.740kΩ		0.683 V/ms	26	17.40kΩ		0.683 V/ms
13	4.220kΩ		0.504 V/ms	27	19.10kΩ		0.504 V/ms

5 Typical Performance Data

This section gives typical performance data for the individual products in the ZSPM15xx family. The pre-programmed compensation loop parameters for the ZSPM15xx have been designed to ensure stability and optimal transient performance for the specified inductance in combination with one of the four output capacitor ranges (see Table 4.8).

The transient load steps have been generated with a load resistor and a power MOSFET located on the same circuit board as the ZSPM15xx and the recommended reference layout. The Evaluation Kit for the specific ZSPM15xx product can be used to further evaluate the performance of the ZSPM15xx for the four output capacitor ranges.

5.1. ZSPM1501 – Typical Load Transient Response – Capacitor Range #1 – Comp0

Test conditions: $V_{IN} = 12.0V$, $V_{OUT} = 0.85V$

Minimum output capacitance: $2 \times 100\mu F/6.3V \text{ X5R}$

Maximum output capacitance: $4 \times 100\mu F/6.3V \text{ X5R} + 2 \times 47\mu F/10V \text{ X7R}$

Figure 5.1 ZSPM1501 with Comp0; 5A to 15A Load Step; and Min. Capacitance

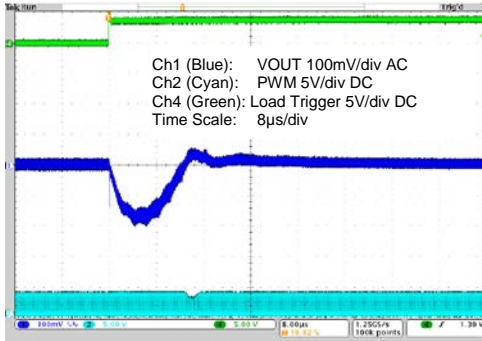

Figure 5.2 ZSPM1501 with Comp0; 15A to 5A Load Step; and Min. Capacitance

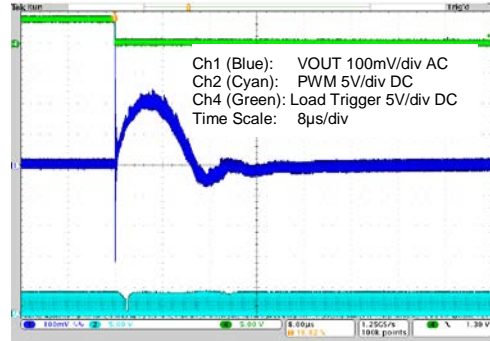

Figure 5.3 ZSPM1501 with Comp0; 5A to 15A Load Step; and Max. Capacitance

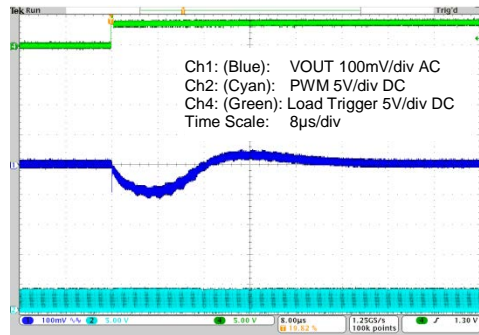

Figure 5.4 ZSPM1501 with Comp0; 15A to 5A Load Step; and Max. Capacitance

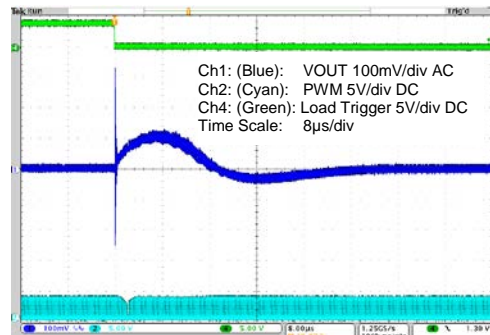
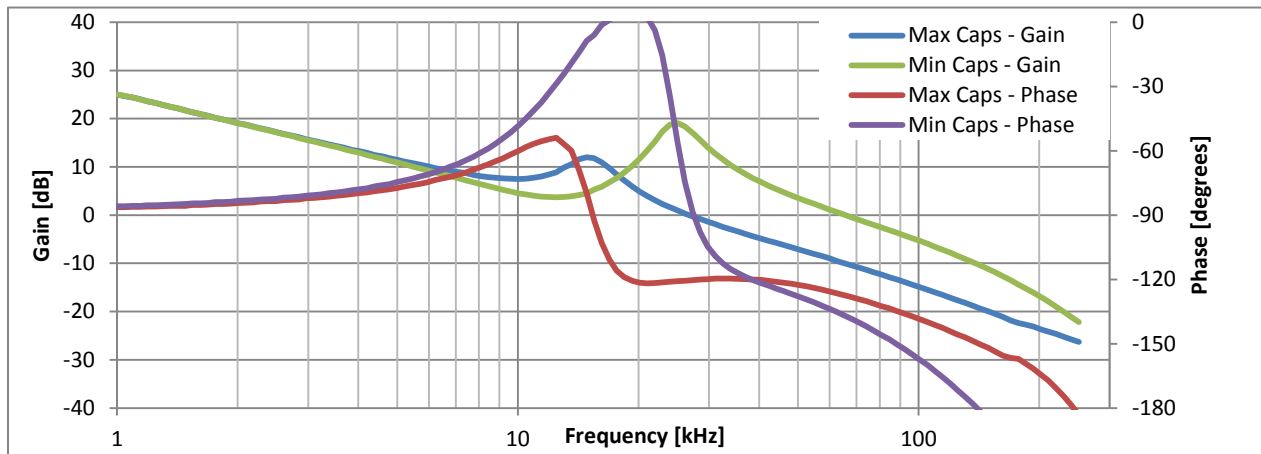

Figure 5.5 Open Loop Bode Plots for ZSPM1501 with Comp0



5.2. ZSPM1501 – Typical Load Transient Response – Capacitor Range #2 – Comp1

Test conditions: $V_{IN} = 12.0V$, $V_{OUT} = 0.85V$

Minimum output capacitance: $5 \times 100\mu F/6.3V \text{ X5R}$

Maximum output capacitance: $8 \times 100\mu F/6.3V \text{ X5R} + 4 \times 47\mu F/10V \text{ X7R}$

Figure 5.6 ZSPM1501 with Comp1; 5A to 15A Load Step; and Min. Capacitance

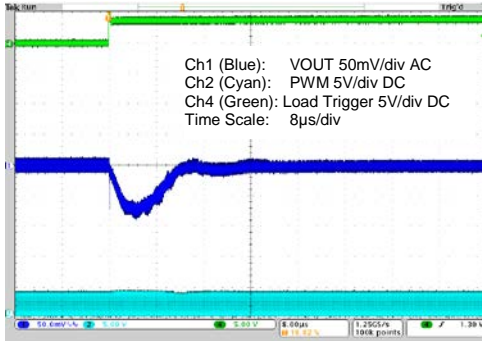

Figure 5.7 ZSPM1501 with Comp1; 15A to 5A Load Step; and Min. Capacitance

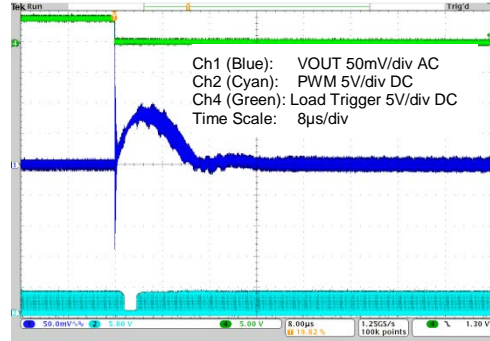

Figure 5.8 ZSPM1501 with Comp1; 5A to 15A Load Step; and Max. Capacitance

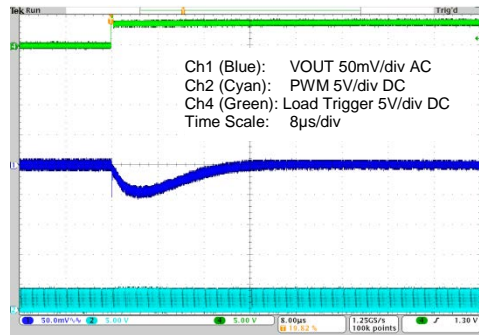

Figure 5.9 ZSPM1501 with Comp1; 15A to 5A Load Step; and Max. Capacitance

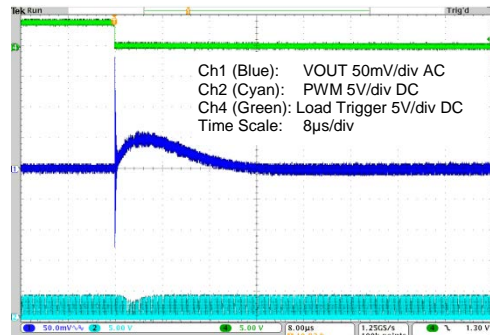
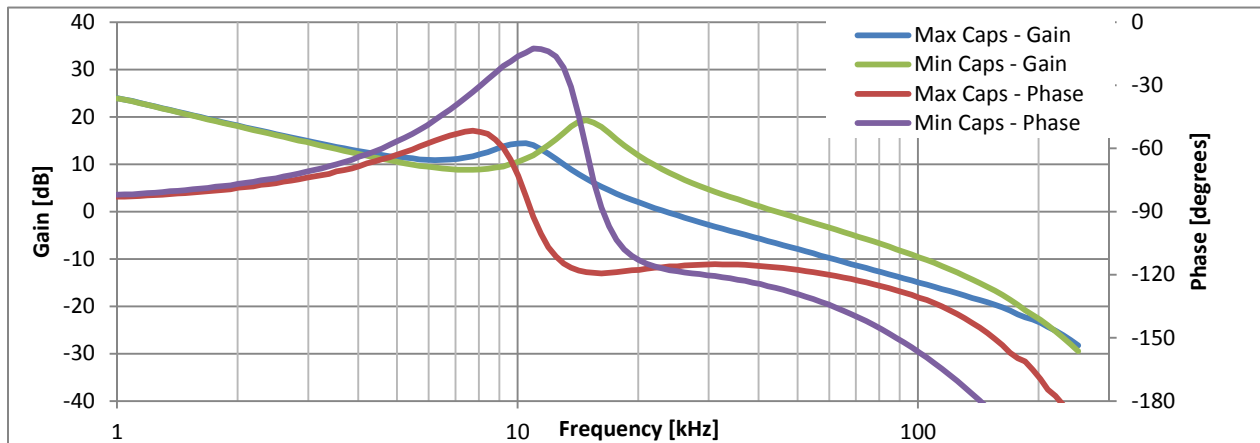

Figure 5.10 Open Loop Bode Plots for ZSPM1501 with Comp1



5.3. ZSPM1501 – Typical Load Transient Response – Capacitor Range #3 – Comp2

Test conditions: $V_{IN} = 12.0V$, $V_{OUT} = 0.85V$

Minimum output capacitance: $2 \times 100\mu F/6.3V \text{ X5R} + 2 \times 470\mu F/7m\Omega$

Maximum output capacitance: $4 \times 100\mu F/6.3V \text{ X5R} + 2 \times 47\mu F/10V \text{ X7R} + 4 \times 470\mu F/7m\Omega$

Figure 5.11 ZSPM1501 with Comp2; 5A to 15A Load Step; and Min. Capacitance

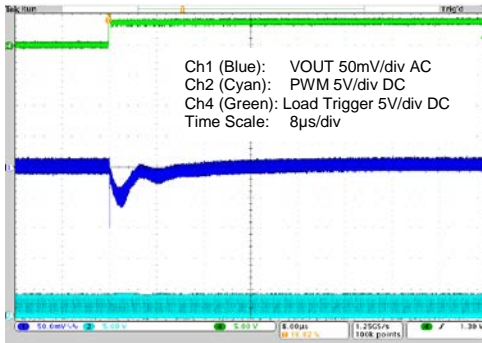

Figure 5.12 ZSPM1501 with Comp2; 15A to 5A Load Step; and Min. Capacitance

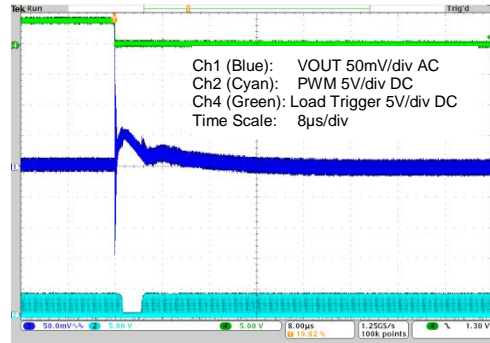

Figure 5.13 ZSPM1501 with Comp2; 5A to 15A Load Step; and Max. Capacitance

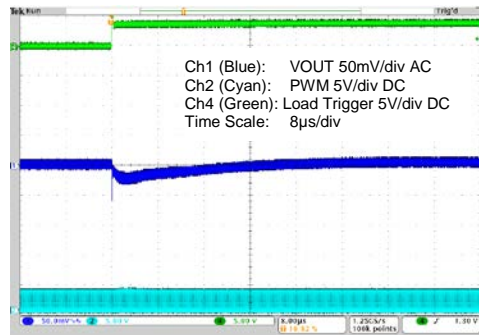

Figure 5.14 ZSPM1501 with Comp2; 15A to 5A Load Step; and Max. Capacitance

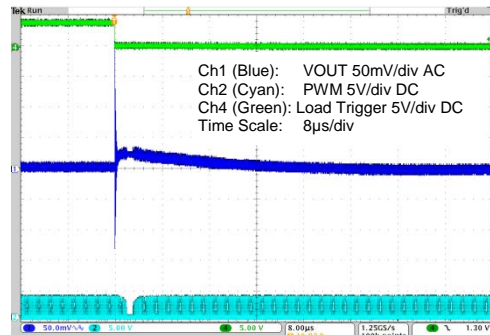
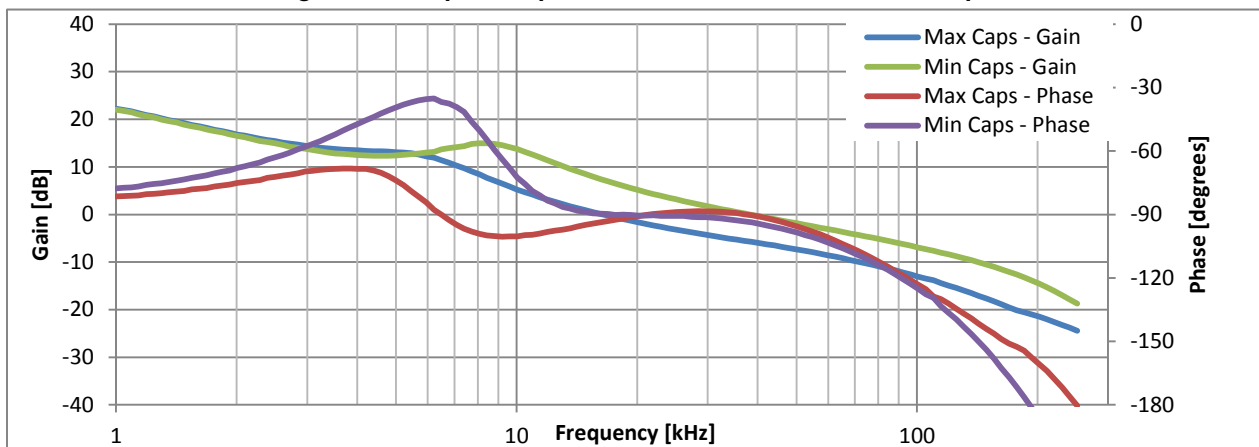

Figure 5.15 Open Loop Bode Plots for ZSPM1501 with Comp2



5.4. ZSPM1501 – Typical Load Transient Response – Capacitor Range #4 – Comp3

Test conditions: $V_{IN} = 12.0V$, $V_{OUT} = 0.85V$

Minimum output capacitance: $5 \times 100\mu F/6.3V \text{ X5R} + 4 \times 470\mu F/7m\Omega$

Maximum output capacitance: $8 \times 100\mu F/6.3V \text{ X5R} + 4 \times 47\mu F/10V \text{ X7R} + 6 \times 470\mu F/7m\Omega$

Figure 5.16 ZSPM1501 with Comp3; 5A to 15A Load Step; and Min. Capacitance

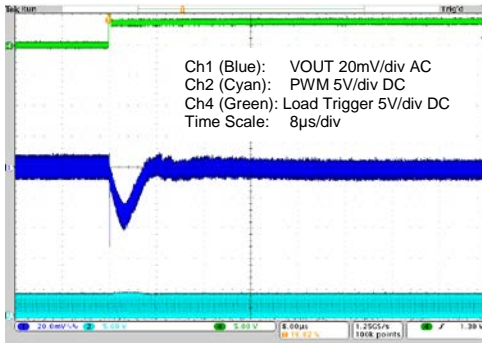

Figure 5.17 ZSPM1501 with Comp3; 15A to 5A Load Step; and Min. Capacitance

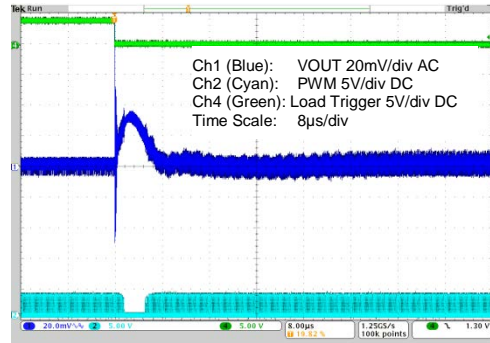

Figure 5.18 ZSPM1501 with Comp3; 5A to 15A Load Step; and Max. Capacitance

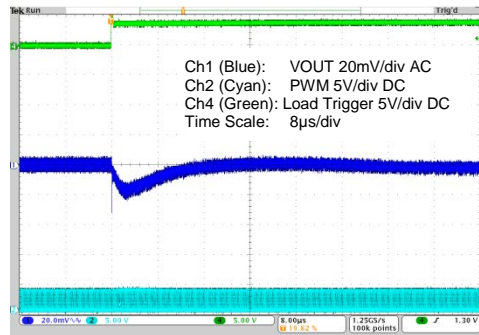

Figure 5.19 ZSPM1501 with Comp3; 15A to 5A Load Step; and Max. Capacitance

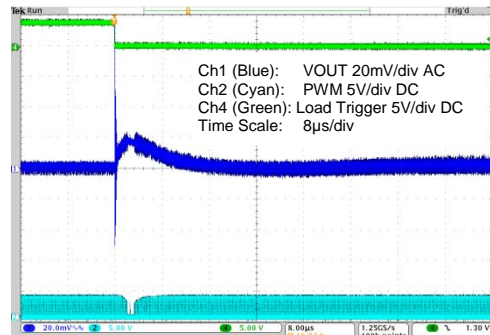
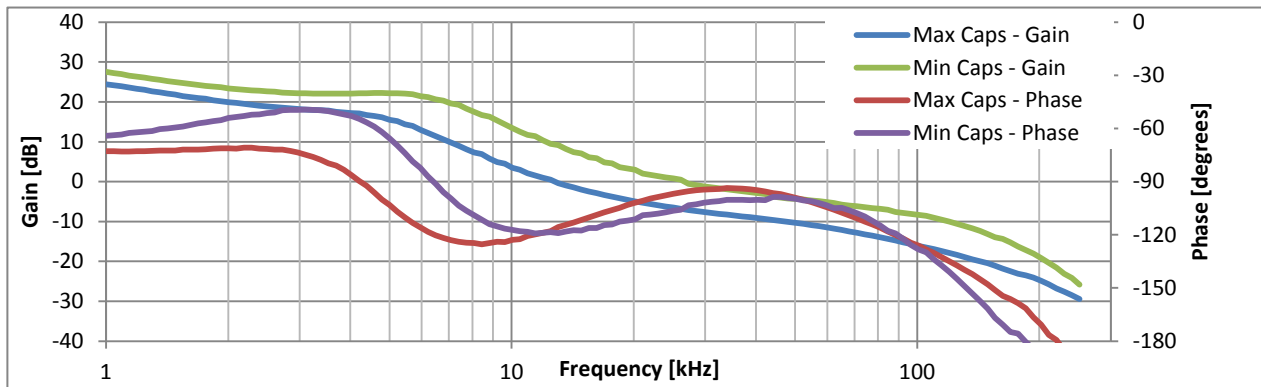

Figure 5.20 Open Loop Bode Plots for ZSPM1501 with Comp3



5.5. ZSPM1502 – Typical Load Transient Response – Capacitor Range #1 – Comp0

Test conditions: $V_{IN} = 12.0V$, $V_{OUT} = 1.00V$

Minimum output capacitance: $2 \times 100\mu F/6.3V \text{ X5R}$

Maximum output capacitance: $4 \times 100\mu F/6.3V \text{ X5R} + 2 \times 47\mu F/10V \text{ X7R}$

Figure 5.21 ZSPM1502 with Comp0; 5A to 15A Load Step; and Min. Capacitance

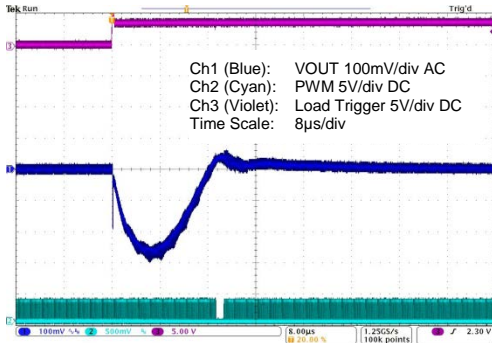

Figure 5.22 ZSPM1502 with Comp0; 15A to 5A Load Step; and Min. Capacitance

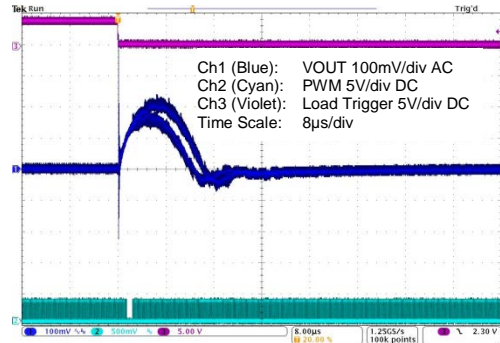

Figure 5.23 ZSPM1502 with Comp0; 5A to 15A Load Step; and Max. Capacitance

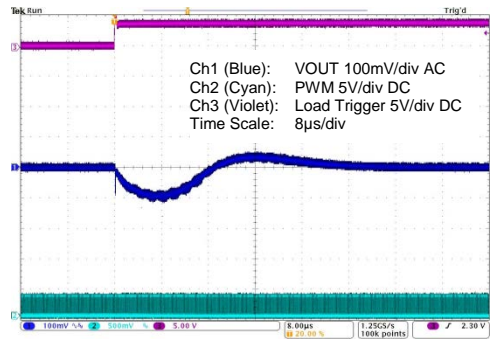

Figure 5.24 ZSPM1502 with Comp0; 15A to 5A Load Step; and Max. Capacitance

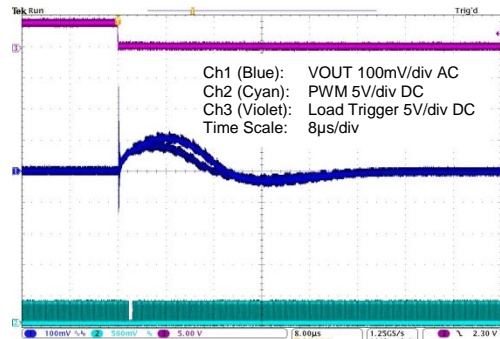
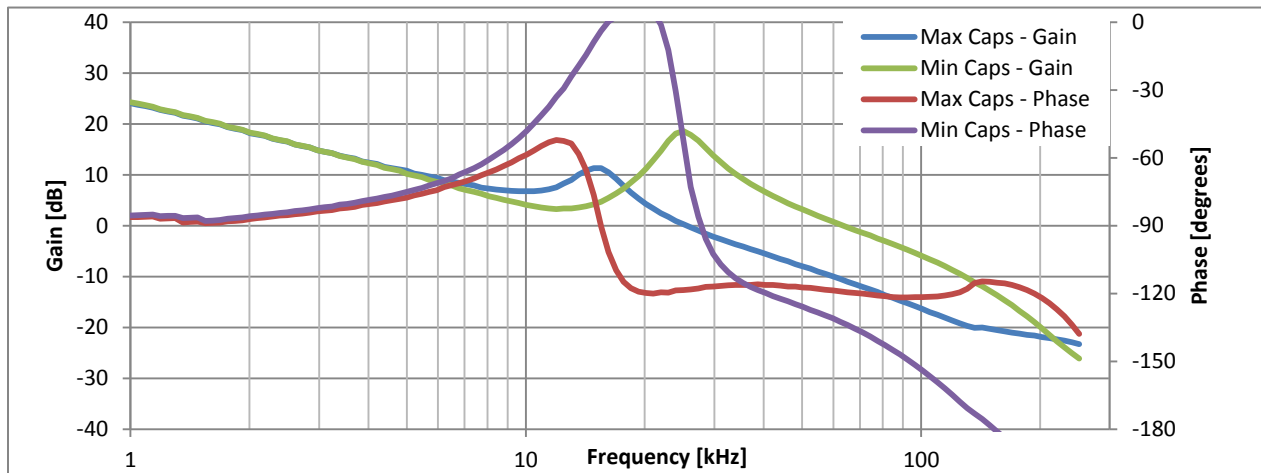

Figure 5.25 Open Loop Bode Plots for ZSPM1502 with Comp0



5.6. ZSPM1502 – Typical Load Transient Response – Capacitor Range #2 – Comp1

Test conditions: $V_{IN} = 12.0V$, $V_{OUT} = 1.00V$

Minimum output capacitance: $5 \times 100\mu F/6.3V \text{ X5R}$

Maximum output capacitance: $8 \times 100\mu F/6.3V \text{ X5R} + 4 \times 47\mu F/10V \text{ X7R}$

Figure 5.26 ZSPM1502 with Comp1; 5A to 15A Load Step; and Min. Capacitance

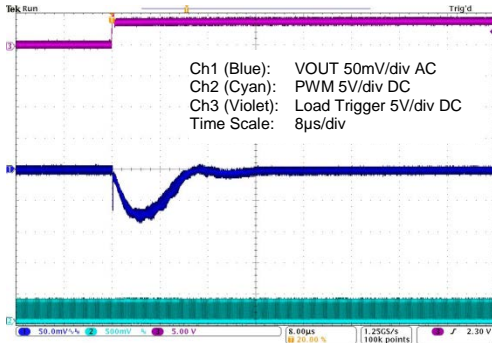

Figure 5.27 ZSPM1502 with Comp1; 15A to 5A Load Step; and Min. Capacitance

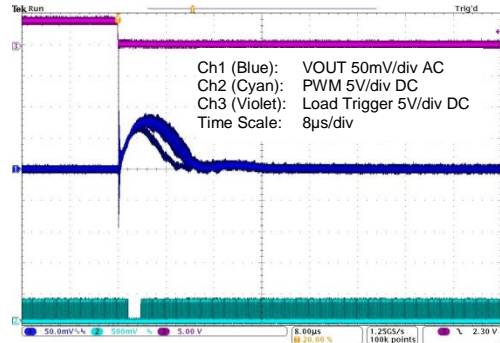

Figure 5.28 ZSPM1502 with Comp1; 5A to 15A Load Step; and Max. Capacitance

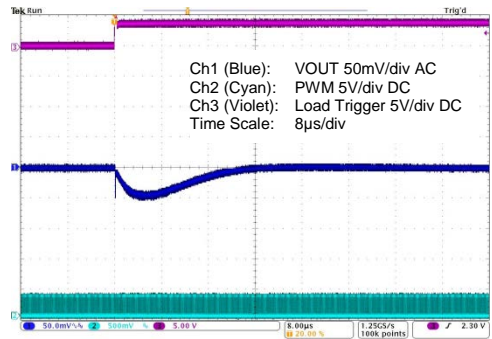

Figure 5.29 ZSPM1502 with Comp1; 15A to 5A Load Step; and Max. Capacitance

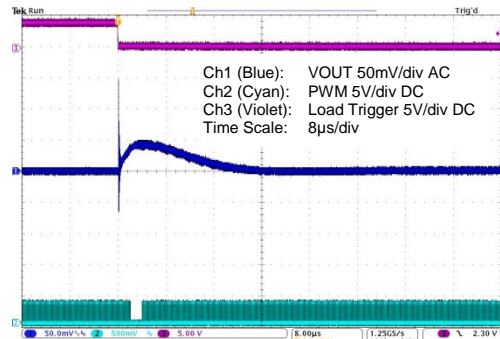
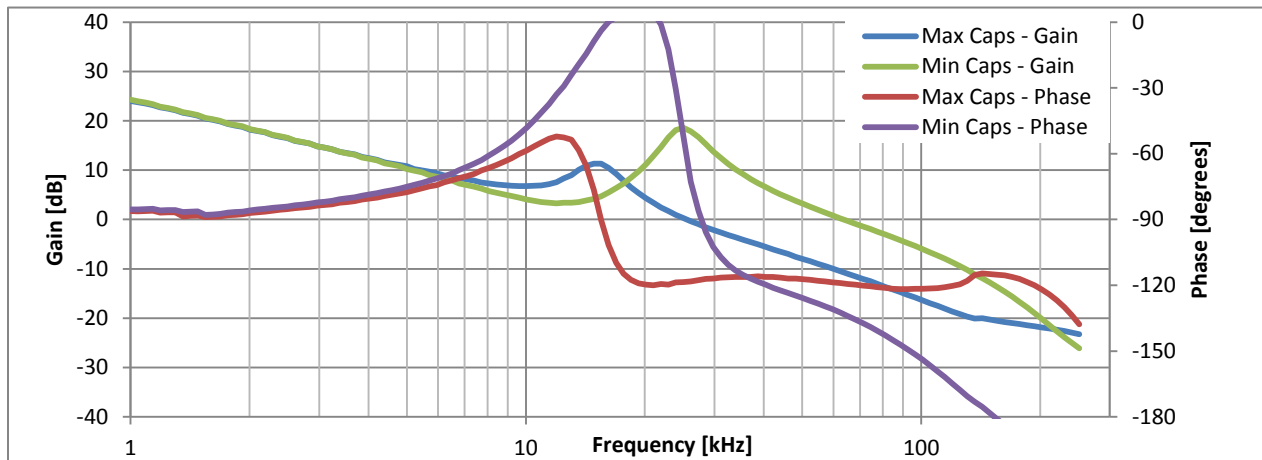

Figure 5.30 Open Loop Bode Plots for ZSPM1502 with Comp1



5.7. ZSPM1502 – Typical Load Transient Response – Capacitor Range #3 – Comp2

Test conditions: $V_{IN} = 12.0V$, $V_{OUT} = 1.00V$

Minimum output capacitance: $2 \times 100\mu F/6.3V \text{ X5R} + 2 \times 470\mu F/7m\Omega$

Maximum output capacitance: $4 \times 100\mu F/6.3V \text{ X5R} + 2 \times 47\mu F/10V \text{ X7R} + 4 \times 470\mu F/7m\Omega$

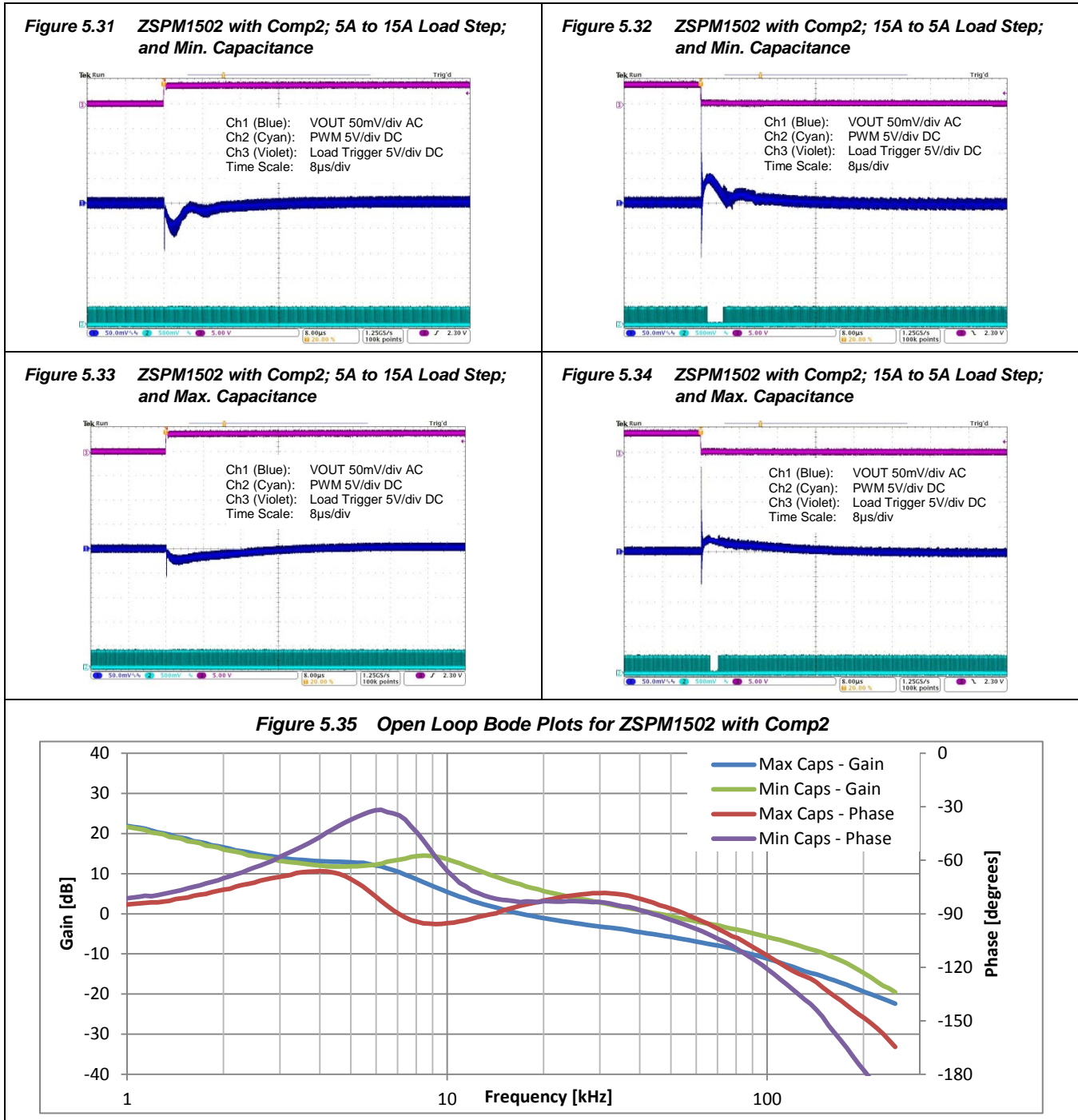

5.8. ZSPM1502 – Typical Load Transient Response – Capacitor Range #4 – Comp3

Test conditions: $V_{IN} = 12.0V$, $V_{OUT} = 1.00V$

Minimum output capacitance: $5 \times 100\mu F/6.3V \text{ X5R} + 4 \times 470\mu F/7m\Omega$

Maximum output capacitance: $8 \times 100\mu F/6.3V \text{ X5R} + 4 \times 47\mu F/10V \text{ X7R} + 6 \times 470\mu F/7m\Omega$

Figure 5.36 ZSPM1502 with Comp3; 5A to 15A Load Step; and Min. Capacitance

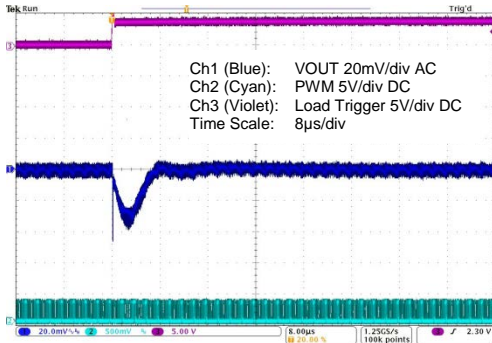

Figure 5.37 ZSPM1502 with Comp3; 15A to 5A Load Step; and Min. Capacitance

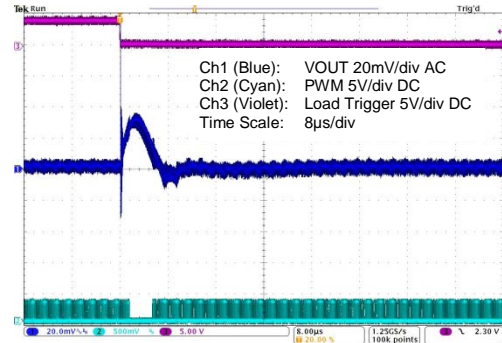

Figure 5.38 ZSPM1502 with Comp3; 5A to 15A Load Step; and Max. Capacitance

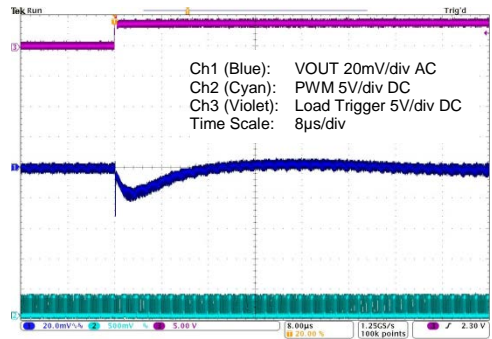

Figure 5.39 ZSPM1502 with Comp3; 15A to 5A Load Step; and Max. Capacitance

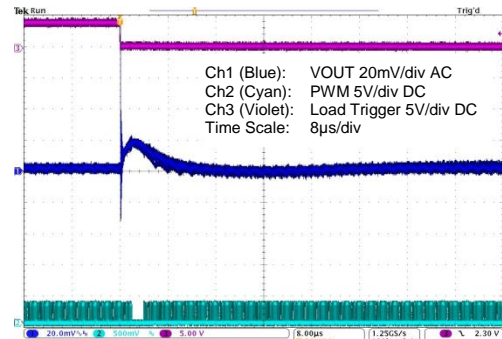
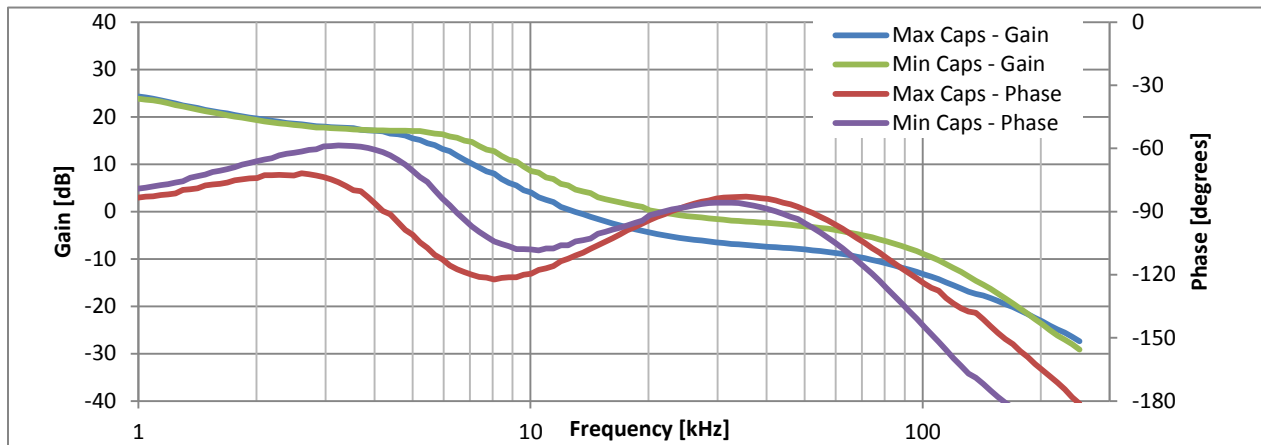

Figure 5.40 Open Loop Bode Plots for ZSPM1502 with Comp3



5.9. ZSPM1503 – Typical Load Transient Response – Capacitor Range #1 – Comp0

Test conditions: $V_{IN} = 12.0V$, $V_{OUT} = 1.20V$

Minimum output capacitance: $2 \times 100\mu F/6.3V \text{ X5R}$

Maximum output capacitance: $4 \times 100\mu F/6.3V \text{ X5R} + 2 \times 47\mu F/10V \text{ X7R}$

Figure 5.41 ZSPM1503 with Comp0; 5A to 15A Load Step; and Min. Capacitance

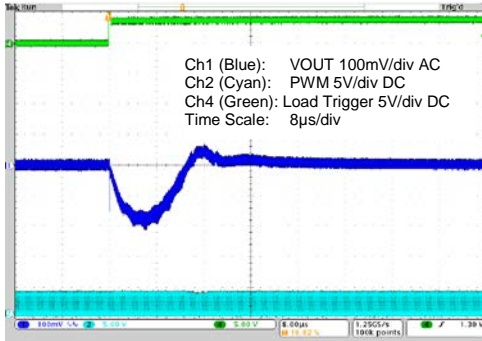

Figure 5.42 ZSPM1503 with Comp0; 15A to 5A Load Step; and Min. Capacitance

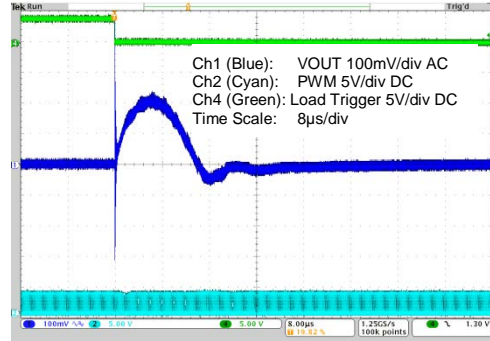

Figure 5.43 ZSPM1503 with Comp0; 5A to 15A Load Step; and Max. Capacitance

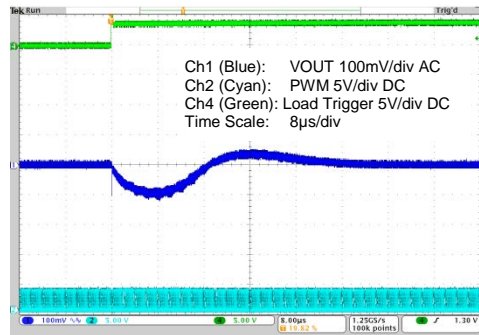

Figure 5.44 ZSPM1503 with Comp0; 15A to 5A Load Step; and Max. Capacitance

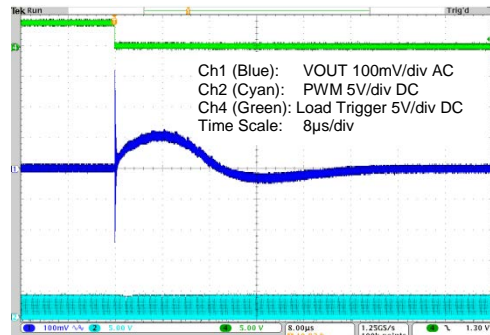
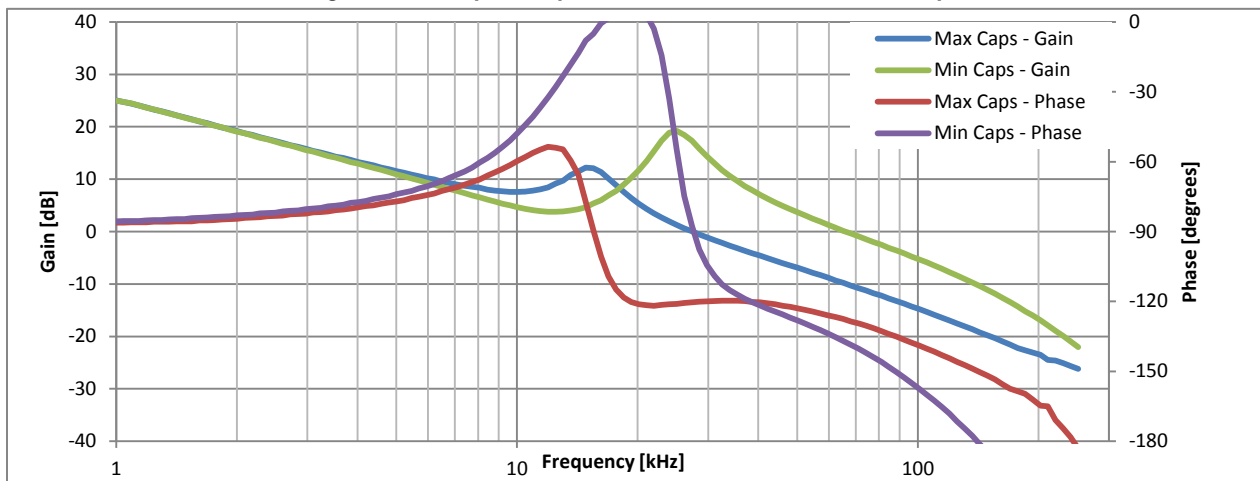

Figure 5.45 Open Loop Bode Plots for ZSPM1503 with Comp0



5.10. ZSPM1503 – Typical Load Transient Response – Capacitor Range #2 – Comp1

Test conditions: $V_{IN} = 12.0V$, $V_{OUT} = 1.20V$

Minimum output capacitance: $5 \times 100\mu F/6.3V \text{ X5R}$

Maximum output capacitance: $8 \times 100\mu F/6.3V \text{ X5R} + 4 \times 47\mu F/10V \text{ X7R}$

Figure 5.46 ZSPM1503 with Comp1; 5A to 15A Load Step; and Min. Capacitance

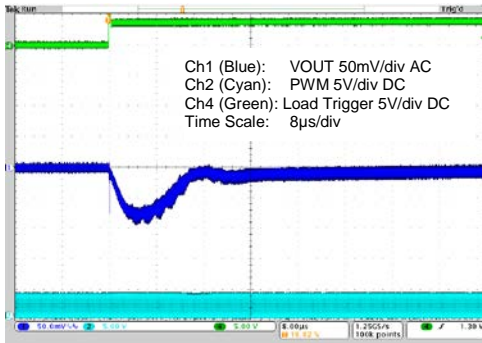

Figure 5.47 ZSPM1503 with Comp1; 15A to 5A Load Step; and Min. Capacitance

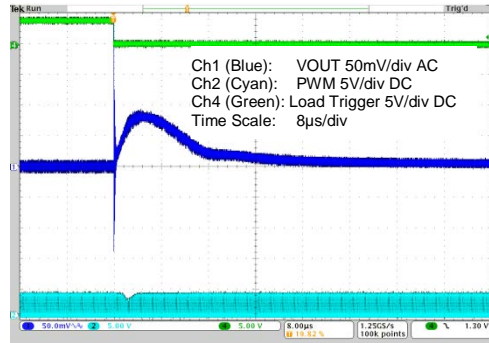

Figure 5.48 ZSPM1503 with Comp1; 5 to 15A Load Step; and Max. Capacitance

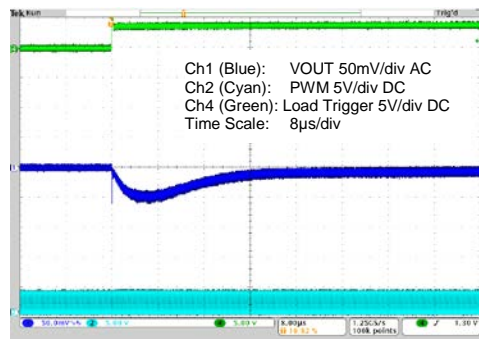

Figure 5.49 ZSPM1503 with Comp1; 15 to 5A Load Step; and Max. Capacitance

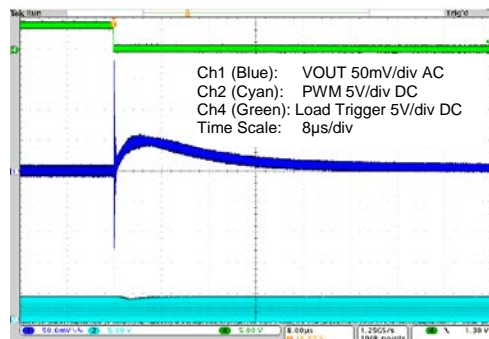
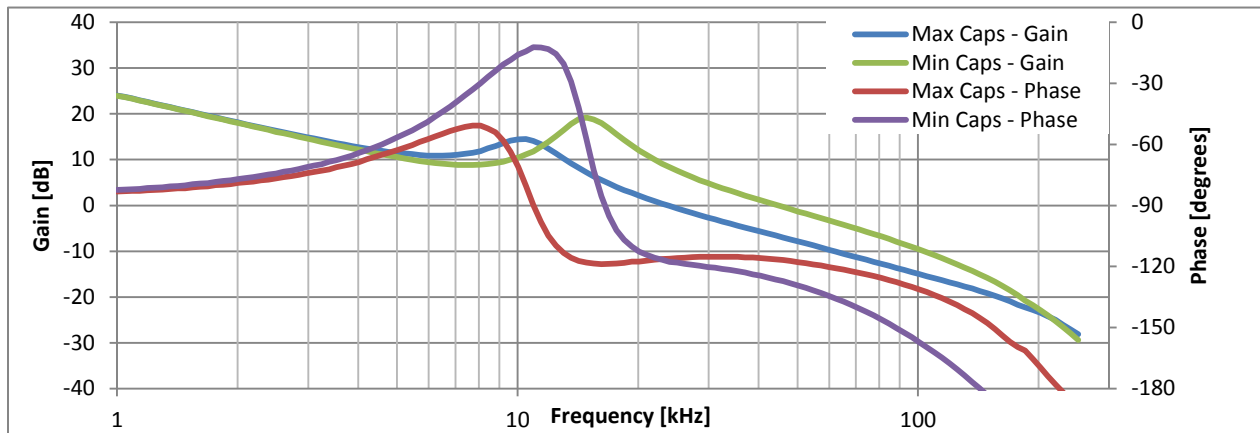

Figure 5.50 Open Loop Bode Plots for ZSPM1503 with Comp1



5.11. ZSPM1503 – Typical Load Transient Response – Capacitor Range #3 – Comp2

Test conditions: $V_{IN} = 12.0V$, $V_{OUT} = 1.20V$

Minimum output capacitance: $2 \times 100\mu F/6.3V \text{ X5R} + 2 \times 470\mu F/7m\Omega$

Maximum output capacitance: $4 \times 100\mu F/6.3V \text{ X5R} + 2 \times 47\mu F/10V \text{ X7R} + 4 \times 470\mu F/7m\Omega$

Figure 5.51 ZSPM1503 with Comp2; 5A to 15A Load Step; and Min. Capacitance

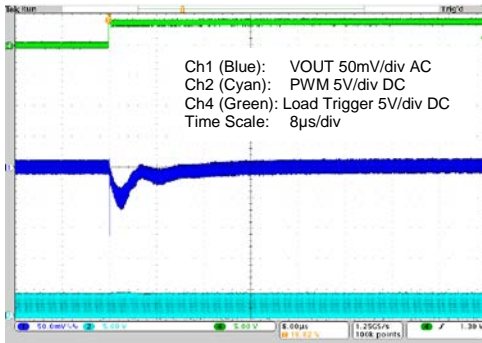

Figure 5.52 ZSPM1503 with Comp2; 15A to 5A Load Step; and Min. Capacitance

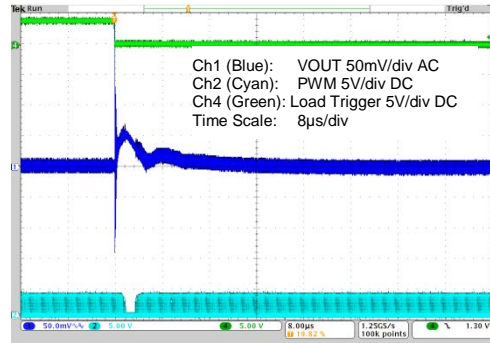

Figure 5.53 ZSPM1503 with Comp2; 5A to 15A Load Step; and Max. Capacitance

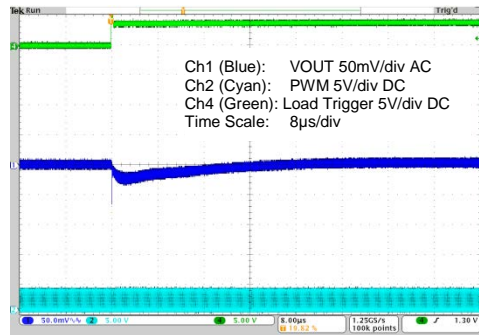

Figure 5.54 ZSPM1503 with Comp2; 15A to 5A Load Step; and Max. Capacitance

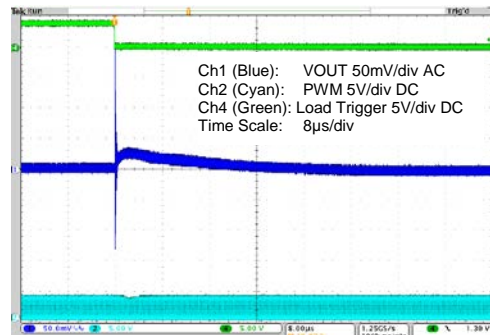
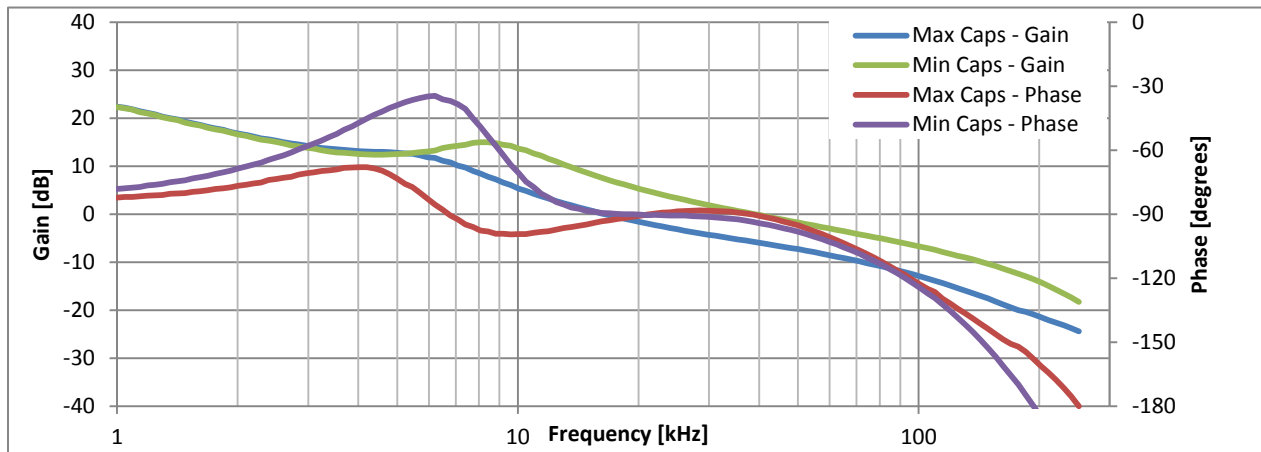

Figure 5.55 Open Loop Bode Plots for ZSPM1503 with Comp2



5.12. ZSPM1503 – Typical Load Transient Response – Capacitor Range #4 – Comp3

Test conditions: $V_{IN} = 12.0V$, $V_{OUT} = 1.20V$

Minimum output capacitance: $5 \times 100\mu F/6.3V \text{ X5R} + 4 \times 470\mu F/7m\Omega$

Maximum output capacitance: $8 \times 100\mu F/6.3V \text{ X5R} + 4 \times 47\mu F/10V \text{ X7R} + 6 \times 470\mu F/7m\Omega$

Figure 5.56 ZSPM1503 with Comp3; 5A to 15A Load Step; and Min. Capacitance

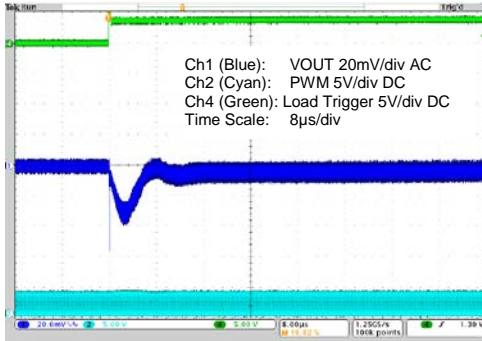

Figure 5.57 ZSPM1503 with Comp3; 15A to 5A Load Step; and Min. Capacitance

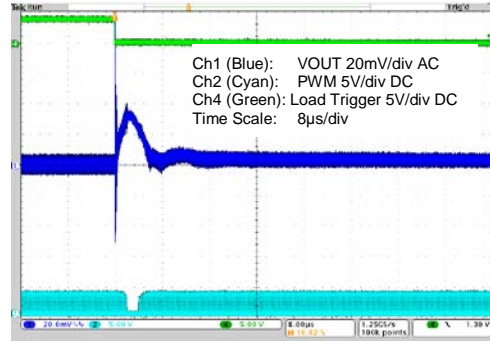

Figure 5.58 ZSPM1503 with Comp3; 5A to 15A Load Step; and Max. Capacitance

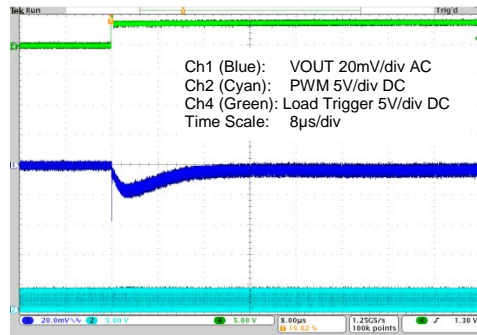

Figure 5.59 ZSPM1503 with Comp3; 15A to 5A Load Step; and Max. Capacitance

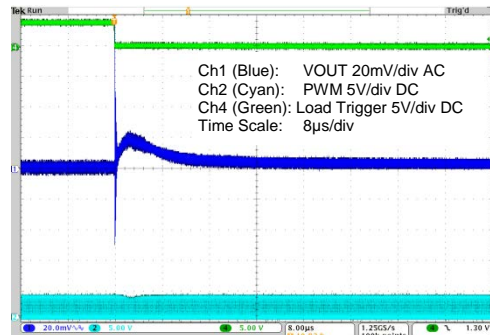
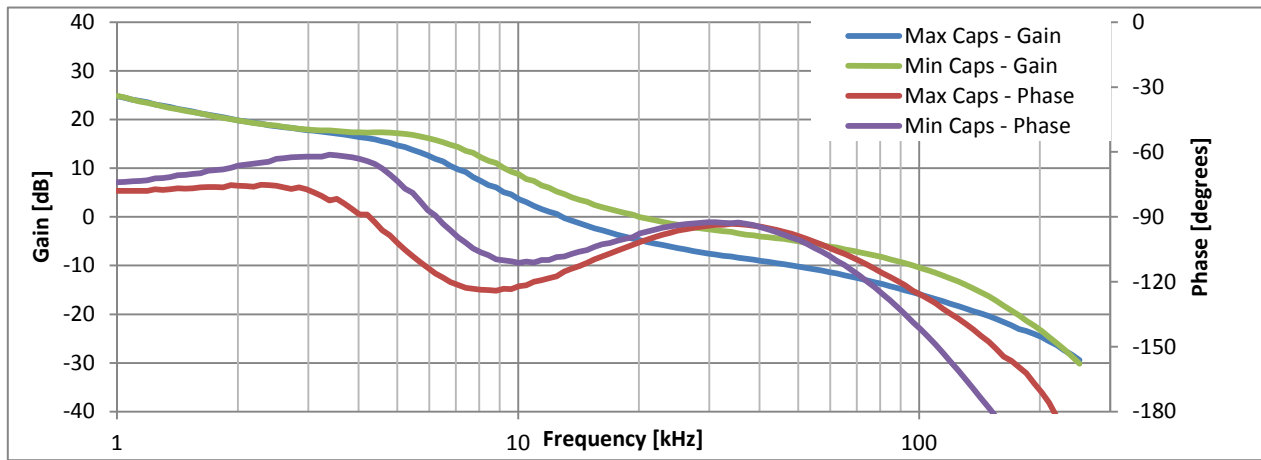

Figure 5.60 Open Loop Bode Plots for ZSPM1503 with Comp3



5.13. ZSPM1504 – Typical Load Transient Response – Capacitor Range #1 – Comp0

Test conditions: $V_{IN} = 12.0V$, $V_{OUT} = 1.50V$

Minimum output capacitance: $2 \times 100\mu F/6.3V \text{ X5R}$

Maximum output capacitance: $4 \times 100\mu F/6.3V \text{ X5R} + 2 \times 47\mu F/10V \text{ X7R}$

Figure 5.61 ZSPM1504 with Comp0; 5A to 15A Load Step; and Min. Capacitance

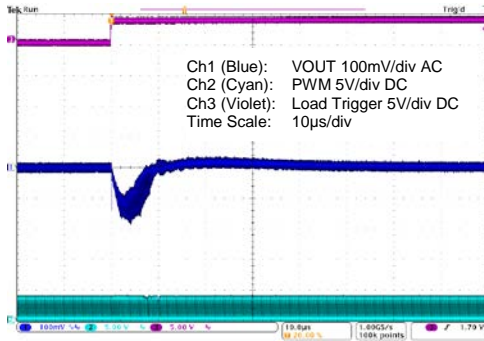

Figure 5.62 ZSPM1504 with Comp0; 15A to 5A Load Step; and Min. Capacitance

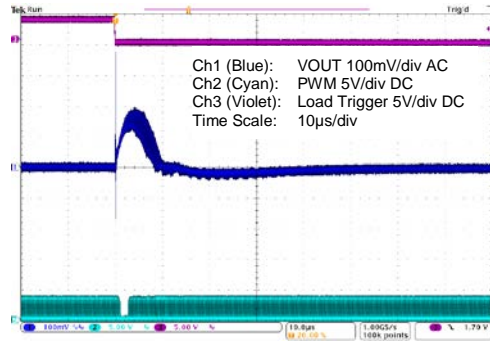

Figure 5.63 ZSPM1504 with Comp0; 5A to 15A Load Step; and Max. Capacitance

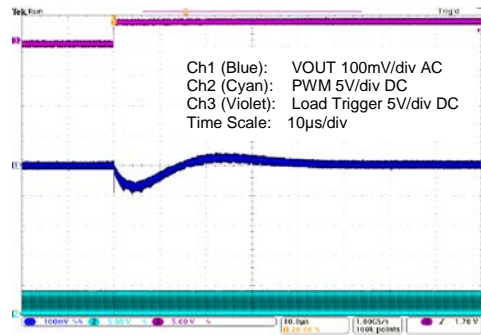

Figure 5.64 ZSPM1504 with Comp0; 15A to 5A Load Step; and Max. Capacitance

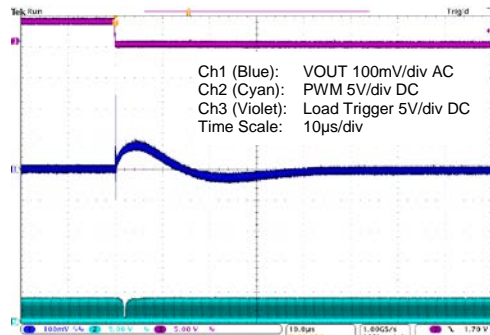
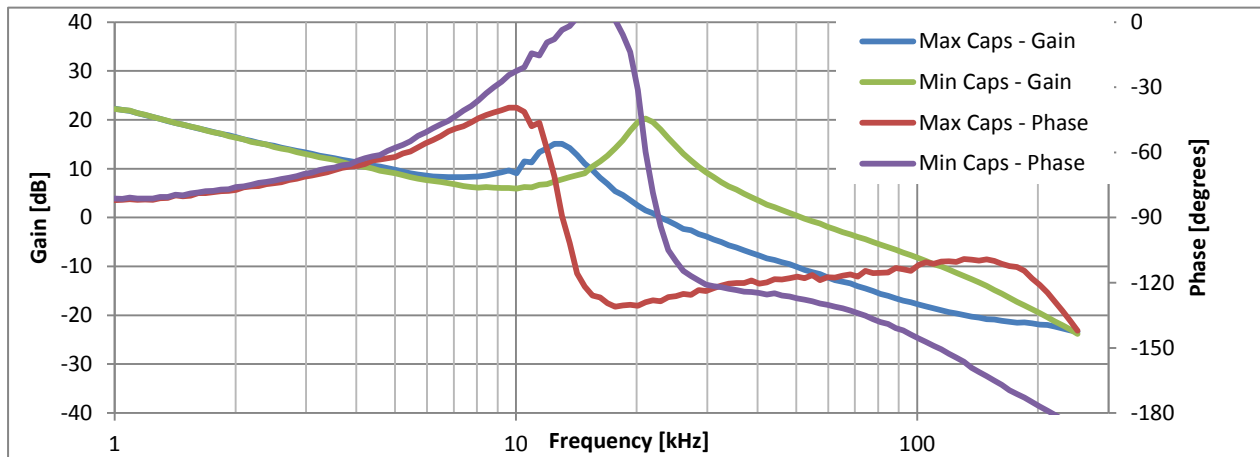

Figure 5.65 Open Loop Bode Plots for ZSPM1504 with Comp0



5.14. ZSPM1504 – Typical Load Transient Response – Capacitor Range #2 – Comp1

Test conditions: $V_{IN} = 12.0V$, $V_{OUT} = 1.50V$

Minimum output capacitance: $5 \times 100\mu F/6.3V \text{ X5R}$

Maximum output capacitance: $8 \times 100\mu F/6.3V \text{ X5R} + 4 \times 47\mu F/10V \text{ X7R}$

Figure 5.66 ZSPM1504 with Comp1; 5A to 15A Load Step; and Min. Capacitance

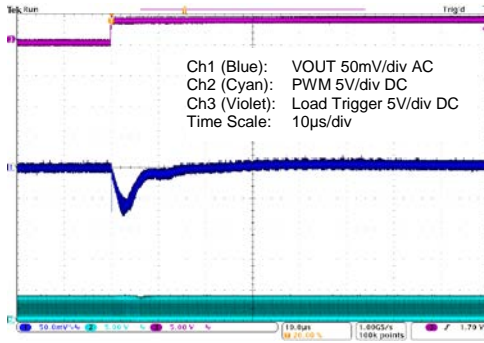

Figure 5.67 ZSPM1504 with Comp1; 15A to 5A Load Step; and Min. Capacitance

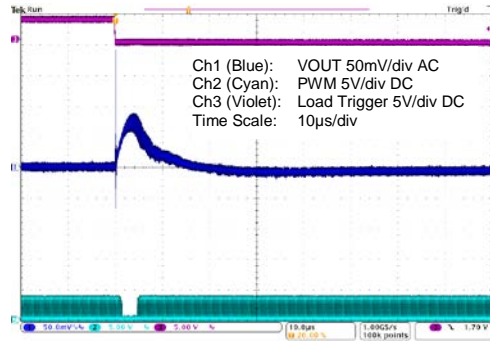

Figure 5.68 ZSPM1504 with Comp1; 5A to 15A Load Step; and Max. Capacitance

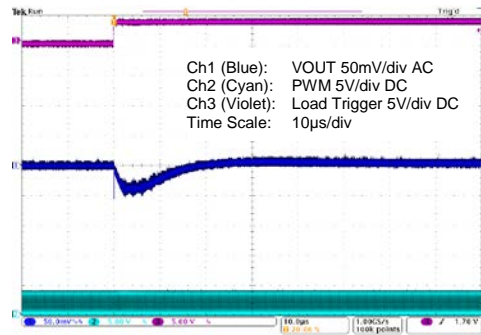

Figure 5.69 ZSPM1504 with Comp1; 15A to 5A Load Step; and Max. Capacitance

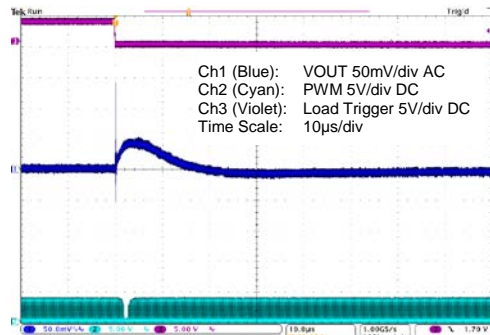
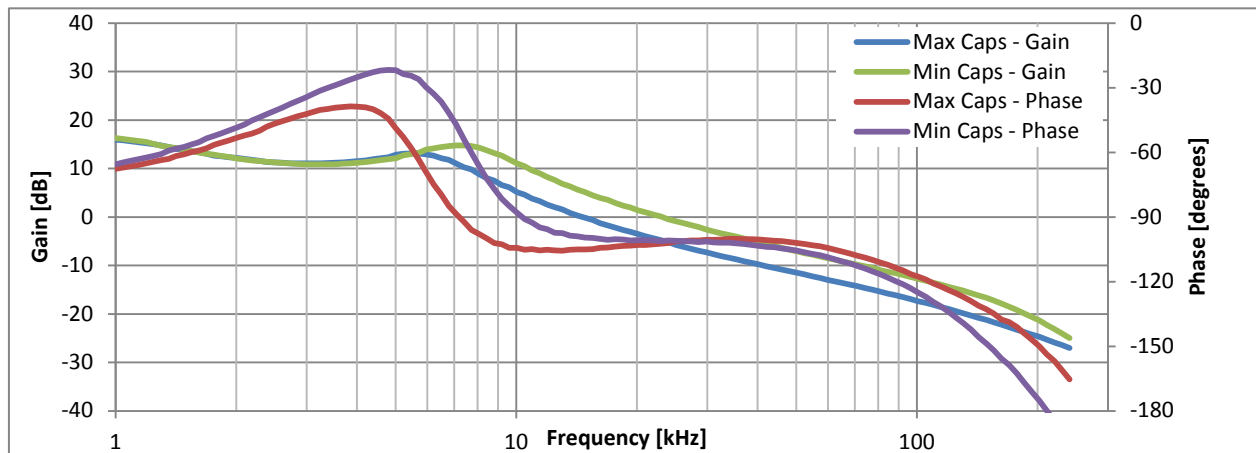

Figure 5.70 Open Loop Bode Plots for ZSPM1504 with Comp1



5.15. ZSPM1504 – Typical Load Transient Response – Capacitor Range #3 – Comp2

Test conditions: $V_{IN} = 12.0V$, $V_{OUT} = 1.50V$

Minimum output capacitance: $2 \times 100\mu F/6.3V \text{ X5R} + 2 \times 470\mu F/7m\Omega$

Maximum output capacitance: $4 \times 100\mu F/6.3V \text{ X5R} + 2 \times 47\mu F/10V \text{ X7R} + 4 \times 470\mu F/7m\Omega$

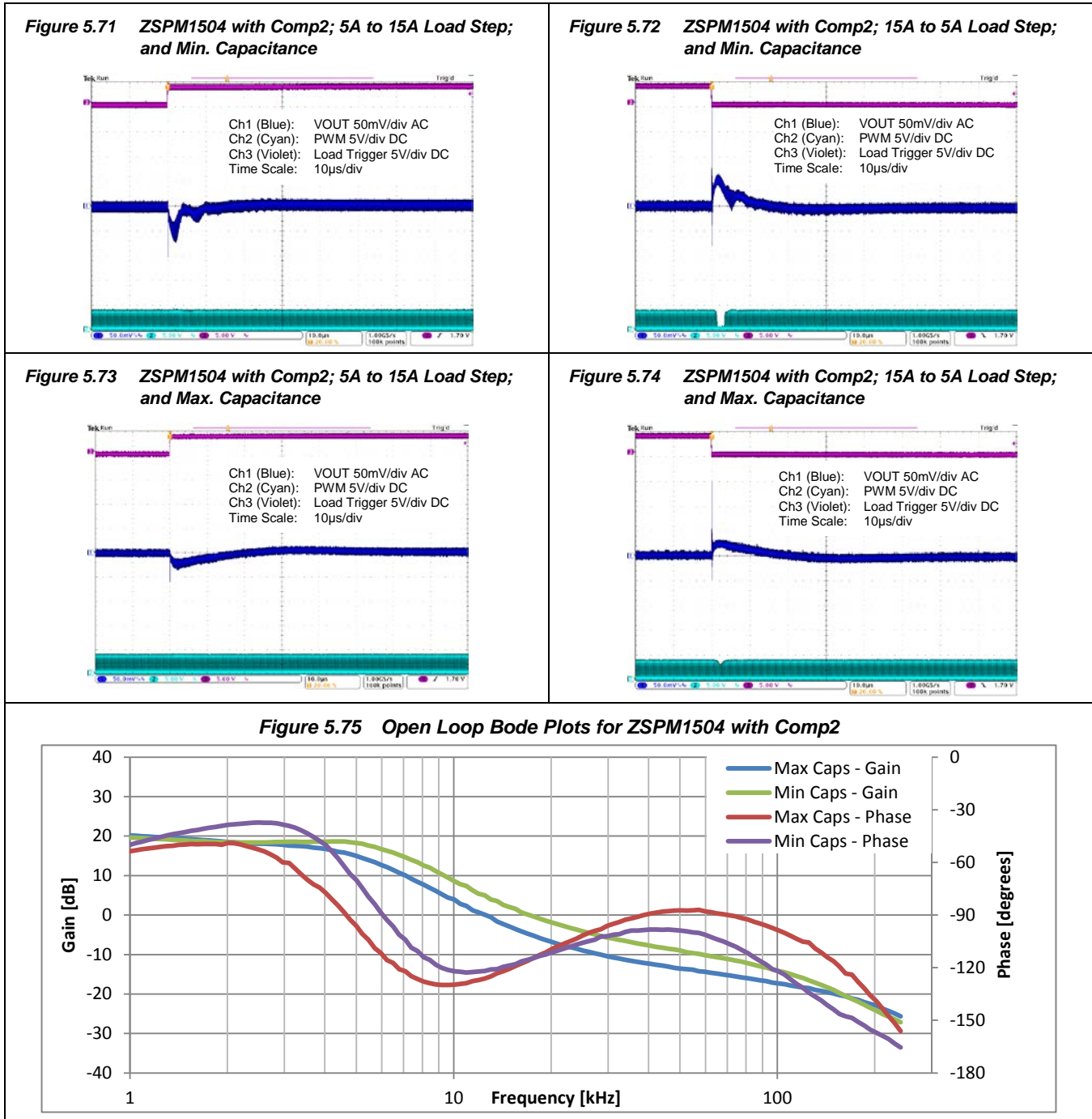

5.16. ZSPM1504 – Typical Load Transient Response – Capacitor Range #4 – Comp3

Test conditions: $V_{IN} = 12.0V$, $V_{OUT} = 1.50V$

Minimum output capacitance: $5 \times 100\mu F/6.3V \text{ X5R} + 4 \times 470\mu F/7m\Omega$

Maximum output capacitance: $8 \times 100\mu F/6.3V \text{ X5R} + 4 \times 47\mu F/10V \text{ X7R} + 6 \times 470\mu F/7m\Omega$

Figure 5.76 ZSPM1504 with Comp3; 5A to 15A Load Step; and Min. Capacitance

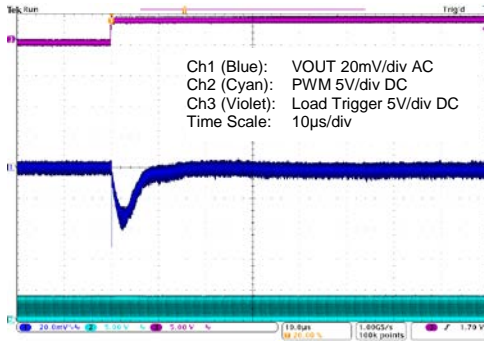

Figure 5.77 ZSPM1504 with Comp3; 15A to 5A Load Step; and Min. Capacitance

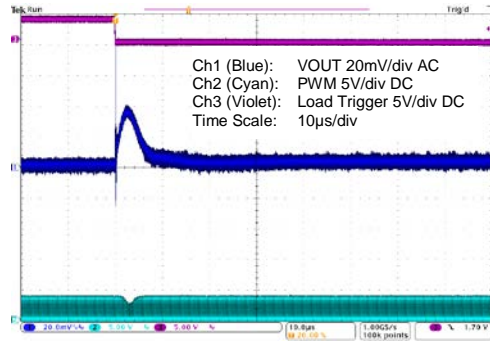

Figure 5.78 ZSPM1504 with Comp3; 5A to 15A Load Step; and Max. Capacitance

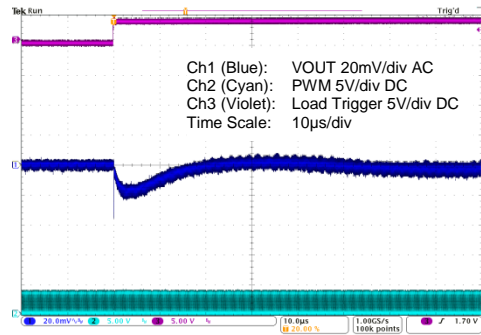

Figure 5.79 ZSPM1504 with Comp3; 15A to 5A Load Step; and Max. Capacitance

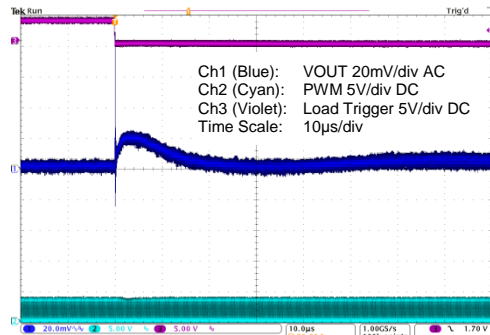
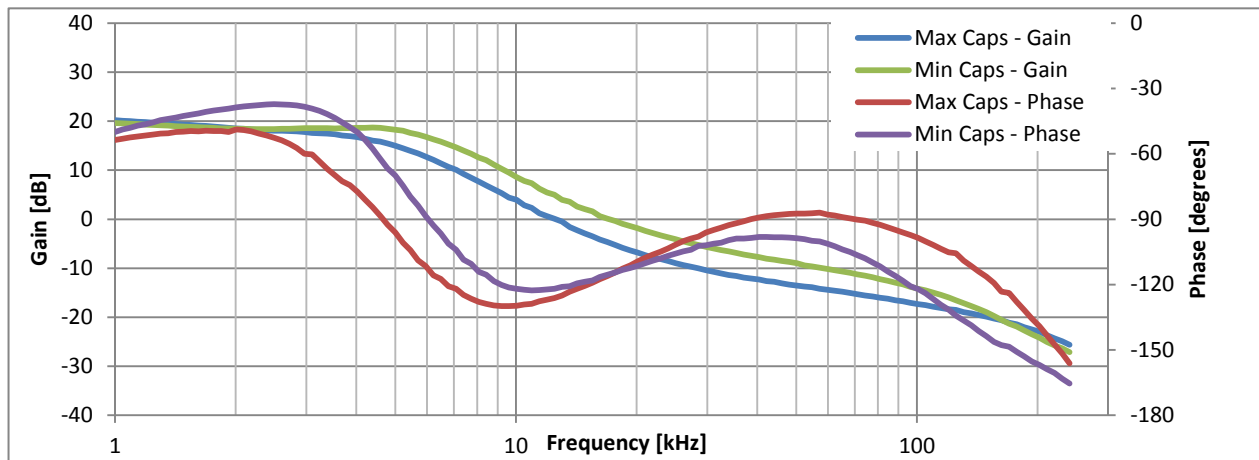

Figure 5.80 Open Loop Bode Plots for ZSPM1504 with Comp3



5.17. ZSPM1505 – Typical Load Transient Response – Capacitor Range #1 – Comp0

Test conditions: $V_{IN} = 12.0V$, $V_{OUT} = 1.80V$

Minimum output capacitance: $2 \times 100\mu F/6.3V \text{ X5R}$

Maximum output capacitance: $4 \times 100\mu F/6.3V \text{ X5R} + 2 \times 47\mu F/10V \text{ X7R}$

Figure 5.81 ZSPM1505 with Comp0; 5A to 15A Load Step; and Min. Capacitance

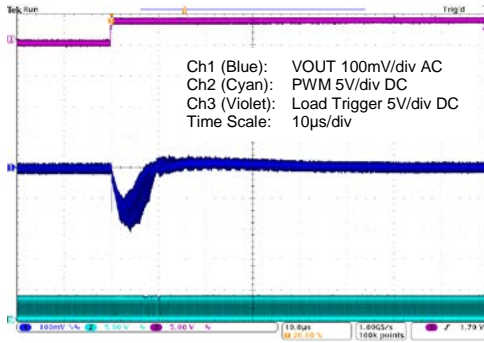

Figure 5.82 ZSPM1505 with Comp0; 15A to 5A Load Step; and Min. Capacitance

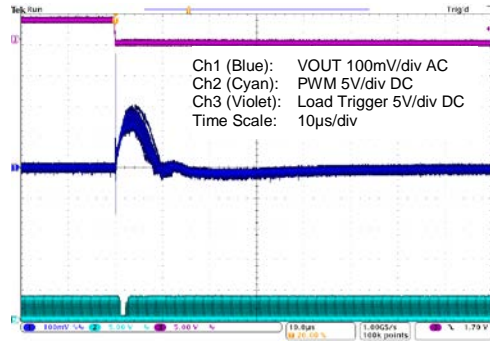

Figure 5.83 ZSPM1505 with Comp0; 5A to 15A Load Step; and Max. Capacitance

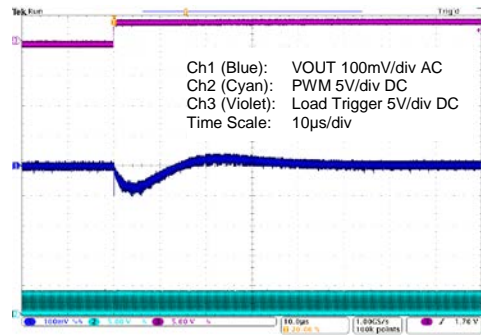

Figure 5.84 ZSPM1505 with Comp0; 15A to 5A Load Step; and Max. Capacitance

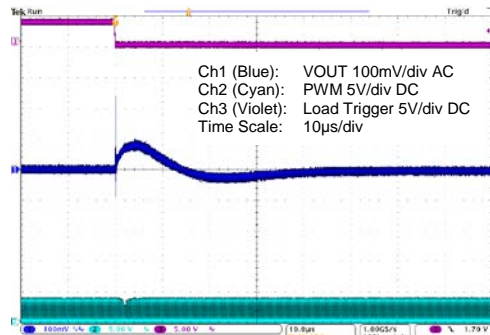
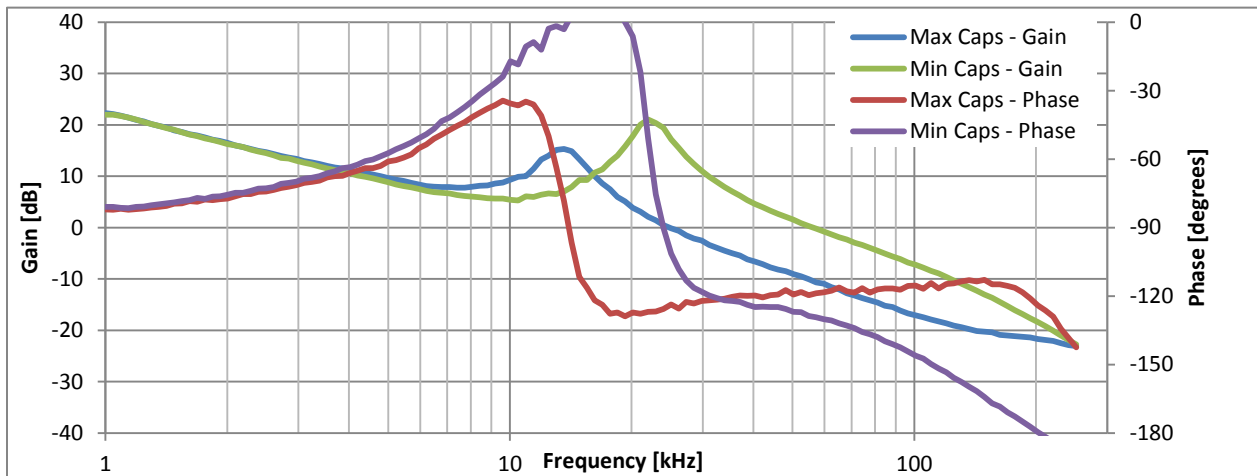

Figure 5.85 Open Loop Bode Plots for ZSPM1505 with Comp0



5.18. ZSPM1505 – Typical Load Transient Response – Capacitor Range #2 – Comp1

Test conditions: $V_{IN} = 12.0V$, $V_{OUT} = 1.80V$

Minimum output capacitance: $5 \times 100\mu F/6.3V \text{ X5R}$

Maximum output capacitance: $8 \times 100\mu F/6.3V \text{ X5R} + 4 \times 47\mu F/10V \text{ X7R}$

Figure 5.86 ZSPM1505 with Comp1; 5A to 15A Load Step; and Min. Capacitance

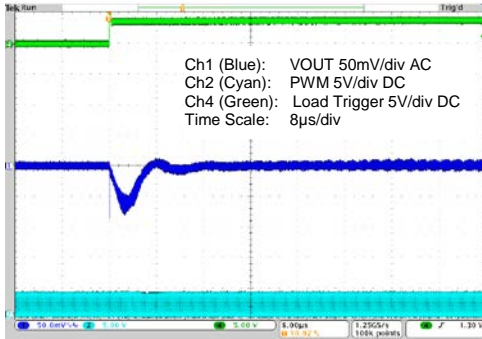

Figure 5.87 ZSPM1505 with Comp1; 15A to 5A Load Step; and Min. Capacitance

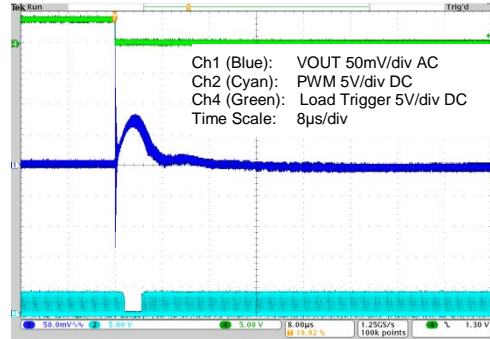

Figure 5.88 ZSPM1505 with Comp1; 5A to 15A Load Step; and Max. Capacitance

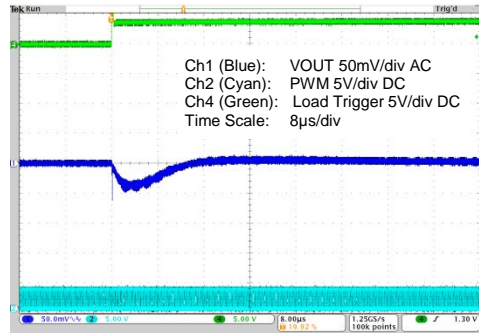

Figure 5.89 ZSPM1505 with Comp1; 15A to 5A Load Step; and Max. Capacitance

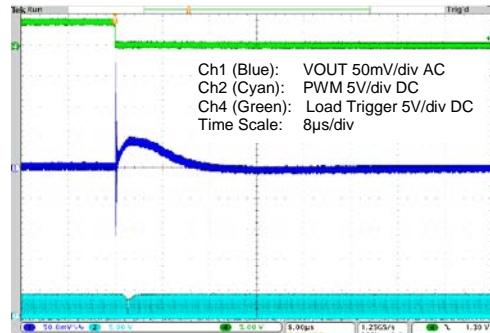
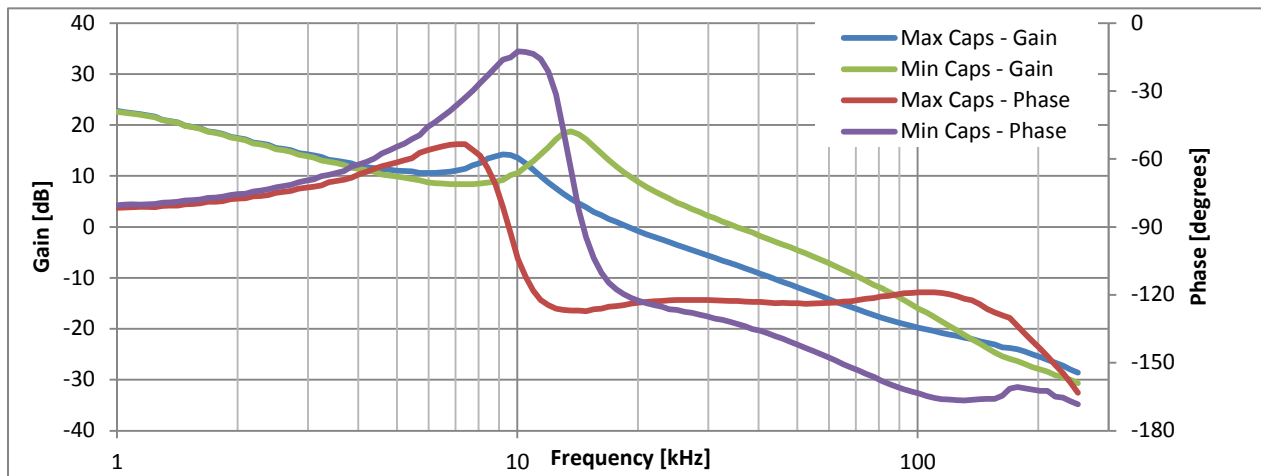

Figure 5.90 Open Loop Bode Plots for ZSPM1505 with Comp1



5.19. ZSPM1505 – Typical Load Transient Response – Capacitor Range #3 – Comp2

Test conditions: $V_{IN} = 12.0V$, $V_{OUT} = 1.80V$

Minimum output capacitance: $2 \times 100\mu F/6.3V \text{ X5R} + 2 \times 470\mu F/7m\Omega$

Maximum output capacitance: $4 \times 100\mu F/6.3V \text{ X5R} + 2 \times 47\mu F/10V \text{ X7R} + 4 \times 470\mu F/7m\Omega$

Figure 5.91 ZSPM1505 with Comp2; 5A to 15A Load Step; and Min. Capacitance

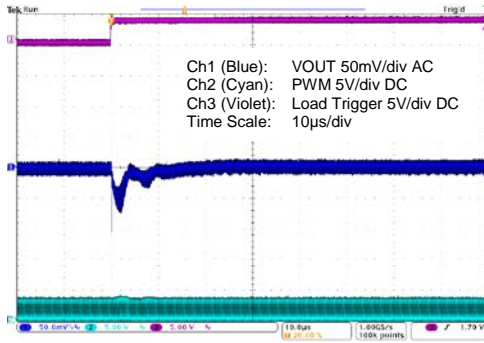

Figure 5.92 ZSPM1505 with Comp2; 15A to 5A Load Step; and Min. Capacitance

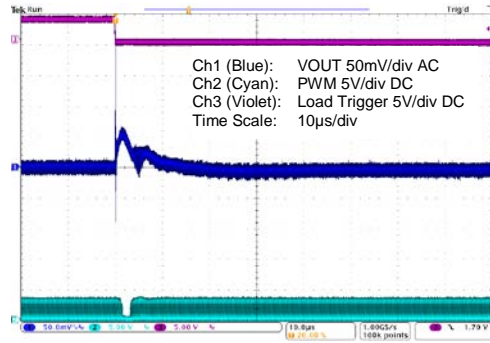

Figure 5.93 ZSPM1505 with Comp2; 5A to 15A Load Step; and Max. Capacitance

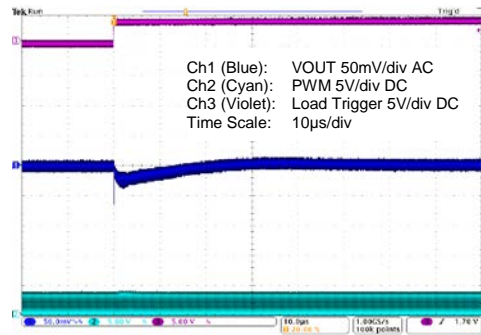

Figure 5.94 ZSPM1505 with Comp2; 15A to 5A Load Step; and Max. Capacitance

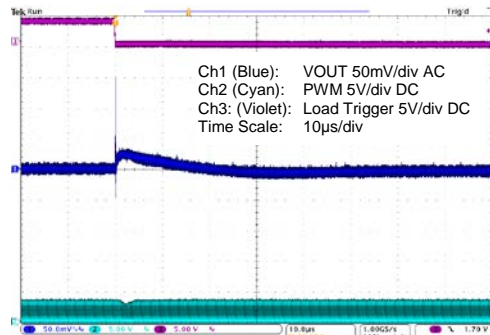
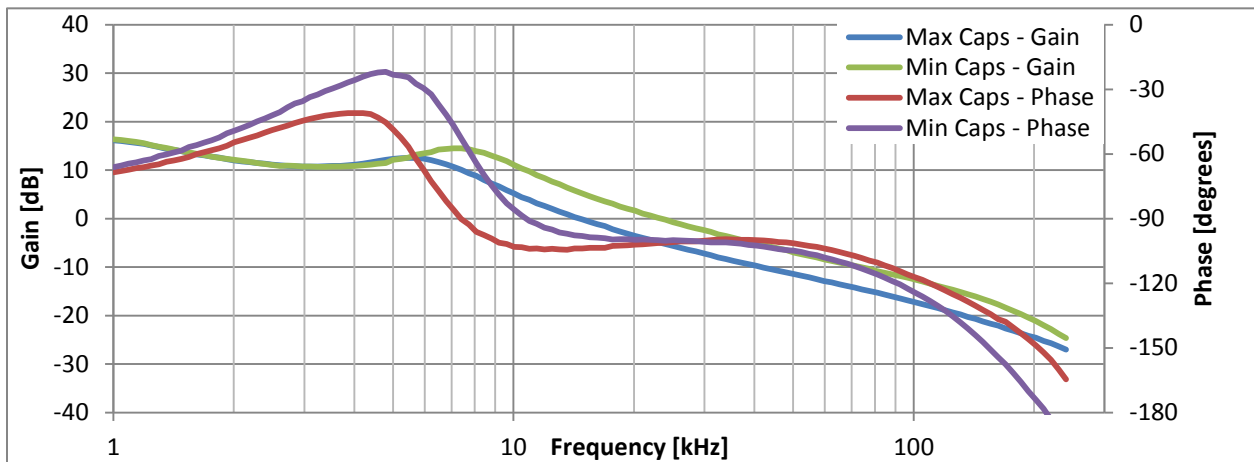

Figure 5.95 Open Loop Bode Plots for ZSPM1505 with Comp2



5.20. ZSPM1505 – Typical Load Transient Response – Capacitor Range #4 – Comp3

Test conditions: $V_{IN} = 12.0V$, $V_{OUT} = 1.80V$

Minimum output capacitance: $5 \times 100\mu F/6.3V \text{ X5R} + 4 \times 470\mu F/7m\Omega$

Maximum output capacitance: $8 \times 100\mu F/6.3V \text{ X5R} + 4 \times 47\mu F/10V \text{ X7R} + 6 \times 470\mu F/7m\Omega$

Figure 5.96 ZSPM1505 with Comp3; 5A to 15A Load Step; and Min. Capacitance

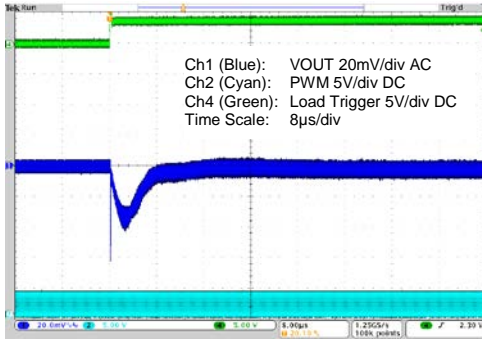

Figure 5.97 ZSPM1505 with Comp3; 15A to 5A Load Step; and Min. Capacitance

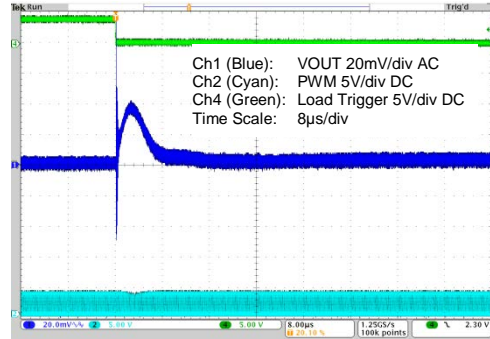

Figure 5.98 ZSPM1505 with Comp3; 5A to 15A Load Step; and Max. Capacitance

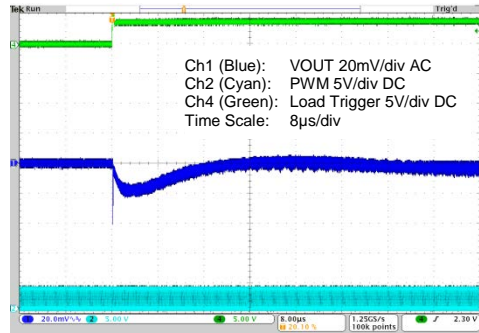

Figure 5.99 ZSPM1505 with Comp3; 15A to 5A Load Step; and Max. Capacitance

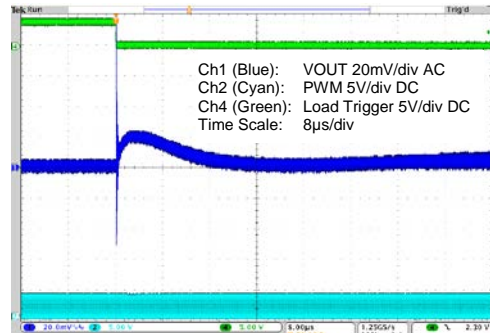
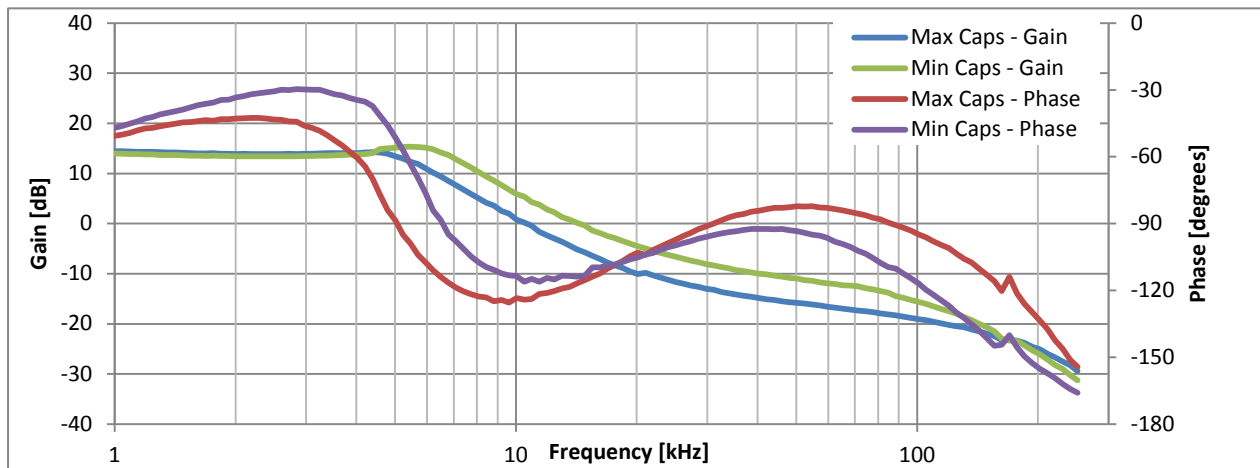

Figure 5.100 Open Loop Bode Plots for ZSPM1505 with Comp3



5.21. ZSPM1506 – Typical Load Transient Response – Capacitor Range #1 – Comp0

Test conditions: $V_{IN} = 12.0V$, $V_{OUT} = 2.00V$

Minimum output capacitance: $2 \times 100\mu F/6.3V \text{ X5R}$

Maximum output capacitance: $4 \times 100\mu F/6.3V \text{ X5R} + 2 \times 47\mu F/10V \text{ X7R}$

Figure 5.101 ZSPM1506 with Comp0; 5A to 15A Load Step; and Min. Capacitance

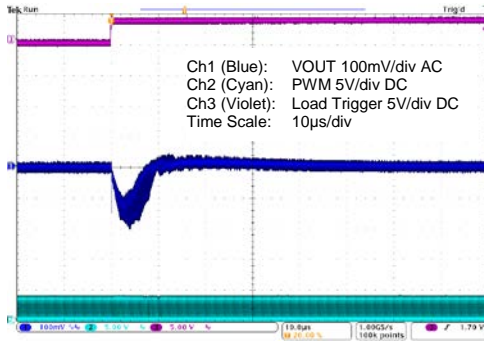

Figure 5.102 ZSPM1506 with Comp0; 15A to 5A Load Step; and Min. Capacitance

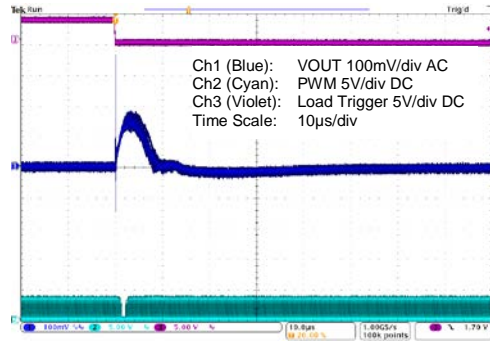

Figure 5.103 ZSPM1506 with Comp0; 5A to 15A Load Step; and Max. Capacitance

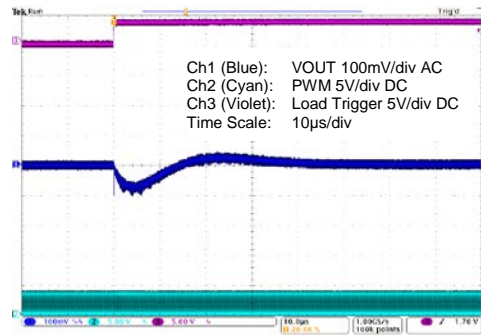

Figure 5.104 ZSPM1506 with Comp0; 15A to 5A Load Step; and Max. Capacitance

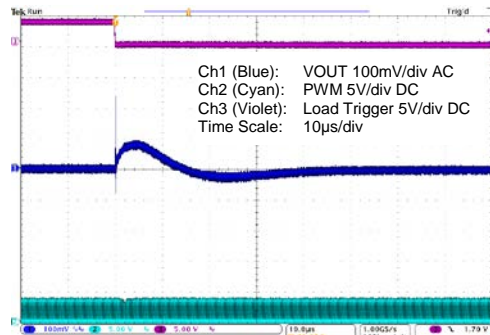
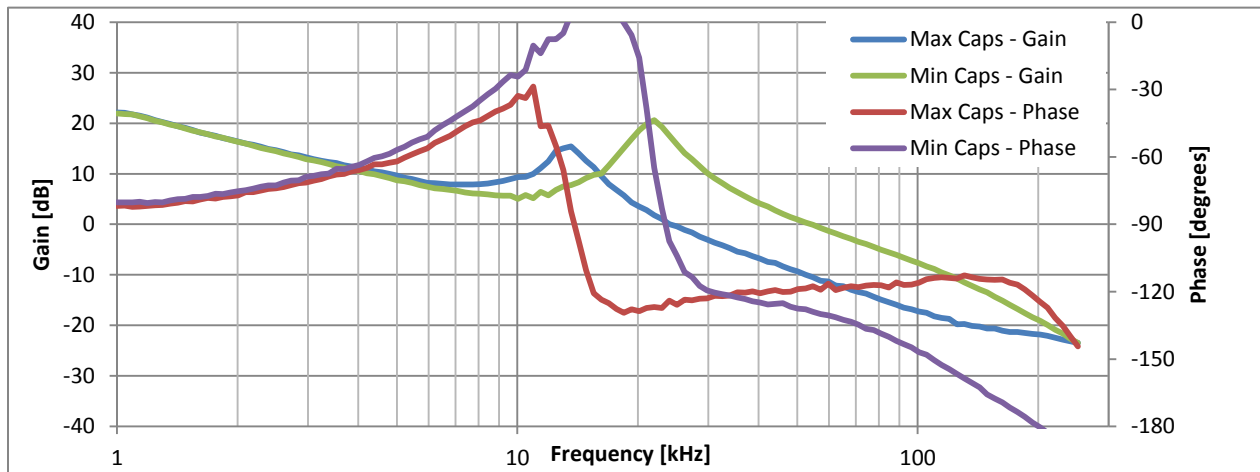

Figure 5.105 Open Loop Bode Plots for ZSPM1506 with Comp0



5.22. ZSPM1506 – Typical Load Transient Response – Capacitor Range #2 – Comp1

Test conditions: $V_{IN} = 12.0V$, $V_{OUT} = 2.00V$

Minimum output capacitance: $5 \times 100\mu F/6.3V \text{ X5R}$

Maximum output capacitance: $8 \times 100\mu F/6.3V \text{ X5R} + 4 \times 47\mu F/10V \text{ X7R}$

Figure 5.106 ZSPM1506 with Comp1; 5A to 15A Load Step; and Min. Capacitance

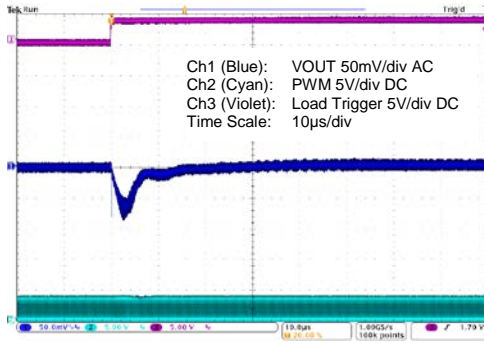

Figure 5.107 ZSPM1506 with Comp1; 15A to 5A Load Step; and Min. Capacitance

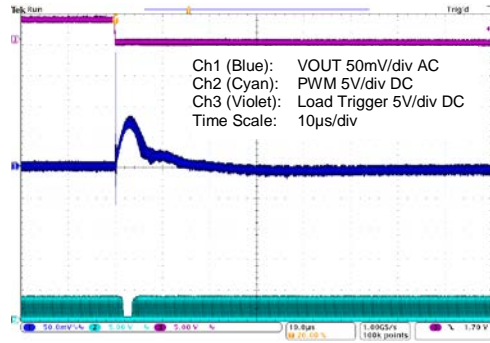

Figure 5.108 ZSPM1506 with Comp1; 5A to 15A Load Step; and Max. Capacitance

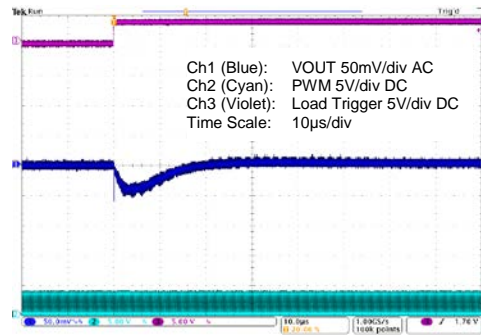

Figure 5.109 ZSPM1506 with Comp1; 15A to 5A Load Step; and Max. Capacitance

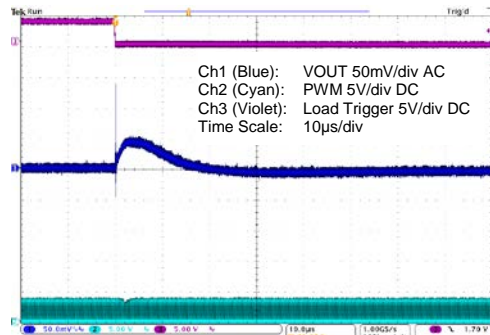
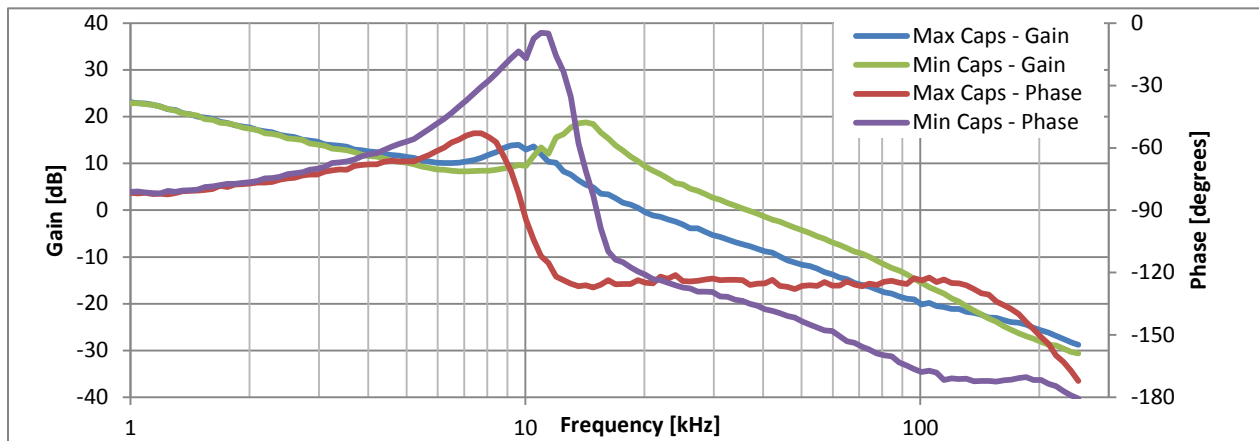

Figure 5.110 Open Loop Bode Plots for ZSPM1506 with Comp1



5.23. ZSPM1506 – Typical Load Transient Response – Capacitor Range #3 – Comp2

Test conditions: $V_{IN} = 12.0V$, $V_{OUT} = 2.00V$

Minimum output capacitance: $2 \times 100\mu F/6.3V \text{ X5R} + 2 \times 470\mu F/7m\Omega$

Maximum output capacitance: $4 \times 100\mu F/6.3V \text{ X5R} + 2 \times 47\mu F/10V \text{ X7R} + 4 \times 470\mu F/7m\Omega$

Figure 5.111 ZSPM1506 with Comp2; 5A to 15A Load Step; and Min. Capacitance

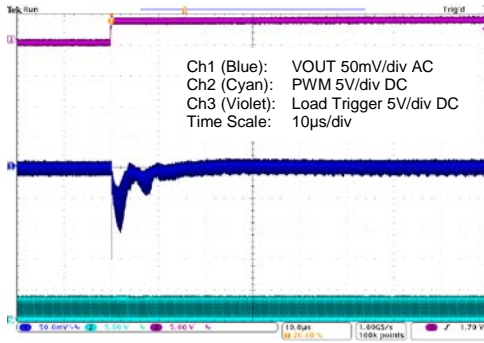

Figure 5.112 ZSPM1506 with Comp2; 15A to 5A Load Step; and Min. Capacitance

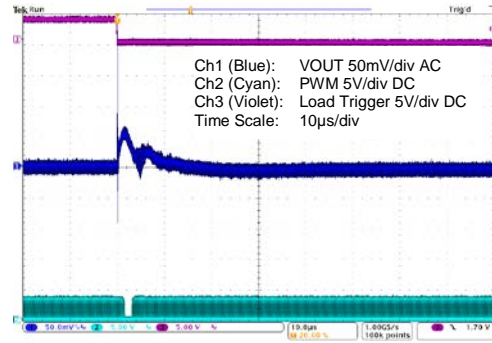

Figure 5.113 ZSPM1506 with Comp2; 5A to 15A Load Step; and Max. Capacitance

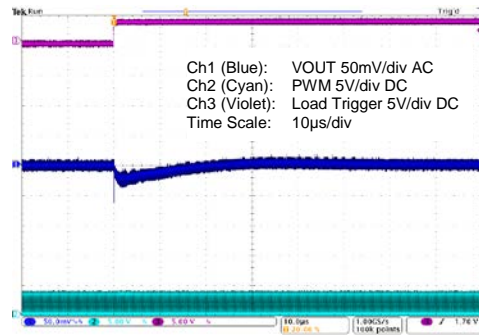

Figure 5.114 ZSPM1506 with Comp2; 15A to 5A Load Step; and Max. Capacitance

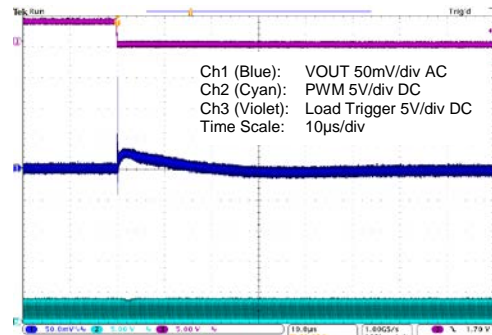
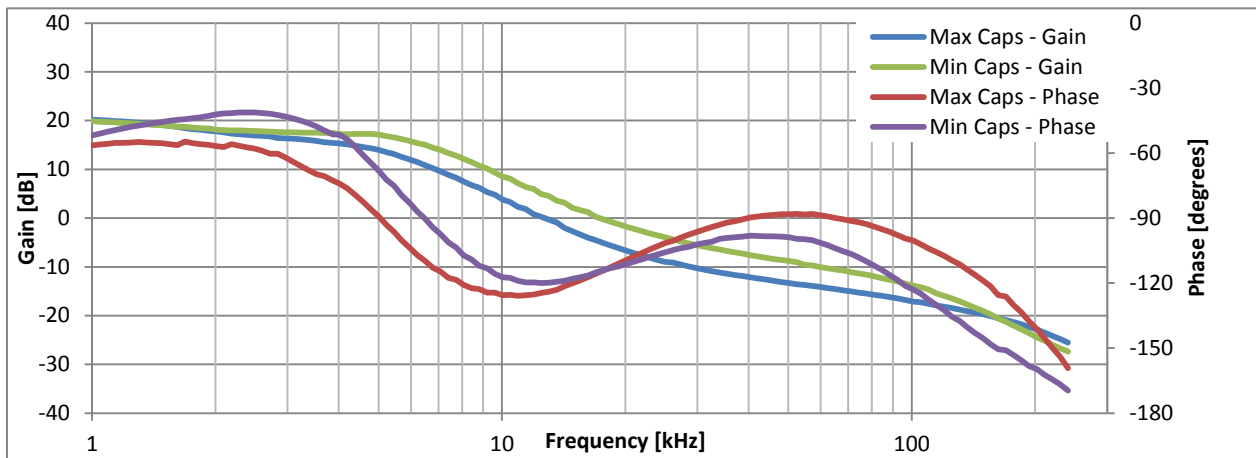

Figure 5.115 Open Loop Bode Plots for ZSPM1506 with Comp2



5.24. ZSPM1506 – Typical Load Transient Response – Capacitor Range #4 – Comp3

Test conditions: $V_{IN} = 12.0V$, $V_{OUT} = 2.00V$

Minimum output capacitance: $5 \times 100\mu F/6.3V \text{ X5R} + 4 \times 470\mu F/7m\Omega$

Maximum output capacitance: $8 \times 100\mu F/6.3V \text{ X5R} + 4 \times 47\mu F/10V \text{ X7R} + 6 \times 470\mu F/7m\Omega$

Figure 5.116 ZSPM1506 with Comp3; 5A to 15A Load Step; and Min. Capacitance

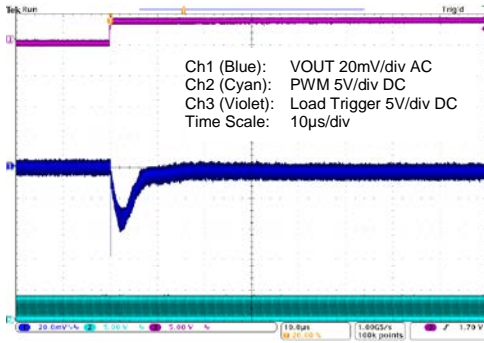

Figure 5.117 ZSPM1506 with Comp3; 15A to 5A Load Step; and Min. Capacitance

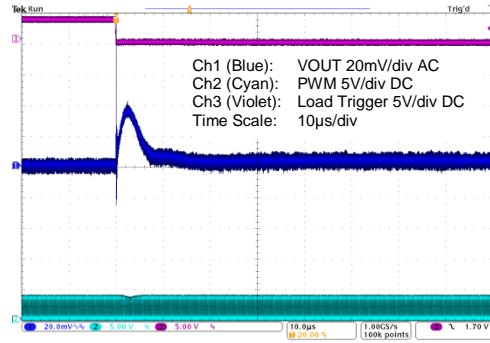

Figure 5.118 ZSPM1506 with Comp3; 5A to 15A Load Step; and Max. Capacitance

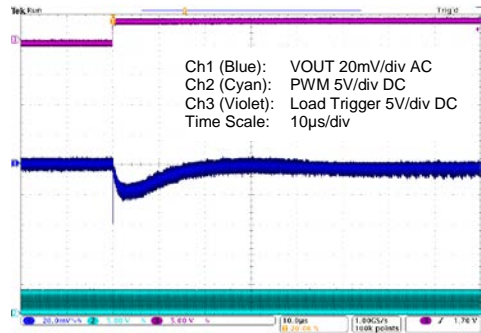

Figure 5.119 ZSPM1506 with Comp3; 15A to 5A Load Step; and Max. Capacitance

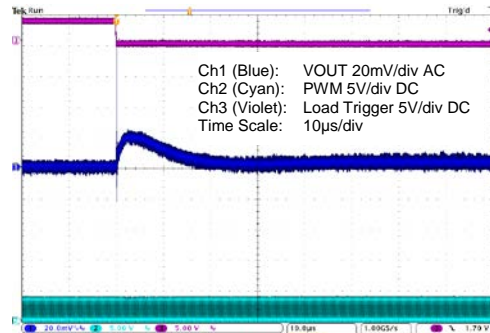
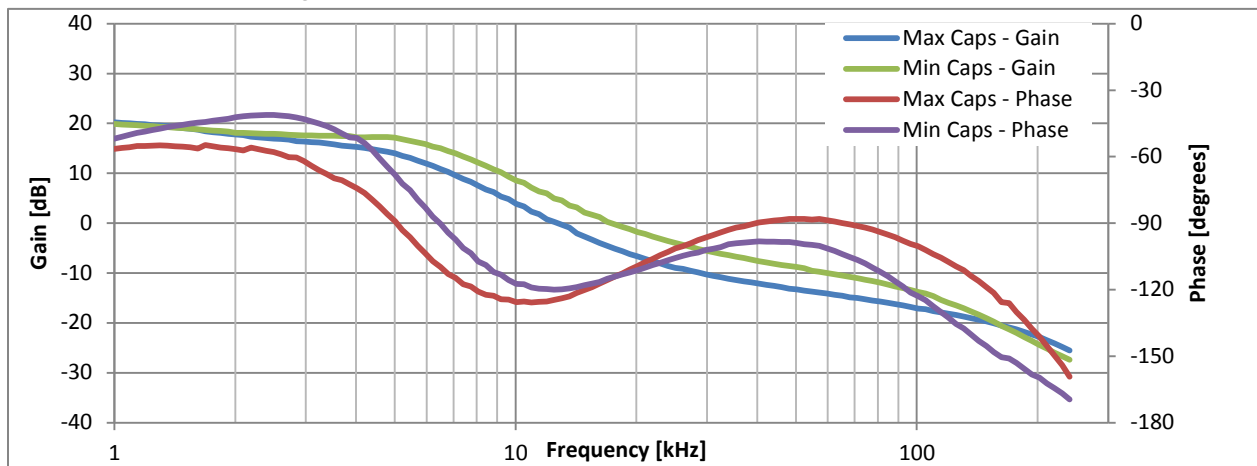
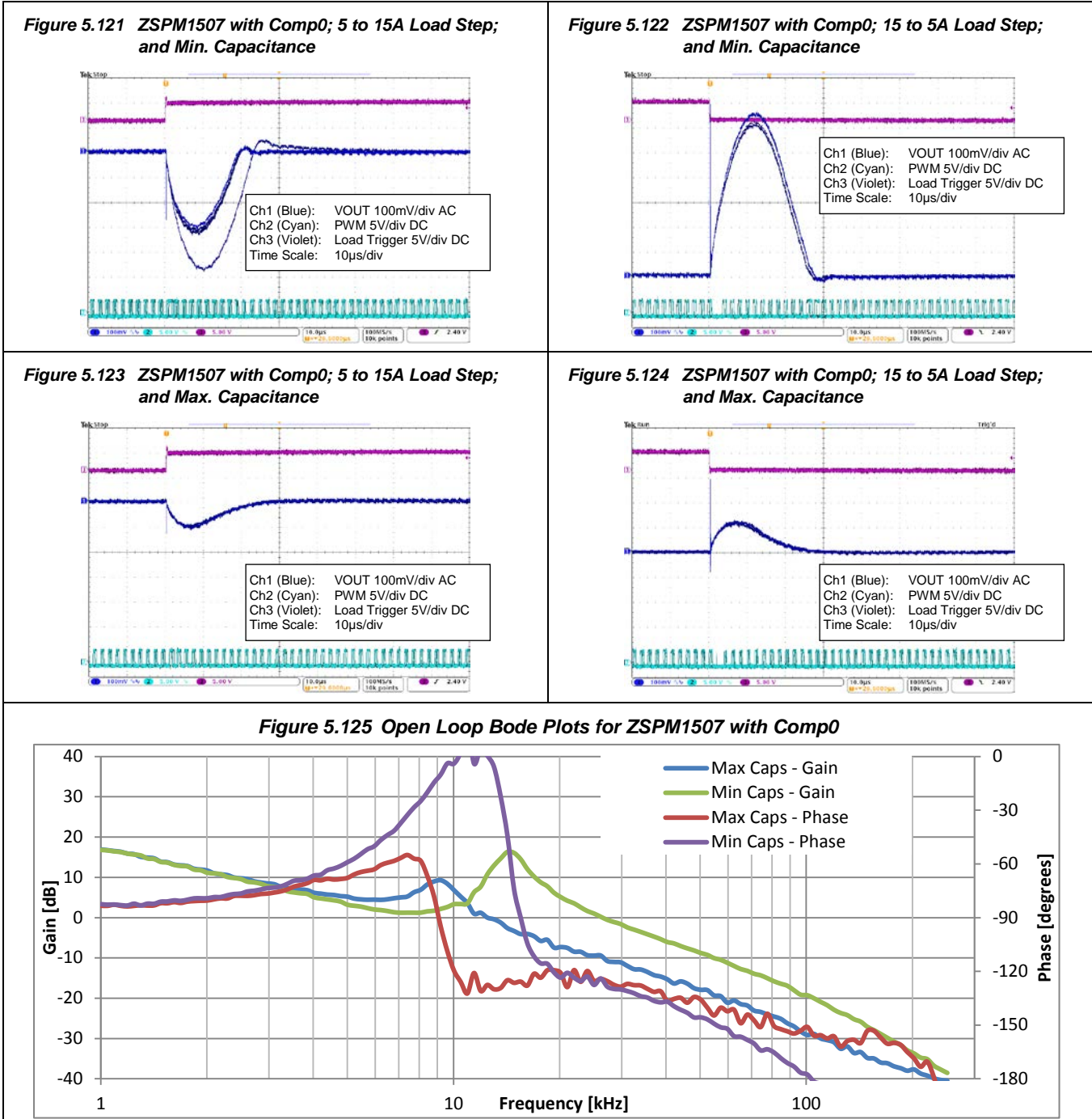

Figure 5.120 Open Loop Bode Plots for ZSPM1506 with Comp3



5.25. ZSPM1507 – Typical Load Transient Response –Capacitor Range 1 – Comp0

Test conditions: $V_{IN} = 12.0V$, $V_{OUT} = 2.50V$
 Minimum output capacitance: $2 \times 100\mu F/6.3V \text{ X5R}$
 Maximum output capacitance: $4 \times 100\mu F/6.3V \text{ X5R} + 2 \times 47\mu F/10V \text{ X7R}$



5.26. ZSPM1507 – Typical Load Transient Response –Capacitor Range 2 – Comp1

Test conditions: $V_{IN} = 12.0V$, $V_{OUT} = 2.50V$

Minimum output capacitance: $5 \times 100\mu F/6.3V \times 5R$

Maximum output capacitance: $8 \times 100\mu F/6.3V \times 5R + 4 \times 47\mu F/10V \times 7R$

Figure 5.126 ZSPM1507 with Comp1; 5 to 15A Load Step; and Min. Capacitance

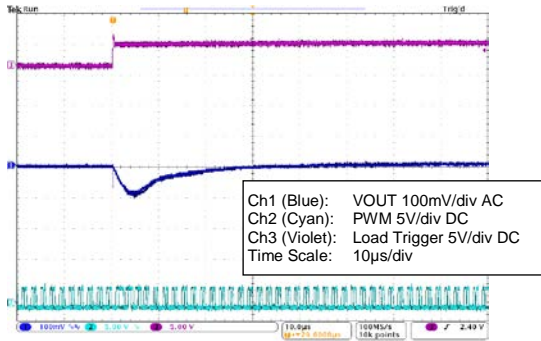

Figure 5.127 ZSPM1507 with Comp1; 15 to 5A Load Step; and Min. Capacitance

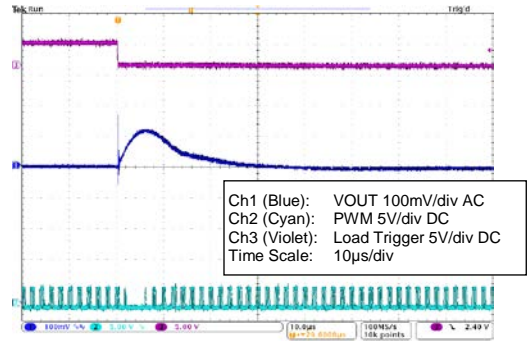

Figure 5.128 ZSPM1507 with Comp1; 5 to 15A Load Step; and Max. Capacitance

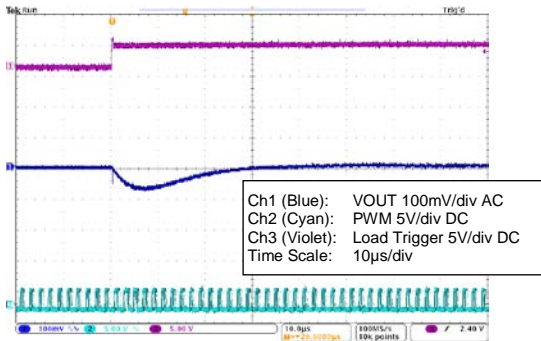

Figure 5.129 ZSPM1507 with Comp1; 15 to 5A Load Step; and Max. Capacitance

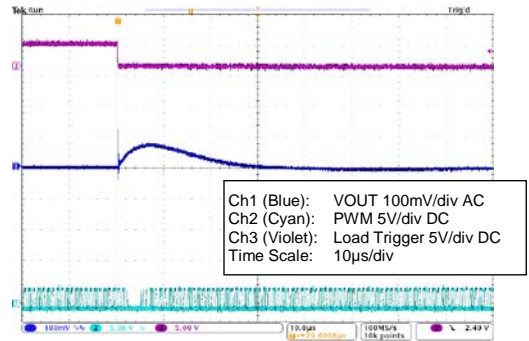
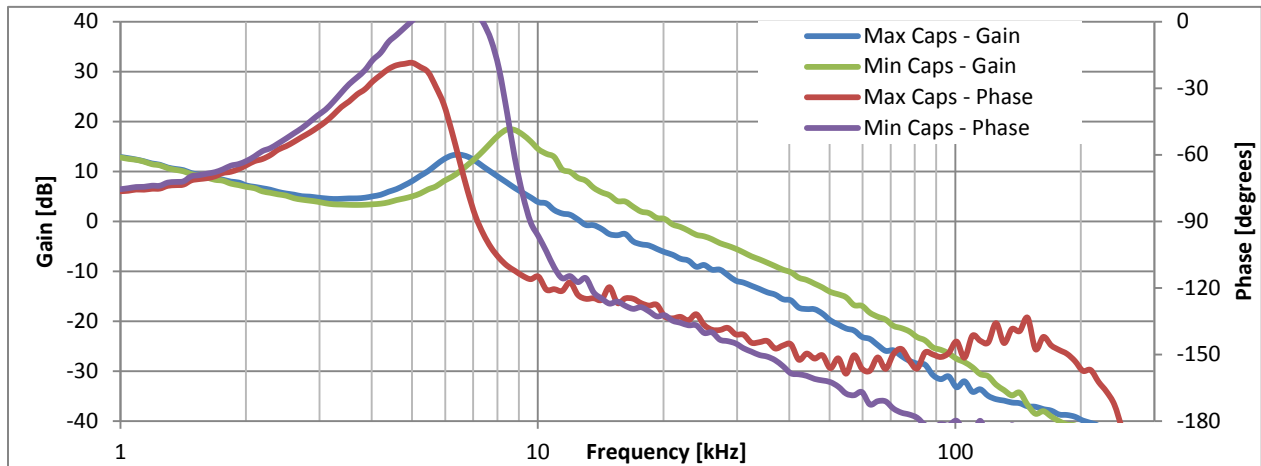

Figure 5.130 Open Loop Bode Plots for ZSPM1507 with Comp1



5.27. ZSPM1507 – Typical Load Transient Response –Capacitor Range 3 – Comp2

Test conditions: $V_{IN} = 12.0V$, $V_{OUT} = 2.50V$

Minimum output capacitance: $2 \times 100\mu F/6.3V \text{ X5R} + 2 \times 470\mu F/7m\Omega$

Maximum output capacitance: $4 \times 100\mu F/6.3V \text{ X5R} + 2 \times 47\mu F/10V \text{ X7R} + 4 \times 470\mu F/7m\Omega$

Figure 5.131 ZSPM1507 with Comp2; 5 to 15A Load Step; and Min. Capacitance

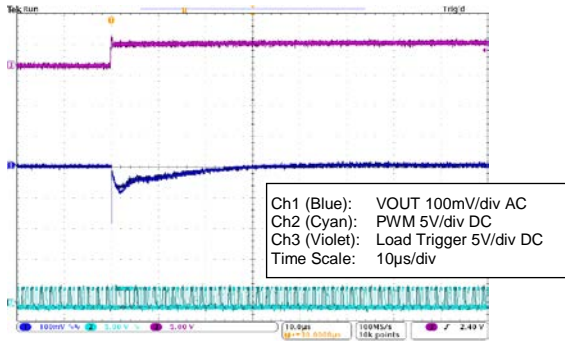

Figure 5.132 ZSPM1507 with Comp2; 15 to 5A Load Step; and Min. Capacitance

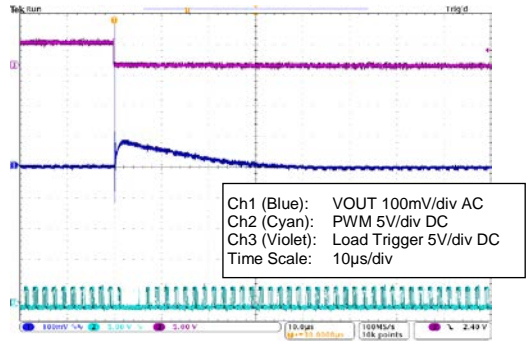

Figure 5.133 ZSPM1507 with Comp2; 5 to 15A Load Step; and Max. Capacitance

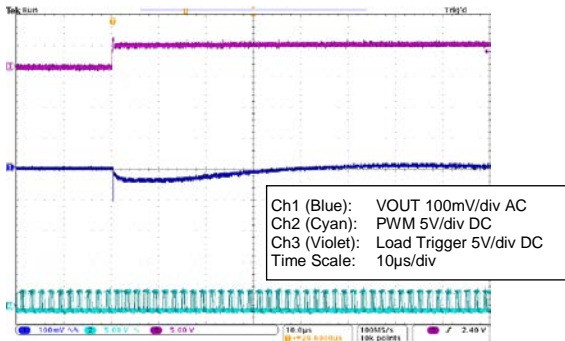

Figure 5.134 ZSPM1507 with Comp2; 15 to 5A Load Step; and Max. Capacitance

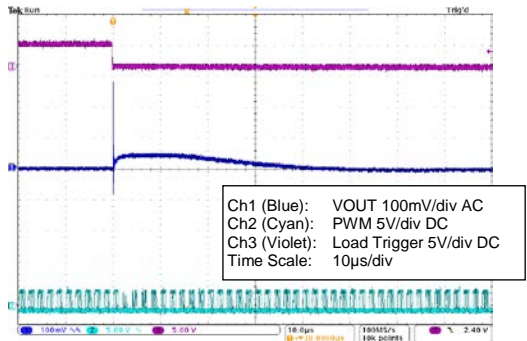
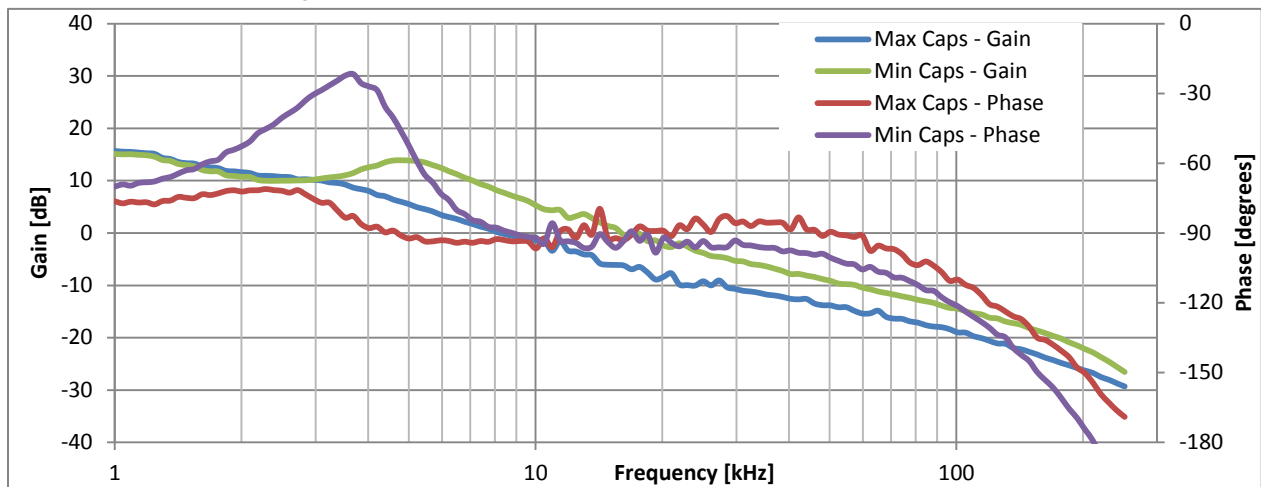

Figure 5.135 Open Loop Bode Plots for ZSPM1507 with Comp2



5.28. ZSPM1507 – Typical Load Transient Response –Capacitor Range 4 – Comp3

Test conditions: $V_{IN} = 12.0V$, $V_{OUT} = 2.50V$

Minimum output capacitance: $5 \times 100\mu F/6.3V \text{ X5R} + 4 \times 470\mu F/7m\Omega$

Maximum output capacitance: $8 \times 100\mu F/6.3V \text{ X5R} + 4 \times 47\mu F/10V \text{ X7R} + 6 \times 470\mu F/7m\Omega$

Figure 5.136 ZSPM1507 with Comp3; 5 to 15A Load Step; and Min. Capacitance

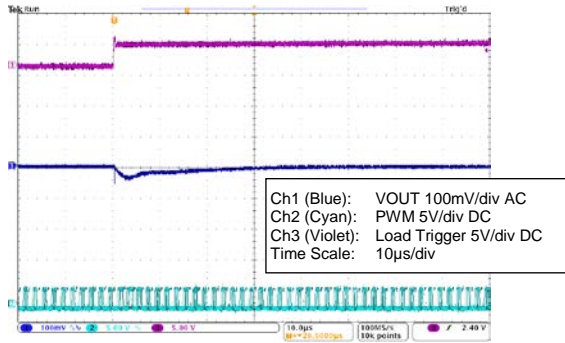

Figure 5.137 ZSPM1507 with Comp3; 15 to 5A Load Step; and Min. Capacitance

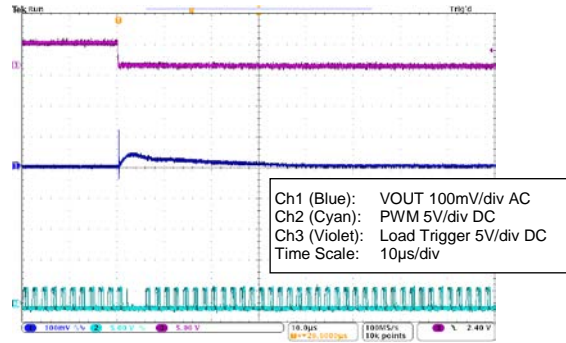

Figure 5.138 ZSPM1507 with Comp3; 5 to 15A Load Step; and Max. Capacitance

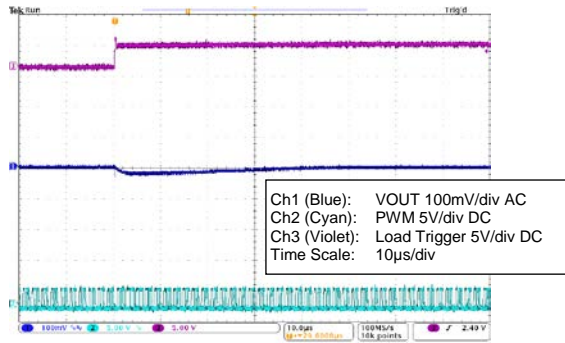

Figure 5.139 ZSPM1507 with Comp3; 15 to 5A Load Step; and Max. Capacitance

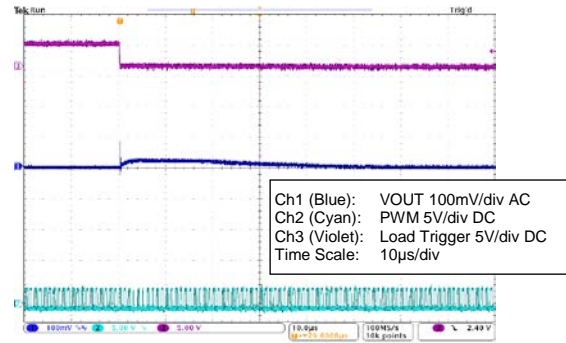
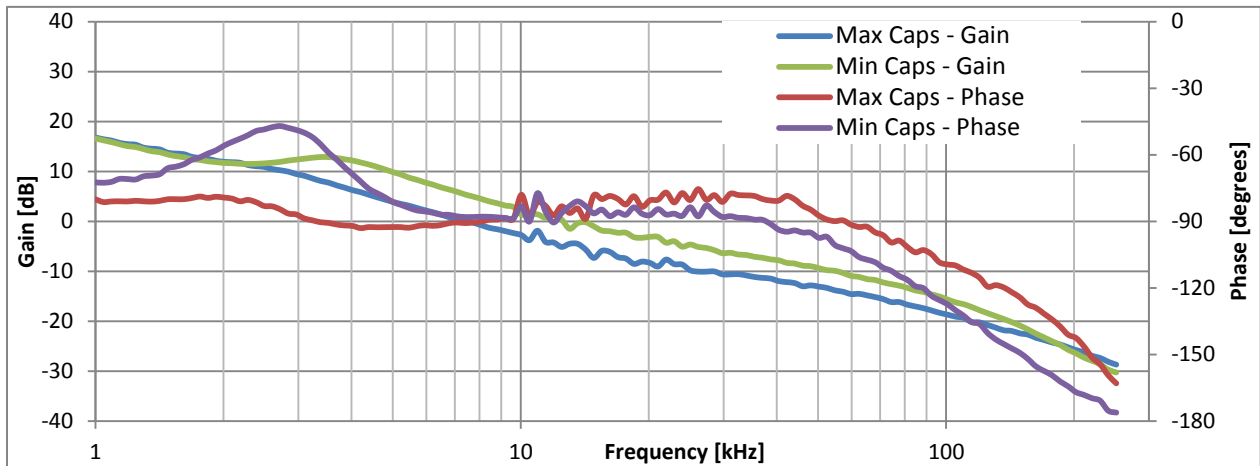

Figure 5.140 Open Loop Bode Plots for ZSPM1507 with Comp3



5.29. ZSPM1508 – Typical Load Transient Response –Capacitor Range 1 – Comp0

Test conditions: $V_{IN} = 12.0V$, $V_{OUT} = 3.30V$

Minimum output capacitance: $2 \times 100\mu F/10V \text{ X5R}$

Maximum output capacitance: $4 \times 100\mu F/10V \text{ X5R} + 2 \times 47\mu F/10V \text{ X7R}$

Figure 5.141 ZSPM1508 with Comp0; 5A to 10A Load Step; and Min. Capacitance

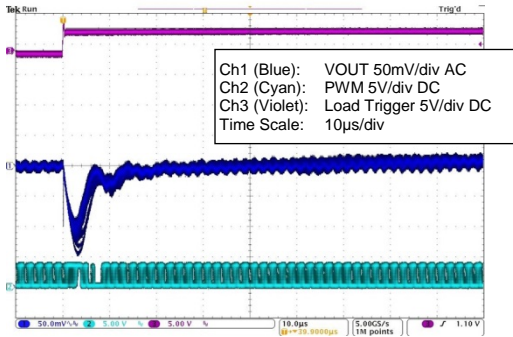

Figure 5.142 ZSPM1508 with Comp0; 10A to 5A Load Step; and Min. Capacitance

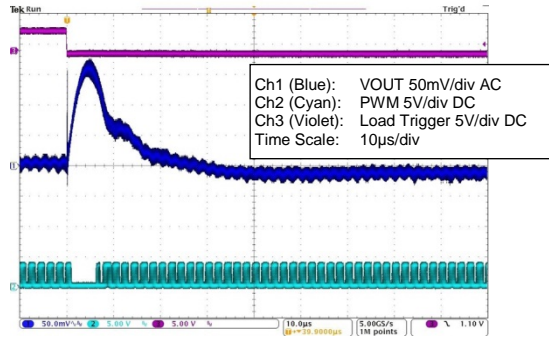

Figure 5.143 ZSPM1508 with Comp0; 5A to 10A Load Step; and Max. Capacitance

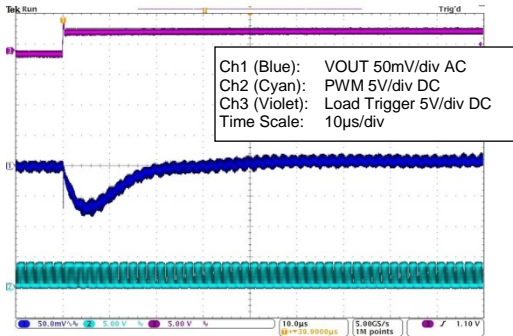

Figure 5.144 ZSPM1508 with Comp0; 10A to 5A Load Step; and Max. Capacitance

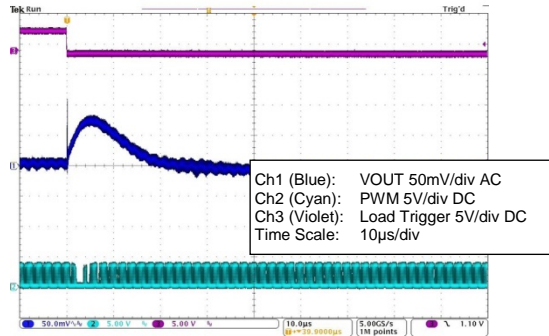
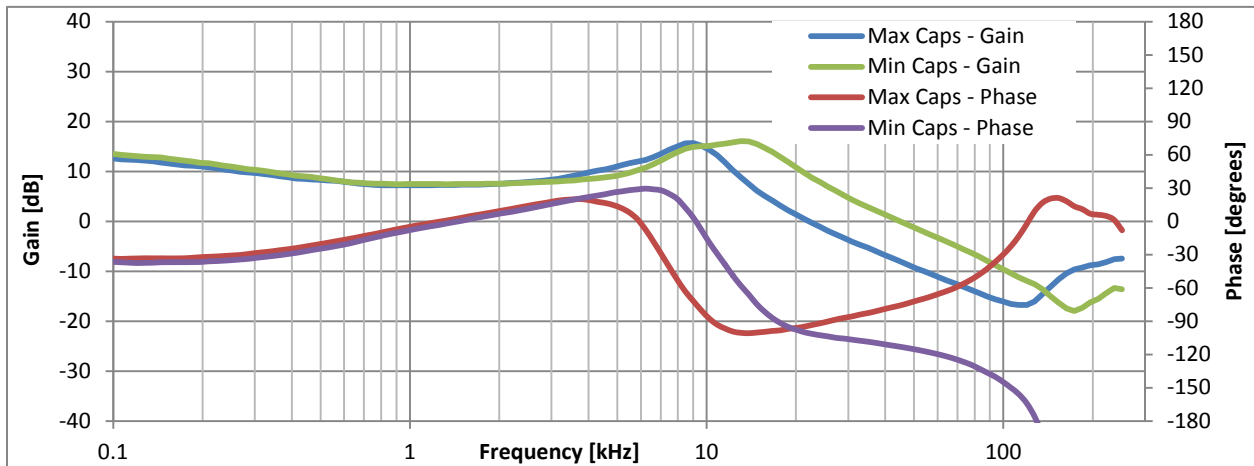

Figure 5.145 Open Loop Bode Plots for ZSPM1508 with Comp0



5.30. ZSPM1508 – Typical Load Transient Response –Capacitor Range 2 – Comp1

Test conditions: $V_{IN} = 12.0V$, $V_{OUT} = 3.30V$

Minimum output capacitance: $5 \times 100\mu F/10V \text{ X5R}$

Maximum output capacitance: $8 \times 100\mu F/10V \text{ X5R} + 4 \times 47\mu F/10V \text{ X7R}$

Figure 5.146 ZSPM1508 with Comp1; 5A to 10A Load Step; and Min. Capacitance

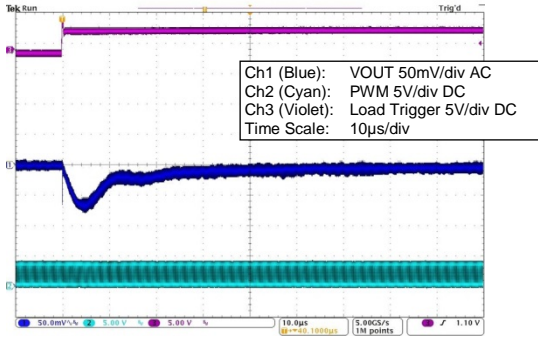

Figure 5.147 ZSPM1508 with Comp1; 10A to 5A Load Step; and Min. Capacitance

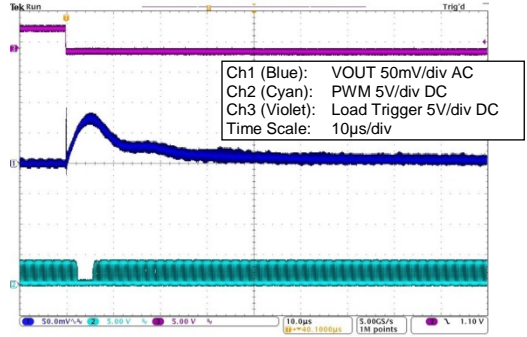

Figure 5.148 ZSPM1508 with Comp1; 5A to 10A Load Step; and Max. Capacitance

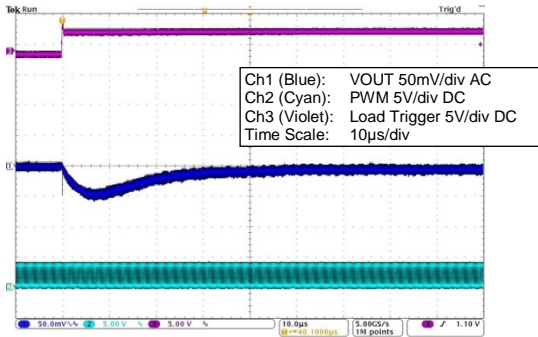

Figure 5.149 ZSPM1508 with Comp1; 10A to 5A Load Step; and Max. Capacitance

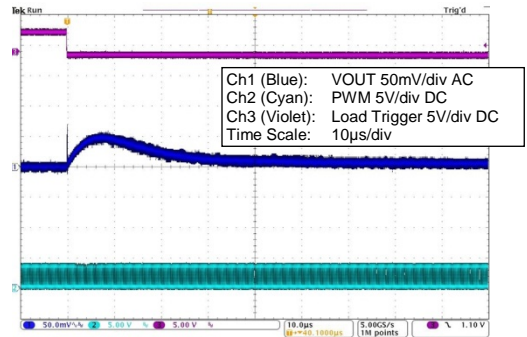
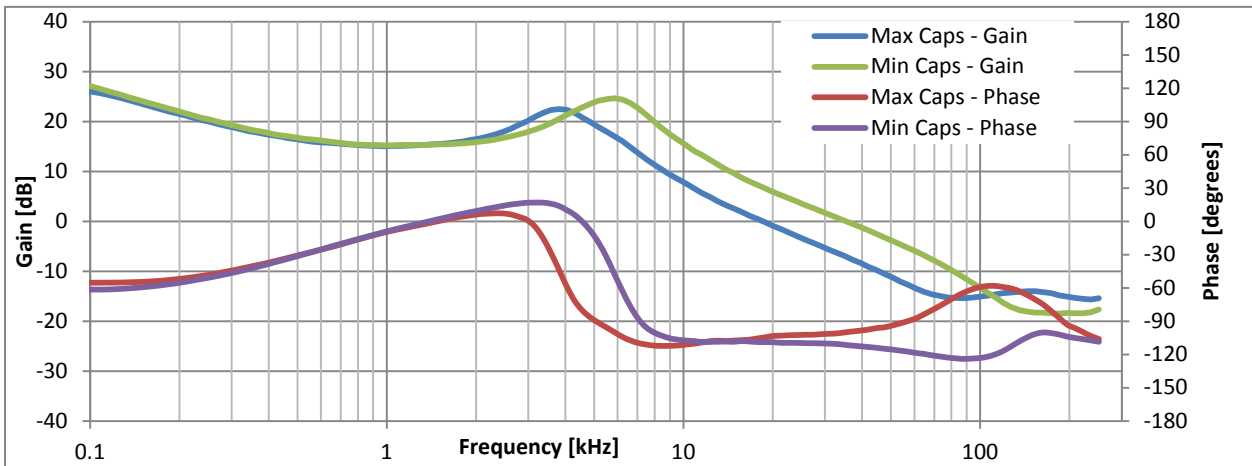

Figure 5.150 Open Loop Bode Plots for ZSPM1508 with Comp1



5.31. ZSPM1508 – Typical Load Transient Response –Capacitor Range 3 – Comp2

Test conditions: $V_{IN} = 12.0V$, $V_{OUT} = 3.30V$

Minimum output capacitance: $2 \times 100\mu F/10V \text{ X5R} + 2 \times 470\mu F/7m\Omega$

Maximum output capacitance: $4 \times 100\mu F/10V \text{ X5R} + 2 \times 47\mu F/10V \text{ X7R} + 4 \times 470\mu F/7m\Omega$

Figure 5.151 ZSPM1508 with Comp2; 5A to 10A Load Step; and Min. Capacitance

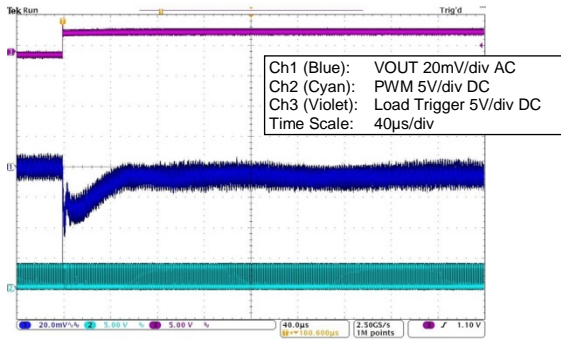

Figure 5.152 ZSPM1508 with Comp2; 10A to 5A Load Step; and Min. Capacitance

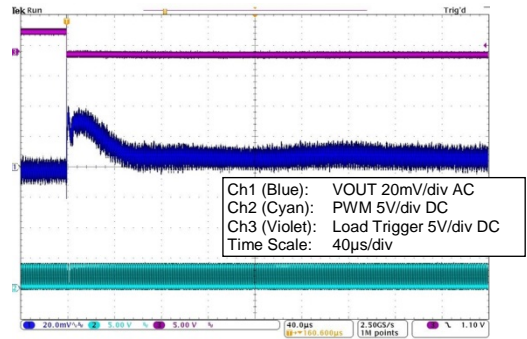

Figure 5.153 ZSPM1508 with Comp2; 5A to 10A Load Step; and Max. Capacitance

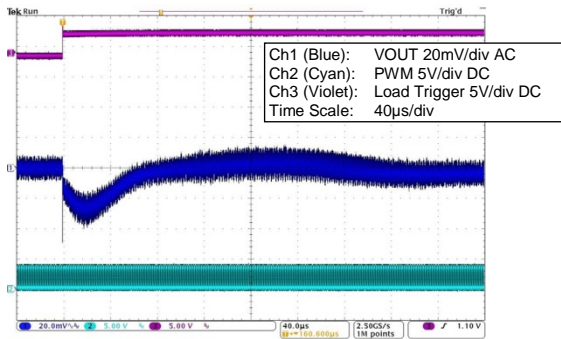

Figure 5.154 ZSPM1508 with Comp2; 10A to 5A Load Step; and Max. Capacitance

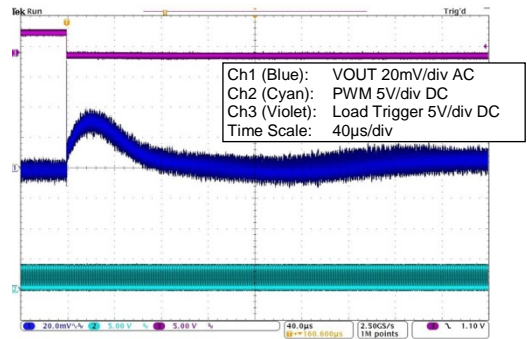
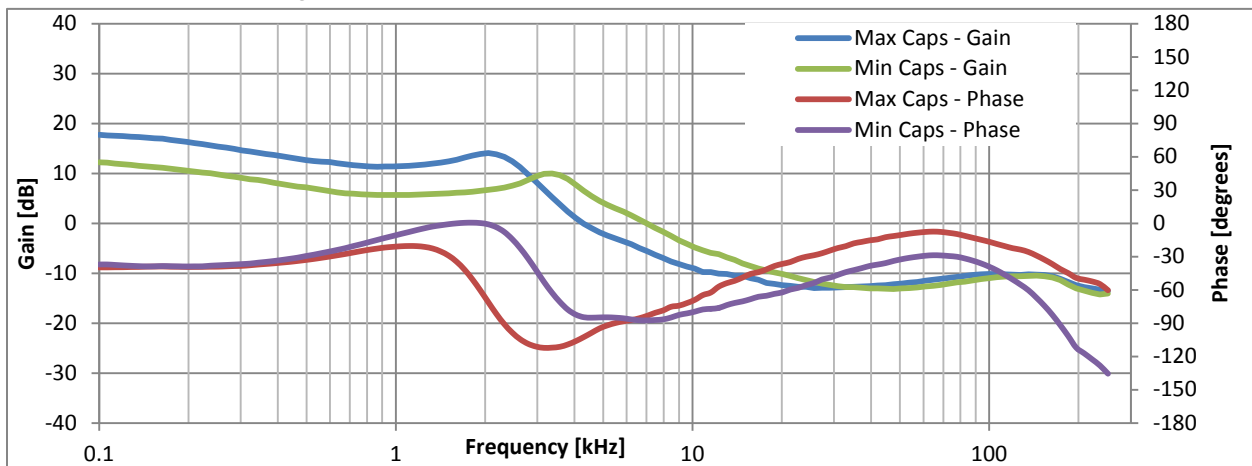

Figure 5.155 Open Loop Bode Plots for ZSPM1508 with Comp2



5.32. ZSPM1508 – Typical Load Transient Response –Capacitor Range 4 – Comp3

Test conditions: $V_{IN} = 12.0V$, $V_{OUT} = 3.30V$

Minimum output capacitance: $5 \times 100\mu F/10V \text{ X5R} + 4 \times 470\mu F/7m\Omega$

Maximum output capacitance: $8 \times 100\mu F/10V \text{ X5R} + 4 \times 47\mu F/10V \text{ X7R} + 6 \times 470\mu F/7m\Omega$

Figure 5.156 ZSPM1508 with Comp3; 5A to 10A Load Step; and Min. Capacitance

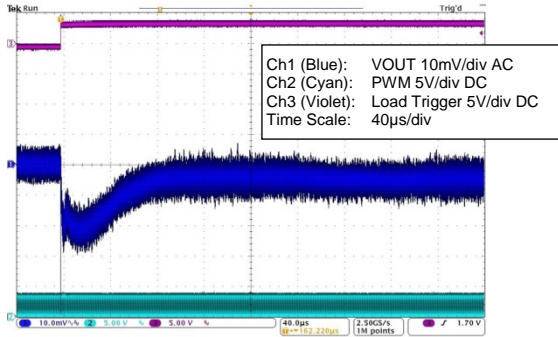

Figure 5.157 ZSPM1508 with Comp3; 10A to 5A Load Step; and Min. Capacitance

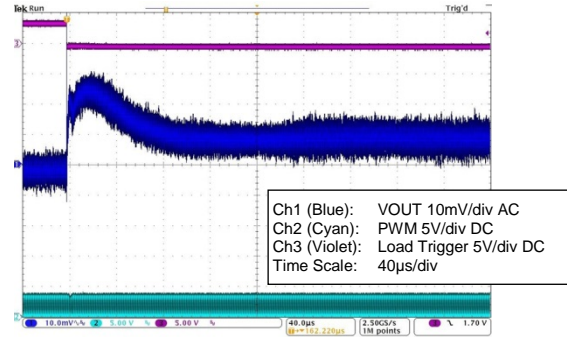

Figure 5.158 ZSPM1508 with Comp3; 5A to 10A Load Step; and Max. Capacitance

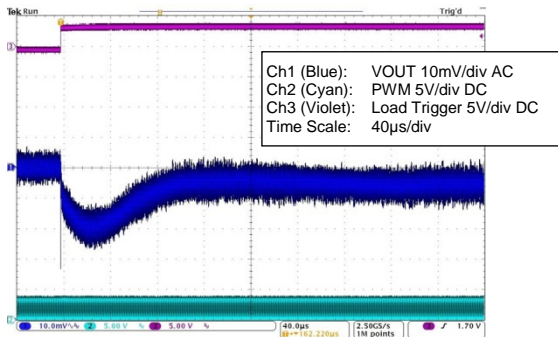

Figure 5.159 ZSPM1508 with Comp3; 10A to 5A Load Step; and Max. Capacitance

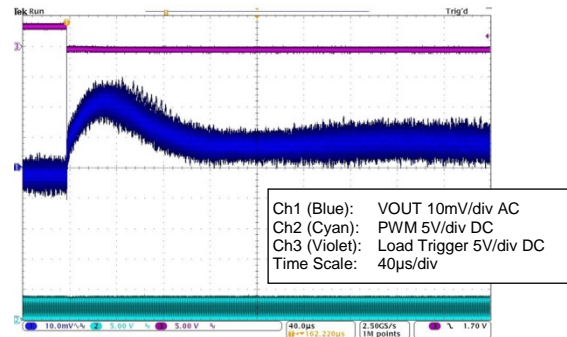
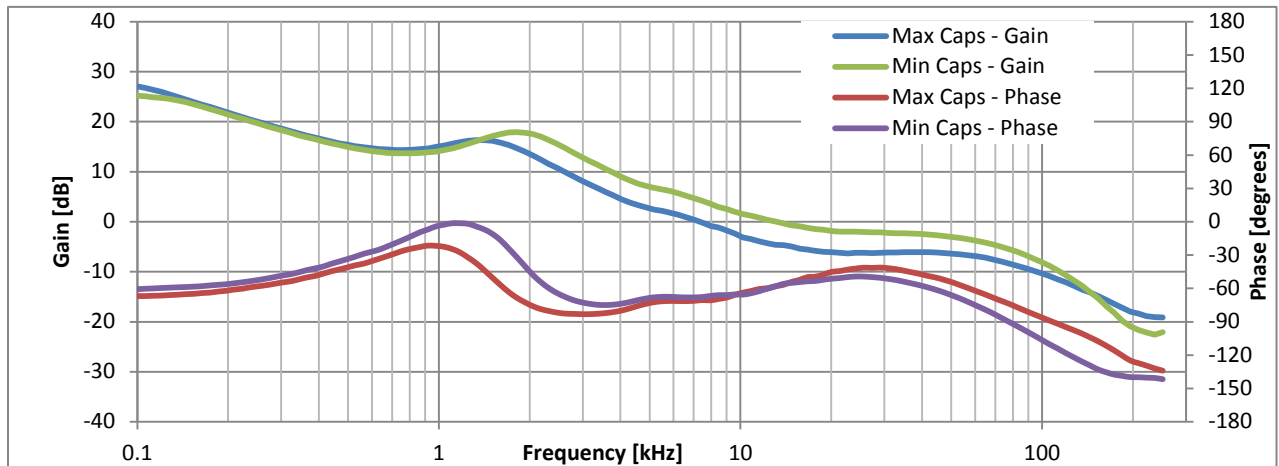

Figure 5.160 Open Loop Bode Plots for ZSPM1508 with Comp3



5.33. ZSPM1509 – Typical Load Transient Response –Capacitor Range 1 – Comp0

Test conditions: $V_{IN} = 12.0V$, $V_{OUT} = 5.00V$

Minimum output capacitance: $2 \times 100\mu F/10 \text{ X5R}$

Maximum output capacitance: $4 \times 100\mu F/10V \text{ X5R} + 2 \times 47\mu F/10V \text{ X7R}$

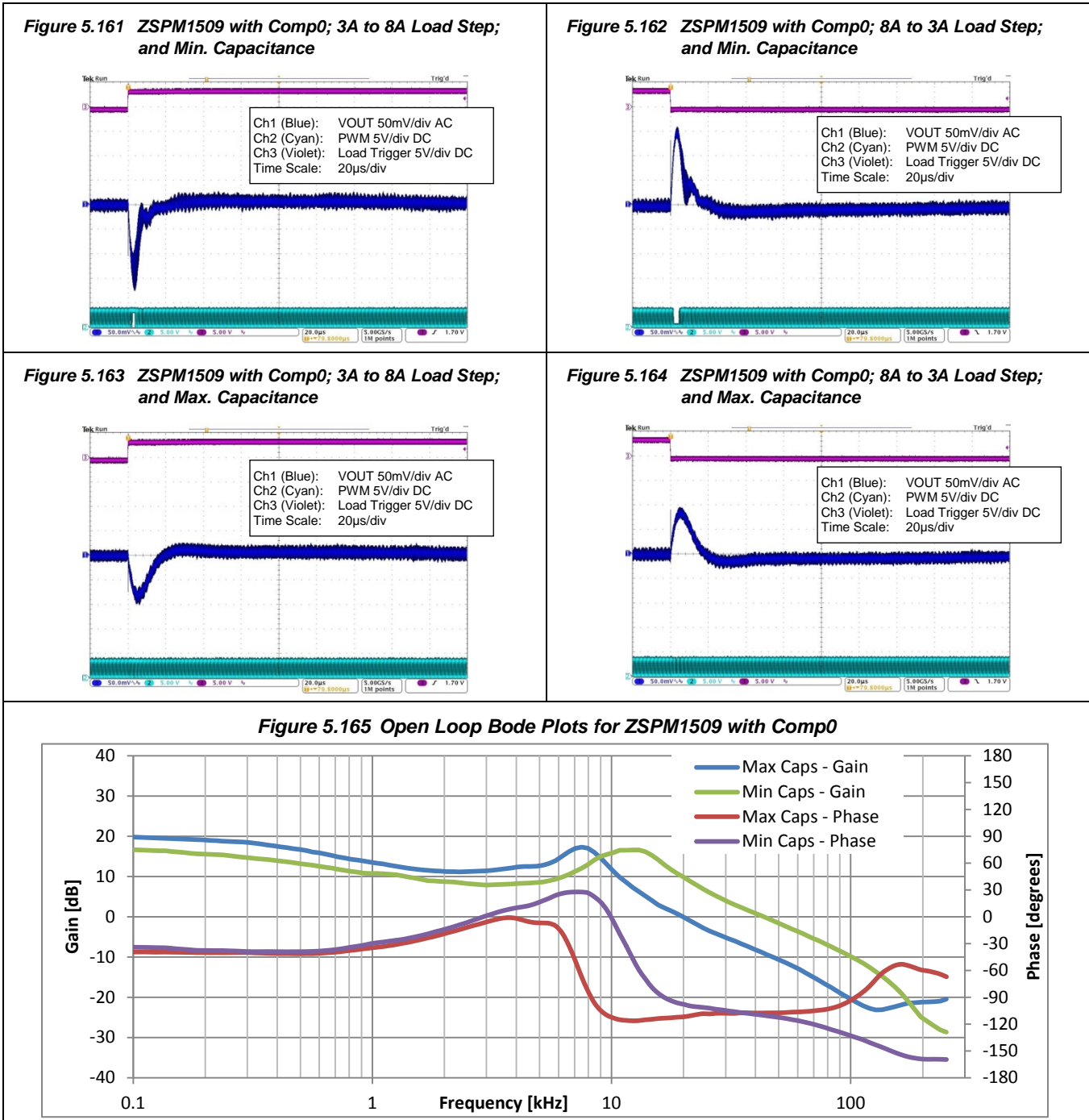

5.34. ZSPM1509 – Typical Load Transient Response –Capacitor Range 2 – Comp1

Test conditions: $V_{IN} = 12.0V$, $V_{OUT} = 5.00V$

Minimum output capacitance: $5 \times 100\mu F/10V \text{ X5R}$

Maximum output capacitance: $8 \times 100\mu F/10V \text{ X5R} + 4 \times 47\mu F/10V \text{ X7R}$

Figure 5.166 ZSPM1509 with Comp1; 3A to 8A Load Step; and Min. Capacitance

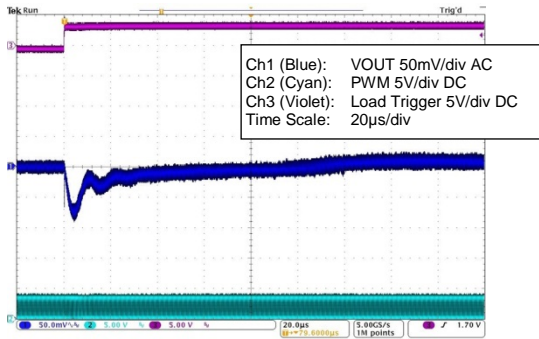

Figure 5.167 ZSPM1509 with Comp1; 8A to 3A Load Step; and Min. Capacitance

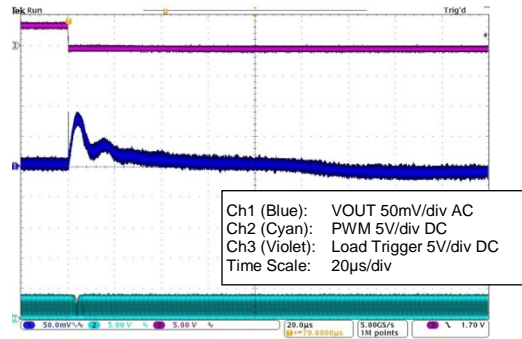

Figure 5.168 ZSPM1509 with Comp1; 3A to 8A Load Step; and Max. Capacitance

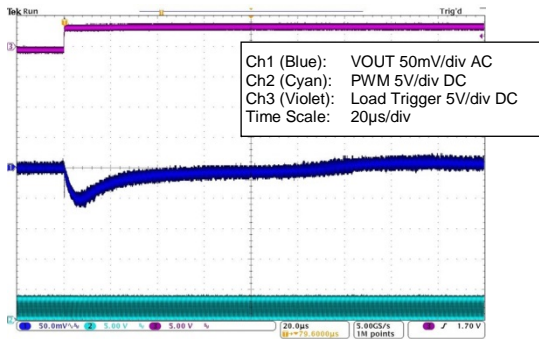

Figure 5.169 ZSPM1509 with Comp1; 8A to 3A Load Step; and Max. Capacitance

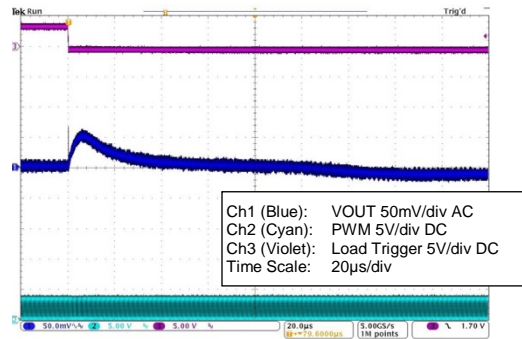
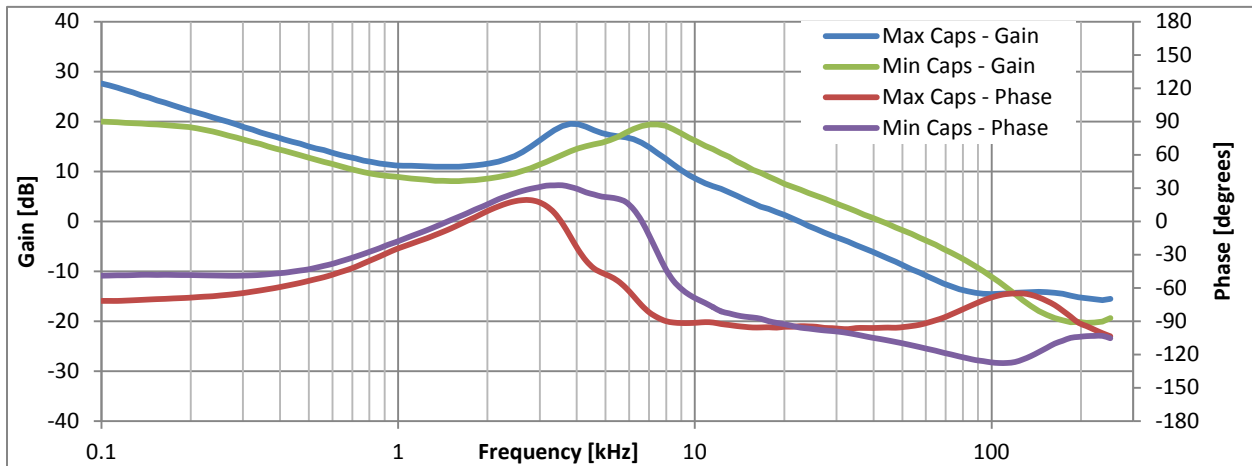

Figure 5.170 Open Loop Bode Plots for ZSPM1509 with Comp1



5.35. ZSPM1509 – Typical Load Transient Response –Capacitor Range 3 – Comp2

Test conditions: $V_{IN} = 12.0V$, $V_{OUT} = 5.00V$

Minimum output capacitance: $2 \times 100\mu F/10V \text{ X5R} + 2 \times 470\mu F/7m\Omega$

Maximum output capacitance: $4 \times 100\mu F/10V \text{ X5R} + 2 \times 47\mu F/10V \text{ X7R} + 4 \times 470\mu F/7m\Omega$

Figure 5.171 ZSPM1509 with Comp2; 3A to 8A Load Step; and Min. Capacitance

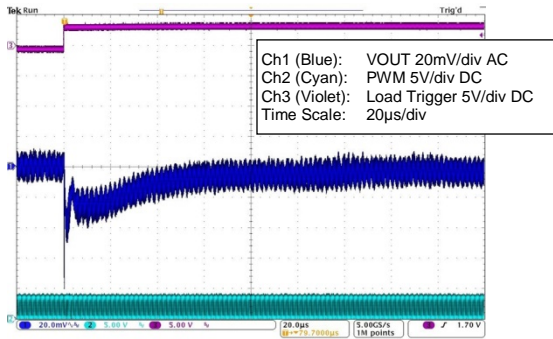

Figure 5.172 ZSPM1509 with Comp2; 8A to 3A Load Step; and Min. Capacitance

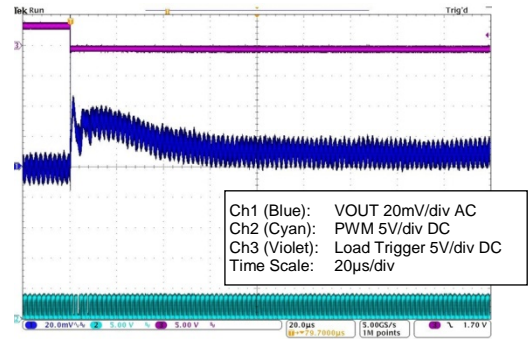

Figure 5.173 ZSPM1509 with Comp2; 3A to 8A Load Step; and Max. Capacitance

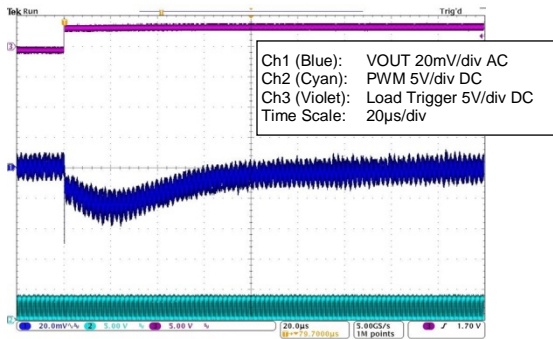

Figure 5.174 ZSPM1509 with Comp2; 8A to 3A Load Step; and Max. Capacitance

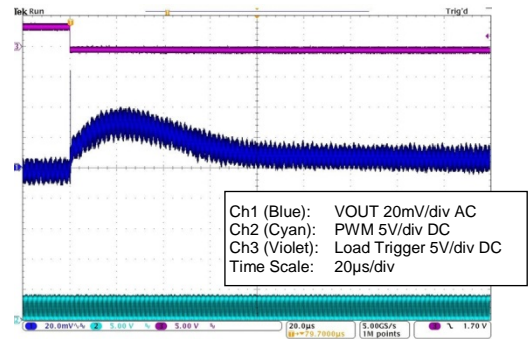
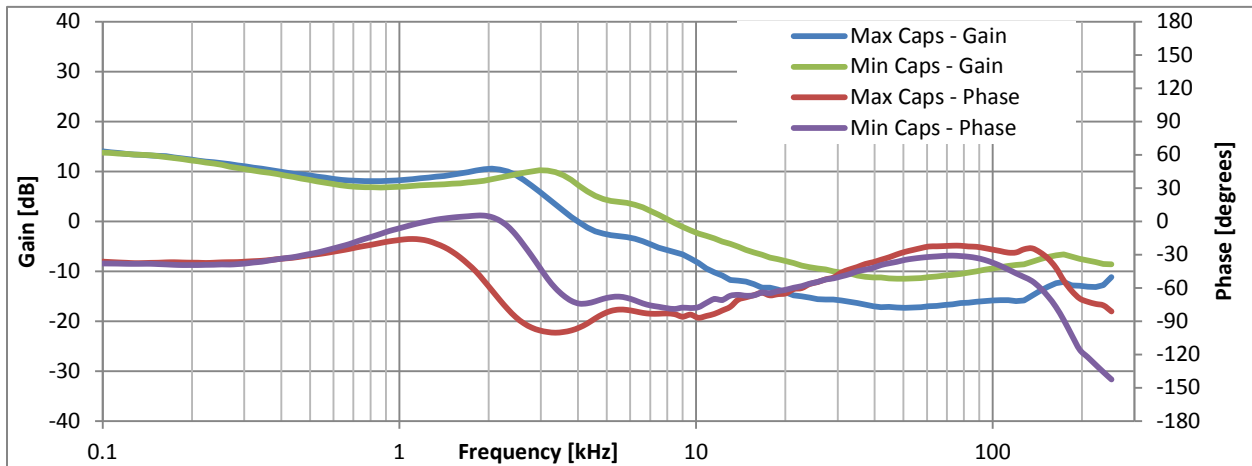

Figure 5.175 Open Loop Bode Plots for ZSPM1509 with Comp2



5.36. ZSPM1509 – Typical Load Transient Response –Capacitor Range 4 – Comp3

Test conditions: $V_{IN} = 12.0V$, $V_{OUT} = 5.00V$

Minimum output capacitance: $5 \times 100\mu F/10V \text{ X5R} + 4 \times 470\mu F/7m\Omega$

Maximum output capacitance: $8 \times 100\mu F/10V \text{ X5R} + 4 \times 47\mu F/10V \text{ X7R} + 6 \times 470\mu F/7m\Omega$

Figure 5.176 ZSPM1509 with Comp3; 3A to 8A Load Step; and Min. Capacitance

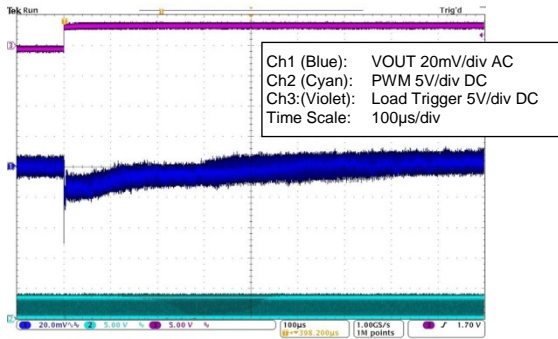

Figure 5.177 ZSPM1509 with Comp3; 8A to 3A Load Step; and Min. Capacitance

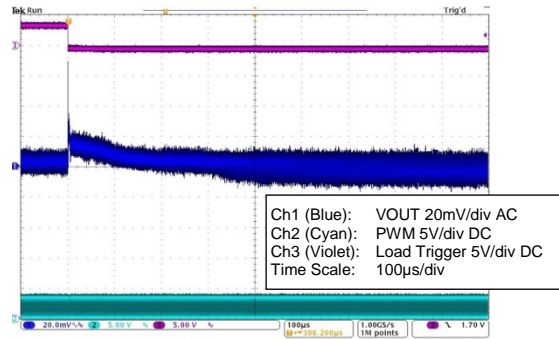

Figure 5.178 ZSPM1509 with Comp3; 3A to 8A Load Step; and Max. Capacitance

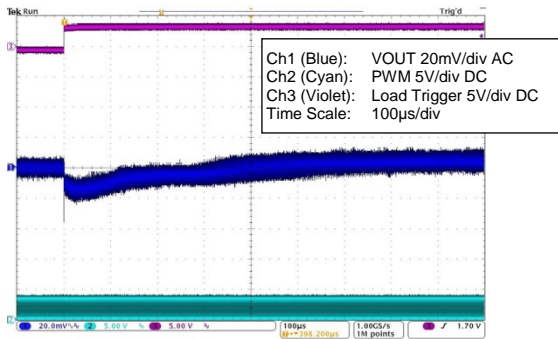

Figure 5.179 ZSPM1509 with Comp3; 8A to 3A Load Step; and Max. Capacitance

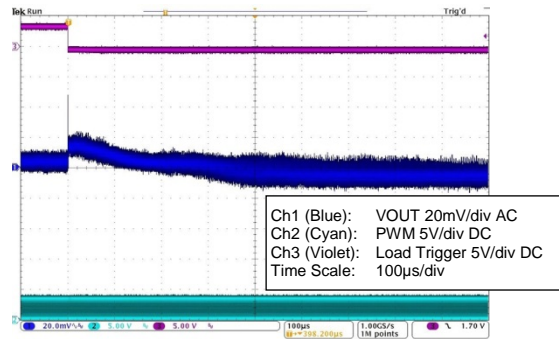
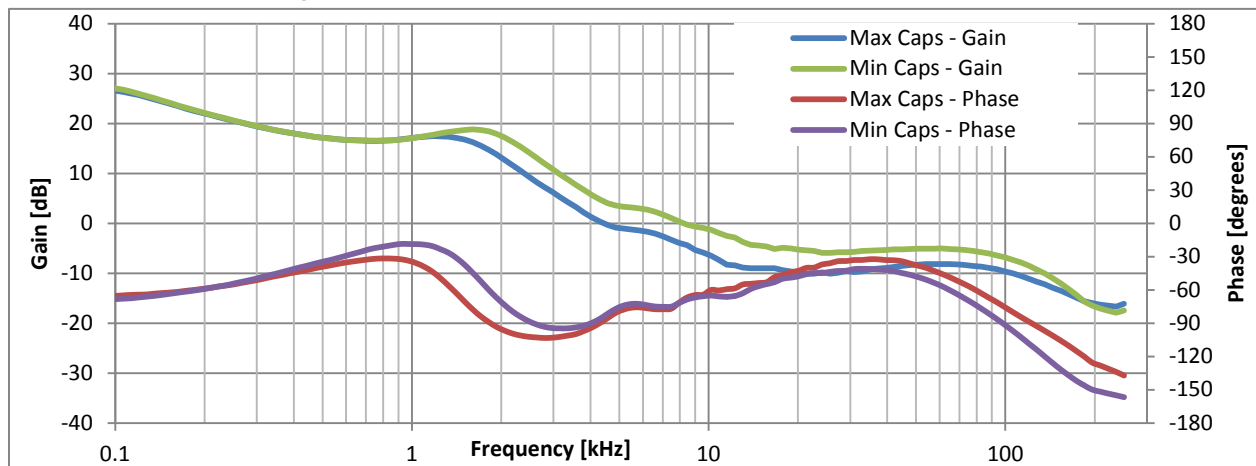

Figure 5.180 Open Loop Bode Plots for ZSPM1509 with Comp3



5.37. ZSPM1511 – Typical Load Transient Response – Capacitor Range #1 – Comp0

Test conditions: $V_{IN} = 12.0V$, $V_{OUT} = 0.85V$

Minimum output capacitance: $2 \times 100\mu F/6.3V \text{ X5R}$

Maximum output capacitance: $4 \times 100\mu F/6.3V \text{ X5R} + 2 \times 47\mu F/10V \text{ X7R}$

Figure 5.181 ZSPM1511 with Comp0; 5A to 15A Load Step; and Min. Capacitance

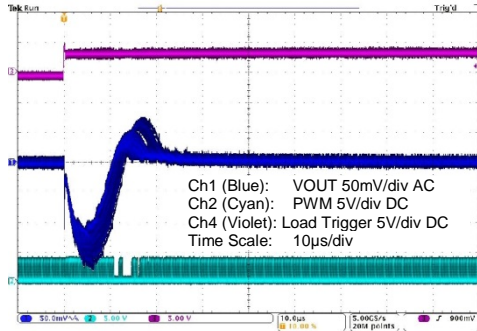

Figure 5.182 ZSPM1511 with Comp0; 15A to 5A Load Step; and Min. Capacitance

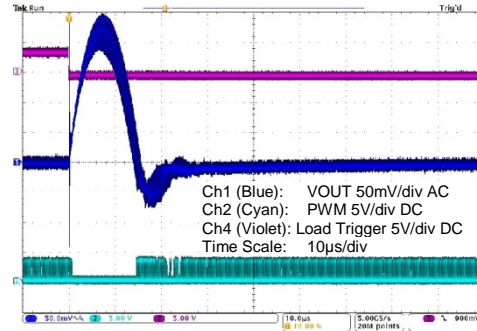

Figure 5.183 ZSPM1511 with Comp0; 5A to 15A Load Step; and Max. Capacitance

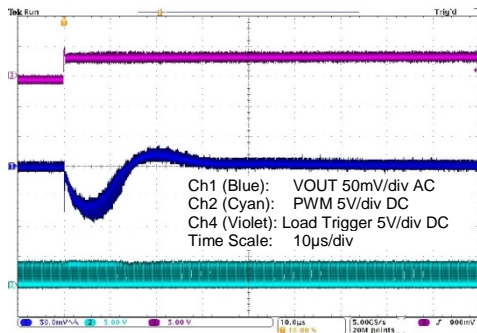

Figure 5.184 ZSPM1511 with Comp0; 15A to 5A Load Step; and Max. Capacitance

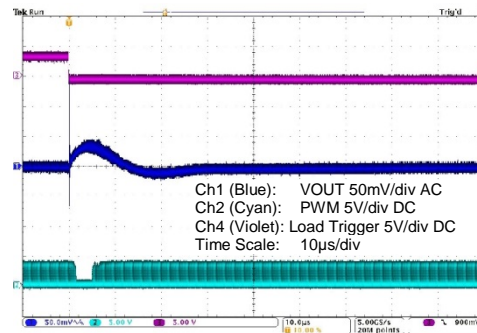
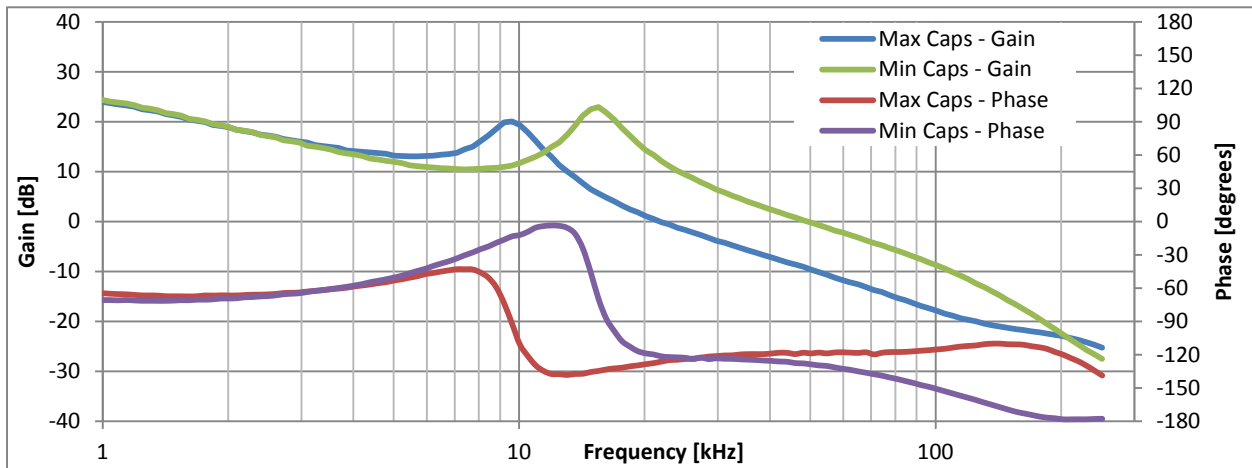

Figure 5.185 Open Loop Bode Plots for ZSPM1511 with Comp0



5.38. ZSPM1511 – Typical Load Transient Response – Capacitor Range #2 – Comp1

Test conditions: $V_{IN} = 12.0V$, $V_{OUT} = 0.85V$

Minimum output capacitance: $5 \times 100\mu F/6.3V \times 5R$

Maximum output capacitance: $8 \times 100\mu F/6.3V \times 5R + 4 \times 47\mu F/10V \times 7R$

Figure 5.186 ZSPM1511 with Comp1; 5A to 15A Load Step; and Min. Capacitance

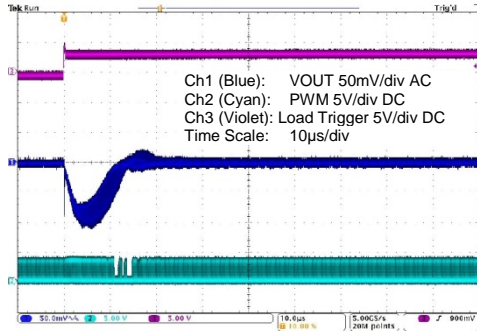

Figure 5.187 ZSPM1511 with Comp1; 15A to 5A Load Step; and Min. Capacitance

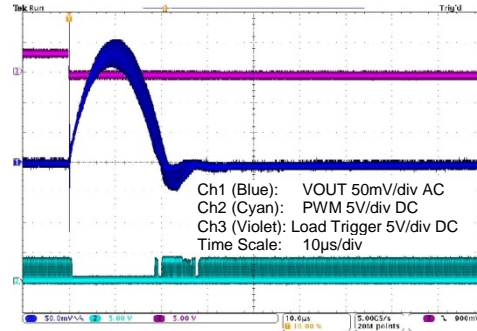

Figure 5.188 ZSPM1511 with Comp1; 5A to 15A Load Step; and Max. Capacitance

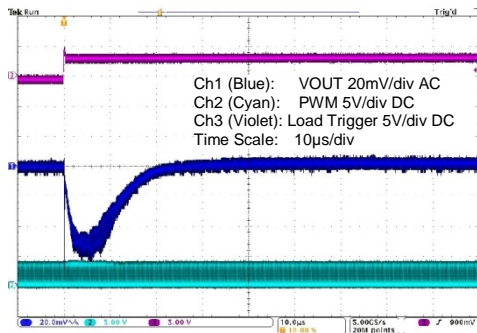

Figure 5.189 ZSPM1511 with Comp1; 15A to 5A Load Step; and Max. Capacitance

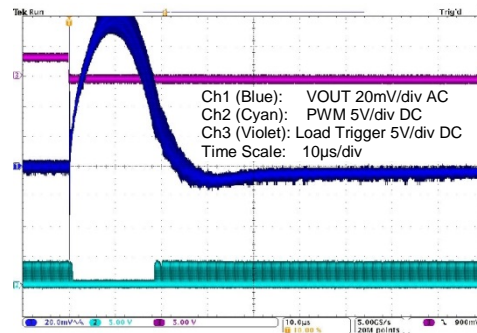
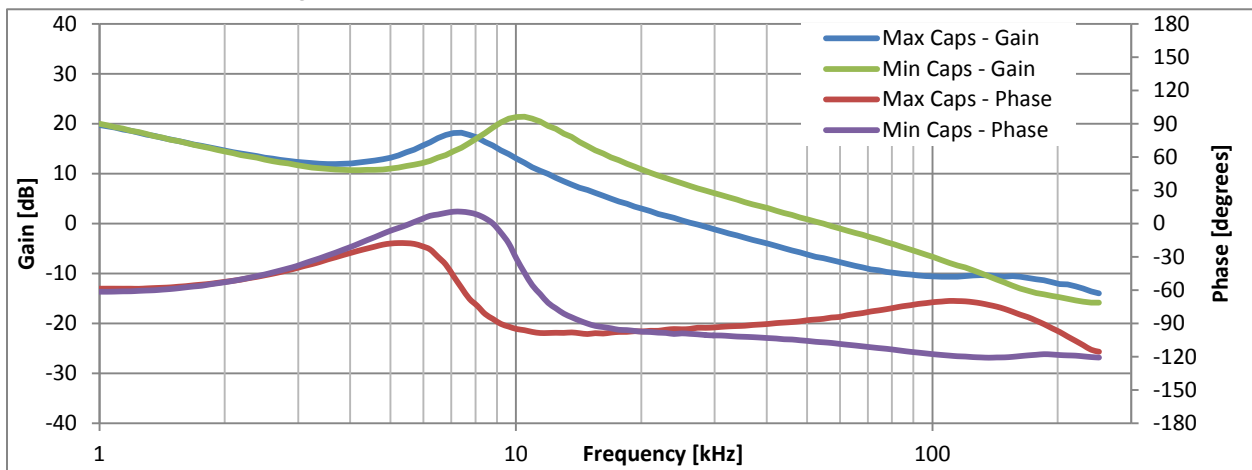

Figure 5.190 Open Loop Bode Plots for ZSPM1511 with Comp1



5.39. ZSPM1511 – Typical Load Transient Response – Capacitor Range #3 – Comp2

Test conditions: $V_{IN} = 12.0V$, $V_{OUT} = 0.85V$

Minimum output capacitance: $2 \times 100\mu F/6.3V \text{ X5R} + 2 \times 470\mu F/7m\Omega$

Maximum output capacitance: $4 \times 100\mu F/6.3V \text{ X5R} + 2 \times 47\mu F/10V \text{ X7R} + 4 \times 470\mu F/7m\Omega$

Figure 5.191 ZSPM1511 with Comp2; 5A to 15A Load Step; and Min. Capacitance

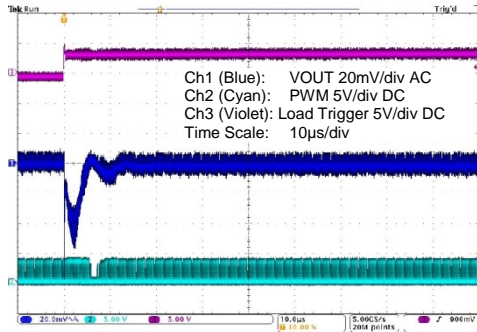

Figure 5.192 ZSPM1511 with Comp2; 15A to 5A Load Step; and Min. Capacitance

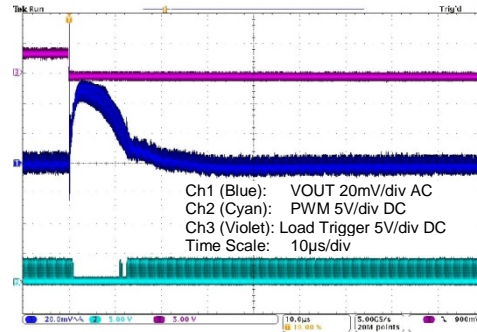

Figure 5.193 ZSPM1511 with Comp2; 5A to 15A Load Step; and Max. Capacitance

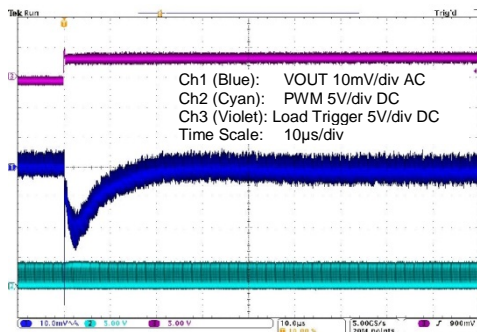

Figure 5.194 ZSPM1511 with Comp2; 15A to 5A Load Step; and Max. Capacitance

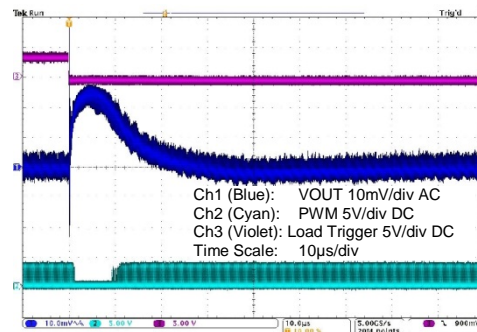
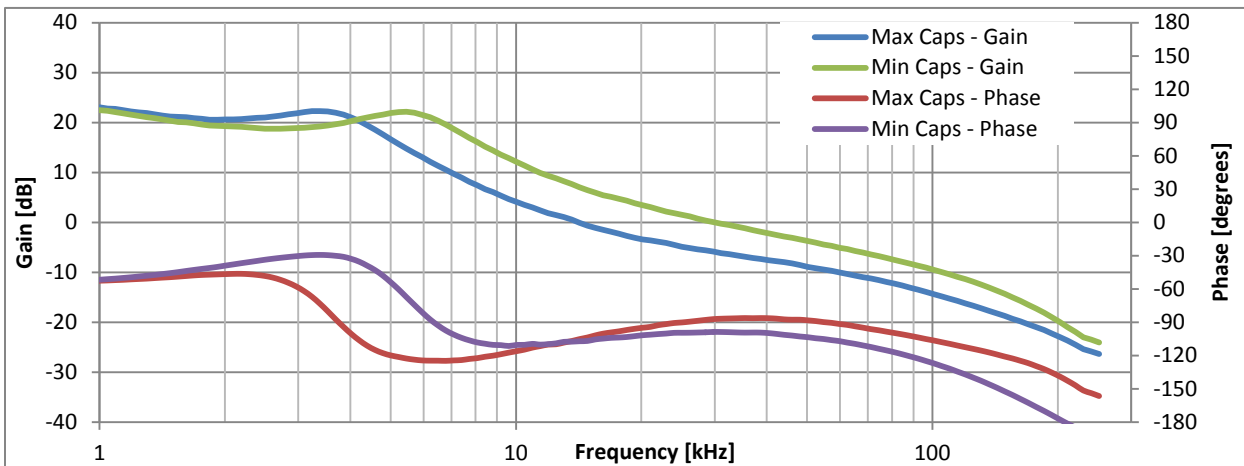

Figure 5.195 Open Loop Bode Plots for ZSPM1511 with Comp2



5.40. ZSPM1511 – Typical Load Transient Response – Capacitor Range #4 – Comp3

Test conditions: $V_{IN} = 12.0V$, $V_{OUT} = 0.85V$

Minimum output capacitance: $5 \times 100\mu F/6.3V \text{ X5R} + 4 \times 470\mu F/7m\Omega$

Maximum output capacitance: $8 \times 100\mu F/6.3V \text{ X5R} + 4 \times 47\mu F/10V \text{ X7R} + 6 \times 470\mu F/7m\Omega$

Figure 5.196 ZSPM1511 with Comp3; 5A to 15A Load Step; and Min. Capacitance

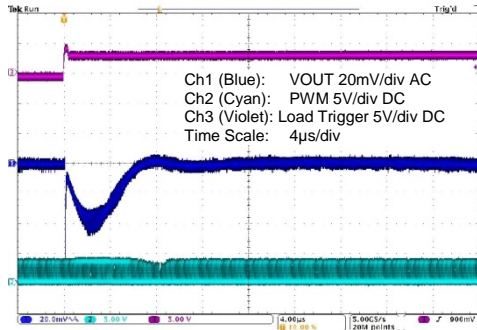

Figure 5.197 ZSPM1511 with Comp3; 15A to 5A Load Step; and Min. Capacitance

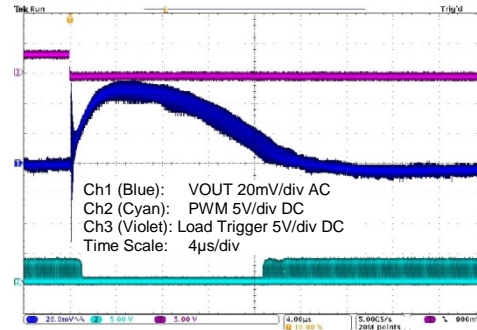

Figure 5.198 ZSPM1511 with Comp3; 5A to 15A Load Step; and Max. Capacitance

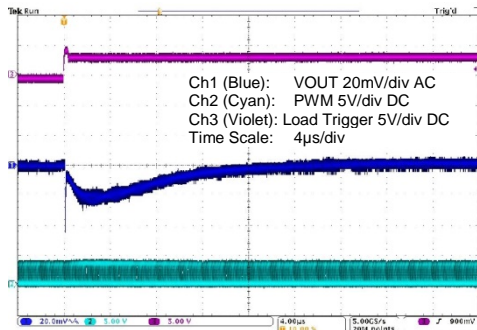

Figure 5.199 ZSPM1511 with Comp3; 15A to 5A Load Step; and Max. Capacitance

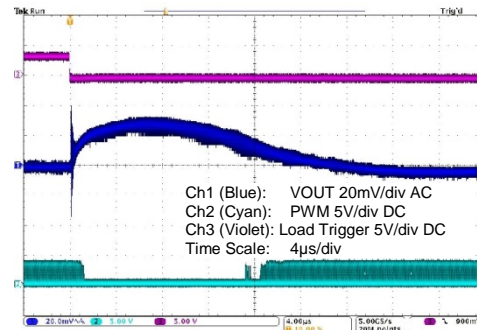
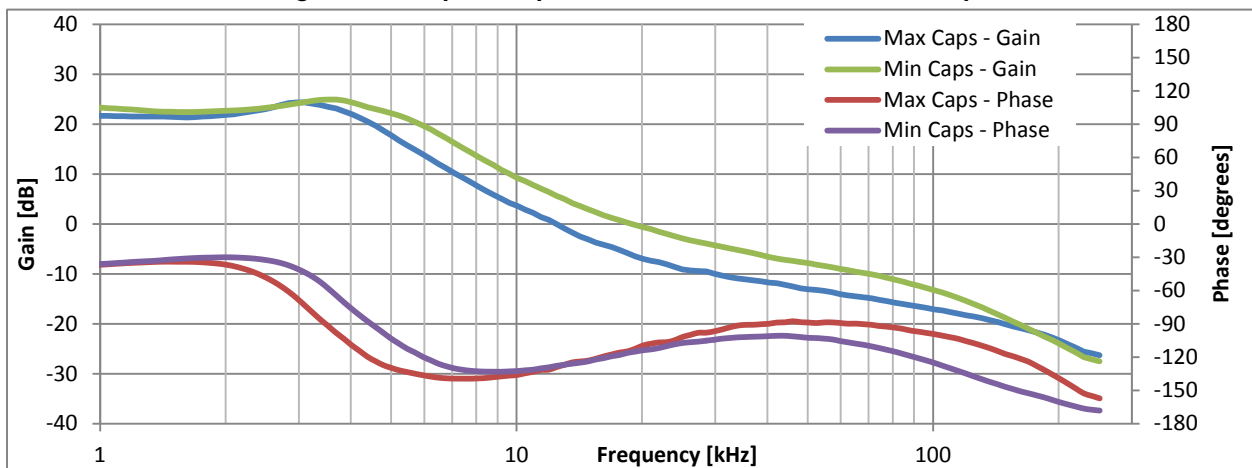

Figure 5.200 Open Loop Bode Plots for ZSPM1511 with Comp3



5.41. ZSPM1512 – Typical Load Transient Response – Capacitor Range #1 – Comp0

Test conditions: $V_{IN} = 12.0V$, $V_{OUT} = 1.00V$

Minimum output capacitance: $2 \times 100\mu F/6.3V \text{ X5R}$

Maximum output capacitance: $4 \times 100\mu F/6.3V \text{ X5R} + 2 \times 47\mu F/10V \text{ X7R}$

Figure 5.201 ZSPM1512 with Comp0; 5A to 15A Load Step; and Min. Capacitance

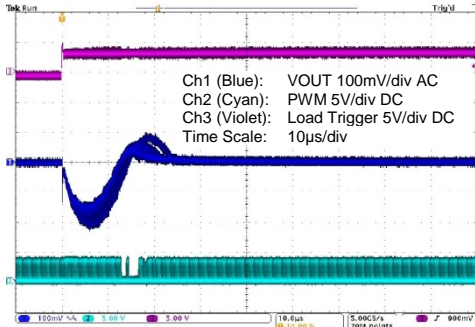

Figure 5.202 ZSPM1512 with Comp0; 15A to 5A Load Step; and Min. Capacitance

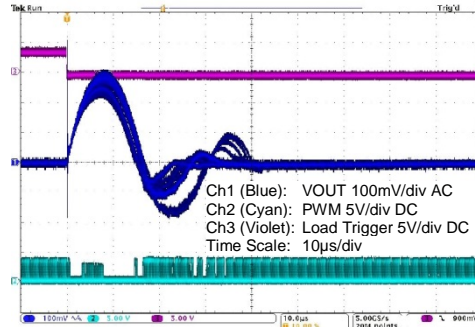

Figure 5.203 ZSPM1512 with Comp0; 5A to 15A Load Step; and Max. Capacitance

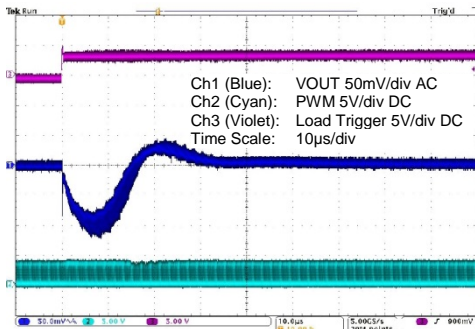

Figure 5.204 ZSPM1512 with Comp0; 15A to 5A Load Step; and Max. Capacitance

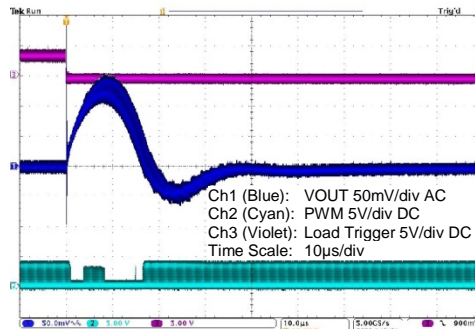
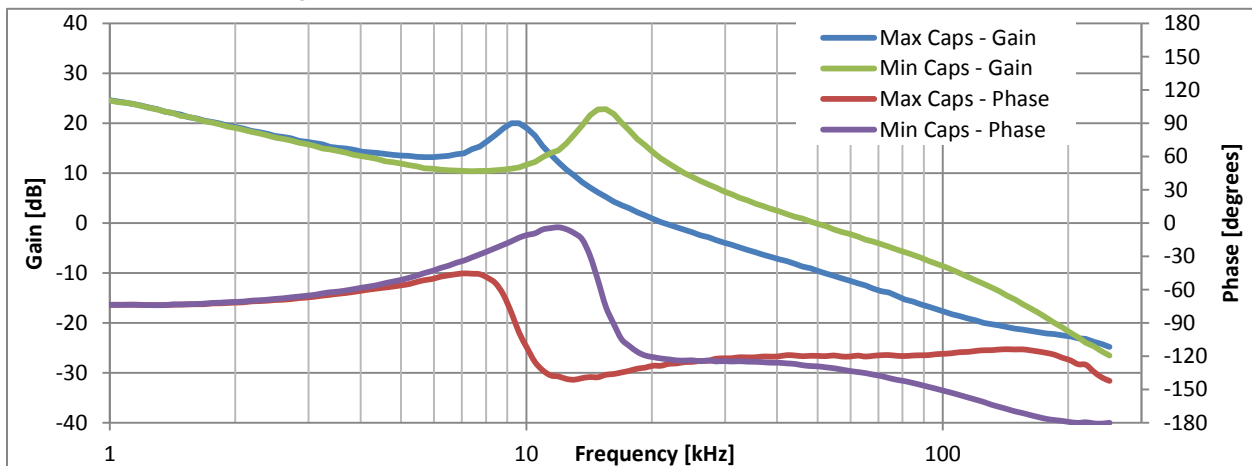

Figure 5.205 Open Loop Bode Plots for ZSPM1512 with Comp0



5.42. ZSPM1512 – Typical Load Transient Response – Capacitor Range #2 – Comp1

Test conditions: $V_{IN} = 12.0V$, $V_{OUT} = 1.00V$

Minimum output capacitance: $5 \times 100\mu F/6.3V \text{ X5R}$

Maximum output capacitance: $8 \times 100\mu F/6.3V \text{ X5R} + 4 \times 47\mu F/10V \text{ X7R}$

Figure 5.206 ZSPM1512 with Comp1; 5A to 15A Load Step; and Min. Capacitance

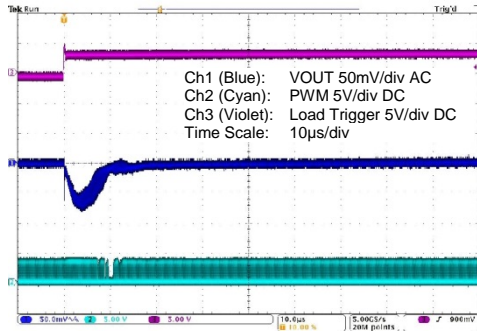

Figure 5.207 ZSPM1512 with Comp1; 15A to 5A Load Step; and Min. Capacitance

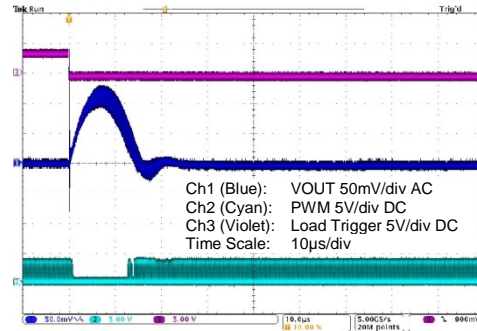

Figure 5.208 ZSPM1512 with Comp1; 5A to 15A Load Step; and Max. Capacitance

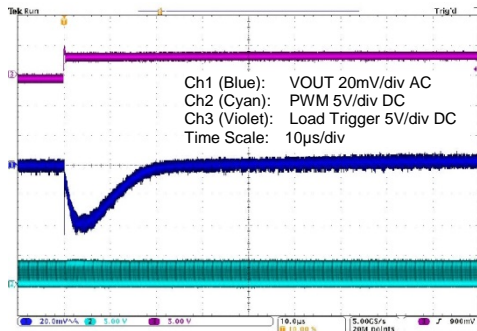

Figure 5.209 ZSPM1512 with Comp1; 15A to 5A Load Step; and Max. Capacitance

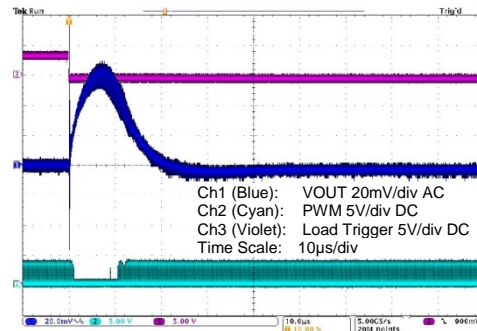
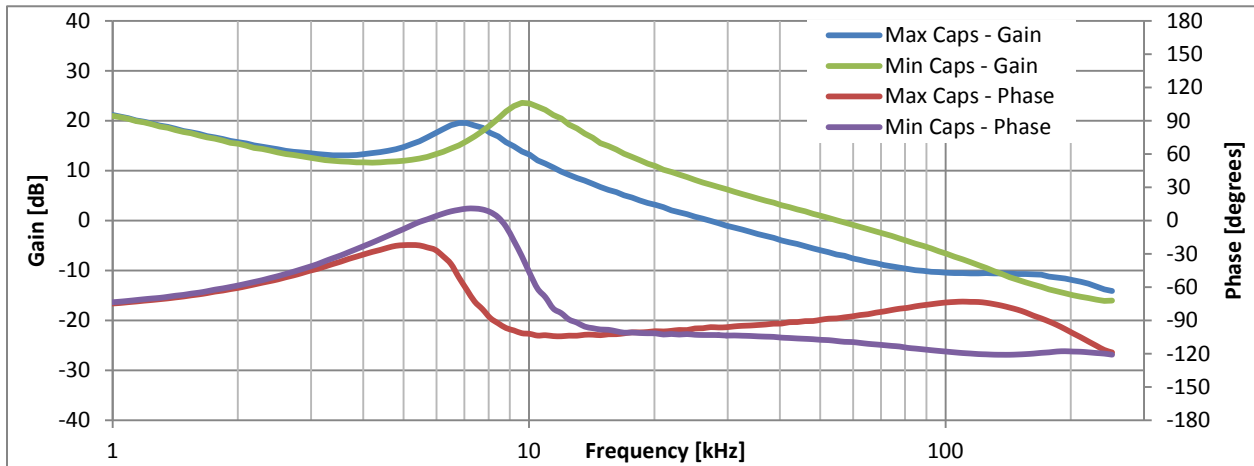

Figure 5.210 Open Loop Bode Plots for ZSPM1512 with Comp1



5.43. ZSPM1512 – Typical Load Transient Response – Capacitor Range #3 – Comp2

Test conditions: $V_{IN} = 12.0V$, $V_{OUT} = 1.00V$

Minimum output capacitance: $2 \times 100\mu F/6.3V \text{ X5R} + 2 \times 470\mu F/7m\Omega$

Maximum output capacitance: $4 \times 100\mu F/6.3V \text{ X5R} + 2 \times 47\mu F/10V \text{ X7R} + 4 \times 470\mu F/7m\Omega$

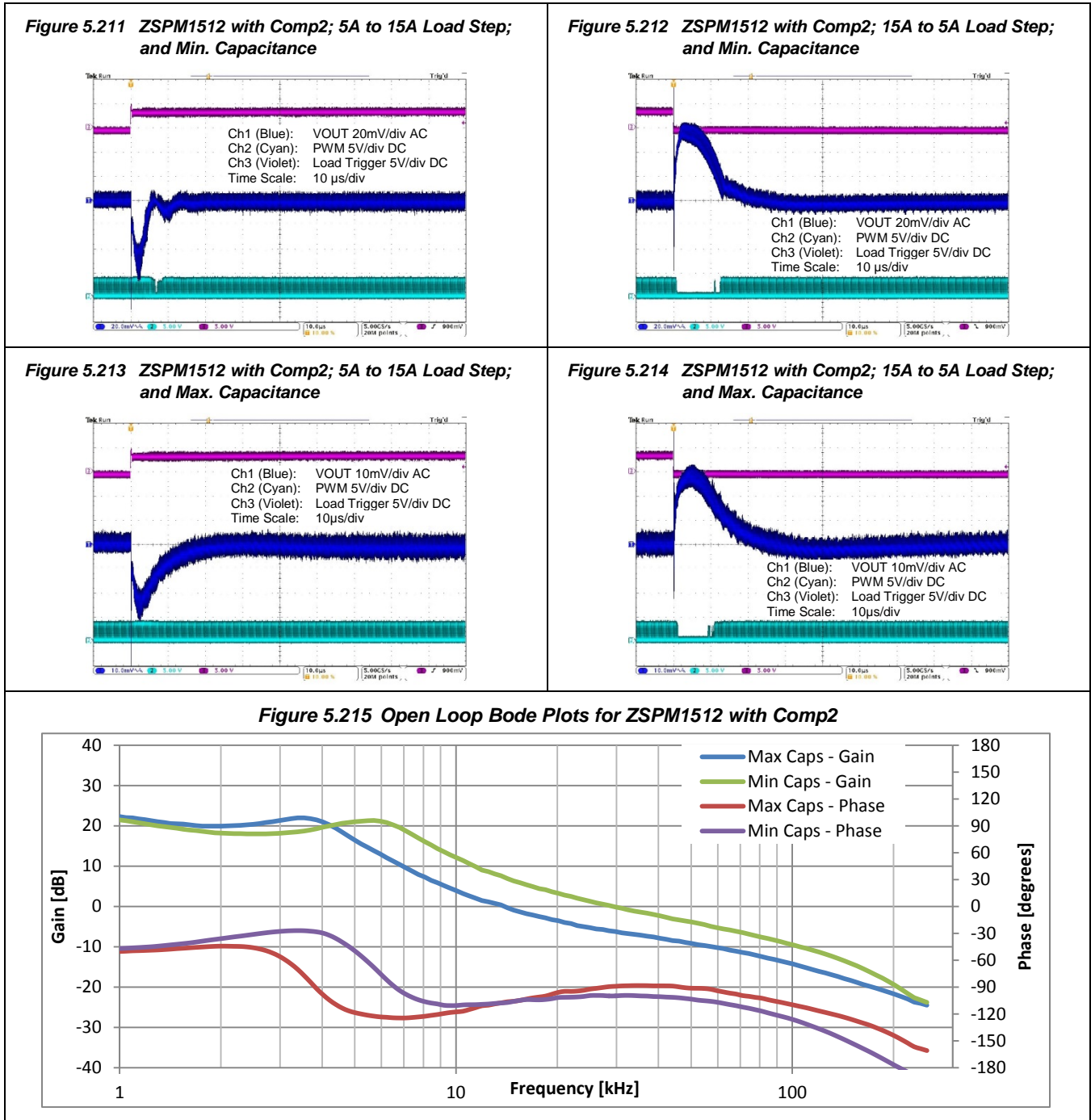

5.44. ZSPM1512 – Typical Load Transient Response – Capacitor Range #4 – Comp3

Test conditions: $V_{IN} = 12.0V$, $V_{OUT} = 1.00V$

Minimum output capacitance: $5 \times 100\mu F/6.3V \text{ X5R} + 4 \times 470\mu F/7m\Omega$

Maximum output capacitance: $8 \times 100\mu F/6.3V \text{ X5R} + 4 \times 47\mu F/10V \text{ X7R} + 6 \times 470\mu F/7m\Omega$

Figure 5.216 ZSPM1512 with Comp3; 5A to 15A Load Step; and Min. Capacitance

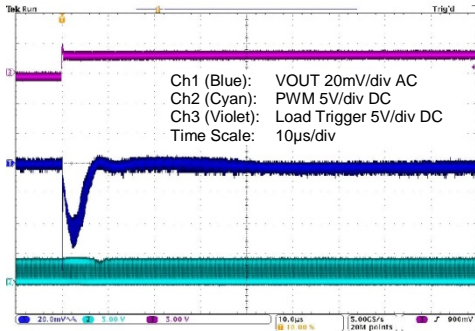

Figure 5.217 ZSPM1512 with Comp3; 15A to 5A Load Step; and Min. Capacitance

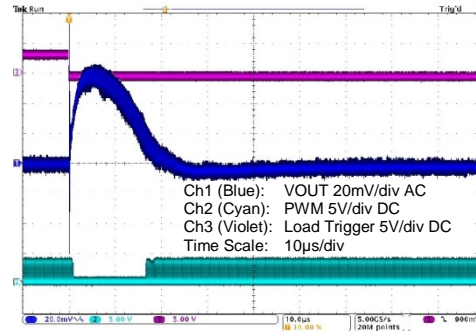

Figure 5.218 ZSPM1512 with Comp3; 5A to 15A Load Step; and Max. Capacitance

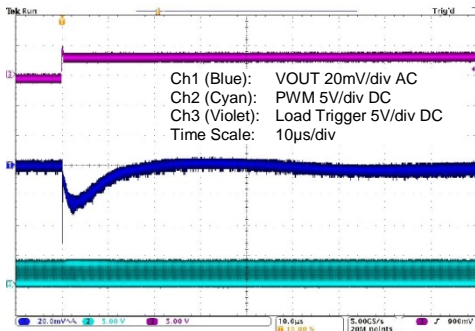

Figure 5.219 ZSPM1512 with Comp3; 15A to 5A Load Step; and Max. Capacitance

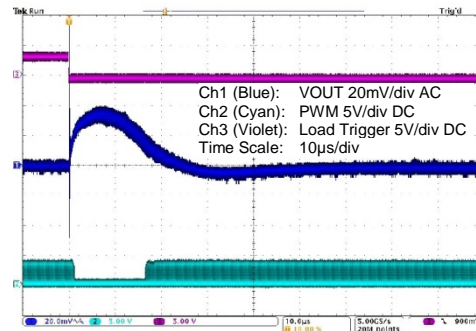
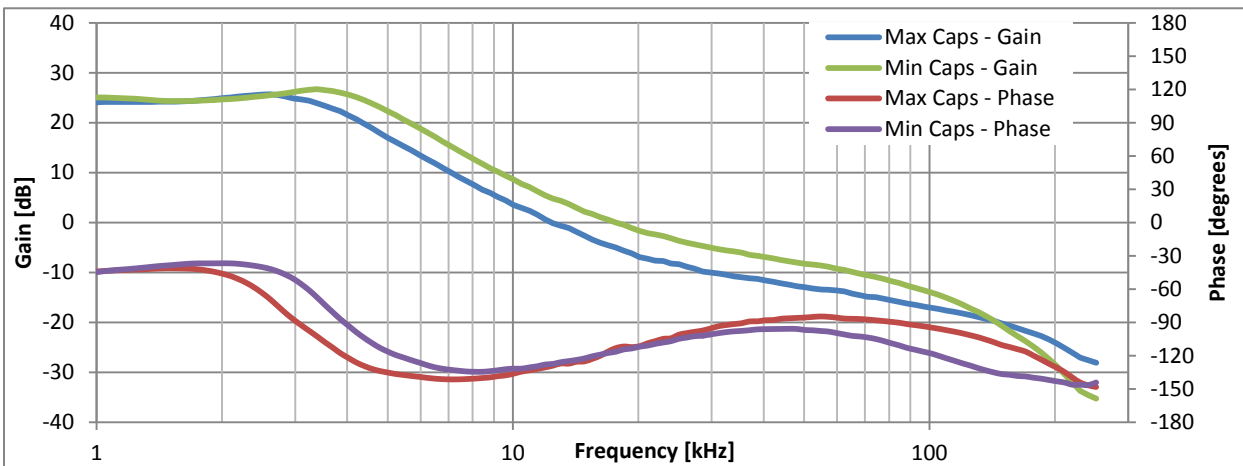

Figure 5.220 Open Loop Bode Plots for ZSPM1512 with Comp3



5.45. ZSPM1513 – Typical Load Transient Response – Capacitor Range #1 – Comp0

Test conditions: $V_{IN} = 12.0V$, $V_{OUT} = 1.20V$

Minimum output capacitance: $2 \times 100\mu F/6.3V \text{ X5R}$

Maximum output capacitance: $4 \times 100\mu F/6.3V \text{ X5R} + 2 \times 47\mu F/10V \text{ X7R}$

Figure 5.221 ZSPM1513 with Comp0; 5A to 15A Load Step; and Min. Capacitance

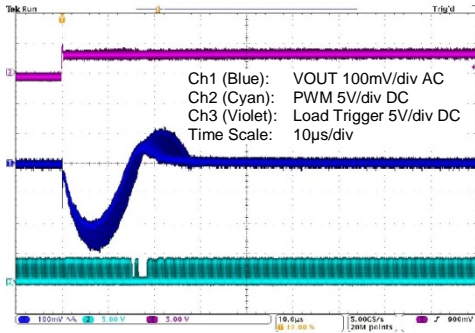

Figure 5.222 ZSPM1513 with Comp0; 15A to 5A Load Step; and Min. Capacitance

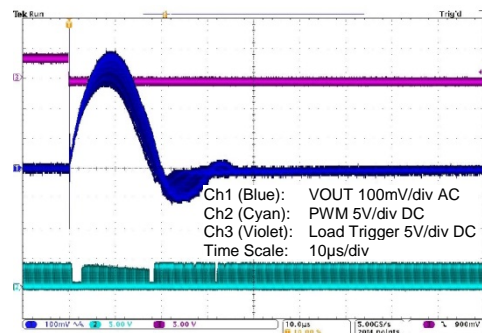

Figure 5.223 ZSPM1513 with Comp0; 5A to 15A Load Step; and Max. Capacitance

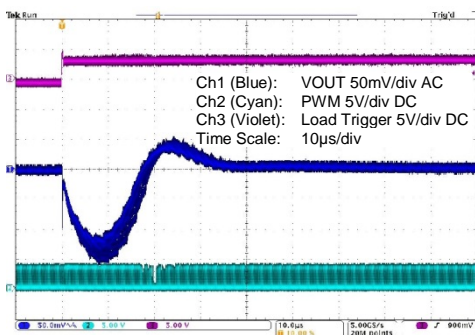

Figure 5.224 ZSPM1513 with Comp0; 15A to 5A Load Step; and Max. Capacitance

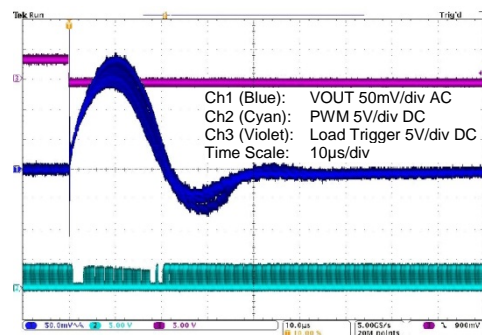
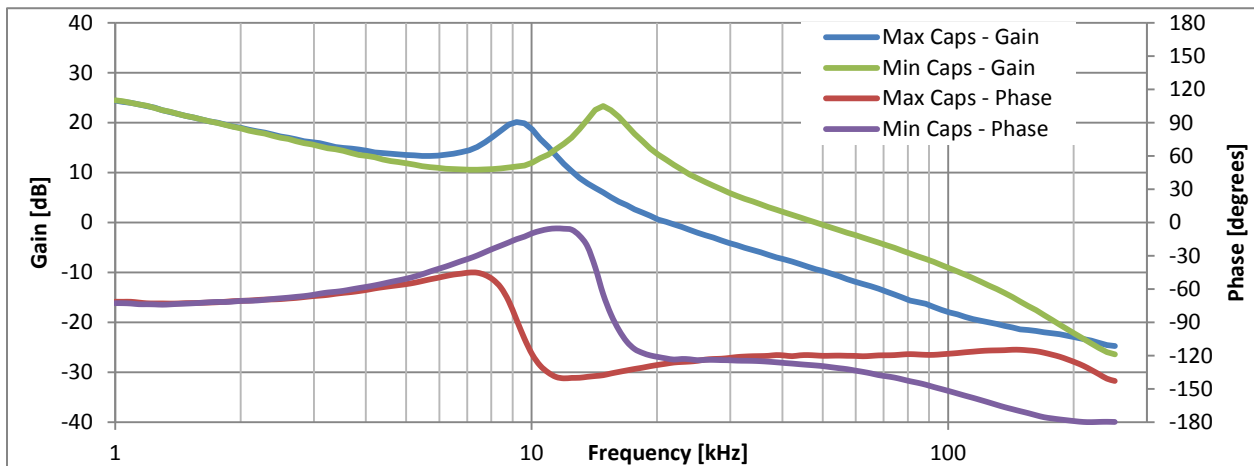

Figure 5.225 Open Loop Bode Plots for ZSPM1513 with Comp0



5.46. ZSPM1513 – Typical Load Transient Response – Capacitor Range #2 – Comp1

Test conditions: $V_{IN} = 12.0V$, $V_{OUT} = 1.20V$

Minimum output capacitance: $5 \times 100\mu F/6.3V \times 5R$

Maximum output capacitance: $8 \times 100\mu F/6.3V \times 5R + 4 \times 47\mu F/10V \times 7R$

Figure 5.226 ZSPM1513 with Comp1; 5A to 15A Load Step; and Min. Capacitance

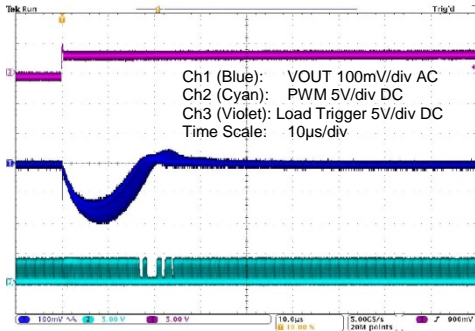

Figure 5.227 ZSPM1513 with Comp1; 15A to 5A Load Step; and Min. Capacitance

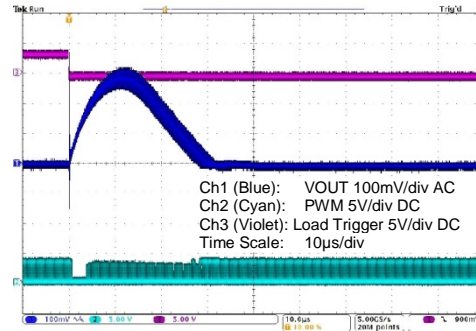

Figure 5.228 ZSPM1513 with Comp1; 5 to 15A Load Step; and Max. Capacitance

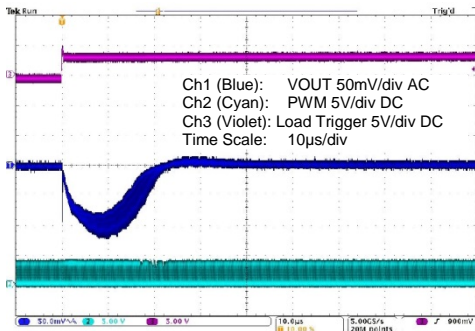

Figure 5.229 ZSPM1513 with Comp1; 15 to 5A Load Step; and Max. Capacitance

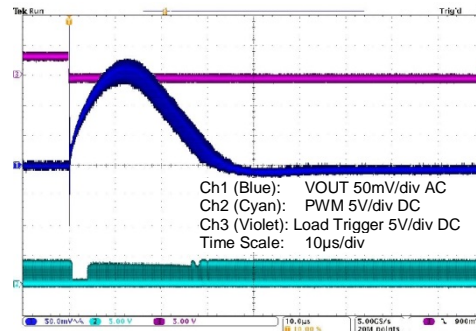
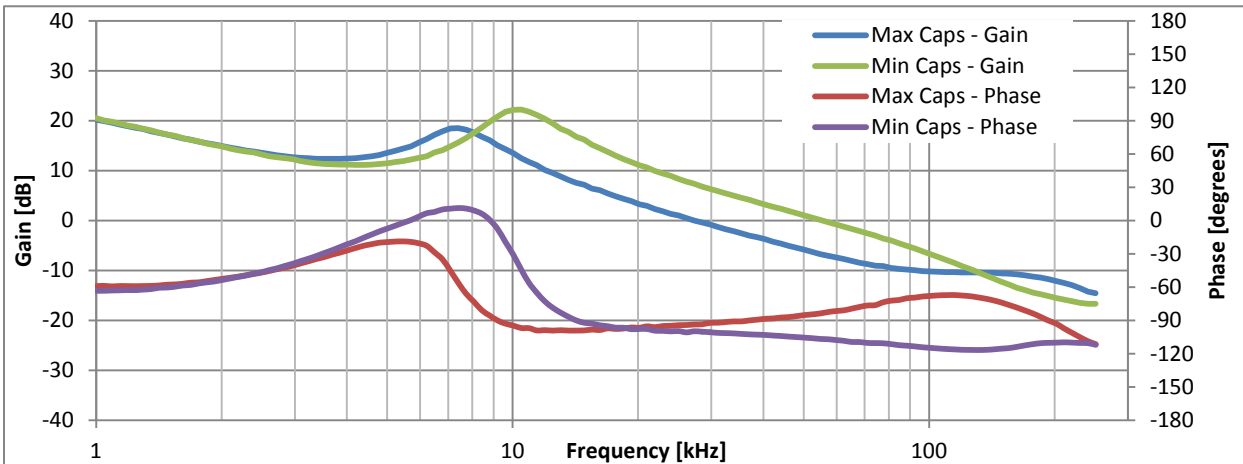

Figure 5.230 Open Loop Bode Plots for ZSPM1513 with Comp1



5.47. ZSPM1513 – Typical Load Transient Response – Capacitor Range #3 – Comp2

Test conditions: $V_{IN} = 12.0V$, $V_{OUT} = 1.20V$

Minimum output capacitance: $2 \times 100\mu F/6.3V \text{ X5R} + 2 \times 470\mu F/7m\Omega$

Maximum output capacitance: $4 \times 100\mu F/6.3V \text{ X5R} + 2 \times 47\mu F/10V \text{ X7R} + 4 \times 470\mu F/7m\Omega$

Figure 5.231 ZSPM1513 with Comp2; 5A to 15A Load Step; and Min. Capacitance

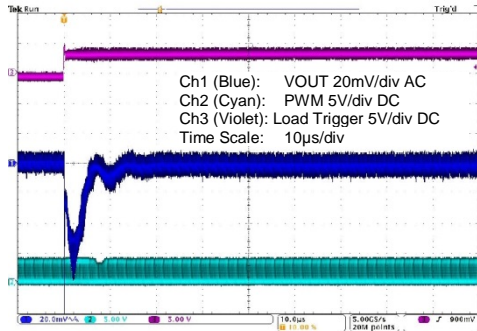

Figure 5.232 ZSPM1513 with Comp2; 15A to 5A Load Step; and Min. Capacitance

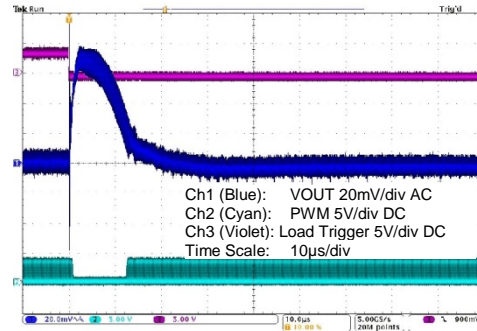

Figure 5.233 ZSPM1513 with Comp2; 5A to 15A Load Step; and Max. Capacitance

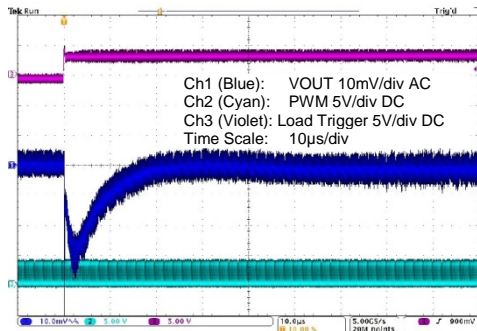

Figure 5.234 ZSPM1513 with Comp2; 15A to 5A Load Step; and Max. Capacitance

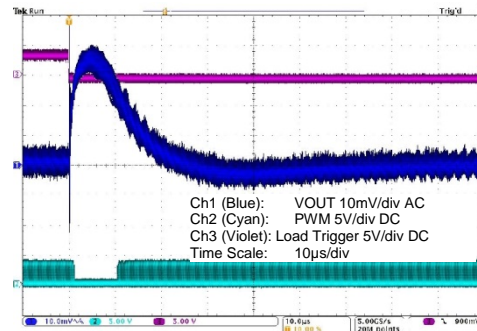
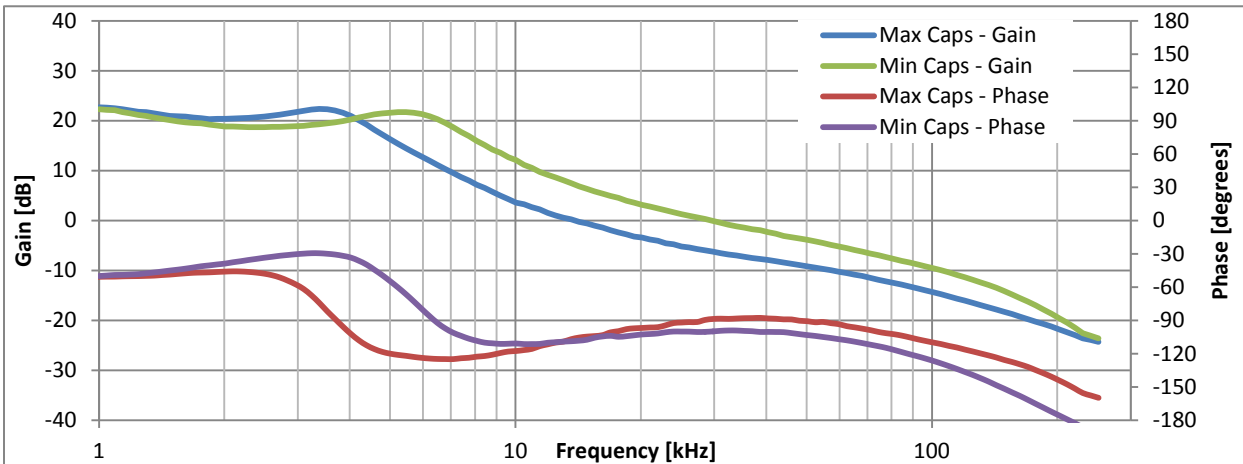

Figure 5.235 Open Loop Bode Plots for ZSPM1513 with Comp2



5.48. ZSPM1513 – Typical Load Transient Response – Capacitor Range #4 – Comp3

Test conditions: $V_{IN} = 12.0V$, $V_{OUT} = 1.20V$

Minimum output capacitance: $5 \times 100\mu F/6.3V \text{ X5R} + 4 \times 470\mu F/7m\Omega$

Maximum output capacitance: $8 \times 100\mu F/6.3V \text{ X5R} + 4 \times 47\mu F/10V \text{ X7R} + 6 \times 470\mu F/7m\Omega$

Figure 5.236 ZSPM1513 with Comp3; 5A to 15A Load Step; and Min. Capacitance

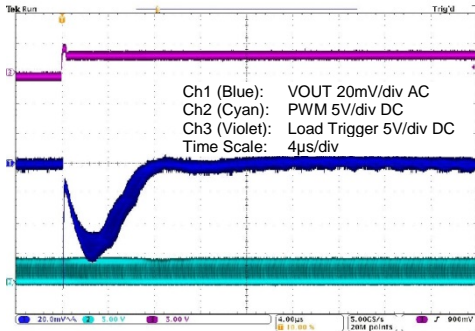

Figure 5.237 ZSPM1513 with Comp3; 15A to 5A Load Step; and Min. Capacitance

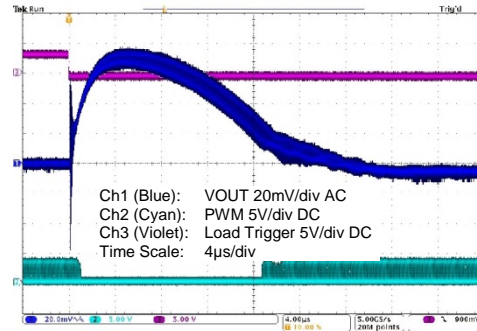

Figure 5.238 ZSPM1513 with Comp3; 5A to 15A Load Step; and Max. Capacitance

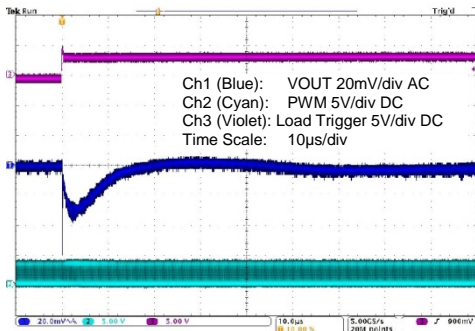

Figure 5.239 ZSPM1513 with Comp3; 15A to 5A Load Step; and Max. Capacitance

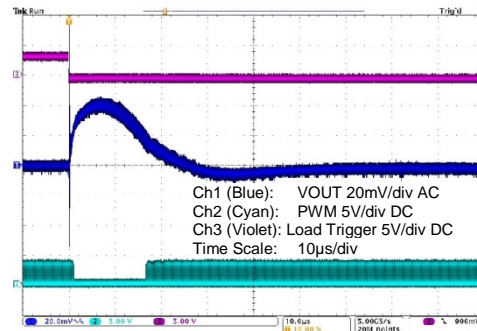
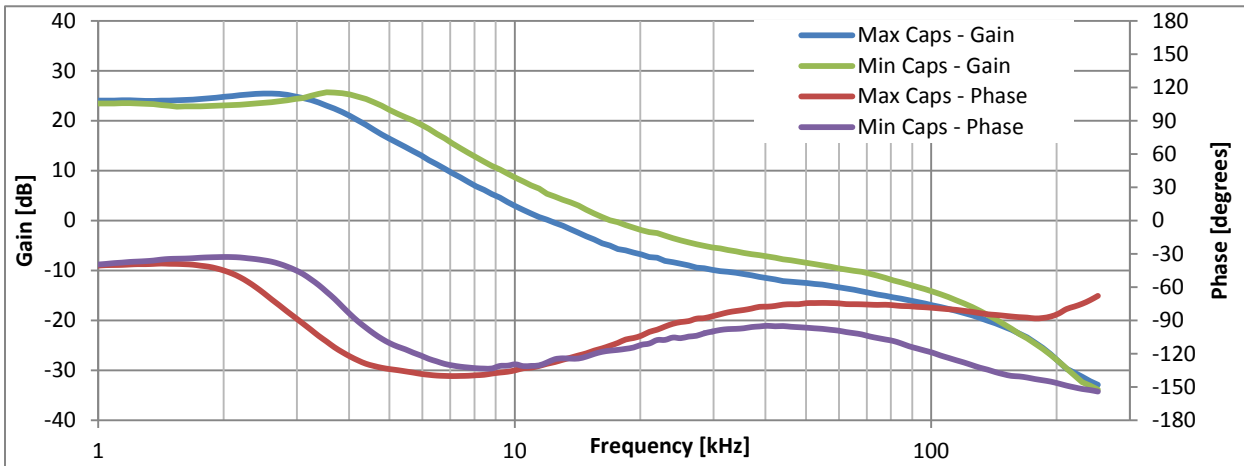

Figure 5.240 Open Loop Bode Plots for ZSPM1513 with Comp3



5.49. Typical Efficiency Curves – ZSPM1502 with ZSPM9000, ZSPM9015, and ZSPM9060 DrMOS

The following graph shows typical efficiency curves for the ZSPM1502 with three different IDT DrMOS power stage options: the ZSPM9000, ZSPM9015, and ZSPM9060. (Note: The ZSPM1502 is also compatible with the ZSPM9010, which is not shown.)

Figure 5.241 Typical Efficiency Curves: ZSPM1502 with ZSPM9000, ZSPM9015, and ZSPM9060 DrMOS ($V_{IN} = 12V$; $V_{out} = 1.0V$)

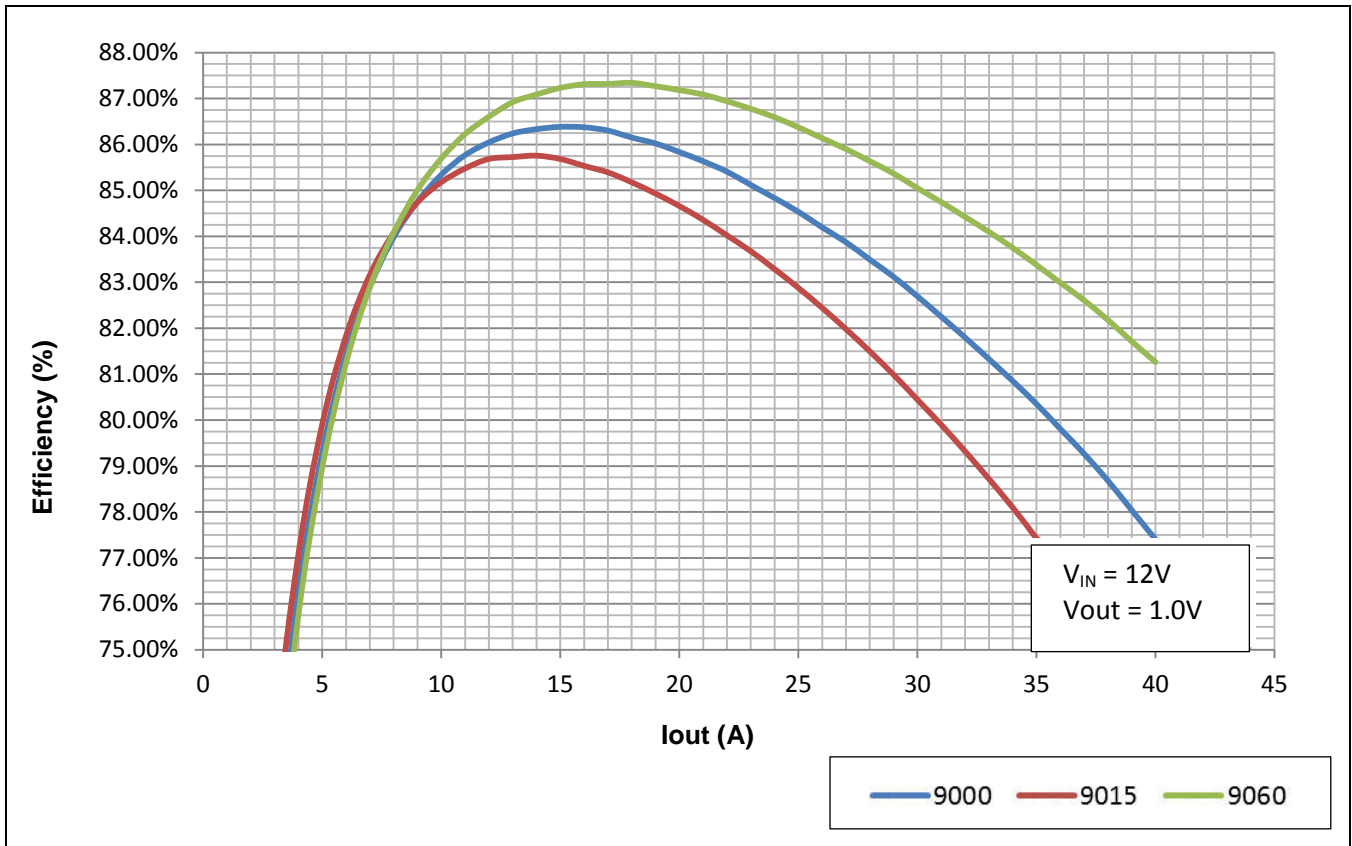

5.50. Typical Efficiency Curves – ZSPM9000 DrMOS with ZSPM1504, ZSPM1505, and ZSPM1506

The following graph shows typical efficiency curves for the ZSPM9000 power stage with three different ZSPM15xx controllers: the ZSPM1504, ZSPM1505, and ZSPM1506.

Figure 5.242 Typical Efficiency Curves: ZSPM9000 DrMOS with ZSPM1504, ZSPM1505, and ZSPM1506 ($V_{IN} = 12V$)

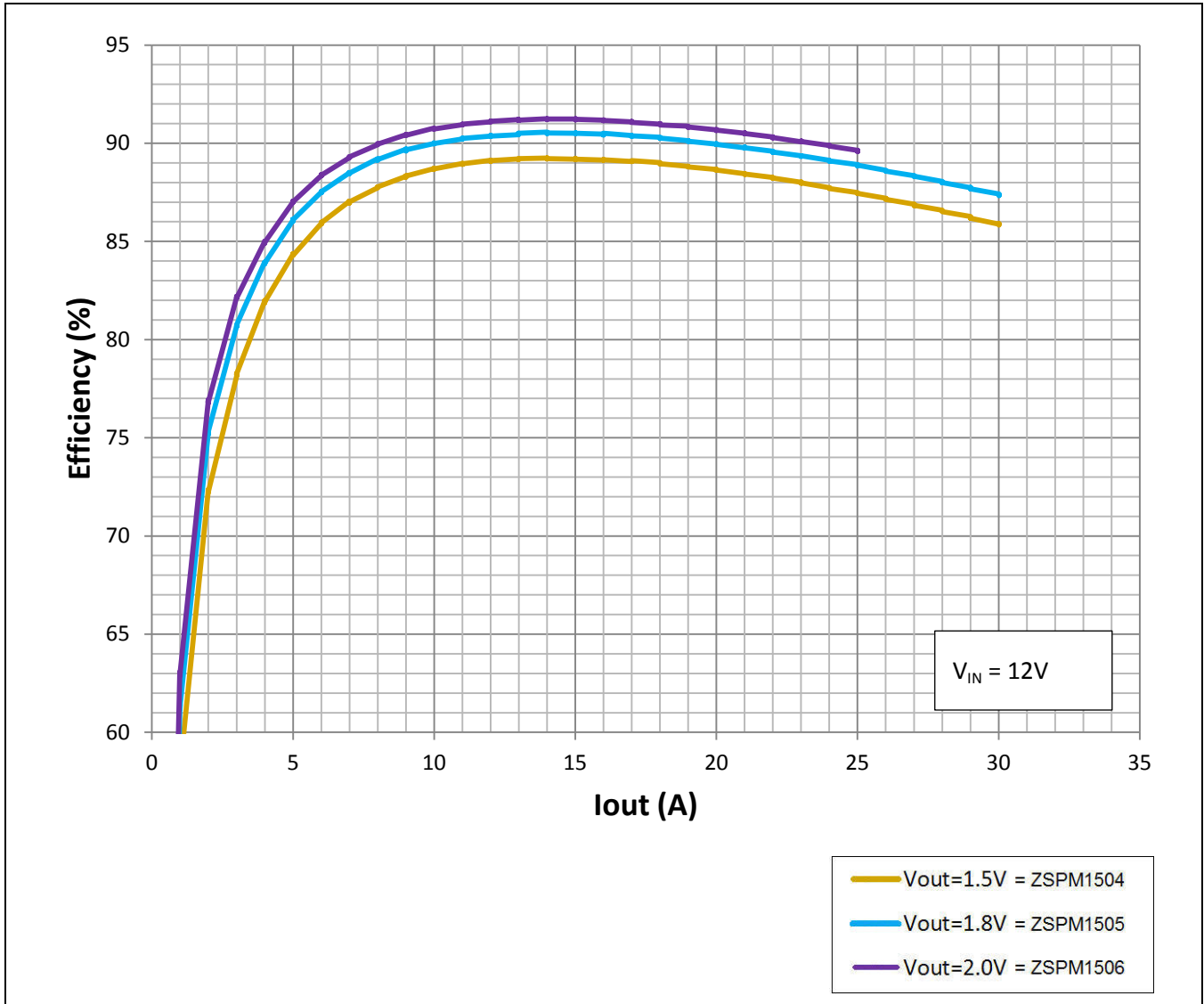

5.51. Typical Efficiency Curves – ZSPM9000 and ZSPM9060 DrMOS with ZSPM1508 and ZSPM1509

The following graph shows typical efficiency curves for the ZSPM9000 and ZSPM9060 power stages with two different ZSPM15xx controllers: the ZSPM1508 and ZSPM1509.

Figure 5.243 Typical Efficiency Curves: ZSPM9000 and ZSPM9060 DrMOS with ZSPM1508 and ZSPM1509

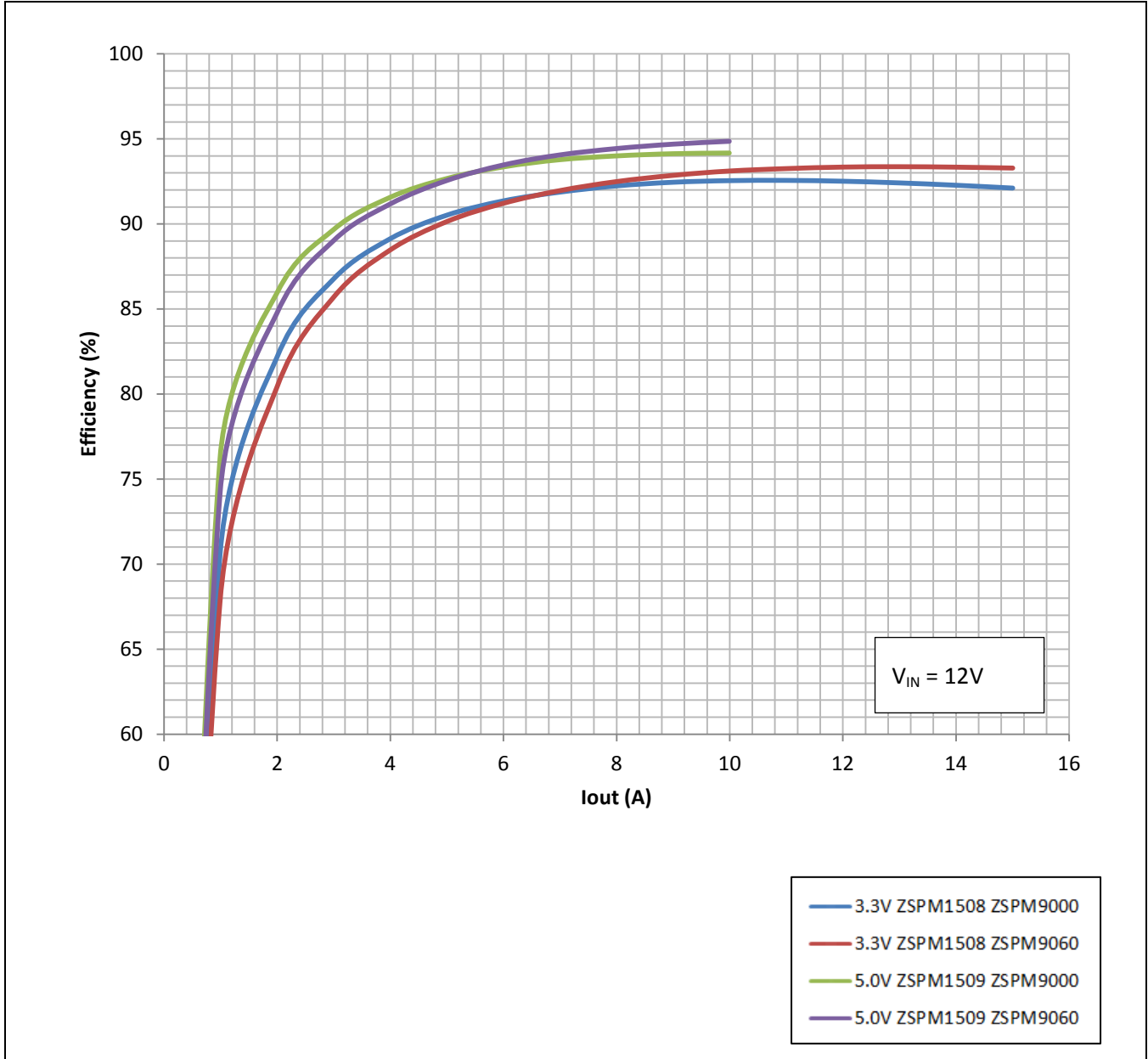

5.52. Typical Efficiency Curves – ZSPM9000 and ZSPM9060 DrMOS with ZSPM1511, ZSPM1512, and ZSPM1513

The following graph shows typical efficiency curves for the ZSPM9000 and ZSPM9060 power stages with three different ZSPM15xx controllers: the ZSPM1511, ZSPM1512, and ZSPM1513.

Figure 5.244 Typical Efficiency Curves: ZSPM9000 and ZSPM9060 DrMOS with ZSPM1511, ZSPM1512, and ZSPM1513

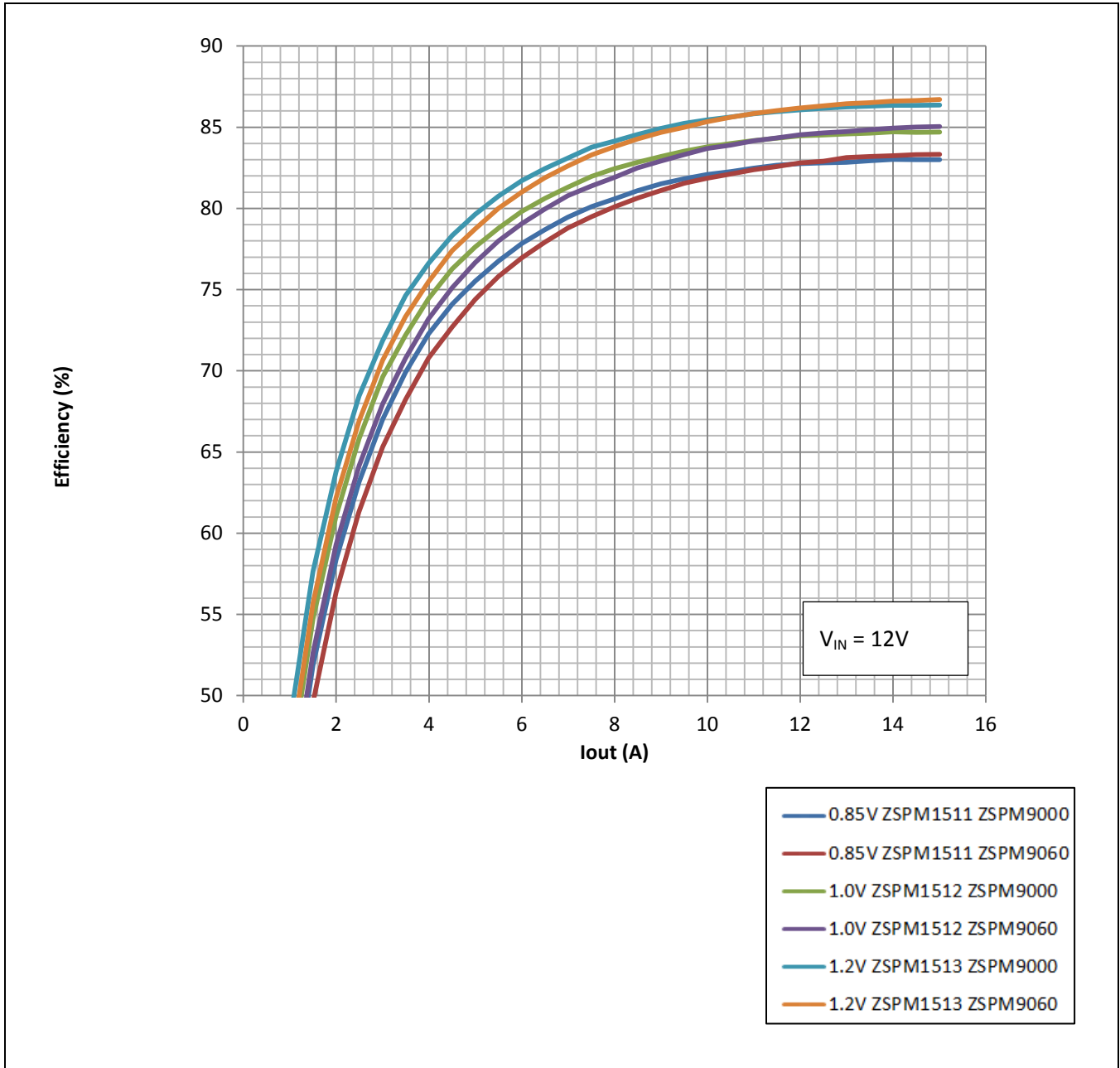

6 Mechanical Specifications

Based on JEDEC MO-220. All dimensions are in millimeters.

Figure 6.1 24-Pin QFN Package Drawing

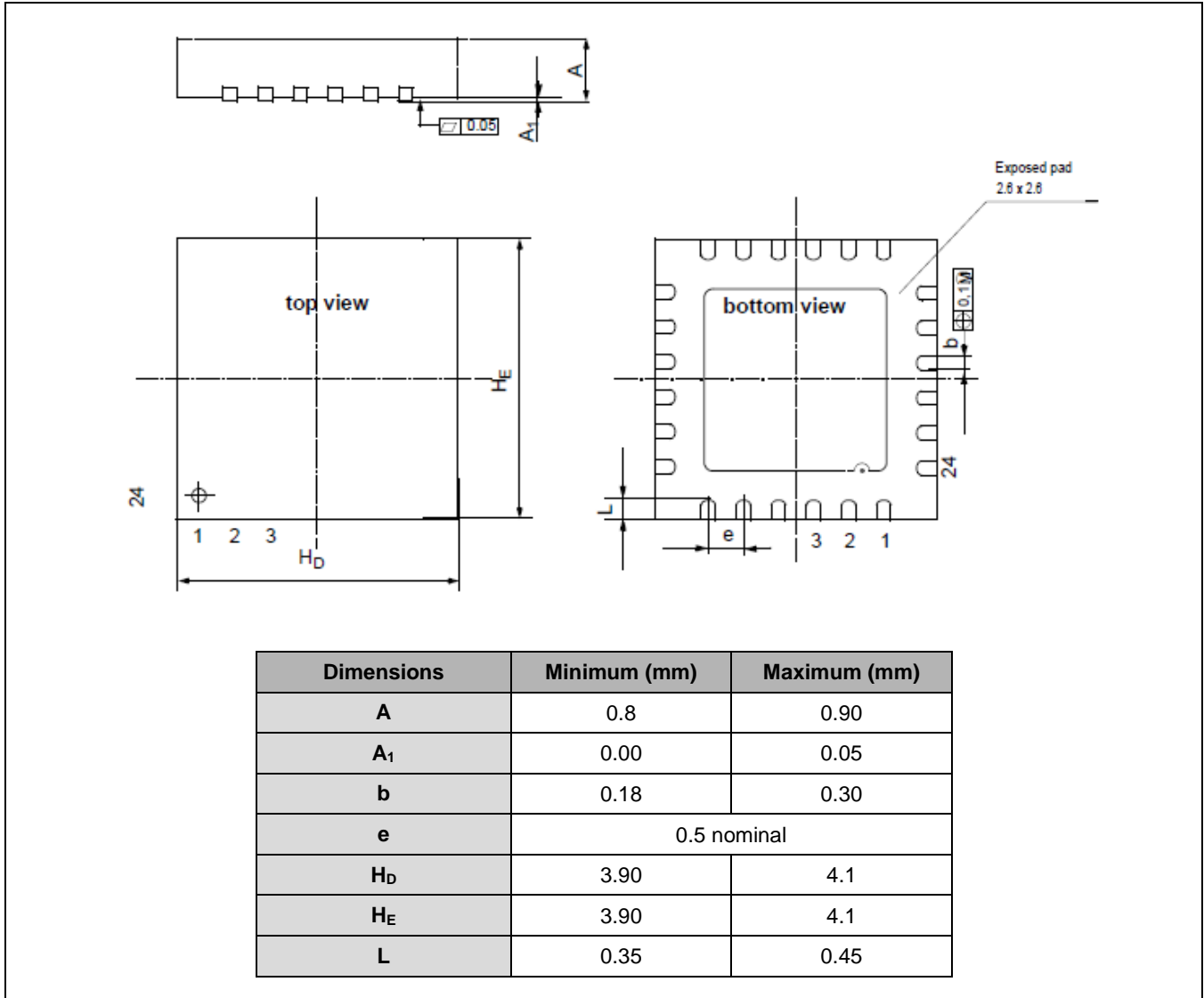

7 Ordering Information

Product Code	Description	Package
ZSPM1501ZA1W0	ZSPM1501 lead-free QFN24; output voltage: 0.85V; inductance: 330nH; temperature: -40°C to +125°C	Reel
ZSPM1502ZA1W0	ZSPM1502 lead-free QFN24; output voltage: 1.00V; inductance: 330nH; temperature: -40°C to +125°C	Reel
ZSPM1503ZA1W0	ZSPM1503 lead-free QFN24; output voltage: 1.20V; inductance: 330nH; temperature: -40°C to +125°C	Reel
ZSPM1504ZA1W0	ZSPM1504 lead-free QFN24; output voltage: 1.50V; inductance: 470nH; temperature: -40°C to +125°C	Reel
ZSPM1505ZA1W0	ZSPM1505 lead-free QFN24; output voltage: 1.80V; inductance: 470nH; temperature: -40°C to +125°C	Reel
ZSPM1506ZA1W0	ZSPM1506 lead-free QFN24; output voltage: 2.00V; inductance: 470nH; temperature: -40°C to +125°C	Reel
ZSPM1507ZA1W0	ZSPM1507 lead-free QFN24; output voltage: 2.50V; inductance: 1000nH; temperature: -40°C to +125°C	Reel
ZSPM1508ZA1W0	ZSPM1508 lead-free QFN24; output voltage: 3.30V; inductance: 2200nH; temperature: -40°C to +125°C	Reel
ZSPM1509ZA1W0	ZSPM1509 lead-free QFN24; output voltage: 5.00V; inductance: 2200nH; temperature: -40°C to +125°C	Reel
ZSPM1511ZA1W0	ZSPM1511 lead-free QFN24; output voltage: 0.85V; inductance: 680nH; temperature: -40°C to +125°C	Reel
ZSPM1512ZA1W0	ZSPM1512 lead-free QFN24; output voltage: 1.00V; inductance: 680nH; temperature: -40°C to +125°C	Reel
ZSPM1513ZA1W0	ZSPM1513 lead-free QFN24; output voltage: 1.20V; inductance: 680nH; temperature: -40°C to +125°C	Reel

8 Related Documents

Document
ZSPM15xx Family Feature Sheet
ZSPM15XX-KIT01 Kit Description

Visit the ZSPM15xx product page www.IDT.com/ZSPM15xx or contact your nearest sales office for the latest version of these documents.

9 Glossary

Term	Description
DCR	Equivalent DC Resistance
DNP	Do Not Place (Component)
DPWM	Digital Pulse-Width Modulator
DSP	Digital Signal Processing
FPGA	Field-Programmable Gate Array
HKADC	Housekeeping Analog-To-Digital Converter
OCP	Over-Current Protection
OT	Over-Temperature
OV	Over-Voltage
PID	Proportional/Integral/Derivative
SLC	State-Law Control™
SPM	Smart Power Management

10 Document Revision History

Revision	Date	Description
2.00	November 24, 2014	First release of full revision.
2.10	March 9, 2015	Addition of ZSPM1507, ZSPM1508, and ZSPM1509 to family of products.
2.20	April 27, 2015	Addition of ZSPM1511, ZSPM1512, and ZSPM1513 to family of products. Removal of references to Sub-cycle Response (SCR) as this is not activated in the ZSPM15xx. Addition of Table 4.10, Table 4.11, and Table 4.12 for CONFIG 1 settings for the ZSPM1507, ZSPM1508, and ZSPM1509 respectively. Correction of C9 to C10 in section 4.5.
	January 27, 2016	Changed to IDT branding.

IMPORTANT NOTICE AND DISCLAIMER

RENESAS ELECTRONICS CORPORATION AND ITS SUBSIDIARIES (“RENESAS”) PROVIDES TECHNICAL SPECIFICATIONS AND RELIABILITY DATA (INCLUDING DATASHEETS), DESIGN RESOURCES (INCLUDING REFERENCE DESIGNS), APPLICATION OR OTHER DESIGN ADVICE, WEB TOOLS, SAFETY INFORMATION, AND OTHER RESOURCES “AS IS” AND WITH ALL FAULTS, AND DISCLAIMS ALL WARRANTIES, EXPRESS OR IMPLIED, INCLUDING, WITHOUT LIMITATION, ANY IMPLIED WARRANTIES OF MERCHANTABILITY, FITNESS FOR A PARTICULAR PURPOSE, OR NON-INFRINGEMENT OF THIRD-PARTY INTELLECTUAL PROPERTY RIGHTS.

These resources are intended for developers who are designing with Renesas products. You are solely responsible for (1) selecting the appropriate products for your application, (2) designing, validating, and testing your application, and (3) ensuring your application meets applicable standards, and any other safety, security, or other requirements. These resources are subject to change without notice. Renesas grants you permission to use these resources only to develop an application that uses Renesas products. Other reproduction or use of these resources is strictly prohibited. No license is granted to any other Renesas intellectual property or to any third-party intellectual property. Renesas disclaims responsibility for, and you will fully indemnify Renesas and its representatives against, any claims, damages, costs, losses, or liabilities arising from your use of these resources. Renesas' products are provided only subject to Renesas' Terms and Conditions of Sale or other applicable terms agreed to in writing. No use of any Renesas resources expands or otherwise alters any applicable warranties or warranty disclaimers for these products.

(Disclaimer Rev.1.01)

Corporate Headquarters

TOYOSU FORESIA, 3-2-24 Toyosu,
Koto-ku, Tokyo 135-0061, Japan
www.renesas.com

Trademarks

Renesas and the Renesas logo are trademarks of Renesas Electronics Corporation. All trademarks and registered trademarks are the property of their respective owners.

Contact Information

For further information on a product, technology, the most up-to-date version of a document, or your nearest sales office, please visit www.renesas.com/contact-us/.