

ISL6742BEVAL3Z

Power Converter 36V to 75V Input, 12V Output Up to 10A

AN1890

Rev 0.00

September 12, 2013

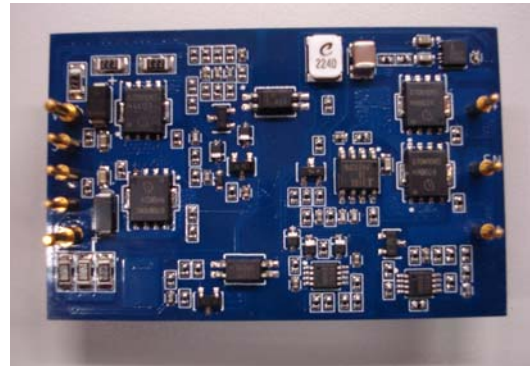
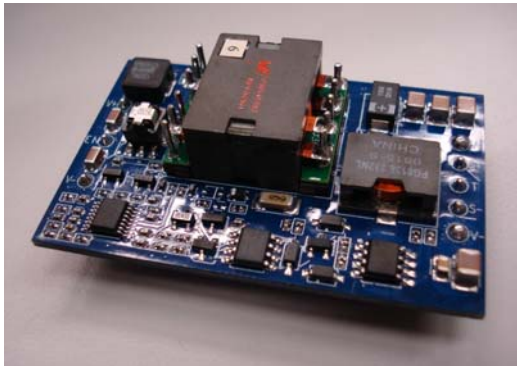

Introduction

The ISL6742BEVAL3Z is a standard quarter brick power module from Intersil. Implemented by the high performance double-ended PWM controller ISL6742B, it is an ideal choice in applications where performance, space and a pre-bias start-up are important attributes. Useful features such as the synchronous rectifier function and the precise average current OCP contribute to the great performance of the ISL6742BEVAL3Z.

Key Features

- Industry standard Quarter-brick. 57.9x36.8x15.88mm
- High efficiency, typical up to 93.4% (48V input full load)
- 1500 VDC input to output isolation
- Output overvoltage protection
- Input undervoltage protection
- Hiccup overcurrent protection (based on average current signal)
- Remote control (On/Off Inhibit)
- Pre-Bias start-up

Equipment and Components Required

- Input power source up to 75V supply voltage with 200W power supply ability.
- Electronic load with 150W power sinking ability
- Voltmeters and ammeters (optional)
- At least 300 μ F/16V output capacitor

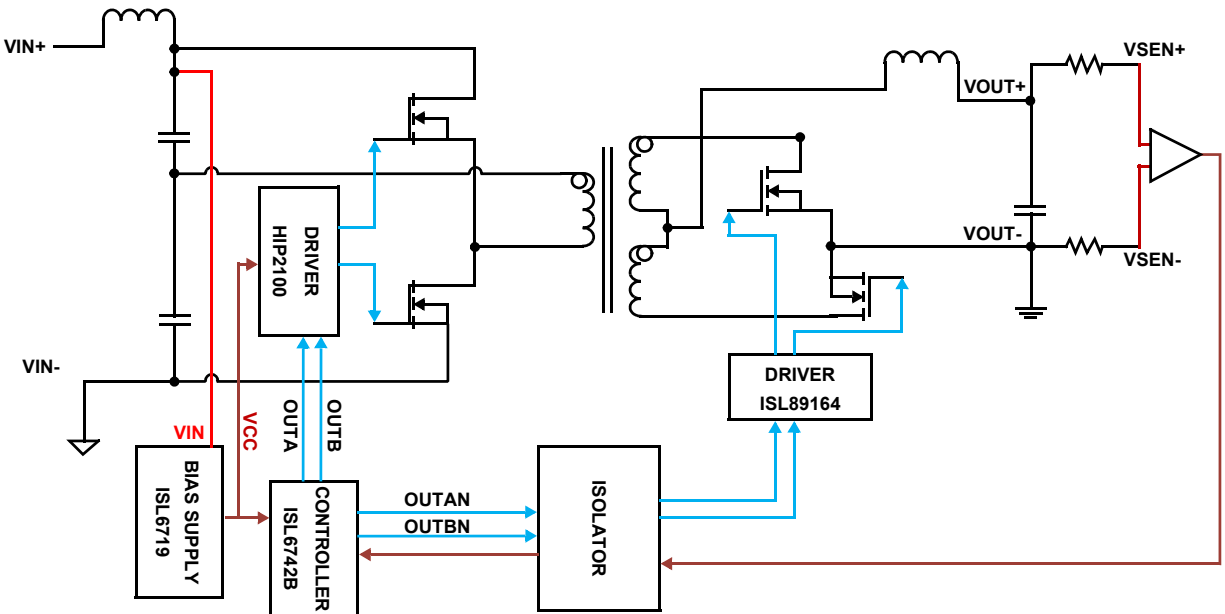

FIGURE 1. TYPICAL CIRCUIT DIAGRAM

Terminal Functions

TERMINAL		DESCRIPTION
NAME	NO.	
V_{IN+}	1	The positive input voltage node to the module, which is referenced to common ground, V_{IN-}
ON/OFF	2	Applying a high-level signal to this input disables the module's output and turns off the output voltage. If this pin is left open-circuit or applying a low-level signal, the module will produce an output whenever a valid input source is applied.
V_{IN-}	3	This is the common ground connection for the input
VO-	4	This is the common ground connection for the V_{OUT} power connection.
V_{SEN-}	5	For remote sense; For optimal voltage accuracy, V_{SEN-} should be connected to the negative of the load directly. It can also be left disconnected.
Trim	6	This pin can be used to adjust the output voltage above or below output voltage initial setting. To increase the output voltage, the resistor should be connected between the Trim pin and V_{SEN-} pin while connected between the Trim pin and V_{SEN+} pin can decrease the output voltage.
V_{SEN+}	7	For remote sense; For optimal voltage accuracy, V_{SEN+} should be connected to the positive of the load directly. It can also be left disconnected.
V_{O+}	8	This is the positive of the output connection for the V_{OUT} power connection.

Getting Started

Using short twisted pair leads for any power connections and with all loads and power supplies off, refer to Figure 2 for the proper measurement and equipment setup. The Power Supply (PS) should not be connected to the circuit until instructed to do so in the following procedure.

When measuring the input or output voltage ripple, care must be taken to avoid a long ground lead on the oscilloscope probe. Measure the input or output voltage ripple by touching the probe tip directly across the output ceramic capacitor, refer to Figure 3.

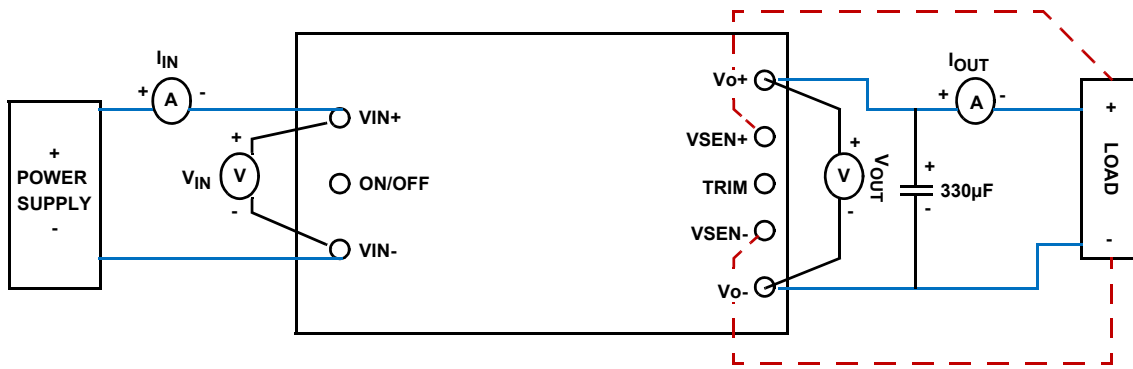

FIGURE 2. CONNECTION DIAGRAM

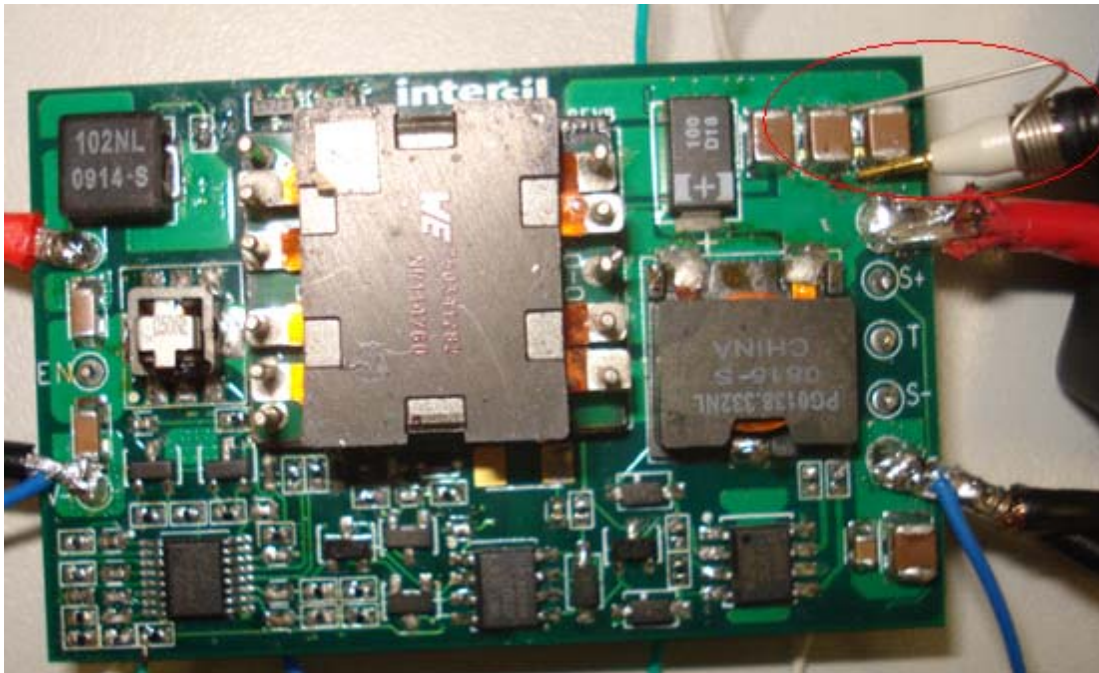

FIGURE 3. OUTPUT RIPPLE MEASUREMENT METHOD

1. External output capacitor with at least 300µF capacitance should be soldered at the output between VO+ and VO- PIN. A 330µF capacitor is applied in the test.
2. Connect the power supply; electronic load; voltmeters and ammeters like Figure 2 shows while keeping the power supply and load power off. For accurate sense voltage, remote sense is required, solder the wire between VSEN+/VSEN- and the load as shown in Figure 2. Also, remote sense could be left open since accuracy here is not important.
3. Turn on the electronic load, making the load sinking a no load.
4. Turn on the power supply and set the input voltage to 48V. Monitor input current, it should be about 60mA. If the input current exceeds 100mA, turn off the power supply and look for shorts.
5. Confirm V_{OUT} equals to 12V; Slowly increase the Load on V_{OUT} to 10A. Verify the V_{OUT} still is 12V.

The board is now ready for operation.

(Note: Air cooling is preferred when the load is high or the temperature is higher than +100 °C)

Absolute Maximum Ratings

PARAMETER	LOW	HIGH
Supply Voltage, VIN+ to VIN-	GND - 0.3V	75V
On/Off	-0.3V	5V

Electrical Specifications $T_A = +25^\circ\text{C}$; $V_{IN} = 48\text{V}$; $V_{OUT} = 12\text{V}$; $I_O = 10\text{A}$ (unless otherwise noted).

SYMBOL	PARAMETER	TEST CONDITIONS	MIN	TYP	MAX	UNIT
I_O	Output Current	$V_O = 12\text{V}$	0		10	A
V_{IN}	Input Range	Over I_O range	36		75	V
V_{OUT}	Output Range	Over I_O range, Trim pin open	12		12.032	V
$\Delta\text{Reg}_{\text{line}}$	Line Regulation	Over V_{IN} range		8		mV
$\Delta\text{Reg}_{\text{load}}$	Load Regulation	Over I_O range		13		mV
η	Efficiency	$I_O = 10\text{A}$				
		$V_{IN} = 36\text{V}$		93.65		%
		$V_{IN} = 48\text{V}$		93.44		%
		$V_{IN} = 75\text{V}$		91.51		%
V_r	V_{OUT} Ripple (Peak to Peak)	20MHz bandwidth, including noise		18.6		mV _{P-P}
$I_{O\text{trip}}$	Overcurrent Threshold	Reset, followed by auto-recovery		13		A
ΔV_{tr}	Transient Response	1 A/ μs load step, 25 to 75% $I_{O(\text{MAX})}$; V_O over/undershoot		+190/-186		mV
T_{tr}	Load Transient Recovery Time			100		μs
UVLO	Undervoltage Lock-out	V_{IN} increasing		35		V
		V_{IN} decreasing		34		V
V_{INH}	ON/OFF Control (Pin 2)	Input high voltage, referenced to GND		2.4		V
V_{INL}		Input low voltage, referenced to GND		0.5		V
F_S	Switching Frequency	Over V_{IN} and I_O range		240		kHz
OVP	Overvoltage Protection	Over V_{IN} range		14		V
C_O	Output Capacitance	Over V_{IN} and I_O range	300		1100	μF

Remote Control (On/Off)

The on/off function allows the product to be turned on or off by an external signal. To turn off the converter, apply a high logic signal referenced to VIN-, like 5V to the on/off pin. The output will be shut down. While turning on the converter, a low logic signal is referenced to VIN- (as 0V is applied on this pin or left open it also could turn on the converter) while a valid power supply is applied on the input pins.

Input Undervoltage Protection

Input UVP is integrated in the converter to eliminate the output voltage re-start when shut down. The output will be shut down when the input voltage decreases to ~34V and an increase to ~35V would turn on the module.

Output Overvoltage Protection

Output OVP function will be enabled when the output voltage is higher than 14V, which is a very dangerous situation that could damage the load circuits. A voltage reference is used for this function to realize an accurate trigger point, which would avoid damage when the output is higher than the setting value.

Output Overcurrent Protection

If the load current is higher than the setting value, 13A, the output OCP will be functional and get into the hiccup mode to decrease the power sourcing from the power supply. Due to the unique function ISL6742B has, the average output current instead of peak current in most prior products is sensed making the current signal more accurate.

Pre-bias Start-up

Pre-bias start condition occurs as a result of an external voltage being present at the output of a power module prior to its output becoming active. A prebias can cause problems with power modules that incorporate synchronous rectifiers. This is because under most operating conditions, such modules can sink as well as source output current. This function will assure that the converter does not sink current during start-up.

Trim (Output Voltage Adjust)

The ISL6742B product has an output voltage trim pin. This pin can be used to adjust the output above or below output voltage initial setting. When increasing the output voltage, the voltage at the output sense pins must be kept below the threshold of the overvoltage protection to prevent shutting down. At an increased output voltage, the maximum power rating of the product remains the same, and the max output current must be decreased correspondingly.

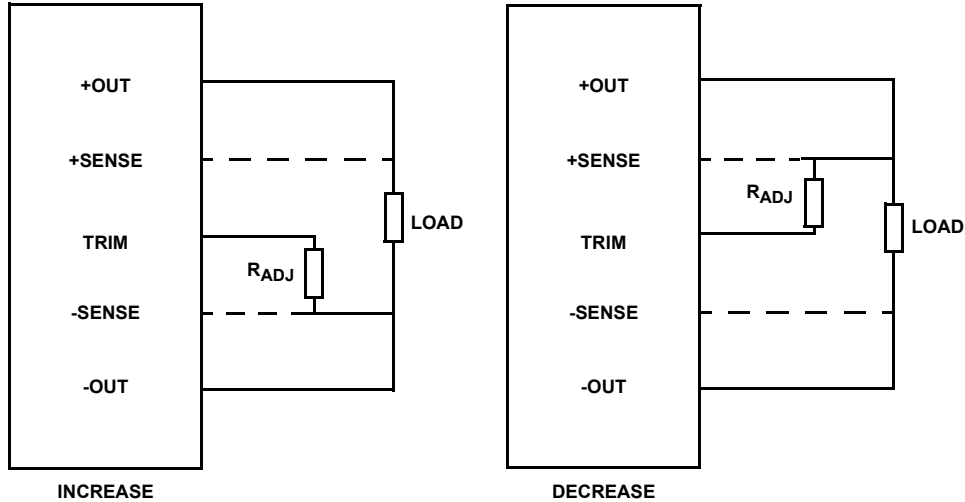

FIGURE 4. TRIM OUTPUT VOLTAGE

The resistor value for an adjust output voltage is calculated by using the following equations:

To adjust output voltage upwards:

Connect R_{TRIM} between Pin "VSEN-" and Pin "Trim".

$$R_{TRIM} = \frac{7.9 - 3.16 \times \Delta\%}{3.16 \times \Delta\%} k\Omega \quad (EQ. 1)$$

Example: increase 5%, $V_{OUT} = 12V \times (1 + 5\%) = 12.6V$

$$R_{TRIM} = \frac{7.9 - 3.16 \times 5\%}{3.16 \times 5\%} k\Omega = 49 k\Omega \quad (EQ. 2)$$

To adjust output voltage downwards:

Connect R_{TRIM} between Pin "VSEN+" and Pin "Trim".

$$R_{TRIM} = \frac{144 - 197.21 \times \Delta\%}{15.17 \times \Delta\%} k\Omega \quad (EQ. 3)$$

Example: decrease 5%, $V_{OUT} = 12V \times (1 - 5\%) = 11.4V$

$$R_{TRIM} = \frac{144 - 197.21 \times 5\%}{15.17 \times 5\%} k\Omega = 176.85 k\Omega \quad (EQ. 4)$$

ISL6742BEVAL3Z Schematic

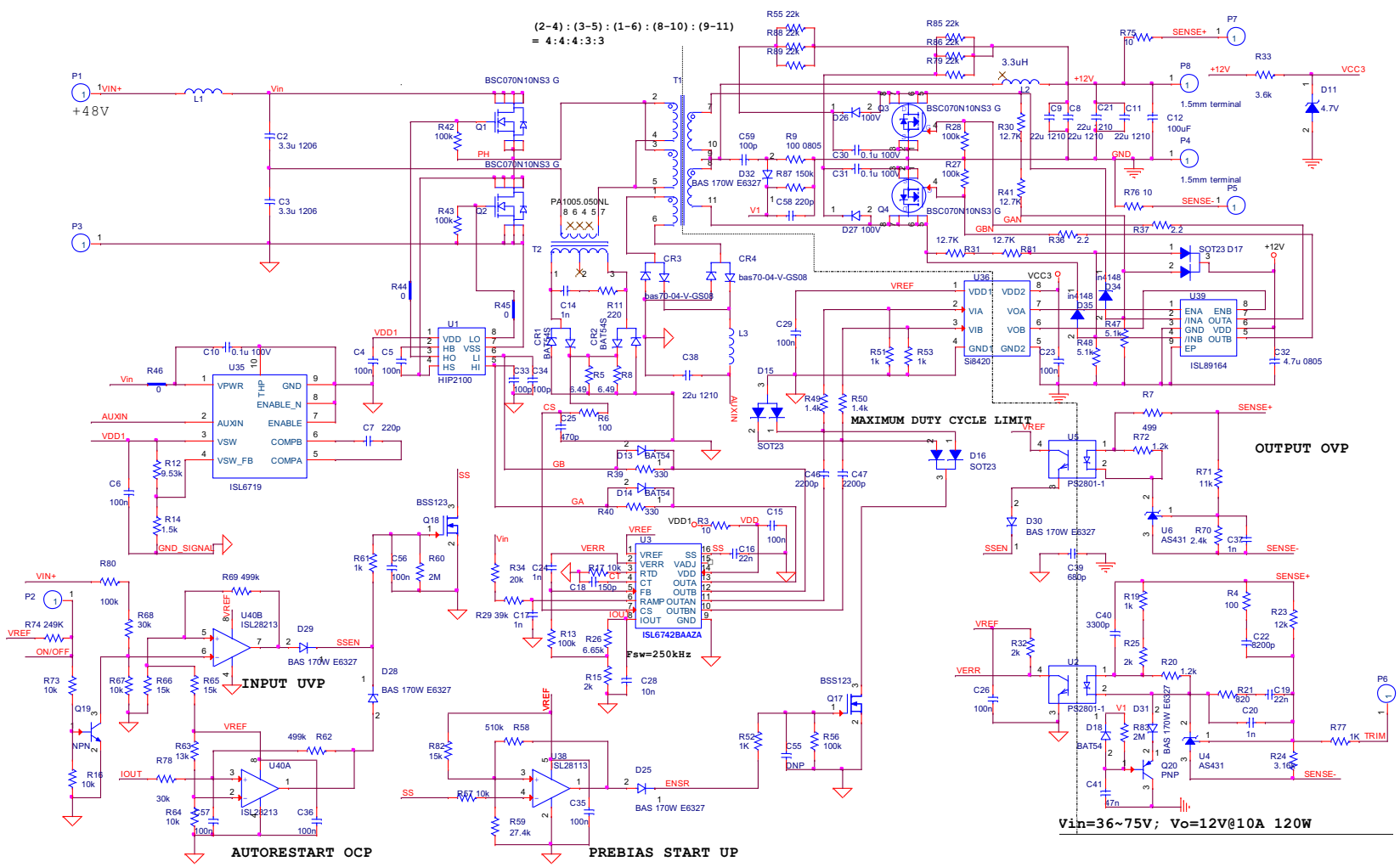

DNP: Do Not Populate

Typical Performance Curves

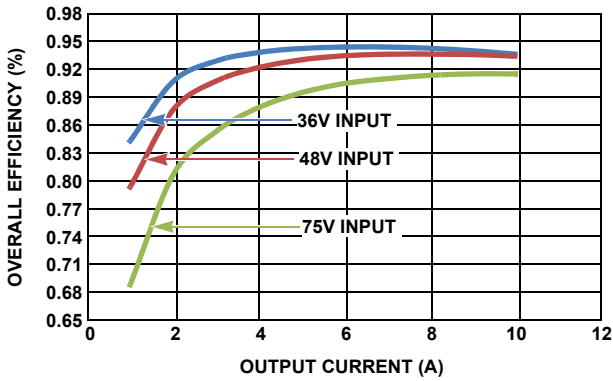

FIGURE 5. OVERALL EFFICIENCY vs LOAD CURRENT

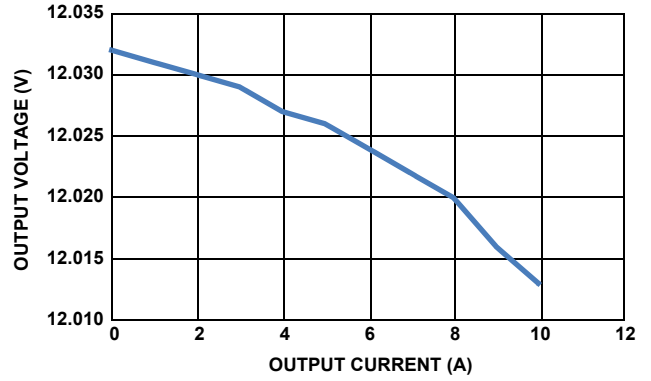

FIGURE 6. LOAD REGULATION @ 36V INPUT

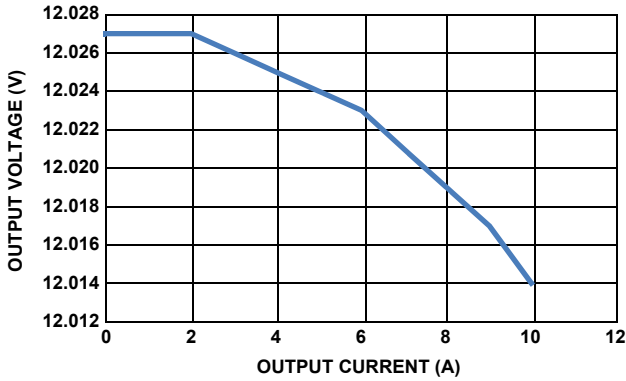

FIGURE 7. LOAD REGULATION AT 48V INPUT

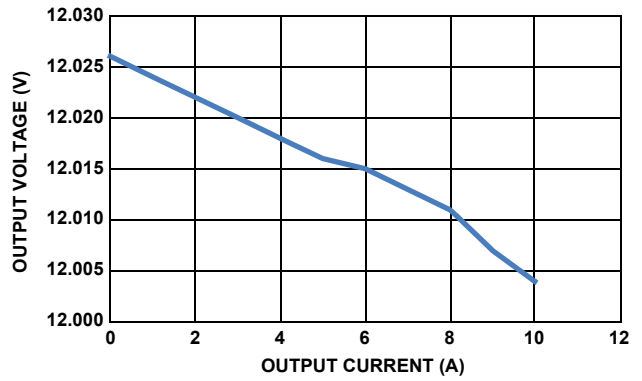

FIGURE 8. LOAD REGULATION AT 75V INPUT

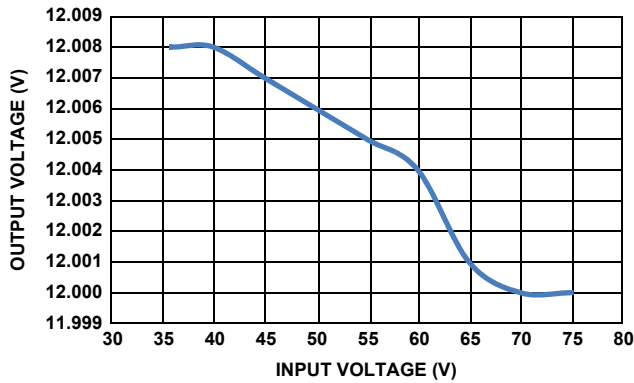

FIGURE 9. LINE REGULATION AT FULL LOAD

Output Voltage Ripples and Noises



400ns

FIGURE 10. 36V INPUT, FULL LOAD, 14.2mV, CH1, OUTPUT VOLTAGE



1.00µs

FIGURE 11. 48V INPUT, FULL LOAD, 18.6mV, CH1, OUTPUT VOLTAGE



400ns

FIGURE 12. 75V INPUT, FULL LOAD, 40mV, CH1, OUTPUT VOLTAGE

Output Transient Responses

Step Load between 2.5A and 7.5A (25% ~ 75%) at 1A/µs.



2.00ms

FIGURE 13. 36V INPUT, CH1: OUTPUT VOLTAGE, CH4: LOAD CURRENT

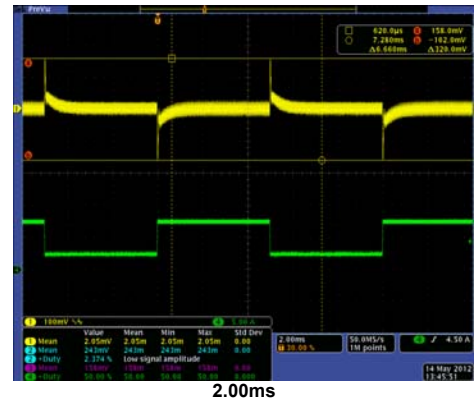

2.00ms

FIGURE 14. 48V INPUT, CH1: OUTPUT VOLTAGE, CH4: LOAD CURRENT

Output Transient Responses

Step Load between 2.5A and 7.5A (25% ~ 75%) at 1A/μs. (Continued)

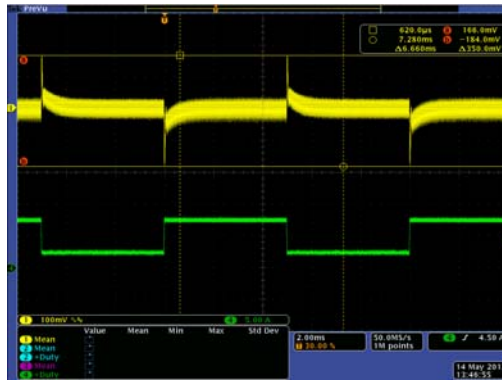

2.00ms

FIGURE 15. 75V INPUT, CH1: OUTPUT VOLTAGE, CH4: LOAD CURRENT

Start-up and Shutdown

36V Input



100ms

FIGURE 16. NO LOAD START-UP, CH1: OUTPUT VOLTAGE, CH2: INPUT VOLTAGE, CH4: LOAD CURRENT

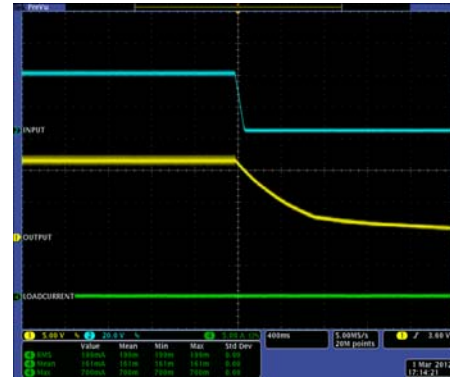

400ms

FIGURE 17. NO LOAD SHUTDOWN, CH1: OUTPUT VOLTAGE, CH2: INPUT VOLTAGE, CH4: LOAD CURRENT



100ms

FIGURE 18. FULL LOAD START-UP, CH1: OUTPUT VOLTAGE, CH2: INPUT VOLTAGE, CH4: LOAD CURRENT



100ms

FIGURE 19. FULL LOAD SHUTDOWN, CH1: OUTPUT VOLTAGE, CH2: INPUT VOLTAGE, CH4: LOAD CURRENT

Start-up and Shutdown (Continued)

48V Input

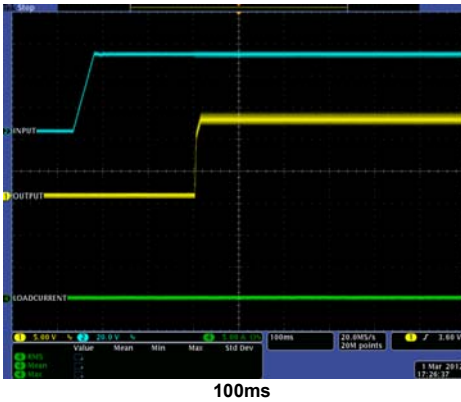

100ms

FIGURE 20. NO LOAD START-UP, CH1: OUTPUT VOLTAGE, CH2: INPUT VOLTAGE, CH4: LOAD CURRENT

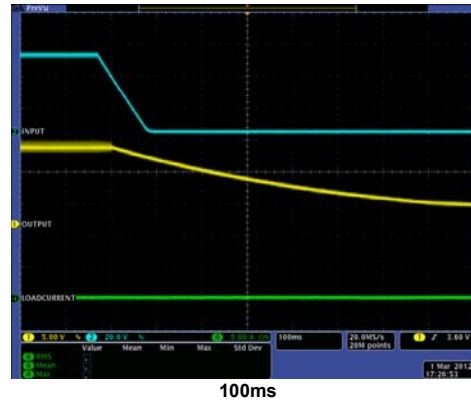

100ms

FIGURE 21. NO LOAD SHUTDOWN, CH1: OUTPUT VOLTAGE, CH2: INPUT VOLTAGE, CH4: LOAD CURRENT

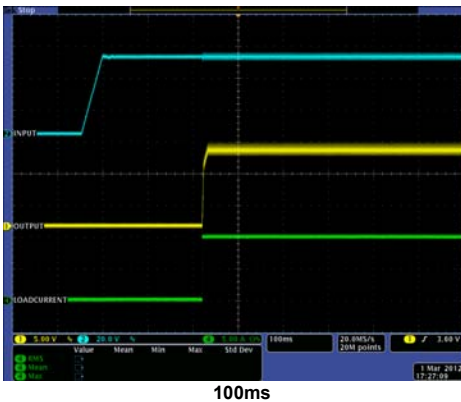

100ms

FIGURE 22. FULL LOAD START-UP, CH1: OUTPUT VOLTAGE, CH2: INPUT VOLTAGE, CH4: LOAD CURRENT

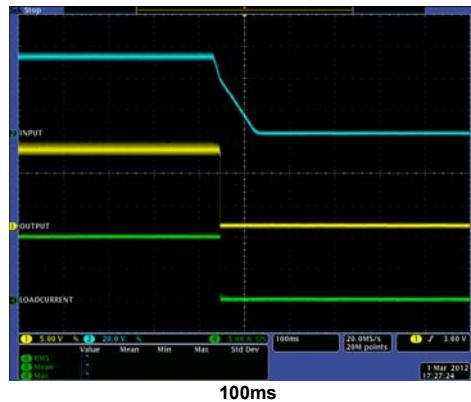

100ms

FIGURE 23. FULL LOAD SHUTDOWN, CH1: OUTPUT VOLTAGE, CH2: INPUT VOLTAGE, CH4: LOAD CURRENT

75V Input

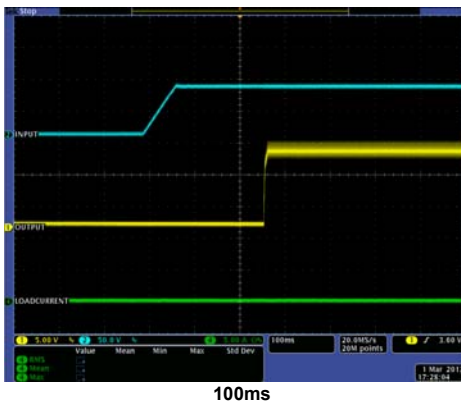

100ms

FIGURE 24. NO LOAD START-UP, CH1: OUTPUT VOLTAGE, CH2: INPUT VOLTAGE, CH4: LOAD CURRENT

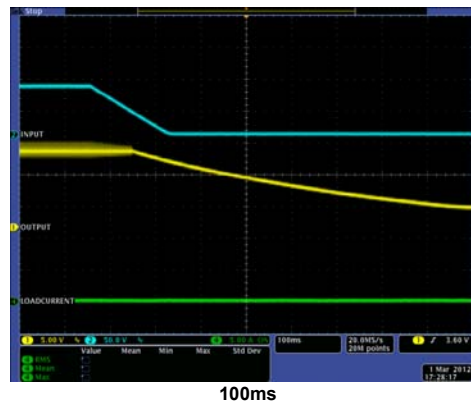

100ms

FIGURE 25. NO LOAD SHUTDOWN, CH1: OUTPUT VOLTAGE, CH2: INPUT VOLTAGE, CH4: LOAD CURRENT

Start-up and Shutdown (Continued)

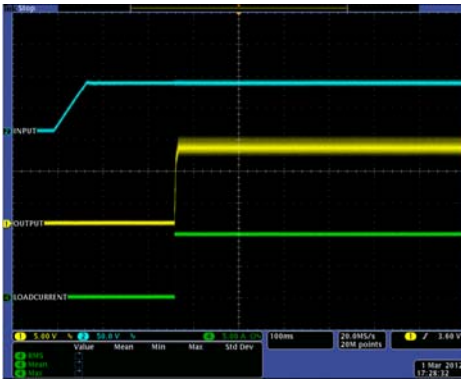

100ms

FIGURE 26. FULL LOAD START-UP, CH1: OUTPUT VOLTAGE, CH2: INPUT VOLTAGE, CH4: LOAD CURRENT



100ms

FIGURE 27. FULL LOAD SHUTDOWN, CH1: OUTPUT VOLTAGE, CH2: INPUT VOLTAGE, CH4: LOAD CURRENT

Overcurrent Protection and Short Protection

The OCP trigger point is ~13.5A at 36V input, ~13A at 48V input, ~13A at 75V input.

36V Input



40.0ms

FIGURE 28. OVERCURRENT PROTECTION, CH1: OUTPUT VOLTAGE, CH2: VOLTAGE ON C3, CH3: Vds OF Q4_SR, CH4: LOAD CURRENT



1.00µs

FIGURE 29. ZOOM IN, CH1: OUTPUT VOLTAGE, CH2: VOLTAGE ON C3, CH3: Vds OF Q4_SR, CH4: LOAD CURRENT



40.0ms

FIGURE 30. SHORT CIRCUIT, CH1: OUTPUT VOLTAGE, CH2: VOLTAGE ON C3, CH3: Vds OF Q4_SR, CH4: LOAD CURRENT



1.00µs

FIGURE 31. ZOOM IN, CH1: OUTPUT VOLTAGE, CH2: VOLTAGE ON C3, CH3: Vds OF Q4_SR, CH4: LOAD CURRENT

Overcurrent Protection and Short Protection

The OCP trigger point is ~13.5A at 36V input, ~13A at 48V input, ~13A at 75V input. (Continued)

48V Input

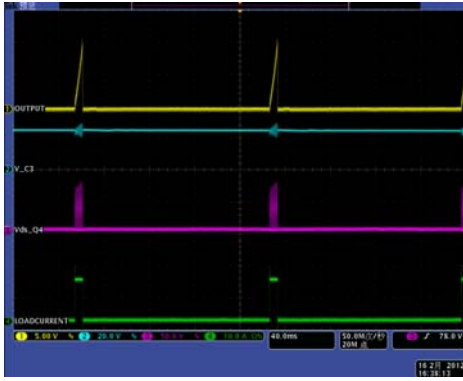

FIGURE 32. OVERCURRENT PROTECTION, CH1: OUTPUT VOLTAGE, CH2: VOLTAGE ON C3, CH3: Vds OF Q4_SR, CH4: LOAD CURRENT



FIGURE 33. ZOOM IN, CH1: OUTPUT VOLTAGE, CH2: VOLTAGE ON C3, CH3: Vds OF Q4_SR, CH4: LOAD CURRENT



FIGURE 34. SHORT CIRCUIT, CH1: OUTPUT VOLTAGE, CH2: VOLTAGE ON C3, CH3: Vds OF Q4_SR, CH4: LOAD CURRENT



FIGURE 35. ZOOM IN, CH1: OUTPUT VOLTAGE, CH2: VOLTAGE ON C3, CH3: Vds OF Q4_SR, CH4: LOAD CURRENT

75V Input

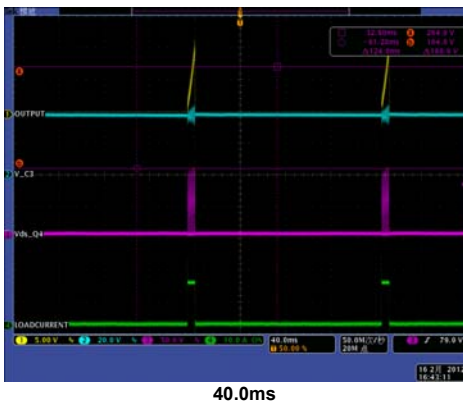

FIGURE 36. OVERCURRENT PROTECTION, CH1: OUTPUT VOLTAGE, CH2: VOLTAGE ON C3, CH3: Vds OF Q4_SR, CH4: LOAD CURRENT



FIGURE 37. ZOOM IN, CH1: OUTPUT VOLTAGE, CH2: VOLTAGE ON C3, CH3: Vds OF Q4_SR, CH4: LOAD CURRENT

Overcurrent Protection and Short Protection

The OCP trigger point is ~13.5A at 36V input, ~13A at 48V input, ~13A at 75V input. (Continued)

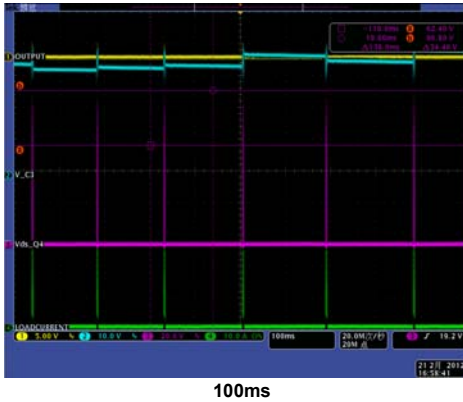

FIGURE 38. SHORT CIRCUIT, CH1: OUTPUT VOLTAGE, CH2: VOLTAGE ON C3, CH3: Vds OF Q4_SR, CH4: LOAD CURRENT

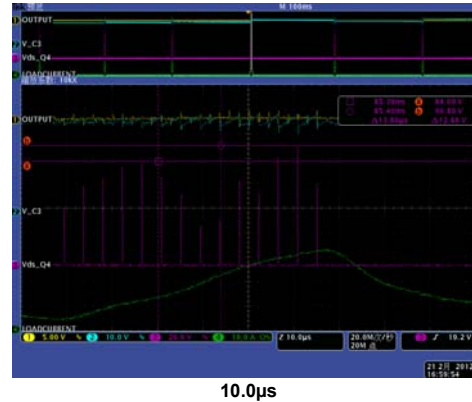

FIGURE 39. ZOOM IN, CH1: OUTPUT VOLTAGE, CH2: VOLTAGE ON C3, CH3: Vds OF Q4_SR, CH4: LOAD CURRENT

Input Undervoltage Protection

Trigger point is ~34V.

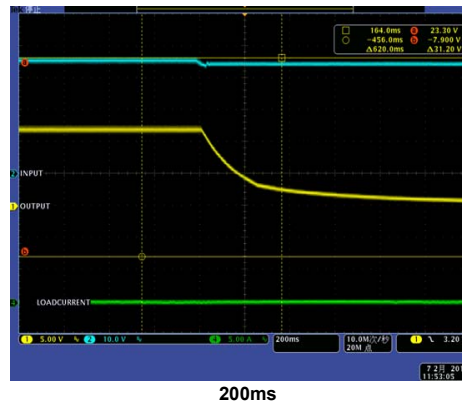

FIGURE 40. CH1: OUTPUT VOLTAGE, CH2: INPUT VOLTAGE, CH4: LOAD CURRENT

Prebias Start-up

Turn off and turn on quickly with no load and large output capacitance condition. The output voltage increases from a 9.3V pre-bias level. Test with 48V input; no load condition.

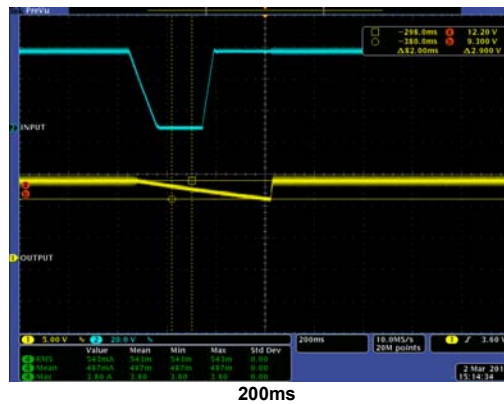

FIGURE 41. CH1: OUTPUT VOLTAGE, CH2: INPUT VOLTAGE

Maximum Duty Cycle Limit

The duty cycle of SR is limited in order to prevent the current flows back from the output at shutdown.

Shutdown at 48V input with no load and the driver signal of SR(Q4) is limited compared with the original one produced by the controller ISL6742B.

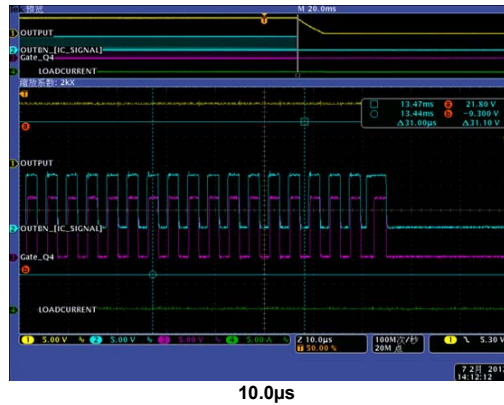

FIGURE 42. CH1: OUTPUT VOLTAGE, CH2: OUTBN_IC PIN 10, CH3: GATE SINGLE OF Q4, CH4: LOAD CURRENT

Adaptive Dead Time of SR

Compared with the original signal produced by ISL6742B, the driver signal of SR (Q4) is adaptive with the Vds of Q4 and this function makes better efficiency.

Q4 is turned on after its Vds decrease to zero and the body diode is conducting.

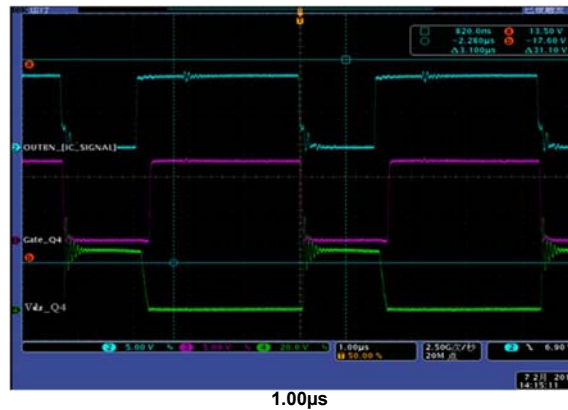

FIGURE 43. CH2: OUTBN_IC PIN 10, CH3: GATE SINGLE OF Q4, CH4: Vds of Q4_SR

Output Overvoltage Protection

Output OVP is triggered when the voltage of output is ~14V.

Test the function with open loop and increase the input voltage.

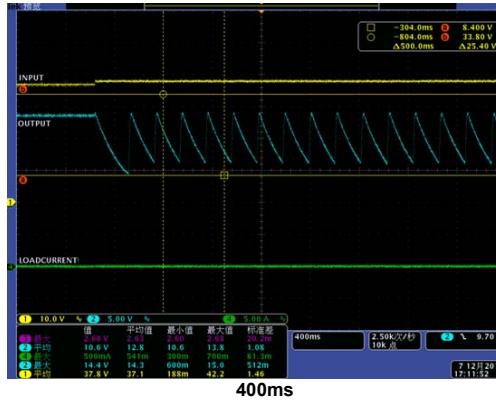

FIGURE 44. CH1: INPUT VOLTAGE, CH2: OUTPUT VOLTAGE, CH4: LOAD CURRENT

On/Off Function

Enable and disable function. Test at 48V input.

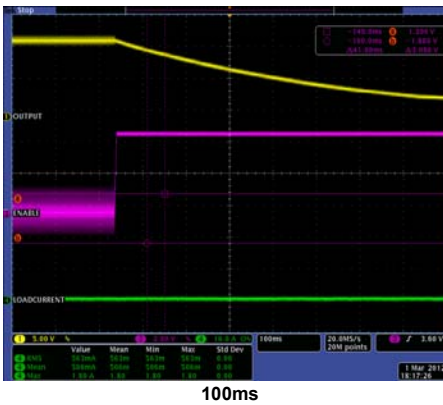

FIGURE 45. DISABLE WITHOUT LOAD, CH1: OUTPUT VOLTAGE, CH3: ON/OFF TERMINAL, CH4: LOAD CURRENT

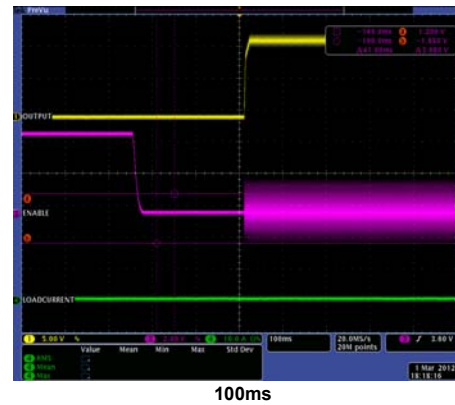

FIGURE 46. ENABLE WITHOUT LOAD, CH1: OUTPUT VOLTAGE, CH3: ON/OFF TERMINAL, CH4: LOAD CURRENT

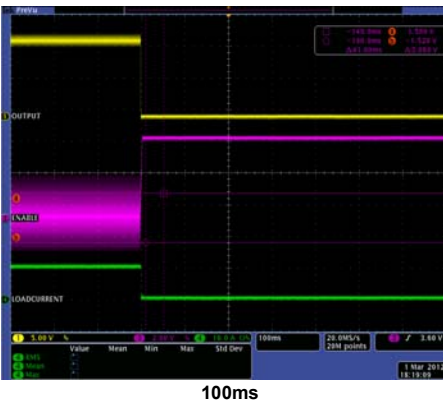

FIGURE 47. DISABLE WITH FULL LOAD, CH1: OUTPUT VOLTAGE, CH3: ON/OFF TERMINAL, CH4: LOAD CURRENT

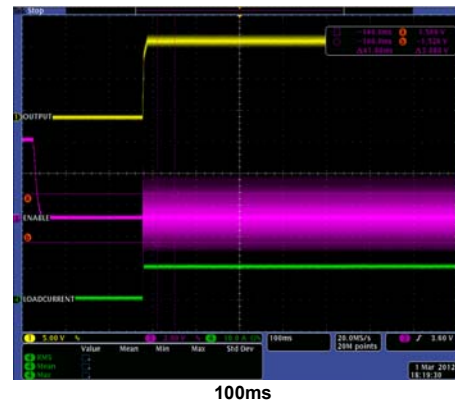

FIGURE 48. ENABLE WITH FULL LOAD, CH1: OUTPUT VOLTAGE, CH3: ON/OFF TERMINAL, CH4: LOAD CURRENT

Bill of Materials

ITEM	QTY	REFERENCE	DESCRIPTIONS	MFG	MFG PART NUMBER
1	2	CR1 CR2	DIODE SCHOTTKY, 30V, 200mA, SOT-23	Fairchild Semiconductor	BAT54S
2	2	CR3, CR4	DIODE SCHOTTKY, DUAL, 70V/100mA SOT-23	Vishay	bas70-04-V-GS08
3	2	C2, C3	CAP, CER, 3.3µF, 50V, X7R 10% 1206	TDK	C3216X7R1H335K
4	2	C4, C6	CAP, CER, 0.1µF, 16V, 10%, X7R, 0603	MURATA	GRM188R71C104KA01D
5	10	C5, C15, C23, C26, C29, C35, C36, C55, C56, C57	CAP, CER, 0.1µF, 16V, 10% X7R, 0402	MURATA	GRM155R71C104KA88D
6	2	C7, C58	CAP, CER, 220pF, 50V, 5%, NP0, 0402	MURATA	GRM1555C1H221JA01D
7	5	C8, C9, C11, C21, C38	CAP, CER, 22µF, 16V, X7R, 1210	TDK	C3225X7R1C226K
8	3	C10, C30, C31	CAP, CER, 0.1µF, 100V, X7R, 0603	MURATA	GRM188R72A104KA35D
9	1	C12	POSCAP, 20V, 100µF, D3L	Sanyo	20TQC100MYF
10	5	C14, C17, C20, C24, C37	CAP, CER, 1000pF, 50V, 10%, X7R, 0402	MURATA	GRM155R71H102KA01D
11	2	C16, C19	CAP, CER, 0.022µF, 16V, 10%, X7R, 0402	MURATA	GRM155R71C223KA01D
12	1	C18	CAP, CER, 150pF, 50V, 5%, NP0, 0402	MURATA	GRM1555C1H151JA01D
13	1	C22	CAP, CER, 8200pF, 50V, 10%, X7R, 0402	MURATA	GRM155R71H822KA88D
14	1	C25	CAP, CER, 470pF, 50V, 5%, NP0, 0402	MURATA	GRM1555C1H471JA01D
15	1	C28	CAP, CER, 10000pF, 16V, 10%, X7R, 0402	MURATA	GRM155R71C103KA01D
16	1	C32	CAP, CER, 4.7µF, 16V, X7R, 0805	MURATA	GRM21BR71C475KA73L
17	3	C33, C34, C59	CAP, CER, 100pF, 50V, 5%, NP0, 0402	MURATA	GRM1555C1H101JZ01D
18	1	C39	CAP, CER, 680pF, 250V, 10%, X7R, 1808	MURATA	GA342QR7GD681KW01L
19	1	C40	CAP, CER, 3300pF, 50V, 10%, X7R, 0402	MURATA	GRM155R71H332KA01D
20	1	C41	CAP, CER, 0.047µF, 50V, 10%, X7R, 0402	TDK Corporation	C1005X7R1H473K
21	2	C46, C47	CAP, CER, 2200pF, 50V, 10%, X7R, 0402	MURATA	GRM155R71H222KA01D
22	1	D11	DIODE ZENER, 4.7V, 500MW, SOD-123	Diodes Inc	BZT52C4V7-13-F
23	3	D13, D14, D18	DIODE SCHOTTKY, 30V, SC-79	Infineon Technologies	BAT 54-02V E6327
24	1	D15	DIODE SCHOTTKY, 30V, 200mA, SOT-23	Fairchild Semiconductor	BAT54A
25	2	D16, D17	DIODE SCHOTTKY, 30V, 200mA, SOT-23	Fairchild Semiconductor	BAT54C
26	6	D25, D28, D29, D30, D31, D32	DIODE SCHOTTKY, 70V, 70mA, SOD-323	Infineon Technologies	BAS 170W E6327
27	2	D26, D27	DIODE SCHOTTKY, 1A, 100V, SMA	Vishay	SS1H10-E3/61T
28	2	D34, D35	DIODE SWITCH, 100V, 400MW, SOD123	Diodes	1N4148W-7-F
29	1	L1	INDUCTOR SHIELD, PWR, 1µH SMD	Pulse	pg0083.102nl
30	1	L2	INDUCT PWR, 3.3µH SMD	Pulse	PG0138.332NL
31	1	L3	INDUCT FILTER, 220µH SMD	Coilcraft	DO1605T-224MLC
32	6	P1, P2, P3, P5, P6, P7	1mm Power Terminal	ZRX Inc	CZ118
33	2	P4, P8	1.5mm Power Terminal	ZRX Inc	CZ117
34	4	Q1, Q2, Q3, Q4	MOSFET, N-CH, 100V, 90A, TDSO8	Infineon Technologies	BSC070N10NS3 G
35	2	Q17, Q18	MOSFET, N-CH, 100V, 150mA, SOT-23	NXP Semiconductors	BSS123 215
36	1	Q19	TRANS, NPN, LP, 100mA, 45V, SOT23	ON Semiconductor	BC847ALT1G
37	1	Q20	TRANSISTOR, GP, PNP, AMP, SOT-23	Fairchild Semiconductor	MMBT3906
38	3	R3, R75, R76	RES, 10.0Ω, 1/16W, 1%, 0402, SMD	Yageo	RC0402FR-0710RL

Bill of Materials (Continued)

ITEM	QTY	REFERENCE	DESCRIPTIONS	MFG	MFG PART NUMBER
39	2	R4, R6	RES, 100Ω, 1/16W, 1%, 0402, SMD	Yageo	RC0402FR-07100RL
40	2	R5, R8	RES, 6.49Ω, 1/16W, 1%, 0402, SMD	Vishay/Dale	CRCW04026R49FKED
41	1	R7	RES, 499Ω, 1/16W, 1%, 0402, SMD	Yageo	RC0402FR-07499RL
42	1	R9	RES, 100Ω, 1/8W, 1%, 0805, SMD	Yageo	RC0805FR-07100RL
43	1	R11	RES, 220Ω, 1/16W, 1%, 0402, SMD	Yageo	RC0402FR-07220RL
44	1	R12	RES, 9.53kΩ, 1/16W, 1%, 0402, SMD	Yageo	RC0402FR-079K53L
45	7	R13, R27, R28, R42, R43, R56, R80	RES, 100kΩ, 1/16W, 1%, 0402, SMD	Yageo	RC0402FR-07100KL
46	1	R14	RES, 1.50kΩ, 1/16W, 1%, 0402, SMD	Yageo	RC0402FR-071K5L
47	3	R15, R25, R32	RES, 2.00kΩ, 1/16W, 1%, SMD, 0402	Yageo	RT0402FRE072KL
48	6	R16, R17, R57, R64, R67, R73	RES, 10.0kΩ, 1/16W, 1%, 0402, SMD	Yageo	RC0402FR-0710KL
49	6	R19, R51, R52, R53, R61, R77	RES, 1.00kΩ, 1/16W, 1%, 0402, SMD	Yageo	RC0402FR-071KL
50	2	R20, R72	RES, 1.20kΩ, 1/16W, 1%, 0402, SMD	Yageo	RC0402FR-071K2L
51	1	R21	RES, 820Ω, 1/16W, 1%, 0402, SMD	Yageo	RC0402FR-07820RL
52	1	R23	RES, 12.0kΩ, 1/16W, 1%, 0402, SMD	Yageo	RC0402FR-0712KL
53	1	R24	RES, 3.16kΩ, 1/16W, 1%, SMD, 0402	Yageo	RT0402FRE073K16L
54	1	R26	RES, 6.65kΩ, 1/16W, 1%, SMD, 0402	Yageo	RT0402FRE076K65L
55	1	R29	RES, 39.0kΩ, 1/16W, 1%, 0402, SMD	Yageo	RC0402FR-0739KL
56	4	R30, R31, R41, R81	RES, 12.7kΩ, 1/16W, 1%, SMD, 0402	Yageo	RT0402FRE0712K7L
57	1	R33	RES, 3.60kΩ, 1/16W, 1%, SMD, 0402	Yageo	RT0402FRE073K6L
58	1	R34	RES, 20.0kΩ, 1/16W, 1%, 0402, SMD	Yageo	RC0402FR-0720KL
59	2	R36, R37	RES, 2.20Ω, 1/16W, 1%, 0402, SMD	Yageo	RC0402FR-072R2L
60	2	R39, R40	RES, 330Ω, 1/16W, 1%, 0402, SMD	Yageo	RC0402FR-07330RL
61	3	R44, R45, R46	RES, 0.0Ω, 1/16W, 0402, SMD	Yageo	RC0402JR-070RL
62	2	R47, R48	RES, 5.10kΩ, 1/16W, 1%, 0402, SMD	Yageo	RC0402FR-075K1L
63	2	R49, R50	RES, 1.40kΩ, 1/16W, 1%, SMD, 0402	Yageo	RT0402FRE071K4L
64	6	R55, R79, R85, R86, R88, R89	RES, SMD, 1/2W, 22kΩ, J 1206	WALSIN	WF12P223JTL
65	1	R58	RES, 510kΩ, 1/16W, 1%, 0402, SMD	Yageo	RC0402FR-07510KL
66	1	R59	RES, 27.4kΩ, 1/16W, 1%, 0402, SMD	Yageo	RC0402FR-0727K4L
67	2	R60, R83	RES, 2MΩ, 1/16W, 1%, 0402, SMD	Vishay/Dale	CRCW04022M00FKED
68	2	R62, R69	RES, 499kΩ, 1/16W, 1%, 0402, SMD	Yageo	RC0402FR-07499KL
69	1	R63	RES, 13.0kΩ, 1/16W, 1%, 0402, SMD	Yageo	RC0402FR-0713KL
70	3	R65, R66, R82	RES, 15.0kΩ, 1/16W, 1%, 0402, SMD	Yageo	RC0402FR-0715KL
71	2	R68, R78	RES, 30.0kΩ, 1/16W, 1%, 0402, SMD	Yageo	RC0402FR-0730KL
72	1	R70	RES, 2.40kΩ, 1/16W, 1%, 0402, SMD	Yageo	RC0402FR-072K4L
73	1	R71	RES, 11.0kΩ, 1/16W, 1%, 0402, SMD	Yageo	RC0402FR-0711KL
74	1	R74	RES, 249kΩ, 1/16W, 1%, 0402, SMD	Yageo	RC0402FR-07249KL
75	1	R87	RES, 150kΩ, 1/16W, 1%, 0402, SMD	Yageo	RC0402FR-07150KL

Bill of Materials (Continued)

ITEM	QTY	REFERENCE	DESCRIPTIONS	MFG	MFG PART NUMBER
76	1	T1	Main Transformer 4:4:4:3:3	WE-Midcom	midcom_750341282
77	1	T2	XFRMR CURR SENSE, 0.50MH, 1:50, SMD	Pulse	PA1005.050NL
78	1	U1	IC, MSFT DVR HALF-BRG, 100V, 8-SOIC	Intersil	HIP2100IB
79	2	U2, U5	OPTOISOLATOR, 1CH, TRANS OUT, 4SSOP	NEC	PS2801C-1-F3-A
80	1	U3	IC, CTRLR, PWM, DOUBLE-ENDED, SSOP16	Intersil	ISL6742BAAZA
81	2	U4, U6	IC, REG ADJ ZENER SHUNT, SOT23-3	BCD	AS431ANTRE1
82	1	U35	IC, REG LINEAR ADJ 9-DFN	Intersil	ISL6719ARZ
83	1	U36	IC, ISOLATOR, 2CH, 5.5V, 8-SOIC	Analog Devices Inc	SI8420AB-D-IS
84	1	U38	IC, OPAMP, GP RRIO, 2MHz SOT23-5	Intersil	ISL28113FHZ-T7
85	1	U39	MOSFET DRIVER, 2CH, 5.0V, 6A 8SOIC	Intersil	ISL89164FBEBZ
86	1	U40	IC, OPAMP, GP, RRIO, 2MHz, DUAL 8MSOP	Intersil	ISL28213FUZ

PCB Layout

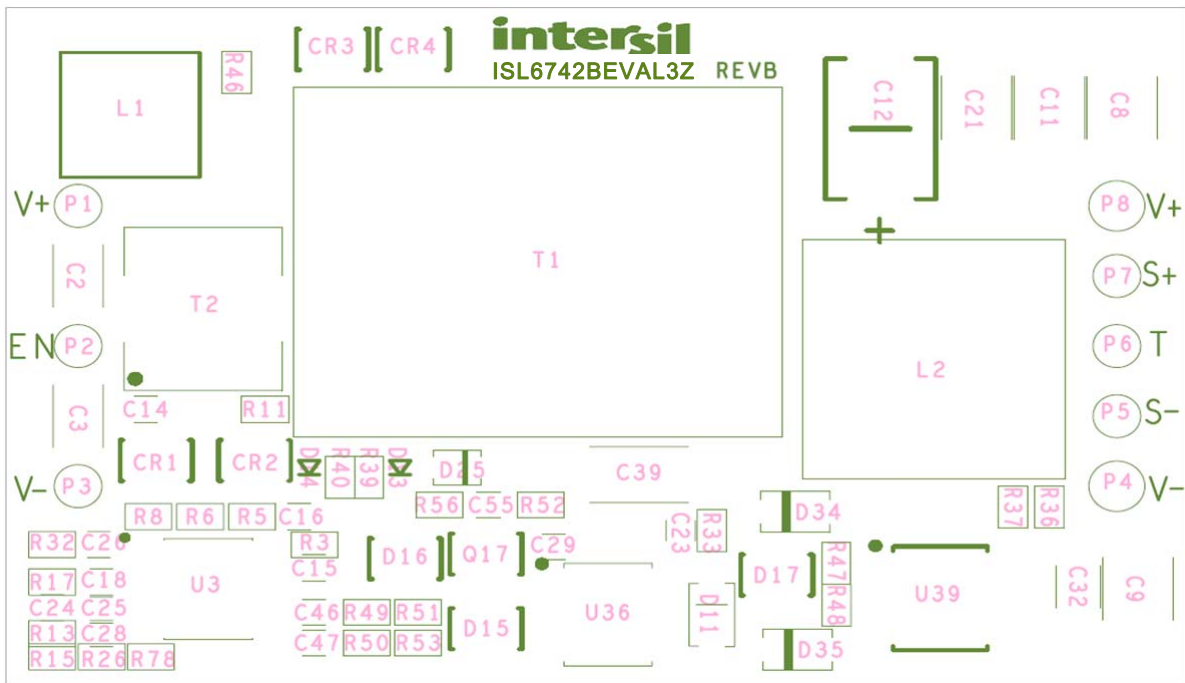

FIGURE 49. ASSEMBLY TOP

PCB Layout (Continued)

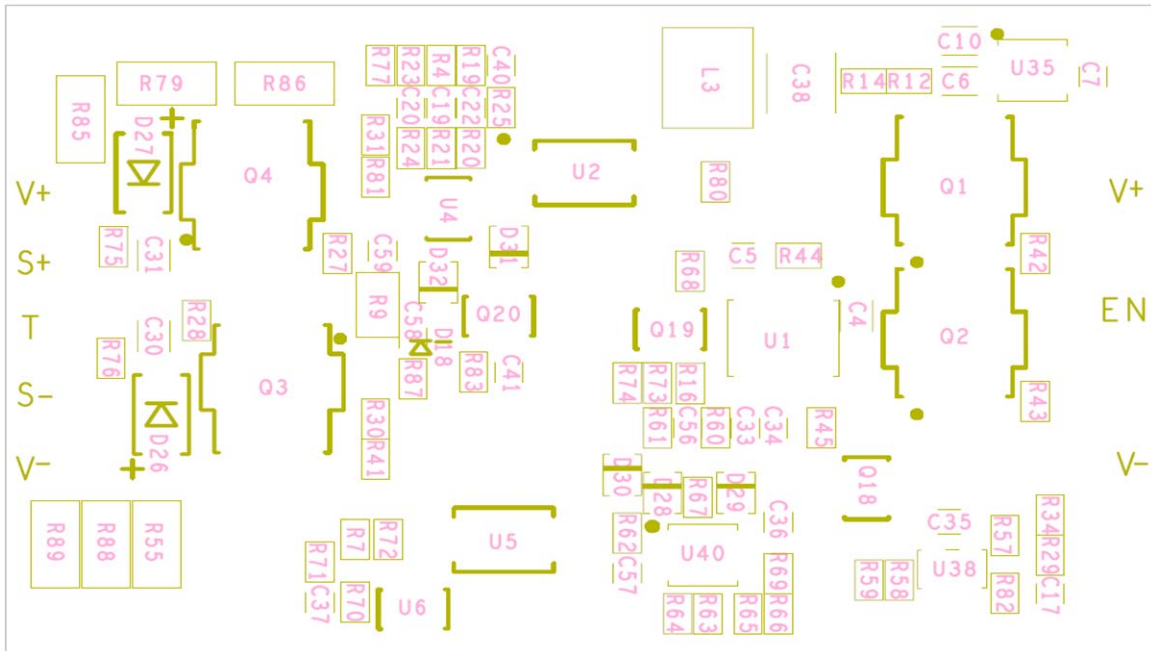

FIGURE 50. ASSEMBLY BOTTOM MIRRORED

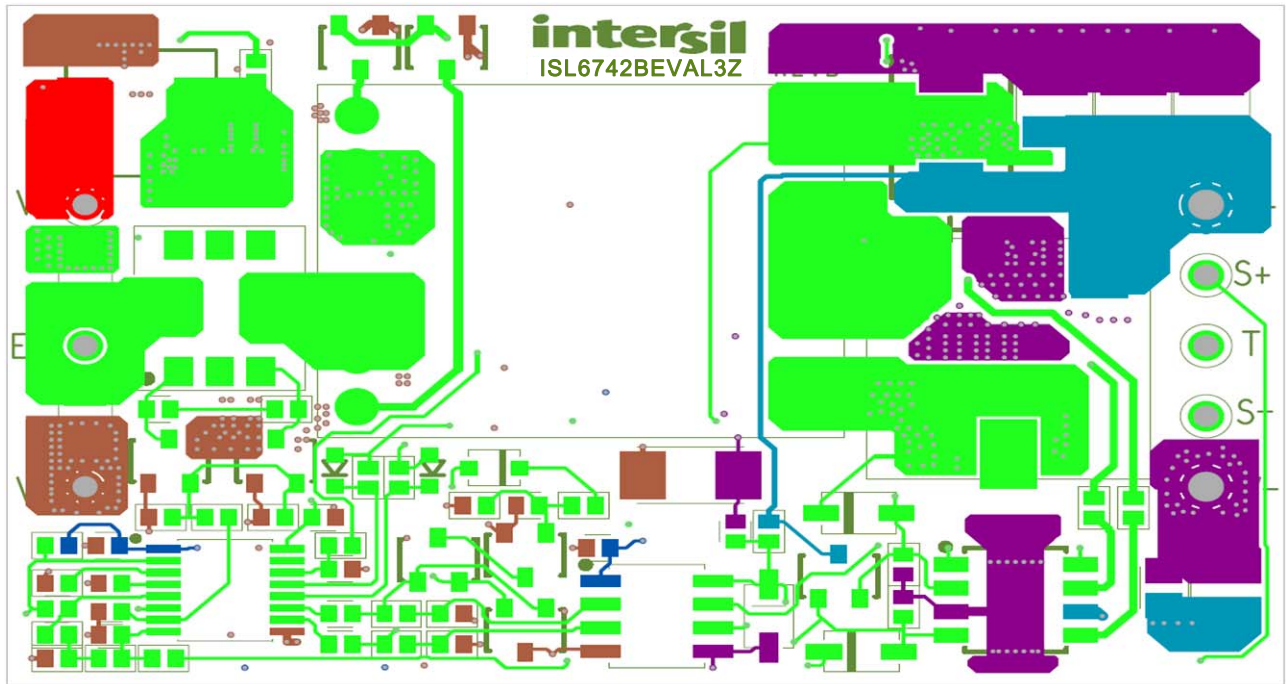

FIGURE 51. TOP LAYER

PCB Layout (Continued)

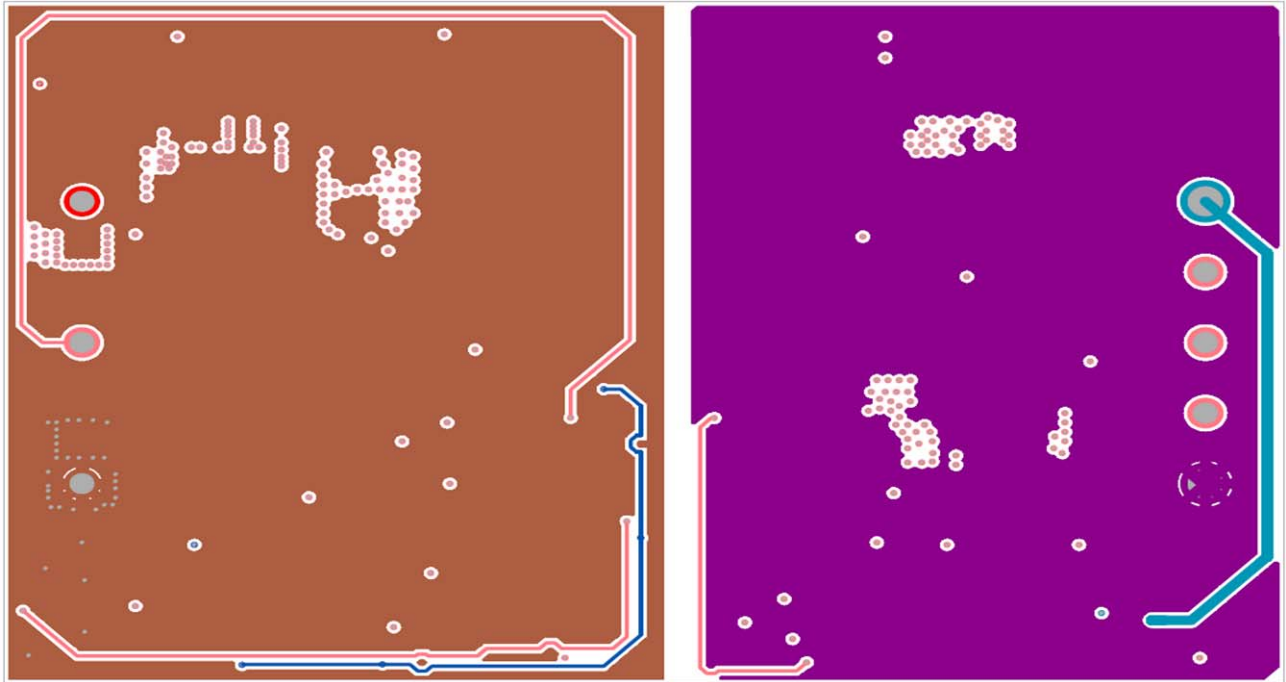

FIGURE 52. MID 1 LAYER

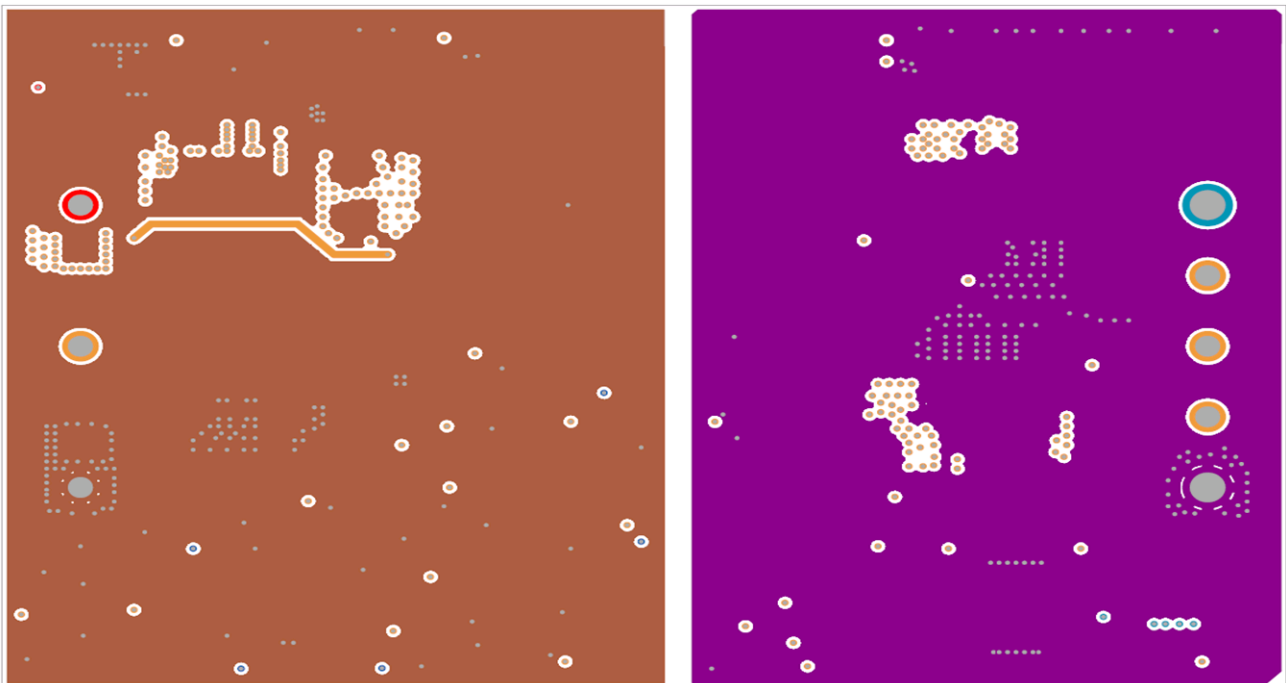

FIGURE 53. MID 2 LAYER

PCB Layout (Continued)

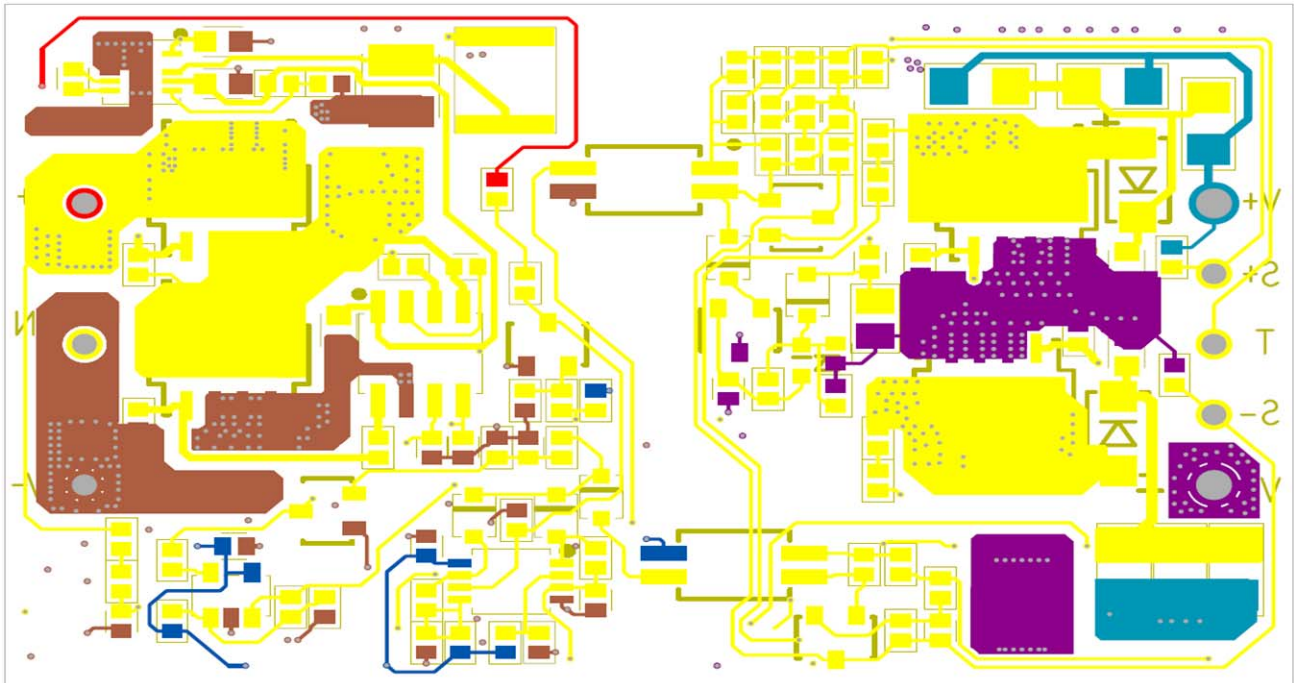

FIGURE 54. BOTTOM LAYER

Notice

1. Descriptions of circuits, software and other related information in this document are provided only to illustrate the operation of semiconductor products and application examples. You are fully responsible for the incorporation or any other use of the circuits, software, and information in the design of your product or system. Renesas Electronics disclaims any and all liability for any losses and damages incurred by you or third parties arising from the use of these circuits, software, or information.
2. Renesas Electronics hereby expressly disclaims any warranties against and liability for infringement or any other claims involving patents, copyrights, or other intellectual property rights of third parties, by or arising from the use of Renesas Electronics products or technical information described in this document, including but not limited to, the product data, drawings, charts, programs, algorithms, and application examples.
3. No license, express, implied or otherwise, is granted hereby under any patents, copyrights or other intellectual property rights of Renesas Electronics or others.
4. You shall not alter, modify, copy, or reverse engineer any Renesas Electronics product, whether in whole or in part. Renesas Electronics disclaims any and all liability for any losses or damages incurred by you or third parties arising from such alteration, modification, copying or reverse engineering.
5. Renesas Electronics products are classified according to the following two quality grades: "Standard" and "High Quality". The intended applications for each Renesas Electronics product depends on the product's quality grade, as indicated below.
"Standard": Computers; office equipment; communications equipment; test and measurement equipment; audio and visual equipment; home electronic appliances; machine tools; personal electronic equipment; industrial robots; etc.
"High Quality": Transportation equipment (automobiles, trains, ships, etc.); traffic control (traffic lights); large-scale communication equipment; key financial terminal systems; safety control equipment; etc.
Unless expressly designated as a high reliability product or a product for harsh environments in a Renesas Electronics data sheet or other Renesas Electronics document, Renesas Electronics products are not intended or authorized for use in products or systems that may pose a direct threat to human life or bodily injury (artificial life support devices or systems; surgical implantations; etc.), or may cause serious property damage (space system; undersea repeaters; nuclear power control systems; aircraft control systems; key plant systems; military equipment; etc.). Renesas Electronics disclaims any and all liability for any damages or losses incurred by you or any third parties arising from the use of any Renesas Electronics product that is inconsistent with any Renesas Electronics data sheet, user's manual or other Renesas Electronics document.
6. When using Renesas Electronics products, refer to the latest product information (data sheets, user's manuals, application notes, "General Notes for Handling and Using Semiconductor Devices" in the reliability handbook, etc.), and ensure that usage conditions are within the ranges specified by Renesas Electronics with respect to maximum ratings, operating power supply voltage range, heat dissipation characteristics, installation, etc. Renesas Electronics disclaims any and all liability for any malfunctions, failure or accident arising out of the use of Renesas Electronics products outside of such specified ranges.
7. Although Renesas Electronics endeavors to improve the quality and reliability of Renesas Electronics products, semiconductor products have specific characteristics, such as the occurrence of failure at a certain rate and malfunctions under certain use conditions. Unless designated as a high reliability product or a product for harsh environments in a Renesas Electronics data sheet or other Renesas Electronics document, Renesas Electronics products are not subject to radiation resistance design. You are responsible for implementing safety measures to guard against the possibility of bodily injury, injury or damage caused by fire, and/or danger to the public in the event of a failure or malfunction of Renesas Electronics products, such as safety design for hardware and software, including but not limited to redundancy, fire control and malfunction prevention, appropriate treatment for aging degradation or any other appropriate measures. Because the evaluation of microcomputer software alone is very difficult and impractical, you are responsible for evaluating the safety of the final products or systems manufactured by you.
8. Please contact a Renesas Electronics sales office for details as to environmental matters such as the environmental compatibility of each Renesas Electronics product. You are responsible for carefully and sufficiently investigating applicable laws and regulations that regulate the inclusion or use of controlled substances, including without limitation, the EU RoHS Directive, and using Renesas Electronics products in compliance with all these applicable laws and regulations. Renesas Electronics disclaims any and all liability for damages or losses occurring as a result of your noncompliance with applicable laws and regulations.
9. Renesas Electronics products and technologies shall not be used for or incorporated into any products or systems whose manufacture, use, or sale is prohibited under any applicable domestic or foreign laws or regulations. You shall comply with any applicable export control laws and regulations promulgated and administered by the governments of any countries asserting jurisdiction over the parties or transactions.
10. It is the responsibility of the buyer or distributor of Renesas Electronics products, or any other party who distributes, disposes of, or otherwise sells or transfers the product to a third party, to notify such third party in advance of the contents and conditions set forth in this document.
11. This document shall not be reprinted, reproduced or duplicated in any form, in whole or in part, without prior written consent of Renesas Electronics.
12. Please contact a Renesas Electronics sales office if you have any questions regarding the information contained in this document or Renesas Electronics products.
(Note 1) "Renesas Electronics" as used in this document means Renesas Electronics Corporation and also includes its directly or indirectly controlled subsidiaries.
(Note 2) "Renesas Electronics product(s)" means any product developed or manufactured by or for Renesas Electronics.

(Rev.4.0-1 November 2017)



SALES OFFICES

Renesas Electronics Corporation

<http://www.renesas.com>

Refer to "<http://www.renesas.com/>" for the latest and detailed information.

Renesas Electronics America Inc.
1001 Murphy Ranch Road, Milpitas, CA 95035, U.S.A.
Tel: +1-408-432-8888, Fax: +1-408-434-5351

Renesas Electronics Canada Limited
9251 Yonge Street, Suite 8309 Richmond Hill, Ontario Canada L4C 9T3
Tel: +1-905-237-2004

Renesas Electronics Europe Limited
Dukes Meadow, Millboard Road, Bourne End, Buckinghamshire, SL8 5FH, U.K
Tel: +44-1628-651-700, Fax: +44-1628-651-804

Renesas Electronics Europe GmbH
Arcadiastrasse 10, 40472 Düsseldorf, Germany
Tel: +49-211-6503-0, Fax: +49-211-6503-1327

Renesas Electronics (China) Co., Ltd.
Room 1709 Quantum Plaza, No.27 ZhichunLu, Haidian District, Beijing, 100191 P. R. China
Tel: +86-10-8235-1155, Fax: +86-10-8235-7679

Renesas Electronics (Shanghai) Co., Ltd.
Unit 301, Tower A, Central Towers, 555 Langao Road, Putuo District, Shanghai, 200333 P. R. China
Tel: +86-21-2226-0888, Fax: +86-21-2226-0999

Renesas Electronics Hong Kong Limited
Unit 1601-1611, 16/F., Tower 2, Grand Century Place, 193 Prince Edward Road West, Mongkok, Kowloon, Hong Kong
Tel: +852-2265-6688, Fax: +852-2886-9022

Renesas Electronics Taiwan Co., Ltd.
13F, No. 363, Fu Shing North Road, Taipei 10543, Taiwan
Tel: +886-2-8175-9600, Fax: +886-2-8175-9670

Renesas Electronics Singapore Pte. Ltd.
80 Bendemeer Road, Unit #06-02 Hyflux Innovation Centre, Singapore 339949
Tel: +65-6213-0200, Fax: +65-6213-0300

Renesas Electronics Malaysia Sdn.Bhd.
Unit 1207, Block B, Menara Amcorp, Amcorp Trade Centre, No. 18, Jln Persiaran Barat, 46050 Petaling Jaya, Selangor Darul Ehsan, Malaysia
Tel: +60-3-7955-9390, Fax: +60-3-7955-9510

Renesas Electronics India Pvt. Ltd.
No.777C, 100 Feet Road, HAL 2nd Stage, Indiranagar, Bangalore 560 038, India
Tel: +91-80-67208700, Fax: +91-80-67208777

Renesas Electronics Korea Co., Ltd.
17F, KAMCO Yangjae Tower, 262, Gangnam-daero, Gangnam-gu, Seoul, 06265 Korea
Tel: +82-2-558-3737, Fax: +82-2-558-5338