

ISL8002xDEMO1Z and ISL80019xDEMO1Z

Demonstration Board

AN1817
Rev 1.00
March 10, 2015

Description

The ISL8002, ISL80019, ISL8002A, ISL8002D and ISL80019A DEMO1Z kits are intended for use by individuals with requirements for Point-of-Load applications sourcing from 2.7V to 5.5V. The ISL8002DEMO1Z and ISL80019DEMO1Z boards are used to demonstrate the performance of the ISL8002 and ISL80019 low quiescent current mode converters.

The ISL8002 and ISL8019 are offered in a 8 pin 2mmx2mm TDFN package with 1mm maximum height. The complete converter occupies less than 64mm² area.

TABLE 1. KEY DIFFERENCES BETWEEN FAMILY OF PARTS

PART#	I _{OUT} (MAX) (A)	F _{SW} (MHz)	V _{IN} RANGE (V)	V _{OUT} RANGE (V)	PACKAGE SIZE
ISL80019	1.5	1	2.7 to 5.5	0.6 to 5.5	8 pin 2mmx2mm TDFN
ISL80019A	1.5	2			
ISL8002	2	1			
ISL8002A	2	2			
ISL8002D	2	2			

Key Features

- High efficiency synchronous buck regulator with up to 95% efficiency
- 0.8% reference accuracy over temperature/load/line
- Start-up with prebiased output
- Internal soft-start - 1ms
- Soft-stop output discharge during disable
- 1MHz, 2MHz default frequency
- Negative OC protection

Ordering Information

PART NUMBER	DESCRIPTION
ISL8002DEMO1Z	Switching frequency 1MHZ; Output current: 2A; PG rising /falling delay time: 1ms/15µs
ISL8002ADEMO1Z	Switching frequency 2MHZ; Output current: 2A; PG rising /falling delay time: 1ms/15µs
ISL80019DEMO1Z	Switching frequency 1MHZ ; Output current: 1.5A; PG rising /falling delay time: 1ms/15µs
ISL80019ADEMO1Z	Switching frequency 2MHZ; Output current: 1.5A; PG rising /falling delay time: 1ms/15µs
ISL8002DDEMO1Z	Switching frequency 2MHZ; Output current: 2A; PG rising /falling delay time: 390µs/330µs

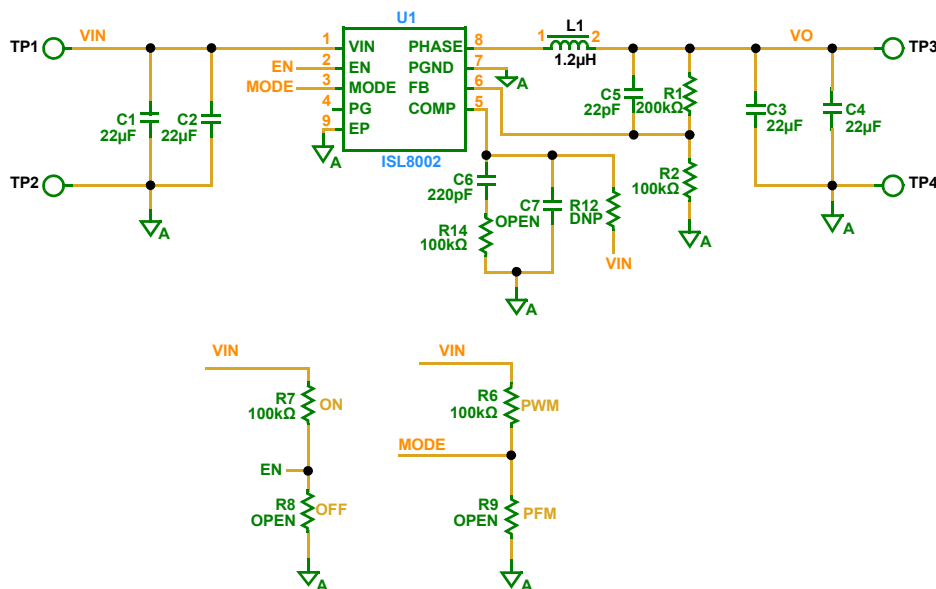

FIGURE 1. ISL8002DEMO1Z SCHEMATIC

ISL8002EVAL2Z Evaluation Board

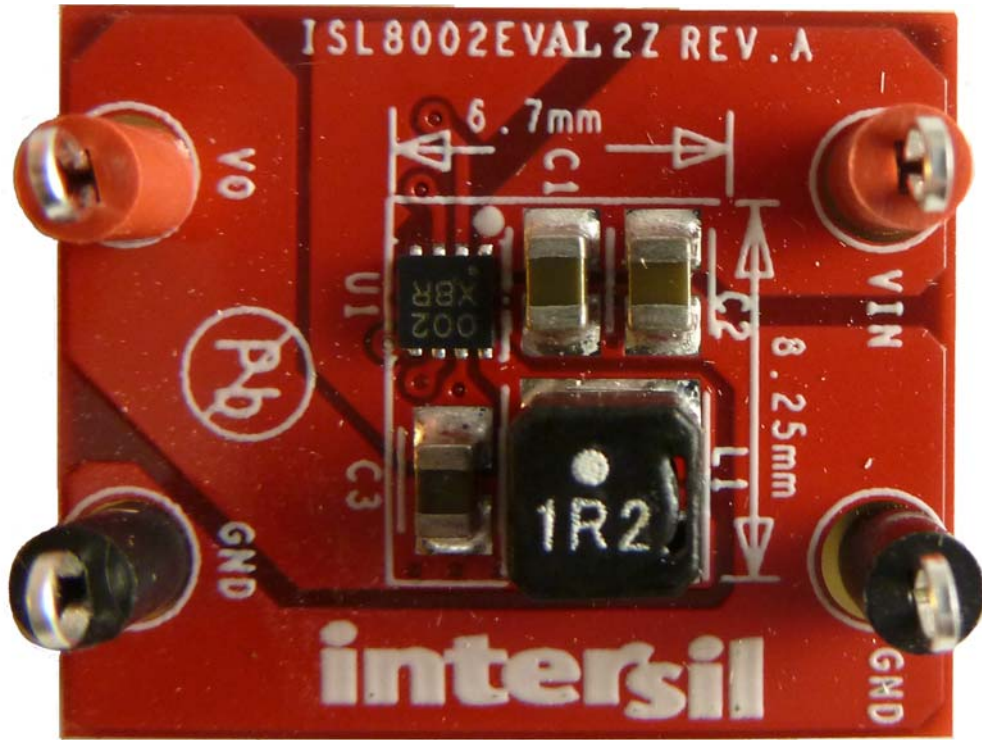

FIGURE 2. TOP SIDE

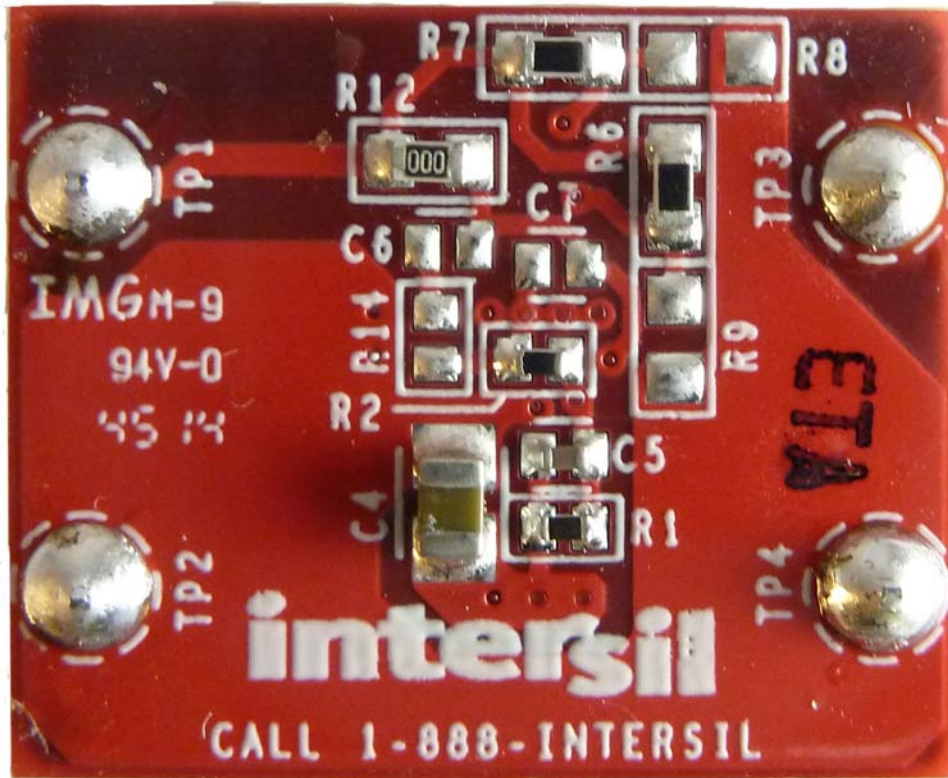

FIGURE 3. BOTTOM SIDE

Quick Setup Guide

1. Ensure that the circuit is correctly connected to the supply and loads prior to applying any power.
2. Connect the bias supply to V_{IN} . Plus terminal to V_{IN} (TP1) and negative return to PGND (TP2).
3. Connect the output load to V_O (TP3), and the negative return to PGND (TP4).
4. Turn on the power supply.
5. Verify the output voltage is 1.8V for V_{OUT} .

Recommended Equipment

The following materials are recommended to perform testing:

- 0V to 10V power supply with at least 5A source current capability or 5V battery
- Electronic loads capable of sinking current up to 7A
- Digital Multimeters (DMMs)
- 100MHz quad-trace oscilloscope

Signal generator

PCB Layout Guidelines

The PCB layout is a very important converter design step to make sure the designed converter works well. The power loop is composed of the output inductor (L's), the output capacitor (CO_{UT}), the PHASE's pin and the PGND pin. It is necessary to make the power loop as small as possible and the connecting traces among them should be direct, short and wide. The switching node of the converter, the PHASE pins, and the traces connected to the node are very noisy, so keep the voltage feedback trace away from these noisy traces. The input capacitor should be placed as closely as possible to the VIN pin and the ground of the input and output capacitors should be connected as closely as possible. The heat of the IC is mainly dissipated through the thermal pad. Maximizing the copper area connected to the thermal pad is preferable. In addition, a solid ground plane is helpful for better EMI performance. It is recommended to add at least 4 vias ground connection within the pad for best thermal relief.

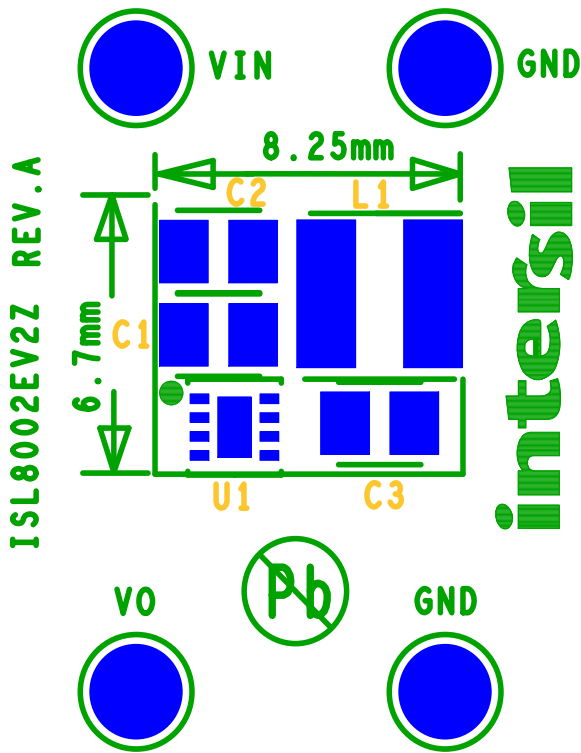

FIGURE 4. SILKSCREEN TOP

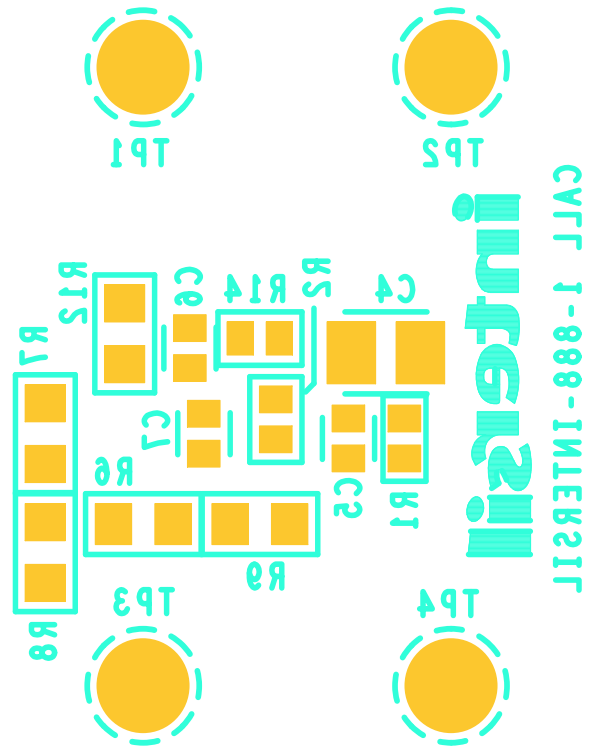

FIGURE 5. SILKSCREEN BOTTOM

TABLE 2. BILL OF MATERIALS

PART NUMBER	QTY	UNITS	REFERENCE DESIGNATOR	COMMENT	DESCRIPTION	MANUFACTURER	MANUFACTURER PART
H1044-00220-50V5-T	1	ea.	C5		CAP, SMD, 0402, 22pF, 50V, 5%, NPO	MURATA PANASONIC	GRM36COG220J050AQ ECU-E1H220JCQ
H1044-00221-50V5-T	1	ea.	C6		CAP, SMD, 0402, 220pF, 50V, 5%, COG	PANASONIC, TDK	ECU-E1H221JCQ C1005C0G1H221J
H1044-DNP	0	ea.	C7		CAP, SMD, 0402, DNP-PLACE HOLDER		
H1046-00226-6R3V10-T	4	ea.	C1, C2, C3, C4		CAP, SMD, 0805, 22µF, 6.3V, 10%, X5R, ROHS	JOHANSON DIELECTRICS INC	6R3R15X226KV4E JMK212BJ226KG-T
VLCF-4028T-1R2N2R7-2	1	ea.	L1 for ISL8002A, ISL80019A, 2MHz	COIL-PWR INDUCTOR, WW, SMD, 4mm, 1.2µH, 30%, 2.7A, ROHS	TDK	VLCF4028T-1R2N2R7-2	VLCF4028T-1R2N2R7-2
74437324022	1	ea.	L1 for ISL8002, ISL80019, 1MHz	COIL-PWR INDUCTOR, SMD, 4.45x4.6, 2.2µH, 20%, 3.25A, ROHS	Würth Electronics	74437324022	
ISL8002IRZ	1	ea.	U1		IC-2A BUCK REGULATOR, 8P, µTDFN, 2X2, ROHS	INTERSIL	ISL8002IRZ
H2510-01003-1/16W1-T	2	ea.	R2, R14		RES, SMD, 0402, 100kΩ, 1/16W, 1%	PANASONIC	ERJ2RKF1003
H2510-02003-1/16W1-T	1	ea.	R1		RES, SMD, 0402, 200kΩ, 1/16W, 1%	VISHAY/DALE, VENKEL	CRCW0402200KFED CR0402-16W-2003FT
H2510-DNP	0	ea.	R12		RES, SMD, 0402, DNP		
H2511-01003-1/10W1-T	2	ea.	R6, R7		RES, SMD, 0603, 100kΩ, 1/10W, 1%	PANASONIC ROHM	ERJ-3EKF1003V MCR03EZPF1003
H2511-DNP	0	ea.	R8, R9		RES, SMD, 060 3, DNP-PLACE HOLDER		

Typical Performance Curves

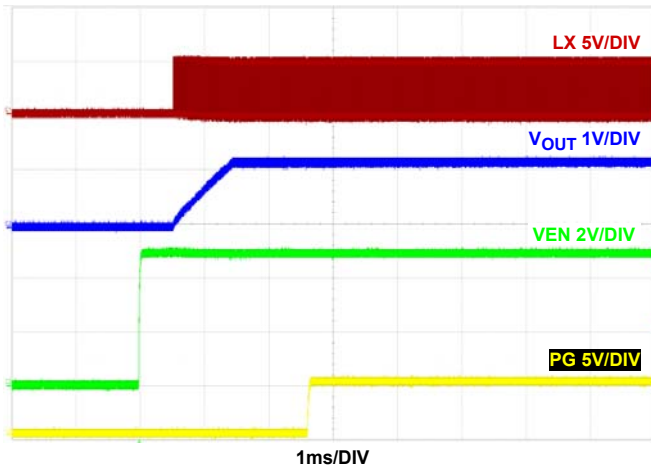

FIGURE 6. ISL8002A START-UP AT 2A LOAD $f_{SW} = 2\text{MHz}$, $V_{IN} = 5\text{V}$, MODE = PWM, $T_A = +25^\circ\text{C}$

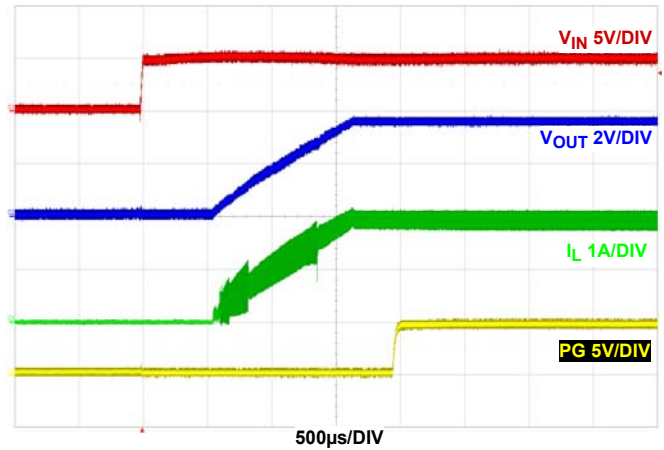

FIGURE 7. ISL8002D START-UP V_{IN} AT 2A LOAD $f_{SW} = 2\text{MHz}$, $V_{IN} = 5\text{V}$, MODE = PWM, $T_A = +25^\circ\text{C}$

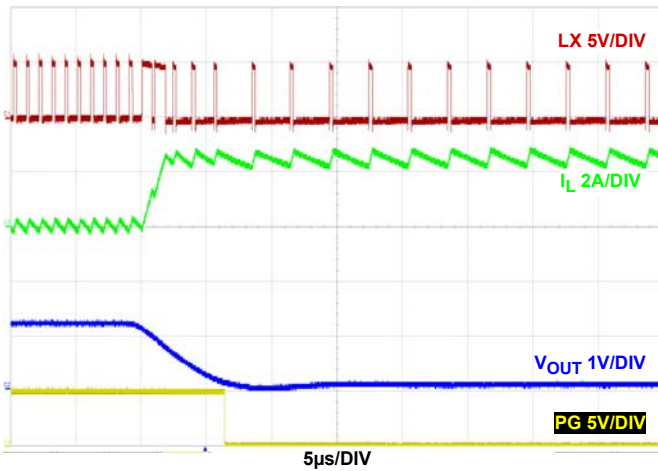

FIGURE 8. ISL8002A OUTPUT SHORT-CIRCUIT $f_{SW} = 2\text{MHz}$, $V_{IN} = 5\text{V}$, MODE = PFM, $T_A = +25^\circ\text{C}$

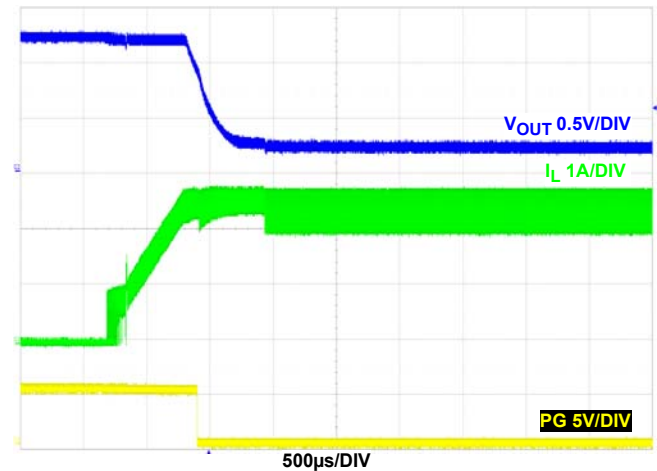

FIGURE 9. ISL8002A OVERCURRENT PROTECTION $f_{SW} = 2\text{MHz}$, $V_{IN} = 5\text{V}$, MODE = PWM, $T_A = +25^\circ\text{C}$

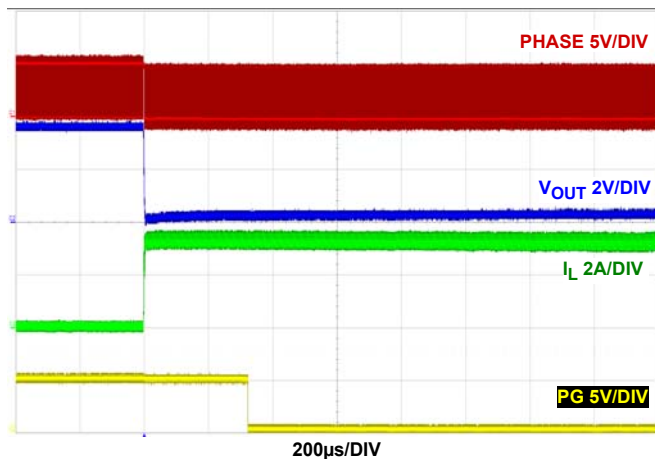

FIGURE 10. ISL8002D OUTPUT SHORT-CIRCUIT $f_{SW} = 2\text{MHz}$, $V_{IN} = 5\text{V}$, MODE = PFM, $T_A = +25^\circ\text{C}$

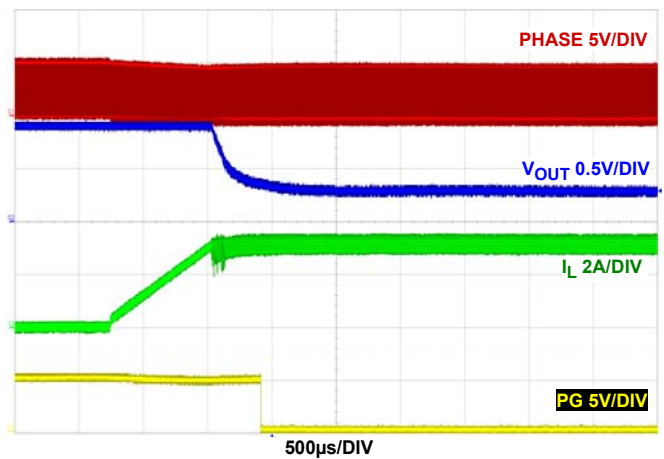

FIGURE 11. ISL8002D OVERCURRENT PROTECTION $f_{SW} = 2\text{MHz}$, $V_{IN} = 5\text{V}$, MODE = PWM, $T_A = +25^\circ\text{C}$

Notice

1. Descriptions of circuits, software and other related information in this document are provided only to illustrate the operation of semiconductor products and application examples. You are fully responsible for the incorporation or any other use of the circuits, software, and information in the design of your product or system. Renesas Electronics disclaims any and all liability for any losses and damages incurred by you or third parties arising from the use of these circuits, software, or information.
2. Renesas Electronics hereby expressly disclaims any warranties against and liability for infringement or any other claims involving patents, copyrights, or other intellectual property rights of third parties, by or arising from the use of Renesas Electronics products or technical information described in this document, including but not limited to, the product data, drawings, charts, programs, algorithms, and application examples.
3. No license, express, implied or otherwise, is granted hereby under any patents, copyrights or other intellectual property rights of Renesas Electronics or others.
4. You shall not alter, modify, copy, or reverse engineer any Renesas Electronics product, whether in whole or in part. Renesas Electronics disclaims any and all liability for any losses or damages incurred by you or third parties arising from such alteration, modification, copying or reverse engineering.
5. Renesas Electronics products are classified according to the following two quality grades: "Standard" and "High Quality". The intended applications for each Renesas Electronics product depends on the product's quality grade, as indicated below.
"Standard": Computers; office equipment; communications equipment; test and measurement equipment; audio and visual equipment; home electronic appliances; machine tools; personal electronic equipment; industrial robots; etc.
"High Quality": Transportation equipment (automobiles, trains, ships, etc.); traffic control (traffic lights); large-scale communication equipment; key financial terminal systems; safety control equipment; etc.
Unless expressly designated as a high reliability product or a product for harsh environments in a Renesas Electronics data sheet or other Renesas Electronics document, Renesas Electronics products are not intended or authorized for use in products or systems that may pose a direct threat to human life or bodily injury (artificial life support devices or systems; surgical implantations; etc.), or may cause serious property damage (space system; undersea repeaters; nuclear power control systems; aircraft control systems; key plant systems; military equipment; etc.). Renesas Electronics disclaims any and all liability for any damages or losses incurred by you or any third parties arising from the use of any Renesas Electronics product that is inconsistent with any Renesas Electronics data sheet, user's manual or other Renesas Electronics document.
6. When using Renesas Electronics products, refer to the latest product information (data sheets, user's manuals, application notes, "General Notes for Handling and Using Semiconductor Devices" in the reliability handbook, etc.), and ensure that usage conditions are within the ranges specified by Renesas Electronics with respect to maximum ratings, operating power supply voltage range, heat dissipation characteristics, installation, etc. Renesas Electronics disclaims any and all liability for any malfunctions, failure or accident arising out of the use of Renesas Electronics products outside of such specified ranges.
7. Although Renesas Electronics endeavors to improve the quality and reliability of Renesas Electronics products, semiconductor products have specific characteristics, such as the occurrence of failure at a certain rate and malfunctions under certain use conditions. Unless designated as a high reliability product or a product for harsh environments in a Renesas Electronics data sheet or other Renesas Electronics document, Renesas Electronics products are not subject to radiation resistance design. You are responsible for implementing safety measures to guard against the possibility of bodily injury, injury or damage caused by fire, and/or danger to the public in the event of a failure or malfunction of Renesas Electronics products, such as safety design for hardware and software, including but not limited to redundancy, fire control and malfunction prevention, appropriate treatment for aging degradation or any other appropriate measures. Because the evaluation of microcomputer software alone is very difficult and impractical, you are responsible for evaluating the safety of the final products or systems manufactured by you.
8. Please contact a Renesas Electronics sales office for details as to environmental matters such as the environmental compatibility of each Renesas Electronics product. You are responsible for carefully and sufficiently investigating applicable laws and regulations that regulate the inclusion or use of controlled substances, including without limitation, the EU RoHS Directive, and using Renesas Electronics products in compliance with all these applicable laws and regulations. Renesas Electronics disclaims any and all liability for damages or losses occurring as a result of your noncompliance with applicable laws and regulations.
9. Renesas Electronics products and technologies shall not be used for or incorporated into any products or systems whose manufacture, use, or sale is prohibited under any applicable domestic or foreign laws or regulations. You shall comply with any applicable export control laws and regulations promulgated and administered by the governments of any countries asserting jurisdiction over the parties or transactions.
10. It is the responsibility of the buyer or distributor of Renesas Electronics products, or any other party who distributes, disposes of, or otherwise sells or transfers the product to a third party, to notify such third party in advance of the contents and conditions set forth in this document.
11. This document shall not be reprinted, reproduced or duplicated in any form, in whole or in part, without prior written consent of Renesas Electronics.
12. Please contact a Renesas Electronics sales office if you have any questions regarding the information contained in this document or Renesas Electronics products.
(Note 1) "Renesas Electronics" as used in this document means Renesas Electronics Corporation and also includes its directly or indirectly controlled subsidiaries.
(Note 2) "Renesas Electronics product(s)" means any product developed or manufactured by or for Renesas Electronics.

(Rev.4.0-1 November 2017)



SALES OFFICES

Renesas Electronics Corporation

<http://www.renesas.com>

Refer to "<http://www.renesas.com/>" for the latest and detailed information.

Renesas Electronics America Inc.
1001 Murphy Ranch Road, Milpitas, CA 95035, U.S.A.
Tel: +1-408-432-8888, Fax: +1-408-434-5351

Renesas Electronics Canada Limited
9251 Yonge Street, Suite 8309 Richmond Hill, Ontario Canada L4C 9T3
Tel: +1-905-237-2004

Renesas Electronics Europe Limited
Dukes Meadow, Millboard Road, Bourne End, Buckinghamshire, SL8 5FH, U.K
Tel: +44-1628-651-700, Fax: +44-1628-651-804

Renesas Electronics Europe GmbH
Arcadiastrasse 10, 40472 Düsseldorf, Germany
Tel: +49-211-6503-0, Fax: +49-211-6503-1327

Renesas Electronics (China) Co., Ltd.
Room 1709 Quantum Plaza, No.27 ZhichunLu, Haidian District, Beijing, 100191 P. R. China
Tel: +86-10-8235-1155, Fax: +86-10-8235-7679

Renesas Electronics (Shanghai) Co., Ltd.
Unit 301, Tower A, Central Towers, 555 Langao Road, Putuo District, Shanghai, 200333 P. R. China
Tel: +86-21-2226-0888, Fax: +86-21-2226-0999

Renesas Electronics Hong Kong Limited
Unit 1601-1611, 16/F., Tower 2, Grand Century Place, 193 Prince Edward Road West, Mongkok, Kowloon, Hong Kong
Tel: +852-2265-6688, Fax: +852-2886-9022

Renesas Electronics Taiwan Co., Ltd.
13F, No. 363, Fu Shing North Road, Taipei 10543, Taiwan
Tel: +886-2-8175-9600, Fax: +886-2-8175-9670

Renesas Electronics Singapore Pte. Ltd.
80 Bendemeer Road, Unit #06-02 Hyflux Innovation Centre, Singapore 339949
Tel: +65-6213-0200, Fax: +65-6213-0300

Renesas Electronics Malaysia Sdn.Bhd.
Unit 1207, Block B, Menara Amcorp, Amcorp Trade Centre, No. 18, Jln Persiaran Barat, 46050 Petaling Jaya, Selangor Darul Ehsan, Malaysia
Tel: +60-3-7955-9390, Fax: +60-3-7955-9510

Renesas Electronics India Pvt. Ltd.
No.777C, 100 Feet Road, HAL 2nd Stage, Indiranagar, Bangalore 560 038, India
Tel: +91-80-67208700, Fax: +91-80-67208777

Renesas Electronics Korea Co., Ltd.
17F, KAMCO Yangjae Tower, 262, Gangnam-daero, Gangnam-gu, Seoul, 06265 Korea
Tel: +82-2-558-3737, Fax: +82-2-558-5338