

## ISL8115DEMO1Z

Synchronous Buck Converter

AN1919  
Rev 2.00  
March 11, 2015

### Introduction

The ISL8115DEMO1Z is a compact reference design Synchronous Buck Converter (28.19mmx16.89mm) implementing Intersil's wide input range PWM controller ISL8115. Utilizing voltage mode control with input feed-forward, the ISL8115DEMO1Z maintains a constant loop gain for optimal transient response, especially for applications with a wide input voltage range. For a more detailed description of the ISL8115 functionality, refer to the [ISL8115](#) datasheet.

This user guide includes the test setup, typical performance waveforms, schematic, layout and bill of materials (BOM).

### Specifications

TABLE 1. DEMONSTRATION BOARD ELECTRICAL SPECIFICATIONS

SPEC	DESCRIPTION	MIN	TYP	MAX	UNIT
V <sub>IN</sub>	Input voltage range	16	24	36	V
V <sub>OUT</sub>	Output voltage		5		V
I <sub>OUT</sub>	Output rated current		10		A
I <sub>OC</sub>	Overcurrent threshold		13		A
f <sub>sw</sub>	Switching frequency		600		kHz
Input UVP	Rising threshold		15		V
	Falling threshold		14.2		V
η	Efficiency at 24V input full load (10A)		90.12		%



FIGURE 1. ISL8115DEMO1Z DEMONSTRATION BOARD

### Key Features

- Small, compact design
- Fast transient response
  - Voltage-mode PWM leading-edge modulation with nonlinear control
  - Input voltage feed-forward
- Integrated 5V high speed 4A MOSFET gate drivers
  - Internal bootstrap diode
- Oscillator programmable from 150kHz to 1.5MHz
  - Frequency synchronization to external clock signal
- Diode emulation mode for light load efficiency improvement
- Output OVP/UVP; OCP and OTP
- Adjustable soft-start
- Prebias start-up function
- Excellent output voltage regulation
  - 0.6V ±1.0% internal reference (-40°C~+125°C)
  - 0.6V ±0.7% internal reference (-40°C~+105°C)
  - Differential voltage sensing

### References

- [ISL8115](#) datasheet

### Ordering Information

PART NUMBER	DESCRIPTION
ISL8115DEMO1Z	Demonstration Board for ISL8115

### Recommended Equipment

- Input power source up to 36V supply voltage with 125W power supply ability
- Electronic load with 100W power sinking ability
- Voltmeters and ammeters
- 100MHz quad-trace oscilloscope

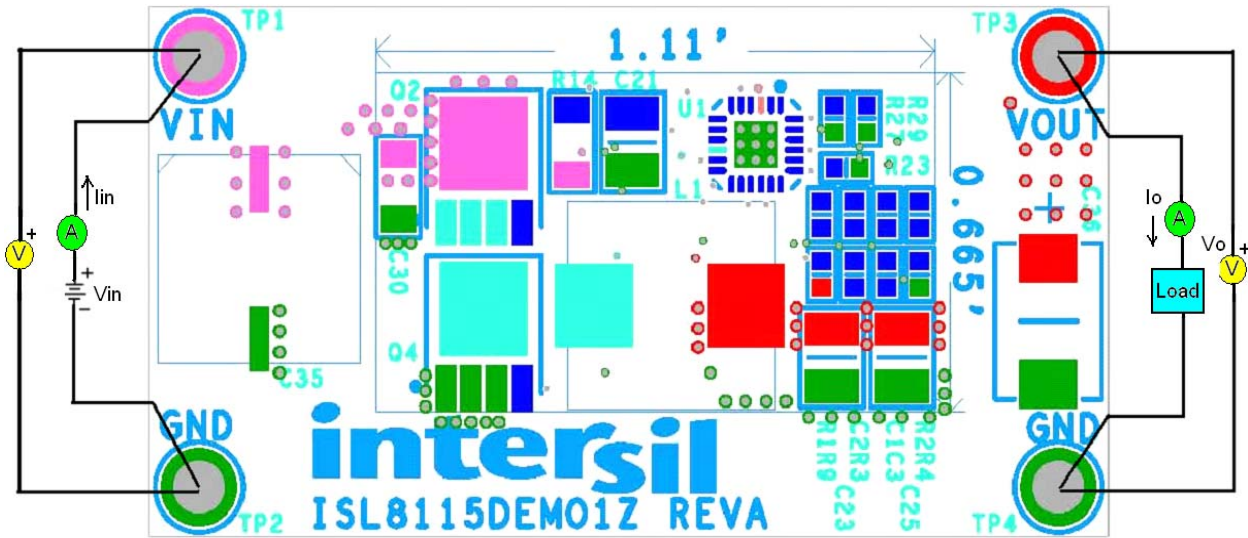

FIGURE 2. ISL8115DEMO1Z TEST SETUP

## Quick Test Setup

1. Ensure that the demonstration board is correctly connected to the power supply and the electronic load prior to applying any power. Refer to [Figure 2](#) for proper setup.
2. Set the input voltage to 24V, turn on the power supply and observe output voltage. The output voltage variation should be within 5%.
3. Adjust load current within 10A. The output voltage variation should be within 5%.
4. Use oscilloscope to observe output ripple voltage and phase node ringing. For accurate measurement, refer to [Figure 3](#) for proper setup.

## Probe Setup

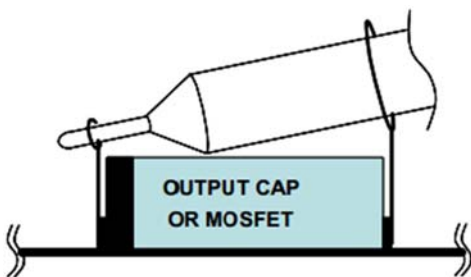

FIGURE 3. OSCILLOSCOPE PROBE SETUP

## Design Guide

The ISL8115DEMO1Z is optimized for 16V to 36V input voltage range. However, the evaluation board can be modified to support multiple applications due to the customer's requirements. Refer to the [ISL8115](#) datasheet for detailed information.

TABLE 2. 12V APPLICATION

V <sub>IN</sub>	R <sub>35</sub>
12V	71.5k

Quick modify to 12V input application, [Table 2](#) can be followed. Some other modifications need to be made at the same time if best performance is expected.

### Output Voltage Adjustment

The output voltage can be set by the resistors R<sub>4</sub> and R<sub>1</sub>. In order to keep the existing compensation parameters unchanged, adjust R<sub>4</sub> to set the output voltage by the following [Equation 1](#):

$$R_4 = \frac{0.6V \times R_1}{V_{OUT} - 0.6V} \quad (\text{EQ. 1})$$

The VMON monitors the output for UVP and OVP, the resistor divider value of R<sub>11</sub>/R<sub>8</sub> should be the same with the R<sub>1</sub>/R<sub>4</sub>.

### Synchronization

The ISL8115DEMOZ board can be synchronized with an external clock. Applying a clock signal (10% to 90% duty cycle) in the range of 150kHz to 1.5MHz to the FSET pin makes the internal frequency synchronized with the external clock. Please remove R<sub>27</sub> when the synchronized function is implemented.

# Typical Performance Curves

Unless otherwise specified, the input voltage is 28V.

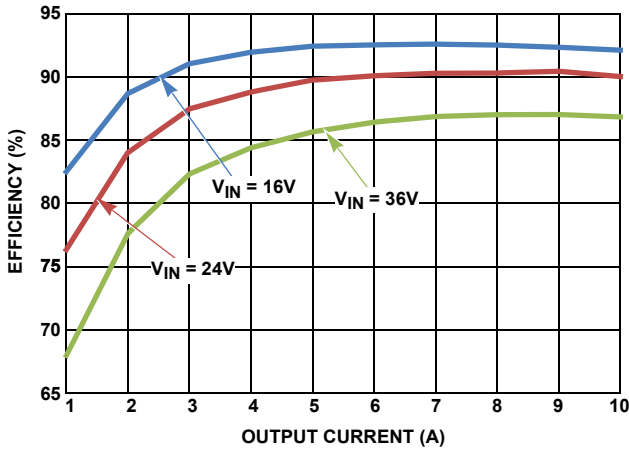

FIGURE 4. EFFICIENCY vs LOAD CURRENT AT CCM MODE

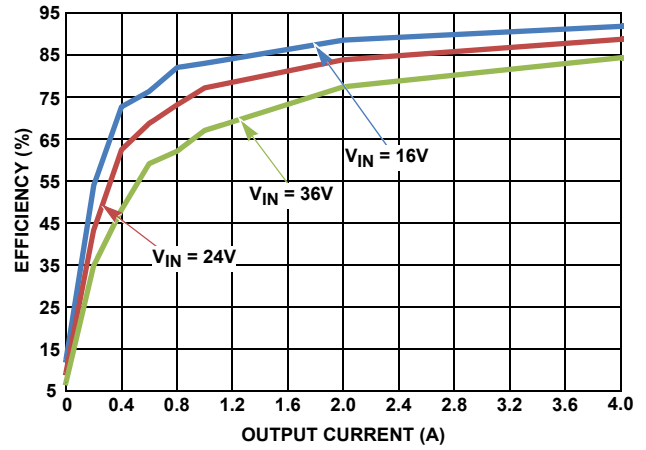

FIGURE 5. EFFICIENCY vs LOAD CURRENT AT DEM MODE

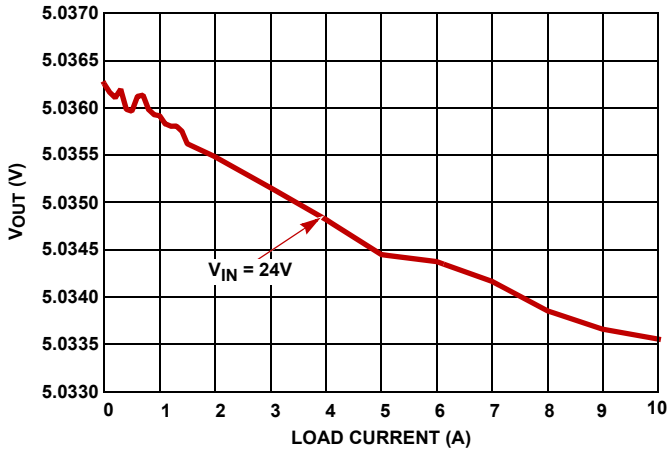

FIGURE 6. V<sub>OUT</sub> LOAD REGULATION AT CCM MODE

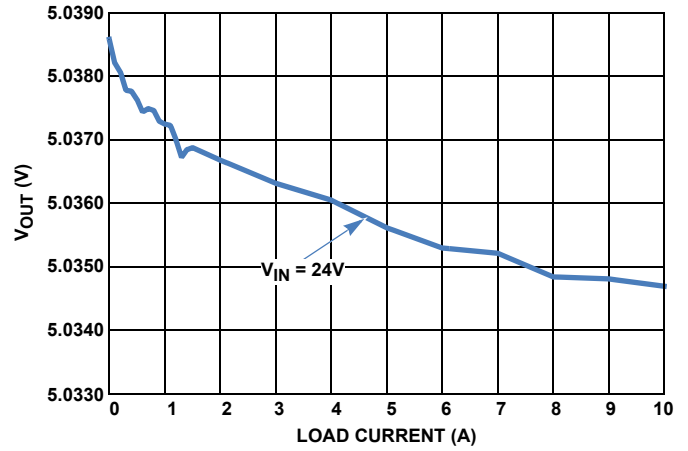

FIGURE 7. V<sub>OUT</sub> LOAD REGULATION AT DEM MODE

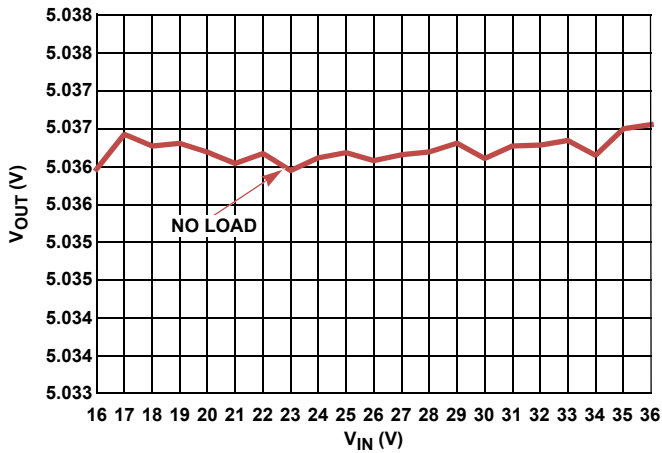

FIGURE 8. LINE REGULATION AT NO LOAD CCM MODE

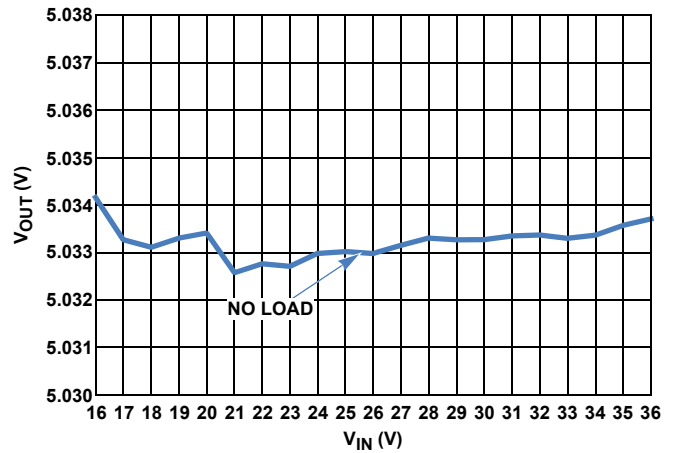

FIGURE 9. LINE REGULATION AT NO LOAD DEM MODE

# Typical Performance Curves

Unless otherwise specified, the input voltage is 28V. (Continued)

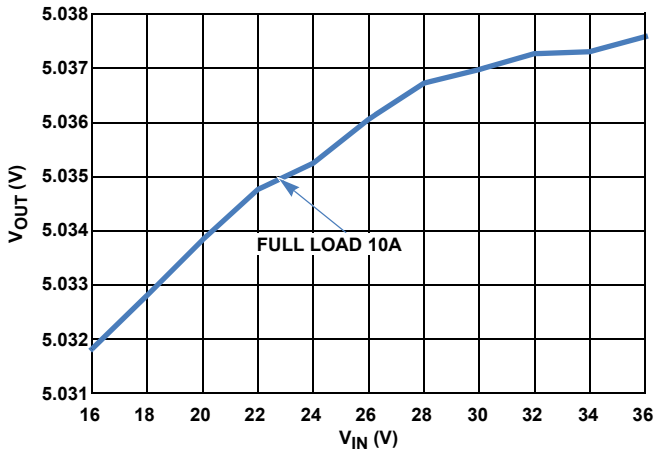

FIGURE 10. LINE REGULATION AT FULL LOAD CCM MODE

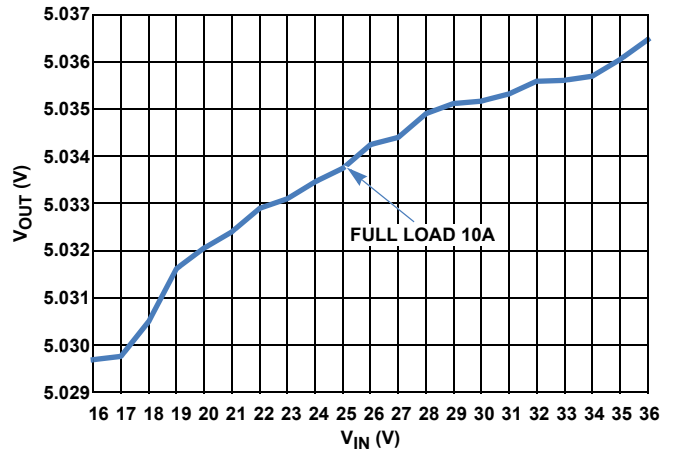

FIGURE 11. LINE REGULATION AT FULL LOAD DEM MODE

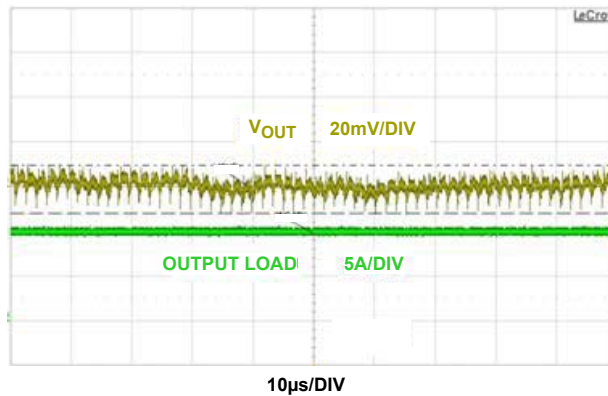

FIGURE 12. OUTPUT VOLTAGE RIPPLE AT 10A LOAD CONDITION

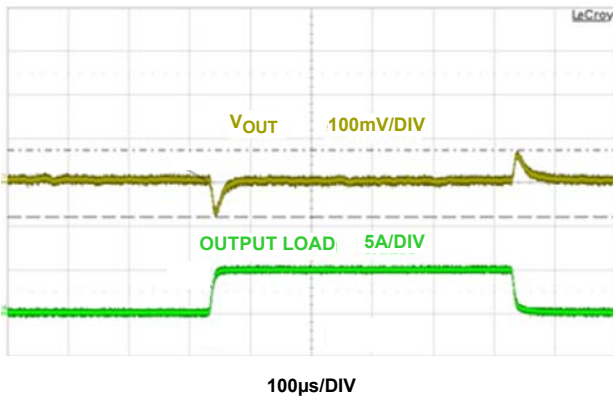

FIGURE 13. LOAD TRANSIENT 0A TO 5A; 2A/µs AT CCM

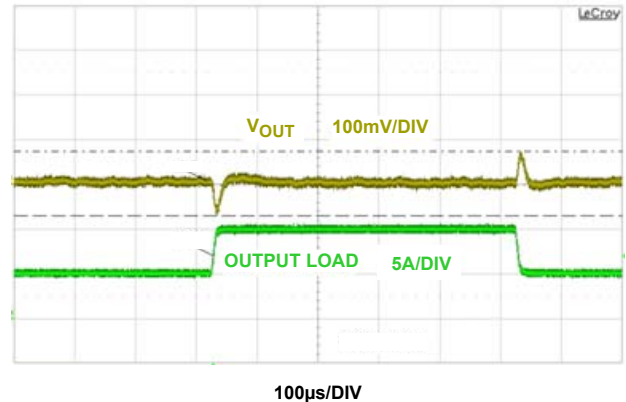

FIGURE 14. LOAD TRANSIENT 5A TO 10A; 2A/µs AT CCM

**Typical Performance Curves** Unless otherwise specified, the input voltage is 28V. (Continued)

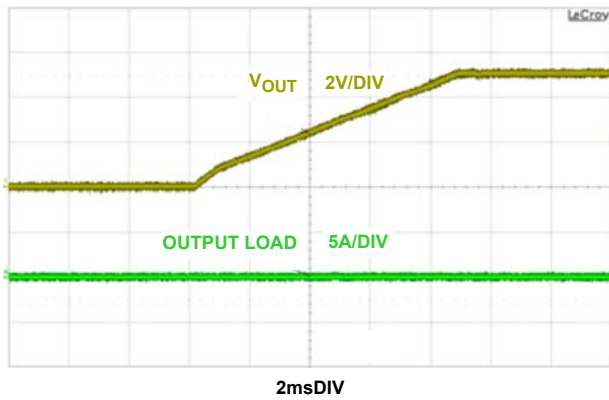

FIGURE 15. START-UP AT 0A LOAD CONDITION

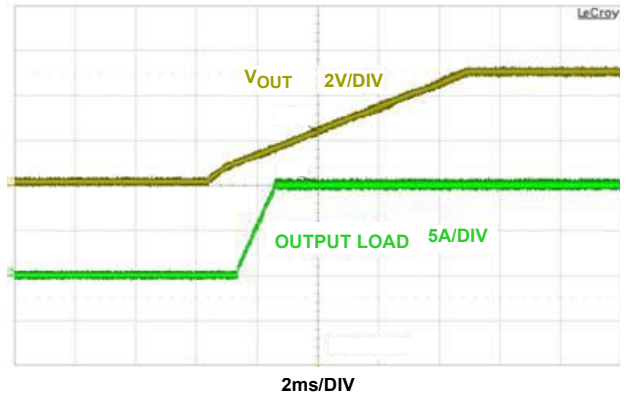

FIGURE 16. START-UP AT 10A LOAD CONDITION

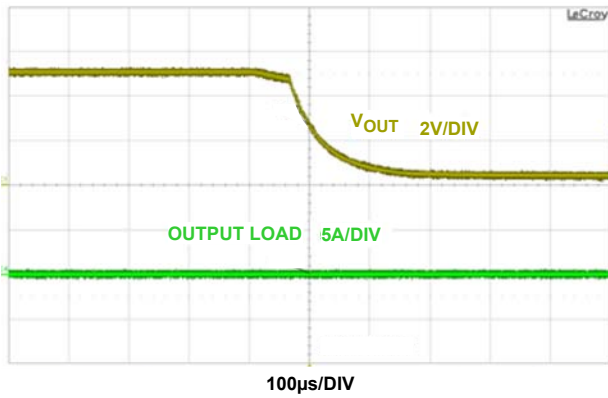

FIGURE 17. SHUTDOWN AT 0A LOAD CONDITION

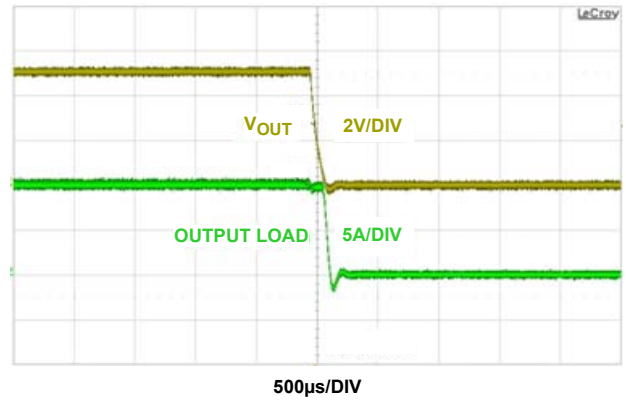

FIGURE 18. SHUTDOWN AT 10A LOAD CONDITION

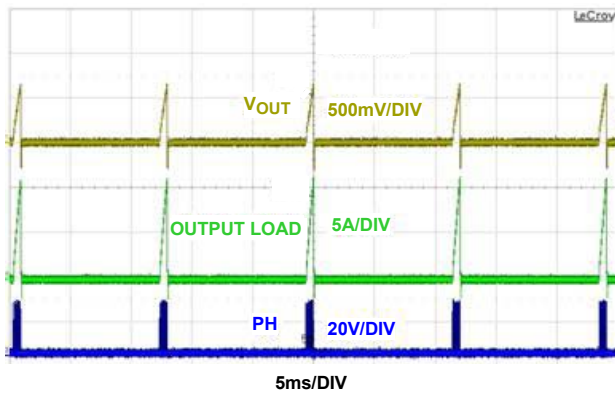

FIGURE 19. OVERCURRENT PROTECTION AT 12.6A LOAD

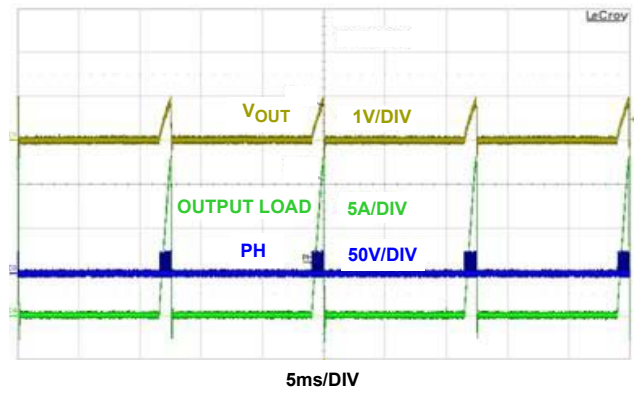

FIGURE 20. SHORT PROTECTION

**Schematic**

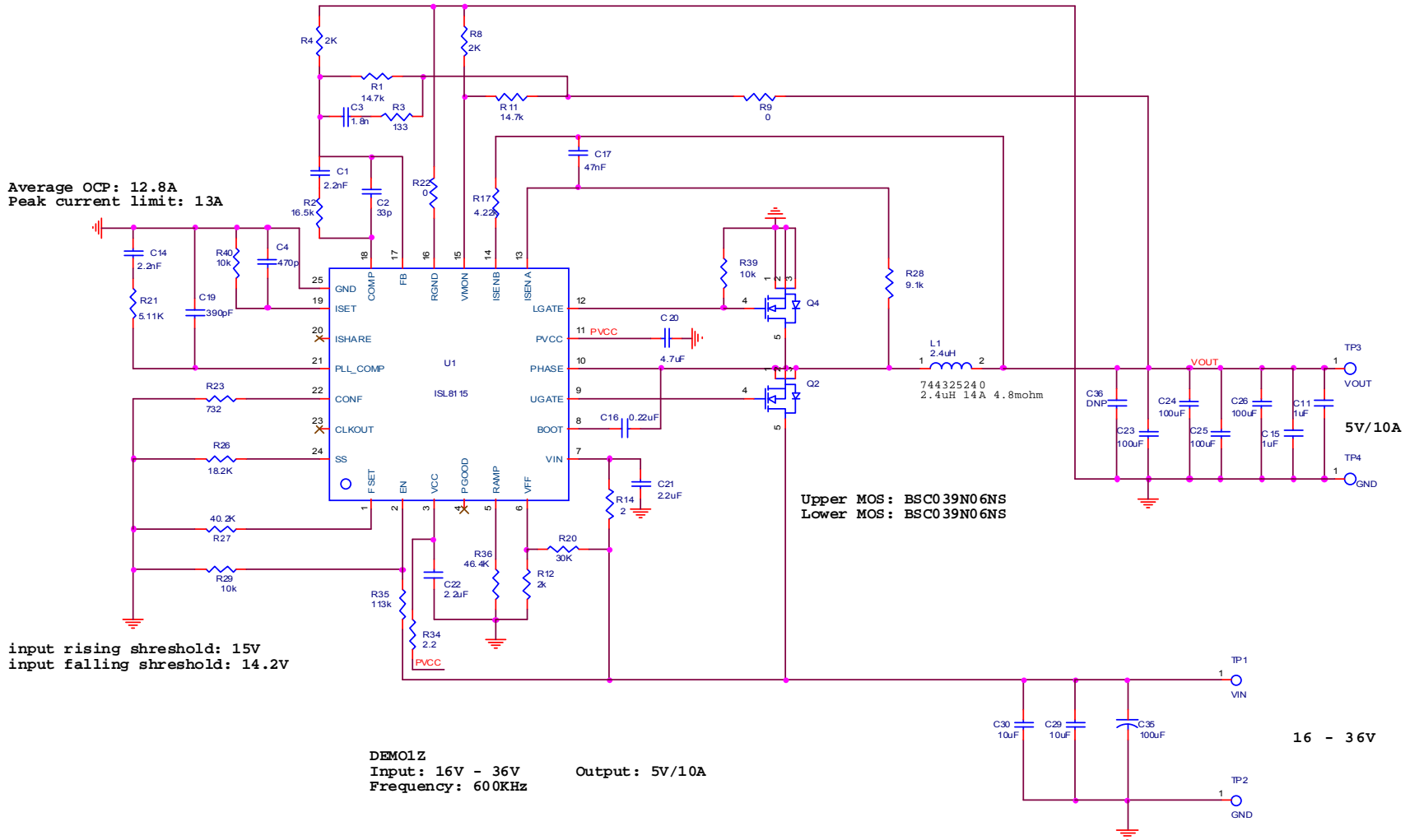

FIGURE 21. ISL8115DEMO1Z SCHEMATIC

## Bill of Materials

ITEM	QTY	REFERENCE	VALUE	DESCRIPTION	MANUFACTURER	PART NUMBER
1	2	C1, C14	2.2nF	CAP CER 2200pF 25V 10% X7R 0402	Generic	Generic
2	1	C2	33pF	CAP CER 33pF 50V 5% NPO 0402	Generic	Generic
3	1	C3	1.8nF	CAP CER 1800pF 50V 10% X7R 0402	Generic	Generic
4	1	C4	470pF	CAP CER 470pF 50V 10% X7R 0402	Generic	Generic
5	2	C11, C15	1μF	CAP CER 1μF 10V 10% X5R 0603	Generic	Generic
7	1	C16	0.22μF	CAP CER 0.22μF 16V 10% X7R 0402	Generic	Generic
8	1	C17	47nF	CAP CER 0.047μF 25V 10% X7R 0402	Generic	Generic
9	1	C19	390pF	CAP CER 390pF 50V 10% X7R 0402	Generic	Generic
10	1	C20	4.7μF	CAP CER 4.7μF 6.3V 10% X5R 0805	Generic	Generic
11	1	C21	2.2μF	CAP CER 2.2μF 50V 10% X7R 1210	TDK	C3225X7R1H225K
12	1	C22	2.2μF	CAP CER 2.2μF 6.3V 20% X5R 0603	Generic	Generic
13	4	C23, C24, C25, C26	100μF	CAP CER 100μF 6.3V 20% X5R 1210	TDK	C3225X5R0J107M250AC
14	2	C29, C30	10μF	CAP CER 10μF 50V 10% X5R 1206	TDK	C3216X5R1H106K160AB
15	1	C35	100μF	CAP ALUM 100μF 50V 20% SMD	Nichicon	PCV1H101MCL2GS
16	1	C36	DNP	CAP 220μF 6.3V	Panasonic	6TPF220M5L
17	1	L1	2.4μH	INDUCTOR POWER 2.4μH 31.5A SMD	WE-Midcom	744325240
18	2	Q2, Q4	BSC039N06NS	MOSFET N-CH 60V 19A TDSO8	Infineon	BSC039N06NS
19	2	R1, R11	14.7k	RES 14.7kΩ 1/16W 1% 0402 SMD	Generic	Generic
20	1	R2	16.5k	RES 16.5kΩ 1/16W 1% 0402 SMD	Generic	Generic
21	1	R3	133	RES 133Ω 1/16W 1% 0402 SMD	Generic	Generic
22	3	R4, R8, R12	2k	RES 2.00kΩ 1/16W 1% 0402 SMD	Generic	Generic
23	2	R9, R22	0	RES 0.0Ω 1/16W JUMP 0402 SMD	Generic	Generic
24	1	R14	2	RES 2.00Ω 1/4W 1% 1206 SMD	Generic	Generic
25	1	R17	4.22k	RES 4.22kΩ 1/16W 1% 0402 SMD	Generic	Generic
26	1	R20	30k	RES 30kΩ 1/16W 1% 0402 SMD	Generic	Generic
27	1	R21	5.11k	RES 5.11kΩ 1/16W 1% 0402 SMD	Generic	Generic
28	1	R23	732	RES 732Ω 1/16W 1% 0402 SMD	Generic	Generic
29	1	R26	18.2k	RES 18.2kΩ 1/16W 1% 0402 SMD	Generic	Generic
30	1	R27	40.2k	RES 40.2kΩ 1/16W 1% 0402 SMD	Generic	Generic
31	1	R28	9.1k	RES 9.1kΩ 1/16W 1% 0402 SMD	Generic	Generic
32	3	R29, R39, R40	10k	RES 10kΩ 1/16W 1% 0402 SMD	Generic	Generic
33	1	R34	2.2	RES 2.2Ω 1/16W 1% 0402 SMD	Generic	Generic
34	1	R35	113k	RES 113kΩ 1/16W 1% 0402 SMD	Generic	Generic



# Assembly Drawing

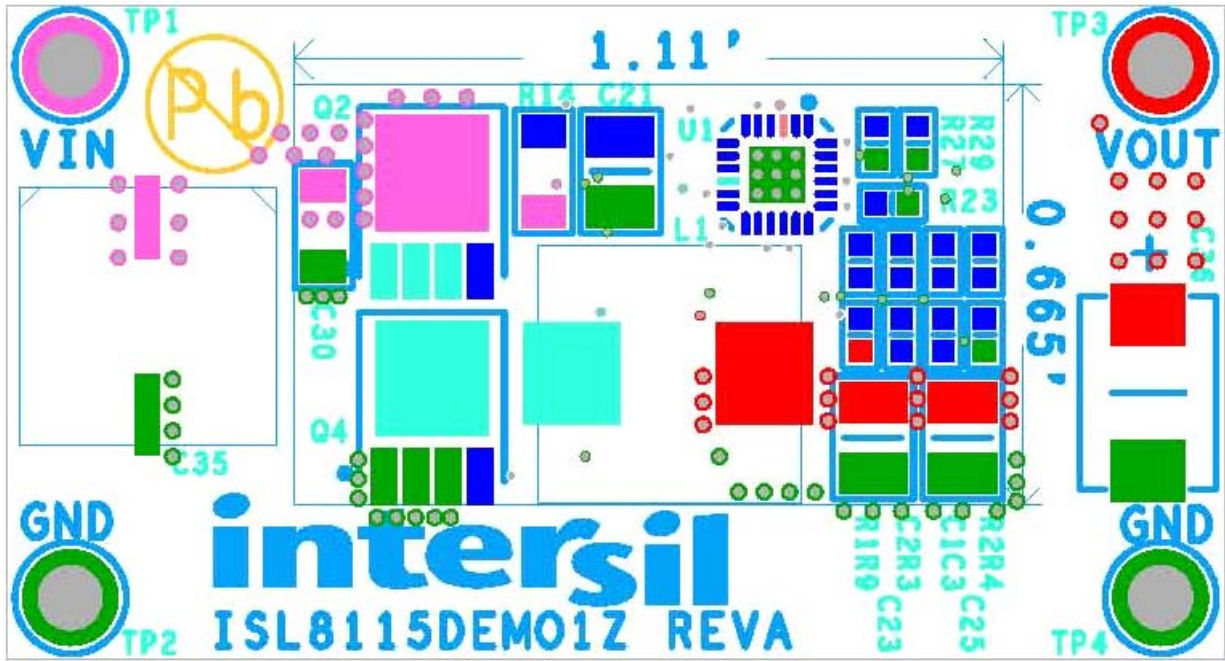

FIGURE 22. TOP



FIGURE 23. BOTTOM



## PCB Layout

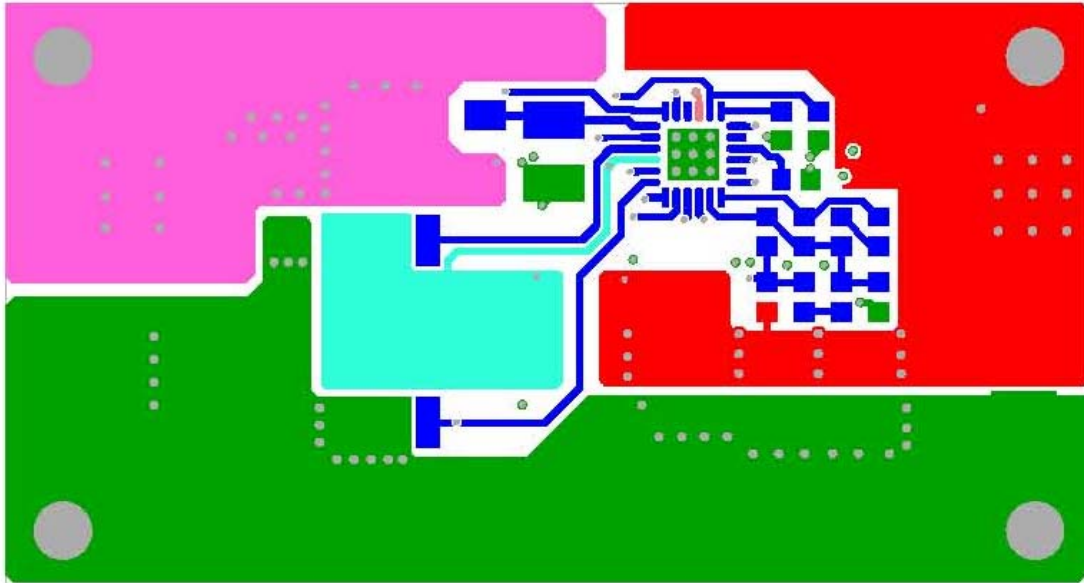

FIGURE 24. TOP LAYER

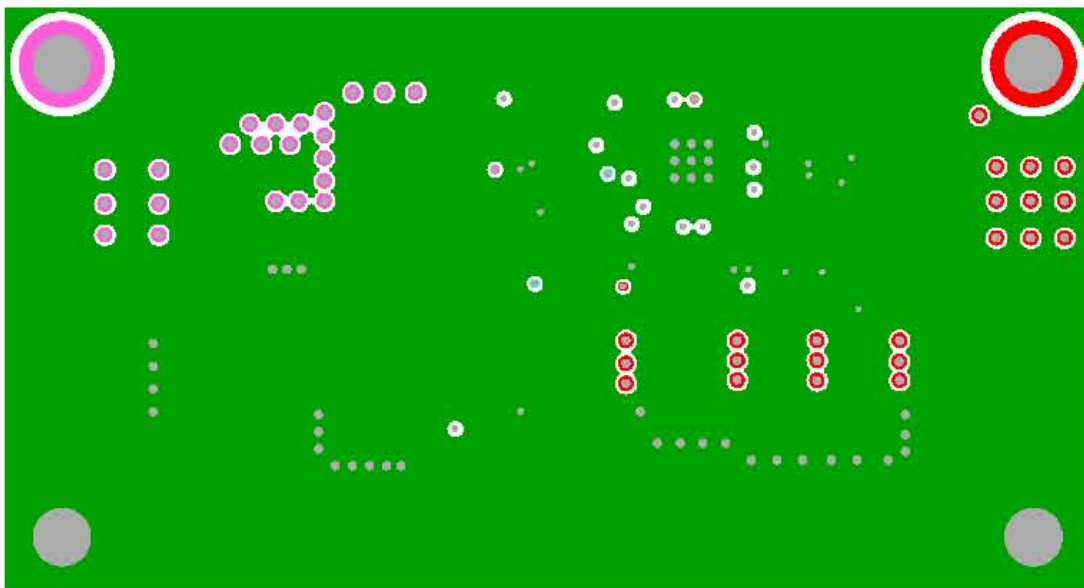

FIGURE 25. LAYER 2

## PCB Layout (Continued)

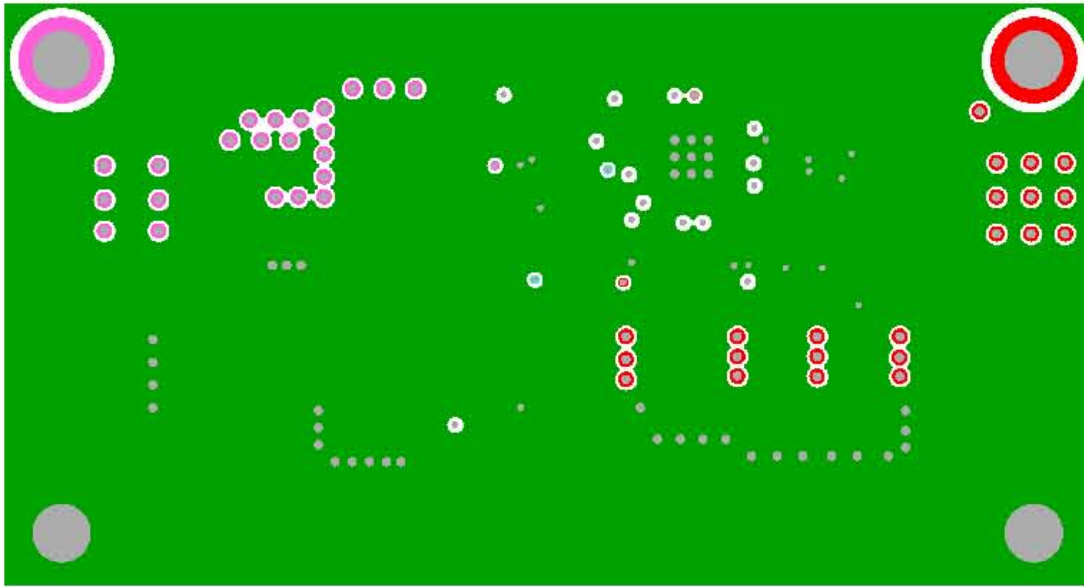

FIGURE 26. LAYER 3

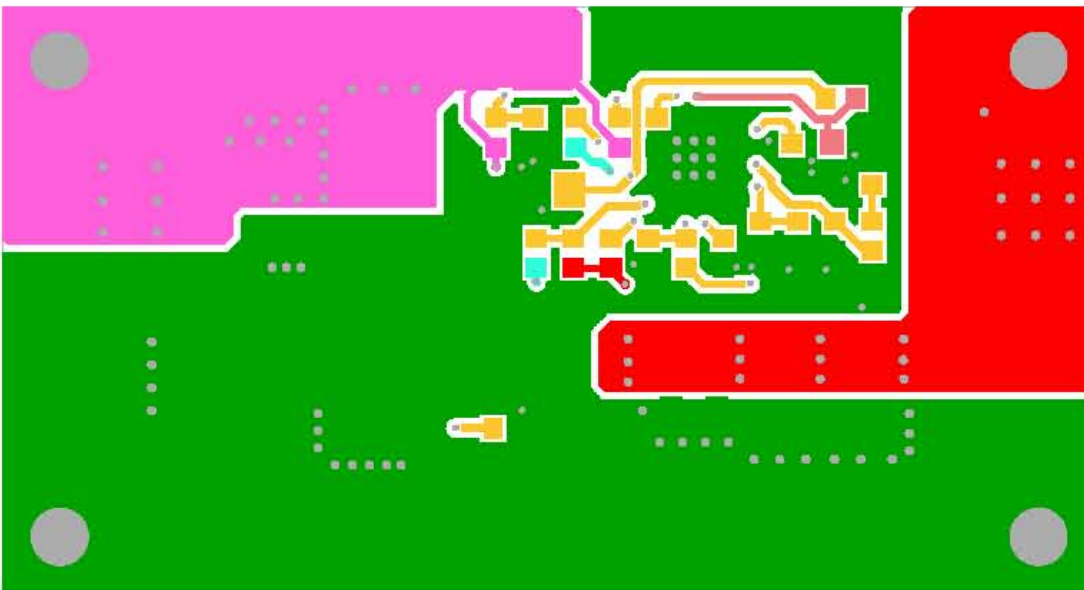

FIGURE 27. BOTTOM LAYER

## Notice

1. Descriptions of circuits, software and other related information in this document are provided only to illustrate the operation of semiconductor products and application examples. You are fully responsible for the incorporation or any other use of the circuits, software, and information in the design of your product or system. Renesas Electronics disclaims any and all liability for any losses and damages incurred by you or third parties arising from the use of these circuits, software, or information.
2. Renesas Electronics hereby expressly disclaims any warranties against and liability for infringement or any other claims involving patents, copyrights, or other intellectual property rights of third parties, by or arising from the use of Renesas Electronics products or technical information described in this document, including but not limited to, the product data, drawings, charts, programs, algorithms, and application examples.
3. No license, express, implied or otherwise, is granted hereby under any patents, copyrights or other intellectual property rights of Renesas Electronics or others.
4. You shall not alter, modify, copy, or reverse engineer any Renesas Electronics product, whether in whole or in part. Renesas Electronics disclaims any and all liability for any losses or damages incurred by you or third parties arising from such alteration, modification, copying or reverse engineering.
5. Renesas Electronics products are classified according to the following two quality grades: "Standard" and "High Quality". The intended applications for each Renesas Electronics product depends on the product's quality grade, as indicated below.  
"Standard": Computers; office equipment; communications equipment; test and measurement equipment; audio and visual equipment; home electronic appliances; machine tools; personal electronic equipment; industrial robots; etc.  
"High Quality": Transportation equipment (automobiles, trains, ships, etc.); traffic control (traffic lights); large-scale communication equipment; key financial terminal systems; safety control equipment; etc.  
Unless expressly designated as a high reliability product or a product for harsh environments in a Renesas Electronics data sheet or other Renesas Electronics document, Renesas Electronics products are not intended or authorized for use in products or systems that may pose a direct threat to human life or bodily injury (artificial life support devices or systems; surgical implantations; etc.), or may cause serious property damage (space system; undersea repeaters; nuclear power control systems; aircraft control systems; key plant systems; military equipment; etc.). Renesas Electronics disclaims any and all liability for any damages or losses incurred by you or any third parties arising from the use of any Renesas Electronics product that is inconsistent with any Renesas Electronics data sheet, user's manual or other Renesas Electronics document.
6. When using Renesas Electronics products, refer to the latest product information (data sheets, user's manuals, application notes, "General Notes for Handling and Using Semiconductor Devices" in the reliability handbook, etc.), and ensure that usage conditions are within the ranges specified by Renesas Electronics with respect to maximum ratings, operating power supply voltage range, heat dissipation characteristics, installation, etc. Renesas Electronics disclaims any and all liability for any malfunctions, failure or accident arising out of the use of Renesas Electronics products outside of such specified ranges.
7. Although Renesas Electronics endeavors to improve the quality and reliability of Renesas Electronics products, semiconductor products have specific characteristics, such as the occurrence of failure at a certain rate and malfunctions under certain use conditions. Unless designated as a high reliability product or a product for harsh environments in a Renesas Electronics data sheet or other Renesas Electronics document, Renesas Electronics products are not subject to radiation resistance design. You are responsible for implementing safety measures to guard against the possibility of bodily injury, injury or damage caused by fire, and/or danger to the public in the event of a failure or malfunction of Renesas Electronics products, such as safety design for hardware and software, including but not limited to redundancy, fire control and malfunction prevention, appropriate treatment for aging degradation or any other appropriate measures. Because the evaluation of microcomputer software alone is very difficult and impractical, you are responsible for evaluating the safety of the final products or systems manufactured by you.
8. Please contact a Renesas Electronics sales office for details as to environmental matters such as the environmental compatibility of each Renesas Electronics product. You are responsible for carefully and sufficiently investigating applicable laws and regulations that regulate the inclusion or use of controlled substances, including without limitation, the EU RoHS Directive, and using Renesas Electronics products in compliance with all these applicable laws and regulations. Renesas Electronics disclaims any and all liability for damages or losses occurring as a result of your noncompliance with applicable laws and regulations.
9. Renesas Electronics products and technologies shall not be used for or incorporated into any products or systems whose manufacture, use, or sale is prohibited under any applicable domestic or foreign laws or regulations. You shall comply with any applicable export control laws and regulations promulgated and administered by the governments of any countries asserting jurisdiction over the parties or transactions.
10. It is the responsibility of the buyer or distributor of Renesas Electronics products, or any other party who distributes, disposes of, or otherwise sells or transfers the product to a third party, to notify such third party in advance of the contents and conditions set forth in this document.
11. This document shall not be reprinted, reproduced or duplicated in any form, in whole or in part, without prior written consent of Renesas Electronics.
12. Please contact a Renesas Electronics sales office if you have any questions regarding the information contained in this document or Renesas Electronics products.  
(Note 1) "Renesas Electronics" as used in this document means Renesas Electronics Corporation and also includes its directly or indirectly controlled subsidiaries.  
(Note 2) "Renesas Electronics product(s)" means any product developed or manufactured by or for Renesas Electronics.

(Rev.4.0-1 November 2017)



### SALES OFFICES

Renesas Electronics Corporation

<http://www.renesas.com>

Refer to "<http://www.renesas.com/>" for the latest and detailed information.

**Renesas Electronics America Inc.**  
1001 Murphy Ranch Road, Milpitas, CA 95035, U.S.A.  
Tel: +1-408-432-8888, Fax: +1-408-434-5351

**Renesas Electronics Canada Limited**  
9251 Yonge Street, Suite 8309 Richmond Hill, Ontario Canada L4C 9T3  
Tel: +1-905-237-2004

**Renesas Electronics Europe Limited**  
Dukes Meadow, Millboard Road, Bourne End, Buckinghamshire, SL8 5FH, U.K  
Tel: +44-1628-651-700, Fax: +44-1628-651-804

**Renesas Electronics Europe GmbH**  
Arcadiastrasse 10, 40472 Düsseldorf, Germany  
Tel: +49-211-6503-0, Fax: +49-211-6503-1327

**Renesas Electronics (China) Co., Ltd.**  
Room 1709 Quantum Plaza, No.27 ZhichunLu, Haidian District, Beijing, 100191 P. R. China  
Tel: +86-10-8235-1155, Fax: +86-10-8235-7679

**Renesas Electronics (Shanghai) Co., Ltd.**  
Unit 301, Tower A, Central Towers, 555 Langao Road, Putuo District, Shanghai, 200333 P. R. China  
Tel: +86-21-2226-0888, Fax: +86-21-2226-0999

**Renesas Electronics Hong Kong Limited**  
Unit 1601-1611, 16/F., Tower 2, Grand Century Place, 193 Prince Edward Road West, Mongkok, Kowloon, Hong Kong  
Tel: +852-2265-6688, Fax: +852-2886-9022

**Renesas Electronics Taiwan Co., Ltd.**  
13F, No. 363, Fu Shing North Road, Taipei 10543, Taiwan  
Tel: +886-2-8175-9600, Fax: +886-2-8175-9670

**Renesas Electronics Singapore Pte. Ltd.**  
80 Bendemeer Road, Unit #06-02 Hyflux Innovation Centre, Singapore 339949  
Tel: +65-6213-0200, Fax: +65-6213-0300

**Renesas Electronics Malaysia Sdn.Bhd.**  
Unit 1207, Block B, Menara Amcorp, Amcorp Trade Centre, No. 18, Jln Persiaran Barat, 46050 Petaling Jaya, Selangor Darul Ehsan, Malaysia  
Tel: +60-3-7955-9390, Fax: +60-3-7955-9510

**Renesas Electronics India Pvt. Ltd.**  
No.777C, 100 Feet Road, HAL 2nd Stage, Indiranagar, Bangalore 560 038, India  
Tel: +91-80-67208700, Fax: +91-80-67208777

**Renesas Electronics Korea Co., Ltd.**  
17F, KAMCO Yangjae Tower, 262, Gangnam-daero, Gangnam-gu, Seoul, 06265 Korea  
Tel: +82-2-558-3737, Fax: +82-2-558-5338