

Introduction/Overview

The following document provides a description of the code supplied with the ISL94208 evaluation kit. This code supports 4- to 6-cell battery pack implementations.

In the microcode, there are a number of routines common to an actual battery pack implementation, such as power control, cell monitoring, over and undervoltage protection, overcurrent detection, temperature monitoring, and communication, but the code is provided only as an example of battery pack operation using the ISL94208. It is not intended for use in production battery packs.

Process Flow Chart

The flow chart of Figure 1 on page 3 shows the overall process flow for the microcontroller for two basic, but different configurations. In the first flow, determined by the WKPOL bit, when WKPOL equals zero, the pack is waken when a charger connection to the pack terminals pulls the WKUP pin below its wake up threshold by connecting to a charger or a load, or by using the on board push buttons.

In the second configuration, when WKPOL is one, the pack is waken by a push button connected to the WKUP pin of the ISL94208. When WKUP goes HIGH, above the wake up threshold, the pack wakes up.

In either mode, the pack goes to sleep if at least one of the cell voltages drops below a sleep threshold, there is no current for a long period of time, or if the user sends a sleep command through the GUI.

To operate unattended with WKPOL = 1 requires a firmware change. Since the device operation depends on the state of the WKPOL bit in the ISL94208, and because the WKPOL is a volatile bit with a default setting of "0", it requires that the microcontroller set this bit on initial power-up. To change this requires a change to the microcode to set the WKPOL to 1 on power-up. Until then, it is necessary to power the board up with WKPOL = 1, connect the board to a PC, and then use the PC GUI to change the WKPOL bit. From then on, the pack operates in the second mode as long as the VBACK pin does not drop below the POR threshold causing the pack to make another "first power-up". Note: There is one caveat to the use of the pack in the second mode of operation. Releasing the WKUP pin causes the pack to go to sleep. While the pack is asleep, there can be no communication with the pack through the microcontroller. If the pack is to be monitored by the GUI, then the GUI needs to be restarted when the pack wakes up and will only operate while the pack is awake.

Both process flows include only the required functions for safe pack operation.

Interrupt Structure

The microcode is set up with an interrupt every 250ms. On this interrupt, the cells following subroutines are executed. There is also an interrupt set up on the I²C communication link. This link opens communication between the microcontroller and a USB to I²C interface microcontroller that, in turn, communicates with the PC. During communication to the PC, the ISL94208 microcode interrupts are suspended.

Required Subroutines

There are a number of routines included in the microcontroller code. These are:

POWER UP/INITIALIZATION (INCLUDING WAKE UP)

See "Power-up/Initialization" on page 4

CELL MONITORING

See "Cell Voltage/Temperature Monitoring" on page 6

OVERVOLTAGE DETECTION/RESPONSE

See "Overvoltage Detection/Response" on page 10

UNDERVOLTAGE DETECTION/RESPONSE

See "Undervoltage Detection/Response" on page 12

DISCHARGE OVERCURRENT/SHORT CIRCUIT DETECTION/RESPONSE

See "Discharge Overcurrent and Short Circuit Detection/Response" on page 15

CHARGE OVERCURRENT DETECTION/RESPONSE

See "Charge Overcurrent Detection/Response" on page 18

TEMPERATURE MONITORING/RESPONSE

See "Temperature Monitoring/Response" on page 22

COMMUNICATIONS

See "Communications" on page 24

CELL BALANCING

See "Cell Balancing" on page 25

Optional Subroutines

There are also a number of additional routines that may be included in future releases of the code. These are listed as follows:

FUEL GAUGING

In the ISL94208 evaluation board, there is no current sense monitoring, so a coulomb counting procedure is not possible. An algorithm based on voltage could be added to give the pack some ability to determine remaining capacity.

IN-PACK REPROGRAMMABILITY

Future revisions of this code could include the ability to reprogram the microcontroller through the external serial interface, without disassembling the battery pack.

OTHER FUNCTIONS

Other functions may include the addition of LEDs and pushbutton for status or fuel gauge readout, the addition of battery pack manufacturing data and battery pack information (capacity, voltage, cell type, etc), additional power-down states, and interrupt responses to overcurrent conditions.

System Operation Main

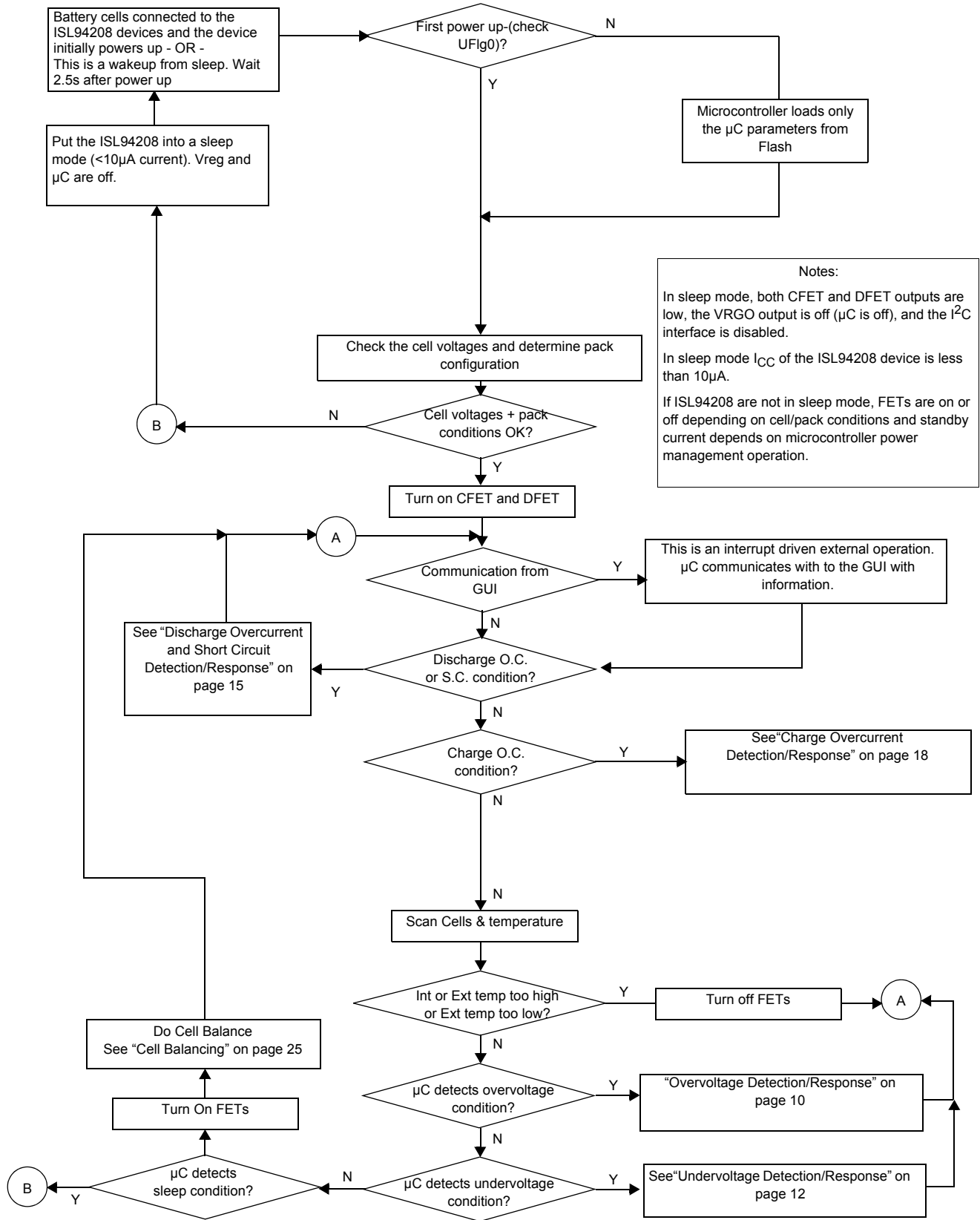

FIGURE 1. SYSTEM OPERATION MAIN

Power-up/Initialization

Power-up

The ISL94208 devices initially power-up when the voltage on VBACK rises above about 2V and the VCC pin voltage rises above about 6.5V. Generally, in a battery pack this happens only one time when the cells are connected to the PCB. Once the ISL94208 powers up, the internal registers are reset to all zeros. In this code, the microcontroller does not put the pack into the sleep mode on initial power-up.

On power-up, the microcontroller checks the status of the UFLG0. If this bit is zero, then this is the first power-up. In this case, the ISL94208 registers are set to their default states and the microcontroller parameters are loaded. If the UFLG0 is "1", then only the microcontroller values are re-loaded.

Sleep Mode

The device can enter sleep mode in four ways:

- (Optional) After initial power-up, the microcontroller puts the pack to sleep. This will take a coding change. It was dropped out because it makes debug and demonstration of the pack difficult.
- The device enters the sleep mode when at least one cell voltage drops below a sleep threshold. This operation is controlled by the microcontroller.
- If there is no current detected for a long period of time, the μ C puts the pack to sleep.
- In response to an external communication from the GUI, the microcontroller sends a command to the ISL94208 through the device serial port.

The sleep mode is induced by the microcontroller, by setting the SLEEP bit in register 04H of the ISL94208. Prior to setting the SLEEP bit, the microcontroller turns off the FETs and does any maintenance operations, because in sleep mode the ISL94208 3.3V voltage regulator turns off - powering down the microcontroller.

While in sleep mode, the contents of the ISL94208 are maintained by the voltage of VBACK. If the voltage on VBACK drops low enough for the contents of the registers to be lost, then it is likely that the cells are damaged and the pack unusable. However...

The microcontroller stores in Flash memory all default register values used to control the pack operation, for two reasons:

- On initial power-up, the microcontroller examines the contents of the UFLG0 bit. If this bit is "1" then this is not an initial condition, since the ISL94208 powers up with this bit equal to "0". In this way, any changes made to the configuration of the ISL94208 is maintained as long as the power remains on the VBACK input.
- Since the contents of the registers determines the operation of some critical functions, the microcontroller periodically checks that the register values are correct. Normally this is not a problem, however, it is desired that a short glitch on the VBACK pin or an inadvertent write operation does not compromise the proper operation of the pack.

Wake up

The device returns from sleep mode when waken by an external signal, usually from the charger, but this could also come from a load or a switch on the board. Note: The wake up signal could even come from the microcontroller, if the microcontroller has its own separate voltage regulator. However, this capability is not to be designed into this code. The wake up signal causes the voltage regulator to power-up. Once the microcontroller powers up, the microcontroller checks the integrity of the registers and scans the cells. In this scan, the microcontroller determines if the cell voltages are too low or too high, if the temperature of the IC and pack is right, and that there is no other safety issue.

If everything checks out, then the microcontroller turns on both power FETs.

TABLE 1. PACK WAKE UP/INITIALIZATION

		DESCRIPTION		
Functional Description	<p>As soon as the microcontroller powers up, it checks the contents of the ISL94208 registers to determine if they have been reset. It does this by checking the ISL94208 UFLGO. If this bit is zero, then assume that this is the first power-up. In the first power-up, write the ISL94208 register values and initialize the microcontroller.</p> <p>Next, the microcontroller needs to scan all of the cells to make sure none exceed the maximum allowable voltage and none are below the minimum voltage. If any of the cell voltages are too high, the charge FET will remain off. If any of the cell voltages are too low, the discharge FET will remain off.</p> <p>Then, the microcontroller monitors the temperature. If the cell or IC temperature is too high, both FETs remain off. If the cell or IC temperatures are too low, the charger FET remains off.</p> <p>If the voltage and temperature conditions are within spec, the microcontroller turns on both power FETs and begins normal scan operations.</p>			
OPTIONAL FUNCTIONS				
SOFTWARE VARIABLES	NAME	LOCATION		DESCRIPTION
	CHARGESET_REG DISCHARGESET_REG FEATURESET_REG	IC	values	These values are the key parameters (registers 5, 6, and 7) from the ISL94208 that need default values to be mirrored in the microcontroller Flash.
	OverVoltageTripLevel OverVoltageTripTime OverVoltageRecoveryLevel OverVoltageRecoveryTime UndervoltageTripLevel UnderVoltageTripTime UnderVoltageRecoveryLevel UnderVoltageRecoveryTime UnderVoltageSleepLevel UnderVoltageSleepTime LoadMonitorOnTime LoadMonitorOffTime ChargeOvercurrentWaitTime ChargeOvercurrentRetestTime XTempLower XTempUpper CBOntime CBOffTime CBCellMinDeltaV CBCellMaxDeltaV CBOverTemp CBUnderTemp CBMinimumBalVoltage CBMaximumBalVoltage CB_Enable_Charge CB_Enable_Discharge Charger_connect CBMaxNumber	µC	values	These values are the key microcontroller parameters for operation of the various subroutines that are controllable by the user through the GUI and need to be kept in RAM in addition to the Flash.

Cell Voltage/Temperature Monitoring

TABLE 2. CELL VOLTAGE MONITORING

	DESCRIPTION
<p>Functional Description</p>	<p>The ISL94208 monitors the voltages on each cell. To speed the cell sampling, there is another value (CellPartition) that indicates the number of cells in the pack. For example, a value of 04H indicates that there are 4 cells being monitored. A value of 06H indicates that this is a configuration with 6 cells. Any comments or code referring to cascading or a partition value greater than 06H is unused code and is residual code from previous iterations of the program.</p> <p>The rate of scan is set by an interrupt set to 250ms. A/D conversion, serial communication and settling time are all sequential and start at the internal temperature (AO3:A00 = 09H). Sampling proceeds to the external temperature, then to the cells starting at CELL6 and working down. After selecting the external temperature, the code needs to wait for about 1ms, so the ISL94208 circuitry can activate in order to check for an external over temperature condition.</p> <p>To measure the cell voltage, the microcontroller sets a value in the Analog Out register to specify the cell being measured. The value for cell voltages measured from the ISL94208 AO pin must be left shifted once after the A/D conversion, since the ISL94208 divides the cell voltages by 2. Temperature measurements should not be shifted, however, the temperature values need to be converted to °C at some point.</p> <p>As part of the cell voltage monitoring, the total pack voltage is calculated. This values (PackVoltage) is provided in the ISL94208 evaluation software GUI display.</p> <p>The microcode samples each cell voltage and then converts it from a hex value to a voltage, which is stored sequentially. If there are fewer than 6 cells, then the middle cells need to be skipped. The skipped cells are determined by the partition value. The scan starts at CELL6, then does CELL5. It then scans CELL4 and CELL3 only if directed by the partition value. The routine finishes by scanning CELL2 and CELL1. If there are 4 cells in the pack; CELL1, CELL2, CELL5, and CELL6, the ADC values will be stored in the first 4 storage locations.</p> <p>Once the voltages are determined, the code checks to see if any cells are overvoltage or undervoltage. See the state machine in figure 3. For details on the overvoltage and undervoltage monitoring, See "Overvoltage Detection/Response" on page 10. and See "Undervoltage Detection/Response" on page 12.</p>
<p>Additional Functions</p>	<p>The GUI and the microcode work together to provide a calibration mechanism to the ISL94208. Each cell input has its own calibration parameter.</p> <p>The GUI has a calibration tab. The tab will show two columns of data. These are for the voltage applied at each input and the voltage read back from each cell. This allows a single point calibration value that is added or subtracted from the measured cell voltage value. The microcode will use these balance values in a calibration step following each acquisition of a cell voltage or at the end of a voltage scan.</p> <p>Roughly, the calibration procedure is as follows. The user applies a known voltage to the pack (or monitors the voltage at each cell input.) For this single offset value solution, the input voltage should be set to 3.6V per cell. The input voltages are recorded on the GUI input screen. The user then uses the microcode software to read the input voltage using its ADC. These values are transferred to the GUI screen. The GUI calculates the offset values. The offset values are shown on in the GUI and saved to the microcontroller RAM. The microcontroller uses these values every time the cell voltage is read to adjust and calibrate the cell voltage readings. Ultimately, the calibration values are written to the µC Flash memory.</p>

TABLE 2. CELL VOLTAGE MONITORING (Continued)

SOFTWARE VARIABLES	DESCRIPTION				DESCRIPTION																																																
	NAME	LOCATION	RANGE	UNITS																																																	
	CellScanDelay	μC	0 to 256		This value specifies the time between scans of the cell voltages. This value is not used in the existing code, but might be added as part of power saving routines.																																																
	CellPartition	μC	xxH	value	This is the cell partition specification value stored in the microcontroller. The lower nibble specifies the number of cells being monitored by the ISL94208. The following are available partitions: 6 cells: 06H; 5 cells: 05H; 4 cells: 04H																																																
	CellVoltages1 - CellVoltagesN	μC	0 to 65536	mV	These are the A/D converted values of the cell voltages.																																																
	PackVoltage	μC	0 to 65536	mV	This is the sum of the A/D converted values of all cell voltages.																																																
	IntTemp	μC	-32768 to +32768	°C	This is conversion of the internal temperature voltage to °C. It is calculated using the following formula: IntTemp = 85+[(AO-1.1)/(-0.0035)]. Calculate to 0.1 °C. This calculation is not performed within the microcode.																																																
	ExtTemp	μC	0 to 65536	°C	This is conversion of the external temperature voltage to °C. It is calculated using the following formula: ExtTemp = Table lookup (R, °C) where: R = (5900*AO)/(3.3-AO) (Note: 3.3 = regulator voltage) <table border="0" style="margin-left: 20px;"> <tr> <td>R</td> <td>T °C</td> <td>R</td> <td>T °C</td> </tr> <tr> <td>68.2k</td> <td>-20</td> <td>6.95k</td> <td>35</td> </tr> <tr> <td>53.6k</td> <td>-15</td> <td>5.83k</td> <td>40</td> </tr> <tr> <td>42.5k</td> <td>-10</td> <td>4.92k</td> <td>45</td> </tr> <tr> <td>33.9k</td> <td>-5</td> <td>4.16k</td> <td>50</td> </tr> <tr> <td>27.2k</td> <td>0</td> <td>3.54k</td> <td>55</td> </tr> <tr> <td>22.0k</td> <td>5</td> <td>3.01k</td> <td>60</td> </tr> <tr> <td>17.9k</td> <td>10</td> <td>2.59k</td> <td>65</td> </tr> <tr> <td>14.7k</td> <td>15</td> <td>2.23k</td> <td>70</td> </tr> <tr> <td>12.1k</td> <td>20</td> <td>1.92k</td> <td>75</td> </tr> <tr> <td>10.0k</td> <td>25</td> <td>1.67k</td> <td>80</td> </tr> <tr> <td>8.31k</td> <td>30</td> <td>1.45k</td> <td>85</td> </tr> </table> <p>The value is linearly interpolated to get a temperature with 1 °C resolution.</p>	R	T °C	R	T °C	68.2k	-20	6.95k	35	53.6k	-15	5.83k	40	42.5k	-10	4.92k	45	33.9k	-5	4.16k	50	27.2k	0	3.54k	55	22.0k	5	3.01k	60	17.9k	10	2.59k	65	14.7k	15	2.23k	70	12.1k	20	1.92k	75	10.0k	25	1.67k	80	8.31k	30	1.45k	85
R	T °C	R	T °C																																																		
68.2k	-20	6.95k	35																																																		
53.6k	-15	5.83k	40																																																		
42.5k	-10	4.92k	45																																																		
33.9k	-5	4.16k	50																																																		
27.2k	0	3.54k	55																																																		
22.0k	5	3.01k	60																																																		
17.9k	10	2.59k	65																																																		
14.7k	15	2.23k	70																																																		
12.1k	20	1.92k	75																																																		
10.0k	25	1.67k	80																																																		
8.31k	30	1.45k	85																																																		

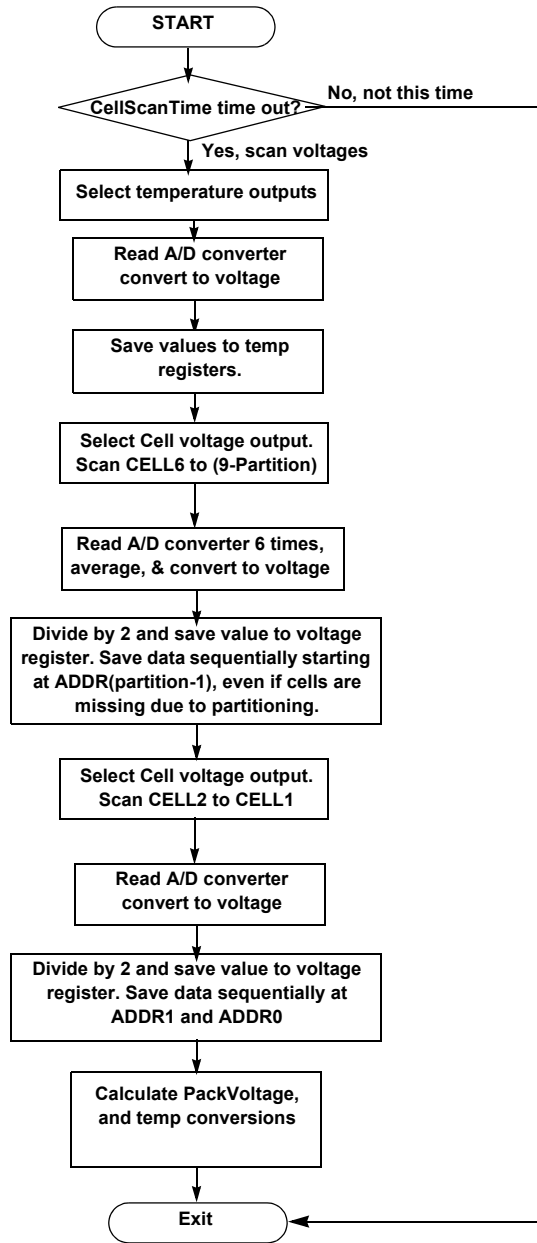

FIGURE 2. CELL VOLTAGE MONITORING

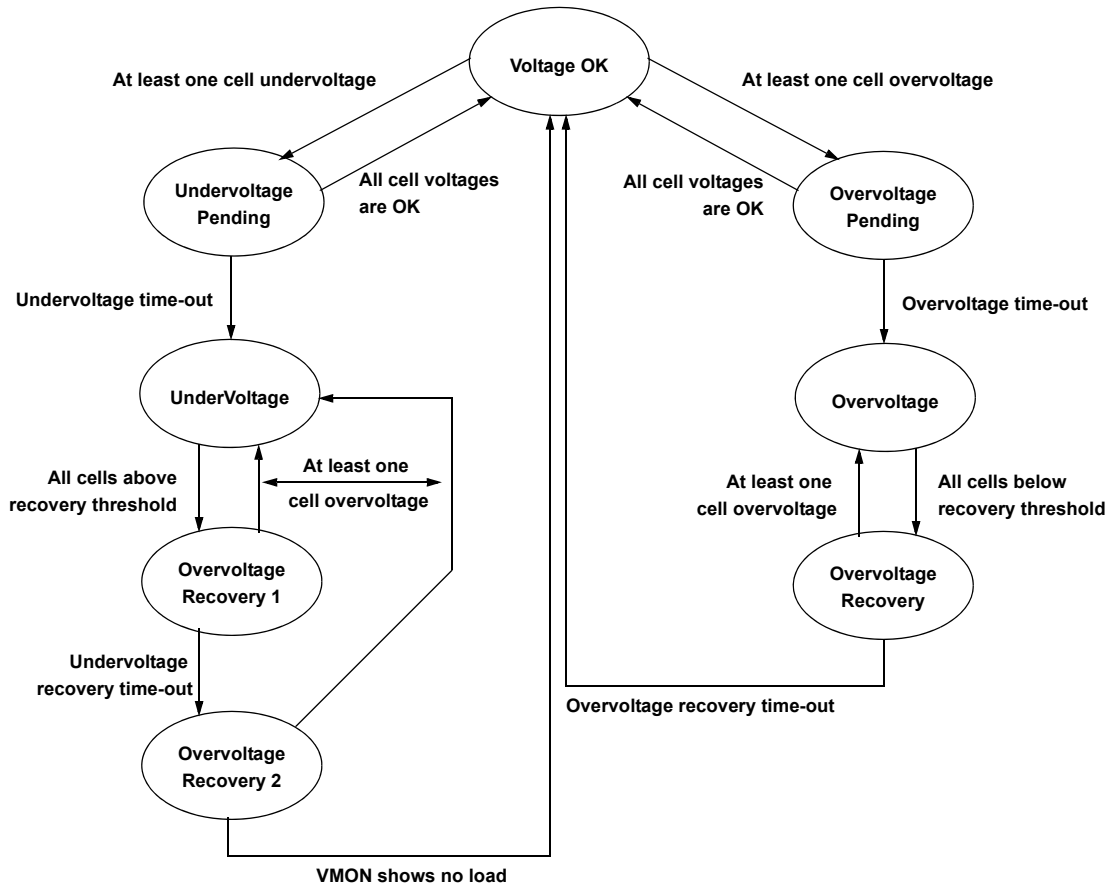

FIGURE 3. CELL VOLTAGE MONITOR STATE MACHINE

Overvoltage Detection/Response

TABLE 3. OVERVOLTAGE DETECTION AND RESPONSE

	DESCRIPTION				
Functional Description	<p>The microcode needs to monitor the voltage on each battery cell (V_{CELL}). If for any cell, $V_{CELL} > V_{OV}$ for a time exceeding t_{OV}, then the microcode must turn both the charge FET OFF, by setting the CFET bit to "0". The pack has now entered Over-charge protection mode. The status of the discharge FET remains unaffected.</p> <p>The charge FET remains off until the voltage on the overcharged cell drops back below a recovery level, V_{OVR}, for a recovery time period, t_{OVR}.</p> <p>The device further continues to monitor the battery cell voltages, and is released from overcharge protection mode when $V_{CELL} < V_{OVR}$ for more than the overcharge release time, for all cells.</p> <p>When the Device is released from over-charge protection mode, the charge FET is automatically switched ON. When the device returns from over-charge protection mode, the status of the discharge FET remains unaffected.</p>				
Optional Functions	<p>The microcontroller may include an option to turn the charge FET back on (in an overvoltage condition) if dV/dt of the pack exceeds a specified limit $DVdtCFETon$ (See "Cell Voltage/Temperature Monitoring" on page 6. for information on dV/dt). Then, if the dV/dt drops below $DVdtCFEToff$ and there is still an over-charge condition on the cell, the microcode again disabled the charge FET. This function is only used if there is a single charge and discharge path. This option is set by a user Flag (Single_Charge_Discharge_Path) stored in Flash.</p>				
SOFTWARE VARIABLES	NAME	LOCATION	RANGE	UNITS	DESCRIPTION
	OverVoltageTripLevel	μC	0 to 256	100mV	This value (V_{OV}) specifies the maximum allowable voltage on any individual cell (divided by 2). Default = 4.2V
	OverVoltageTripTime	μC	0 to 256	100ms	This value (t_{OV}) specifies the time that any cell is allowed to exceed V_{OV} before charging terminates. Default = 1s.
	OverVoltageRecovery Level	μC	0 to 256	100mV	This value (V_{OVR}) is the voltage to which a cell must reach before the charge FET is allowed to turn on (divided by 2). Default = 4.0V
	OverVoltageRecovery Time	μC	0 to 256	100ms	This value (t_{OVR}) specifies the time that the voltage across any cell must be below the V_{OVR} level before the charge FET turns on. Default = 1s.
	DVdtCFETon	μC	0 to 256	mV/s	This optional value specifies the maximum rate of voltage change that is allowed during the discharge of a pack that is in overvoltage protection mode before the charge FET is turned on. This is to prevent the over heating of the charge FET.
	DVdtCFEToff	μC	0 to 256	mV/s	This optional value specifies the minimum rate of voltage change that is allowed during the discharge of a pack that is in overvoltage protection mode before the charge FET is turned off.
	Single_Charge_Discharge_Path	μC			This is an optional bit set to "1" that indicates that there is a single charge and discharge path. This bit set to "0" means that there are separate paths. This bit is saved in the microcontroller Flash and is settable through the GUI.
	Over_Voltage_Tripped	μC			This is a bit that indicates that at least one cell is in an overcharge (overvoltage) condition

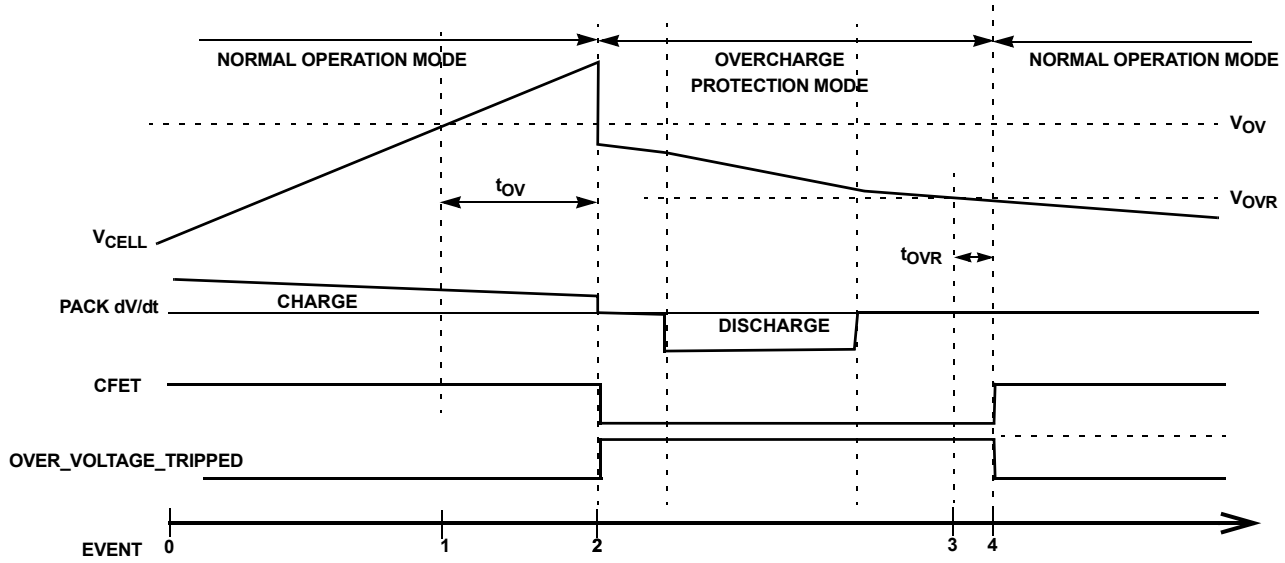

FIGURE 4. OVER-CHARGE PROTECTION MODE-EVENT DIAGRAM

TABLE 4. OVER-CHARGE PROTECTION MODE-EVENT DIAGRAM DESCRIPTION

EVENT	EVENT DESCRIPTION
[0,1]	<ul style="list-style-type: none"> Discharge FET is ON (ISL94208 DFET bit = "1"). Charge FET is ON (ISL94208 CFET bit = "1"), and hence battery cells are permitted to receive charge. All cell voltages ($V_{CELL1} - V_{CELLN}$) are below the over-charge voltage threshold (V_{OV}). The device is in normal operation mode (i.e. not in a protection mode).
[1]	<ul style="list-style-type: none"> The voltage of one or more of the battery cells (V_{CELL}), exceeds V_{OV}. The microcode starts an over-charge detection delay timer. The device is still in normal operation mode
(1,2)	The over-charge detection delay timer continues counting for T_{OV} seconds.
[2]	<p>The over-charge detection delay timer times out AND V_{CELL} still exceeds V_{OV}.</p> <ul style="list-style-type: none"> Therefore, the microcode sends a command to the ISL94208 to switch the charge FET OFF (CFET bit = "0"). The microcontroller sets the OverVoltageTripped bit and the pack has entered the overcharge protection mode.
(2,3)	<ul style="list-style-type: none"> While in over-charge protection mode: The battery cells are permitted to discharge via the discharge FET, and the body diode across the charge FET The microcontroller monitors the voltages $V_{CELL1} - V_{CELLN}$ to determine whether or not they have all fallen below the "Return from over-charge threshold" (V_{OVR}).
[3]	<ul style="list-style-type: none"> All cell voltages fall below V_{OVR}— but the Over-charge release time has not expired
[3]	<ul style="list-style-type: none"> All cell voltages fall below V_{OVR}—and the Over-charge release time has expired The pack is now in normal operation mode so the OverVoltageTripped bit is reset to "0". The microcontroller switches the charge FET = ON (CFET bit = "1") The status of the discharge FET remains unaffected. Charging of the battery cells can now resume.

Undervoltage Detection/Response

TABLE 5. UNDERVOLTAGE DETECTION AND RESPONSE

	DESCRIPTION				
Functional Description	<p>If $V_{CELL} < V_{UV}$, for a time exceeding T_{UV}, the cells are said to be in a over-discharge (undervoltage) state. In this condition, the microcontroller switches the discharge FET OFF (by setting the DFET bit = "0").</p> <p>At this point:</p> <ul style="list-style-type: none"> If any of the cells drop below a second threshold ($V_{CELL} < V_{SLP}$) for a period of time (TSL), the microcontroller does some clean up, turns off the charge FET (CFET bit = "0") and puts the pack into a sleep mode by setting the SLEEP bit to "1". <p>From the Undervoltage condition, if the cells recover to above a V_{UVR} level for a time exceeding T_{UVR}, the microcontroller turns on the VMON output and looks for the absence of a load. If there is no load, and the cells are above the undervoltage recovery level, the microcontroller turns on the discharge FET.</p> <p>If the device has gone to sleep, the microcontroller is also off, so the micro is waken when the regulator turns on (see "Power-up/Initialization" on page 4)</p>				
Optional Functions	There is a special condition in which the discharge FET turns on if the cells are undervoltage, but being charged. The discharge FET will then remain on until the charge stops.				
SOFTWARE VARIABLES	NAME	LOCATION	RANGE	UNITS	DESCRIPTION
	LDMONEN	IC			This bit is set in the ISL94208 by the microcontroller to turn on the load monitor.
	LDFAIL	IC			This bit is set by the ISL94208 to indicate a load failure (continued short circuit).
	SLEEP	IC			This bit is set n the ISL94208 by the microcontroller to go into the sleep mode.
	UnderVoltageTripLevel	μC	0 to 256	100mV	This value specifies the minimum allowable voltage (V_{UV}) on any individual cell for normal operation. Default = 3.0V
	UnderVoltageTripTime	μC	0 to 256	100ms	This value specifies the time (t_{UV}) that any cell is allowed to exceed V_{UV} before discharge is prevented by turning off the DFET. Default = 1s.
	UnderVoltageRecoverLevel	μC	0 to 256	100mV	This value is the voltage to which a cell must reach (V_{UVR}) before the charge FET is allowed to turn on. Default = 3.2V
	UnderVoltageRecoverTime	μC	0 to 256	100ms	This value specifies the time (t_{UVR}) that the voltage across any cell must be above the V_{UVR} level before the charge FET turns on. This also requires that the load has been removed from the pack. Default = 1s.
	UnderVoltageSleepLevel	μC	0 to 256	100mV	This value specifies the minimum allowable voltage (V_{SL}) on any individual cell. If the cell stays below this level for the TSL period of time, the microcontroller specifies that the pack go to sleep. Default = 2.7V
	UnderVoltageSleepTime	μC	0 to 256	100ms	This value specifies the time (t_{SL}) that the voltage across any cell must be below the V_{SL} level before setting the sleep condition. Default = 1s.
Under_Voltage_Tripped	μC			This is a bit that indicates that at least one cell is in an over discharge (undervoltage) condition.	

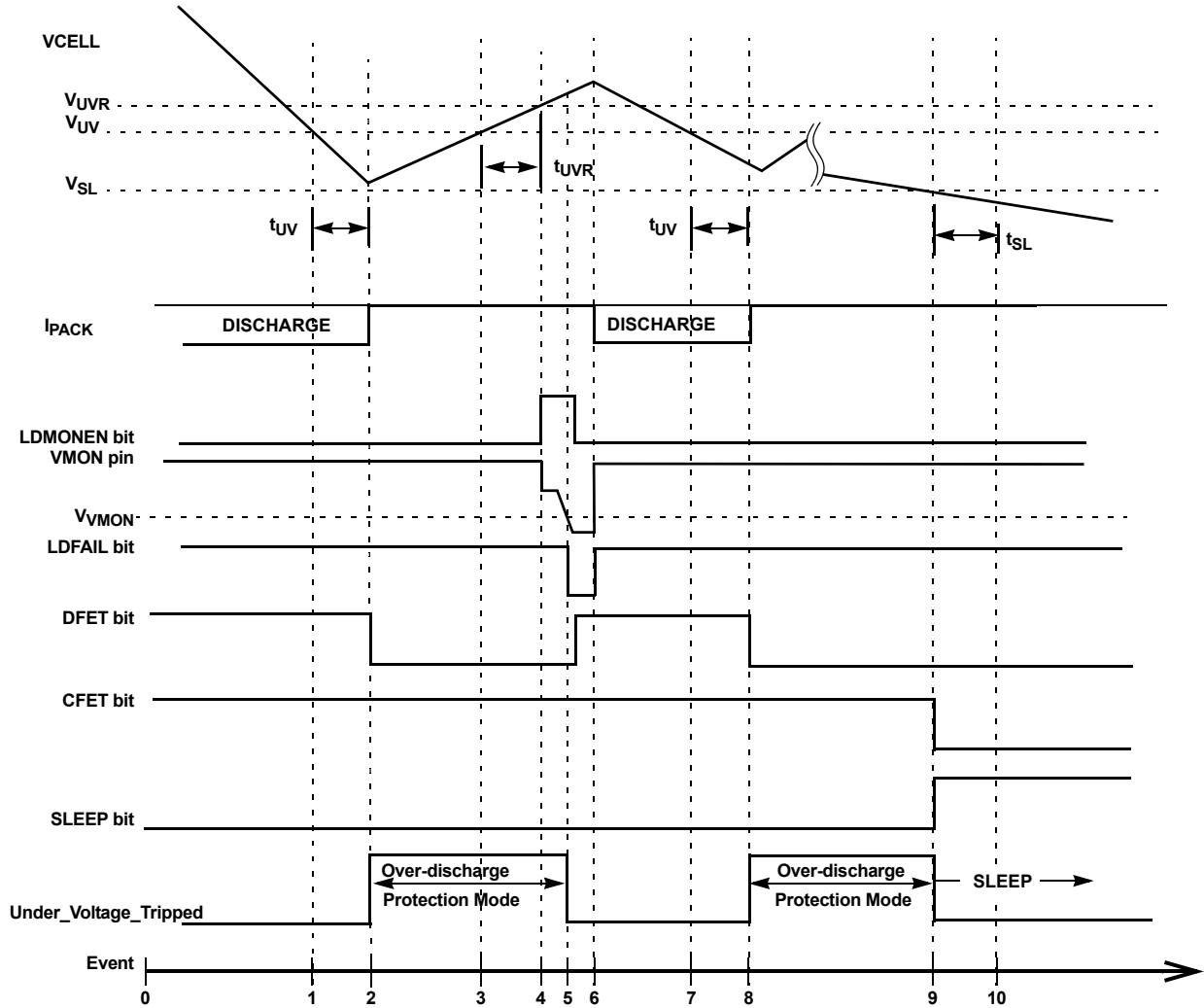

FIGURE 5. OVER-DISCHARGE PROTECTION MODE-EVENT DIAGRAM

TABLE 6. OVER-DISCHARGE PROTECTION MODE-EVENT DIAGRAM DESCRIPTION

EVENT	EVENT DESCRIPTION
[0,1]	<ul style="list-style-type: none"> Charge FET is ON (CFET bit = "1") Discharge FET is ON (DFET bit = "1"), and hence battery cells are permitted to discharge. All cell voltages (V_{CELL_1}-V_{CELL_N}) are above the over-discharge threshold voltage (V_{UV}). The device is in normal operation mode (i.e. not in a protection mode).
[1]	<ul style="list-style-type: none"> The voltage of one or more of the battery cells (V_{CELL}), falls below V_{UV}. The microcontroller over-discharge detection delay timer begins counting. The device is still in normal operation mode
(1,2)	<ul style="list-style-type: none"> The microcontroller over-discharge detection delay timer continues counting for T_{UV} seconds.
[2]	<ul style="list-style-type: none"> The microcontroller over-discharge detection delay timer times out, AND V_{CELL} is still below V_{UV}. The microcontroller switches the discharge FET OFF (sets the DFET bit to "0"). The charge FET remains on (CFET bit = "1"). The microcontroller sets the Under_Voltage_Tripped bit as the pack enters the over-discharge protection mode. At this time, the microcontroller does not enter the sleep mode.
(2,3)	<ul style="list-style-type: none"> While device is in over-discharge protection mode the microcontroller monitors for cell voltage recovery.
[3]	<ul style="list-style-type: none"> Cell voltages rise above V_{UVR}, but device remains in over-discharge protection mode.

TABLE 6. OVER-DISCHARGE PROTECTION MODE—EVENT DIAGRAM DESCRIPTION (Continued)

EVENT	EVENT DESCRIPTION
(3,4)	<ul style="list-style-type: none"> The microcontroller over-discharge recovery detection delay timer continues counting for T_{UVR} seconds.
[4]	<ul style="list-style-type: none"> The voltage of all of the battery cells (V_{CELL}), have risen above V_{UVR} for the minimum amount of time. To prevent an unexpected motor turn on, the microcontroller turns on the VMON output with the LDMONEN bit. When this bit turns on, the VMON pin will be high, and the LDFAIL bit will be high, until the load turns off.
(4,5)	<ul style="list-style-type: none"> The pack is still in over-discharge protection mode. The microcontroller monitors the LDFAIL flag.
[5]	<ul style="list-style-type: none"> The over-discharge release timer has times out, AND V_{CELL} is still above V_{UVR}, and the load has been released (LDFAIL = "0").
(5,6)	<ul style="list-style-type: none"> The microcontroller resets the Under_Voltage_Tripped flag, turns off the load monitor and turns the discharge FET on.
[6]	<ul style="list-style-type: none"> The load turns on and the batteries again start to drain.
(6,7)	<ul style="list-style-type: none"> The pack is operating normally. There are no protection conditions.
[7]	<ul style="list-style-type: none"> The voltage of one or more of the battery cells (V_{CELL}), falls below V_{UV}. The microcontroller over-discharge detection delay timer begins counting. The device is still in normal operation mode
(7,8)	<ul style="list-style-type: none"> The microcontroller over-discharge detection delay timer continues counting for T_{UV} seconds.
[8]	<ul style="list-style-type: none"> The microcontroller over-discharge detection delay timer times out, AND V_{CELL} is still below V_{UV}. The microcontroller switches the discharge FET OFF (sets the DFET bit to "0"). The charge FET remains on (CFET bit = "1"). The microcontroller sets the Under_Voltage_Tripped bit as the pack enters the over-discharge protection mode. At this time, the microcontroller does not enter the sleep mode.
(8,9)	<ul style="list-style-type: none"> While device is in over-discharge protection mode the microcontroller monitors for cell voltage recovery. The cells do not recover and no charger is connected. The cell voltages continue to decline.
[9]	<ul style="list-style-type: none"> The voltage of one or more of the battery cells (V_{CELL}), falls below the sleep voltage level, V_{SL} The microcontroller sleep detection delay timer begins counting. The device is still in over-discharge mode. The discharge FET is off.
(9,10)	<ul style="list-style-type: none"> The microcontroller sleep detection delay timer continues counting for T_{SL} seconds.
[10]	<ul style="list-style-type: none"> The voltage of one or more of the battery cells (V_{CELL}), remains below the sleep voltage level, V_{SL} The microcontroller sleep detection delay timer times out. The microcontroller turns off the charge FET, completes housekeeping tasks and sets the SLEEP bit. Setting the sleep bit in the ISL94208 turns off the voltage regulator powering the microcontroller.

Discharge Overcurrent and Short Circuit Detection/Response

TABLE 7. DISCHARGE OVERCURRENT/SHORT CIRCUIT DETECTION AND RESPONSE

	DESCRIPTION				
Functional Description	<p>The ISL94208 continually monitors discharge current by monitoring voltage across a current sense resistor at the Dsense pin. When the voltage at the terminal exceeds the limit, the FETs are automatically turned off, unless over-ridden by the overcurrent or short circuit disable flags (DENOCD and DENSCD). If the automatic response is over-ridden, then the microcontroller needs to turn off the FETs. This software implementation will base its operation on the status of the over-ride bits, since they can be controlled by the user through the GUI.</p> <p>Overcurrent is specified as current exceeding the overcurrent threshold voltage, set by the overcurrent threshold bits (OCDV1:OCDV0) for the overcurrent time delay, set by the overcurrent time out bits (OCDT1:OCDT0) and the discharge time speed up bit (DTDIV). The microcontroller can detect the overcurrent condition by monitoring the DOC bit.</p> <p>Short circuit is specified as current exceeding the short circuit threshold voltage, set by the short circuit threshold bits (OCCV1:OCCV0) for the short circuit time out period, set by the short circuit time out bit (SCLONG). The microcontroller can detect the short circuit condition by monitoring the DSC bit.</p> <p>Once the ISL94208 enters overcurrent protection mode, the microcontroller begins a load monitor state. In the load monitor state, the microcontroller turns on the load monitor by setting the LDMONEN bit to "1". This allows a small current to flow from the load through an external resistor and into the device. With a load present, the voltage on the VMON pin is high and the LDFAIL bit is set to "1". When the load rises to a sufficiently high resistance, the voltage on the VMON pin drops below the VMON threshold and the LDFAIL bit is reset. When the load has been released for a sufficiently long period of time (t_{OCR} or t_{SCR}) the microcontroller acknowledges the removal of the load and re-enables the power FETs by setting the CFET and DFET bits to "1".</p> <p>If the load has not been removed in LoadMonitorOn seconds after entering the load monitor state, LDMONEN is reset to "0". After LoadMonitorOff seconds, the load monitor is turned on and waits again for LoadMonitorOn seconds before turning off the load monitor. This continues indefinitely.</p>				
Software Variables	NAME	LOCATION	RANGE	UNITS	DESCRIPTION
	VOCD	IC/ μ C	2 bits		Selection bits for the discharge overcurrent protection threshold
	VSC	IC/ μ C	2 bits		Selection bits for the discharge short circuit protection threshold
	TOCD	IC/ μ C	2 bits		This value (along with the DTDIV bit) specifies the time that the overcurrent can remain before the charge and discharge FETs turns off.
	DTDIV	IC/ μ C	1 bit		This value specifies the overcurrent delay is divided by 1 or by 64.
	SCLONG	IC/ μ C	1 bit		This value specifies the time that the short circuit can remain (short or long) before the charge and discharge FETs turns off.
	DENOCD	IC/ μ C	1 bit		ISL94208 bit set to "0" to enable automatic discharge overcurrent response.
	DENSCD	IC/ μ C	1 bit		ISL94208 bit set to "0" to enable automatic short circuit response.
	DOC	IC/ μ C	1 bit		ISL94208 bit set to "1" to indicate a discharge overcurrent condition.
	DSC	IC/ μ C	1 bit		ISL94208 bit set to "1" to indicate a short circuit condition.
	LDMONEN	IC			This bit is set in the ISL94208 by the microcontroller to turn on the load monitor.
	LDFAIL	IC			This bit is set by the ISL94208 to indicate a load failure (continued short circuit).
	LoadMonitorOnTime	μ C	0 to 256	sec	This value (t_{MONON}) specifies the time that the load monitor will be allowed to continue without detecting a release of the load.
	LoadMonitorOffTime	μ C	0 to 65535	sec	This value (t_{MONOFF}) specifies the time between load monitor states to restart the release of load detection.

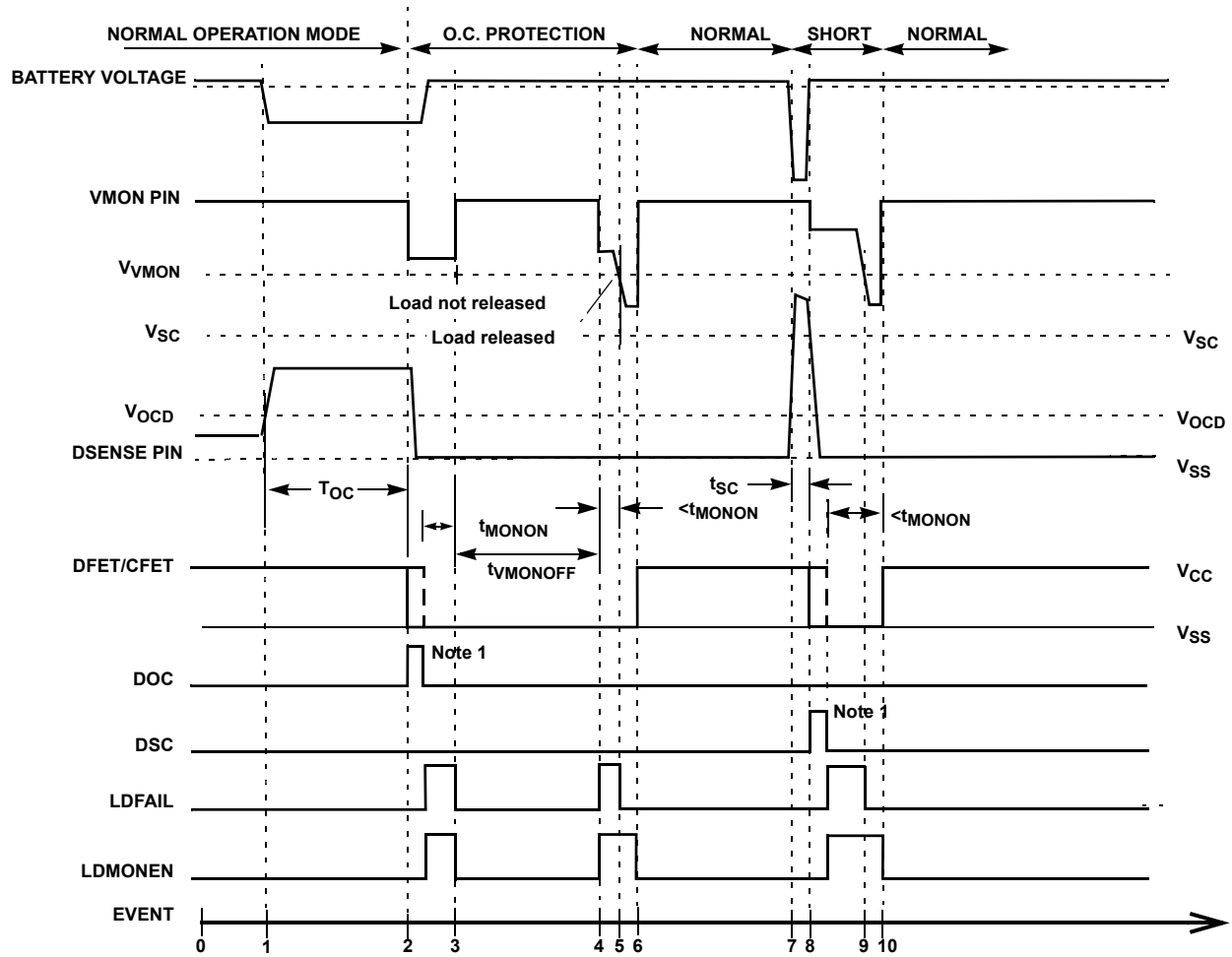

FIGURE 6. DISCHARGE OVERCURRENT PROTECTION MODE - EVENT DIAGRAM

NOTE:

1. DOC and DSC bits are reset when the register is read.

TABLE 8. DISCHARGE OVERCURRENT AND SHORT CIRCUIT PROTECTION MODE-EVENT DIAGRAM DESCRIPTION

EVENT	EVENT DESCRIPTION
(0,1)	<ul style="list-style-type: none"> Discharge FET is ON (DFET bit = "1") and Charge FET is ON (CFET = "1"). Battery cells are permitted to discharge. Current sense resistor voltage is less than the discharge overcurrent threshold voltage (V_{OCD}) and less than the short circuit threshold (V_{SC}). The device is in normal operation mode (i.e. not in a protection mode).
[1]	<ul style="list-style-type: none"> Excessive current starts flowing through the battery terminals, dropping the battery voltage. The voltage across the current sense resistor exceeds V_{OCD}. The ISL94208 overcurrent detection delay timer begins counting down. The device is still in Normal Operation Mode
(1,2)	The ISL94208 overcurrent detection delay timer continues counting for T_{OC} seconds.
[2]	<ul style="list-style-type: none"> The ISL94208 overcurrent detection delay timer times out, AND the sense resistor voltage V_{dsense} is still above V_{OCD}. The ISL94208 automatically turns off the DFET and the CFET (unless over-ridden by the DENOCD and DECS CD bits) The ISL94208 sets the DOC flag.
(2,3)	<ul style="list-style-type: none"> The microcontroller detects that there is an overcurrent condition by reading the status register and seeing a DOC bit = "1". Reading the status register resets the DOC bit. The microcontroller turns off the discharge and charge FETs (if not already automatically turned off) by setting the DFET and CFET bits to "0". The microcontroller turns on the LDMONEN bit to start the load monitor The microcontroller monitors the LDFAIL bit. If it goes LOW, then the load is released.
[3]	<ul style="list-style-type: none"> LDFAIL did not go low and the microcontroller load monitor time out expires, so the micro turns off the LDMONEN bit to stop looking for a load release for a while.
(3,4)	<ul style="list-style-type: none"> The microcontroller times out the period between load release scans.
[4]	<ul style="list-style-type: none"> The microcontroller starts the load monitor again by setting the LDMONEN bit to "1". The microcontroller starts scanning the LDFAIL bit.
[5]	<ul style="list-style-type: none"> The VMON pin drops below the VMON threshold level as the load is released. The positive battery terminal voltage (P+) falls, and VCS_{21} exceeds V_{SC}. The FET is turned off immediately. There is no delay and the FET drive should be stronger than a normal FET turnoff.
[6]	<ul style="list-style-type: none"> The microcontroller has detected that there is no current and that the load has been released. The microcontroller turns off the load monitoring by setting the LDMONEN bit = "0". The microcontroller turns on the discharge and charge FETs by setting the DFET = "1" and CFET = "1" The device has now returned to a normal operating condition so discharge of the battery cells is once again possible.
(6,7)	<ul style="list-style-type: none"> Discharge FET is ON (DFET bit = "1") and Charge FET is ON (CFET = "1"). Battery cells are permitted to discharge. Current sense resistor voltage is less than the discharge overcurrent threshold voltage (V_{OCD}) and less than the short circuit threshold (V_{SC}). The device is in normal operation mode (i.e. not in a protection mode).
[7]	<ul style="list-style-type: none"> Excessive current starts flowing through the battery terminals, dropping the battery voltage. The voltage across the current sense resistor exceeds both V_{OCD} and V_{SCD}. The ISL94208 overcurrent and short circuit detection delay timers begin counting down. The device is still in Normal Operation Mode
(7,8)	<ul style="list-style-type: none"> The ISL94208 short circuit detection delay timer continues counting for T_{SC} seconds.
[8]	<ul style="list-style-type: none"> The ISL94208 short circuit detection delay timer times out, AND the sense resistor voltage V_{dsense} is still above V_{SC}. The ISL94208 automatically turns off the DFET and the CFET (unless over-ridden by the DENOCD and DECS CD bits) The ISL94208 sets the DSC flag.
(8,9)	<ul style="list-style-type: none"> The microcontroller detects that there is a short circuit condition by reading the status register and seeing a DOC bit = "1". Reading the status register resets the DSC bit. The microcontroller turns off the discharge and charge FETs (if not already automatically turned off) by setting the DFET and CFET bits to "0". The microcontroller turns on the LDMONEN bit to start the load monitor The microcontroller monitors the LDFAIL bit. If it goes LOW, then the load is released.
[9]	<ul style="list-style-type: none"> LDFAIL bit is read to be "0" by the microcontroller. This indicates that the short circuit load has been released.
[10]	<ul style="list-style-type: none"> The microcontroller has detected that there is no current and that the load has been released. The microcontroller turns off the load monitoring by setting the LDMONEN bit = "0". The microcontroller turns on the discharge and charge FETs by setting the DFET = "1" and CFET = "1" The device has now returned to a normal operating condition so discharge of the battery cells is once again possible.

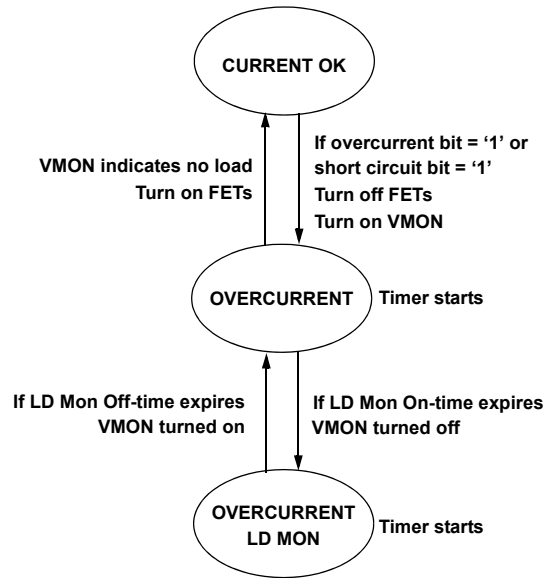

FIGURE 7. DISCHARGE OVERCURRENT AND SHORT CIRCUIT STATE MACHINE

Charge Overcurrent Detection/Response

TABLE 9. CHARGE OVERCURRENT DETECTION AND RESPONSE

	DESCRIPTION				
Functional Description	<p>The ISL94208 continually monitors charge current by monitoring voltage across a current sense resistor at the Csense pin. When the voltage at the terminal exceeds the limit, the charge FET is automatically turned off, unless over-ridden by the overcurrent disable flag (DENOCC). If the automatic response is over-ridden, then the microcontroller needs to turn off the FETs. This software implementation will base its operation on the status of the over-ride bits, since they can be controlled by the user through the GUI. Overcurrent is specified as current exceeding the overcurrent threshold voltage, set by the overcurrent threshold bits (OCCV1:OCCV0) for the overcurrent time delay, set by the overcurrent time out bits (OCCT1:OCCT0) and the discharge time speed up bit (CTDIV). The microcontroller can detect the overcurrent condition by monitoring the COC bit. Once the ISL94208 enters overcurrent protection mode, the microcontroller waits for a period of time t_{SCDW}, then turns the charge FET on again. If there is an overcurrent again within a time period t_{SCDR}, then the microcontroller puts the ISL94208 into a sleep condition, waiting for the removal and re-connection of the charger.</p>				
OPTIONAL FUNCTIONS					
SOFTWARE VARIABLES	NAME	LOCATION	RANGE	UNITS	DESCRIPTION
	VOCC	IC/ μ C	2 bits		ISL94208 selection bits for the discharge overcurrent protection threshold
	TOCC	IC/ μ C	2 bits		ISL94208 value (t_{OCC} , along with the ISL94208 CTDIV bit) specifies the time that the overcurrent can remain before the charge and discharge FETs turns off.
	CTDIV	IC/ μ C	1 bit		This ISL94208 value specifies the overcurrent delay is divided by 1 or by 32.
	DENOCC	IC/ μ C	1 bit		ISL94208 bit set to "0" to enable automatic charge overcurrent response.
	COC	IC/ μ C	1 bit		ISL94208 bit set to "1" to indicate a charge overcurrent condition.
	ChargeOvercurrentWaitTime	μ C	0 to 256	sec	This value specifies the time that the microcontroller will wait after detecting a charger overcurrent condition before starting another charge operation.
	ChargeOvercurrentRetestTime	μ C	0 to 256	sec	This value specifies the time that the microcontroller looks for an overcurrent condition after a previous charge overcurrent condition. If the microcontroller detects an overcurrent during the repeat charge time period, then the microcontroller will put the pack into a sleep condition.

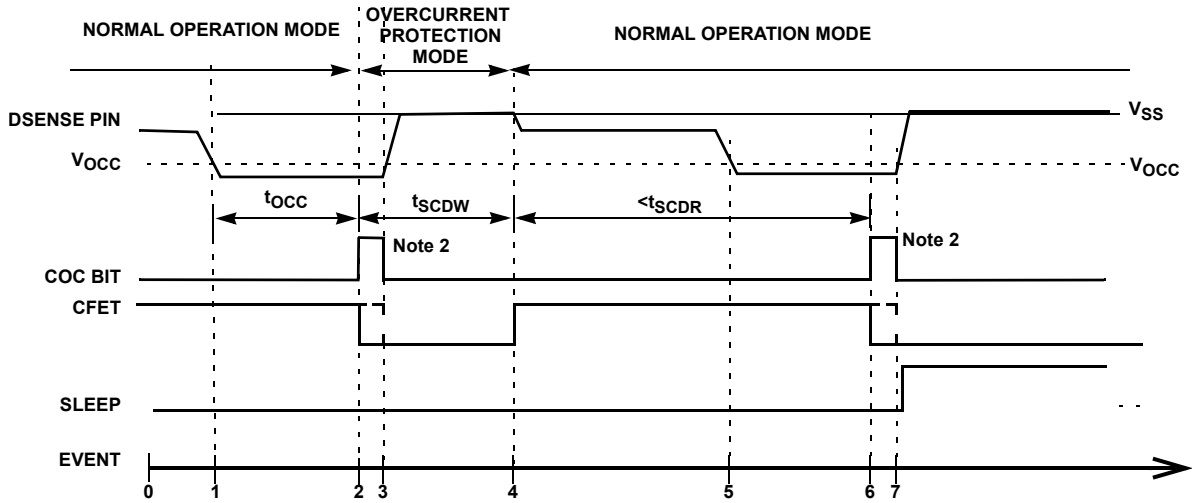

FIGURE 8. CHARGE OVERCURRENT PROTECTION MODE - EVENT DIAGRAM

NOTE:

- 2. COC bit is reset when the register is read.

TABLE 10. CHARGE OVERCURRENT PROTECTION MODE-EVENT DIAGRAM DESCRIPTION

EVENT	EVENT DESCRIPTION
(0,1)	<ul style="list-style-type: none"> • Charge FET is ON (CFET = "1"). Discharge FET is on (DFET = "1"). Battery cells are permitted to charge. • The voltage at the Dsense pin is less than the overcurrent threshold voltage (V_{OCC}). • The device is in normal operation mode (i.e. not in a protection mode).
[1]	<ul style="list-style-type: none"> • Excessive charge current flows into the pack. • The ISL94208 charge overcurrent detection delay timer begins counting down. • The device is still in Normal Operation Mode
(1,2)	<ul style="list-style-type: none"> • The internal Overcurrent detection delay timer continues counting for t_{OC} seconds. • The microcontroller monitors the COC bit.
[2]	<ul style="list-style-type: none"> • The ISL94208 charge overcurrent detection delay timer times out, AND the voltage across the discharge resistor is still above V_{OCC}. • The ISL94208 charge overcurrent circuitry switches the charge FET OFF (CFET = "0"), unless the automatic overcurrent response is over-ridden. • The ISL94208 sets the COC bit. • The device has now entered overcurrent protection mode.
[3]	<ul style="list-style-type: none"> • The microcontroller detects that there is an overcurrent condition by reading the status register and seeing a COC bit = "1". • Reading the status register resets the COC bit. • The microcontroller turns off the charge FET (if not already automatically turned off) by setting the CFET bit to "0". • The microcontroller starts a timer (TSCDW) that waits for a while, keeping the charger off.
(3,4)	<ul style="list-style-type: none"> • The microcontroller TSCDW wait timer counts down.
[4]	<ul style="list-style-type: none"> • The microcontroller TSCDW timer times out. • The microcontroller turns on the charge FET by setting the CFET bit to "1". • The microcontroller starts a timer (TSCDR) that prevents repetitive charge overcurrent conditions from occurring too frequently.
[5]	<ul style="list-style-type: none"> • Excessive charge current again flows into the pack. • The ISL94208 charge overcurrent detection delay timer begins counting down. • The device is still in Normal Operation Mode. • The repetitive timer TSCDR has not yet timed out.
[6]	<ul style="list-style-type: none"> • The ISL94208 charge overcurrent detection delay timer times out, AND the voltage across the discharge resistor is still above V_{OCC}. • The ISL94208 charge overcurrent circuitry switches the charge FET OFF (CFET = "0"), unless the automatic overcurrent response is over-ridden. • The ISL94208 sets the COC bit. • The device has again entered overcurrent protection mode.
[7]	<ul style="list-style-type: none"> • The microcontroller detects that there is an overcurrent condition by reading the status register and seeing a COC bit = "1". • Reading the status register resets the COC bit. • The microcontroller turns off the charge FET (if not already automatically turned off) by setting the CFET bit to "0". • The TSCDR timer has not yet expired, meaning a second charge overcurrent condition in too short a period of time. • Because there were two charge overcurrent conditions within the time period, the microcontroller saves its state and puts the pack into the sleep condition by setting the ISL94208 SLEEP bits to "1".

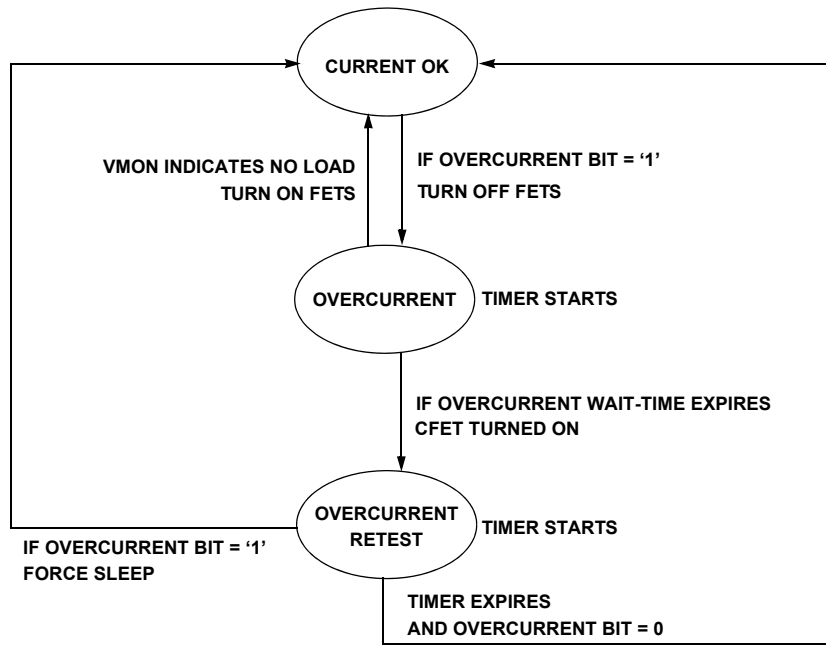

FIGURE 9. DISCHARGE OVERCURRENT AND SHORT CIRCUIT STATE MACHINE

Temperature Monitoring/Response

TABLE 11. TEMPERATURE MONITORING AND RESPONSE

		DESCRIPTION			
Functional Description	<p>The ISL94208 continually monitors both the temperature of the pack and the temperature of the IC.</p> <p>If the temperature of the IC (Internal Temp) goes above 140 °C, then the ISL94208 sets an over temp flag (IOT), prevents cell balancing and turns off the FETs, if automatic response is enabled (DISITSD bit = "0"). Otherwise, the ISL94208 sets an over temperature flag (IOT) and the microcontroller responds to the condition. In this code, the microcontroller response will be identical to the automatic response.</p> <p>If the temperature of the cells (External Temperature) goes above a threshold determined by an external resistor and thermistor, the ISL94208 sets an over temp flag XOT), prevents cell balancing and turns off the FETs, if automatic response is enabled (DISXTSD bit = "0"). Otherwise, the ISL94208 sets an over temperature flag (XOT) and the microcontroller responds to the condition. In this code, the microcontroller response will be identical to the automatic response.</p> <p>The temperature of the IC or cells is also available to the microcontroller through the AO pin. This requires that the internal or external temperature value be selected by using the Analog out register, then requires that the analog voltage be converted to a digital value and scaled appropriately. These temperature values can be used for a number of purposes in the pack operation, but in this code, the only use will be to use the external temperature to prevent charging if the cell temperature is too low.</p> <p>The external temperature scan circuit can be set to automatic or manual. If the ATMPOFF flag is set to "0", then the external temperature is sampled for 4ms out of every 512ms. In this case, an over temperature condition is detected automatically. If the ATMPOFF bit is set to "1", the microcontroller code needs to sample the external temperature periodically. To do this, a timer value (TempScan) is required to set the time between external temperature scans. The actual "on" time of the temperature circuit is determined by the register read operation.</p>				
OPTIONAL FUNCTIONS					
SOFTWARE VARIABLES	NAME	LOCATION	RANGE	UNITS	DESCRIPTION
	IOT	IC	1 bit		ISL94208 bit indicates an internal over temperature condition.
	XOT	IC	1 bit		ISL94208 bit indicates an external over temperature condition.
	DISITD	IC/μC	1 bit		ISL94208 bit set to "1" to disable automatic internal over temperature response.
	DISXTD	IC/μC	1 bit		ISL94208 bit set to "1" to disable automatic external over temperature response.
	ATMPOFF	IC/μC	1 bit		Selection bit for the automatic scan of the external temperature.
	TempScanDelay		0 to 255	10ms	This value specifies the time between external temperature scans. A value of 0 means that there is no temperature scan.
	ChargeTempMin		0 to 255	2 °C	This value specifies the minimum temperature allowed for charging. A value of 0 corresponds to a temperature range of -40 °C. A value of 255 corresponds to 87.5 °C.
	TempMeasDelay	μC	0 to 65535	ms	This value specifies the time between analog temperature measurements.
	ExtTemp	μC	-32768 to +32768	0.01 °C	This is the external (cell temperature) converted to °C for the ISL94208 or ISL9216. (The ISL9217 does not have an external temperature measurement)
	ITempLower	μC	-32768 to +32768	0.01 °C	This is the internal (IC temperature) converted to °C for the ISL94208 or ISL9216. (See voltage monitoring, Table 2 for temperature conversion calculation.
	ITempUpper	μC	-32768 to +32768	0.01 °C	This is the internal (IC temperature) converted to °C for the ISL9217

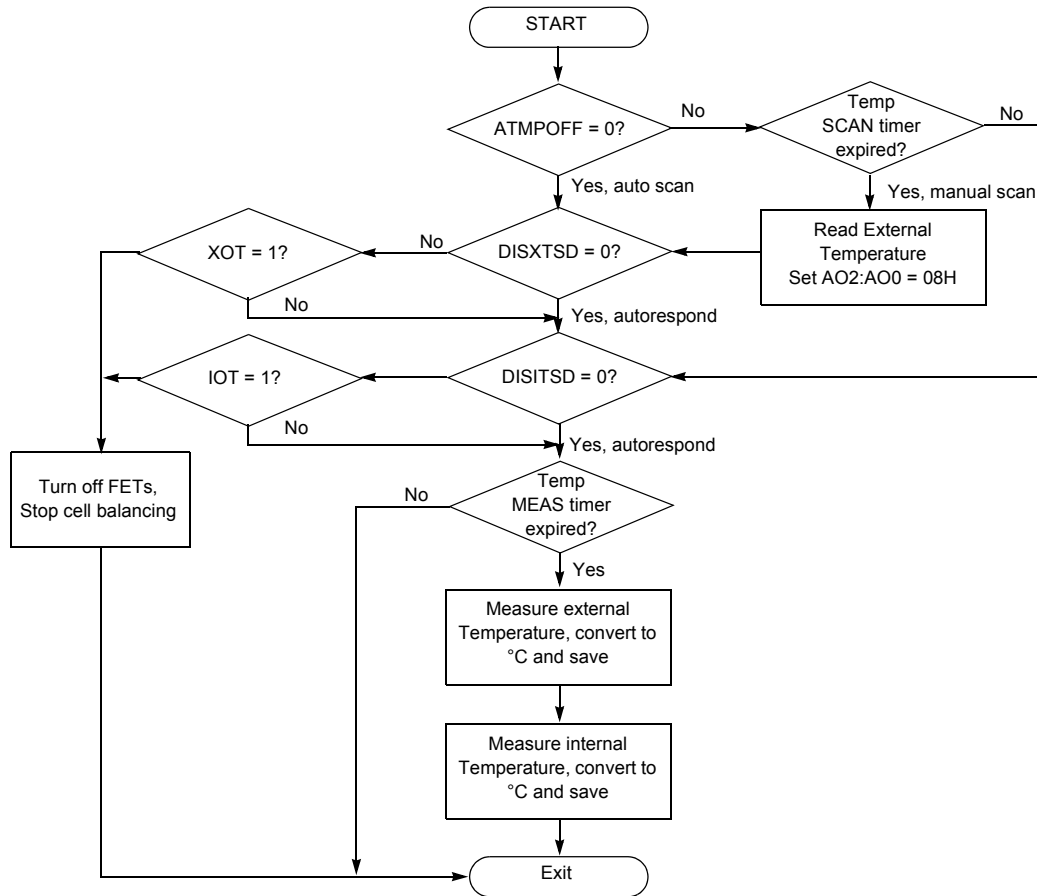

FIGURE 10. TEMPERATURE MONITORING AND RESPONSE

Current Direction Detection

The evaluation board provides a circuit to indicate the presence of a charge or discharge current. The algorithm periodically monitors the Discharge Current input (DSCG_I) port PTB5 (pin 7) and the Charge Current input (CHRG_I) port PTB4 (pin 8).

If the DSCG_I pin is “HIGH”, then the algorithm sets the “discharging” flag HIGH. If the CHRG_I pin is HIGH, then the algorithm sets the “charging” flag HIGH. These flags are used for the cell balance and power management routines and are passed to the GUI.

If the CHRG_I pin is HIGH and the CB_Enable_Charge bit is set, the cell balance is enabled. See “Cell Balancing” on page 25.

Power Management Control

The microcontroller code monitors the “charging” and “discharging” flags and if neither is set will start a counter. The counter is set to a value provided by the GUI in the PACK tab (PowerManagementOnTime). This counter value is written to Flash along with the other pack values.

The counter value is set for 1 to 15 minutes (a 4-bit value in the microcode.) If there is no charge or discharge current detected within the counter period, the FETs are turned off, cell balance is turned off and the ISL94208 are put into a sleep mode.

A zero in this register turns off the powerdown operation.

Open Wire Detection

This routine detects the presence of an open input cell. This routine is run once at power up (right after the FETs are initially turned on) and then every time just prior to the cell balance “On” period. That is, before any cell balance outputs are turned on, this routine runs.

The procedure is as follows:

Whenever any of the following conditions exist take the associated action immediately:

- If any cell < 0.5V when not charging – take Action 1 (see “Actions”).
- If any cell < 0.5V when charge current present - take Action 2.
- If any cell > 4.7V – take Action 1.
- If $|VC_n - VC_{(n-1)}| > CBMaxDV$ – take Action 1.

ACTIONS

1. Turn off all FETs (power FETs/balance FETs), turn on PTB7 output (this is an indicator only). Continue to scan the cells. If the voltage returns to normal levels, recover the pack operation.
2. Turn off discharge FET, turn off all cell balance FETs – leave charge FET on.

Continue checking and if the open wire is resolved, reset the bit. This will allow the FETs to turn on and CB to be executed if everything else is OK.

Code Revision

The GUI will be able to show the current revision of the software loaded into the μC . The microcode now includes a revision number, that is sent to the GUI. The revision number includes both the software revision and the device base code.

Communications

Communications with between the device and the microcontroller use an I²C protocol. The ISL94208 uses an industry standard 7-bit address, slave protocol. Communications between the microcontroller and the outside world can be any desired type of connection, I²C, one-wire, SPI, etc. However for this code implementation, the communication outside the pack uses a master/slave 7-bit I²C protocols. The Specific communication protocols between the microcontroller and the PC are not described in this document.

TABLE 12. MICROCONTROLLER TO DEVICE COMMUNICATIONS

	DESCRIPTION		
Functional Description	<p>I²C Slave Address: This is the address of the device on the I²C bus. The I2C slave address is the first one to be sent in the communication stream. The last bit in the slave address identifies the subsequent operation as a read or a write. If the last bit is a "1", it is a read. If it is a "0" it is a write. ISL94208: 0101 000x</p> <p>Register Address: (See below) The second byte sent to the ISL94208 (following an ACK bit) is the address of the register being read or written.</p> <p>Data: The third byte sent or received from the ISL94208 (following an ACK bit) is the data byte. The ACK bit following the data byte increments the address, so additional data can be transferred between the ISL94208 and the microcontroller by sending or receiving subsequent data bytes before sending the final stop bit. However, when the address reaches 0AH, the address "wraps around" back to address 0, so care needs to be taken in multiple write operation.</p>		
	ADDRESSES	FUNCTION	
	00H, 01H	Status registers - read only	
	02H, 03H, 04H	Control registers - read or write. These register control functions that turned off as a default or in sleep mode.	
	05H, 06H, 07H	Configuration registers - read or write. These registers control the basic operation of the ISL94208. These should be re-loaded from a default set stored in the microcontroller Flash.	
	08H	Write enable register - read or write. This register controls the ability to change the contents of the ISL94208 configuration registers. These are always reset to zero following a write operation, so the microcontroller needs to set the proper bit to "1" prior to a write to a configuration register.	
	09H, 0AH	Test registers - read or write. These register control various test modes of the device and should not be used in normal device operation.	
	0BH - FFH	Reserved locations: Do not access these addresses.	
Optional Functions	Other device can be placed on the I2C bus, besides the ISL94208, as long as the device I2C slave address does not conflict. For example, on an initial ISL94208 test board, a serial A/D converter will be used. The I2C slave address of this device is: 1001 000x.		
Software Variables	NAME		DESCRIPTION
	REG5-REG7	values	These values are the key parameters from the ISL94208 that need default values to be mirrored in the microcontroller Flash.

Cell Balancing

TABLE 13. MICROCONTROLLER TO DEVICE COMMUNICATIONS

	DESCRIPTION																																																																																					
<p>Functional Description</p>	<p>At the same rate as the scan of the cell voltages, if cell balancing is on, the system is checked for cell balance proper conditions. The microcontroller prevents cell balancing if proper conditions are not met. There will be no cell balancing if the temperature, current, and voltage conditions exceed the limits specified in CBOverTemp, CBUnderTemp.</p> <p>The microcontroller calculates the voltage of the lowest cell and the highest cell. If the difference between these cells is below CBCellMinDeltaV voltage, then there will be no cell balancing. If the CBMaxV is greater than the CBMaxBalVoltage or if CBMinV is less than CBMinBalVoltage, then there is an no balancing. If any cell has a voltage greater than the programmed threshold (CBMinDeltaVoltage) above the lowest cell voltage, then that cell balancing output is turned on (up to a maximum of CBMaxNum outputs at once.) If any cell voltage differential exceeds the CBMaxDeltaV, then an error flag is set. Note: All designated cell balancing FETs need to turn on at the same time.</p> <p>Each cell balancing cycle lasts for the programmed interval (CBOntime), after which there is a pause of (CBOffTime). During the CBOntime, the cells are not compared for balance purposes. At the end of the pause, the cell voltages are again compared, and a new cell balance cycle is started, if necessary. Cell balancing can be enabled during charge, discharge or both.</p> <p>If the Cell Balance During Charge bit is set and the board hardware indicates that there is charging current, then the cell balancing is enabled. If the Cell Balance During Discharge bit is set and the external hardware detects that there is a discharge current, then cell balancing is enabled. (See Figure 11.)</p>																																																																																					
<p>Optional Functions</p>	<div style="display: flex; align-items: flex-start;"> <div style="flex: 1;"> <p style="margin-left: 20px;">HIGH = Stop cell balance LOW = Allow balance to continue</p> </div> <div style="flex: 2; margin-left: 20px;"> <table border="1"> <thead> <tr> <th>CB during charge</th> <th>charging</th> <th>CB during discharge</th> <th>dis-charging</th> <th>Desired OUT</th> </tr> </thead> <tbody> <tr><td>0</td><td>0</td><td>0</td><td>0</td><td>1</td></tr> <tr><td>0</td><td>0</td><td>0</td><td>1</td><td>1</td></tr> <tr><td>0</td><td>0</td><td>1</td><td>0</td><td>1</td></tr> <tr><td>0</td><td>0</td><td>1</td><td>1</td><td>0</td></tr> <tr><td>0</td><td>1</td><td>0</td><td>0</td><td>1</td></tr> <tr><td>0</td><td>1</td><td>0</td><td>1</td><td>1</td></tr> <tr><td>0</td><td>1</td><td>1</td><td>0</td><td>1</td></tr> <tr><td>0</td><td>1</td><td>1</td><td>1</td><td>0</td></tr> <tr><td>1</td><td>0</td><td>0</td><td>0</td><td>1</td></tr> <tr><td>1</td><td>0</td><td>0</td><td>1</td><td>1</td></tr> <tr><td>1</td><td>0</td><td>1</td><td>0</td><td>1</td></tr> <tr><td>1</td><td>0</td><td>1</td><td>1</td><td>0</td></tr> <tr><td>1</td><td>1</td><td>0</td><td>0</td><td>0</td></tr> <tr><td>1</td><td>1</td><td>0</td><td>1</td><td>1</td></tr> <tr><td>1</td><td>1</td><td>1</td><td>0</td><td>0</td></tr> <tr><td>1</td><td>1</td><td>1</td><td>1</td><td>1</td></tr> </tbody> </table> <p> CBDC = CB during charge bit CHING = Charge current detected CBDD = CB during discharge bit DCHING = Discharge current detected </p> </div> </div>	CB during charge	charging	CB during discharge	dis-charging	Desired OUT	0	0	0	0	1	0	0	0	1	1	0	0	1	0	1	0	0	1	1	0	0	1	0	0	1	0	1	0	1	1	0	1	1	0	1	0	1	1	1	0	1	0	0	0	1	1	0	0	1	1	1	0	1	0	1	1	0	1	1	0	1	1	0	0	0	1	1	0	1	1	1	1	1	0	0	1	1	1	1	1
CB during charge	charging	CB during discharge	dis-charging	Desired OUT																																																																																		
0	0	0	0	1																																																																																		
0	0	0	1	1																																																																																		
0	0	1	0	1																																																																																		
0	0	1	1	0																																																																																		
0	1	0	0	1																																																																																		
0	1	0	1	1																																																																																		
0	1	1	0	1																																																																																		
0	1	1	1	0																																																																																		
1	0	0	0	1																																																																																		
1	0	0	1	1																																																																																		
1	0	1	0	1																																																																																		
1	0	1	1	0																																																																																		
1	1	0	0	0																																																																																		
1	1	0	1	1																																																																																		
1	1	1	0	0																																																																																		
1	1	1	1	1																																																																																		
<p>FIGURE 11. CELL BALANCE CURRENT DETECTION/START/STOP ROUTINE</p>																																																																																						

TABLE 13. MICROCONTROLLER TO DEVICE COMMUNICATIONS (Continued)

SOFTWARE VARIABLES	DESCRIPTION			
	NAME	RANGE	UNITS	DESCRIPTION
	Charger_connect	OFF/ON	'0'	A "1" in this bit, set by an external pack device, indicates that a charger is connected to the pack.
	CB_Chg_Current_OK	OFF/ON	'0'	This is an optional bit that is set by a charger. "1" indicates that the charge current is high enough for balancing (This bit can be used instead of the dVdT measurements for determining the cell balance minimum current specification).
	CB_Enable_Charge	OFF/ON	'1'	Determines if cell balancing will take place while the pack is charging
	CB_Enable_Discharge	OFF/ON	'0'	Determines if cell balancing will take place while the pack is discharging
	CMinV	0 to 65535	mV	This is the voltage on the cell with the minimum voltage
	CMaxV	0 to 65535	500mV	This is the voltage on the cell with the maximum voltage
	cellv[]	array of integer		This array holds the sorted voltages for balancing. Voltages sorted low to high
	celln[]	array of integer		This array holds the sorted cell number for balancing. Cell number associates with the voltage in the cellv[] array.
	CBOnTime	0 to 65535	seconds	Cell Balance ON cycle time (see functional description on page 25) Default = 600s
	CBOffTime	0 to 65535	seconds	Cell Balance OFF cycle time (see functional description on page 25) Default = 10s
	CBMinBalVoltage	0 to 65535	mV	Cell voltage below which cell balancing will not take place. Default = 3V
	CBMaxBalVoltage	0 to 65535	mV	Cell voltage above which cell balancing will not take place. Default = 4.2V
	CBOverTemp	0 to 65535	°K	Cell temperature above which cell balancing will not take place. Default = -40 °C
	CBUnderTemp	0 to 65535	°K	Cell temperature below which cell balancing will not take place. Default = 0 °C
	CBCellMinDeltaV	0 to 65536	mV	Voltage delta between two cells below which no balancing takes place. Default = 30mV
	CBCellMaxDeltaV	0 to 65536	mV	Voltage differential between two cells above which no balancing takes place. In this case, an error flag is set and may cause the pack to shut down. Default = 500mV
	CBError	ON/OFF		Voltage differential between two cells above which no balancing takes place. In this case, an error flag is set and may cause the pack to shut down.
	CBcount	0 to 8		This is a counter for tracking the number of cells that can be balanced at the same time.
	CBMaxNum	0 to 16		This value specifies the maximum number of cells that can be balanced at the same time. Default = 4.

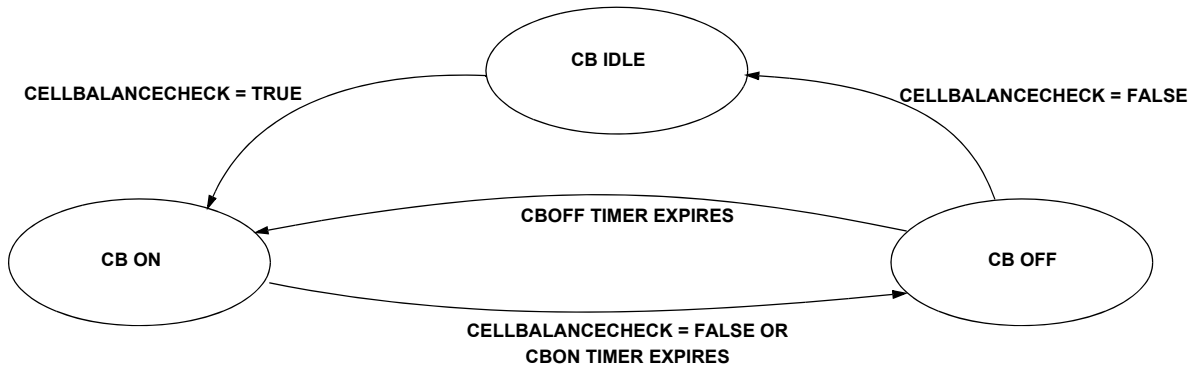

FIGURE 12. CELL BALANCING (STATE DIAGRAM)

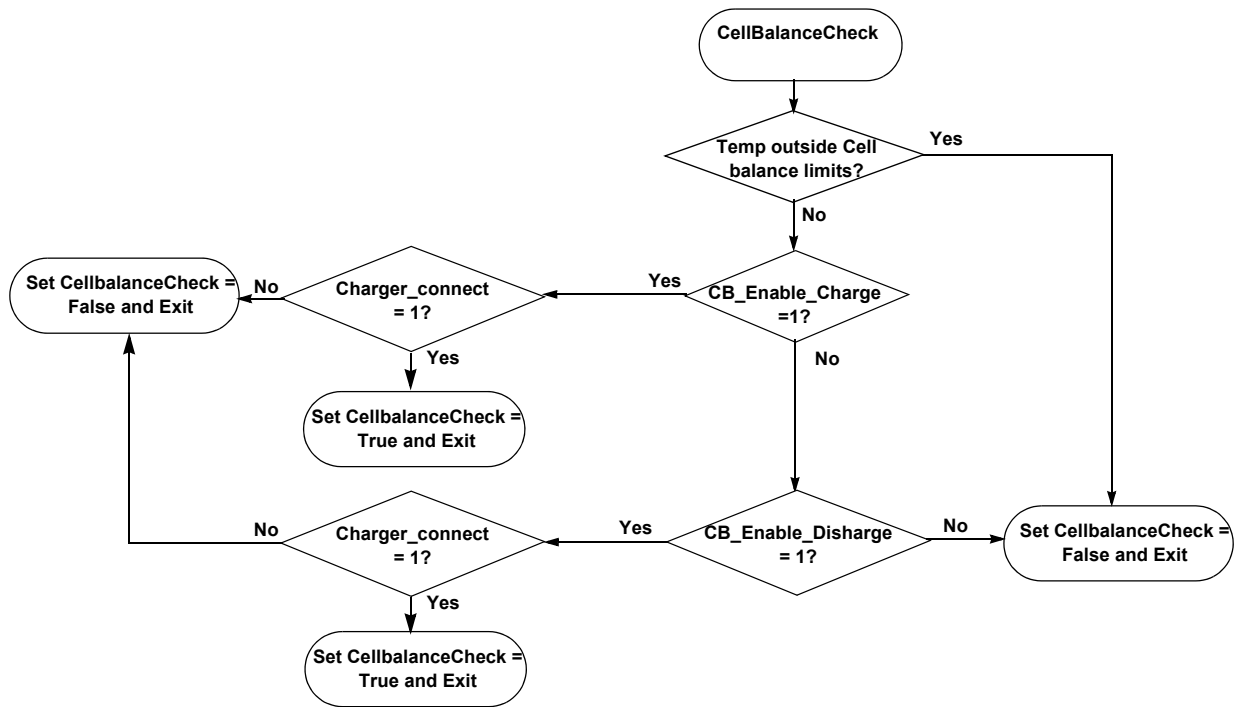
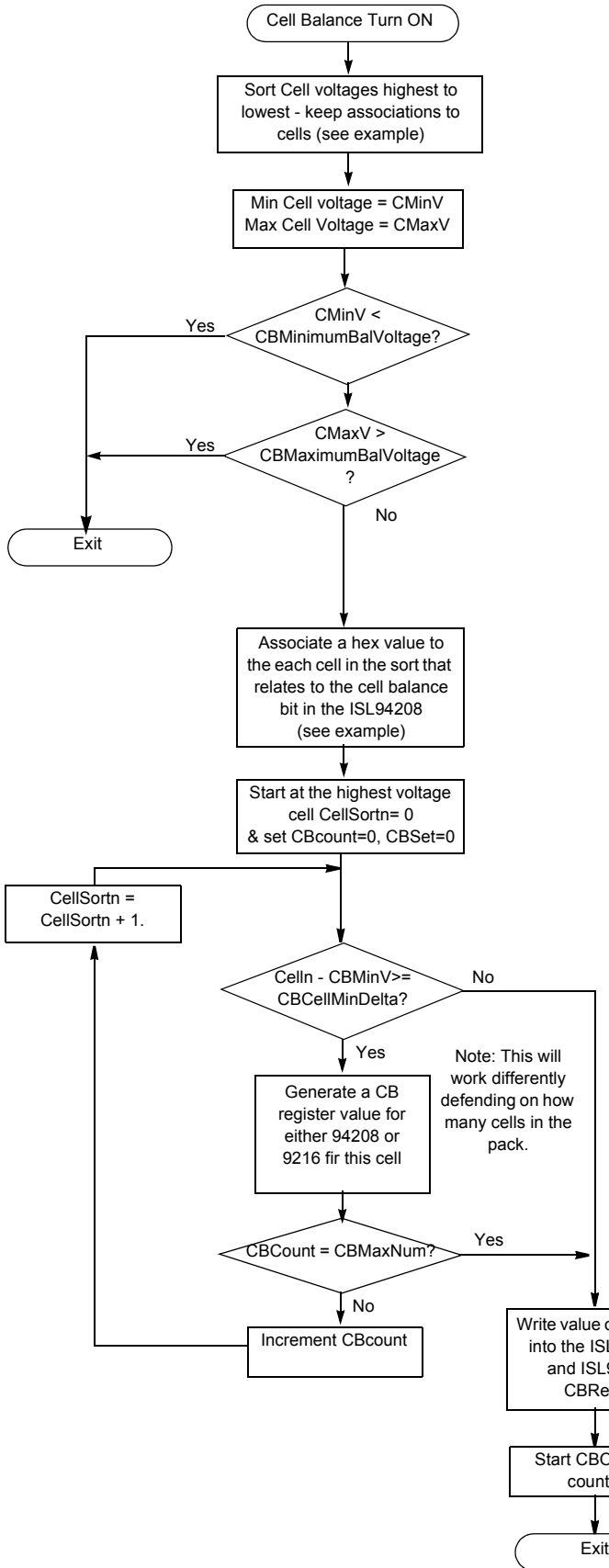

FIGURE 13. CELL BALANCING (CHECK CONDITIONS)



Example:

Cell6V: 3.73
 Cell5V: 3.72
 Cell4V: 3.75
 Cell3V: 3.71
 Cell2V: 3.70
 Cell1V: 3.74

Sort:

cellv[5]: 3.75	celln[5]: 4	CBreg: 10H
cellv[4]: 3.74	celln[4]: 1	CBreg: 11H
cellv[3]: 3.73	celln[3]: 6	CBreg: 51H
cellv[2]: 3.72	celln[2]: 5	CBreg: 71H
cellv[1]: 3.71	celln[1]: 3	CBreg: 79H
cellv[0]: 3.70	celln[0]: 2	CBreg: 7EH

CB control bits

CB6 = 40H
 CB5 = 20H
 CB4 = 10H
 CB3 = 08H
 CB2 = 04H
 CB1 = 02H

The CB value is built up as long as the difference between the cell voltage and the CMinV voltage is larger than the CBMinimumBalVoltage and the CBMaxNum of cells to be balanced has not been reached. In the example above, with a CBMinimumBalVoltage of 30mV, and a CBMaxNum of 4, only the first three cells will be balanced and a CB value of 51H would be written to the ISL94208.

FIGURE 14. CELL BALANCING (TURN CELL BALANCE ON)

	ISL94208 Cell Balance Reg	Cell Voltage Reg	Monitor Cells								
4 Cell pack	<table border="1"> <tr> <td>0</td><td>CB6</td><td>0</td><td>CB4</td><td>CB3</td><td>0</td><td>CB1</td><td>0</td> </tr> </table>	0	CB6	0	CB4	CB3	0	CB1	0	0 - 3	1, _, 3, 4, _, 6
0	CB6	0	CB4	CB3	0	CB1	0				
5 Cell pack	<table border="1"> <tr> <td>0</td><td>CB6</td><td>CB5</td><td>CB4</td><td>CB3</td><td>0</td><td>CB1</td><td>0</td> </tr> </table>	0	CB6	CB5	CB4	CB3	0	CB1	0	0 - 4	1, _, 3, 4, 5, 6
0	CB6	CB5	CB4	CB3	0	CB1	0				
6 Cell pack	<table border="1"> <tr> <td>0</td><td>CB6</td><td>CB5</td><td>CB4</td><td>CB3</td><td>CB2</td><td>CB1</td><td>0</td> </tr> </table>	0	CB6	CB5	CB4	CB3	CB2	CB1	0	0 - 5	1, 2, 3, 4, 5, 6
0	CB6	CB5	CB4	CB3	CB2	CB1	0				

FIGURE 15. CELL BALANCING (CELL MONITORING AND CB CONTROL)

Notice

1. Descriptions of circuits, software and other related information in this document are provided only to illustrate the operation of semiconductor products and application examples. You are fully responsible for the incorporation or any other use of the circuits, software, and information in the design of your product or system. Renesas Electronics disclaims any and all liability for any losses and damages incurred by you or third parties arising from the use of these circuits, software, or information.
2. Renesas Electronics hereby expressly disclaims any warranties against and liability for infringement or any other claims involving patents, copyrights, or other intellectual property rights of third parties, by or arising from the use of Renesas Electronics products or technical information described in this document, including but not limited to, the product data, drawings, charts, programs, algorithms, and application examples.
3. No license, express, implied or otherwise, is granted hereby under any patents, copyrights or other intellectual property rights of Renesas Electronics or others.
4. You shall not alter, modify, copy, or reverse engineer any Renesas Electronics product, whether in whole or in part. Renesas Electronics disclaims any and all liability for any losses or damages incurred by you or third parties arising from such alteration, modification, copying or reverse engineering.
5. Renesas Electronics products are classified according to the following two quality grades: "Standard" and "High Quality". The intended applications for each Renesas Electronics product depends on the product's quality grade, as indicated below.
"Standard": Computers; office equipment; communications equipment; test and measurement equipment; audio and visual equipment; home electronic appliances; machine tools; personal electronic equipment; industrial robots; etc.
"High Quality": Transportation equipment (automobiles, trains, ships, etc.); traffic control (traffic lights); large-scale communication equipment; key financial terminal systems; safety control equipment; etc.
Unless expressly designated as a high reliability product or a product for harsh environments in a Renesas Electronics data sheet or other Renesas Electronics document, Renesas Electronics products are not intended or authorized for use in products or systems that may pose a direct threat to human life or bodily injury (artificial life support devices or systems; surgical implantations; etc.), or may cause serious property damage (space system; undersea repeaters; nuclear power control systems; aircraft control systems; key plant systems; military equipment; etc.). Renesas Electronics disclaims any and all liability for any damages or losses incurred by you or any third parties arising from the use of any Renesas Electronics product that is inconsistent with any Renesas Electronics data sheet, user's manual or other Renesas Electronics document.
6. When using Renesas Electronics products, refer to the latest product information (data sheets, user's manuals, application notes, "General Notes for Handling and Using Semiconductor Devices" in the reliability handbook, etc.), and ensure that usage conditions are within the ranges specified by Renesas Electronics with respect to maximum ratings, operating power supply voltage range, heat dissipation characteristics, installation, etc. Renesas Electronics disclaims any and all liability for any malfunctions, failure or accident arising out of the use of Renesas Electronics products outside of such specified ranges.
7. Although Renesas Electronics endeavors to improve the quality and reliability of Renesas Electronics products, semiconductor products have specific characteristics, such as the occurrence of failure at a certain rate and malfunctions under certain use conditions. Unless designated as a high reliability product or a product for harsh environments in a Renesas Electronics data sheet or other Renesas Electronics document, Renesas Electronics products are not subject to radiation resistance design. You are responsible for implementing safety measures to guard against the possibility of bodily injury, injury or damage caused by fire, and/or danger to the public in the event of a failure or malfunction of Renesas Electronics products, such as safety design for hardware and software, including but not limited to redundancy, fire control and malfunction prevention, appropriate treatment for aging degradation or any other appropriate measures. Because the evaluation of microcomputer software alone is very difficult and impractical, you are responsible for evaluating the safety of the final products or systems manufactured by you.
8. Please contact a Renesas Electronics sales office for details as to environmental matters such as the environmental compatibility of each Renesas Electronics product. You are responsible for carefully and sufficiently investigating applicable laws and regulations that regulate the inclusion or use of controlled substances, including without limitation, the EU RoHS Directive, and using Renesas Electronics products in compliance with all these applicable laws and regulations. Renesas Electronics disclaims any and all liability for damages or losses occurring as a result of your noncompliance with applicable laws and regulations.
9. Renesas Electronics products and technologies shall not be used for or incorporated into any products or systems whose manufacture, use, or sale is prohibited under any applicable domestic or foreign laws or regulations. You shall comply with any applicable export control laws and regulations promulgated and administered by the governments of any countries asserting jurisdiction over the parties or transactions.
10. It is the responsibility of the buyer or distributor of Renesas Electronics products, or any other party who distributes, disposes of, or otherwise sells or transfers the product to a third party, to notify such third party in advance of the contents and conditions set forth in this document.
11. This document shall not be reprinted, reproduced or duplicated in any form, in whole or in part, without prior written consent of Renesas Electronics.
12. Please contact a Renesas Electronics sales office if you have any questions regarding the information contained in this document or Renesas Electronics products.
(Note 1) "Renesas Electronics" as used in this document means Renesas Electronics Corporation and also includes its directly or indirectly controlled subsidiaries.
(Note 2) "Renesas Electronics product(s)" means any product developed or manufactured by or for Renesas Electronics.

(Rev.4.0-1 November 2017)



SALES OFFICES

Renesas Electronics Corporation

<http://www.renesas.com>

Refer to "<http://www.renesas.com/>" for the latest and detailed information.

Renesas Electronics America Inc.
1001 Murphy Ranch Road, Milpitas, CA 95035, U.S.A.
Tel: +1-408-432-8888, Fax: +1-408-434-5351

Renesas Electronics Canada Limited
9251 Yonge Street, Suite 8309 Richmond Hill, Ontario Canada L4C 9T3
Tel: +1-905-237-2004

Renesas Electronics Europe Limited
Dukes Meadow, Millboard Road, Bourne End, Buckinghamshire, SL8 5FH, U.K.
Tel: +44-1628-651-700, Fax: +44-1628-651-804

Renesas Electronics Europe GmbH
Arcadiastrasse 10, 40472 Düsseldorf, Germany
Tel: +49-211-6503-0, Fax: +49-211-6503-1327

Renesas Electronics (China) Co., Ltd.
Room 1709 Quantum Plaza, No.27 ZhichunLu, Haidian District, Beijing, 100191 P. R. China
Tel: +86-10-8235-1155, Fax: +86-10-8235-7679

Renesas Electronics (Shanghai) Co., Ltd.
Unit 301, Tower A, Central Towers, 555 Langao Road, Putuo District, Shanghai, 200333 P. R. China
Tel: +86-21-2226-0888, Fax: +86-21-2226-0999

Renesas Electronics Hong Kong Limited
Unit 1601-1611, 16/F., Tower 2, Grand Century Place, 193 Prince Edward Road West, Mongkok, Kowloon, Hong Kong
Tel: +852-2265-6688, Fax: +852-2886-9022

Renesas Electronics Taiwan Co., Ltd.
13F, No. 363, Fu Shing North Road, Taipei 10543, Taiwan
Tel: +886-2-8175-9600, Fax: +886-2-8175-9670

Renesas Electronics Singapore Pte. Ltd.
80 Bendemeer Road, Unit #06-02 Hyflux Innovation Centre, Singapore 339949
Tel: +65-6213-0200, Fax: +65-6213-0300

Renesas Electronics Malaysia Sdn.Bhd.
Unit 1207, Block B, Menara Amcorp, Amcorp Trade Centre, No. 18, Jln Persiaran Barat, 46050 Petaling Jaya, Selangor Darul Ehsan, Malaysia
Tel: +60-3-7955-9390, Fax: +60-3-7955-9510

Renesas Electronics India Pvt. Ltd.
No.777C, 100 Feet Road, HAL 2nd Stage, Indiranagar, Bangalore 560 038, India
Tel: +91-80-67208700, Fax: +91-80-67208777

Renesas Electronics Korea Co., Ltd.
17F, KAMCO Yangjae Tower, 262, Gangnam-daero, Gangnam-gu, Seoul, 06265 Korea
Tel: +82-2-558-3737, Fax: +82-2-558-5338