

ZSSC3281

## Contents

<b>1. Kit Contents</b> .....	<b>8</b>
<b>2. Evaluation Kit Setup</b> .....	<b>8</b>
2.1 User Equipment.....	8
2.2 User Computer Requirements and Setup .....	8
2.2.1 Computer Requirements .....	8
2.2.2 Software Installation and Setup .....	8
2.3 Board Configuration and Connection .....	9
2.4 Kit Hardware Connections.....	10
2.5 Communication Interfaces.....	11
2.5.1 I2C.....	11
2.5.2 SPI.....	11
2.5.3 OWI .....	12
2.6 Power-Up Procedure .....	12
2.7 Bad Contact between the Socket and the IC .....	12
<b>3. GUI Top</b> .....	<b>13</b>
3.1 Menu Bar .....	13
3.1.1 File Menu.....	13
3.1.2 Settings Menu .....	14
3.1.3 Tools Menu.....	14
3.1.4 Help Menu .....	15
3.2 Connection.....	15
3.3 IC Status .....	16
3.4 I/O Functions .....	16
3.5 Write Memory and Reset IC .....	16
3.6 Active Boards.....	17
3.7 System Status Bar .....	17
<b>4. Main Tab</b> .....	<b>18</b>
<b>5. Configure Tab</b> .....	<b>18</b>
5.1 Power Supply and Oscillator .....	18
5.1.1 Power supply.....	19
5.1.2 Oscillator .....	19
5.2 Serial Interfaces Tab .....	20
5.2.1 I2C/I3C .....	20
5.2.2 SPI.....	21
5.2.3 OWI .....	21
5.3 AFE Tab.....	25
5.3.1 Sequencer .....	25
5.3.2 Temperature Selection.....	32
5.3.3 Bridge .....	35
5.3.4 Temperature.....	45
5.4 Third Logic Channel .....	56
5.4.1 Supported Mathematical Operations .....	57

5.5	Output Scaling .....	57
5.6	Output Preprocessing .....	60
5.7	DOUT .....	60
5.7.1	Output Type .....	61
5.7.2	GPIOs.....	61
5.7.3	FOUT - Frequency .....	61
5.7.4	Ocillator Trim Calibration.....	61
5.7.5	PWM - Mapping .....	62
5.7.6	PWM – Base Frequency .....	62
5.7.7	Output Stimulus.....	62
5.8	AOUT .....	63
5.8.1	Output Operation Mode.....	63
5.8.2	AOUT Pin Mapping .....	74
5.8.3	AOUT Output Stimulus.....	75
5.9	Filter.....	75
5.10	EOC/Alarm.....	76
5.10.1	EOC.....	77
5.10.2	Alarm.....	77
5.11	System Control .....	80
5.12	Customer ID.....	80
<b>6.</b>	<b>Measure .....</b>	<b>81</b>
6.1	Measure Options Selection .....	82
6.1.1	Output Type .....	82
6.1.2	Measure .....	83
6.1.3	Sensor As.....	83
6.1.4	Temperature As .....	84
6.2	Selection for Displaying .....	84
6.3	Save Measured Data to File .....	84
6.4	Save Screen Displayed Data to File.....	85
6.5	Graphs Area .....	85
<b>7.</b>	<b>Calibration .....</b>	<b>86</b>
7.1	Sensor Selection, Acquisition Type .....	86
7.2	Calibration Type Settings .....	87
7.2.1	Type .....	87
7.2.2	Curve.....	88
7.3	Temperature Range .....	88
7.4	Calibration Points.....	88
7.5	Calculate Coefficients, Coefficient Results and Set in GUI .....	89
7.6	Dual Speed Mode Calibration.....	90
<b>8.</b>	<b>Diagnostics.....</b>	<b>91</b>
8.1	General Tab.....	91
8.2	Sensor/AFE Tab .....	91
8.2.1	User Selectable Input Fields .....	91
8.2.2	Diagnostics Operation.....	93
8.2.3	AFE Diagnostic Status .....	93
8.3	AFE Diagnostic Operation Example.....	94
<b>9.</b>	<b>FW Update .....</b>	<b>95</b>

<b>10. Memory</b> .....	<b>97</b>
10.1 Overview.....	97
10.2 View Register.....	97
<b>11. Command Console</b> .....	<b>99</b>
11.1 Select Script and Execute .....	99
11.2 Type Single Command and Execute .....	99
11.3 Result Display.....	100
11.4 Clear Display .....	100
<b>12. Glossary</b> .....	<b>101</b>
<b>13. SW and FW Release References</b> .....	<b>101</b>
<b>14. Revision History</b> .....	<b>101</b>

## Figures

Figure 1. ZSSC3281 SSC Evaluation Kit – Overview .....	9
Figure 2. ZSSC3281 EVB – Overview.....	9
Figure 3. ZSSC3281 Evaluation Board V4 – Top View with default Jumpers in place .....	10
Figure 4. Sensor Replacement Board V3.1 .....	10
Figure 5. I2C Bus Jumpers .....	11
Figure 6. SPI Bus Jumpers.....	11
Figure 7. OWI Bus JumpersPower Supply Options.....	12
Figure 8. GUI Main .....	13
Figure 9. Top Menu .....	13
Figure 10. File Menu.....	13
Figure 11. Settings Menu.....	14
Figure 12. Settings Menu – Warnings .....	14
Figure 13. Tools Menu.....	14
Figure 14. Tools Menu – Open Logfile .....	14
Figure 15. Tools Menu – Command Console.....	15
Figure 16. Help Menu .....	15
Figure 17. Connection .....	15
Figure 18. IC Status.....	16
Figure 19. I/O Functions .....	16
Figure 20. Active Boards .....	17
Figure 21. Active Boards – Info .....	17
Figure 22. System Status Bar.....	17
Figure 23. Block Diagram on Main Tab.....	18
Figure 24. Power Supply and Oscillator .....	18
Figure 25. Power Supply Selection .....	19
Figure 26. Oscillator Menu.....	19
Figure 27. Clock Output Mode.....	19
Figure 28. Serial Interfaces.....	20
Figure 29. Serial Interfaces - I2C/I3C .....	20
Figure 30. Configure – Serial Interfaces – SPI.....	21
Figure 31. Serial Interfaces - OWI .....	21
Figure 32. OWI Window.....	22
Figure 33. OWI Window Selection.....	22

Figure 34. OWI Digital .....	23
Figure 35. OWI Analog Voltage Mode 5V VOUT .....	23
Figure 36. OWI Analog Voltage Mode 10V VOUT .....	24
Figure 37. OWI over Analog Current Loop 2-Wire .....	24
Figure 38. Configuration for Communication OWI over 2WCL .....	24
Figure 39. Connecting with OWI over 2WCL.....	25
Figure 40. AFE Selection and Configurability .....	25
Figure 41. Dual Speed Resistive Bridge Input Configuration .....	26
Figure 42. Sequencer Error Message .....	26
Figure 43. Sequencer Main Mode .....	26
Figure 44. SM+/SM- Exchange .....	26
Figure 45. Auto-Zero Sensor Measurement .....	27
Figure 46. Accelerated Measurements.....	27
Figure 47. Advanced Options .....	27
Figure 48. Advanced Options – Aux Slots .....	28
Figure 49. Main Mode Set to Deterministic Sensor Step Response – SM/AUX .....	28
Figure 50. Auxiliary Measurements .....	28
Figure 51. Auxiliary Measurements Enabled Displayed in GUI.....	29
Figure 52. Sequencer – Idle Time .....	29
Figure 53. Accelerated Main Measurement: SM Combinations .....	29
Figure 54. Auxiliary Insertion Rate .....	30
Figure 55. Auxiliary Insertion Rate: SM+AUX_AZ after the Eights Measurement .....	30
Figure 56. Sequence Execution .....	31
Figure 57. Sequence Execution Example .....	31
Figure 58. Dual Speed Settings.....	32
Figure 59. Temperature Selection Overview .....	32
Figure 60. Temperature Selection – Dual Speed .....	33
Figure 61. Acquired Data Stream Overview .....	33
Figure 62. AFE Status .....	34
Figure 63. Temperature Sensor Activation.....	34
Figure 64. Sensor to Channel Assignment.....	35
Figure 65. Voltage Mode .....	36
Figure 66. Resistor Mode .....	37
Figure 67. Current Mode.....	38
Figure 68. Thermopile Mode.....	39
Figure 69. Configure Register.....	39
Figure 70. Meas Config Menu .....	39
Figure 71. Meas Config: Single .....	40
Figure 72. Meas Config: Single AZ.....	40
Figure 73. Bridge – Sensor Values.....	40
Figure 74. Bridge – Parameters.....	41
Figure 75. Mode Voltage Schematic .....	41
Figure 76. Internals Example.....	42
Figure 77. Internals Out of Range .....	42
Figure 78. Schematic and Graphs Selection .....	43
Figure 79. Combined Graphs .....	43
Figure 80. Dual Speed Mode for Bridge 1 .....	44
Figure 81. Dual Speed Mode for Bridge 2 .....	45

---

Figure 82. Temp – Mode Sink Internal Bias .....	46
Figure 83. Temp – Mode Source Internal Bias .....	47
Figure 84. Mode Source External Bias Low .....	48
Figure 85. Mode Source External Bias High .....	49
Figure 86. External RH, RL.....	49
Figure 87. Mode Bridge Internal Bias .....	50
Figure 88. Mode Bridge External Bias .....	51
Figure 89. Mode Bridge Differential .....	52
Figure 90. Configure Register.....	52
Figure 91. Copy to Temp .....	52
Figure 92. Temp– Sensor Values .....	53
Figure 93. Parameters .....	53
Figure 94. Temp – Schematic.....	54
Figure 95. Internals.....	54
Figure 96. Internals Out of Range .....	55
Figure 97. Schematic and Graphs Selection .....	55
Figure 98. Combined Graphs .....	55
Figure 99. Pt1000 Measurements .....	56
Figure 100. Third Logic Channel Operations.....	56
Figure 101. Third Logic Channel – Channel Order .....	56
Figure 102. Output Scaling .....	57
Figure 103. Back to Defaults .....	58
Figure 104. 50% to 100% Output .....	58
Figure 105. Coefficients for 0% to 100% Output .....	59
Figure 106. 0% to 100% Output .....	59
Figure 107. Output Pre-Processing Defaults .....	60
Figure 108. Clipping Limits .....	60
Figure 109. DOUT .....	60
Figure 110. Configure – DOUT – Output Type.....	61
Figure 111. DOUT - GPIOs .....	61
Figure 112. Configure – DOUT – Frequency Range .....	61
<b>Figure 113. Oscillator Trim Calibration .....</b>	<b>61</b>
Figure 114. Configure – PWM– Mapping .....	62
Figure 115. Configure – PWM – Base Frequency.....	62
Figure 116. Configure – DOUT- Direct Setting.....	62
Figure 117. AOUT mapping.....	63
Figure 118. AOUT – Operation Mode.....	63
Figure 119. AOUT Power Supply .....	63
Figure 120. Absolute Voltage 0V-10V - Jumpers .....	64
Figure 121. AOUT — Measure.....	64
Figure 122. Absolute Voltage 0V - 10V Configuration.....	65
Figure 123. Absolute Voltage 0V-5V - Jumpers .....	65
Figure 124. Absolute Voltage 0V-5V Configuration.....	66
Figure 125. Absolute Voltage 0V-1V - Jumpers .....	67
Figure 126. Absolute Voltage 0V to 1V Configuration .....	67
Figure 127. Ratiometric Voltage Jumpers .....	68
Figure 128. Ratiometric Voltage Configuration.....	68
Figure 129. 2-Wire Current Loop Jumpers .....	69

Figure 130. 2-Wire Current Loop SRBV3 Specific Configuration.....	69
Figure 131. 2-Wire Current Loop Single AFE Active.....	70
Figure 132. 2-Wire Current Loop Power Supply and Oscillator.....	70
Figure 133. Default Calibration Coefficients.....	70
Figure 134. 2-Wire Current Loop Calibration.....	71
Figure 135. 2-Wire Current Loop Calibration Measured Coefficients.....	72
Figure 136. 3-Wire-Current-Loop Jumper Setting.....	73
Figure 137. 3-Wire Current Loop Calibration.....	73
Figure 138. 3-Wire Current Loop calibration Measured Coefficients.....	74
Figure 139. AOUT Pin Mapping.....	74
Figure 140. AOUT Direct Setting.....	75
Figure 141. Filter Tab.....	75
Figure 142. Filter Time Constant Setting.....	75
Figure 143. Filter Response (Digital Domain).....	76
Figure 144. EOC/Alarm Signals.....	76
Figure 145. EOC Polarity.....	77
Figure 146. EOC Generation.....	77
Figure 147. Alarm Configuration Options.....	78
Figure 148. Alarm Threshold Mode, Range and Hysteresis.....	79
Figure 149. System Control.....	80
Figure 150. Advanced Error Response Messages.....	80
Figure 151. Customer ID.....	80
Figure 152. Measure Tab.....	81
Figure 153. Resolution from Device to GUI.....	81
Figure 154. Measure Selection.....	82
Figure 155. Output Type.....	82
Figure 156. Analog AOUT Read-back.....	82
Figure 157. Measure.....	83
Figure 158. Measurement Acquisition.....	83
Figure 159. Sensor As.....	83
Figure 160. Temperature As.....	84
Figure 161. Display Selection.....	84
Figure 162. Save Measured Data.....	84
Figure 163. Selected Display Resolution.....	84
Figure 164. Save Screen Displayed Data.....	85
Figure 165. Graphs Area.....	85
Figure 166. Calibration Tab.....	86
Figure 167. Sensor, Acquisition.....	86
Figure 168. Acquisition Type.....	86
Figure 169. Calibration Type.....	87
Figure 170. Curve.....	88
Figure 171. Temperature Range and Sample Settings.....	88
Figure 172. Calibration Points Input.....	88
Figure 173. Calculate Coefficients, Set in GUI.....	89
Figure 174. Coefficient Result.....	89
Figure 175. Dual Speed Channel Calibration.....	90
Figure 176. Dual Speed Channel Calibration – New Coefficients Ready.....	90
Figure 177. Diagnostic State Signalization Enable.....	91

Figure 178. Diagnostic Tab.....	91
Figure 179. Cbr and Cts Capacitors .....	92
Figure 180. UDR/LDR Selection.....	92
Figure 181. Input for AFE Gain Check .....	92
Figure 182. AFE Reference Gain .....	93
Figure 183. AFE Gain Tolerance.....	93
Figure 184. AFE Offset Reference and Tolerance .....	93
Figure 185. Diagnostic Check and Reset .....	93
Figure 186. AFE Diagnostic Status .....	93
Figure 187. Activation of Diagnostic Check.....	94
Figure 188. Diagnostic Check Pass .....	94
Figure 189. Diagnostic Check Fail.....	94
Figure 190. IC Status Sensor Connection Fail .....	94
Figure 191. FW Update Tab .....	95
Figure 192. FW update file not valid .....	95
Figure 193. Valid FW update file identified.....	95
Figure 194. FW Update Operation .....	96
Figure 195. FW Update Finished.....	96
Figure 196. Memory Overview .....	97
Figure 197. Register .....	97
Figure 198. Memory – View Register .....	97
Figure 199. Register Content .....	98
Figure 200. Changes not Written to NVM.....	98
Figure 201. Modified Bits in a Register –Changes not Written to NVM .....	99
Figure 202. Script Execution.....	99
Figure 203. Single Command execution .....	99
Figure 204. Command Execution Result.....	100
Figure 205. Clear Display .....	100

## 1. Kit Contents

Find the KIT on [www.renesas.com/ZSSC3281KIT](http://www.renesas.com/ZSSC3281KIT)

- ZSSC3281 Evaluation Board – ZSSC328XEVB
- SSC Communication Board - SSCCOMMBOARDV4P1C
- SRB Sensor Replacement Board - SSCSRBV3
- ZSSC3281 40-PQFN – 5 pcs
- USB cable

## 2. Evaluation Kit Setup

### 2.1 User Equipment

A Windows®-based computer is required for interfacing with the kit and configuring the ZSSC3281.

### 2.2 User Computer Requirements and Setup

#### 2.2.1 Computer Requirements

**Note:** The user must have administrative rights on the computer to download and install the ZSSC3281 Evaluation Software for the kit.

The computer must meet the following requirements:

- Windows® 7, 8, 8.1, 10
- Microsoft® .NET Framework 4.0 or higher
- Supported architecture: x86 and x64
- USB port
- Internet access to download the install setup

#### 2.2.2 Software Installation and Setup

The latest version of ZSSC3281 Evaluation Software, which is required for the kit, is available for download from the Renesas website.

**Note:** FTDI USB drivers are needed only for backwards compatibility with older Renesas communication hardware. If these drivers are not already installed on the user's computer, the software automatically installs the correct drivers after user confirmation.

Follow these procedures to install the Evaluation Kit Software on the user's computer:

1. Downloading and extract the contents of the zip file to the user's computer.
2. Double click on the extracted ZSSC328x Application Setup.exe file.  
Follow the resulting standard installation instructions displayed on the screen, changing the installation path if needed.  
If the default path setting is used, the software automatically completes the installation and creates an access link on the user's computer under Start > All Programs > Renesas>ZSSC328x Application> ZSSC328x Application.  
The installation dialog offers the option to create a desktop short-cut icon for the software if selected.
3. Connect the kit hardware as described in section 2.3.
4. Start the software program.



## 2.3 Board Configuration and Connection

Sections 2.4 to 0 describe information about features of the evaluation kit HW.



Figure 1. ZSSC3281 SSC Evaluation Kit – Overview

For a complete description of the SSC Communication Board V4.1 (CB), refer to the relevant datasheet available at the following link:

<https://www.renesas.com/eu/en/products/sensor-products/sensor-signal-conditioners-ssc-afe/ssc-cb-ssc-communication-board> .

Ensure to have the CB with Firmware revision 4.20.4 (see Figure 20) or greater, to have all the GUI functionalities operational. The CB Firmware update package is available at the following link:

<https://www.renesas.com/eu/en/products/sensor-products/sensor-signal-conditioners-ssc-afe/ssc-cb-ssc-communication-board>

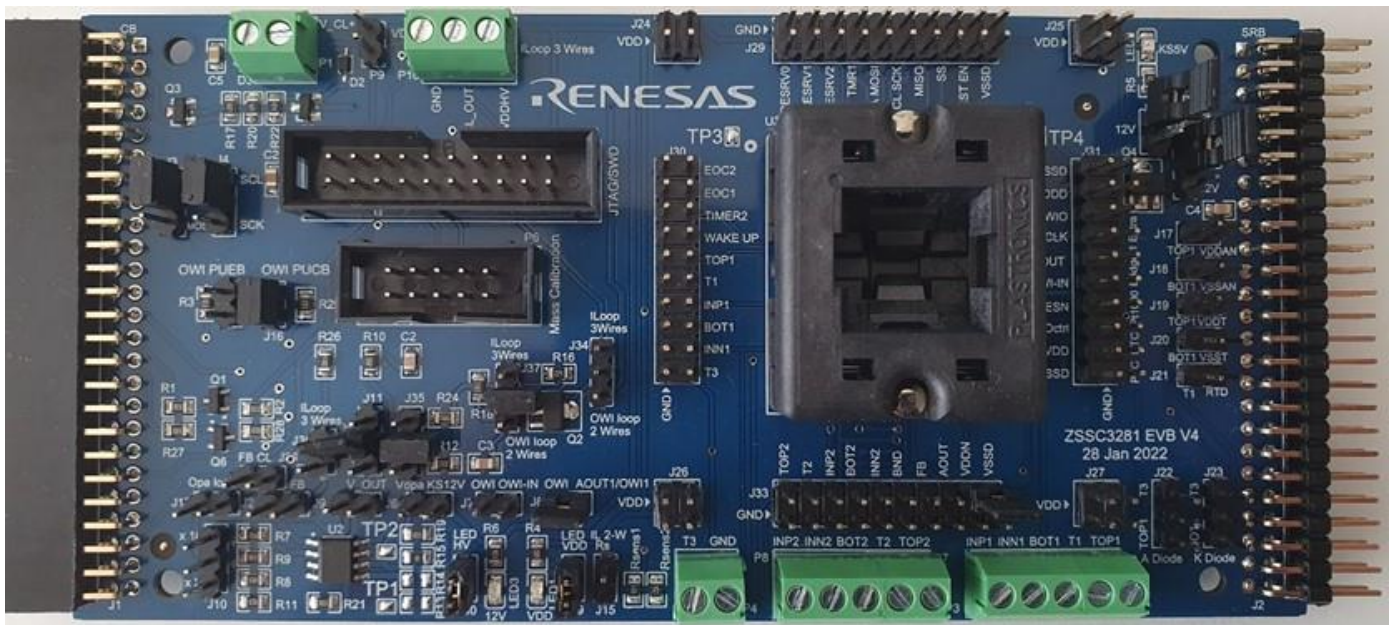

Figure 2. ZSSC3281 EVB – Overview

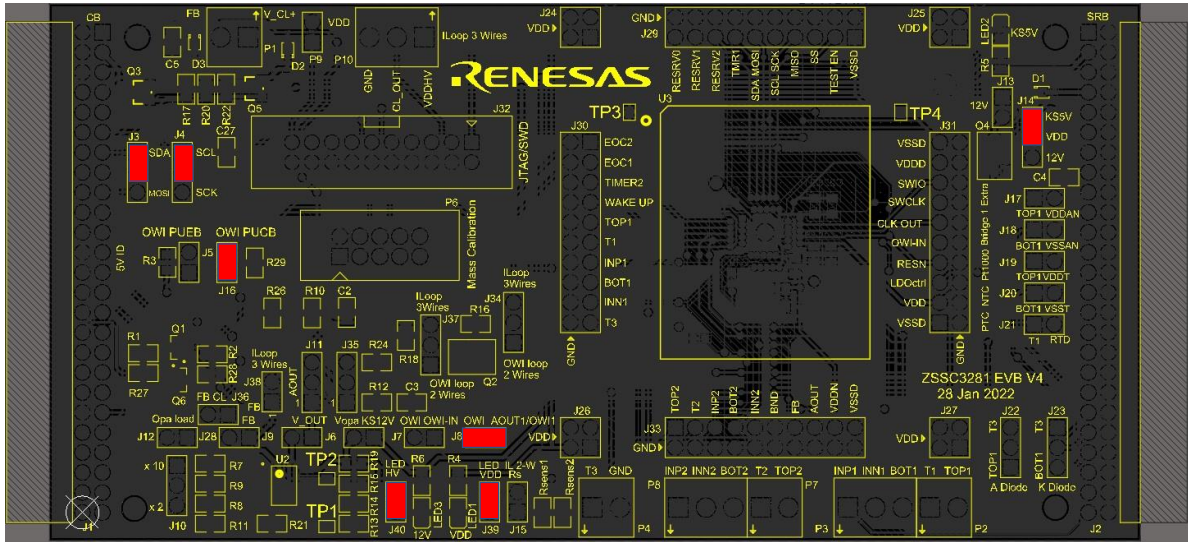

Figure 3. ZSSC3281 Evaluation Board V4 – Top View with default Jumpers in place

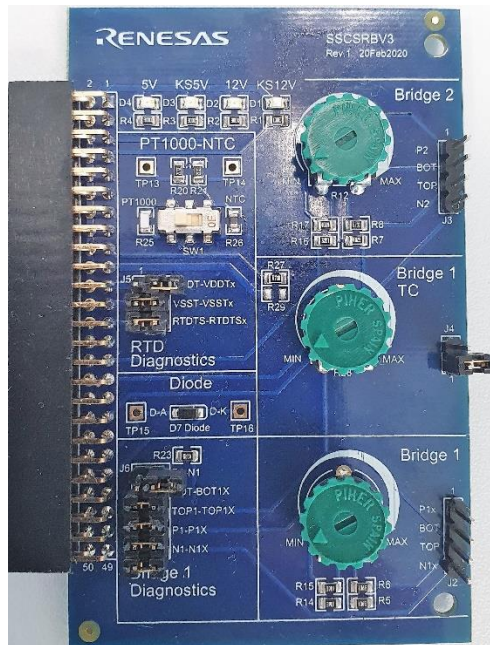

Figure 4. Sensor Replacement Board V3.1

## 2.4 Kit Hardware Connections

Follow these steps to assemble the three PCBs as shown in Figure 1 to start-up of the kit with default settings:

1. Connect the ZSSC3281 Evaluation Board (J1) to the SSC CB V4.1 (K6).
2. Connect the ZSSC3281 Evaluation Board (J2) to the Sensor Replacement Board V3.1.
3. Replace the dummy IC in the socket with a ZSSC3281 device under test (DUT). Take care to place the pin 1 as shown on Figure 3 (dot on the silkscreen close to TP3).  
Default jumpers positions on EVB and SRB are visible in Figure 3 (J3-J4 -J14-J39-J40) and Figure 4 (J5-J6-SW1) respectively.  
Use an ESD safe vacuum suction pen for correct handling of the ICs. The smallest suction cup is best suited for the ZSSC3281 samples.

The Evaluation kit is designed for operation at room temperature; use of the EVK in a thermal chamber may cause damage to the boards.

## 2.5 Communication Interfaces

The ZSSC3281 device supports SPI, I2C, and OWI as communication interfaces. The Evaluation Board supports all three of them, while only one can be active at a time. Sections 3.1.2 and 3.2 provide details about the corresponding Graphical User Interface (GUI) settings.

The ZSSC3281 Evaluation Board is using the SSC CB to translate these interfaces to USB. Only one SSC CB can be connected to the user's computer to operate GUI normally.

### 2.5.1 I2C

JP3 and JP4: short between pins 1 and 2 to use I2C.

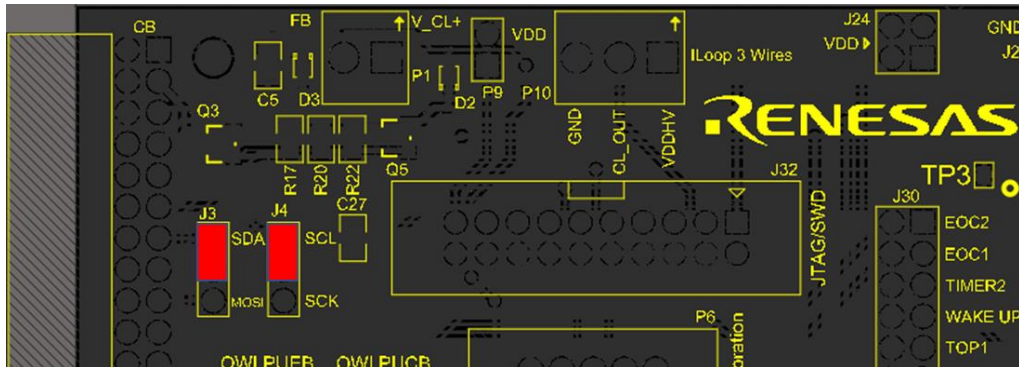

Figure 5. I2C Bus Jumpers

### 2.5.2 SPI

JP3 and JP4: short between pins 2 and 3 to use SPI.

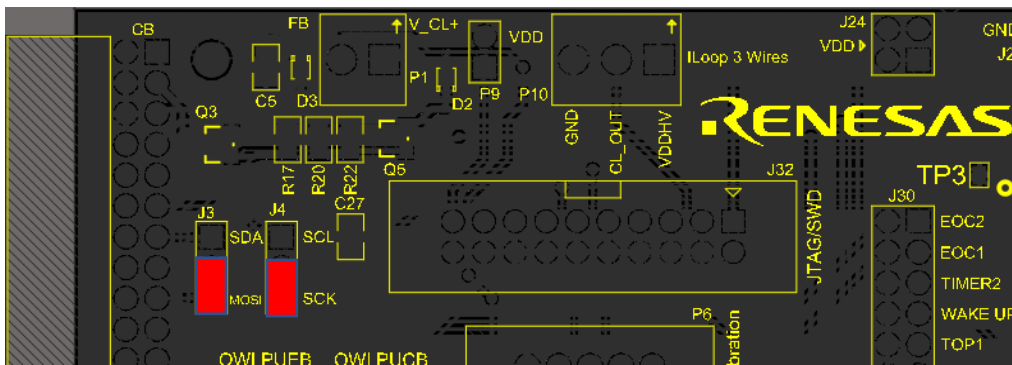

Figure 6. SPI Bus Jumpers

### 2.5.3 OWI

J8 and J16: short to use OWI.

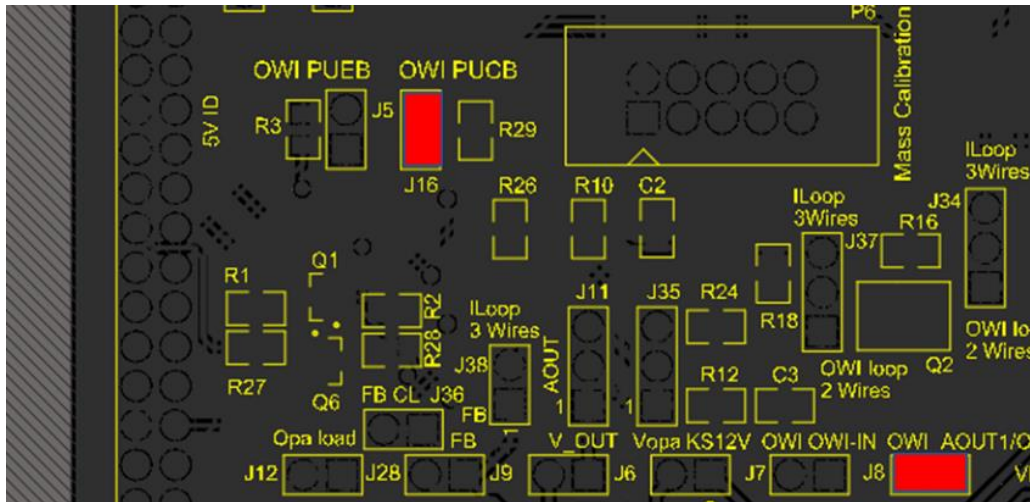

Figure 7. OWI Bus Jumpers Power Supply Options

ZSSC3281 has the following power supply options:

- 5V provided by the CB: J14 1-2 shorted (default)
- 12V is provided by the CB, regulated by the MOS and controlled by the LDOctrl line from the ZSSC3281: J13 short, J14 2-3 shorted.  
**Note:** for this option relevant NVM configuration must be in place, otherwise damage may occur to the ZSSC3281 and/or the EBV. Refer to section 5.1.1.

## 2.6 Power-Up Procedure

The ZSSC3281 Evaluation Software is intended for demonstration purposes and calibration of single units. Upon request, Renesas provides the user with algorithms and assistance in developing their full production calibration software.

Follow these steps for powering up the EVB by the CB:

1. Connect the kit as described in Figure 1 and connect the USB cable to the host PC
2. Launch the GUI.
3. Select one of the three serial buses options.
4. Click "Connect": the CB will power up the EVB.

**IMPORTANT NOTE:** The configuration of the ZSSC3281 must be performed through the GUI. Manual modification of the configuration file (see section 3.1.1) not followed by a consistency check of the configuration performed through the GUI, may lead to unhandled device status.

Consistency check: The GUI, at connection to the device, reads the memory of the device and automatically assess if its configuration is consistent with the expected ones.

## 2.7 Bad Contact between the Socket and the IC

If the GUI shows unstable output signal, there is most probably a bad contact between the QFN socket and the IC, especially when the IC is used for a long time. The oxidation on the QFN pads and on the socket pins are the most probable problem which can be mitigated by either cleaning the contacts of the socket, or removing and installing the IC again.

### 3. GUI Top

The main screen of the GUI is shown in Figure 8.

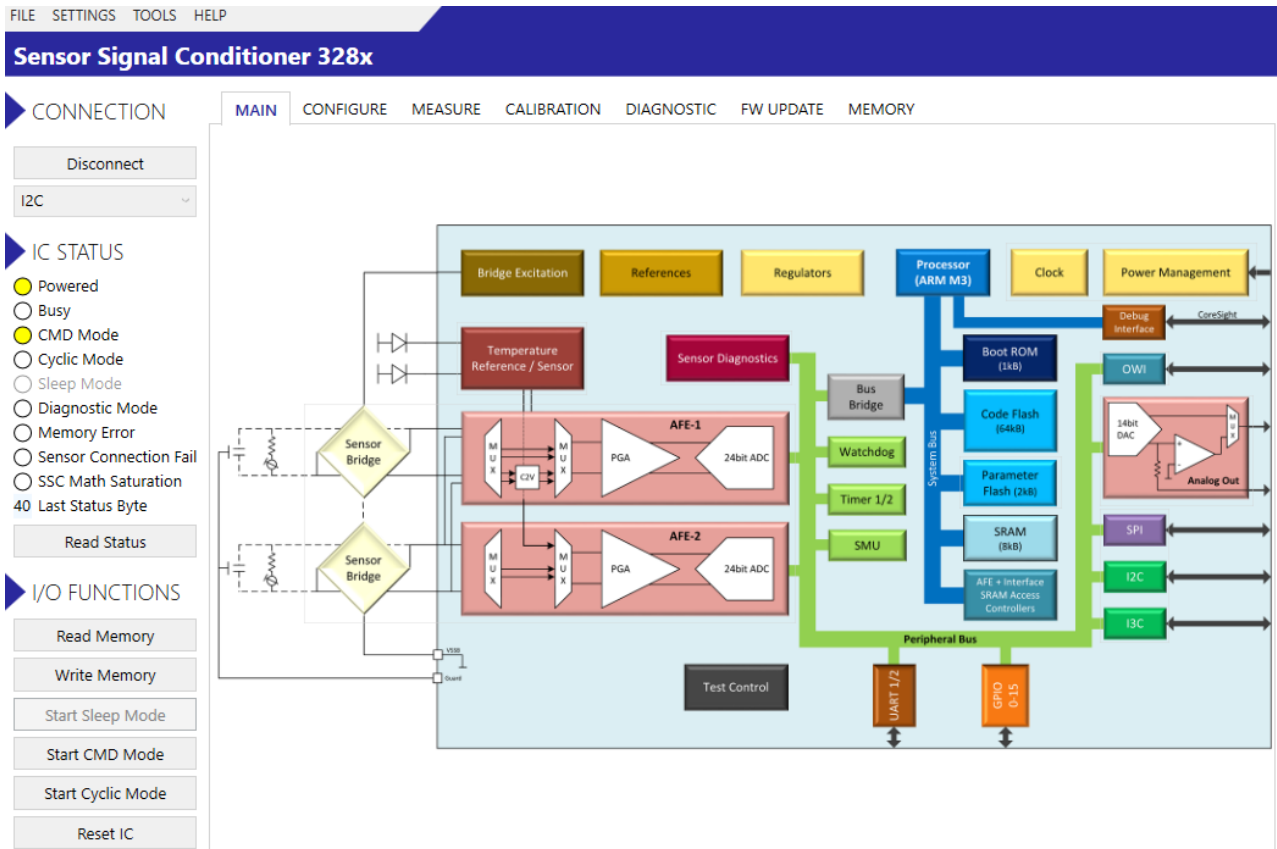

Figure 8. GUI Main

#### 3.1 Menu Bar

The Menu bar (see Figure 9) provides access to files operation, serial bus settings, the CB log file, and software versioning information.

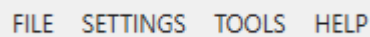

Figure 9. Top Menu

##### 3.1.1 File Menu

File menu (see Figure 10) allows to load, save, or save the GUI configuration with a different name. It also provides the functionality to save the device configuration NVM to a file or to load an NVM configuration to a device from an already existing file.

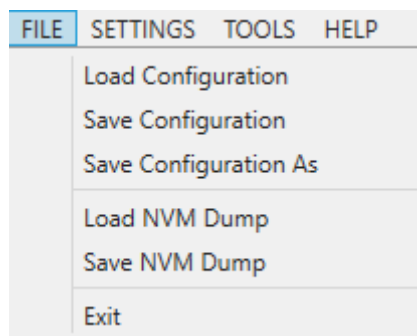

Figure 10. File Menu

### 3.1.2 Settings Menu

Settings menu (see Figure 11) allows configuring the following parameters relevant to the digital serial buses:

- I2C: device address, and SCL frequency
- SPI: SCK frequency, Slave Select polarity, SCK polarity and phase
- OWI:
  - Address
  - Window (first or second)
  - Frequency of bus
  - Frequency of bus for in case of OWI over-current loop

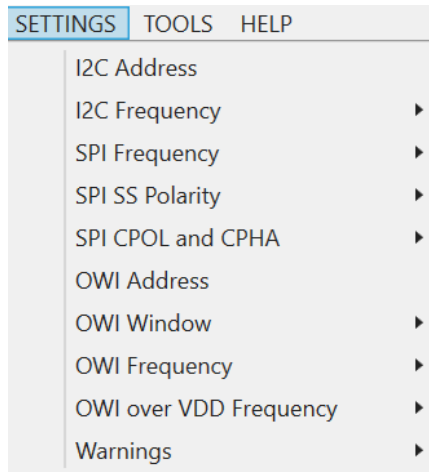

Figure 11. Settings Menu

The Settings menu allows the user to enable or disable GUI warning messages (see Figure 12).

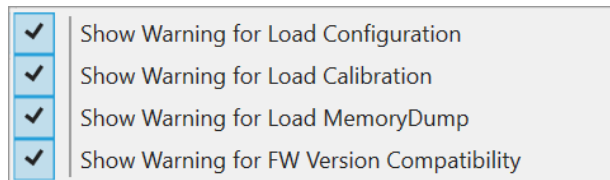

Figure 12. Settings Menu – Warnings

### 3.1.3 Tools Menu

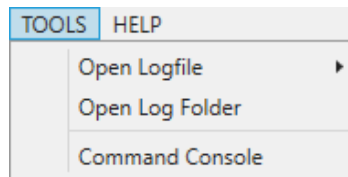

Figure 13. Tools Menu

The Tools menu (see Figure 13) provides the following options:

- Open Logfile: the available Error, Communication, or Calibration log files can be opened for here (see Figure 14).

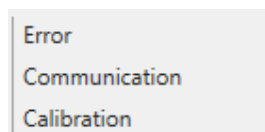

Figure 14. Tools Menu – Open Logfile

- Open Log Folder
- Command Console: the command console can be launched in here (see Figure 15), for detailed description of the available options see section 11.

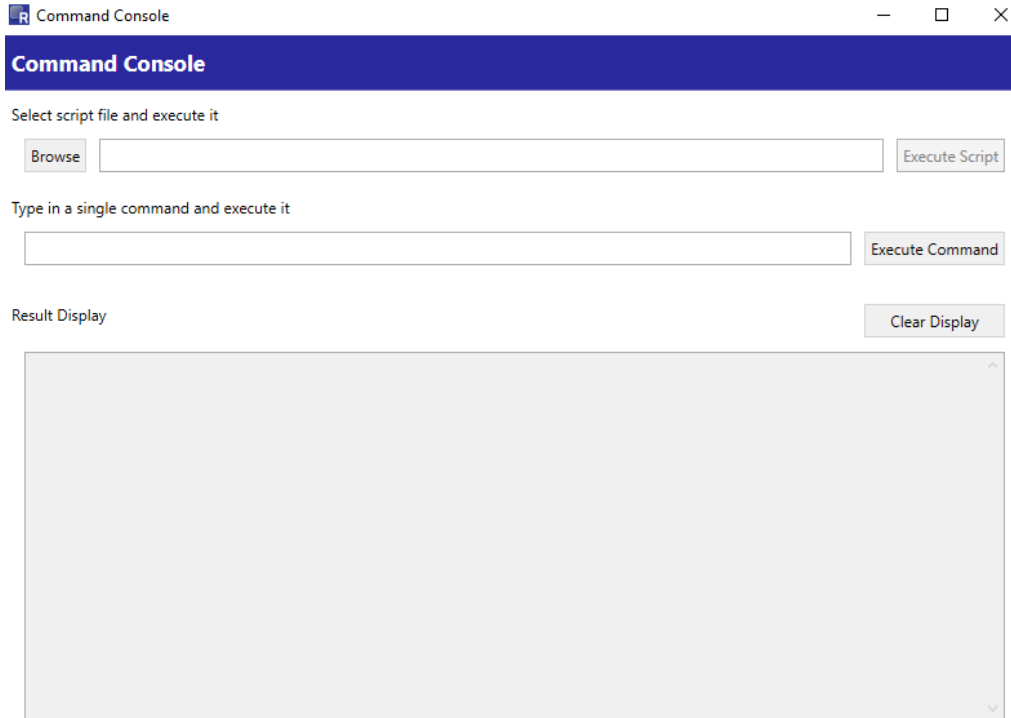

Figure 15. Tools Menu – Command Console

### 3.1.4 Help Menu

The Help menu (see Figure 16) has relevant information of the GUI. The ‘About’ option displays the GUI version, the USB driver version, and the Communication Board firmware version.

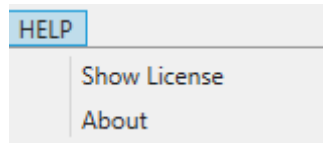

Figure 16. Help Menu

## 3.2 Connection

The connection area (Figure 17) allows the user to establish communication between the GUI, the Communication board, and the ZSSC3281 EVB.

Select the type of digital serial bus from a list of options (see Figure 17). For the serial buses requiring a device address, ensure that the same one is set in the device through the GUI, see section 3.1.2 for details.

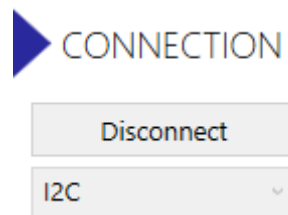

Figure 17. Connection

### 3.3 IC Status

The device status byte is described in the *ZSSC3281 Datasheet* document. When connection to the device is operational, the applicable status information is highlighted with the yellow status button (see Figure 18).

Pressing the “Read Status” button (see Figure 18) the most recent status byte is retrieved and the value (Hexadecimal) is displayed above the button. Refer to the *ZSSC3281 Datasheet* document for full information on the Status Byte.

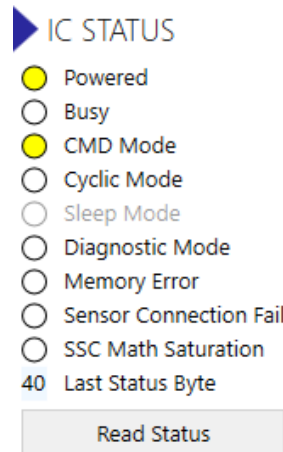

Figure 18. IC Status

### 3.4 I/O Functions

The I/O Function area (Figure 19) allows, through a set of pushbuttons, to perform the most basic functions with the ZSSC3281: read and write memory, enter in Command or Cyclic Mode, or Reset IC (HW line from CB connected to the reset pin of the IC).

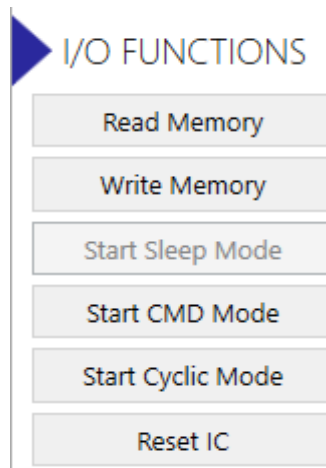

Figure 19. I/O Functions

### 3.5 Write Memory and Reset IC

The Write Memory button allows to write the device memory with updated values by performing an IC memory update and immediately resetting the device. All NVM memory changes are at this point fully operational. A separate IC reset is available through the Reset IC button.



### 3.6 Active Boards

This area (Figure 20) displays information about the boards currently connected to the host PC.

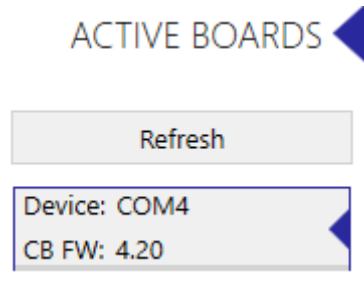

Figure 20. Active Boards

Tooltip information is available for the devices in the information area (Figure 20). Additional details are available to the user (Figure 21).



Figure 21. Active Boards – Info

### 3.7 System Status Bar

The system status bar is located in the bottom part of the GUI and is visible from any tab. It displays a set of information relevant to the EVB and the ZSSC3281 (see Figure 22).

Interface: I2C, Speed: 100 kHz, Address: 0x3C FW: 1.4.0 System Clock: 16 MHz Memory Sync ●

Figure 22. System Status Bar

The following information is provided to the user in the system status bar:

- Digital bus currently in use
- Bus clock speed
- Device address (when applicable)
- FW version in the ZSSC3281
- ZSSC3281 system clock frequency
- Status on NVM (Memory Sync)
- Green status button: NVM and GUI are synchronized, then mean the memory are equal

## 4. Main Tab

The Main tab provides a block diagram overview of the device functionalities (see Figure 23). Hovering on the block diagram highlights active areas; clicking on selected items opens the relevant configuration tab.

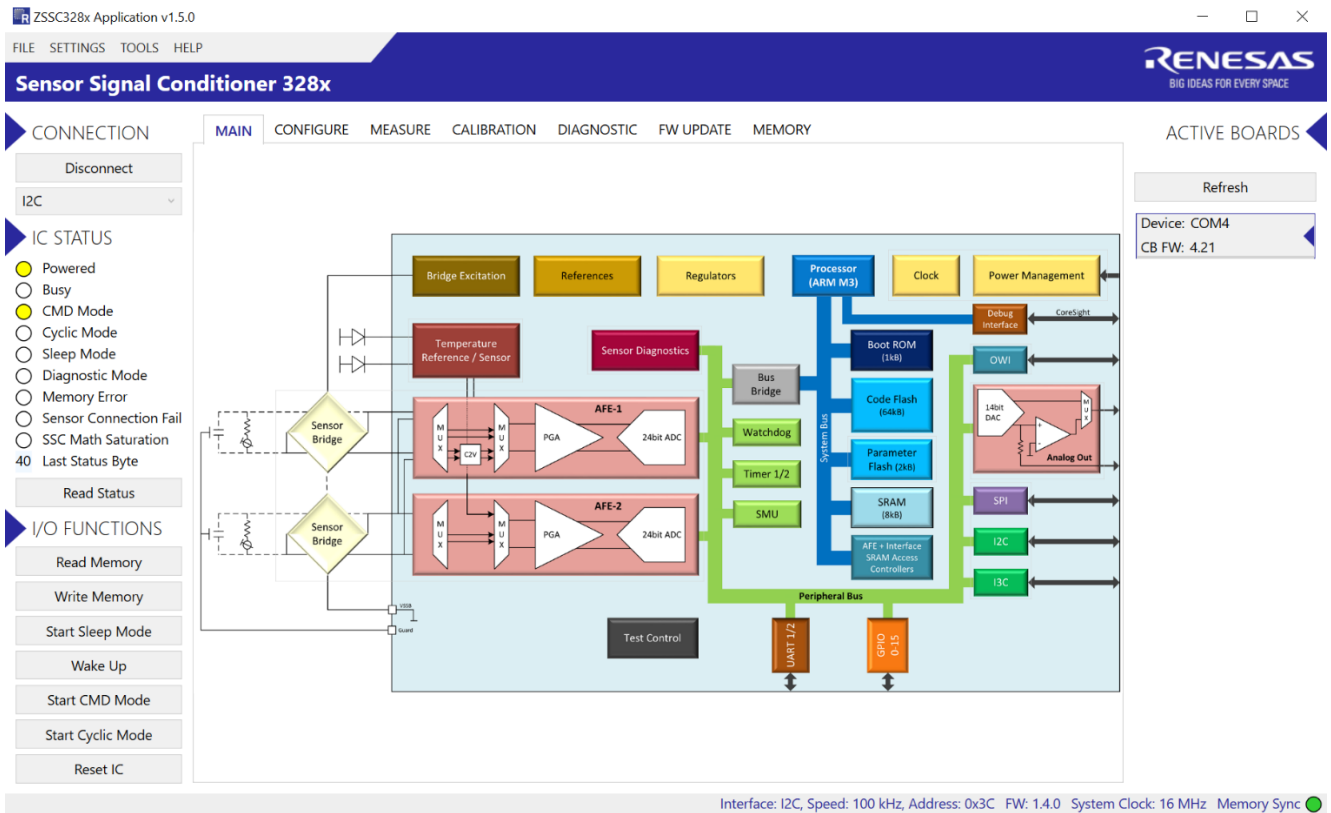

Figure 23. Block Diagram on Main Tab

## 5. Configure Tab

### 5.1 Power Supply and Oscillator

This tab (Figure 24) allows the configuration of the power supply rail of the ZSSC3281, the clock in configurations and the output clock that is available on the GPIO14 (pin 26).

#### Power Supply

Supply Mode	Pre-regulated VDD Supply	Requires different jumper settings
Regulated VDD	5.25V	

#### Oscillator

System Clock Source	Internal Clock
System Clock Source Divider	div1
Clock Output Mode	Inactive

Figure 24. Power Supply and Oscillator

### 5.1.1 Power supply

The power supply selection (Figure 25) allows to configure the following options:

- Supply Mode
- Regulated VDD

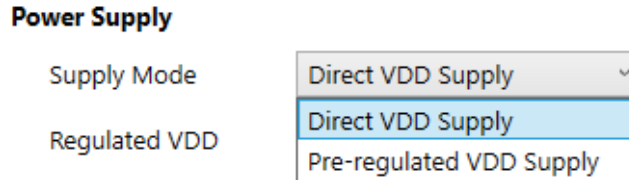

Figure 25. Power Supply Selection

'Direct VDD Supply' option makes the device ready to be supplied directly from the 5V rail provided by the CB. The 'Pre-regulated VDD Supply' option uses a 12V rail from the CB, stepped down by the EVB on board JFET controlled by the ZSSC3281 itself. For EVB power supply jumper settings see section 0.

### 5.1.2 Oscillator

The oscillator selection (Figure 26) allows to configure the following options:

- System Clock Source
- External Clock Type
- System Clock Source Divider
- Clock Output Mode
- Stabilization Wait Time

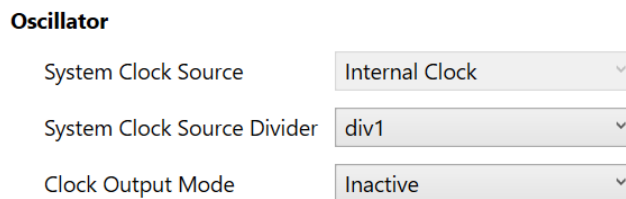

Figure 26. Oscillator Menu

- System Clock Source

The options selectable are Internal Clock or External Clock.

When Internal Clock is selected the Clock Output Mode option becomes selectable, and the Clock Output Mode (available on pin GPIO14, refer to the ZSSC3281 datasheet for more details) can be selected according to the values displayed in Figure 27:

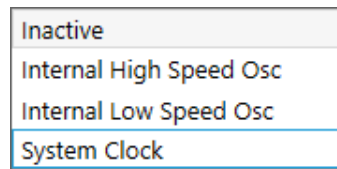

Figure 27. Clock Output Mode

- System Clock Source Divider

When selecting any value different from “div1” for the ‘System Clock Source Divider’, the actual system clock for the device ARM core is divided accordingly from the 16MHz internal clock source.

The ‘System Clock Source Divider’ options applies only when ‘System Clock’ value is selected for the ‘Clock Output Mode’.

## 5.2 Serial Interfaces Tab

This tab (see Figure 28) allows to configure the three serial buses available for communication with the ZSSC3281. The settings selected in this tab need to match the selections made through the options available in section 3.1.2.

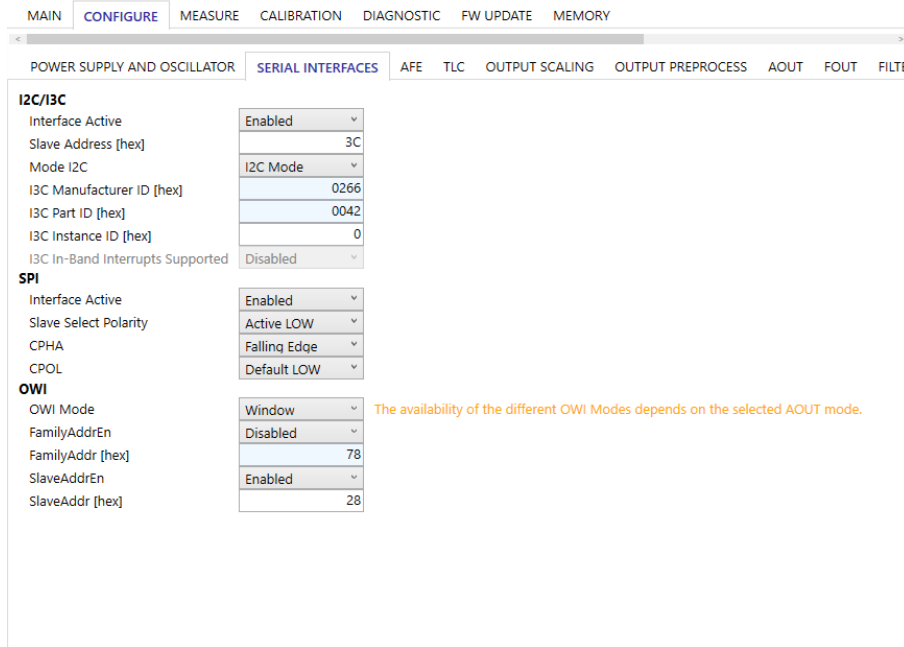

Figure 28. Serial Interfaces

### 5.2.1 I2C/I3C

The I2C/I3C selection (Figure 29) allows to configure the following options for the serial bus:

- Interface Active: enables or disables the bus interface
- Slave Address [hex]: user configurable slave address (Default: 0x3C)
- Mode I2C:
  - I2C default mode: all I3C functionality disabled
  - I3C: only partially supported by the EVK (limited speed, no I3C 3C in-band interrupts)
- I3C Manufacturer ID [hex]: read only – Renesas reserved
- I3C Part ID [hex]: read only - Renesas reserved
- I3C Instance ID [hex]: identifies the device
- I3C In-Band Interrupts Supported: for I3C only, not supported by the EVK

When the field “Interface Active” is “Enabled” the serial communication through the I2/3C bus is possible, see sections 2.5 and 3.1.2.

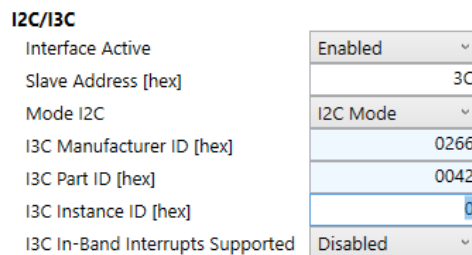

Figure 29. Serial Interfaces - I2C/I3C

### 5.2.2 SPI

The SPI selection (Figure 30) allows to configure the following options for the serial bus:

- Interface Active: enables or disables the bus interface
- Slave Select Polarity: active LOW or HIGH
- CPHA: data sampling edge
- CPOL: SCK LOW or HIGH

When the field “Interface Active” is “Enabled”, the serial communication through the SPI bus is possible, see sections 2.5 and 3.1.2.

SPI	
Interface Active	Enabled ▾
Slave Select Polarity	Active LOW ▾
CPHA	Falling Edge ▾
CPOL	Default LOW ▾

Figure 30. Configure – Serial Interfaces – SPI

### 5.2.3 OWI

The OWI tab (Figure 31) allows to configure the following options for the serial bus:

- OWI Mode:
  - Off: OWI interface is disabled.
  - Window
  - Digital Mode
  - Analog Voltage 5V
  - Analog Voltage 10V
  - Analog Current loop 2W
  - Analog Current loop 3W
- FamilyAddrEn: family addressing not supported (default)
- FamilyAddr [hex]: read only – Renesas reserved
- SlaveAddrEn: slave addressing, the default is ‘Disabled’
- SlaveAddr [hex]: user configurable slave address (default 0x28)

OWI	
OWI Mode	Off ▾
FamilyAddrEn	Disabled ▾
FamilyAddr [hex]	78
SlaveAddrEn	Enabled ▾
SlaveAddr [hex]	28

Figure 31. Serial Interfaces - OWI

5.2.3.1 OWI Window

The OWI startup command must be received at either AOUT/OWI1 or OWI-IN pins, during the window time (200ms per channel).

Figure 32 shows the status of the OWI interface according to the time window and command received.

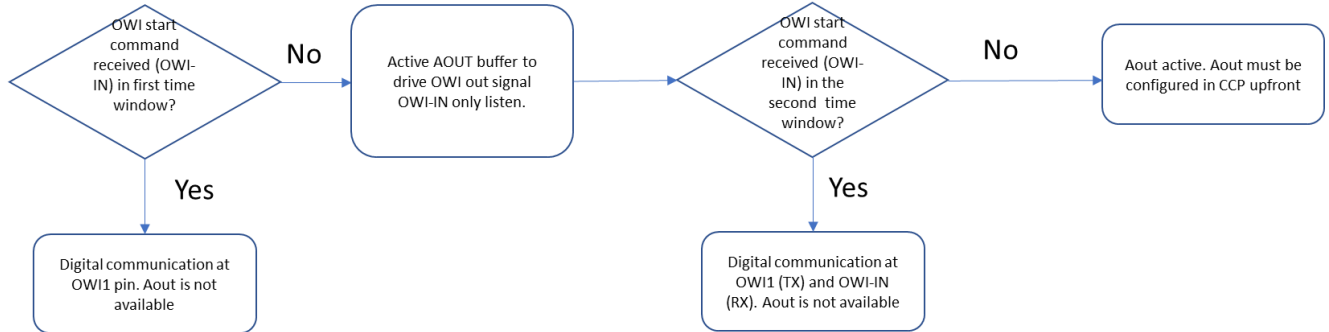

Figure 32. OWI Window

Supported AOUT Modes for OWI Window Mode:

- Absolute Voltage: 0V to 10V
- Absolute Voltage: 0V to 5V
- Ratiometric Voltage
- 2-wire-current-loop
- 3-wire-current-loop

The GUI provides the option to select to connect with the OWI bus in the first or in the second time window, see Figure 33 (refer to ZSSC3281 Datasheet document for a comprehensive description of the OWI Window functionality). The default is 'First', jumper to be in place is J8. If 'Second' is selected, jumper J7 must be in place.

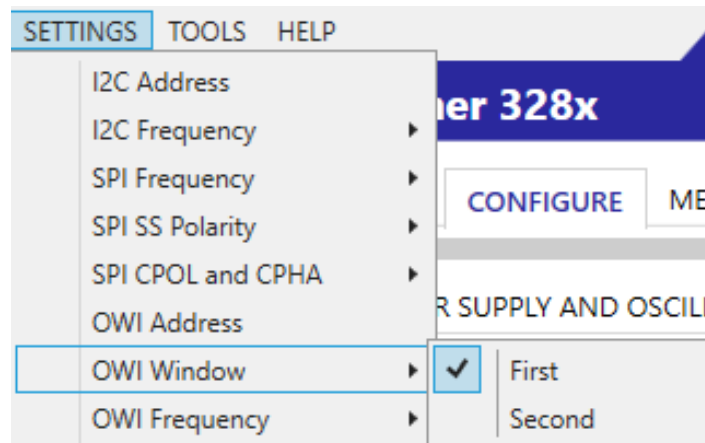

Figure 33. OWI Window Selection

### 5.2.3.2 OWI Digital

In the OWI Digital mode the OWI interface is in listening mode at OWI/AOUT pin only.

Figure 34 shows the status of the OWI interface according to the time window and command received.

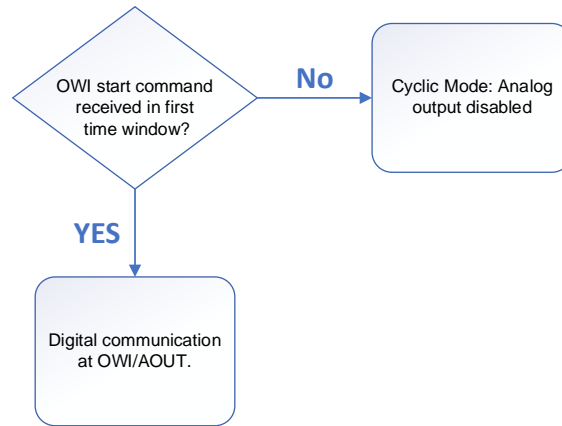

Figure 34. OWI Digital

### 5.2.3.3 OWI Analog Voltage Mode 5V VOUT

In the OWI Analog Voltage Mode 5V VOUT, the OWI interface is in listening mode at OWI-IN pin only.

Figure 35 shows the status of the OWI interface according to the time window and the command received.

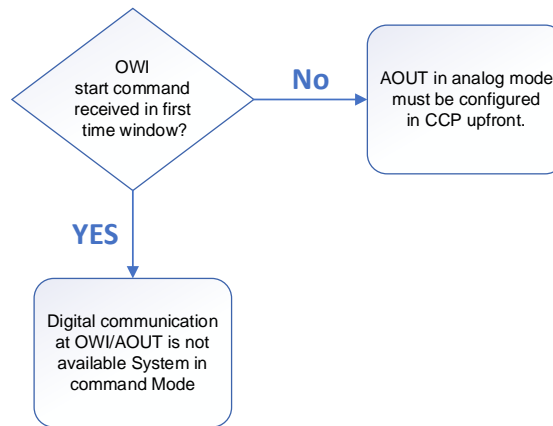

Figure 35. OWI Analog Voltage Mode 5V VOUT

Supported AOUT Modes:

- Absolute Voltage: 0V to 5V
- Ratiometric Voltage

### 5.2.3.4 OWI Analog Voltage Mode 10V VOUT

**Note:** this option requires to setup the additional 10V OWI master board that is described in a dedicated document (ask the Renesas representative).

In the OWI Analog Voltage Mode 10V VOUT, the OWI interface is in listening mode at OWI-IN pin only.

Figure 36 shows the status of the OWI interface according to the time window and the command received.

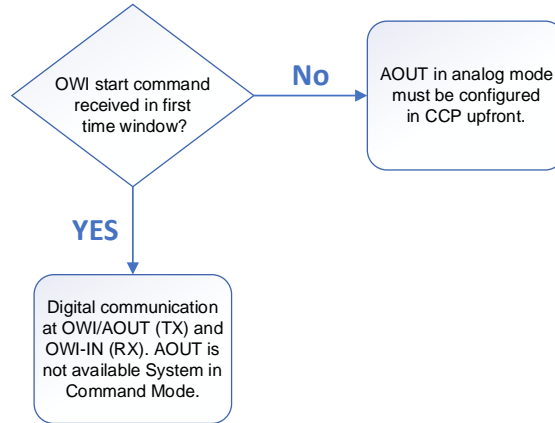

Figure 36. OWI Analog Voltage Mode 10V VOUT

Supported AOUT Modes:

- Absolute Voltage: 0V to 10V

### 5.2.3.5 OWI Analog Current Loop 2-Wire

Additional HW is required for OWI communication over 2-wire current loop; refer to the documentation available at the following link: [ZSSC32XX-CLOWI-PCB - One-Wire Current Loop Add-on Board for ZSSC32xx | Renesas](#)

In the OWI analog current loop 2-wire, the OWI interface is in listening mode at OWI-IN pin only.

Figure 37 shows the status of the OWI interface according to the time window and the command received.

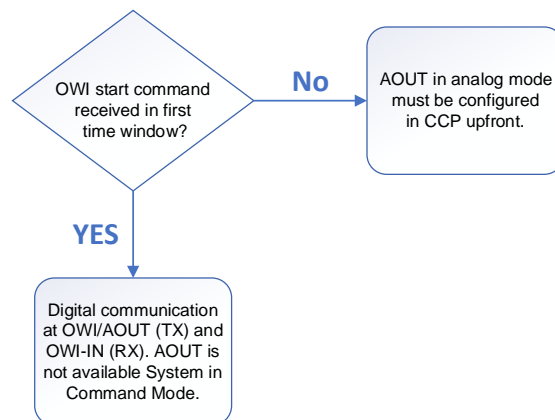

Figure 37. OWI over Analog Current Loop 2-Wire

The OWI serial interface must be configured as displayed in Figure 38.



Figure 38. Configuration for Communication OWI over 2WCL



OWI over VDD can be initiated from the GUI through the option displayed in Figure 39:

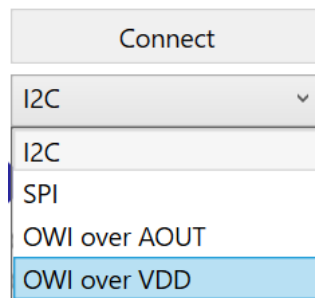

Figure 39. Connecting with OWI over 2WCL

Refer to the *ZSSC3281 OWI Master Guide* document for instructions for setting up OWI over VDD communication.

### 5.3 AFE Tab

#### 5.3.1 Sequencer

The measurement flow is configurable by software. The Analog Front End (AFE) controls the measurement timing for Cyclic Mode. The SSC calculation is executed in parallel (pipelined). Once started, the measurement flow runs autonomously controlled by the AFE sequencer. Depending on configuration, it either runs continuously (cyclic mode) or stops after one defined measurement sequence.

Description of the operation of the sequencer is detailed in the *ZSSC3281 Datasheet* document.

##### 5.3.1.1 AFE Selection and Configurability

The AFE Selection and Configurability option (Figure 40) allows to configure the following options:

- AFE1 Only: AFE1 is used, only the selected AFE starts to acquire data.
- AFE2 Only: AFE2 is used, only the selected AFE starts to acquire data.
- AFE1 + AFE2, config independently: both AFEs are used, relevant configurations are set independently, no restrictions are applied.
- AFE1 + AFE2, config equally: both AFEs are used, relevant configurations are set equally, the AFE2 controls become inactive (read-only) and get assigned the same value that is selected in the corresponding AFE1 controls. This option applies for the settings that influence measurement timing (sequencer, auxiliary measurement selection, AFE resolution, etc.). This option does not apply for analog data path settings (gain, etc.), i.e., AFE2 is configurable for those parameters.
- Dual Speed AFE with AOUT: both AFEs are used, one sensor bridge is connected to both front ends. AFE1 is setup for fast conversion, allowing fast response at lower accuracy. AFE2 is setup for slow conversion, generating a slower response at higher/typical accuracy, see Figure 41 for the needed connections of the bridge to the device. Description of operation of dual speed with the EVK is provided in section 5.3.1.6. Refer to the *ZSSC3281 Datasheet* document for a detailed description of this AFE operation mode.

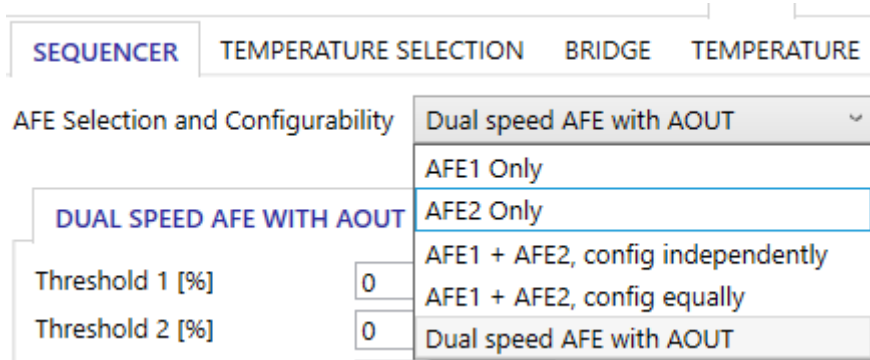

Figure 40. AFE Selection and Configurability

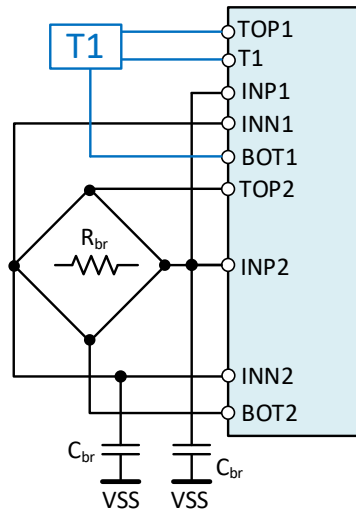

Figure 41. Dual Speed Resistive Bridge Input Configuration

Every combo must have a value for the GUI to start updating and storing the internal shadow image of the configuration file, otherwise the GUI considers the scheduler configuration. If values are missing, an error message pops-up (see Figure 42).

**Not all fields for this configuration have values**

Figure 42. Sequencer Error Message

When the configuration is completed, the scheduler configuration needs to be saved in the flash memory (NVM) before starting any measurement or saving the configuration on a file.

### 5.3.1.2 Sequencer Main Mode

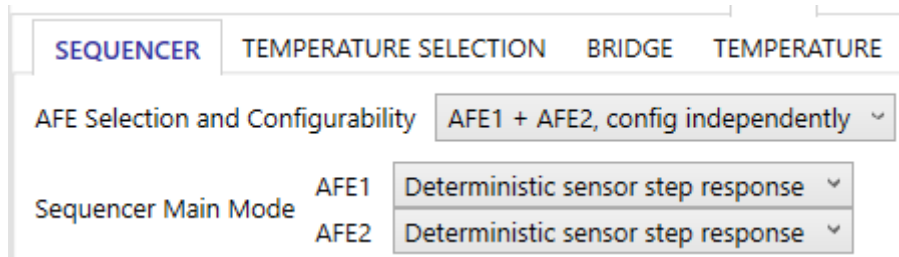

Figure 43. Sequencer Main Mode

The Sequencer Main Mode option (see Figure 43) allows to configure the following options:

- Deterministic sensor step response: for an application with fast and deterministic step response, the minimum predefined measurement flow consists of three phases:
  - sensor measurement (non-inverted)
  - sensor measurement (inverted)
  - auxiliary measurement

**Note:** SM+ and SM- sequence could be exchanged yielding to the same result (see Figure 44).



Figure 44. SM+/SM- Exchange

Within the auxiliary measurement vector, one auto-zero sensor measurement (AZS) can be configured (see Figure 45).

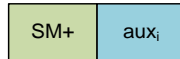

Figure 45. Auto-Zero Sensor Measurement

- Accelerated main measurement (see Figure 46): this measurement scheme is faster than the 'Deterministic sensor step response' which can lead to noticeable timing overhead due to analog frontend settling times. 'Accelerated main measurement' returns a measurement with 1 bit less effective resolution (setting the same physical resolution in both scenarios).

The screenshot shows the 'SEQUENCER' configuration page. At the top, there are tabs for 'SEQUENCER', 'TEMPERATURE SELECTION', 'BRIDGE', and 'TEMPERATURE'. Below the tabs, there is a section for 'AFE Selection and Configurability' with a dropdown menu set to 'AFE1 + AFE2, config independently' and an unchecked 'Advanced Options' checkbox. Underneath, 'Sequencer Main Mode' is configured for AFE1 as 'Accelerated main measurement' and for AFE2 as 'Deterministic sensor step response'. A sub-section for 'AFE1' is active, showing 'SM Combinations' set to 'SM+/SM-' and 'AUX Insertion Rate' set to 'After 2nd measurement'. Below these settings is a sequence diagram with two rows of boxes. The first row has 8 boxes labeled 1 through 8, with alternating colors: 1 (SM+), 2 (SM-), 3 (SM+), 4 (SM-), 5 (SM+), 6 (SM-), 7 (SM+), 8 (SM-). The second row has 16 boxes, alternating between SM+ and SM- for the first 15 boxes, followed by a final light blue box labeled 'AUX<sub>i</sub>'.

Figure 46. Accelerated Measurements

- AUX only: it can only be selected for one of the AFEs and if the Advanced Options (see 5.3.1.3) are enabled.

### 5.3.1.3 Advanced Options

Enabling the “Advanced Options” (see Figure 47) box sets the “Aux only” option in the Sequencer Main Mode. It also enables the insertion of a selectable number of AUX measurements.

The screenshot shows the 'SEQUENCER' configuration page with 'Advanced Options' checked. The 'AFE Selection and Configurability' dropdown is still 'AFE1 + AFE2, config independently'. Under 'Sequencer Main Mode', both AFE1 and AFE2 are now set to 'Deterministic sensor step response'. The rest of the interface, including the tabs and the AFE1 sub-section, remains the same as in Figure 46.

Figure 47. Advanced Options

With the advanced options enabled, the user can also insert a set of Auxiliary Measurements slots (see Figure 48).

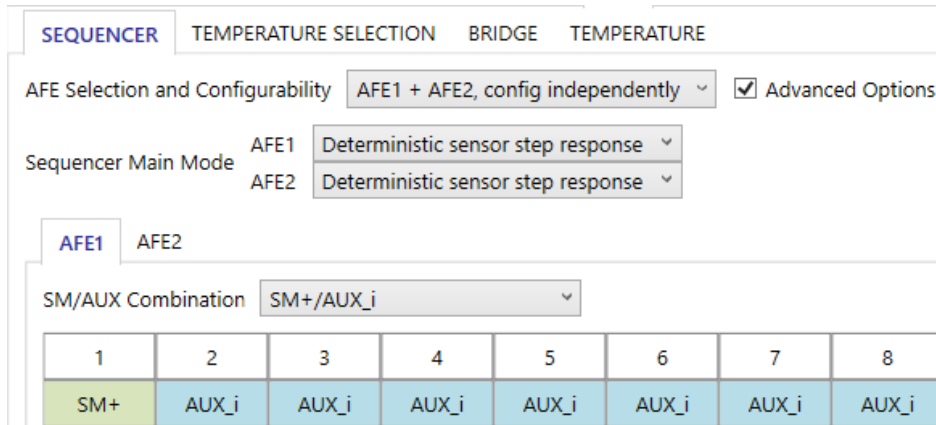

Figure 48. Advanced Options – Aux Slots

### 5.3.1.4 Sequencer Main Mode Set to Deterministic Sensor Step Response

When the Sequencer Main Mode is set to “Deterministic Sensor Step Response”, the SM/AUX allowed combinations are displayed in Figure 49.

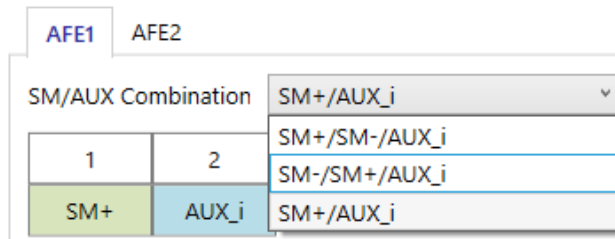

Figure 49. Main Mode Set to Deterministic Sensor Step Response – SM/AUX

Description of the options:

- SM+/SM-/AUX<sub>i</sub>: Sensor measurement, inverted measurement, and auxiliary measurement
- SM-/SM+/AUX<sub>i</sub>: Inverted sensor measurement, sensor measurement and auxiliary measurement
- SM+/AUX<sub>i</sub>: Sensor measurement and auxiliary measurement

#### 5.3.1.4.1 Auxiliary Option

When the “Advanced Options” are enabled, it is possible to activate a predefined amount of auxiliary measurement slots (see Figure 50).

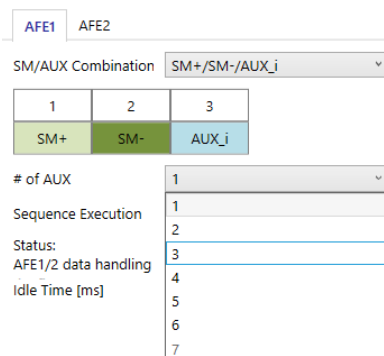

Figure 50. Auxiliary Measurements

5.3.1.4.2 Auxiliary Amount Selection

Activating more than one auxiliary measurement triggers a trading off sensor measurement interval with auxiliary cycle period: a maximum of 6 or 7 (depending on the selected SM/AUX combination) auxiliary measurements to be executed for each sensor measurement.

With the selection of the number of auxiliary measurements, the GUI appears as in Figure 51.

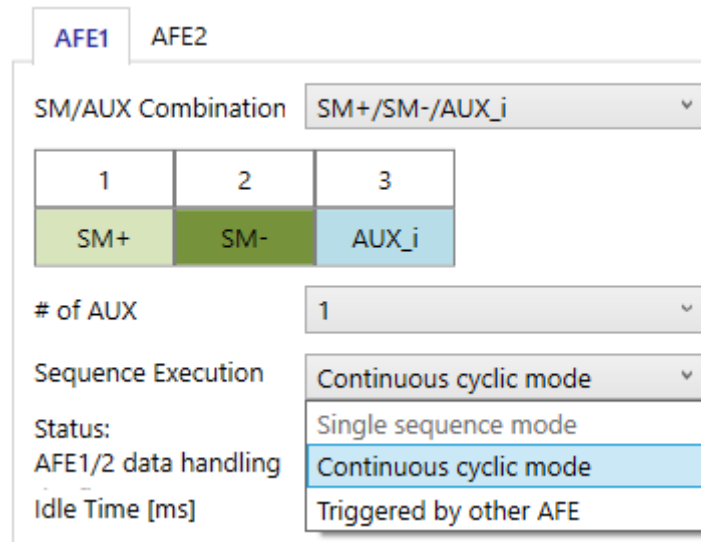

Figure 51. Auxiliary Measurements Enabled Displayed in GUI

The selection of the value in the ‘Sequence Execution’ field implies the following:

- Single sequence mode: one time execution of the sequence. This option is currently not available, it is reserved for future developments.
- Continuous cyclic mode: the sequence displayed is executed cyclically in a continuous way.
- Triggered by other AFE: the sequence displayed is executed after triggering by another AFE (for example, a master IC AFE triggers the sequence execution of a slave IC AFE). This option is currently not available, it is reserved for future developments.

5.3.1.4.3 Idle Time

This input field is available in ‘Continuous cyclic mode’ only. Idle time up to 10ms can be inserted between two sequences (see Figure 52).

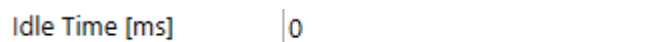

Figure 52. Sequencer – Idle Time

5.3.1.5 Sequencer Main Mode Set to Accelerated Main Measurement

When the Sequencer Main Mode is set to ‘Accelerated main measurement’, the possible sensor measurement combinations are displayed in Figure 53.

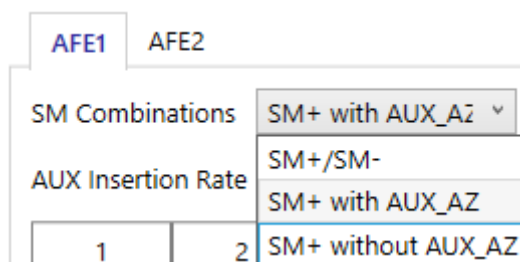

Figure 53. Accelerated Main Measurement: SM Combinations

The selection “SM combinations” chooses the baseline measurement configuration to form one sequence.

- SM+/SM-: SM+ and SM- are processed to carry out internal offset compensation, AUX\_AZ is not active.
- SM+ with AUX\_AZ: SM+ and AUX\_AZ are processed to carry out internal offset compensation, AUX\_AZ is active.
- SM+ without AUX\_AZ: SM+ only without internal offset compensation, AUX\_AZ is not active.

**5.3.1.5.1 AUX Insertion Rate**

The AUX Insertion Rate (Advanced Options enabled) defines at which point of the measurement sequence an auxiliary measurement is performed. The auxiliary measurement can be placed after 2, 4, or 8 measurements (each consisting of 4 pairs of SM+/-), see Figure 54.

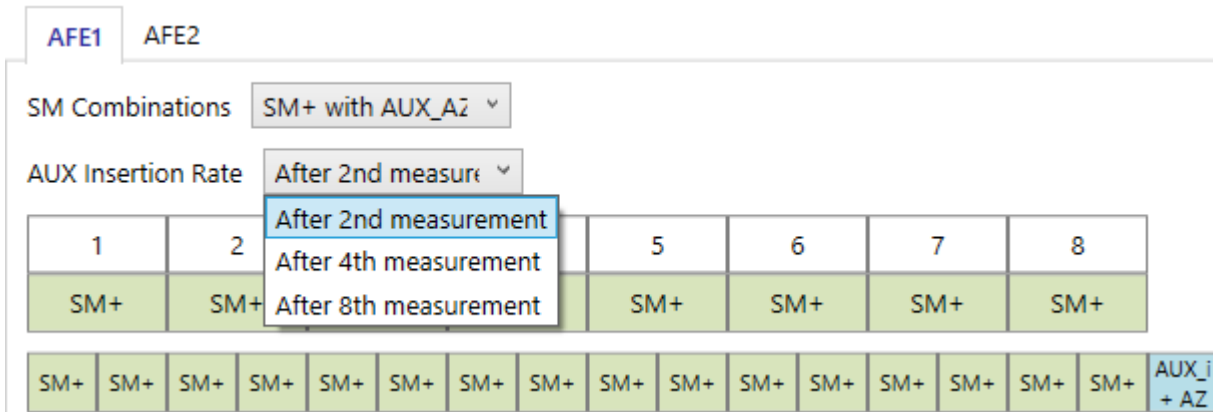

**Figure 54. Auxiliary Insertion Rate**

According to the selection done in the SM combination, the auxiliary measurement can also be after sequence of 16/32/64 SM+ measurements and with or without an additional AZ measurement, see Figure 55.

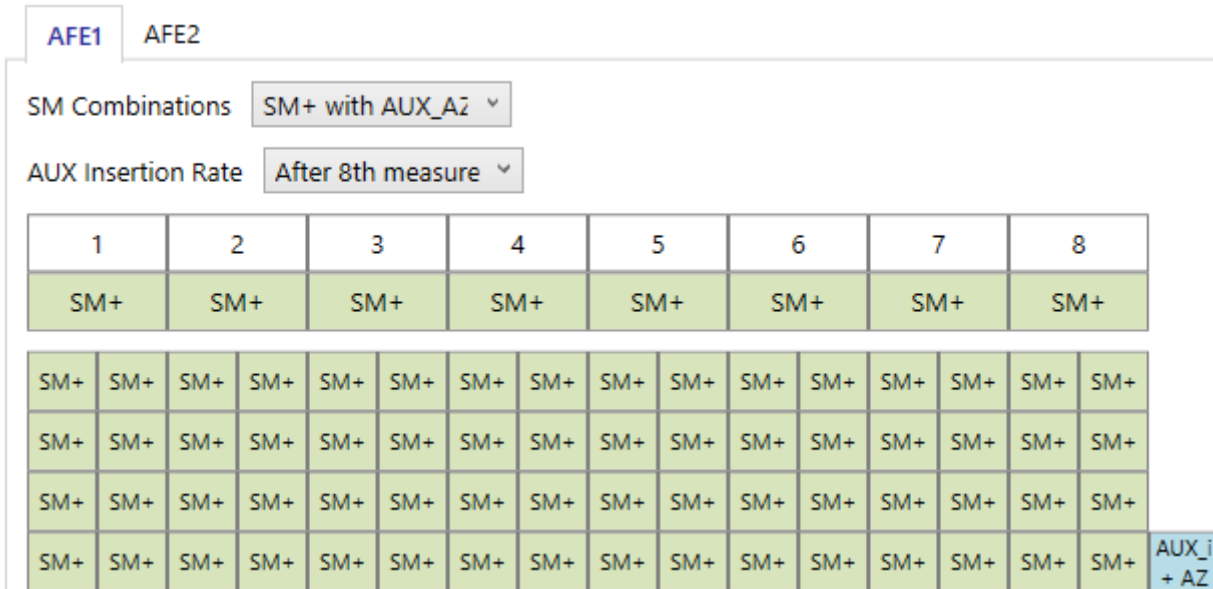

**Figure 55. Auxiliary Insertion Rate: SM+AUX\_AZ after the Eights Measurement**

5.3.1.5.2 Sequence Execution

The selection of “Sequence Execution” (see Figure 56) allows the following options:

- Continuous cyclic mode: a continuous cyclic acquisition of the sequence defined through the “SM Combinations” and the “AUX insertion rate”.
- Triggered by the other AFE: displays a single sequence defined through the “SM Combinations” and the “AUX insertion rate” acquisition triggered by the other AFE. This option is currently not available, it is reserved for future developments.

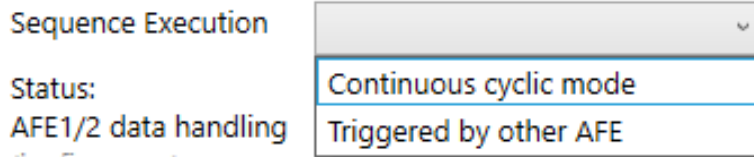

Figure 56. Sequence Execution

The example displayed in Figure 57 shows the slot order when the Sequence Execution is set to “Continuous cyclic mode”, the “AUX insertion Rate” is set after the second measurement:

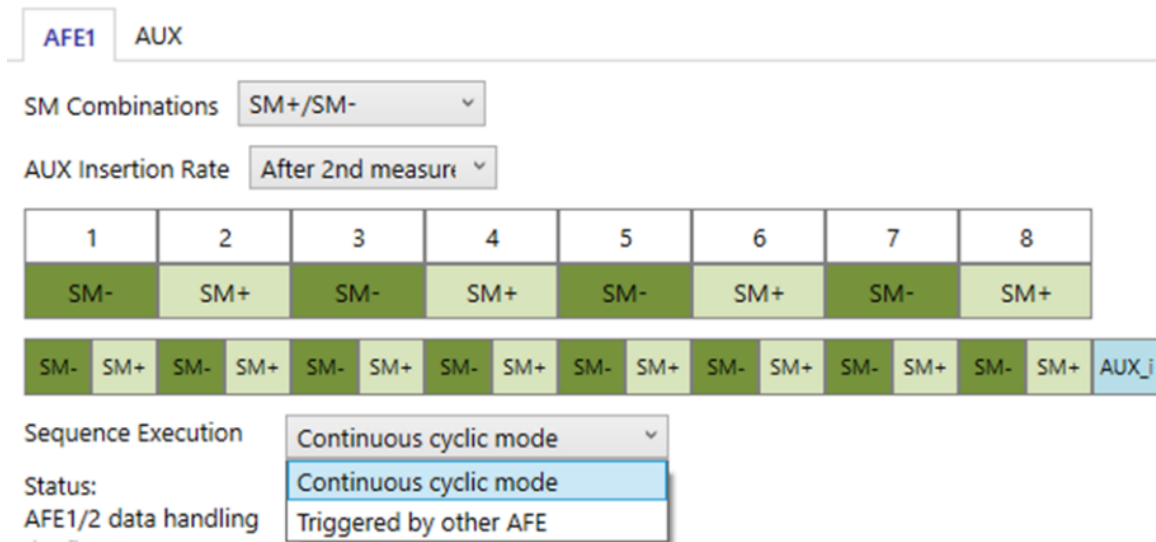

Figure 57. Sequence Execution Example

Eight SM+ and eight SM- readings are performed and finally one auxiliary measurement is taken.

5.3.1.6 AFE Selection: Dual Speed Mode

The dual speed software algorithm combines results of the acquisition from the two AFEs into one conditioned output result (digital and analog) at a time. The bridge must be biased by AFE2 to ensure a ratiometric setup for AFE2 to generate precise and low noise results in this channel. The bridge bias must be active continuously to not disturb the simultaneous conversions in AFE1. Thus, AFE1 has a non-ratiometric bridge connection.

For operating the Dual Speed mode, the EVK can be used with a specific setup of the SRB3 board: remove all jumpers from J6 and connect J3-1 with J6-4, and J3-4 with J6-2. With this setup the second bridge on the SRB is connected as in Figure 41 (temperature sensor can be external, or internal PTAT).

For dual speed operation select the relevant value in the list as displayed in Figure 58.

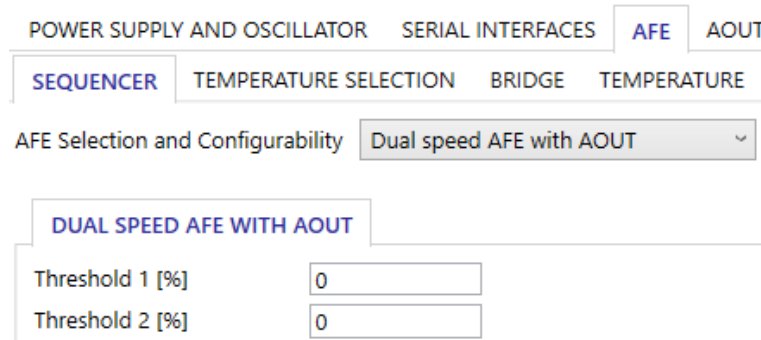

Figure 58. Dual Speed Settings

'Thresholds 1 [%]' and 'Thresholds 2 [%]' are configuration parameters used by the algorithm to switch the signal acquisition from one AFE to the other.

Transition from AFE2 to AFE1 occurs when significant signal change (larger than Threshold 1) is detected by AFE1.

Transition from AFE1 to AFE2 occurs when no further signal changes (larger than Threshold 2) are detected by AFE1 over the course of approximately two AFE2 conversion times.

Values of Thresholds are expressed in % to the full dynamic range of the signal. Their default value is 10% for 'Thresholds 1 [%]' and 2% for 'Thresholds 2 [%]'

The selection of dual speed operation impacts several parameter values, selection and configuration options availability. Details are provided in the relevant tabs description.

### 5.3.2 Temperature Selection

Four physical temperature sensors are available:

- 1 internal temperature sensor: PTAT
- 3 external temperature sensors: T1, T2, T3

Each of four physical temperature sensors can be assigned to each of the 3 logical temperature channels (Temp Ch1/2/3). An overview of this tab is provided in Figure 59.

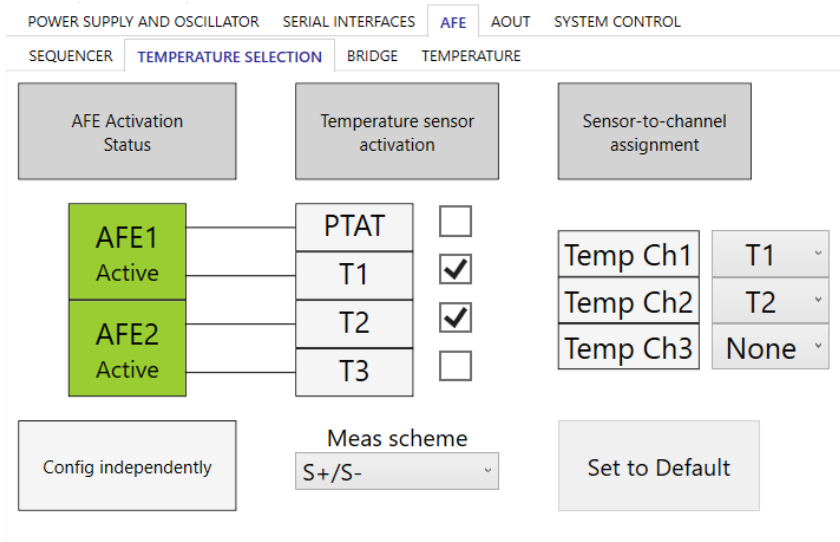

Figure 59. Temperature Selection Overview



This tab provides an overall view of the status of the Analog Front Ends, of the selectable temperature transducer(s), and of the association of the active temperature transducer(s) to one or more of the 3 logical temperature channels available.

When Dual Speed Mode is selected the Temperature sensor activation is possible for AFE1, see Figure 60.

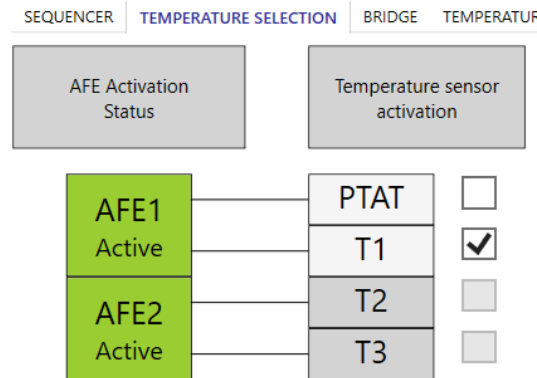

Figure 60. Temperature Selection – Dual Speed

### 5.3.2.1 Channels Data Paths

A simplified high-level description of the data paths for the Main sensor channels 1/2/3 and Temperature channels 1/2/3 is provided in Figure 61.

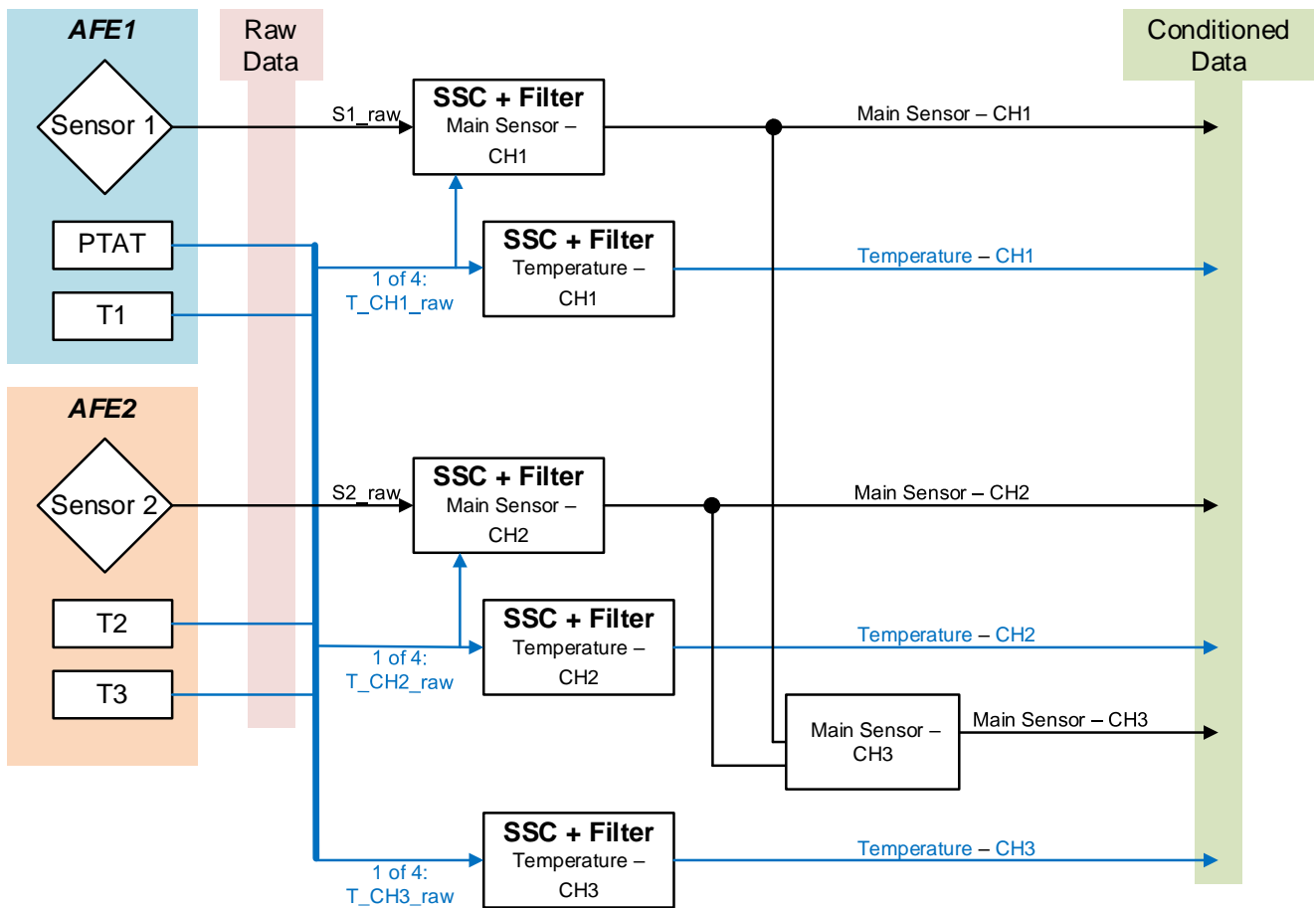

Figure 61. Acquired Data Stream Overview

Figure 61 demonstrates how the conditioned measured values are determined either for the main input transducers (CH1/2) and the derived CH3, or for the temperature transducers (PTAT, T1/2/3) that can be returned and conditioned on T\_CH1/2/3.

Sensor 1 acquired data are processed through the main sensor CH1. When the calibration process requires it (refer to Figure 169), the temperature CH1 is used for the main sensor CH1 calibration over temperature.

Sensor 2 acquired data are processed through the main sensor CH2. When the calibration process requires it (refer to Figure 169), the temperature CH2 is used for the main sensor CH2 calibration over temperature.

### 5.3.2.2 AFE Status

Figure 62 displays the status of each AFE of the device, green color indicate that the AFE is active.

The AFE activation control is handled by the Sequencer tab, through the selection of the preferred option as displayed in Figure 40. If both AFEs are active, GUI displays if they are configured equally or independently (see section 5.3.1.1 for details on dual AFE configuration).

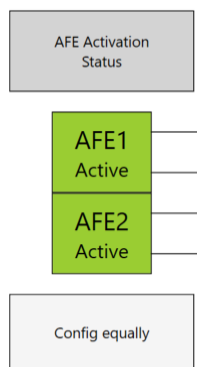

Figure 62. AFE Status

### 5.3.2.3 Temperature Sensor

Enable the relevant selection box to make one or more input temperature transducers active, see Figure 63.

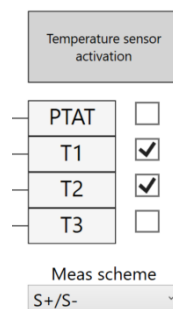

Figure 63. Temperature Sensor Activation

AFE1 processes, when activated, the PTAT and/or T1. AFE2 processes, when activated, the T2 and/or T3. The 'Meas scheme' selection list allows to choose between the acquisitions of S+/S- and S+ only.

**Note:** the selected activations are automatically changed in the GUI if the configuration chosen in the sequencer are modified. (refer to Figure 40). This allows to keep consistency in the device configuration.

### 5.3.2.4 Channel Assignment

Assign the activated temperature sensor to the Temperature channels (1/2/3) by the drop-down lists, see Figure 64. “Set to Default” button returns channel assignment to factory default values.

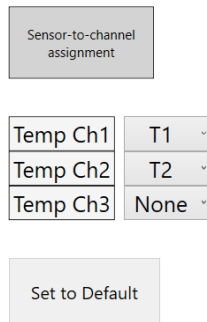

**Figure 64. Sensor to Channel Assignment**

**Note:** The channel assignments selected by the user may be automatically changed in the GUI, in case the user afterwards modifies the configuration chosen in the sequencer (refer to Figure 40). This allows to keep consistency in the device configuration.

### 5.3.3 Bridge

The Bridge tab is structured according to the following scheme:

- The settings in the “Parameters” section are the only ones that are saved in the device configuration NVM.
- Data input in the “Sensor Values” section are used for the “Internals” values calculations along with the “Parameters” selected.
- The “Meas Config” selection affects only the “Internals” calculation and the graphs display.

### 5.3.3.1 Bridge Configurations

Through the 'Mode' drop-down list in the Parameters section, the GUI offers 4 different options for supplying the transducer wired to the ZSSC3281, allowing the resistive bridge to be supplied by/through:

- Voltage: internal voltage supply (VDDA, refer to the ZSSC3281 Datasheet document), see Figure 65.  
**Note:** this mode is used in this document for description/example purposes for the Bridge tab, selecting other modes returns different schematic, graphs, and parameters enabling/disabling options.

SEQUENCER
TEMPERATURE SELECTION
BRIDGE
TEMPERATURE

---

Configure
Calculation and Visualization

**Configure Register** Bridge 1

**Parameters**

Mode: Voltage

PgaGain1: 19.8

PgaGain2: 1.6

PgaPolarity: Positive

PgaOffset [mV]: 0

AdcReso: 16

AdcShift and 2xGain: Enabled

AdcShift: 0

SetTime [μs]: 20

BrdgRth

BrdgRtl

BridgeBias [μA]

Copy to Bridge 2

**Sensor Values**

Max Input [mV/V]	10
Max Offset [mV/V]	1
Bridge Resistance [Ω]	5000
Bridge Capacitance [nF]	0.5
Calculated Tau*5 [μs]	12.5
RH [Ω]	0
RL [Ω]	0

**Internals**

VDDA [V]	1.65
Max ADC Input [V]	1.4
Input(VDDA) [mV]	16.5
Offset(VDDA) [mV]	1.65
Calculated Gain(90%)	70
Calc G(90%) w/ PgaOffset	70
Bridge Current [mA]	0.330

	SM+	SM-
ADC Input Max [mV]	575.0	-575.0
ADC Input Min [mV]	-470.4	470.4
ADC Int Max(Shift) [mV]	1,150.0	-1,150.0
ADC Int Min(Shift) [mV]	-940.9	940.9
ADC Out Max	13,080	-13,080
ADC Out Min	-10,702	10,702
ADC Out Max(Shift)	26,161	-26,161
ADC Out Min(Shift)	-21,404	21,404

**Meas Config** Pair (SM+/SM-)

Schematic
  Graph ADC Vin
  Graph ADC Val
  Both Graphs

Figure 65. Voltage Mode

- Resistor: internal voltage supply (VDDA, refer to ZSSC3281 Datasheet document) with configurable internal series resistors, see Figure 66.

SEQUENCER
TEMPERATURE SELECTION
BRIDGE
TEMPERATURE

---

Configure
Calculation and Visualization

**Configure Register** Bridge 1

**Parameters**

Mode: Resistor

PgaGain1: 19.8

PgaGain2: 1.6

PgaPolarity: Positive

PgaOffset [mV]: 0

AdcReso: 16

AdcShift and 2xGain: Enabled

AdcShift: 0

SetTime [μs]: 20

BrdgRth: 1333

BrdgRtl: 1333

BridgeBias [μA]:

Copy to Bridge 2

Sensor Values		Internals		SM+		SM-	
Max Input [mV/V]	10	VDDA [V]	1.65	ADC Input Max [mV]	575.0	-575.0	
Max Offset [mV/V]	1	Max ADC Input [V]	1.4	ADC Input Min [mV]	-470.4	470.4	
Bridge Resistance [Ω]	5000	Input(VDDA) [mV]	16.5	ADC Int Max(Shift) [mV]	1,150.0	-1,150.0	
Bridge Capacitance [nF]	0.5	Offset(VDDA) [mV]	1.65	ADC Int Min(Shift) [mV]	-940.9	940.9	
Calculated Tau*5 [μs]	19.165	Calculated Gain(90%)	70	ADC Out Max	13,080	-13,080	
		Calc G(90%) w/ PgaOffset	70	ADC Out Min	-10,702	10,702	
		Bridge Current [mA]	0.215	ADC Out Max(Shift)	26,161	-26,161	
		Bridge Voltage [V]	1.650	ADC Out Min(Shift)	-21,404	21,404	

**Meas Config** Pair (SM+/SM-)  Schematic  Graph ADC Vin  Graph ADC Val  Both Graphs

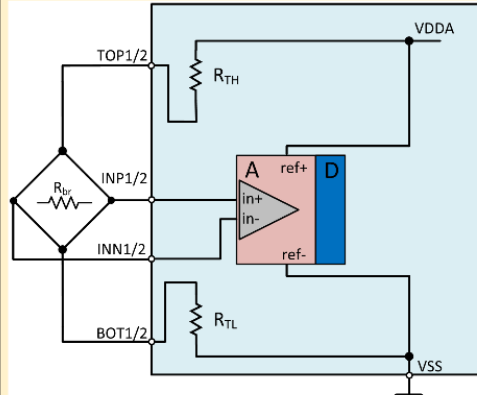

Figure 66. Resistor Mode

- Current: configurable internal current source with configurable internal series resistor, see Figure 67.

SEQUENCER
TEMPERATURE SELECTION
BRIDGE
TEMPERATURE

---

Configure

**Configure Register** Bridge 1

**Parameters**

Mode: Current

PgaGain1: 19.8

PgaGain2: 1.6

PgaPolarity: Positive

PgaOffset [mV]: 0

AdcReso: 16

AdcShift and 2xGain: Enabled

AdcShift: 0

SetTime [μs]: 20

BrdgRth: 1333

BrdgRtl: 5

BridgeBias [μA]: 5

Copy to Bridge 2

Calculation and Visualization

**Sensor Values**

Max Input [mV/V]: 10

Max Offset [mV/V]: 1

Bridge Resistance [Ω]: 5000

Bridge Capacitance [nF]: 0.05

Calculated Tau\*5 [μs]: 14

**Internals**

VDDA [V]: 1.65

Max ADC Input [V]: 1.4

Input(VDDA) [mV]: 16.5

Offset(VDDA) [mV]: 1.65

Calculated Gain(90%): 70

Calc G(90%) w/ PgaOffset: 70

Bridge Current [mA]: 0.005

Bridge Voltage [V]: 0.032

	SM+	SM-
ADC Input Max [mV]	575.0	-575.0
ADC Input Min [mV]	-470.4	470.4
ADC Int Max(Shift) [mV]	1,150.0	-1,150.0
ADC Int Min(Shift) [mV]	-940.9	940.9
ADC Out Max	13,080	-13,080
ADC Out Min	-10,702	10,702
ADC Out Max(Shift)	26,161	-26,161
ADC Out Min(Shift)	-21,404	21,404

**Meas Config** Pair (SM+/SM-) 
 Schematic
  Graph ADC Vin
  Graph ADC Val
  Both Graphs

Figure 67. Current Mode

- Thermopile: the device acquires the voltage signal generated by a thermopile, see Figure 68.

SEQUENCER
TEMPERATURE SELECTION
BRIDGE
TEMPERATURE

---

Configure

**Configure Register** Bridge 1 ▾

**Parameters**

Mode: Thermopile ▾

PgaGain1: 19.8 ▾

PgaGain2: 1.6 ▾

PgaPolarity: Positive ▾

PgaOffset [mV]:

AdcReso: 16 ▾

AdcShift and 2xGain: Enabled ▾

AdcShift: 0 ▾

SetTime [μs]: 20 ▾

BrdgRth:

BrdgRtl:

BridgeBias [μA]:

Copy to Bridge 2

Calculation and Visualization

**Sensor Values**

Max Input [mV/V]:

**Internals**

VDDA [V]	1.65
Max ADC Input [V]	1.4
Input(VDDA) [mV]	16.5
Offset(VDDA) [mV]	0
Calculated Gain(90%)	77
Calc G(90%) w/ PgaOffset	77

	SM+	SM-
ADC Input Max [mV]	522.7	-522.7
ADC Input Min [mV]	0.0	0.0
ADC Int Max(Shift) [mV]	1,045.4	-1,045.4
ADC Int Min(Shift) [mV]	0.0	0.0
ADC Out Max	11,891	-11,891
ADC Out Min	0	0
ADC Out Max(Shift)	23,783	-23,783
ADC Out Min(Shift)	0	0

**Meas Config** Pair (SM+/SM-) ▾

Schematic
  Graph ADC Vin
  Graph ADC Val
  Both Graphs

Figure 68. Thermopile Mode

### 5.3.3.2 Configure Register

To configure an Analog Front End, select it from the “Configure Register” drop-down list and set the relevant values in the Parameters section.

To duplicate an already defined configuration, click “Copy to Bridge” button (see Figure 69).

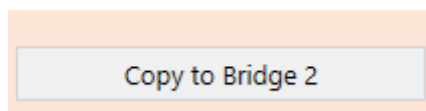

Figure 69. Configure Register

### 5.3.3.3 Meas Config

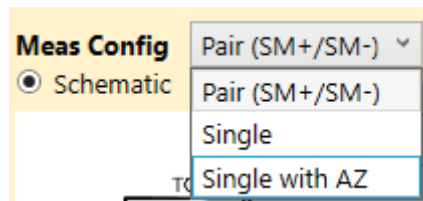

Figure 70. Meas Config Menu

The Meas Config menu (see Figure 70) affects the internal calculations and Graphs only and it allows to select from the following options:

- Pair (SM+/SM-): a pair of measurements i.e., the SM+ AND SM- readings (see Figure 70)
- Single: single measurement (see Figure 71)
  - SM+
  - SM-
  - AZ

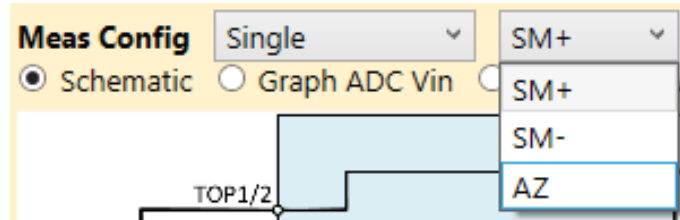

Figure 71. Meas Config: Single

- Single with AZ: single measurement with AZ (see Figure 72)
  - SM+
  - SM-
  - AZ

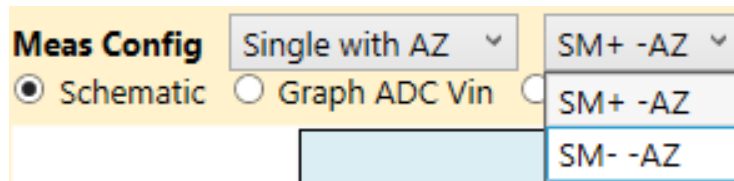

Figure 72. Meas Config: Single AZ

### 5.3.3.4 Sensor Values

The Sensor Values section (see Figure 73) allows the user to enter the input transducer characteristics for performing the calculations displayed in Figure 76.

Sensor Values	
Max Input [mV/V]	10
Max Offset [mV/V]	1
Bridge Resistance [ $\Omega$ ]	10000
Bridge Capacitance [nF]	0
Calculated Tau*5 [ $\mu$ s]	0
RH [ $\Omega$ ]	0
RL [ $\Omega$ ]	0

Figure 73. Bridge – Sensor Values

The GUI SW calculates the Tau time constant (Resistance x Capacitance) according to the inputs provided.



### 5.3.3.5 Parameters

The Parameters section (see Figure 74) defines the type of the transducer supply, the behavior of the analog signal path, and the ADC configuration. Specific parameters values enable or disable the availability of a set of additional parameters and the relevant list of available values.

The reference schematic in Figure 75 is dynamically updated according to the 'Mode' selection, see section 5.3.3.1 for details on different modes.

Configure Register	Bridge 1
<b>Parameters</b>	
Mode	Voltage
PgaGain1	20
PgaGain2	1.6
PgaPolarity	Positive
PgaOffset [mV]	11.25
AdcReso	16
AdcShift and 2xGain	Enabled
AdcShift	0
SetTime [μs]	20
BrdgRth	
BrdgRtl	
BridgeBias [μA]	

Figure 74. Bridge – Parameters

The following parameters can be set:

- Mode: defines the type of supply scheme of the connected transducer, see section 5.3.3.1.
- PgaGain1: PGA gain stage 1 value
- PgaGain2: PGA gain stage 2 value
- PgaPolarity: Polarity inversion of the PGA input signal
- PgaOffset [mV]: PGA offset value (in mV)
- AdcReso: ADC resolution
- AdcShift and 2xGain: enable of the internal ADC 2x gain and internal ADC offset shift.
- AdcShift: ADC offset shift value
- SetTime [μs]: Bridge settling time (μs)

The following parameters are available if “Current” or “Resistor” modes are selected:

- BrdgRth: internal bridge resistor value (Ohm) upper side (Rth)
- BrdgRtl: internal bridge resistor value (Ohm) lower side (Rtl)
- BridgeBias [μA]: current level of transducer current driver ( $I_{Tbias}$ )

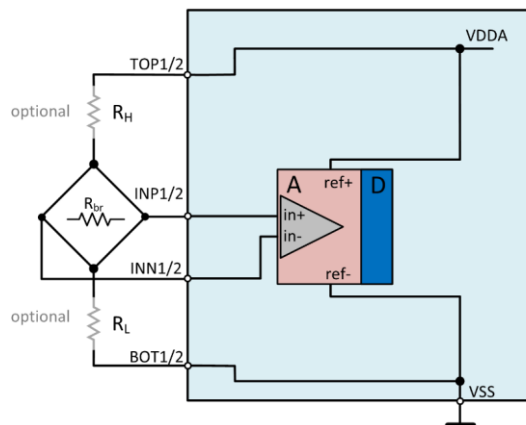

Figure 75. Mode Voltage Schematic

5.3.3.6 Internals

The Internals section (see Figure 76) displays values of specific electrical parameters that are built in the device and calculated parameters after the values set as per sections 5.3.3.3, 5.3.3.4, and 5.3.3.5.

Internals			SM+	SM-
VDDA [V]	1.65	ADC Input Max [mV]	676.8	-676.8
Max ADC Input [V]	1.4	ADC Input Min [mV]	148.8	-148.8
Input(VDDA) [mV]	8.25	ADC Int Max(Shift) [mV]	1,353.6	-1,353.6
Offset(VDDA) [mV]	1.65	ADC Int Min(Shift) [mV]	297.6	-297.6
Calculated Gain(90%)	129	ADC Out Max	15,397	-15,397
Calculated Offset(90%)	60	ADC Out Min	3,385	-3,385
Bridge Current [mA]	0.330	ADC Out Max(Shift)	30,793	-30,793
		ADC Out Min(Shift)	6,770	-6,770

Figure 76. Internals Example

The following values are displayed:

- VDDA: analog supply typical level (silicon defined)
- Max ADC Input [V]: the maximum ADC input level (silicon defined)
- Input(VDDA) [mV]: input pin level (VDDA supply) in mV
- Offset(VDDA) [mV]: offset input pin level (VDDA supply) in mV
- Calculated Gain(90%): suggested Gain setting to reach 90% FS
- Calculated Offset(90%): suggested offset setting to reach 90% FS
- Bridge Current [mA]: current on the resistive transducer
- ADC Input Max [mV]: ADC maximum input (input multiplied by Gain)
- ADC Input Min [mV]: ADC minimum input (input multiplied by Gain)
- ADC Input Max(Shift) [mV]: ADC maximum input (input multiplied by Gain and including shift)
- ADC Input Min(Shift) [mV]: ADC minimum input (input multiplied by Gain and including shift)
- ADC Out Max: ADC maximum output (counts)
- ADC Out Min: ADC minimum output (counts)
- ADC Out Max(Shift): ADC maximum output with ADC internal shift and 2x gain (counts)
- ADC Out Min(Shift): ADC minimum output with ADC internal shift and 2x gain (counts)

Out of range parameters or input values are highlighted in red, see Figure 77.

Internals			SM+	SM-
VDDA [V]	1.65	ADC Input Max [mV]	1,468.8	-1,468.8
Max ADC Input [V]	1.4	ADC Input Min [mV]	-643.2	643.2
Input(VDDA) [mV]	33	ADC Int Max(Shift) [mV]	2,937.6	-2,937.6
Offset(VDDA) [mV]	1.65	ADC Int Min(Shift) [mV]	-1,286.4	1,286.4
Calculated Gain(90%)	37	ADC Out Max	33,414	-33,414
Calculated Offset(90%)	28	ADC Out Min	-14,632	14,632
Bridge Current [mA]	0.165	ADC Out Max(Shift)	66,827	-66,827
		ADC Out Min(Shift)	-29,264	29,264

Figure 77. Internals Out of Range

### 5.3.3.7 Schematic and Graphs

Select Schematic, Graph ADC Vin, Graph ADC Val, or Graph Combined (Figure 78) to switch view among the reference circuit schematic, the input to ADC Voltage transfer characteristic graph, the ADC input voltage to ADC counts transfer characteristic, and a combined view of both graphs (see Figure 79).

- Schematic
- Graph ADC Vin
- Graph ADC Val
- Graph Combined

Figure 78. Schematic and Graphs Selection

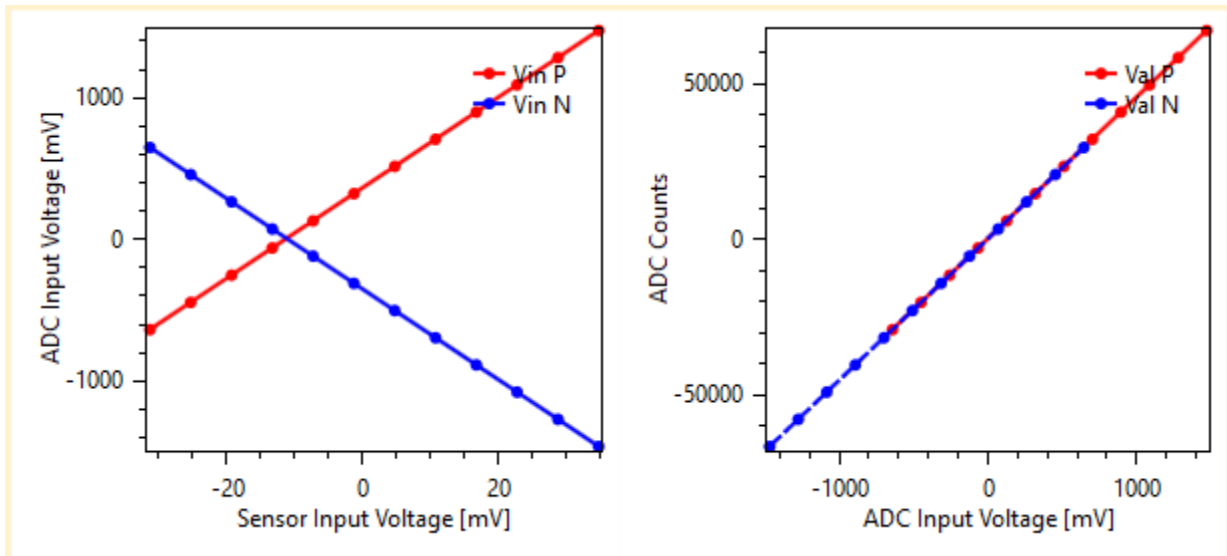

Figure 79. Combined Graphs

### 5.3.3.8 Bridge in Dual Speed Mode

If Dual speed mode configuration is selected (see section 5.3.1.6), parameters of Bridge 1 are fixed and they are dependant from the parameter settings of Bridge 2 as shown in Figure 80.

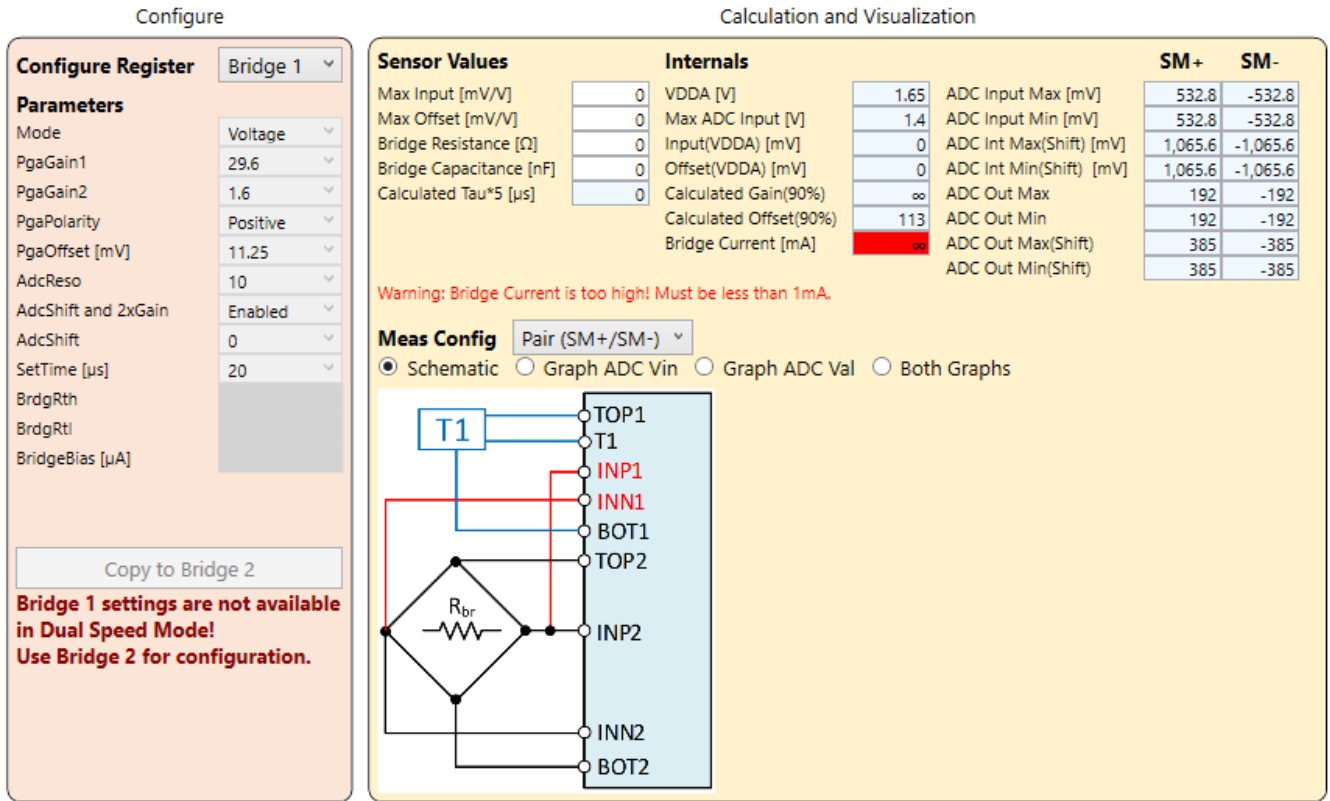

Figure 80. Dual Speed Mode for Bridge 1

Figure 81 displays the user configurable parameters for Bridge 2.

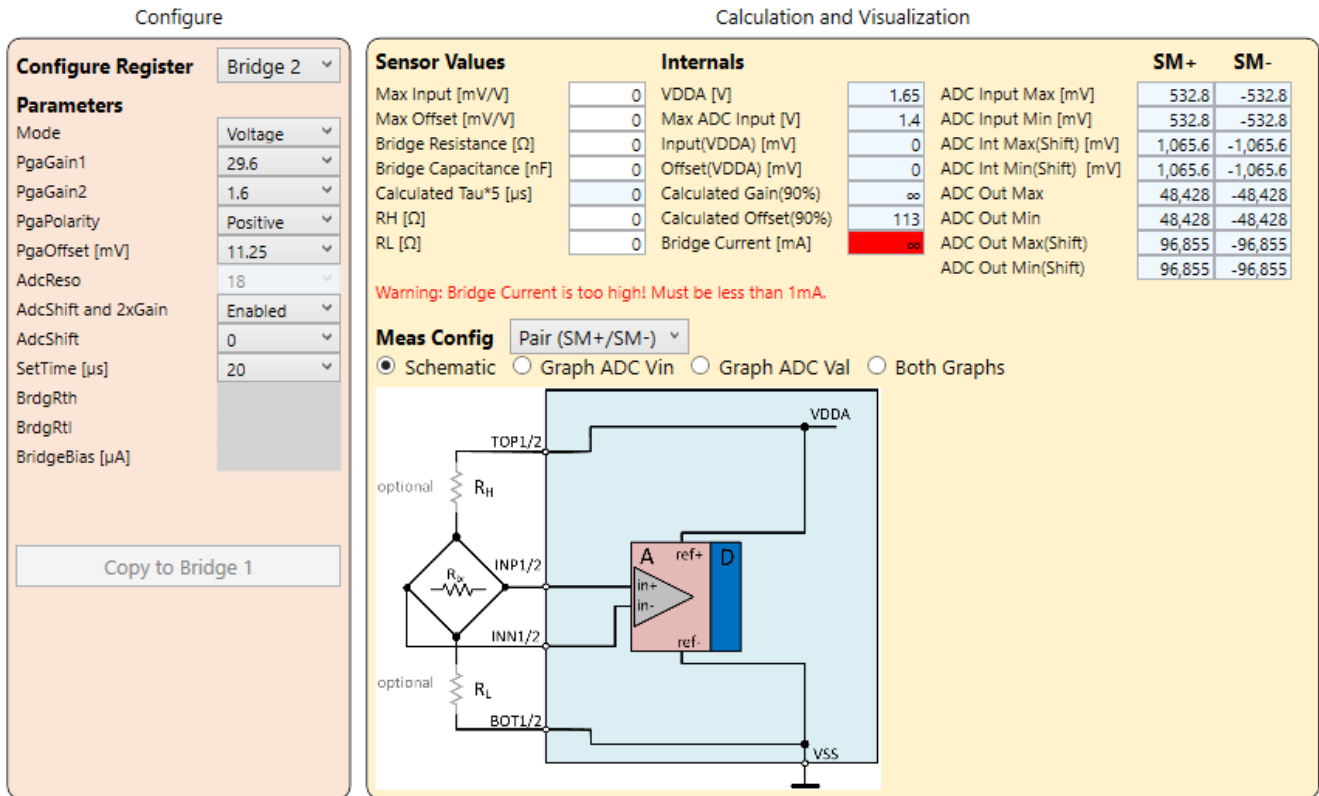

Figure 81. Dual Speed Mode for Bridge 2

**Note:** The resolution in the 'AdcReso' parameter is a fixed value. The values of other parameters are assigned to Bridge 1 through the Bridge 2 tab. Configuration must be saved to the NVM.

### 5.3.4 Temperature

The Temperature tab is structured according to the following scheme:

- The settings in the “Parameters” section are the only ones that will be saved in the device configuration NVM.
- Data input in the “Sensor Values” section are used for the “Internals” values calculations along with the “Parameters” selected.
- “Internals” calculation
- the graphs display.

### 5.3.4.1 Temp Configurations

Through the 'Mode' drop-down list in the Parameters section, the GUI offers 6 different options for supplying the temperature transducer wired to the ZSSC3281 pins:

- Sink, Internal Bias: the transducer (Diode/NTC/PTC) is supplied by an internal voltage source or by an internal configurable current source tied to the VSS rail (GND).

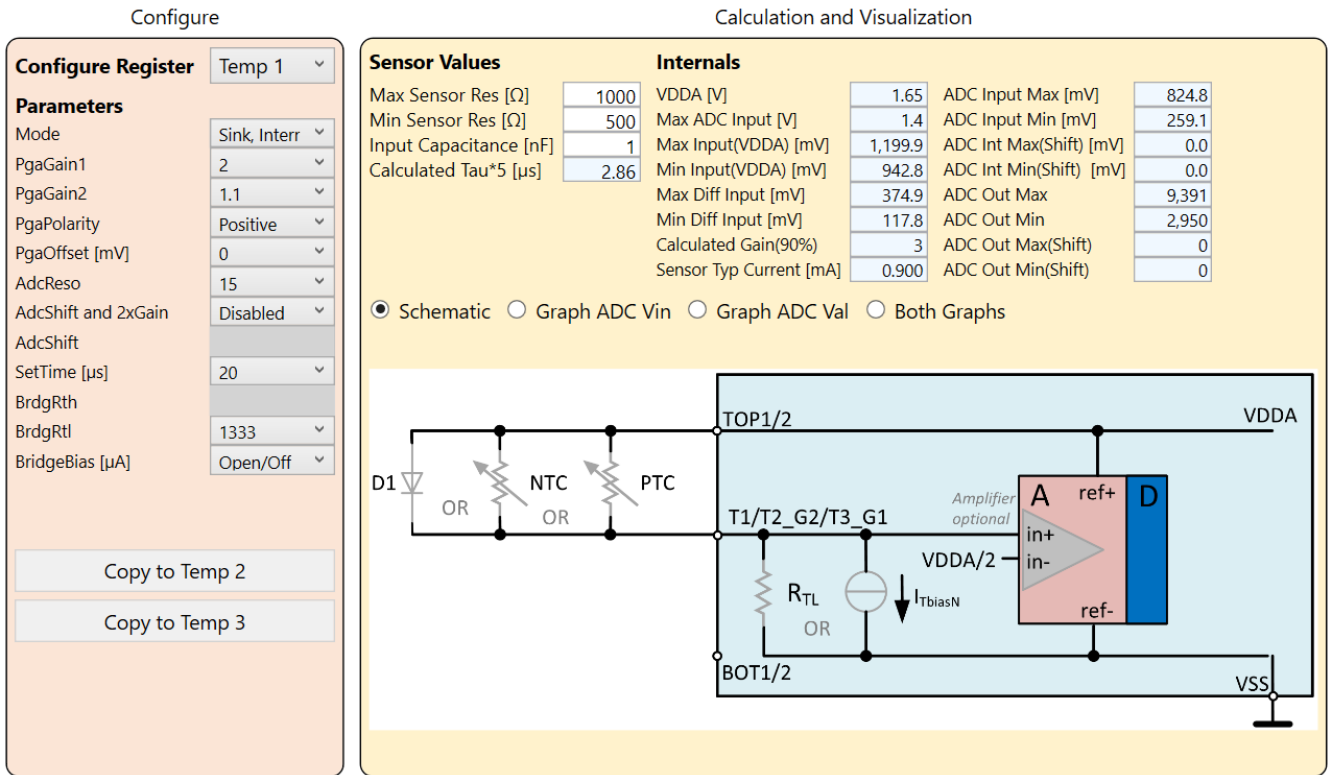

Figure 82. Temp – Mode Sink Internal Bias

- Source, Internal Bias: the transducer (Diode/NTC/PTC) is supplied by an internal voltage source or by an internal configurable current source tied to the VDDA rail (see the ZSSC3281 Datasheet document).

**Note:** this mode is used in this document for description/example purposes for the Temp tab, selecting other modes returns different schematic, graphs, and parameters enabling/disabling options.

Configure

**Configure Register** Temp 1

**Parameters**

Mode: Source, Int

PgaGain1: 2

PgaGain2: 1.1

PgaPolarity: Positive

PgaOffset [mV]: 0

AdcReso: 15

AdcShift and 2xGain: Disabled

AdcShift:

SetTime [μs]: 20

BrdgRth: 1333

BrdgRtl:

BridgeBias [μA]: Open/Off

Copy to Temp 2

Copy to Temp 3

Calculation and Visualization

<b>Sensor Values</b>		<b>Internals</b>	
Max Sensor Res [Ω]	1000	VDDA [V]	1.65
Min Sensor Res [Ω]	500	Max ADC Input [V]	1.4
Input Capacitance [nF]	1	Max Input(VDDA) [mV]	707.2
Calculated Tau*5 [μs]	2.86	Min Input(VDDA) [mV]	450.1
		Max Diff Input [mV]	-117.8
		Min Diff Input [mV]	-374.9
		Calculated Gain(90%)	-11
		Sensor Typ Current [mA]	0.900

ADC Input Max [mV]	-259.1
ADC Input Min [mV]	-824.8
ADC Int Max(Shift) [mV]	0.0
ADC Int Min(Shift) [mV]	0.0
ADC Out Max	-2,950
ADC Out Min	-9,391
ADC Out Max(Shift)	0
ADC Out Min(Shift)	0

Schematic
  Graph ADC Vin
  Graph ADC Val
  Both Graphs

Figure 83. Temp – Mode Source Internal Bias

- External Bias: the transducer is supplied with a voltage source from the following possible configuration:
  - The diode/NTC/PTC transducer is supplied through an external resistor tied to the VDDA rail (see the ZSSC3281 Datasheet document). This is active when the 'External RL' (selectable in the Sensor Values section) is not set to 'open' or '0'.

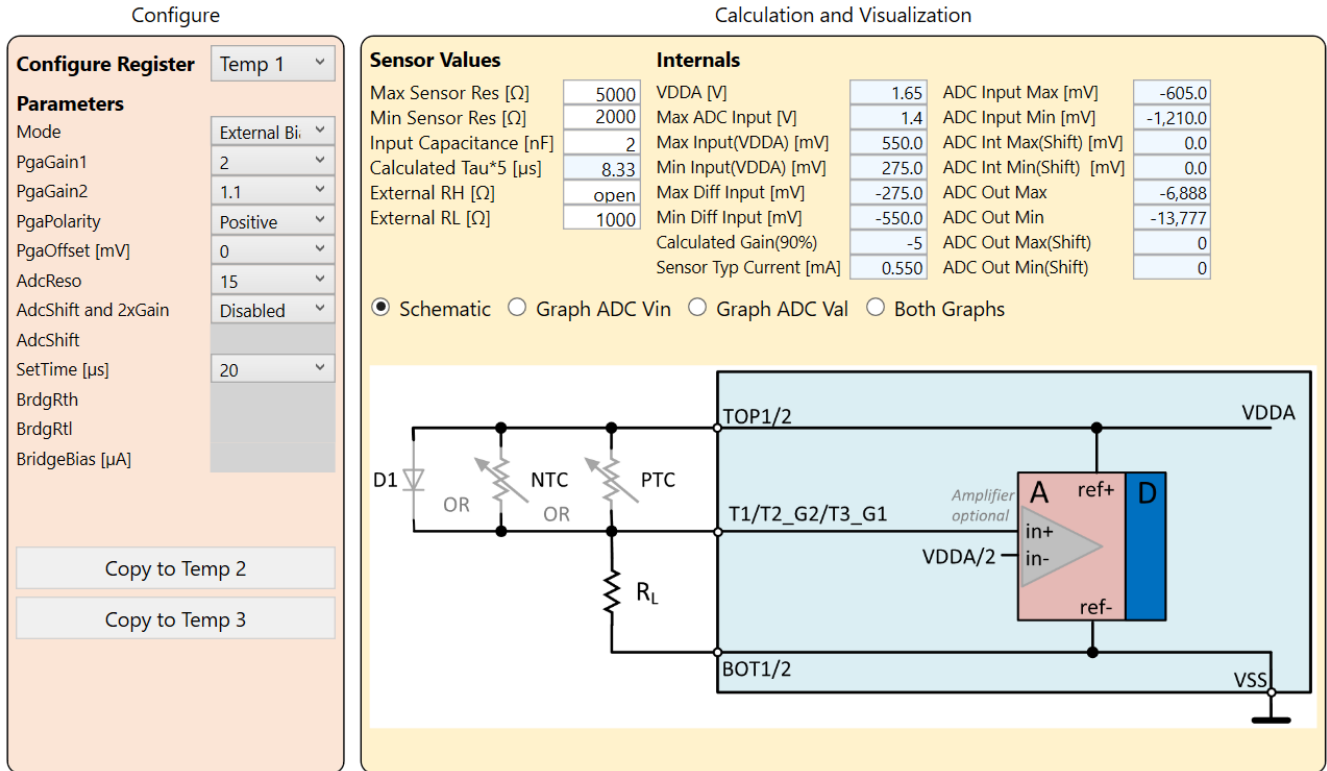

Figure 84. Mode Source External Bias Low



- The diode/NTC/PTC transducer is supplied through an external resistor tied to the VSS rail (GND) when the 'External RH' (selectable in the Sensor Values section) is not set to 'open' or '0'.

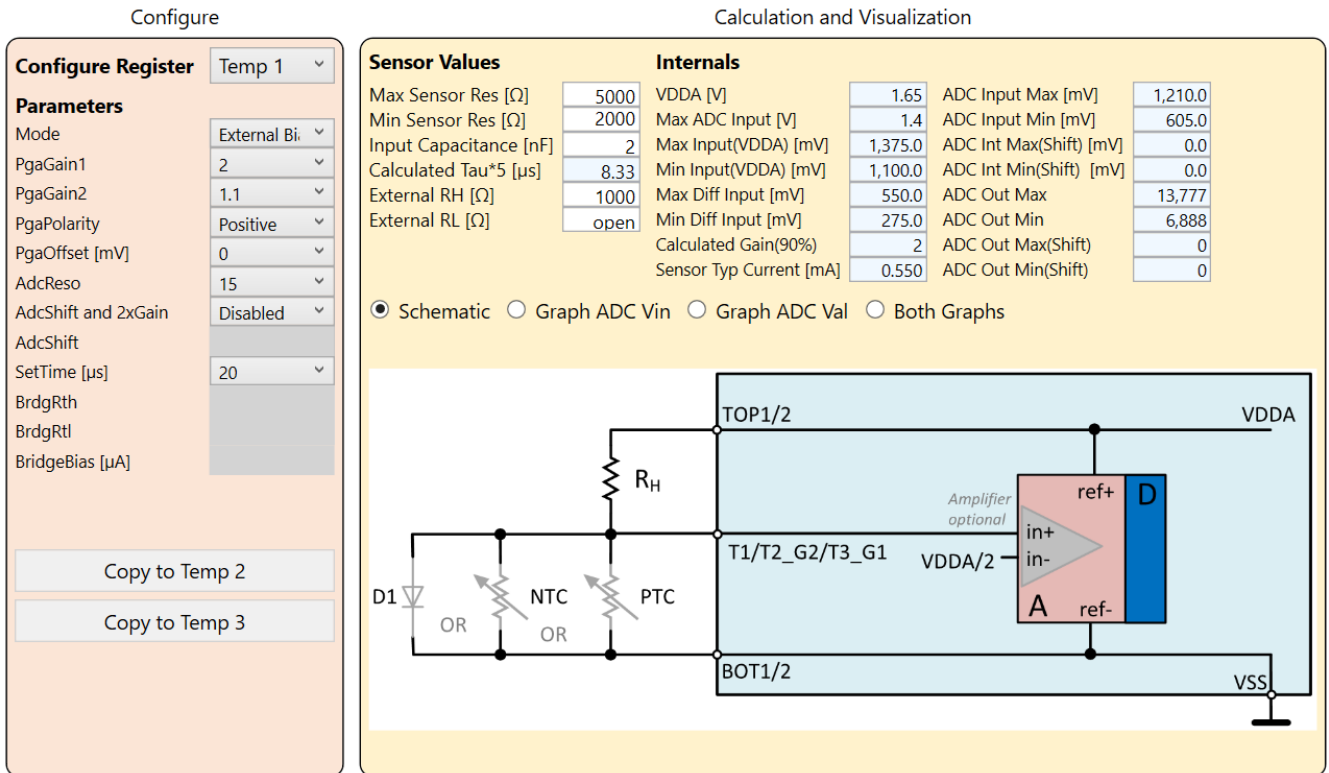

Figure 85. Mode Source External Bias High

To select between the options, put a non-zero value in the 'External RH' or 'External RL' (see Figure 86).

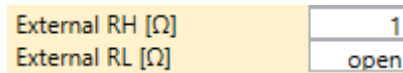

Figure 86. External RH, RL

- Bridge, Internal Bias: the resistive bridge (used for the main measurement) is supplied by an internal voltage source or by an internal configurable current source tied to the VDDA rail (see the ZSSC3281 Datasheet document).

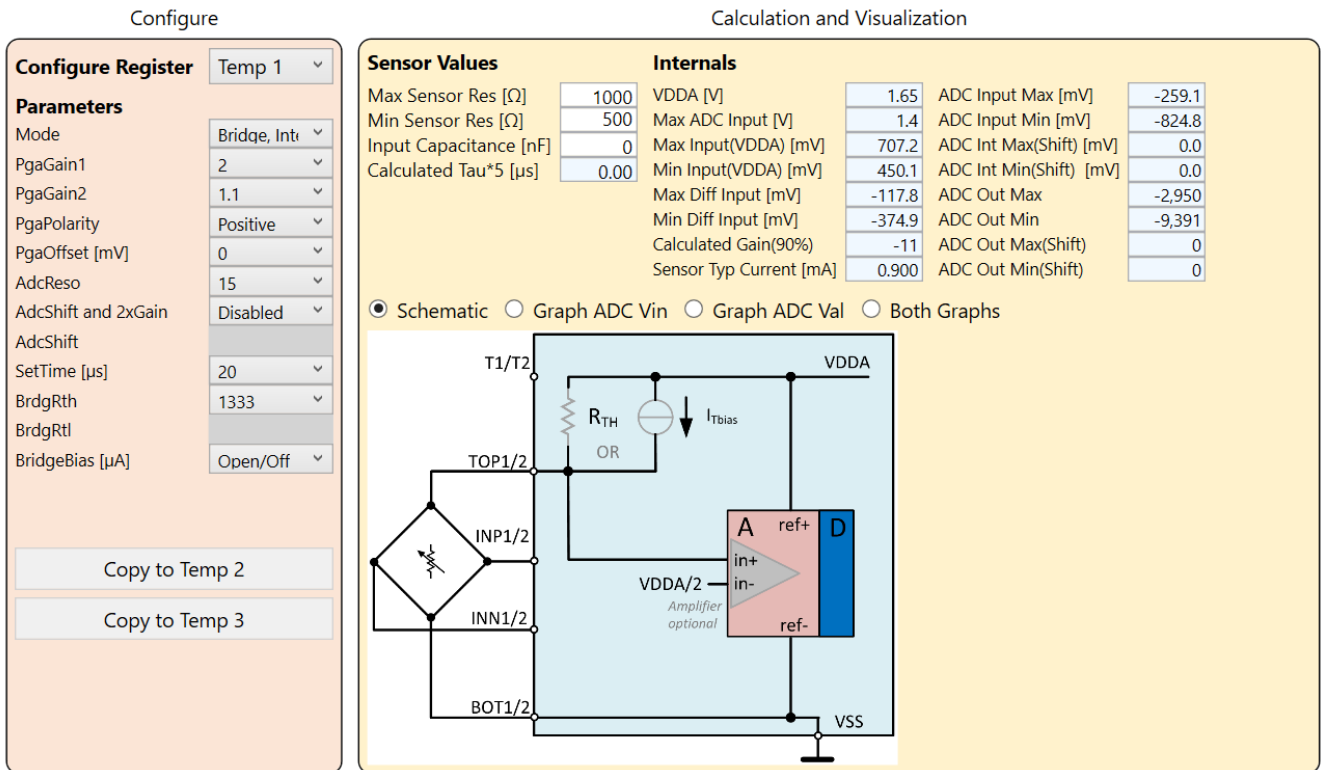

Figure 87. Mode Bridge Internal Bias

- Bridge, External Bias: the resistive bridge (used for the main measurement), is supplied by an internal voltage source through an external resistor (selectable by the 'External RH').

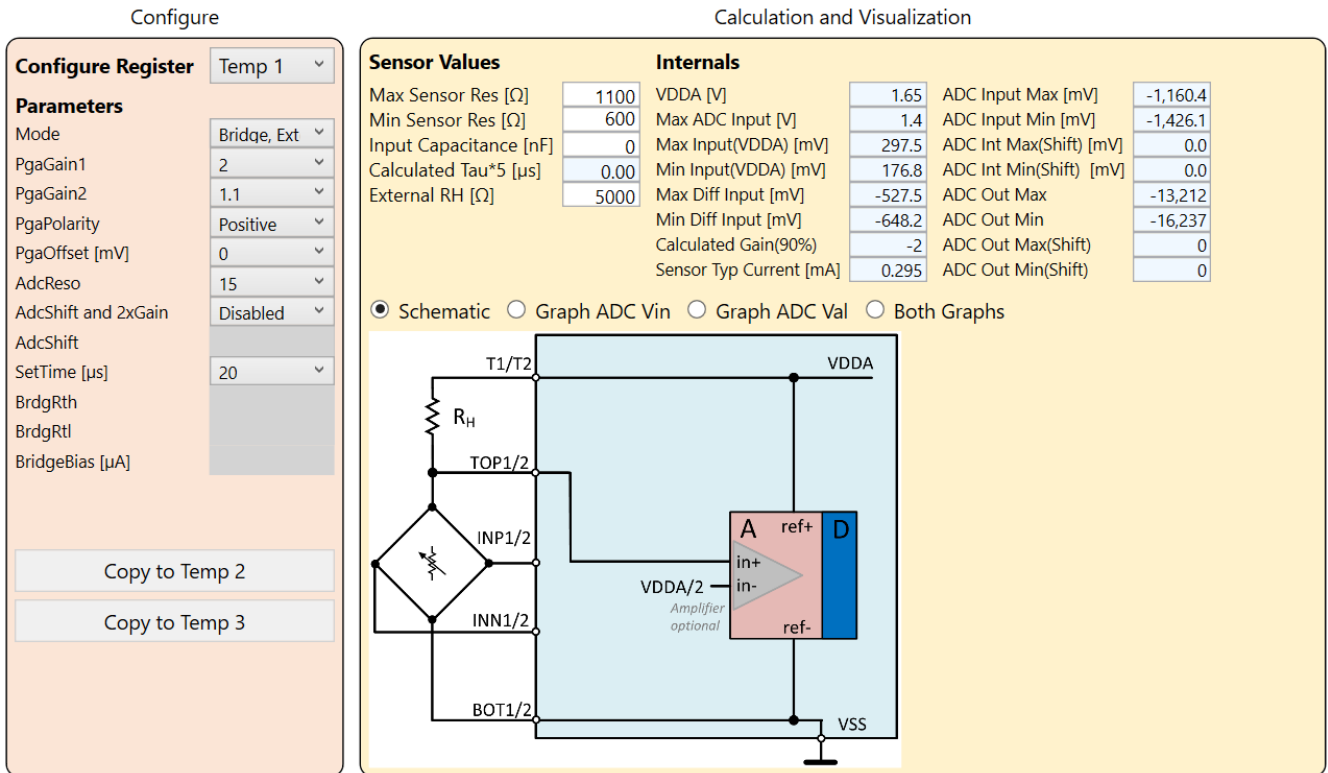

Figure 88. Mode Bridge External Bias

- Bridge, Differential: the resistive bridge (used for the main measurement) is supplied through an internal configurable resistors tied to the VDDA rail (RTH) and to VSS rail (RTL).

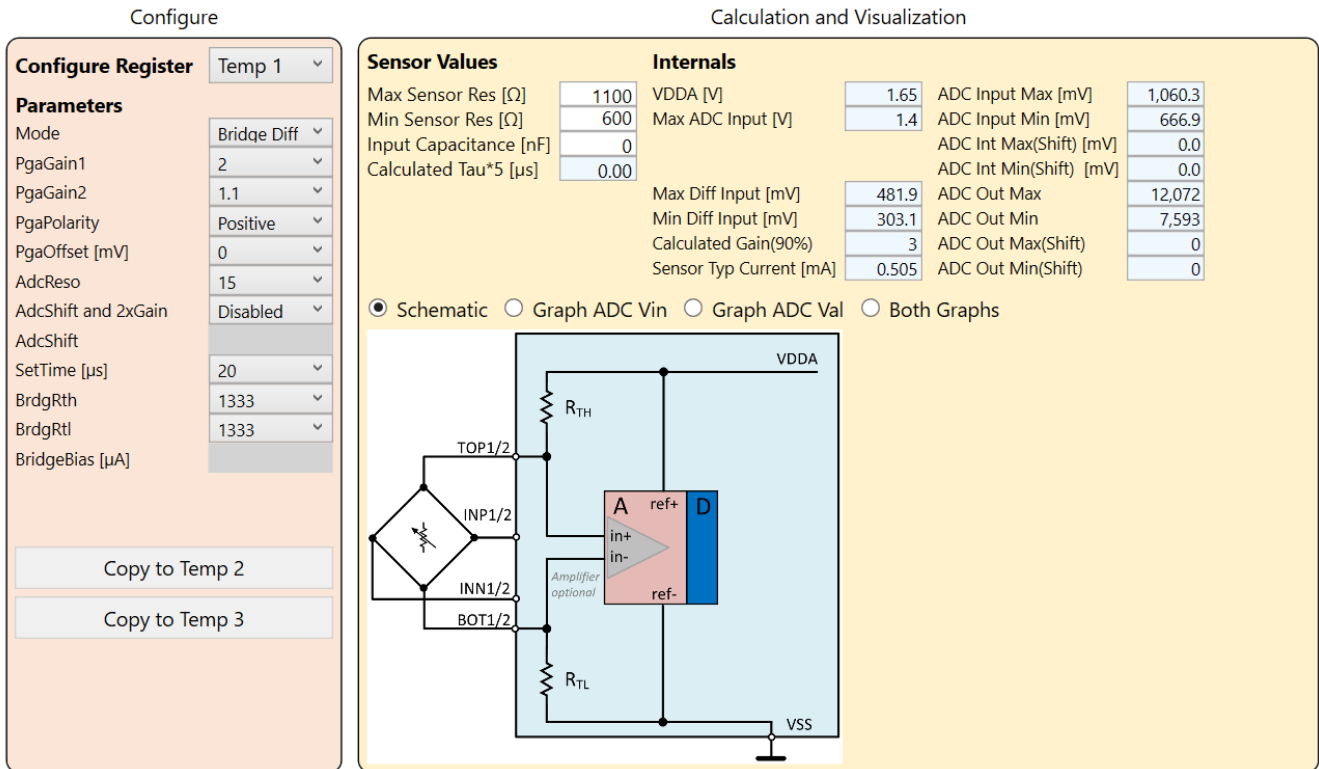

Figure 89. Mode Bridge Differential

### 5.3.4.2 Configure Register

To configure an external transducer input or the device internal temperature transducer input, select Temp1, Temp 2, Temp 3, or PTAT from the “Configure Register” drop-down list and set the relevant values in the Parameters section (see Figure 90).

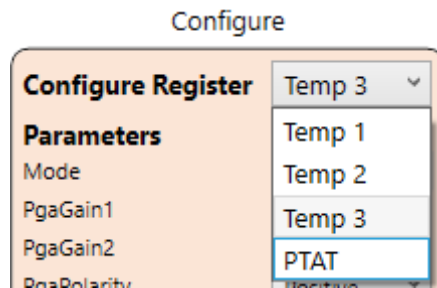

Figure 90. Configure Register

To duplicate an already defined configuration, click “Copy to Temp” button (see Figure 91).

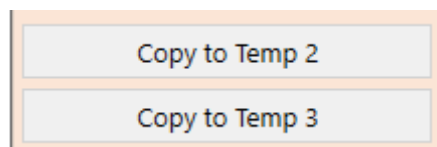

Figure 91. Copy to Temp

### 5.3.4.3 Sensor Values

This section (see Figure 92) allows the user to enter the input transducer characteristics for performing the calculations displayed in Figure 95.

Sensor Values	
Max Sensor Res [ $\Omega$ ]	1100
Min Sensor Res [ $\Omega$ ]	600
Sensor Typ Resistance [ $\Omega$ ]	750
Input Capacitance [nF]	0
Calculated Tau*5 [ $\mu$ s]	0.00

Figure 92. Temp– Sensor Values

The GUI SW calculates the Tau (Resistance x Capacitance) according to the inputs provided.

### 5.3.4.4 Parameters

The Parameters section (see Figure 93) defines the type of the transducer supply, the behavior of the analog signal path, and the ADC configuration. Specific parameters values enable or disable the availability of a set of additional parameters and the relevant list of available values.

The reference schematic in Figure 94 is dynamically updated according to the 'Mode' selection, see section 5.3.4.1 for details on different modes.

Parameters	
Mode	Bridge Diff ▾
PgaGain1	2 ▾
PgaGain2	1.1 ▾
PgaPolarity	Positive ▾
PgaOffset [mV]	0 ▾
AdcReso	15 ▾
AdcShift and 2xGain	Disabled ▾
AdcShift	
SetTime [ $\mu$ s]	20 ▾
BrdgRth	1333 ▾
BrdgRtl	1333 ▾
BridgeBias [ $\mu$ A]	

Figure 93. Parameters

The following parameters can be set:

- Mode: defines the type of supply scheme of the connected transducer, see section 5.3.4.1.
- PgaGain1: PGA gain stage 1 value
- PgaGain2: PGA gain stage 2 value
- PgaPolarity: Polarity inversion of the PGA input signal
- PgaOffset [mv]: PGA offset value (in mV)
- AdcReso: ADC resolution
- AdcShift and 2xGain: enable of the internal ADC 2x gain and internal ADC offset shift.
- AdcShift: ADC offset shift value
- SetTime [ $\mu$ s]: Bridge settling time ( $\mu$ s)

- BrdgRth: internal bridge resistor value (Ohm) upper side (Rth), this field is greyed out in the example configuration)
- BrdgRtl: internal bridge resistor value (Ohm) lower side (Rtl)
- BridgeBias [ $\mu$ A]: current level of transducer current driver ( $I_{Tbias}$ )

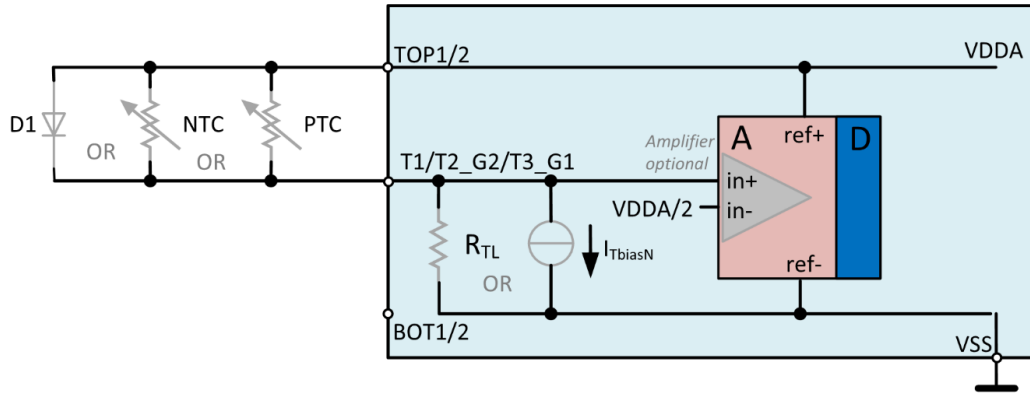

Figure 94. Temp – Schematic

### 5.3.4.5 Internals

The Internals section (see Figure 95) displays values of specific electrical parameters that are built in the device and calculated parameters after the values set as per sections 5.3.4.1, 5.3.4.2, 5.3.4.3, and 5.3.4.4.

Internals			
VDDA [V]	1.65	ADC Input Max [mV]	-347.6
Max ADC Input [V]	1.4	ADC Input Min [mV]	-1,376.5
Max Input(VDDA) [mV]	746.0	ADC Int Max(Shift) [mV]	0.0
Min Input(VDDA) [mV]	512.2	ADC Int Min(Shift) [mV]	0.0
Max Diff Input [mV]	-79.0	ADC Out Max	-3,958
Min Diff Input [mV]	-312.8	ADC Out Min	-15,672
Calculated Gain(90%)	-16	ADC Out Max(Shift)	0
Sensor Typ Current [mA]	0.854	ADC Out Min(Shift)	0

Figure 95. Internals

The following values are displayed:

- VDDA: analog supply typical level (silicon defined)
- Max ADC Input [V]: the maximum ADC input level (silicon defined)
- Max Input(VDDA) [mV]: maximum input pin level (referred to VDDA) in mV
- Min Input(VDDA) [mV]: minimum input pin level (referred to VDDA) in mV
- Max Diff Input [mV]: maximum differential input (in mV) at input pins
- Min Diff Input [mV]: minimum differential input (in mV) at input pins
- Calculated Gain(90%): suggested Gain setting to reach 90% FS
- Sensor Typ Current [mA]: typical current on transducer element (mA)
- ADC Input Max [mV]: ADC maximum input (input multiplied by Gain)
- ADC Input Min [mV]: ADC minimum input (input multiplied by Gain)
- ADC Int Max(Shift) [mV]: ADC maximum input (input multiplied by Gain and including shift)
- ADC Int Min(Shift) [mV]: ADC minimum input (input multiplied by Gain and including shift)
- ADC Out Max: ADC maximum output (counts)

- ADC Out Min: ADC minimum output (counts)
- ADC Out Max(Shift): ADC maximum output with ADC internal shift and 2x gain (counts)
- ADC Out Min(Shift): ADC minimum output with ADC internal shift and 2x gain (counts)

Out of range parameters or input values are highlighted in red, see Figure 96.

Internals			
VDDA [V]	1.65	ADC Input Max [mV]	-521.4
Max ADC Input [V]	1.4	ADC Input Min [mV]	-2,064.8
Max Input(VDDA) [mV]	746.0	ADC Int Max(Shift) [mV]	0.0
Min Input(VDDA) [mV]	512.2	ADC Int Min(Shift) [mV]	0.0
Max Diff Input [mV]	-79.0	ADC Out Max	-5,937
Min Diff Input [mV]	-312.8	ADC Out Min	-23,509
Calculated Gain(90%)	-16	ADC Out Max(Shift)	0
Sensor Typ Current [mA]	0.854	ADC Out Min(Shift)	0

Figure 96. Internals Out of Range

### 5.3.4.6 Schematic and Graphs

Select Schematic, Graph ADC Von, Graph ADC Val, or Graph Combined (Figure 97) to switch view among the reference circuit schematic, the input to ADC Voltage transfer characteristic graph, the ADC input voltage to ADC counts transfer characteristic, and a combined view of both graphs (see Figure 98).

- Schematic
  Graph ADC Vin
  Graph ADC Val
  Graph Combined

Figure 97. Schematic and Graphs Selection

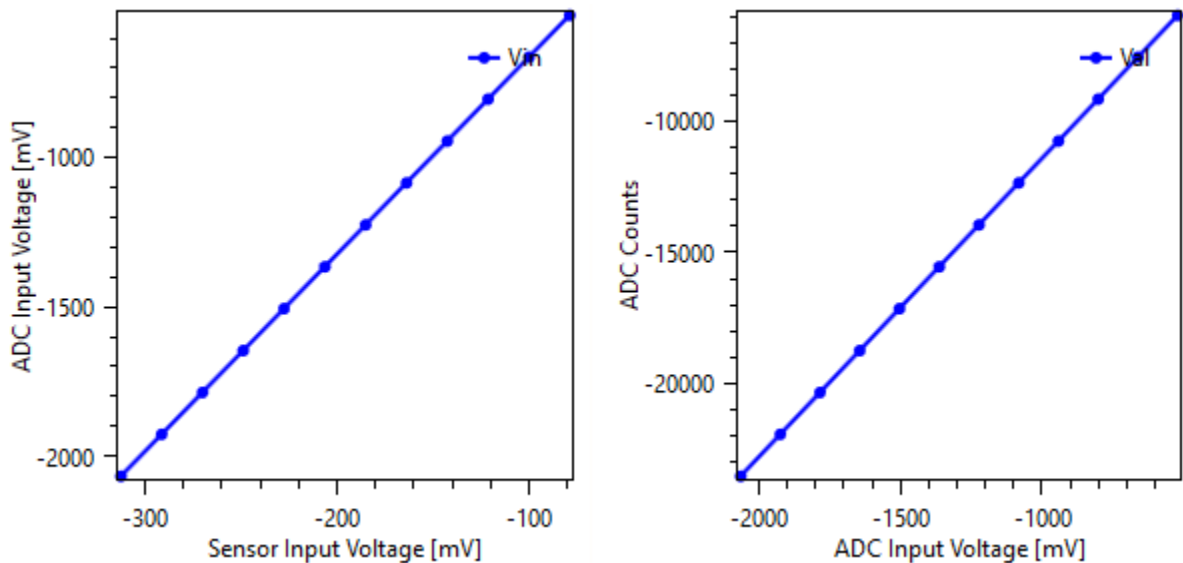

Figure 98. Combined Graphs

### 5.3.4.7 Configuration of the EVK for SRB Pt1000 reading

TCh1 is preconfigured to allow the use of the Pt1000 present on the SRB as temperature transducer.

Ensure the following HW settings are in place: EVB, J20 and J21 shorted; SRB SW1 in the left position, see Figure 99.

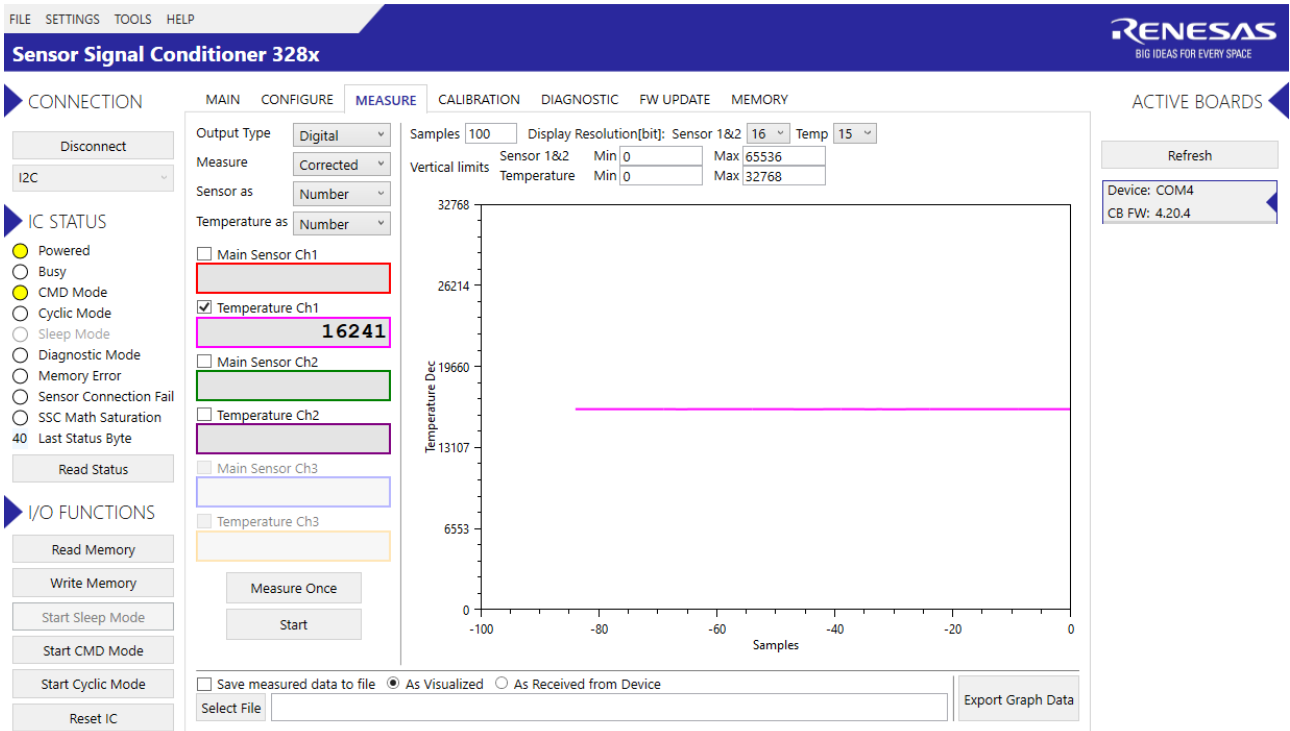

Figure 99. Pt1000 Measurements

For actual temperature measurement Tch1 requires calibration (the default calibration coefficients are set equal to “0”, with the exception of the TGain that has been set equal to “1”)

### 5.4 Third Logic Channel

The Third logic channel (see Figure 61) allows the processing of conditioned data from Sensor Channel 1 and Sensor Channel 2 according to the operation displayed in Figure 100.

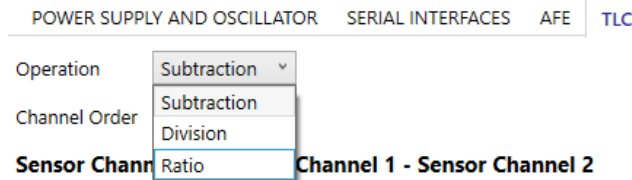

Figure 100. Third Logic Channel Operations

Select ‘Subtraction’ or ‘Division’ from the Operation drop-down list (see Figure 100), and ‘CH1 op CH2’ or ‘CH2 op CH1’ from the Channel Order drop-down list (see Figure 101).

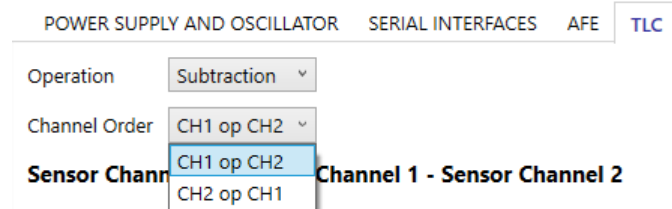

Figure 101. Third Logic Channel – Channel Order

The Third logic channel provides the user conditioned data only as there is no physical AFE associated with it. The relevant measurements are displayed in the Measure tab described in section 6.

Data provided by the ZSSC3281 are in a 4 bytes length so that the result of the division between the 2 sensor channels can be properly displayed.



### 5.4.1 Supported Mathematical Operations

#### Subtraction

The TLC must support the *subtraction* operation  $ch3 = ch1 - ch2$ .

The TLC must support the *subtraction* operation  $ch3 = ch2 - ch1$ .

#### Division

The TLC must support the *division* operation  $ch3 = ch1 / ch2$ .

The TLC must support the *division* operation  $ch3 = ch2 / ch1$ .

A division by zero or small number is handled as a math saturation.

#### Ratio

The TLC must support the *ratio* operation, which is defined as following (pseudo code):

IF  $ch1 == ch2$  THEN

$ch3 = 1$

ELSE IF  $ch1 < ch2$  THEN

$ch3 = ch1 / ch2$

ELSE

$ch3 = 2 - (ch2 / ch1)$

## 5.5 Output Scaling

The output scaling functionality allows the linear re-scaling of a reduced input range to the full input range. The functionality is useful when the input range is reduced but changing the AFE settings or performing a new calibration to reach the full output range is not an option.

The functionality is available for the 2 main sensor channels (1 and 2) but not for the remaining channels (T1/2/3 and CH3).

The output scaling functionality acts downstream when the input is conditioned by the SSC math (section 7) and upstream when the application of the (IIR) has filtering function (section 5.9).

The Output scaling tab is displayed in Figure 102.

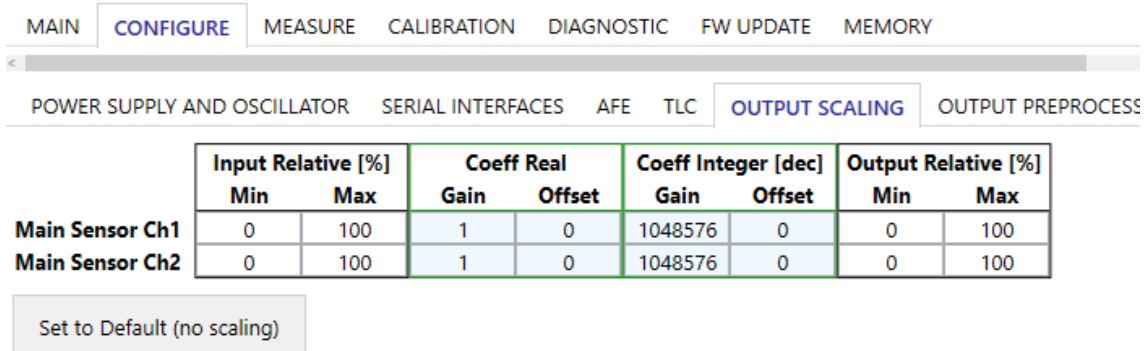

Figure 102. Output Scaling

The Input Relative [%] and Output Relative [%] fields are editable, the GUI calculates the offset and gain coefficients.

Click the 'Set to Default (no scaling)' to have the default input/output values (see Figure 103).

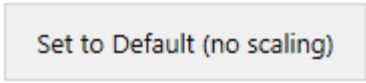

Figure 103. Back to Defaults

Output Scaling Example

For this example, it is assumed that the actual input returning an output swing from 50% to 100% of the full scale (see Figure 104).

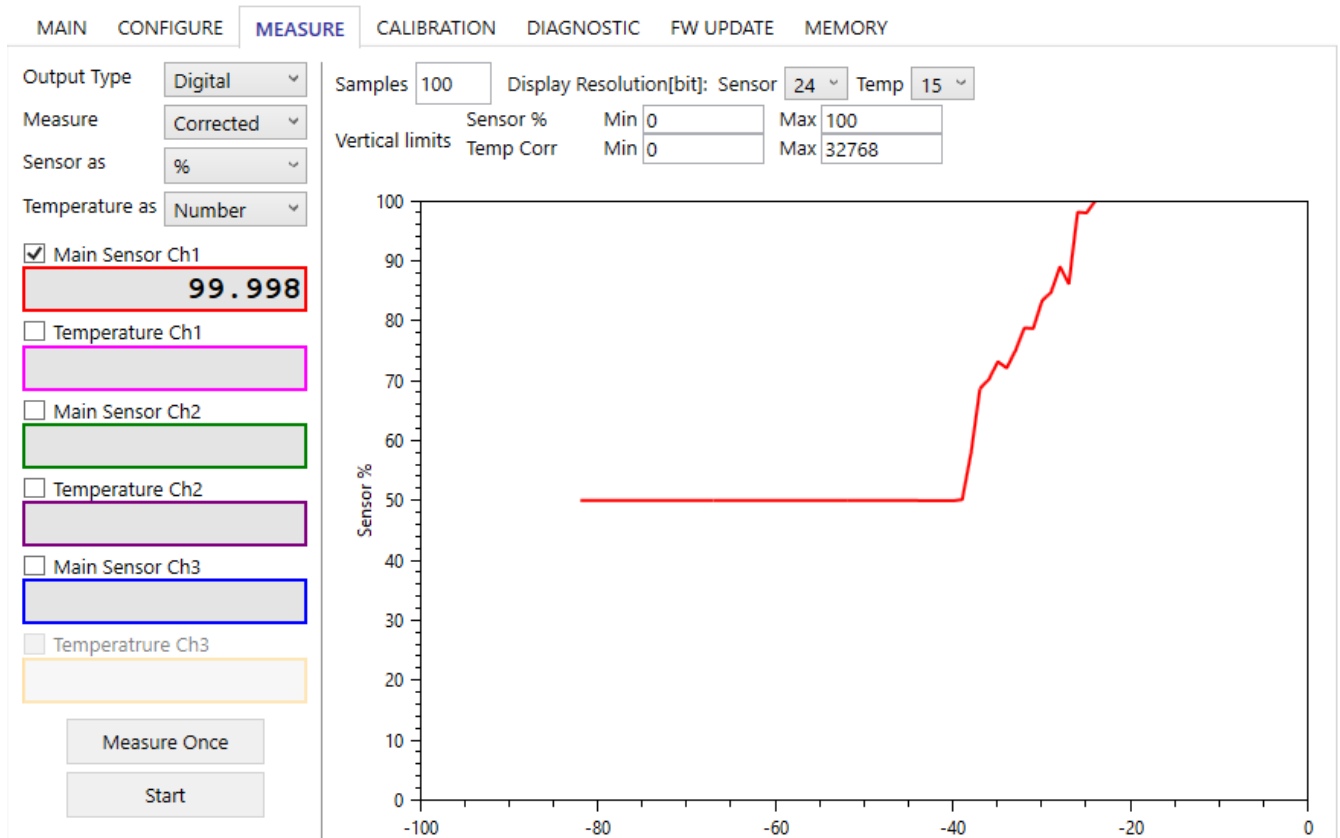

Figure 104. 50% to 100% Output

In the example, main sensor Ch1 has to return as full-scale output without changing calibration or AFE setup using the Output scaling. The current full-scale signal (%) and the output desired full scale signal (%) input is set (see Figure 105).

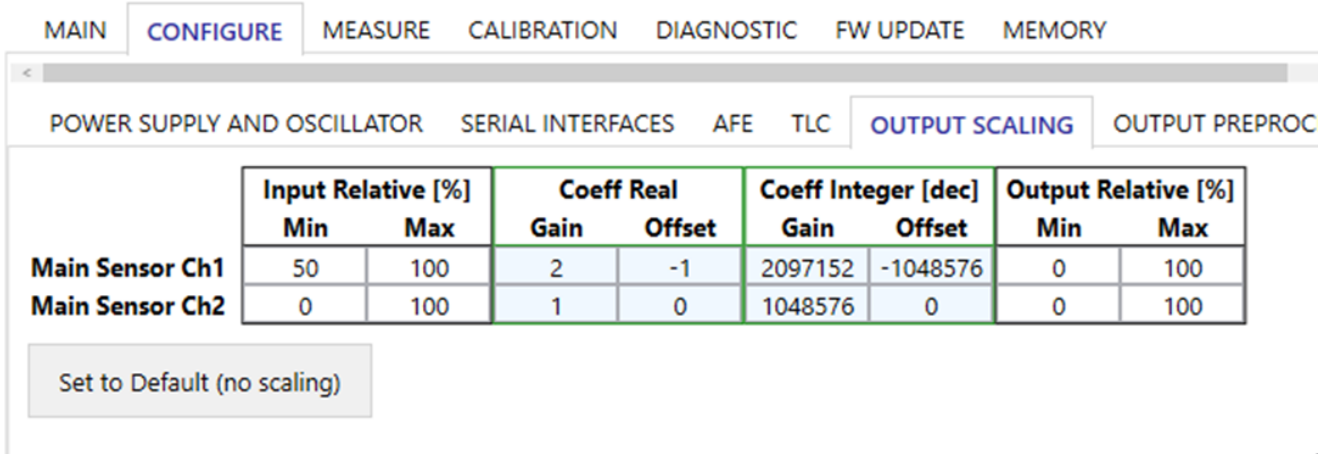

Figure 105. Coefficients for 0% to 100% Output

The GUI automatically calculates the scaling coefficients to be applied and displays them in the Coeff Real and Coeff Integer [dec] fields of Figure 105. To have the Output to operate the 0% to 100% full scale, a memory write needs to be performed so that scaling coefficients are saved in NVM.

The measurements after applying the coefficients in Figure 105 return the expected swing as displayed in Figure 106

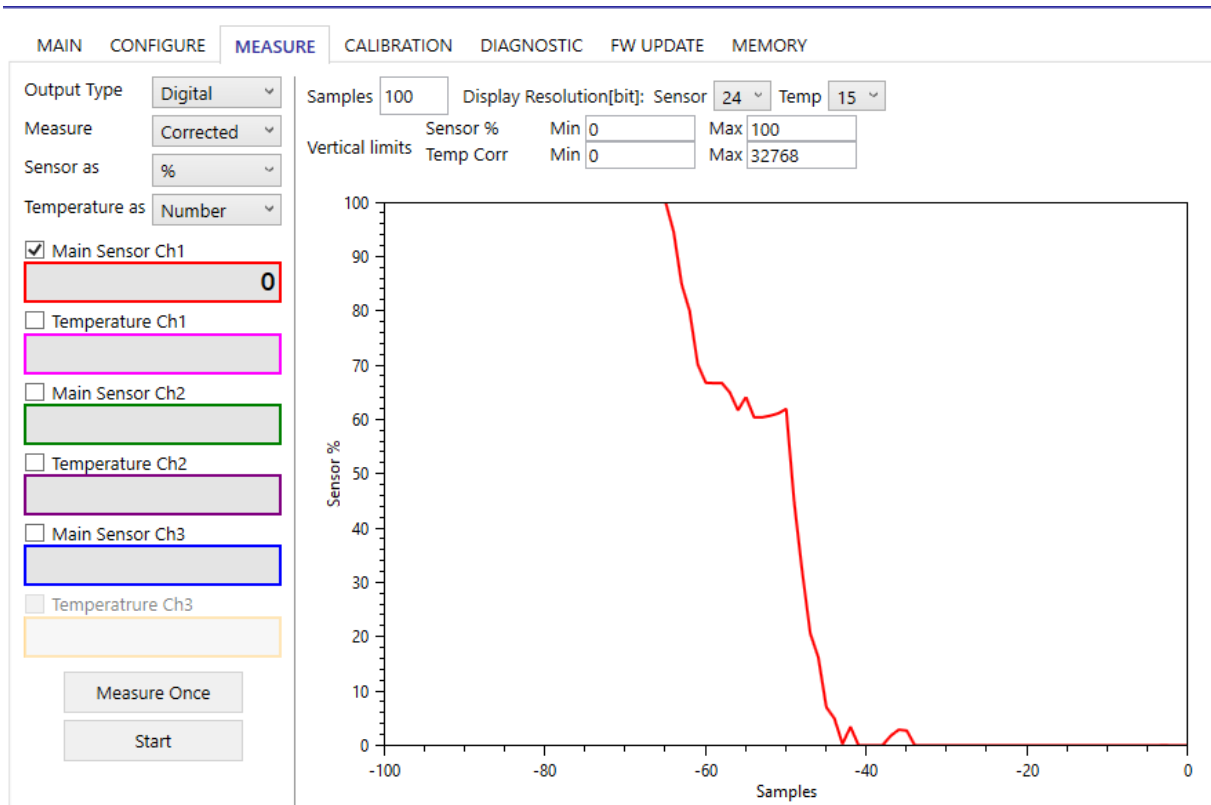

Figure 106. 0% to 100% Output

## 5.6 Output Preprocessing

The output preprocessing allows to apply a two thresholds clipping function on the AOUT and FOUT signals.

The clipping function is applied after the measured signal is corrected and not visible on the digital values displayed in Measure tab.

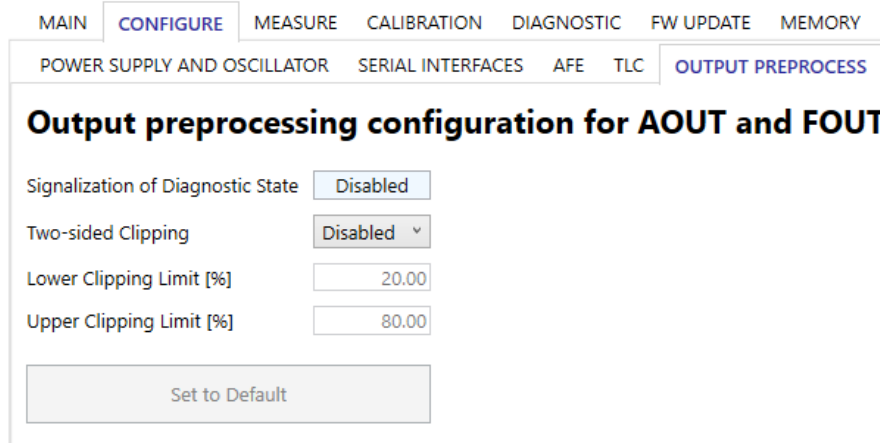

Figure 107. Output Pre-Processing Defaults

The signalization of the diagnostic state reflects the settings defined in the Diagnostic tab (refer to section 8).

When the clipping is enabled, the 'Lower Clipping Limit [%]' and 'Lower Clipping Limit [%]' fields are editable (see Figure 108).

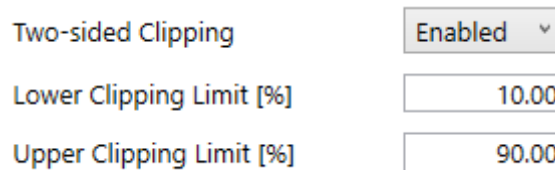

Figure 108. Clipping Limits

Store the settings in NVM to have the clipping functionality operational on measured input.

## 5.7 DOUT

Modulated signals can be output on the dedicated pins (refer to *ZSSC3281 Datasheet* document), options can be set in the DOUT tab, see Figure 109.

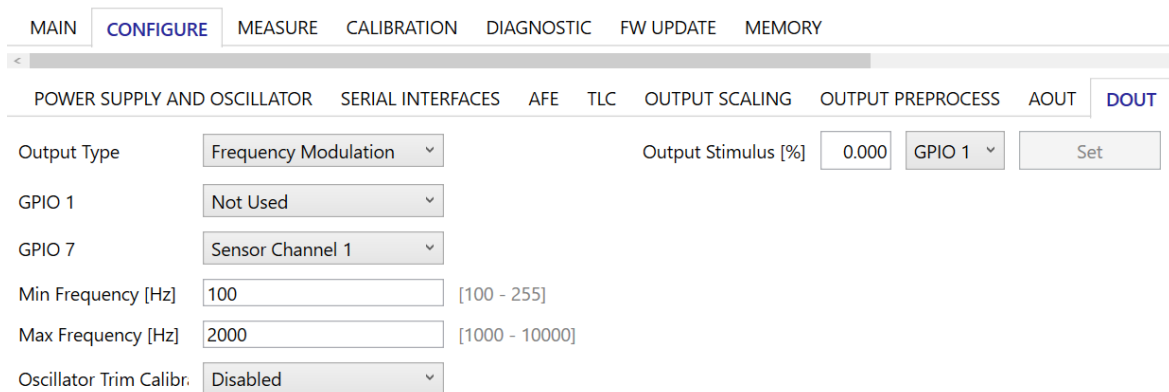

Figure 109. DOUT

### 5.7.1 Output Type

The following options are available for the modulation (see Figure 110):

- No Output Modulation
- Frequency Modulation
- Pulse Width Modulation

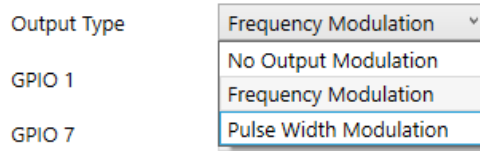

Figure 110. Configure – DOUT – Output Type

### 5.7.2 GPIOs

Any active channels can be associated to GPIO 1 and GPIO 7, see Figure 111.

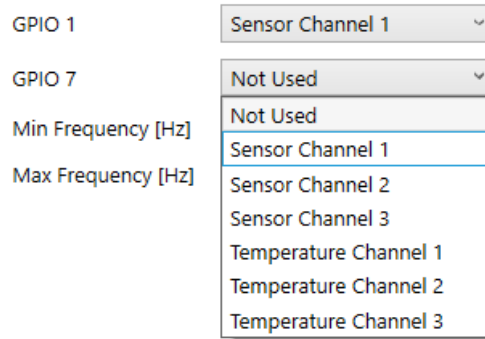

Figure 111. DOUT - GPIOs

### 5.7.3 FOUT - Frequency

The frequency range limits are defined with the Min Frequency [Hz] and Max Frequency [Hz] fields, see Figure 112.



Figure 112. Configure – DOUT – Frequency Range

### 5.7.4 Oscillator Trim Calibration

With the Oscillator Trim Calibration the frequency output can be calibrated over temperature. We recommend doing that if no external clock is used.

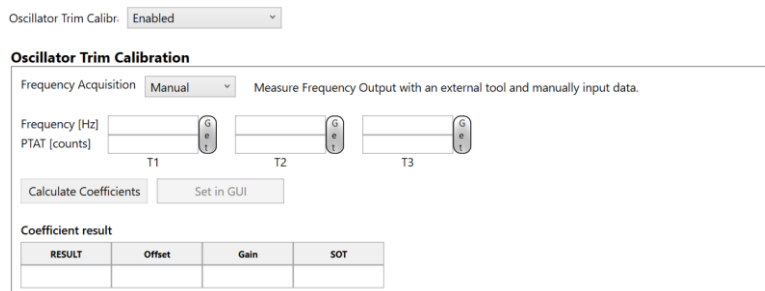

Figure 113. Oscillator Trim Calibration

**Note:** PTAT must be enabled and mapped to a Temperature Channel!

### 5.7.5 PWM - Mapping

The mapping selection allows the user to select the maximum and minimum of the duty cycle associated to the High and Low voltage levels on the output pin.

Example:

- if Max = %100, when the output stimulus is set to 100%, the output will be at steady High level.
- If Max = %0, when the output stimulus is set to 100%, the output will be at steady Low level.

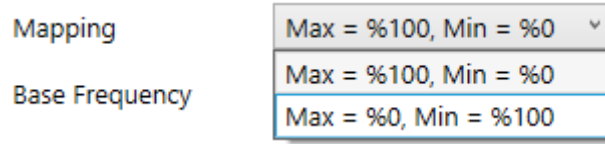

Figure 114. Configure – PWM– Mapping

### 5.7.6 PWM – Base Frequency

The base frequency selection allows to select the base frequency of the PWM output from 200Hz to 15kHz.

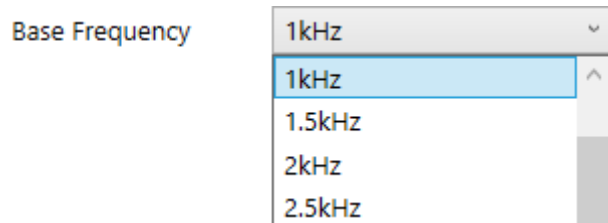

Figure 115. Configure – PWM – Base Frequency

### 5.7.7 Output Stimulus

To drive a GPIO directly, set the fixed output level in the ‘Output Stimulus [%]’ field and click the ‘Set’ button (see Figure 116).

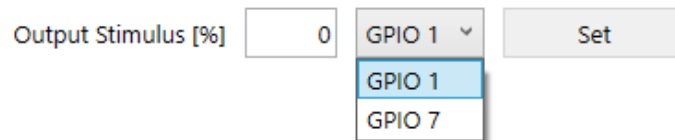

Figure 116. Configure – DOUT- Direct Setting

Store the settings in NVM to have the DOUT functionality operational on measured input.

## 5.8 AOUT

From the AOUT Pin Mapping menu select the channel to be output as analog output. In Figure 117 'Sensor Channel 1' is selected, refer to section 5.8.2 for additional details.

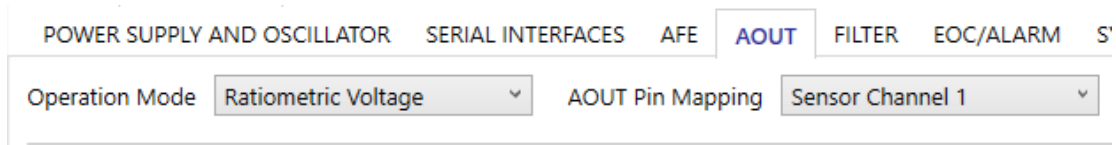

Figure 117. AOUT mapping

### 5.8.1 Output Operation Mode

See Figure 118 for the analog output options. The available options require specific EVB jumper configuration.

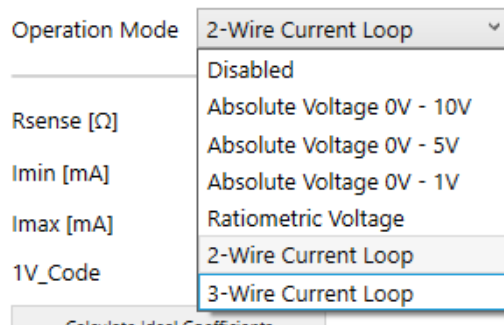

Figure 118. AOUT – Operation Mode

#### 5.8.1.1 Operation Mode: Absolute Voltage 0V - 10V

Selecting this option automatically sets the proper device power supply configuration, see Figure 119.

**Note:** ensure the device is supplied by the 12V rail from the CB as described in section 0

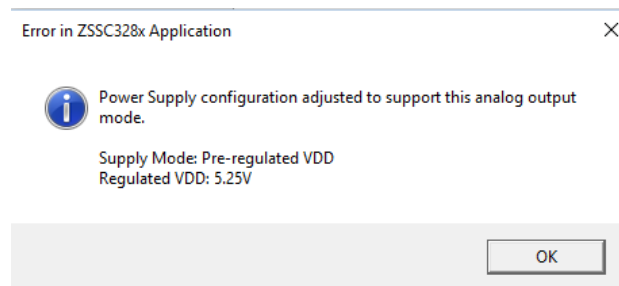

Figure 119. AOUT Power Supply

The following jumper settings are needed to operate in this configuration:

- J11: short pins 1-2
- J6: short
- J28: short
- J9: short
- J12: short
- J10: short pins 2-3 (Set the external operational amplifier U2 gain equal to 2)
- J8: short (allows the GUI to visualize the AOUT pin signal only, the 0V to 10V signal is present on J10)

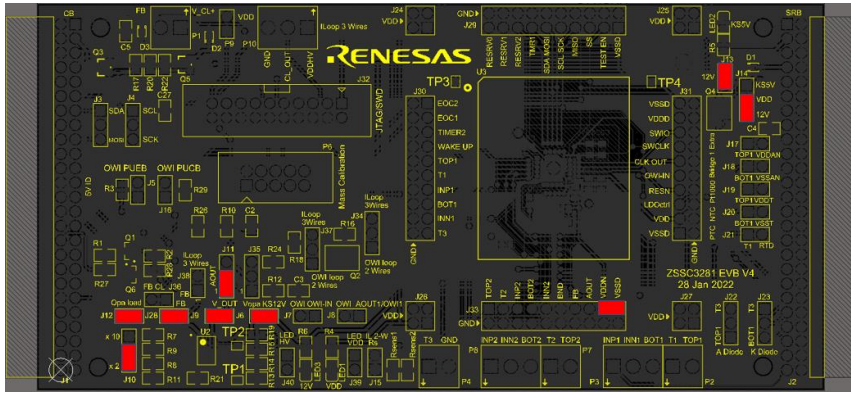

Figure 120. Absolute Voltage 0V-10V - Jumpers

**Note:** before starting the measurement with the “Start” button (see Figure 121), it is necessary to save configuration in NVM (by the “Write Memory” button in the GUI main tab) and to make sure the output is present on J10 pin 2-3.

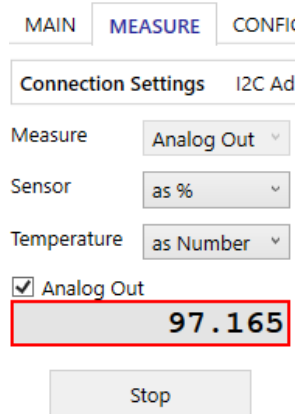

Figure 121. AOUT — Measure

See Figure 122 for the Absolute Voltage 0V - 10V parameters configuration tab.



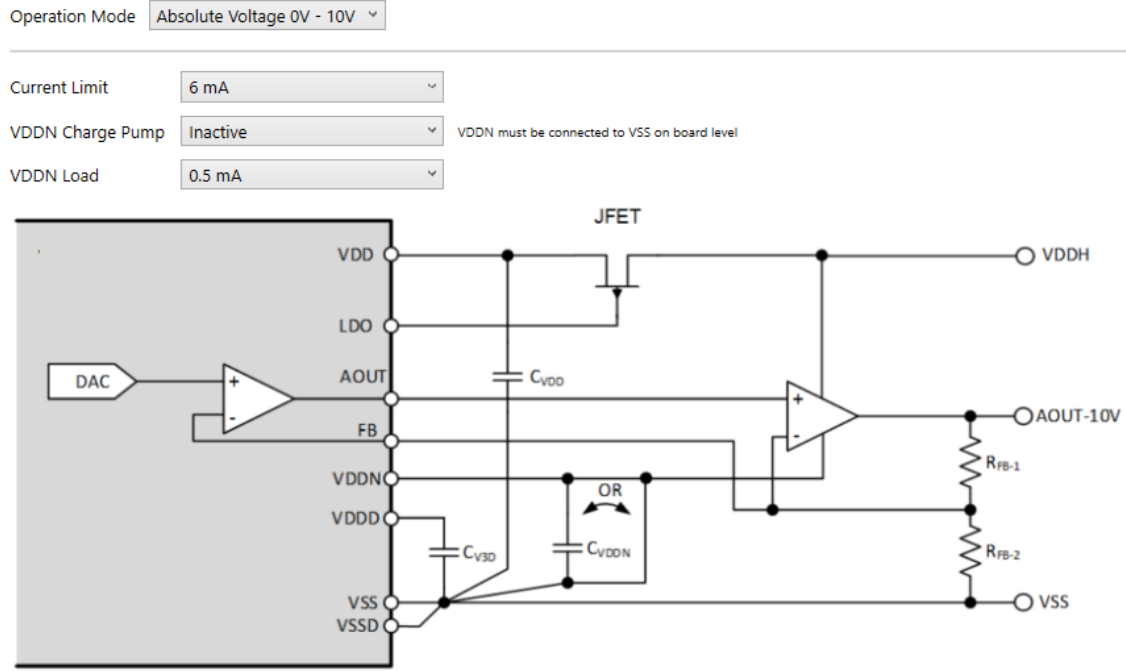

Figure 122. Absolute Voltage 0V - 10V Configuration

Parameters description:

- Current Limit: defines short circuit output current limitation of AOUT Buffer. Typical current limit is selectable.
- VDDN Charge Pump: to support the driving of true 0V at AOUT, an internal charge pump can be activated which generates a negative voltage of approximately -0.6V at the VDDN pin. In this application scenario the otherwise required external short connection between VDDN and VSS must be opened and the external capacitor  $C_{VDDN}$  must be connected between VDDN and VSS.
- VDDN Load: the maximum output drive current of the VDDN charge pump can be configured. The higher the set output drive current, the higher the quiescent current of the ZSSC3281.

### 5.8.1.2 Operation Mode: Absolute Voltage 0V - 5V

For operating in this configuration, remove specific jumpers setup described in 5.8.1.1, no additional jumpers setting on the EVB is needed.

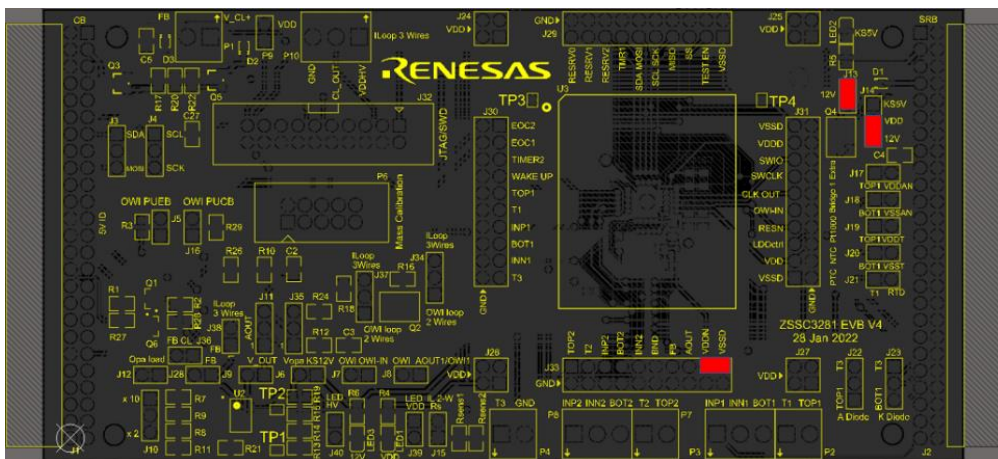

Figure 123. Absolute Voltage 0V-5V - Jumpers

See Figure 124 for the Absolute Voltage 0V - 5V parameters configuration tab.

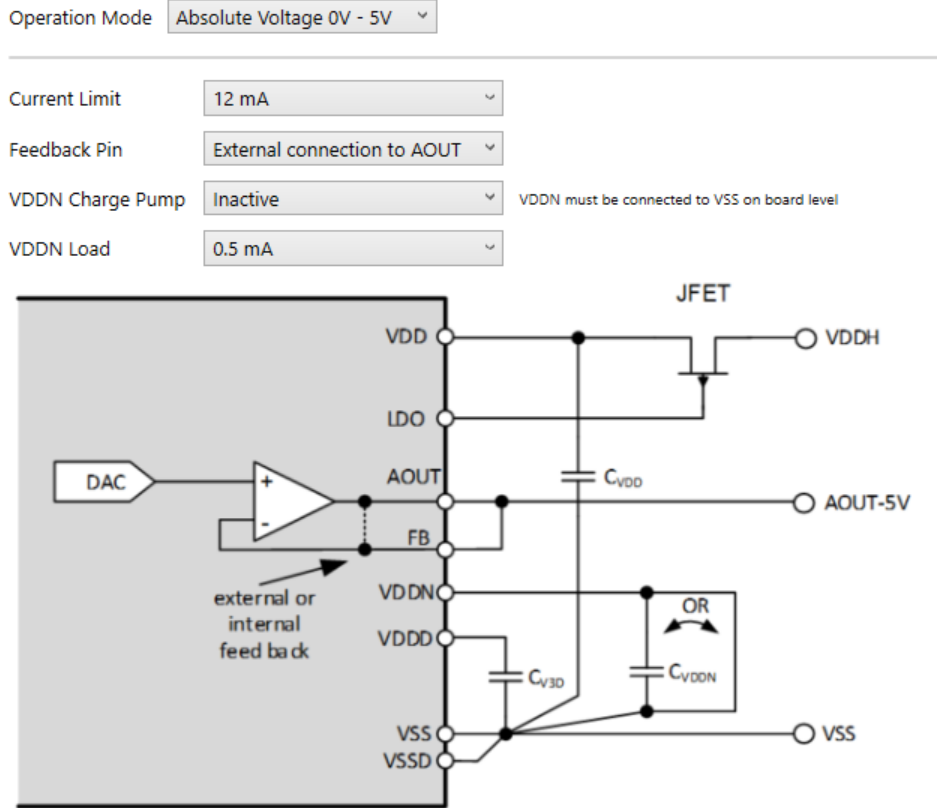

Figure 124. Absolute Voltage 0V-5V Configuration

Parameter's description:

- Current Limit: defines short circuit output current limitation of AOUT Buffer. Typical current limit is selectable.
- Feedback Pin: defines if the FB pin needs to be connected to AOUT externally, or if it is connected to AOUT internally.
- VDDN Charge Pump: to support the driving of true 0V at AOUT, an internal charge pump can be activated which generates a negative voltage of approximately -0.6V at the VDDN pin. In this application scenario the otherwise required external short connection between VDDN and VSS must be opened and the external capacitor  $C_{VDDN}$  must be connected between VDDN and VSS.
- VDDN Load: the maximum output drive current of the VDDN charge pump can be configured. The higher the set output drive current, the higher the quiescent current of the ZSSC3281.

**Note:** before starting the measurement with the “Start” button, it is necessary to save configuration in NVM (by the “Write Memory” button in the GUI main tab), to reset the device, and to make sure the output is present on J8 pin 1-2 shorted.

5.8.1.3 Operation Mode: Absolute Voltage 0V - 1V

For operating in this configuration, remove specific jumpers setup described in 5.8.1.1 and 5.8.1.2, no additional jumpers setting on the EVB is needed.

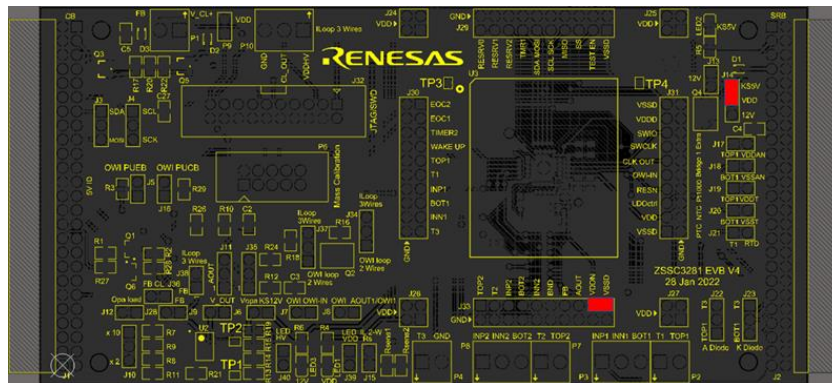

Figure 125. Absolute Voltage 0V-1V - Jumpers

See Figure 126 for the Absolute Voltage 0V - 1V parameters configuration tab.

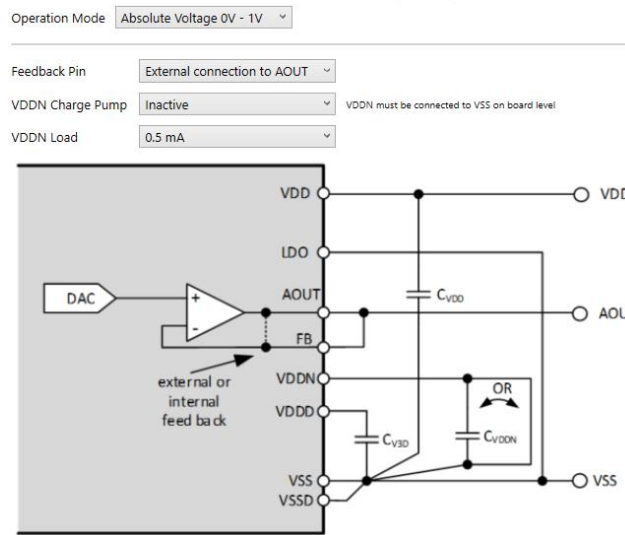

Figure 126. Absolute Voltage 0V to 1V Configuration

Parameters description:

- Feedback Pin: defines if the FB pin needs to be connected to AOUT externally, or if it is connected to AOUT internally.
- VDDN Charge Pump: to support the driving of true 0V at AOUT, an internal charge pump can be activated which generates a negative voltage of approximately -0.6V at the VDDN pin. In this application scenario the otherwise required external short connection between VDDN and VSS must be opened and the external capacitor  $C_{VDDN}$  must be connected between VDDN and VSS.
- VDDN Load: the maximum output drive current of the VDDN charge pump can be configured. The higher the set output drive current, the higher the quiescent current of the ZSSC3281.

**Note:** before starting the measurement with the “Start” button, it is necessary to save configuration in NVM (by the “Write Memory” button in the GUI main tab), to reset the device, and to make sure the output is present on J8 pin 1-2 shorted.

5.8.1.4 Operation Mode: Ratiometric Voltage

For operating in this configuration, remove specific jumpers setup described in 5.8.1.1 or 5.8.1.2 or 5.8.1.3, no additional jumpers setting on the EVB is needed.

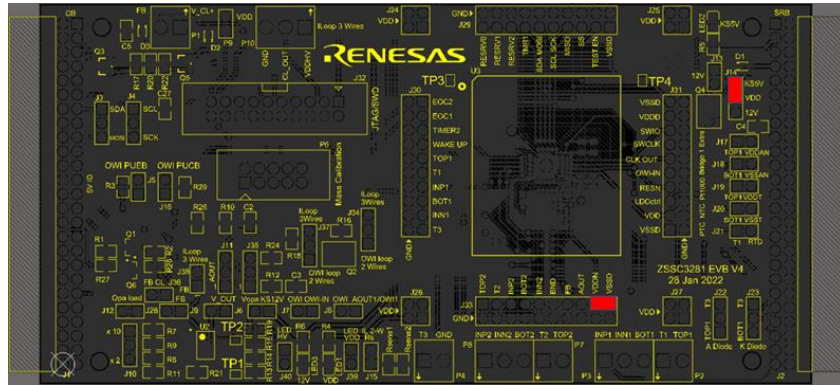

Figure 127. Ratiometric Voltage Jumpers

See Figure 128 for the Ratiometric Voltage parameters configuration tab.

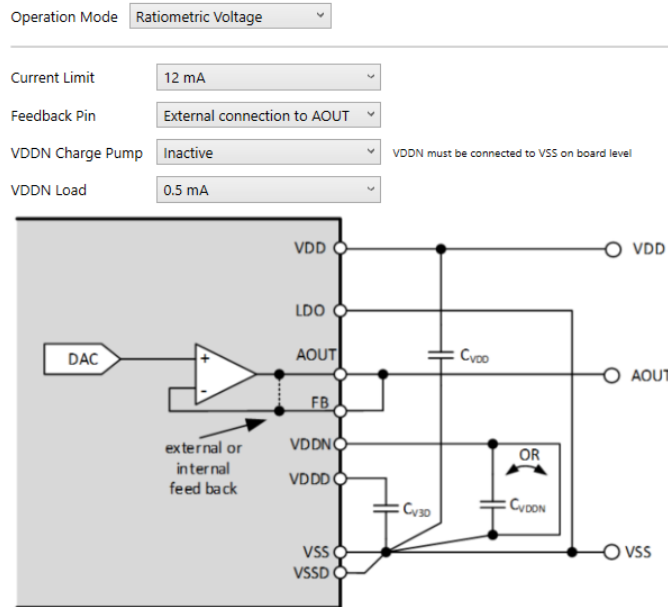

Figure 128. Ratiometric Voltage Configuration

Parameter's description:

- Current Limit: defines short circuit output current limitation of AOUT Buffer. Typical current limit is selectable.
- Feedback Pin: defines if the FB pin needs to be connected to AOUT externally, or if it is connected to AOUT internally.
- VDDN Charge Pump: to support the driving of true 0V at AOUT, an internal charge pump can be activated which generates a negative voltage of approximately -0.6V at the VDDN pin. In this application scenario the otherwise required external short connection between VDDN and VSS must be opened and the external capacitor  $C_{VDDN}$  must be connected between VDDN and VSS.
- VDDN Load: the maximum output drive current of the VDDN charge pump can be configured. The higher the set output drive current, the higher the quiescent current of the ZSSC3281.

**Note:** before starting the measurement with the “Start” button, it is necessary to save configuration in NVM (by the “Write Memory” button in the GUI main tab), and to make sure the ratiometric output is present on J8 pin 1-2 shorted.

5.8.1.5 Operation Mode: 2-Wire Current Loop

For operating in this configuration, remove specific jumpers setup described in 5.8.1.1, 5.8.1.2, 5.8.1.3, or 5.8.1.7 and set the jumpers as the following:

- J11: short 2-3
- J35: short 1-2
- J37: short 1-2
- J34: short 1-2
- J15: short
- J14: short 2-3
- Ensure that VDDN is shorted to GND (J33) as displayed in Figure 129.

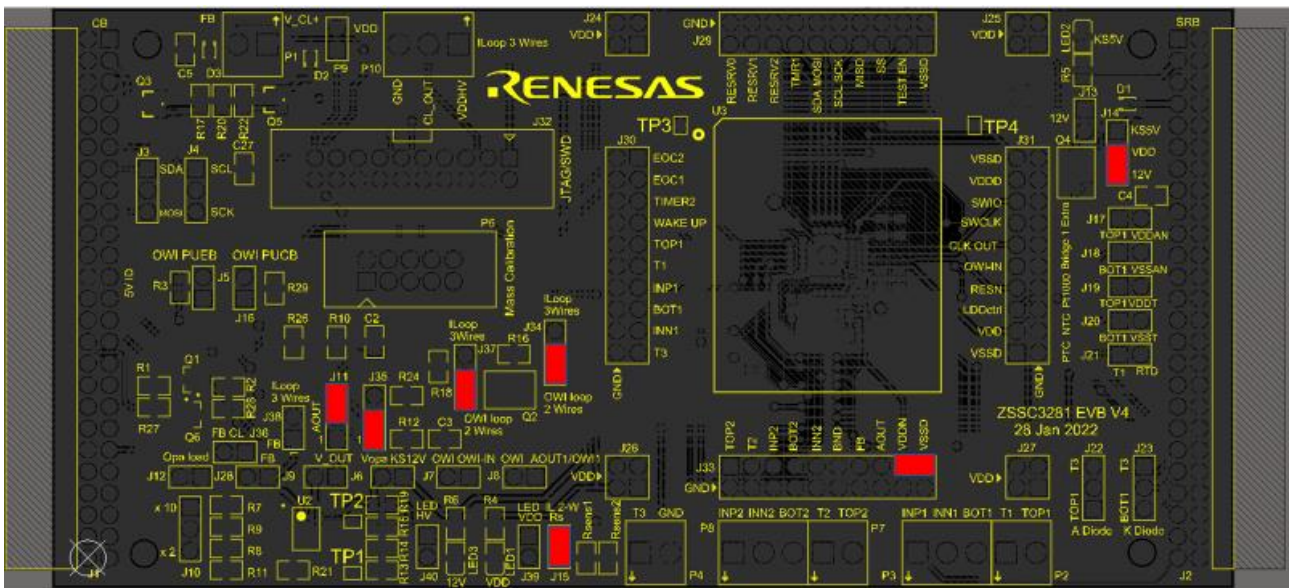

Figure 129. 2-Wire Current Loop Jumpers

For the ZSSC3281EVV version V3 or older, unsolder R4.

When using the SRB3 sensor replacement board to operate the 2-wire current loop, ensure that resistor R1 and R3 are not soldered on the board (see Figure 130).

OPEN



Figure 130. 2-Wire Current Loop SRB3 Specific Configuration

For testing purposes, the power supply of the current loop can be 24V applied to the connector P1. A current meter (for measuring purposes) needs to be connected between in series with the loop power supply (high side).

Selecting 2-Wire Current Loop option automatically set the proper device power supply configuration, see Figure 119.

Ensure the sequencer has one AFE enabled (for example, AFE1) as per Figure 131.

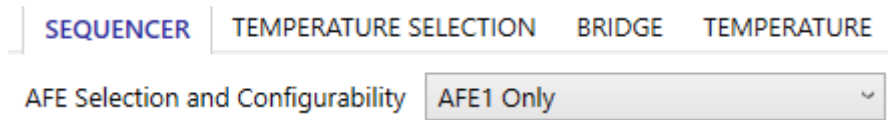

Figure 131. 2-Wire Current Loop Single AFE Active

Ensure the Power Supply and Oscillator parameters are configured as per Figure 132.

**Power Supply**

Supply Mode  Requires different jumper settings

Regulated VDD

**Oscillator**

System Clock Source

System Clock Source Divider

Clock Output Mode

Some settings are not selectable due to the configured AOUT Mode.

Figure 132. 2-Wire Current Loop Power Supply and Oscillator

Ensure the calibration coefficients in NVM are configured as per Figure 133 (default values).

Afe1CfgSccCoeff.SOffset	32	00000000
Afe1CfgSccCoeff.SGain	33	00200000
Afe1CfgSccCoeff.SSot	34	00000000
Afe1CfgSccCoeff.SShift	35	00000000
Afe1CfgSccCoeff.STco	36	00000000
Afe1CfgSccCoeff.SSotTco	37	00000000
Afe1CfgSccCoeff.STcg	38	00000000
Afe1CfgSccCoeff.SSotTcg	39	00000000

Figure 133. Default Calibration Coefficients

**Note:** before the current loop is ready to be calibrated, it is necessary to save configuration in NVM (by the “Write Memory” button in the GUI main tab).

**5.8.1.6 2-Wire Current Loop Calibration**

For sensor signal calibration refer to section 7.

Follow these steps to calibrate the 2-wire current loop option:

1. Set the ‘Rsense [Ω]’, ‘Imin [mA]’, and ‘Imax [mA]’ values for the current loop input (defaults are displayed)
2. Click the ‘Calculate Ideal Coefficients’ button (see Figure 134).

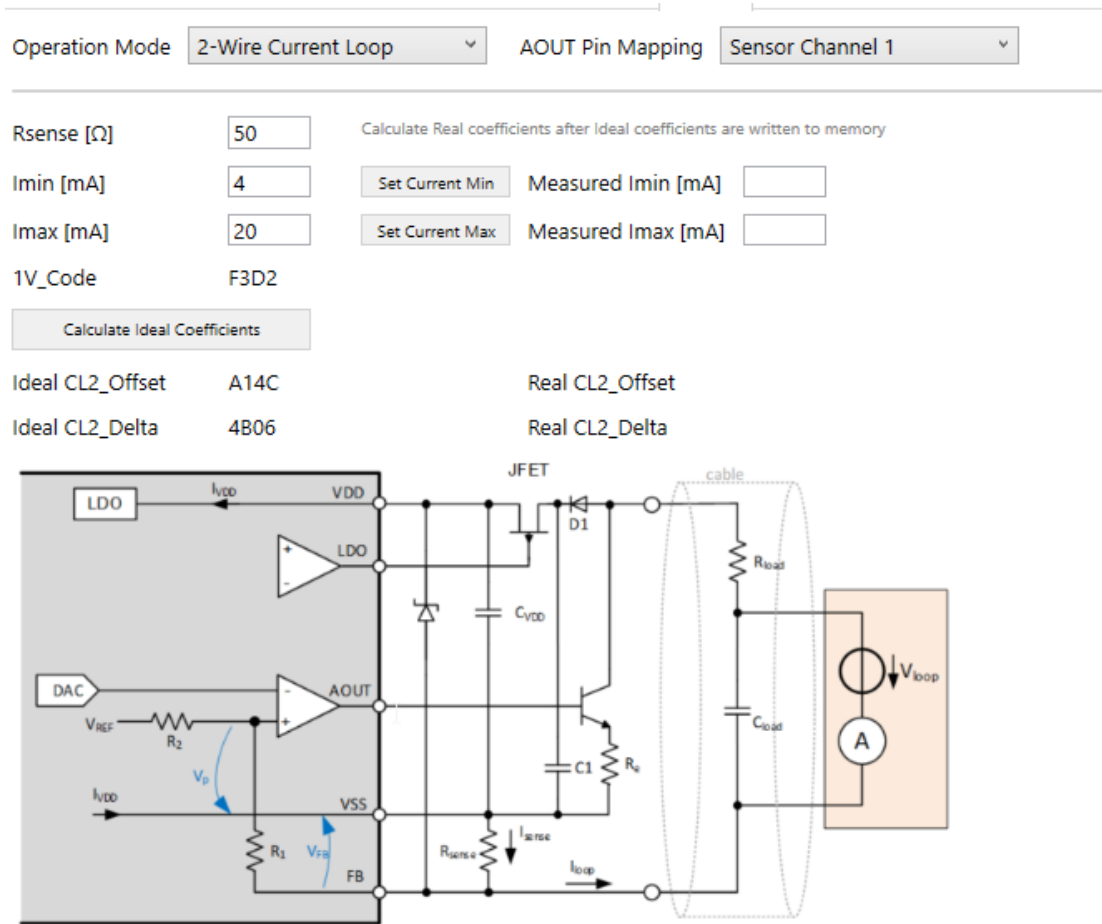

Figure 134. 2-Wire Current Loop Calibration

3. Execute a Memory Write.
4. Click on the 'Set Current Min' button and read the current in the loop through a current probe (a digital multi meter in series in the loop can be used as well).
5. Input the read value in the relevant input field.
6. Click on the 'Set Current Max' button and read the current in the loop through a current probe (a digital multi meter in series in the loop can be used as well).
7. Input the read value in the relevant input field.  
The interface appears as displayed in Figure 135 (values are for reference only).

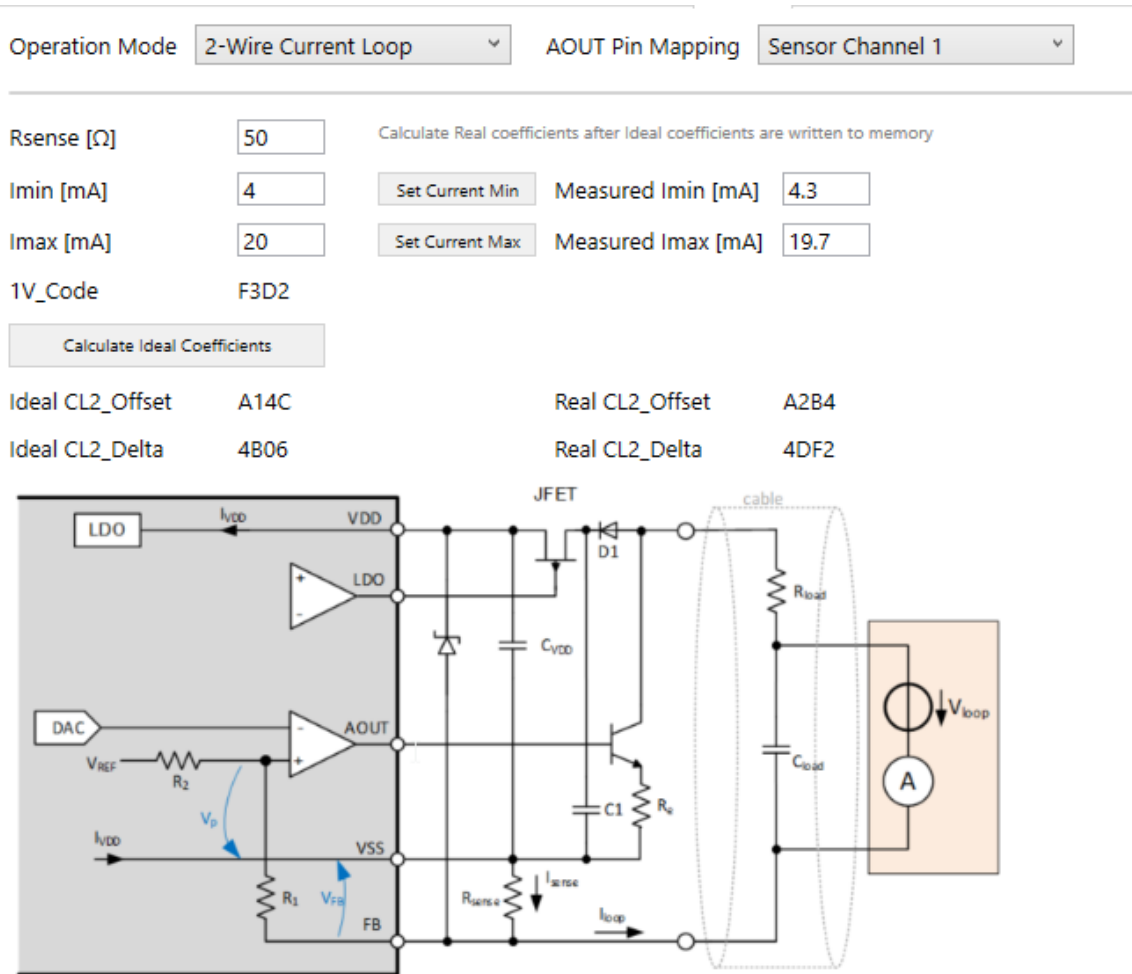

Figure 135. 2-Wire Current Loop Calibration Measured Coefficients

8. Execute a Memory Write.  
The Current loop is calibrated and ready for measurements.
9. Click on the 'Start' button (see Figure 158) to start measurement.

### 5.8.1.7 Operation Mode: 3-Wire Current loop

Selecting 3-Wire Current Loop option automatically set the proper device power supply configuration, see Figure 119.

**Note:** before the current loop is ready to be calibrated, it is necessary to save configuration in NVM (by the "Write Memory" button in the GUI main tab). For operating in this configuration, remove specific jumpers setup described in 5.8.1.1, 5.8.1.2, 5.8.1.3, or 5.8.1.5, and set the jumpers as the following:

- J11: short 2-3
- J35: short 2-3
- J37: short 2-3
- J34: short 2-3
- J14: short 2-3
- J38: short
- Ensure that VDDN is shorted to GND (J33) as displayed in Figure 136.
- Connect P10, pin 1, to the VDDHV
- Connect GND of VDDHV to P10 pin 3.



A current meter (for measuring purposes) with a current limiting resistor (for example, 390Ω) can be connected between P10 pin 1 and 2, or the current meter can be attached on J34 replacing the short 2-3.

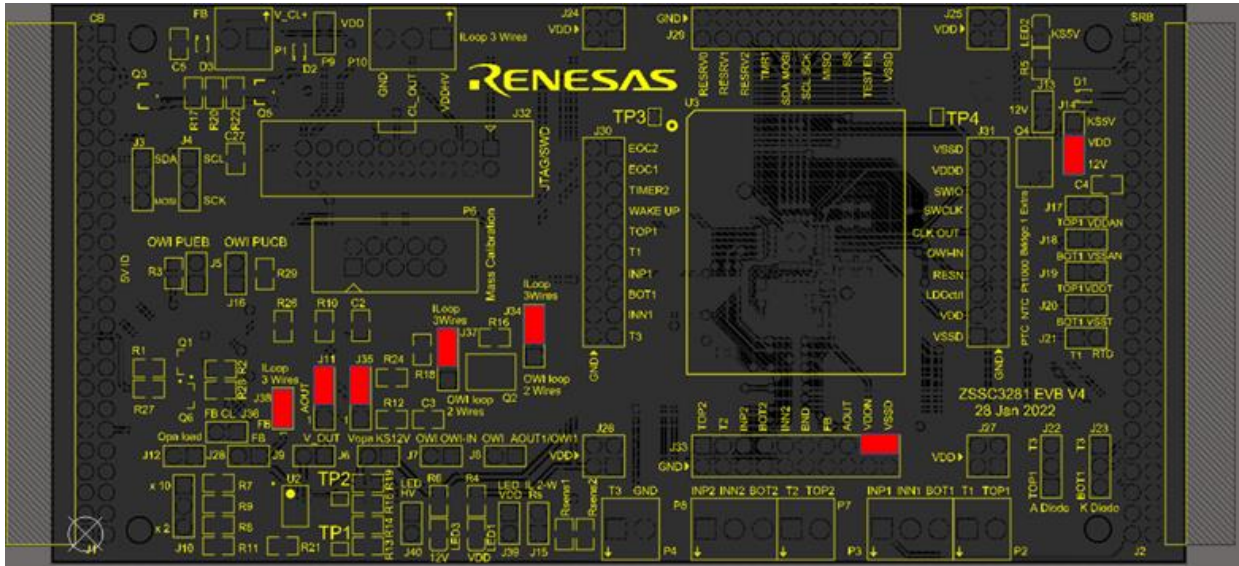

Figure 136. 3-Wire-Current-Loop Jumper Setting

### 5.8.1.8 3-Wire Current Loop Calibration

For sensor signal calibration refer to section 7. Follow these step to calibrate the 3-wire current loop option:

1. Set the 'Rsense [Ω]', 'Imin [mA]', and 'Imax [mA]' values for the current loop input.
2. Click the 'Calculate Ideal Coefficients' button (see Figure 137).

Operation Mode **3-Wire Current Loop**
AOUT Pin Mapping **Sensor Channel 1**

---

Re [Ω]

Imin [mA]

Imax [mA]

1V\_Code

**Calculate Ideal Coefficients**

Calculate Real coefficients after Ideal coefficients are written to memory

Set Current Min

Set Current Max

Ideal CL3\_Offset

Real CL3\_Offset

Ideal CL3\_Delta

Real CL3\_Delta

Figure 137. 3-Wire Current Loop Calibration

3. Execute a Memory Write.
4. Click on the 'Set Current Min' button and read the current in the loop through a current probe (a digital multi meter in series in the loop can be used).
5. Input the read value in the relevant input field.
6. Click on the 'Set Current Max' button and read the current in the loop through a current probe (a digital multi meter in series in the loop can be used).
7. Input the read value in the relevant input field.  
The interface appears as displayed in Figure 138 (values are for reference only).

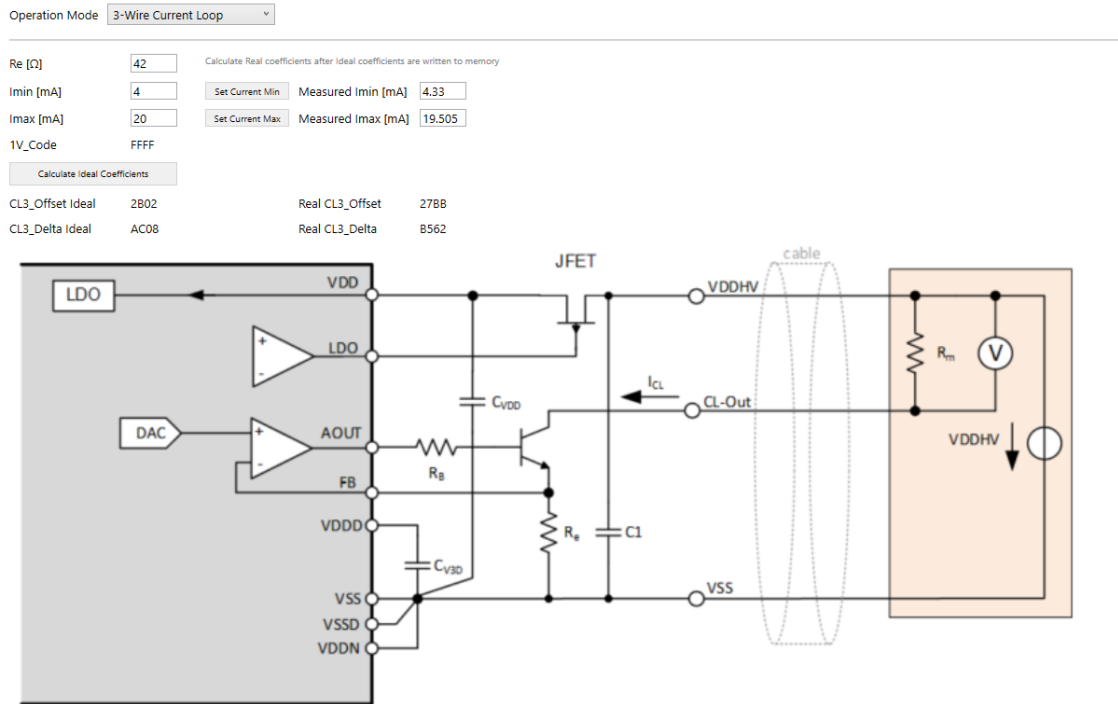

Figure 138. 3-Wire Current Loop calibration Measured Coefficients

8. Execute a Memory Write.  
The current loop is calibrated and ready for measurements.
9. Click on the 'Start' button (see Figure 158) to start measurement.

### 5.8.2 AOUT Pin Mapping

The AOUT pin can provide the analog output from different channels, select it from the AOUT Pin Mapping drop-down list (see Figure 139).

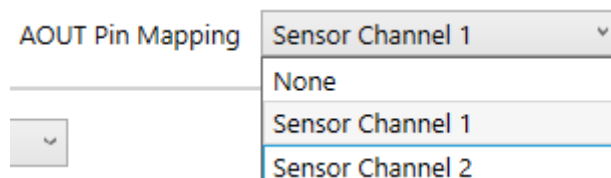

Figure 139. AOUT Pin Mapping

In Dual Speed Mode, the AOUT mapping is forced to Sensor Channel 1 (no other options are available).

### 5.8.3 AOUT Output Stimulus

The AOUT can be directly driven with a fixed output level by entering the value to the Output Stimulus [%] field and clicking the 'Set' button (see Figure 140).

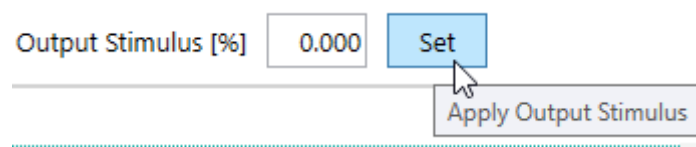

Figure 140. AOUT Direct Setting

## 5.9 Filter

The filter can be employed for each conditioned sensor signals in Cyclic Mode only. The location of the filter function in the processing path is highlighted in Figure 61. The purpose of the filter is noise reduction (low pass filter). The main capability of the IIR filter is to allow a compromise between noise reduction and response time.

**Note:** the step response gradually approaches the actual step value following an exponential like behavior.

The Filter tab is displayed in Figure 141.

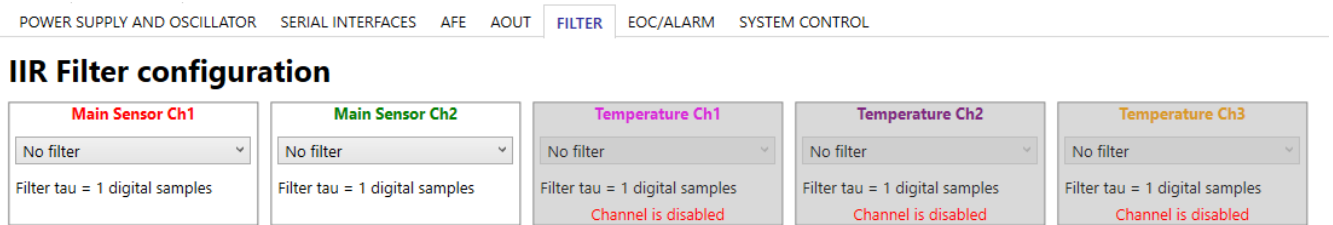

Figure 141. Filter Tab

The filter function applied to each of the channels displayed in Figure 141 is identical. The list of values displayed in Figure 142 allows the selection of the time constant ( $\tau$ ) of the filter, expressed in units of digital samples.

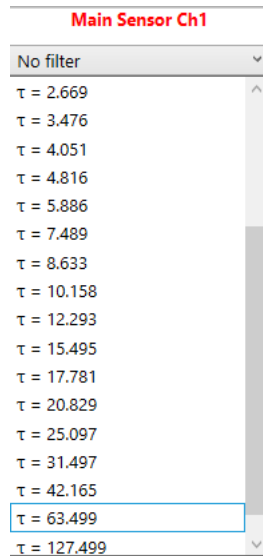

Figure 142. Filter Time Constant Setting

Filter behavior at the event of an input step is displayed in figure Figure 143, where the filter tau value 4.051 (X axis is representing time in terms of digital samples).

### IIR Filter configuration

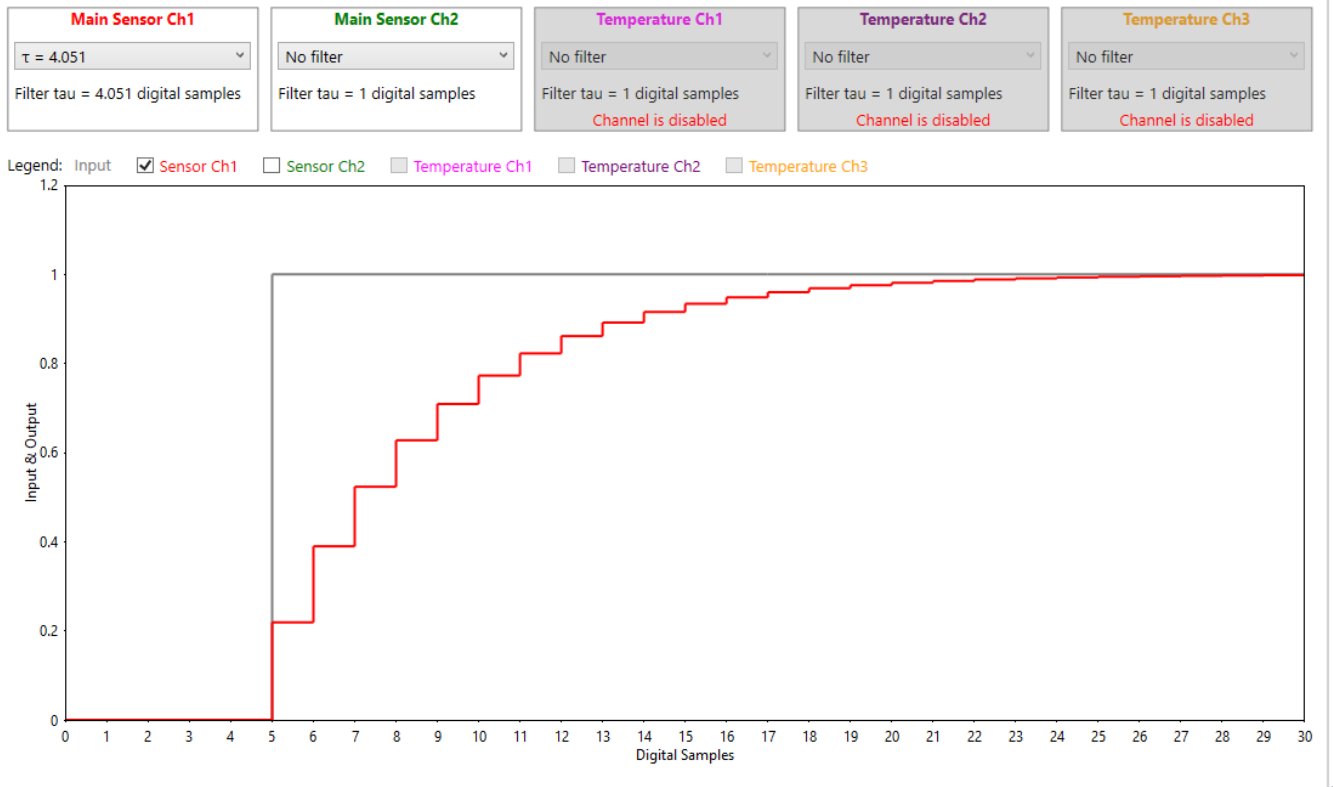

Figure 143. Filter Response (Digital Domain)

To calculate the actual time needed for filter settling, measure the data rate of the output first (that is dependant on the resolution selected and the sequencer configuration).

**Note:** before the filter function becomes operational, it is necessary to execute a Write Memory to save the time constant in flash memory.

The filter configuration functionality is not available when operating the Dual Speed Mode.

### 5.10 EOC/Alarm

The ZSSC3281 provides the option to generate two independent EOC/Alarm signals. EOC/Alarm functions are selectable as displayed in Figure 144.

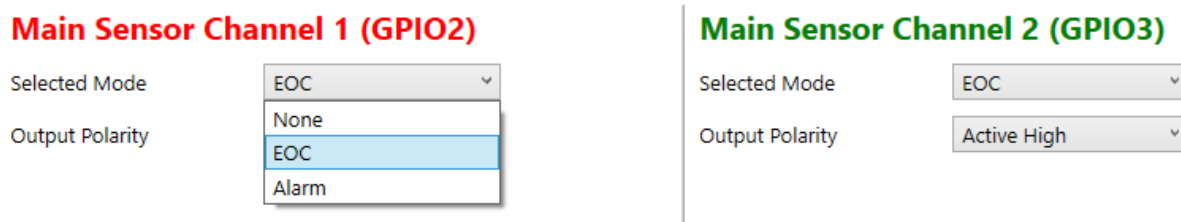

Figure 144. EOC/Alarm Signals

EOC/Alarm functions have configurable options, see sections 5.10.1 and 5.10.2 for details. These signals are generated when the corrected measurement of the main sensor is available at the digital output buffer for reading.

### 5.10.1 EOC

The EOC signals (one for AFE1 and one for AFE2) are activated when the SSC-corrected measurement result of the main bridge sensor is available for the host system, which means after the output data buffer is updated.

The EOC signals are independently configurable for each main sensor channel. EOC for main sensor channel 1 is assigned to pin GPIO2 and EOC for main sensor channel 2 is assigned to pin GPIO3.

The EOC signal can be configured as active high or active low by selecting an option from the Output Polarity drop-down list (see Figure 145).

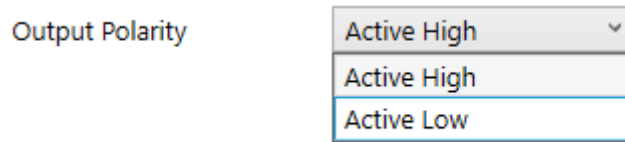
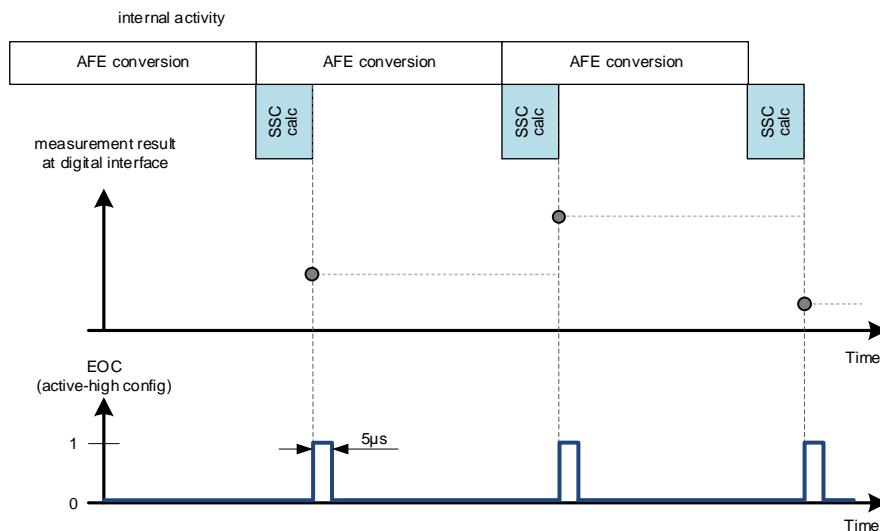

Figure 145. EOC Polarity

Behavior of the EOC signal is shown in Figure 146.



Note: timing relations are not to scale, they are qualitative illustrations only

Figure 146. EOC Generation

### 5.10.2 Alarm

The Alarm (comparator) functionality is highly configurable and allows the user to select among the following options:

- single threshold mode or dual threshold (window) mode
- alarm region (Above/Below, Outside/Inside)
- hysteresis
- persistence
- active-high / active-low output levels for both features

The Alarm signals are one for AFE1 and one for AFE2.

The Alarm signals are independently configurable for each Main Sensor Channel. Alarm for main sensor channel 1 is assigned to pin GPIO2 and Alarm for main sensor channel 2 is assigned to pin GPIO3.

The selections are visible in the GUI as displayed in Figure 147.

Main Sensor Channel 1 (GPIO2)		Main Sensor Channel 2 (GPIO3)	
Selected Mode	Alarm	Selected Mode	Alarm
Output Polarity	Active High	Output Polarity	Active High
Threshold Mode	Single Threshold	Threshold Mode	Single Threshold
Range	Above	Range	Above
Hysteresis	0	Hysteresis	0
Persistence	0	Persistence	0
Threshold 1	0	Threshold 1	0

Figure 147. Alarm Configuration Options

Constraints on thresholds and hysteresis:

- Threshold2 must be set larger than Threshold1. The maximum value of Threshold2 is 16777215.
- Threshold 1 can be set up only to 16777214 (FS-1).
- Hysteresis cannot be set higher than Threshold1.
- Persistence: the maximum value is 255.  
For example, if signal sampling rate is 1ms and Persistence is set to 225, the alarm has a persistence on the output of about 0.25s
- Hysteresis: the configured hysteresis value defines the hysteresis “offset”, i.e., the hysteresis width is effectively twice the configured hysteresis value.  
For example:
  - Threshold set equal to 15194300
  - Hysteresis set equal to 10
  - Hysteresis window width is equal to 20 counts, centered on the 15194300 threshold.
  - Hysteresis and Persistence are both disabled if their relevant value is set to 0.

See Figure 148 for the behavior of the Threshold Mode, Range and Hysteresis parameters.

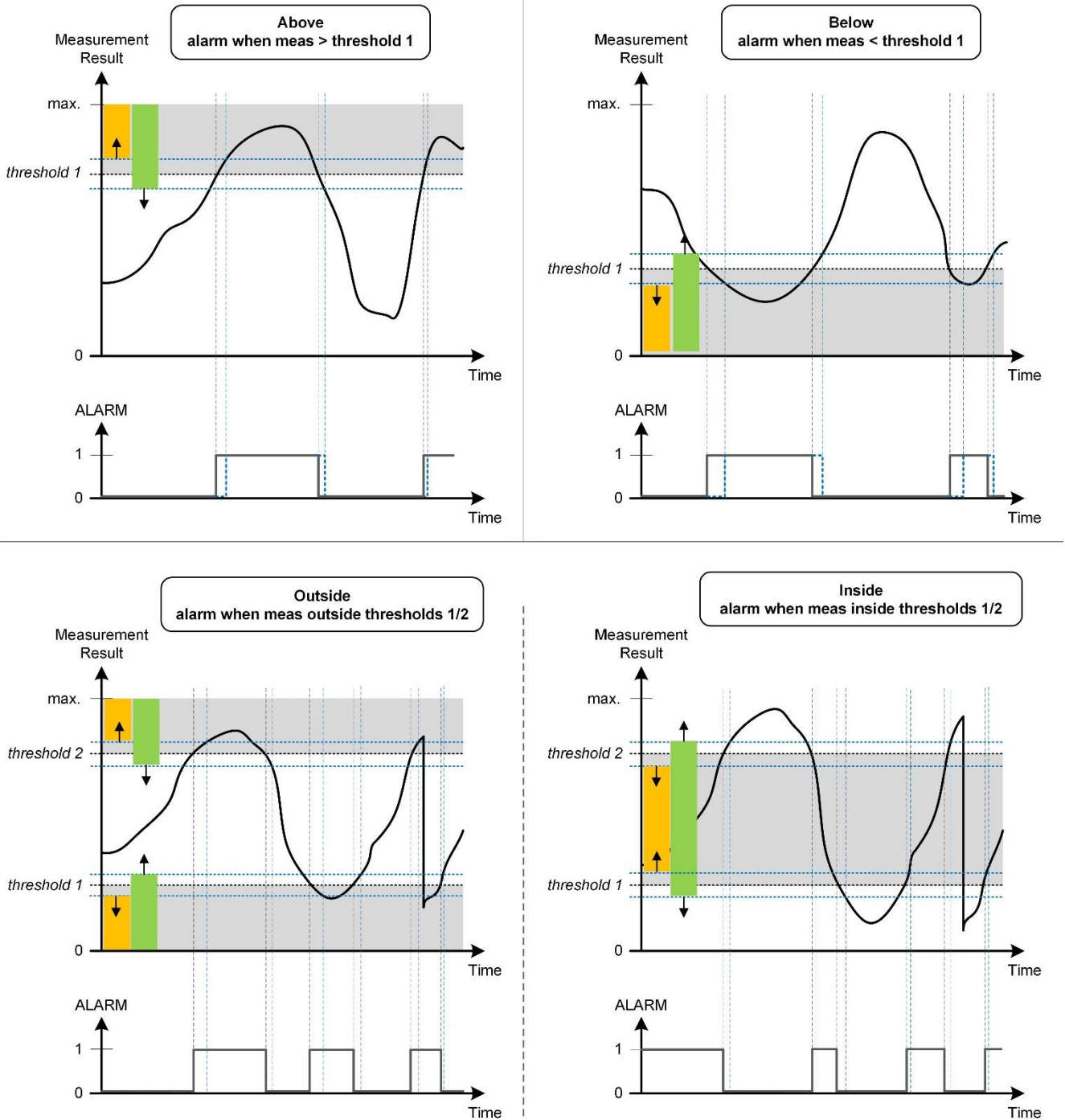

Figure 148. Alarm Threshold Mode, Range and Hysteresis

### 5.11 System Control

Define the active device Mode (refer to the ZSSC3281 Datasheet document) at system startup on the System control tab. The selection is active after writing to NVM, see Figure 149.

Select 'Enable' from the Advanced Error Response drop down list, refer to the ZSSC3281 Datasheet document for details on this function.

System Startup	<input type="text" value="Start in Cyclic Mode"/>
Advanced Error Response	<input type="text" value="Disabled"/>
End of Busy Signal	<input type="text" value="Disabled"/>

Figure 149. System Control

When the Advanced Error Response is enabled, in case there is an issue (for instance an unrecognized command, or a wrongly formatted command), this is reported in the IC STATUS area as displayed in the following picture:

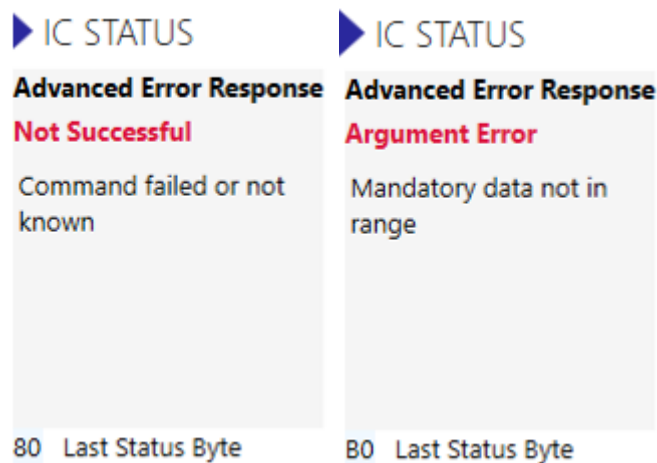

Figure 150. Advanced Error Response Messages

When the End of Busy Signal is enabled, a short signal pulse will be generated on the configured EOC pins.

### 5.12 Customer ID

The Customer ID tab provides the capability to store two words (32 bits each) in the NVM that may contain, for example, the final product manufacturing information (see Figure 151).

AFE TLC OUTPUT SCALING OUTPUT PREPROCESS AOUT FOUT FILTER EOC/ALARM SYSTEM CONTROL **CUSTOMER ID**

Customer ID 0 [hex]

Customer ID 1 [hex]

Figure 151. Customer ID



## 6. Measure

The Measure tab (Figure 152) provides a comprehensive overview on the measurements visualization settings and the option to save the acquired data to file.

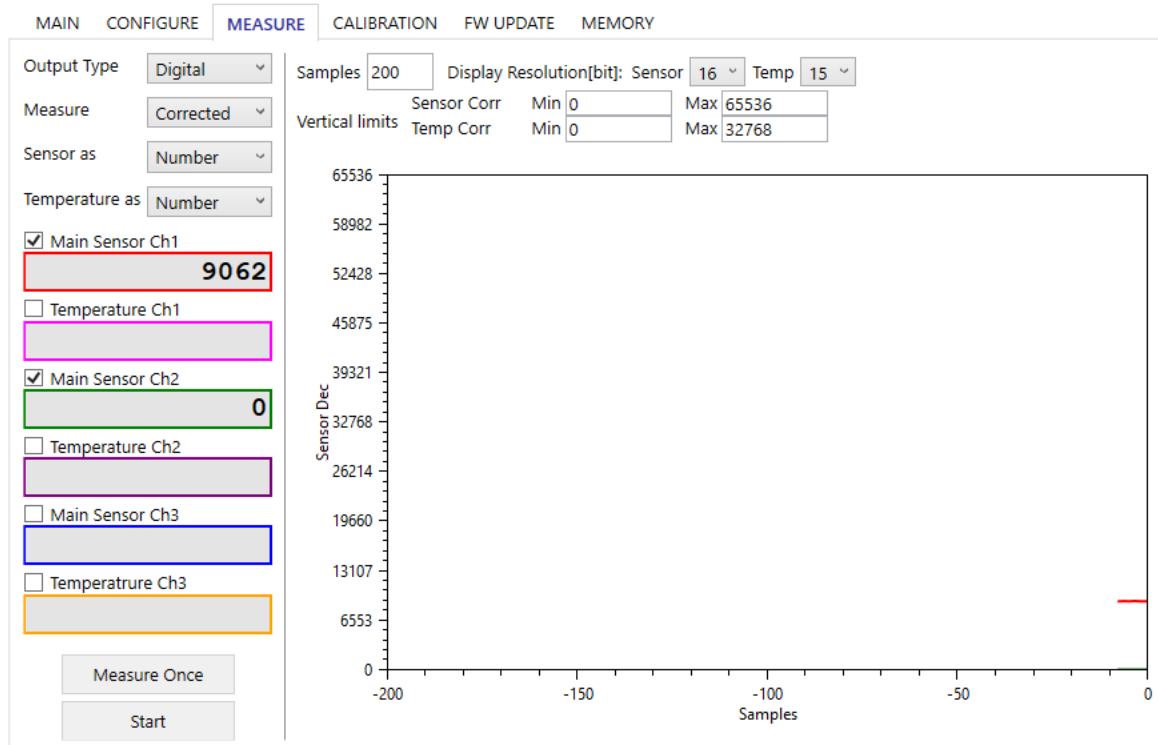

Figure 152. Measure Tab

Each measurement result coming from the ZSSC3281 is structured in 3 bytes (24-bit) or in case of CH3 in 4 bytes. The GUI limits the data display to the selected resolution via software (see the 'Display Resolution[bit]' fields of Figure 152). The original stream of bits can be viewed by logging the communication. The graph shown in Figure 153 is an example of the resolution range from the chip through the communication channel to the GUI display.

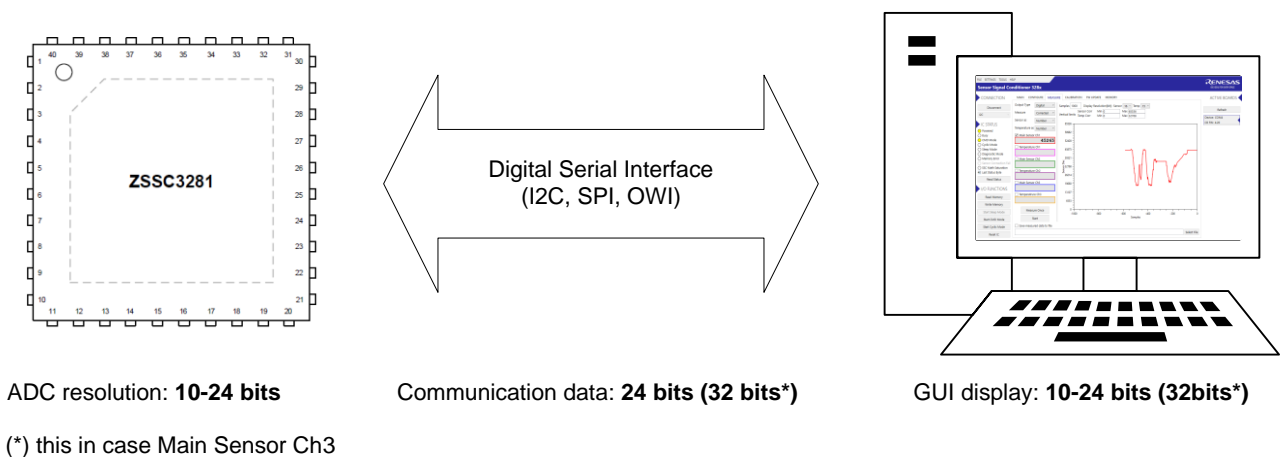

Figure 153. Resolution from Device to GUI

## 6.1 Measure Options Selection

The Measure menu (Figure 154) allows to select options to display the acquired data, either for the Main sensor or the Temperature sensor.

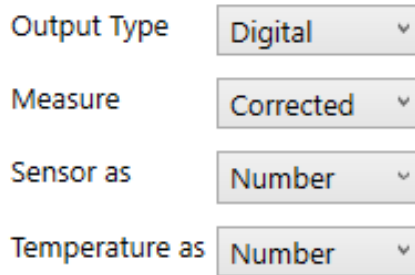

Figure 154. Measure Selection

### 6.1.1 Output Type

This drop-down list (Figure 155) allows to select the type of output to be displayed.

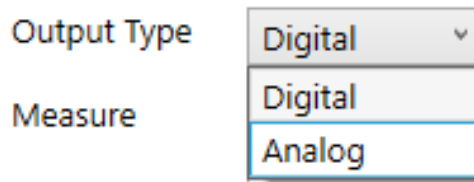

Figure 155. Output Type

If Digital is selected, data displayed is the one received on the operating serial buses.

If Analog is selected and J8 on the EVB is shorted, the analog output is connected to a 10bit ADC input available on the CB, allowing analog data to be displayed (see Figure 156).

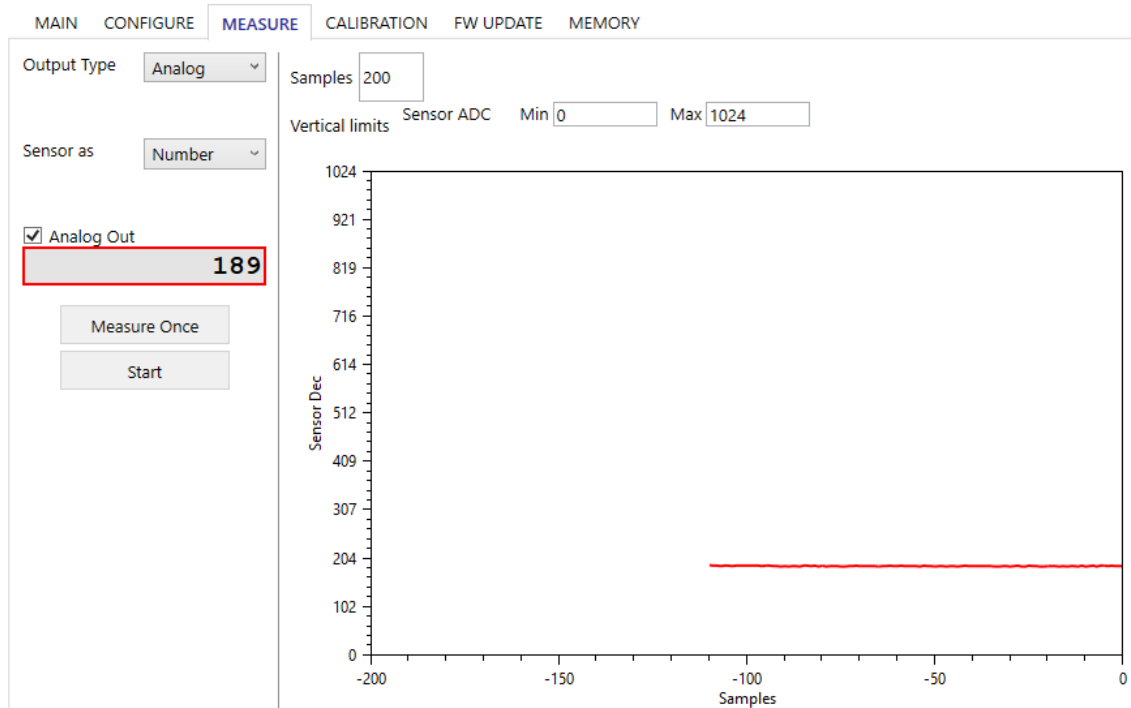

Figure 156. Analog AOUT Read-back

### 6.1.2 Measure

Select an option from the Measure drop-down list (see Figure 157):

- Raw Legacy: data is acquired through a legacy set of reading commands. These measurements are not mathematically conditioned by the device. Legacy commands are implemented in the ZSC3281 to allow a direct comparison with previously released devices such as the ZSSC3240.
- Raw: data is acquired through a ZSSC3281 specific set of reading commands. These measurements are not mathematically conditioned by the device.
- Corrected: data is acquired through a specific ZSSC3281 set of reading commands. These measurements are mathematically conditioned by the device.

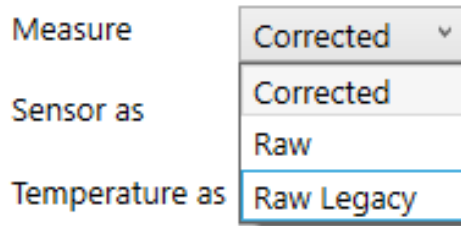

Figure 157. Measure

For information on the commands available for data acquisition, refer to the *ZSSC3281 Datasheet* document.

#### 6.1.2.1 Measurement Acquisition

The GUI offers the following options for measurements acquisition:

- single measurement acquisition (Measure Once),
- continuous acquisition (Start).

The selection is possible by using the pushbuttons shown in Figure 158.

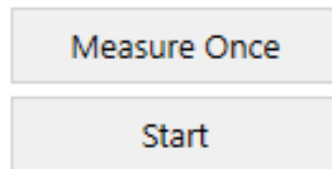

Figure 158. Measurement Acquisition

### 6.1.3 Sensor As

This drop-down list allows the visualization of data according to the options displayed in Figure 159.

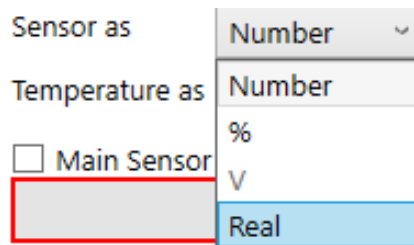

Figure 159. Sensor As

**Note:** the “Real” option allows visualizing the measurements as per the internal ZSSC3281 representation: in the (-1 to 1) range for Raw data, in the (0 to 2) range for conditioned data.

### 6.1.4 Temperature As

This drop-down list allows the visualization of data according to the options displayed in Figure 160.

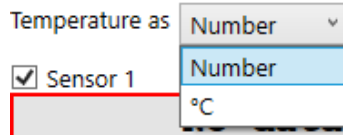

Figure 160. Temperature As

### 6.2 Selection for Displaying

By marking the relevant check box and clicking on the ‘Start’ button, the numerical field shows the data from the selected sources (see Figure 161), see sections 6.1.1 to 6.1.4 for details.

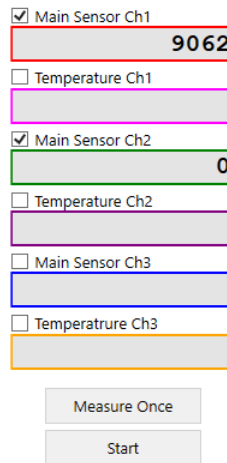

Figure 161. Display Selection

### 6.3 Save Measured Data to File

By marking the relevant check box and clicking on the ‘Start’ button, acquired data is stored in the selected file (Figure 162). This offers the user the possibility to perform statistical analysis on data batches.

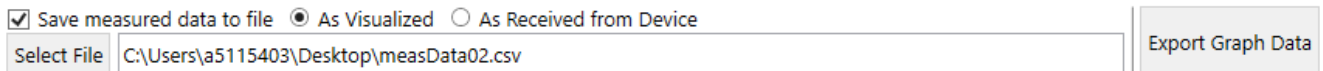

Figure 162. Save Measured Data

**Note:** when “As Visualized” is active, the data saved on file are stored in decimal format taking in account the display resolution selected, see Figure 163.

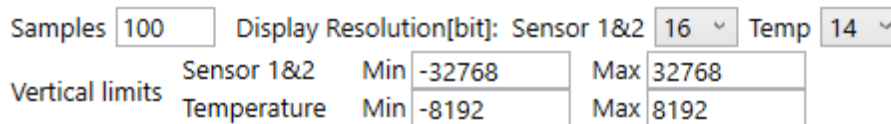

Figure 163. Selected Display Resolution

For example: if the actual ADC resolution is set at 16bit and the display resolution is set to 18bits, data stored on file are already taking in account the scaling from the fixed 24bit format data received from the ZSSC3281 to the display configured resolution (18bits). The physical data resolution is 16bits, as per setting in the Bridge Configure tab (see section 5.3.3.1). The display resolution is in most of cases set equal to the ADC resolution.

When “As Received from Device” is active, the data saved on file are stored in decimal format, without any further manipulation from the GUI.

## 6.4 Save Screen Displayed Data to File

To visualize the acquired data on screen and then save to file, follow these steps:

1. Select the wanted channel(s).
2. Start measurement.
3. Stop the measurements when the data displayed on the screen are needed on file.
4. Click on the 'Export Graph Data' button (see Figure 164).
5. Browse and save the file to a location.

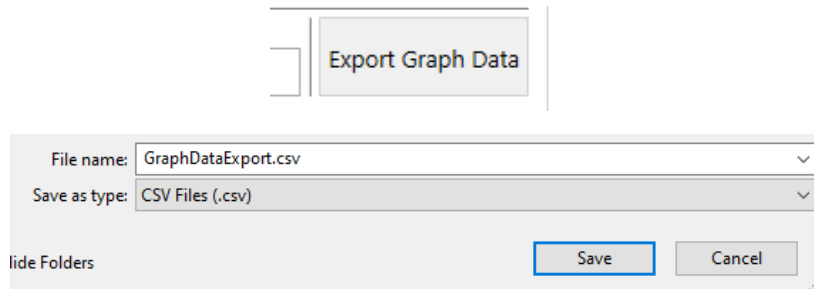

Figure 164. Save Screen Displayed Data

## 6.5 Graphs Area

The graphs area (Figure 165) allows visualizing, over a specific number of samples, the trend of the acquired data as selected in section 6.2.

Set the following options for display:

- the number of samples
- the resolution of the display either for the sensor or for the temperature graph
- the limits of the Y-axis

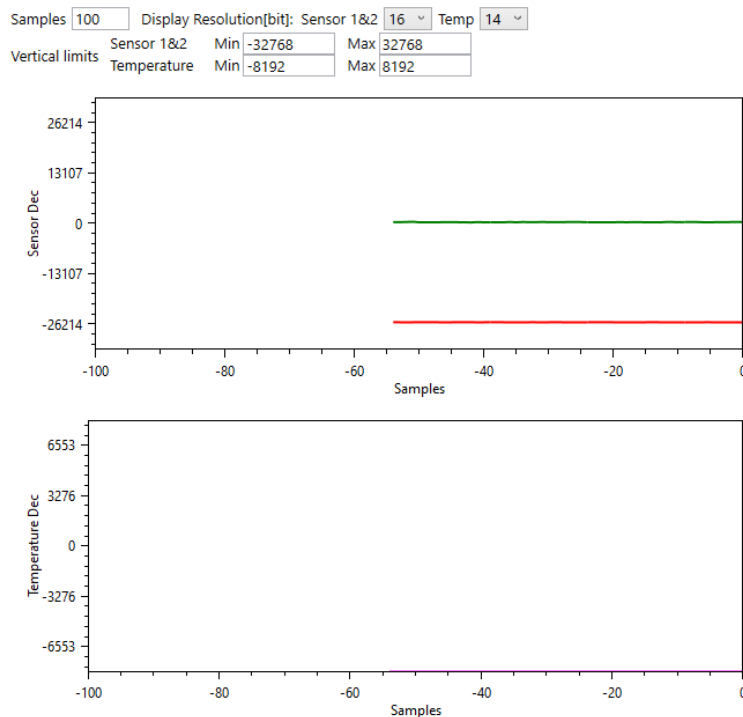

Figure 165. Graphs Area

## 7. Calibration

The Calibration tab (see Figure 166) allows acquiring raw data and calculating the coefficients needed for signal linearization and temperature compensation.

Refer to the information provided in section 5.3.2 for the association of a Temperature transducer to a specific main sensor and relevant signal processing.

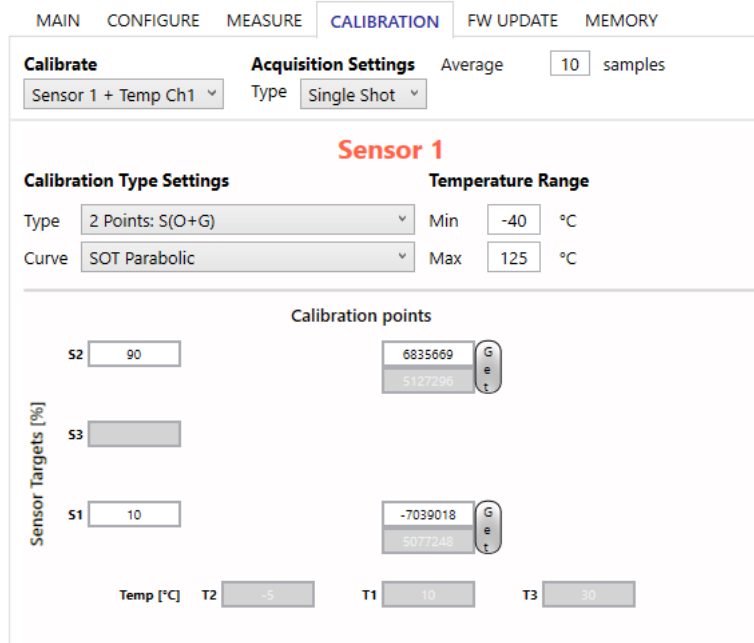

Figure 166. Calibration Tab

### 7.1 Sensor Selection, Acquisition Type

Select the sensor, the acquisition type, and specify the number of samples for calibration with the drop-down lists and boxes displayed in Figure 167.

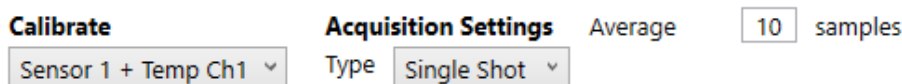

Figure 167. Sensor, Acquisition

Select Sensor 1/2 (and relevant Temperature Ch1/2) or Temperature Ch3 from the “Calibrate” drop-down.

Select either Single Shot (for using the 0xA7 command) or Legacy (for using both 0xA2 and 0xA6 commands) from the “Acquisition Type” drop-down to choose the option to adopt a specific type of data acquisition for the calibration points, see Figure 168. Refer to the *ZSSC3281 Datasheet* document for the description of the commands.



Figure 168. Acquisition Type

Set the number of samples to be averaged as input reading for the calibration point by the “Average” input field.

## 7.2 Calibration Type Settings

The settings available in this area of the Calibration tab define the features of the calibration that are finalized with the data collection at the chosen calibration points.

### 7.2.1 Type

The number of points of the selected input (main sensor and temperature channel) is defined with the one of selectable options in the 'Type' drop-down list (see Figure 169).

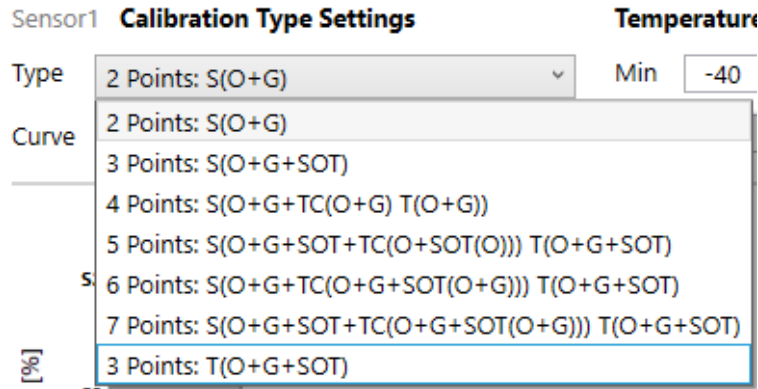

Figure 169. Calibration Type

Table 1 provides information linking the GUI mnemonic to the specific set of coefficients calculated and used for correcting the measurement before providing it on the chosen output. It also maps the mnemonic with a specific relevant set of measurements (Main Sensor and Temperature).

Table 1. Calculating Coefficients

Type	GUI	Calculated coefficients									Required set points		
		OFFSET_S	GAIN_S	TCO	TCG	SOT_S	SOT_TCO	SOT_TCG	OFFSET_T	GAIN_T	SOT_T	Main Sensor	Temperature
2 Point	B(O+G)	✓	✓									2	0
3 Point	B(O+G + SOT)	✓	✓			✓						3	0
4 Point	B(O+G +TC(O+G) T(O+G))	✓	✓	✓	✓				✓	✓		2	2
5 Point	B(O+G +SOT + TC(O+SOT(O))) T(O+G+SOT))	✓	✓	✓		✓	✓		✓	✓	✓	3	3
6 Point	B(O+G+TC(O+G+SOT(O+G))) T(O+G+SOT))	✓	✓	✓	✓		✓	✓	✓	✓	✓	2	3
7 Point	B(O+G+SOT+TC(O+G+SOT(O+G))) T(O+G+SOT))	✓	✓	✓	✓	✓	✓	✓	✓	✓	✓	3	3
2 Point	T(O+G)								✓	✓		0	2
3 Point	T(O+G+SOT)								✓	✓	✓	0	3

### 7.2.2 Curve

Select a second-order equation compensate for sensor nonlinearity with a parabolic curve by choosing either of the following options from the 'Curve' drop-down list (see the ZSSC3281 Datasheet document for details):

- SOT Parabolic: this compensation is recommended for most of the transducers.
- SOT S-shaped

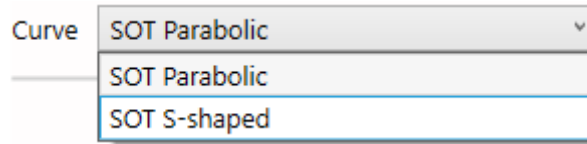

Figure 170. Curve

### 7.3 Temperature Range

The application temperature range must be specified by the user, entering values to the 'Min' and 'Max' fields (see Figure 171).

**Temperature Range**

Min  °C

Max  °C

Figure 171. Temperature Range and Sample Settings

### 7.4 Calibration Points

Depending on the calibration type, the corresponding number of calibration points is displayed in the Calibration Points graph to illustrate the coverage of the measurement range.

When the calibration type is defined, the reference value [S(x)] for the Sensor Targets represents the final output data in percentage of the ADC FS range from the ZSSC3281 output, after signal conditioning.

In the example in Figure 172, a raw bridge sensor value of -7039018 counts is mapped by calibration to 10% of FS and a raw bridge sensor value of 6835669 counts is mapped by calibration to 90% of FS.

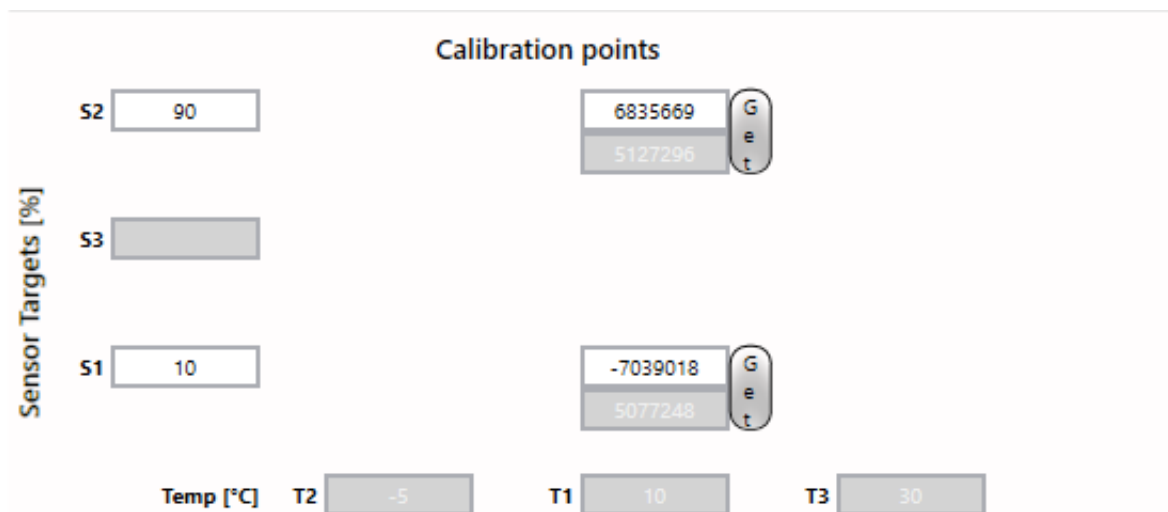

Figure 172. Calibration Points Input



Definitions:

- Sensor Targets [%]: external sensor measurement reference point, enter the point as a percent of the full measurement range.
- Temp [°C]: temperature measurement reference point, enter the point in Celsius degrees.
- S(x): raw external sensor measurement result in counts, enter values manually or get them displayed by clicking the 'Get' button.
- T(x): raw temperature measurement result in counts, enter values manually or get them displayed by clicking the 'Get' button.

### 7.5 Calculate Coefficients, Coefficient Results and Set in GUI

When the complete set of calibration data is collected, the correction coefficients can be calculated by clicking the 'Calculate Coefficients' button (see Figure 173).

Figure 173. Calculate Coefficients, Set in GUI

The calculated coefficients are displayed in the 'Coefficient result' table (see Figure 174 for an example with 2 points calibration).

Coefficient result										
RESULT	Offset S	Gain S	SOT S	Tco	SOT Tco	Tcg	SOT Tcg	Offset T	Gain T	SOT T
SUCCESS	25418	2028694								

Figure 174. Coefficient Result

The result can be either:

- Success: save the calibration coefficients in the NVM by clicking the 'Set in GUI' button (see Figure 173) and execute a Memory Write.
- Failed: the calculated coefficients out of range are displayed in red.

## 7.6 Dual Speed Mode Calibration

Select the “Dual Speed Ch” option from the ‘Calibrate’ drop-down list (see Figure 175) to have both sensor channels share the same calibration settings. The “Get”, “Calculate coefficients”, and “Set in GUI” buttons work simultaneously for both signal paths (CH1 and CH2).

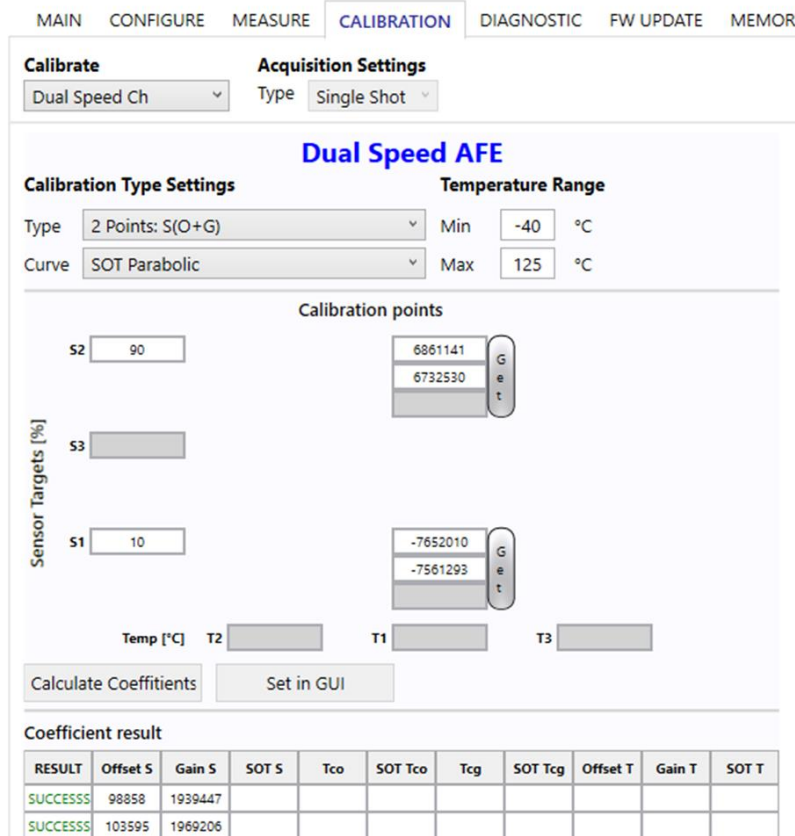

Figure 175. Dual Speed Channel Calibration

When the input measurements is acquired (see Figure 175 for a 2 points calibration example), the coefficients can be calculated by clicking the ‘Calculate Coefficients’ button.

The result can be either:

- Success: operation for both channels passed, save the newly calculated calibration coefficients (see Figure 176) in the NVM by clicking the ‘Set in GUI’ button (see Figure 176) and execute a Memory Write to finalize the operation.
- Failed: the calculated coefficients out of range are displayed in red.

Afe1CfgSccCoeff.SOffset	4D	0001822A
Afe1CfgSccCoeff.SGain	4E	001D97F7
Afe1CfgSccCoeff.SSot	4F	00000000
Afe1CfgSccCoeff.SShift	50	00000000
Afe1CfgSccCoeff.STco	51	00000000
Afe1CfgSccCoeff.SSotTco	52	00000000
Afe1CfgSccCoeff.STcg	53	00000000
Afe1CfgSccCoeff.SSotTcg	54	00000000
SscCoeffSbr[0].OutScaleGain	55	00100000
SscCoeffSbr[0].OutScaleOfst	56	00000000
Afe2CfgSccCoeff.SOffset	57	000194AB
Afe2CfgSccCoeff.SGain	58	001E0C36
Afe2CfgSccCoeff.SSot	59	00000000

Figure 176. Dual Speed Channel Calibration – New Coefficients Ready

## 8. Diagnostics

The Diagnostic tab enables the diagnostic test through the GUI. The Diagnostic functionality is not available in Dual Speed Mode (see 5.3.1.1).

### 8.1 General Tab

Enable or disable the diagnostic state (refer to the *ZSSC3281 Datasheet* document for the functional description) on the AOUT pin and the pins associated to FOUT (GPIOs) with the drop-down list as displayed in Figure 177.

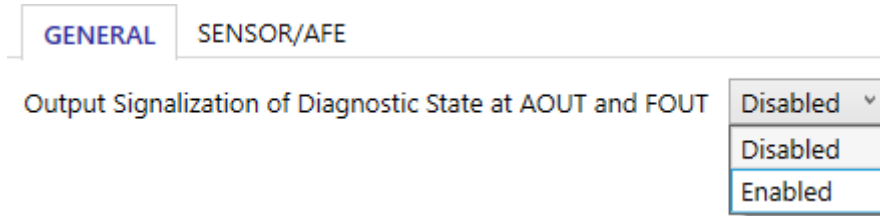

Figure 177. Diagnostic State Signalization Enable

### 8.2 Sensor/AFE Tab

On the Sensor/AFE tab (see Figure 178) mark the relevant check box to enable the corresponding diagnostic test. If a test requires additional user input, it must be entered in the input field available on the right side. Refer refer to the *ZSSC3281 Datasheet* document for a comprehensive description of the diagnostic features.

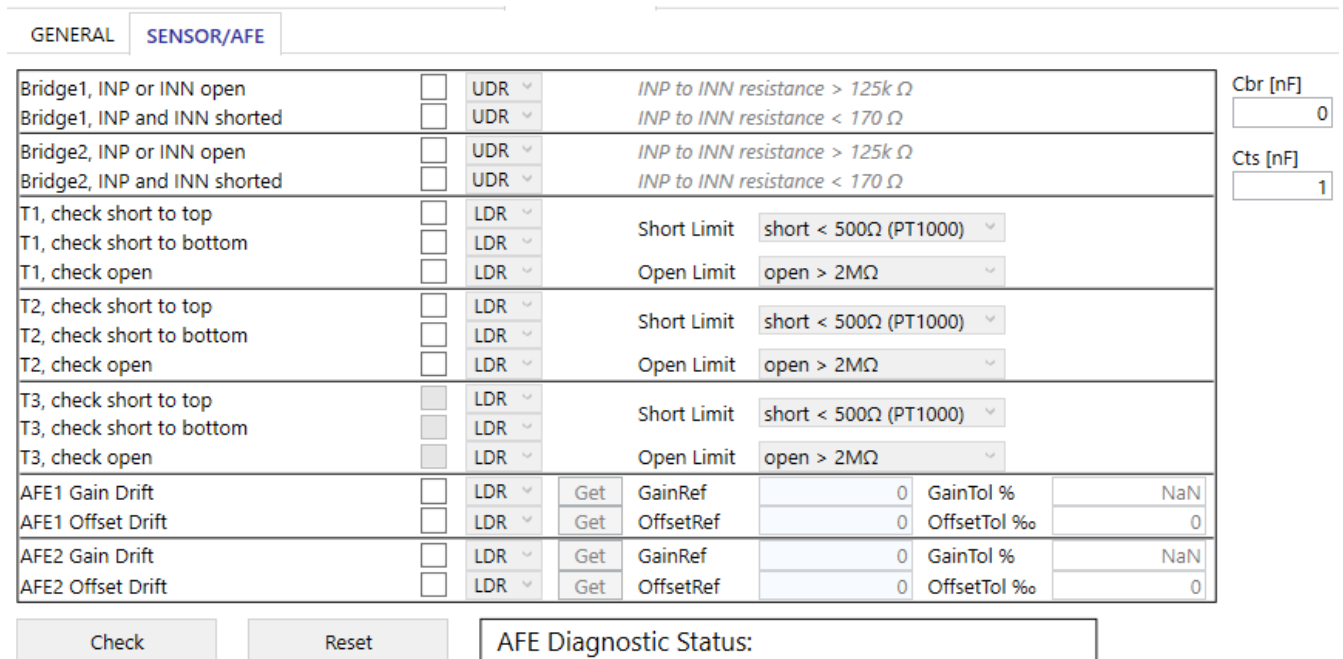

Figure 178. Diagnostic Tab

#### 8.2.1 User Selectable Input Fields

The Sensor/AFE tab has the following fields:

- Cbr [nF] and Cts [nF] fields: enter the values to the fields within the allowed range of 0nF to 2nF, the capacitors are displayed in Figure 179.

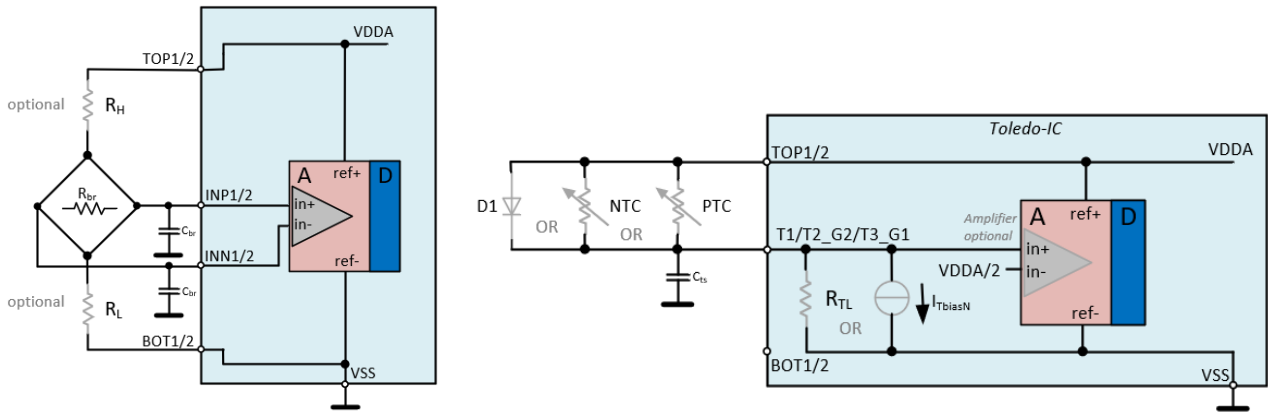

Figure 179. Cbr and Cts Capacitors

- UDR/LDR drop-downs: define if an upper or lower diagnostic range of signalization level is used on the AOUT and/or FOUT pins for the selected check (see Figure 180).  
**Note:** the UDR signalization has higher priority on the LDR signalization. It might be convenient to assign the UDR to a check if it is of top priority in the application under design.

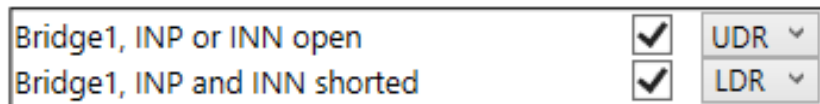

Figure 180. UDR/LDR Selection

- Short Limit/Open Limit options: select the limits from the drop-down lists. 'short < 500Ω (PT1000)' is available for the short limit (T1, T2, T3). The following options are available for open limits (T1, T2, T3):
  - open > 2MΩ
  - open > 500kΩ
  - open > 100kΩ
- AFE(x) Gain Drift: set the values to have the gain references for AFEs calculated. Follow these steps to calibrate AFE gain drifts:
  - Enable 'AFE1 Gain Drift' or 'AFE2 Gain Drift' checkboxes. The "Get" button is enabled.
  - Click on 'Get'. The 'Set diagnostic DAC value for AFE(x) Gain check' window pops-up (see Figure 181).

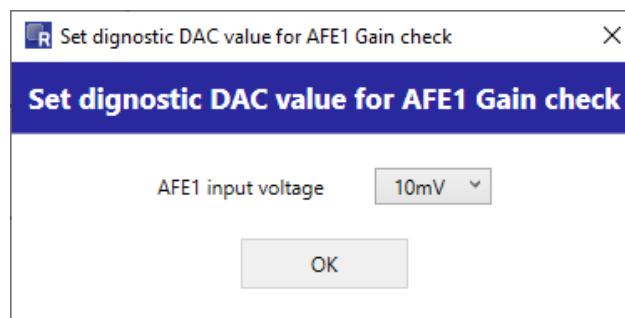

Figure 181. Input for AFE Gain Check

- Select a value from the 'AFE(x) input voltage' drop-down list.  
**Note:** for the identification of the actual AFE gain, it is recommended to use the default value. Other values are available for testing purpose only.

- Click on “OK”.  
The GUI calculates the AFE gain reference that is displayed in the non-editable field (see Figure 182).

Afe1GainRef:

**Figure 182. AFE Reference Gain**

- Enter the lifetime drift tolerance (in %) to the ‘Afe(x)GainTol %’ field (see Figure 183).  
**Note:** the GUI rounds the input value to the closest admissible value for the calculation.

Afe1GainTol %:

**Figure 183. AFE Gain Tolerance**

- Write to NVM.

- AFE(x) Offset Drift: set values to have offset for AFEs calculated properly.  
Follow these steps to calibrate AFE offset drifts:

- Enable ‘AFE1 Offset Drift’ or ‘AFE2 Offset Drift’ checkboxes.  
The “Get” button is enabled.
- Click on ‘Get’.  
The GUI makes an offset measurement that is displayed in the non-editable field (see Figure 184).

Afe1OffsetRef:  Afe1OffsetTol %:

**Figure 184. AFE Offset Reference and Tolerance**

- Enter the lifetime drift tolerance (in %, related to the ADC full scale) to the ‘AfeOffsetTol%’ field (see Figure 184).
- Write to NVM.

### 8.2.2 Diagnostics Operation

Diagnostic check and reset can be started with the relevant buttons.

**Note:** to have the specific set of diagnostic features operational, execute a memory write. The ‘Check’ and ‘Reset’ buttons are disabled until the Memory Write is performed (see Figure 185).



**Figure 185. Diagnostic Check and Reset**

### 8.2.3 AFE Diagnostic Status

The Diagnostic tab provides the current Diagnostic Status (see Figure 186).

AFE Diagnostic Status: 0x00000000\_00000000

**Figure 186. AFE Diagnostic Status**

When diagnostic checks do not return a fault, the status is set to “0” (two 32 bits words). A check detecting a fault determines a change in the AFE Diagnostic Status value.

A comprehensive description of the Diagnostic Status is provided in the *ZSSC3281 Datasheet* document.

### 8.3 AFE Diagnostic Operation Example

In this diagnostics operation example the default EVK configuration is used with the check for shorts between INP1 and INN1, AFE1 is enabled, the 'Bridge1, INP and INN shorted' checkbox is enabled (see Figure 187), and a write to memory is executed.



Figure 187. Activation of Diagnostic Check

When the diagnostic check is performed by clicking on the "Check" button, the result is successful (see Figure 188).



Figure 188. Diagnostic Check Pass

After clicking on 'Reset' and placing a short between the INN1 and INP1 pins on the EVB, the new check fails (see Figure 189).

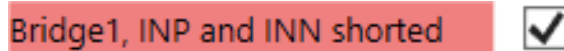

Figure 189. Diagnostic Check Fail

In the IC Status the failure is reported as displayed in Figure 190 :

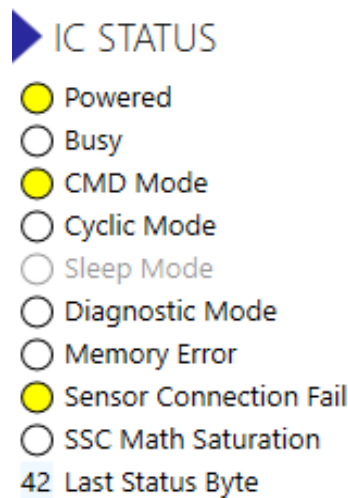

Figure 190. IC Status Sensor Connection Fail

## 9. FW Update

Update the ZSSC3281 Firmware version that is on the device memory through the FW Update tab (see Figure 191).

The FW update is normally performed using the I2C serial bus, make sure that the relevant jumper configurations (see section 2.5) on the EVB are in place to ensure to proper operation.

Before starting the procedure of FW update ensure that the device configuration saved in NVM has the System Startup option (see Figure 149) set to “Start in Command Mode”. Missing this setting in NVM can result in FW update failure.

### Notes:

- It is recommended to make a copy of the NVM configuration settings (see Figure 10 for details) before performing a FW update.
- Ensure that during the FW update operation the supply is not switched off. Interruptions of the power supply during an NVM update may result in a loss of functionality of this device.

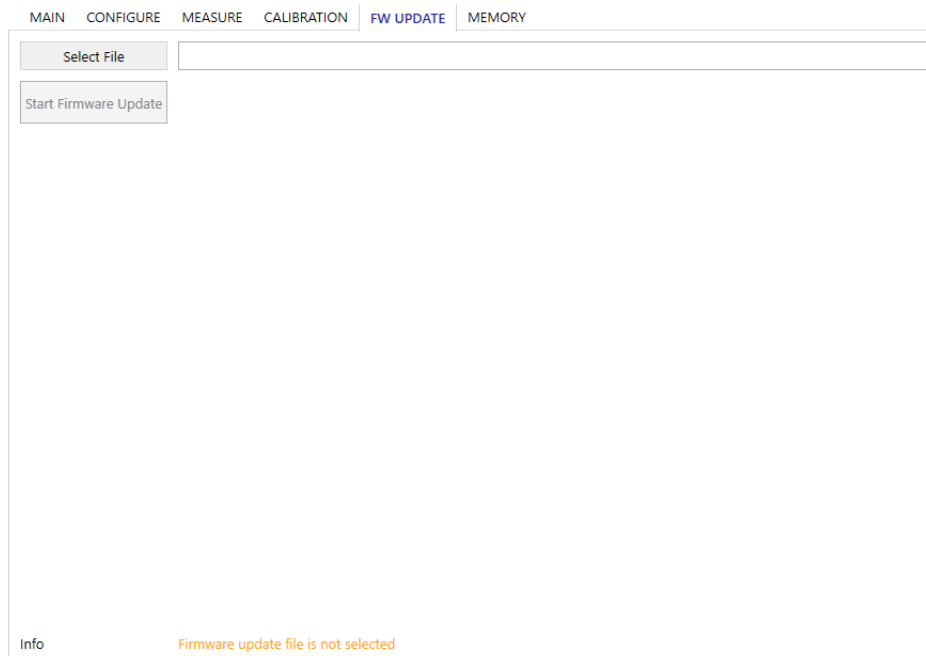

Figure 191. FW Update Tab

Follow these steps to update the FW:

1. Select and upload the FW update file.  
The file extension must be either .bin or .zip; the .zip contains both the .bin and VersionInfo.txt files which is displayed on the GUI.  
The file needs to contain valid firmware update data, otherwise an error message appears (see Figure 192).



Figure 192. FW update file not valid

When a valid firmware update file is selected, an acknowledgement message is displayed (see Figure 193).

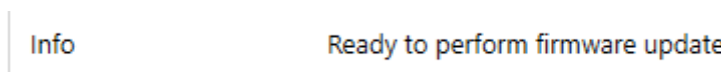

Figure 193. Valid FW update file identified

The firmware update can be performed whether the GUI is connected or not. If the GUI is connected, it goes through the following sequence:

- a. Disconnect
  - b. FW update
  - c. Reconnect
  - d. Read all memory
2. Click the “Start Firmware Update” button. The ‘ZSSC328x Application’ window pops-up (see Figure 194) The button is enabled if all criteria to perform a FW update is met. During the update, no other action can be performed in the GUI.

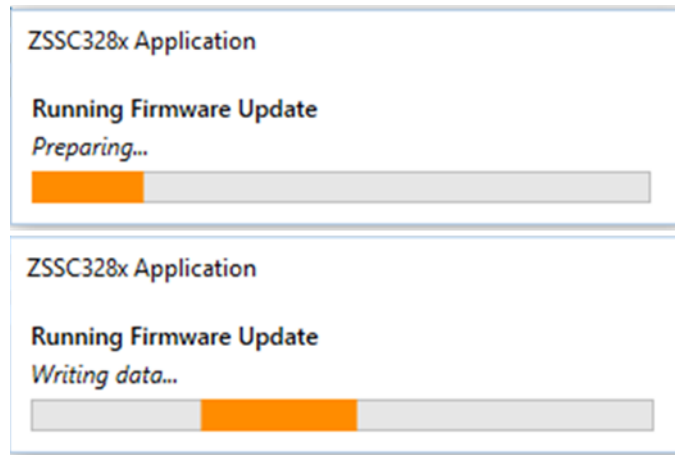

Figure 194. FW Update Operation

3. Click OK in the ‘Success’ pop-up window.

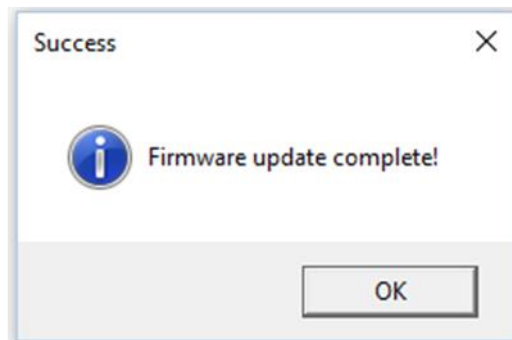

Figure 195. FW Update Finished

Additional tracking information about the FW update is available in the communication log file (see section 3.1.3).



## 10. Memory

### 10.1 Overview

The Memory tab provides the user a read only view on the device configuration memory (NVM), see Figure 196.

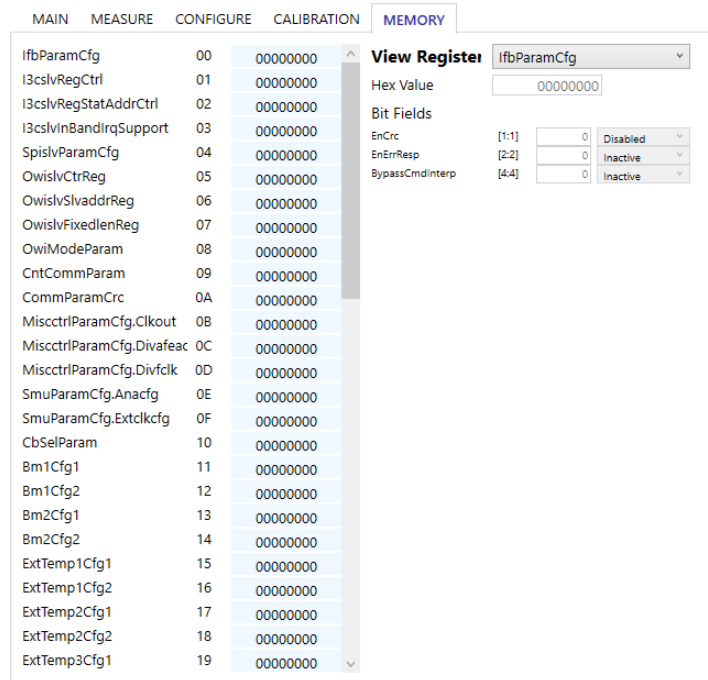

Figure 196. Memory Overview

The complete set of register composing the device configuration memory is listed. Each register is associated with a mnemonic, an address, and the relevant content (in hexadecimal value) as displayed in Figure 197:



Figure 197. Register

### 10.2 View Register

To have a detailed view of the register content, select it from the 'View Register' drop-down list (see Figure 198).

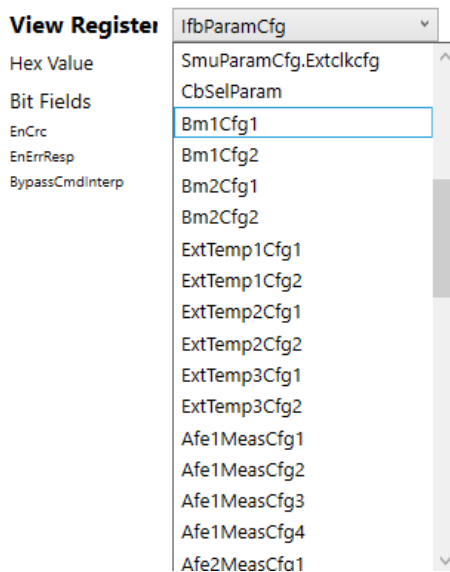

Figure 198. Memory – View Register

For the selected register, the relevant values are displayed and the bit sets associated with specific functions or functionalities are listed (Figure 199 shows an example register). The value of registers is accessible in read/write through the Configure and Calibration tabs described in sections 5 and 7.

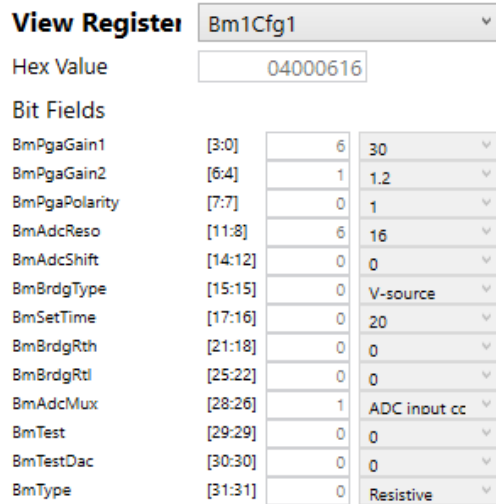

Figure 199. Register Content

When changes to the configuration of the device are set, those are highlighted in the Memory map in red (see Figure 200). To have the changes taken an effect, execute a Write Memory operation.

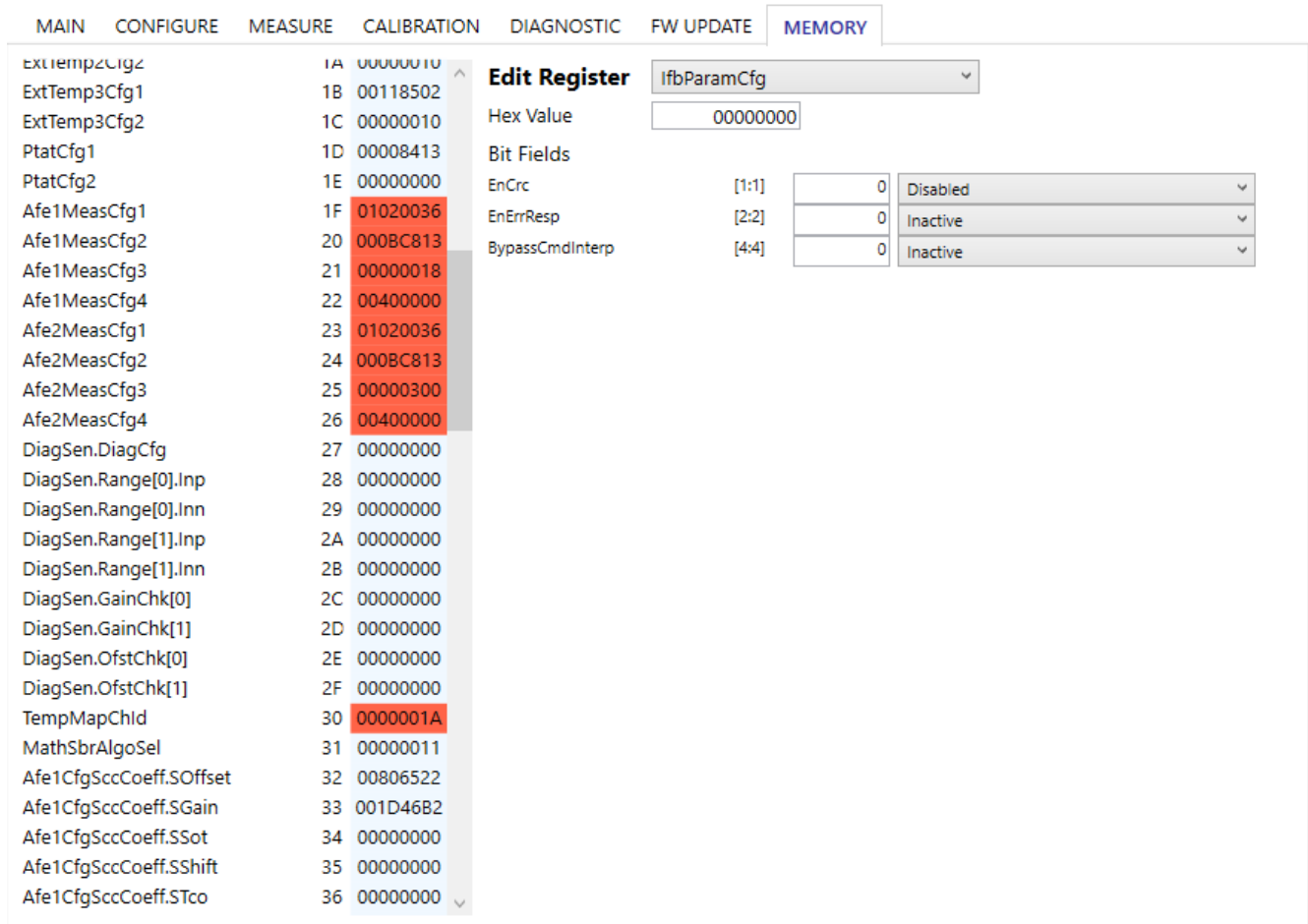

Figure 200. Changes not Written to NVM

Hoovering over a modified register allows the direct display of the bit fields, in the Edit Register section it is possible to check the bits of the registers that were affected by a change (see Figure 201).

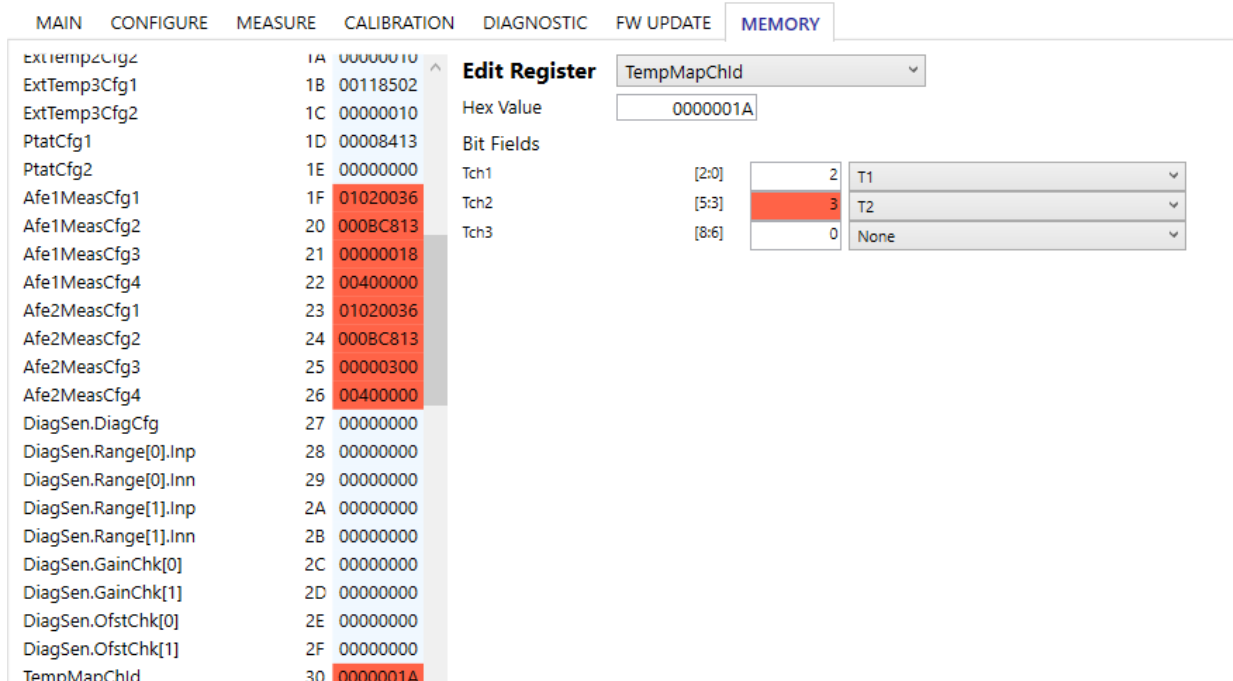

Figure 201. Modified Bits in a Register –Changes not Written to NVM

## 11. Command Console

The Command Console can be started as described in section 3.1.3. Commands can be written directly to the ZSSC3281 (through the CB) and the device response is received in the output window. The output data from the ZSSC3281 can be copied and saved for further analysis by right-clicking on the results in the display.

### 11.1 Select Script and Execute

A previously edited script file, containing a commands sequence, can be loaded and executed directly by clicking the “Browse” button, selecting a file, and clicking the “Execute Script” button as shown in Figure 202.

The script file must be a text file with valid commands.

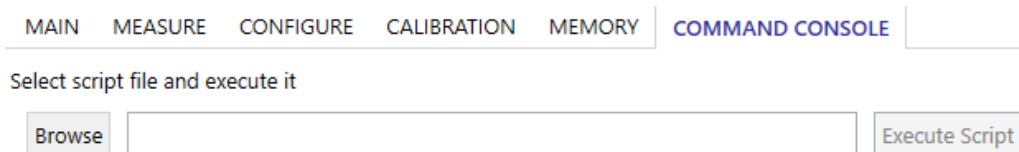

Figure 202. Script Execution

### 11.2 Type Single Command and Execute

A single command can be executed using the entry field displayed in Figure 203.

Type in a single command and execute it



Figure 203. Single Command execution

The list of the commands is available upon request.

### 11.3 Result Display

The result of the execution of a command is returned in the area displayed in Figure 204.

Result Display

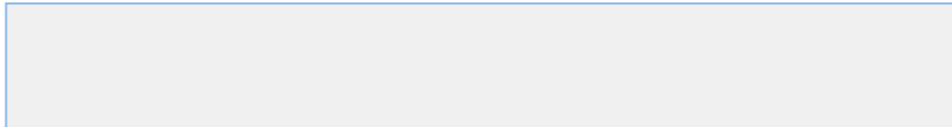
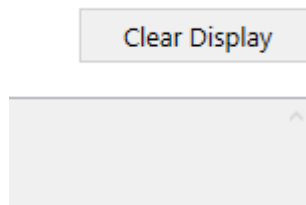

**Figure 204. Command Execution Result**

The output data from the ZSSC3281 can be copied and saved for further analysis by right-clicking on the results in the display.

### 11.4 Clear Display

Once a command is executed and the relevant result is displayed, the display area may be cleared using the “Clear Display” button (see Figure 205).



**Figure 205. Clear Display**

## 12. Glossary

Term	Description
2WCL	Two Wire Current Loop
AFE	Analog Front End
AUX	Auxiliary
CB	Communication Board
CMD	Command
DUT	Device Under Test
EOC	End of Conversion
ESD	Electro Static Discharge
EVB	Evaluation Board
EVK	Evaluation Kit
FS	Full Scale
FW	Firmware
GND	Ground
GUI	Graphical User Interface
HW	Hardware
IC	Integrated Circuit
JP	Jumper
NTC	Negative Temperature Coefficient
NVM	Non Volatile Memory
OWI	One Wire Interface
PC	Personal Computer
PCB	Printed Circuit Board
SM-	Sensor Measurement Negative
SM+	Sensor Measurement Positive
SRB	Sensor Replacement Board
SSC	Sensor Signal Conditioner

## 13. SW and FW Release References

GUI SW Release	FW Release
1.5.0	1.4.0

## 14. Revision History

Revision	Date	Description
1.2	Jan 24, 2024	Update to newer Firmware and Gui Version, adding Chapter 5.7.4
1.1	May 9, 2023	Update to newer Firmware and GUI Version
1.00	Jun 14, 2022	Initial release.

## Notice

1. Descriptions of circuits, software and other related information in this document are provided only to illustrate the operation of semiconductor products and application examples. You are fully responsible for the incorporation or any other use of the circuits, software, and information in the design of your product or system. Renesas Electronics disclaims any and all liability for any losses and damages incurred by you or third parties arising from the use of these circuits, software, or information.
2. Renesas Electronics hereby expressly disclaims any warranties against and liability for infringement or any other claims involving patents, copyrights, or other intellectual property rights of third parties, by or arising from the use of Renesas Electronics products or technical information described in this document, including but not limited to, the product data, drawings, charts, programs, algorithms, and application examples.
3. No license, express, implied or otherwise, is granted hereby under any patents, copyrights or other intellectual property rights of Renesas Electronics or others.
4. You shall be responsible for determining what licenses are required from any third parties, and obtaining such licenses for the lawful import, export, manufacture, sales, utilization, distribution or other disposal of any products incorporating Renesas Electronics products, if required.
5. You shall not alter, modify, copy, or reverse engineer any Renesas Electronics product, whether in whole or in part. Renesas Electronics disclaims any and all liability for any losses or damages incurred by you or third parties arising from such alteration, modification, copying or reverse engineering.
6. Renesas Electronics products are classified according to the following two quality grades: "Standard" and "High Quality". The intended applications for each Renesas Electronics product depends on the product's quality grade, as indicated below.
  - "Standard": Computers; office equipment; communications equipment; test and measurement equipment; audio and visual equipment; home electronic appliances; machine tools; personal electronic equipment; industrial robots; etc.
  - "High Quality": Transportation equipment (automobiles, trains, ships, etc.); traffic control (traffic lights); large-scale communication equipment; key financial terminal systems; safety control equipment; etc.
- Unless expressly designated as a high reliability product or a product for harsh environments in a Renesas Electronics data sheet or other Renesas Electronics document, Renesas Electronics products are not intended or authorized for use in products or systems that may pose a direct threat to human life or bodily injury (artificial life support devices or systems; surgical implantations; etc.), or may cause serious property damage (space system; undersea repeaters; nuclear power control systems; aircraft control systems; key plant systems; military equipment; etc.). Renesas Electronics disclaims any and all liability for any damages or losses incurred by you or any third parties arising from the use of any Renesas Electronics product that is inconsistent with any Renesas Electronics data sheet, user's manual or other Renesas Electronics document.
7. No semiconductor product is absolutely secure. Notwithstanding any security measures or features that may be implemented in Renesas Electronics hardware or software products, Renesas Electronics shall have absolutely no liability arising out of any vulnerability or security breach, including but not limited to any unauthorized access to or use of a Renesas Electronics product or a system that uses a Renesas Electronics product. RENESAS ELECTRONICS DOES NOT WARRANT OR GUARANTEE THAT RENESAS ELECTRONICS PRODUCTS, OR ANY SYSTEMS CREATED USING RENESAS ELECTRONICS PRODUCTS WILL BE INVULNERABLE OR FREE FROM CORRUPTION, ATTACK, VIRUSES, INTERFERENCE, HACKING, DATA LOSS OR THEFT, OR OTHER SECURITY INTRUSION ("Vulnerability Issues"). RENESAS ELECTRONICS DISCLAIMS ANY AND ALL RESPONSIBILITY OR LIABILITY ARISING FROM OR RELATED TO ANY VULNERABILITY ISSUES. FURTHERMORE, TO THE EXTENT PERMITTED BY APPLICABLE LAW, RENESAS ELECTRONICS DISCLAIMS ANY AND ALL WARRANTIES, EXPRESS OR IMPLIED, WITH RESPECT TO THIS DOCUMENT AND ANY RELATED OR ACCOMPANYING SOFTWARE OR HARDWARE, INCLUDING BUT NOT LIMITED TO THE IMPLIED WARRANTIES OF MERCHANTABILITY, OR FITNESS FOR A PARTICULAR PURPOSE.
8. When using Renesas Electronics products, refer to the latest product information (data sheets, user's manuals, application notes, "General Notes for Handling and Using Semiconductor Devices" in the reliability handbook, etc.), and ensure that usage conditions are within the ranges specified by Renesas Electronics with respect to maximum ratings, operating power supply voltage range, heat dissipation characteristics, installation, etc. Renesas Electronics disclaims any and all liability for any malfunctions, failure or accident arising out of the use of Renesas Electronics products outside of such specified ranges.
9. Although Renesas Electronics endeavors to improve the quality and reliability of Renesas Electronics products, semiconductor products have specific characteristics, such as the occurrence of failure at a certain rate and malfunctions under certain use conditions. Unless designated as a high reliability product or a product for harsh environments in a Renesas Electronics data sheet or other Renesas Electronics document, Renesas Electronics products are not subject to radiation resistance design. You are responsible for implementing safety measures to guard against the possibility of bodily injury, injury or damage caused by fire, and/or danger to the public in the event of a failure or malfunction of Renesas Electronics products, such as safety design for hardware and software, including but not limited to redundancy, fire control and malfunction prevention, appropriate treatment for aging degradation or any other appropriate measures. Because the evaluation of microcomputer software alone is very difficult and impractical, you are responsible for evaluating the safety of the final products or systems manufactured by you.
10. Please contact a Renesas Electronics sales office for details as to environmental matters such as the environmental compatibility of each Renesas Electronics product. You are responsible for carefully and sufficiently investigating applicable laws and regulations that regulate the inclusion or use of controlled substances, including without limitation, the EU RoHS Directive, and using Renesas Electronics products in compliance with all these applicable laws and regulations. Renesas Electronics disclaims any and all liability for damages or losses occurring as a result of your noncompliance with applicable laws and regulations.
11. Renesas Electronics products and technologies shall not be used for or incorporated into any products or systems whose manufacture, use, or sale is prohibited under any applicable domestic or foreign laws or regulations. You shall comply with any applicable export control laws and regulations promulgated and administered by the governments of any countries asserting jurisdiction over the parties or transactions.
12. It is the responsibility of the buyer or distributor of Renesas Electronics products, or any other party who distributes, disposes of, or otherwise sells or transfers the product to a third party, to notify such third party in advance of the contents and conditions set forth in this document.
13. This document shall not be reprinted, reproduced or duplicated in any form, in whole or in part, without prior written consent of Renesas Electronics.
14. Please contact a Renesas Electronics sales office if you have any questions regarding the information contained in this document or Renesas Electronics products.

(Note1) "Renesas Electronics" as used in this document means Renesas Electronics Corporation and also includes its directly or indirectly controlled subsidiaries.

(Note2) "Renesas Electronics product(s)" means any product developed or manufactured by or for Renesas Electronics.

(Disclaimer Rev.5.0-1 October 2020)

## Corporate Headquarters

TOYOSU FORESIA, 3-2-24 Toyosu,  
Koto-ku, Tokyo 135-0061, Japan  
[www.renesas.com](http://www.renesas.com)

## Trademarks

Renesas and the Renesas logo are trademarks of Renesas Electronics Corporation. All trademarks and registered trademarks are the property of their respective owners.

## Contact Information

For further information on a product, technology, the most up-to-date version of a document, or your nearest sales office, please visit:  
[www.renesas.com/contact/](http://www.renesas.com/contact/)