

Quick start ADC1x43D DB

Demonstration board for ADC1443D series

Rev. 02 — 2 July 2012

Quick start

Document information

Info	Content
Keywords	ADC1x43D DB, ADC1X43xxW1DB, ADC1443D series, demonstration board, ADC, Converter, JESD204B, BSX0254.
Abstract	This document describes how to use the demonstration board ADC1443D DB for the analog-to-digital converter ADC1443D dual channel ADC with JESD204B interface.

Overview

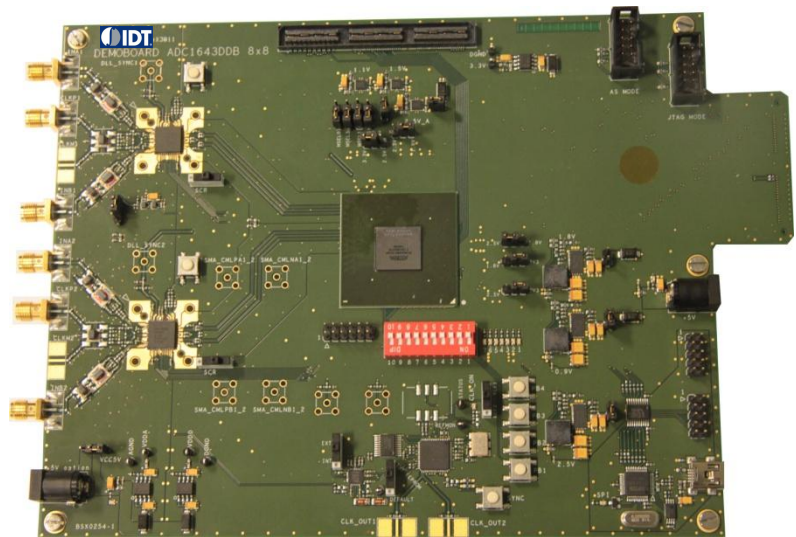

The Board is available in 3 version 125, 160 and 200 Mps sampling rate, with relative naming ADC1443D125W1/DB; ADC1443D160W1/DB; ADC1443D200W1/DB

Revision history

Rev	Date	Description
1	17 th October 2011	Initial version
2	2 July 2012	Rebranded



1. Overview of the demo board ADC1x43D DB

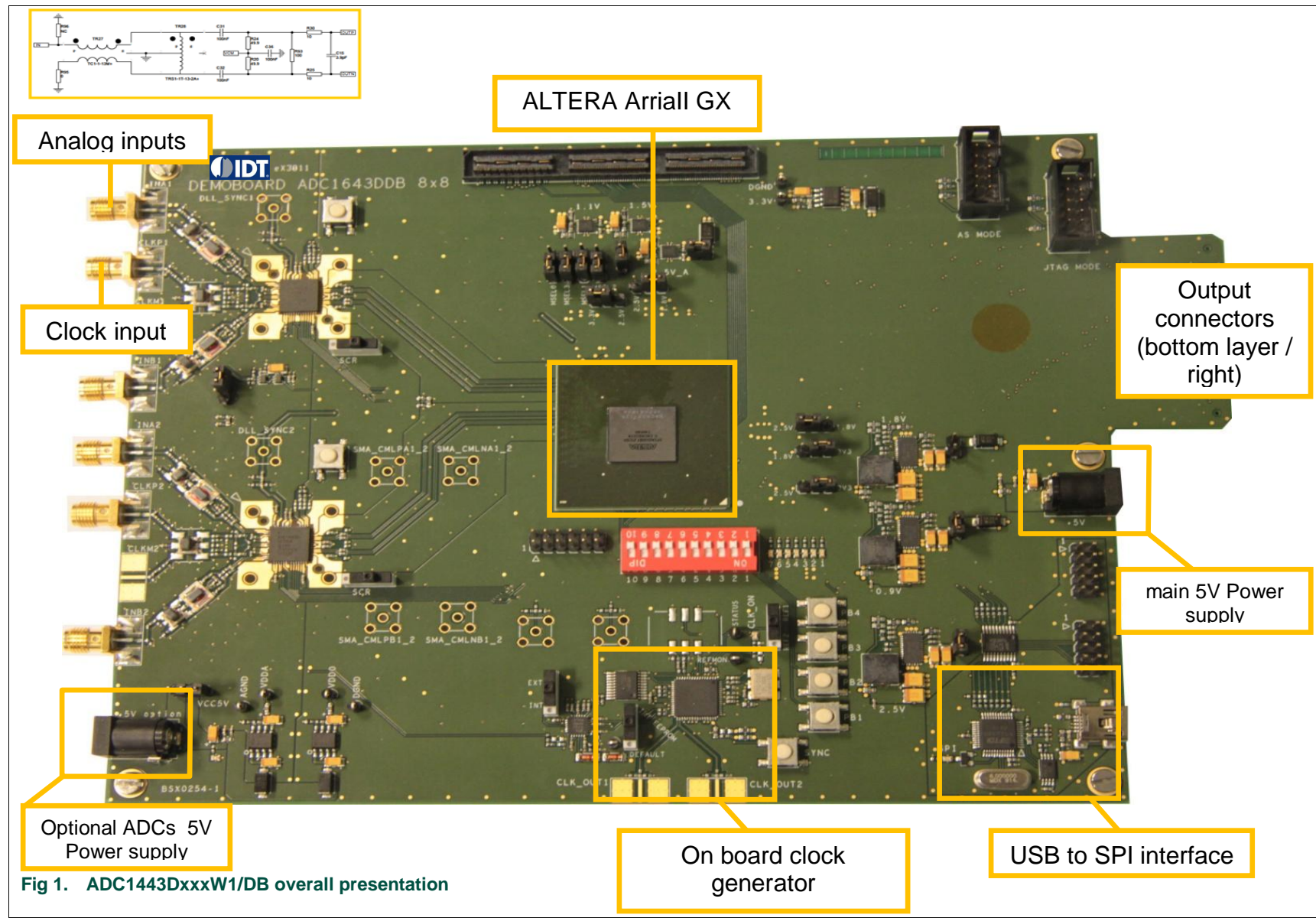

Fig 1. ADC1443DxxxW1/DB overall presentation

2. Switch and Jumpers default state

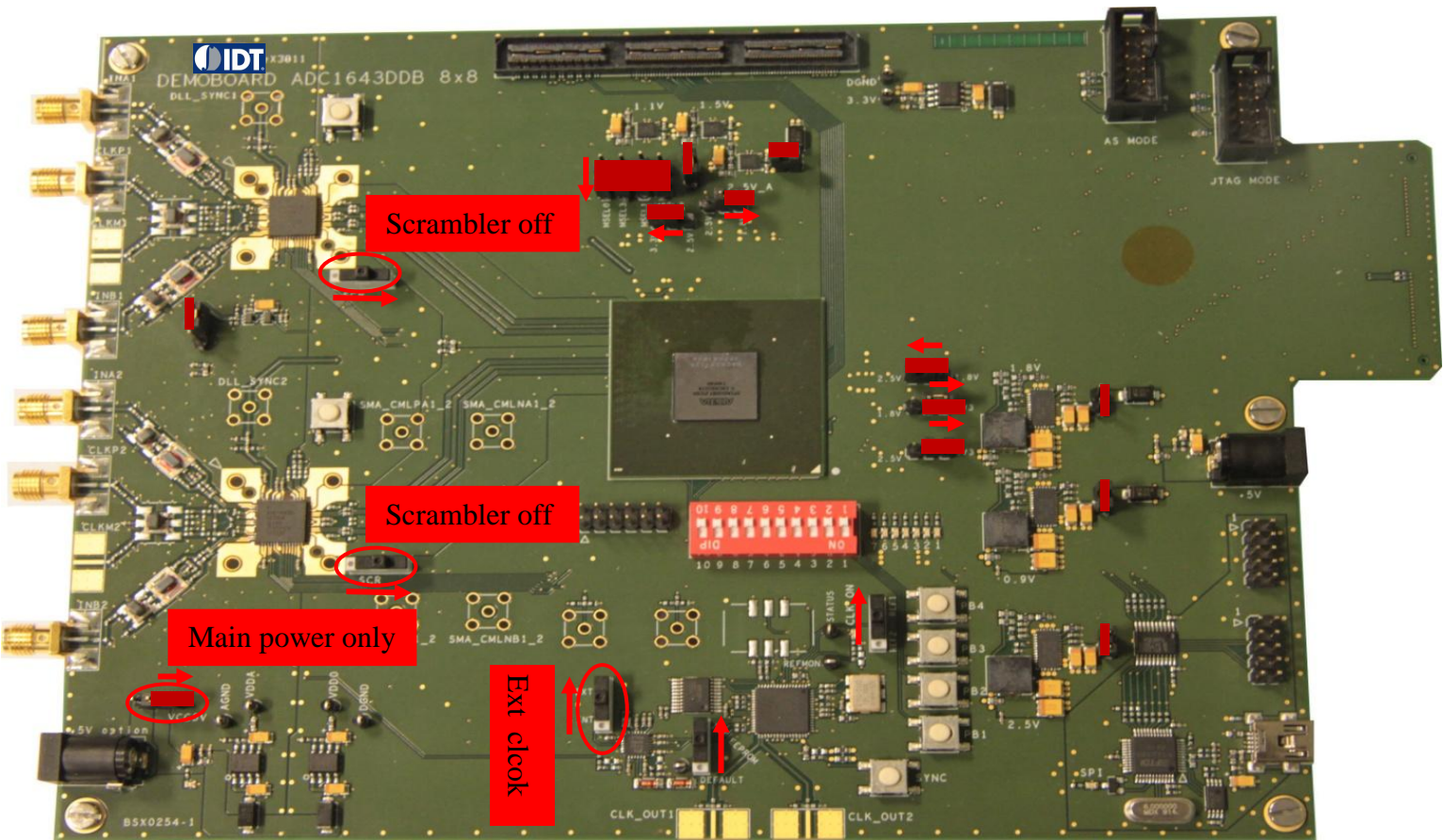

Fig 2. Overall presentation of default switches and jumpers

3. Board goal and general description

The ADC1443DxxxW1/DBboard is aimed to provide a full and complete set to evaluate and demonstrate the ADC1x43D series, analog to digital converters, compliant with JESD204B JEDEC serialization standard.

- **The ADCs**

The board embeds 2 dual ADC devices both connected to the ALTERA Arria11 GX FPGA to de-serialize the ADC output according to the JESD204B physical and protocol layer.

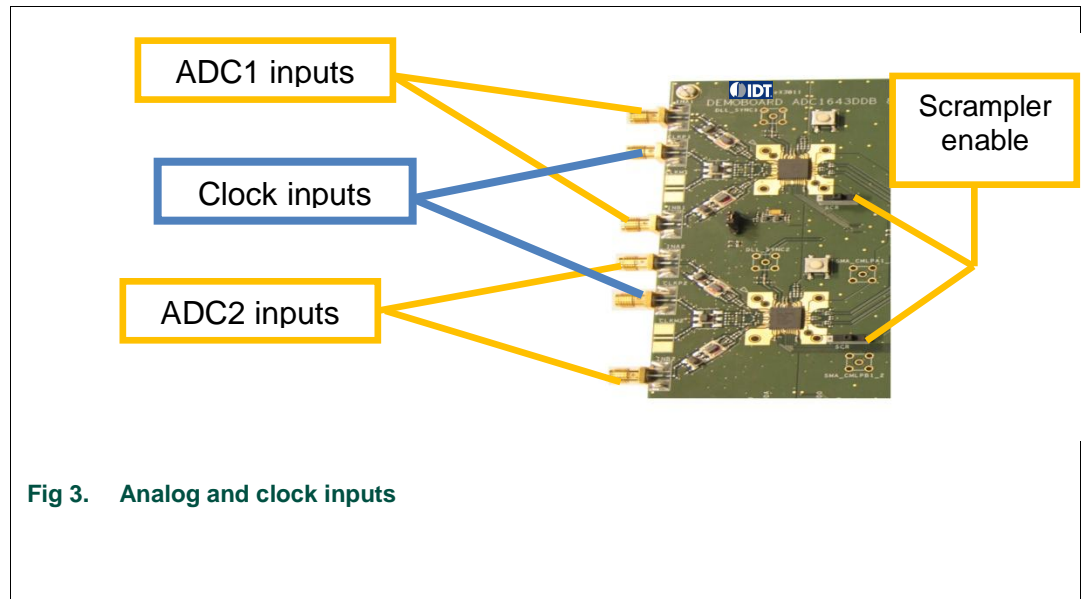

Fig 3. Analog and clock inputs

Each ADC is dual channel and need to be fed with single ended input (from SMA connector).

Input clock is also single ended when using an external clock generator.

- **The Clock Generator**

An embedded clock generator is also on the board. The HSDC_SW_ADC_4.exe application allow to configure and control the clock generation.

When using it, some PCB soldering modification needs to be operated on the board (see board schematic for more information).

The default configuration is for use with external clock generator, and hence, main selector Jumper J301 has to be set to “EXT” position.

- **Power supplies**

The board embeds two 5V power supplies connector (one main, on right side to power-up all the board components, and a second optional, on the left side of the board, to power-up the ADCs linear regulators).

Selection of the 5V that power the ADCs regulators is done through the Jumper VCC5V.

When Jumper is set to the right (see figure 4), only powering from main connector is required

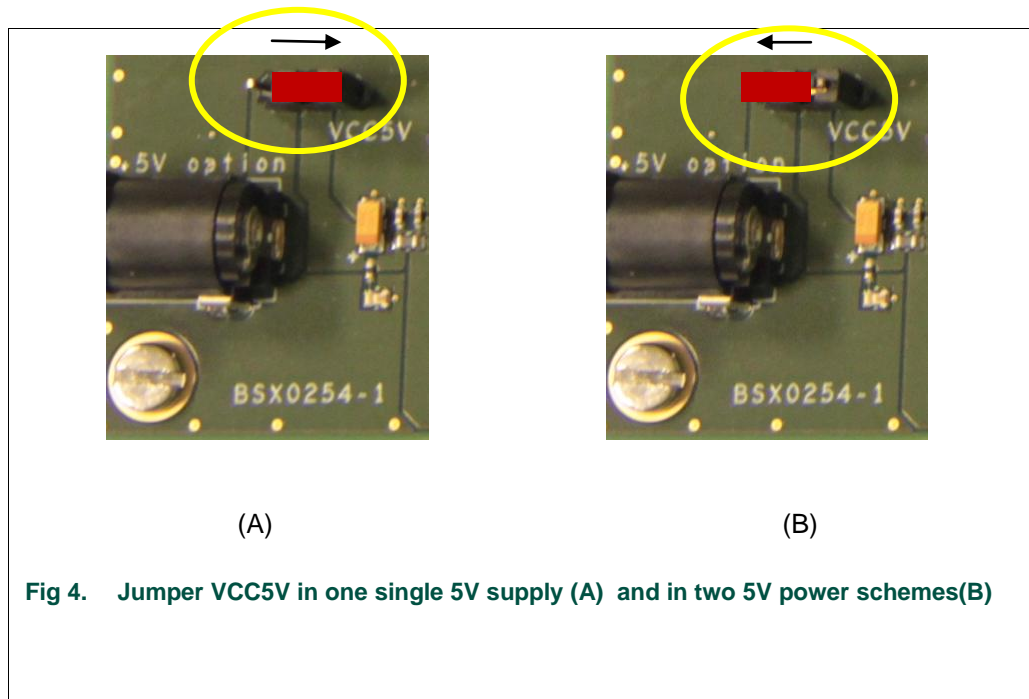

Other jumpers are kept on their default value.

Best SNR performances are seen when using separate power supplies for ADC, since the Switching FPGA power supplies add some noise to the supplies layers

▪ **Receiving the serial pattern**

The Arijall GX FPGA is provided with Binary code already burned in internal 64M serial EEPROM memory (bottom side), both FPGA and the EEPROM are accessible via the 2 connectors AS MODE and JTAG mode.

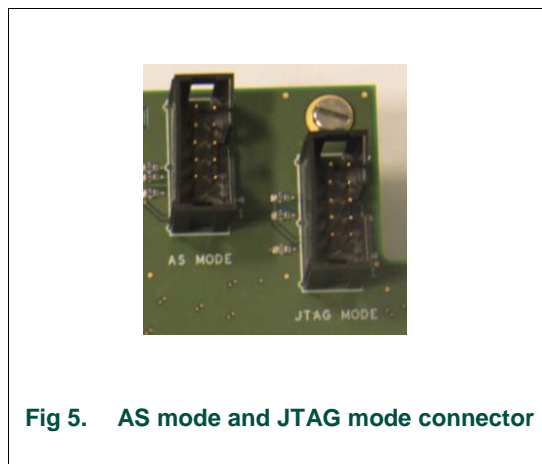

To operate any FPGA programming, you need to get the free Quartus tool from ALTERA and the ALTERA USB BLASTER that you plug to either AS Mode connector, when

burning to the Active Serial EEPROM or to JTAG Mode when accessing directly the FPGA.

The FPGA is responsible for de-serializing the serial stream coming From the ADC, according to the JESD204B standard.

Since we have 2 dual ADC on the board, each with 2 lanes, the HSDC_SW_ADC_4.exe application allow to configure the FPGA and to choose which channel, ADC, lanes we are talking to.

FPGA is accessible via SPI and also through some GPIO (DIP switch SW700) and push button PB1 to PB4.

Main used are Dip switch “1” to allow Scrambling in the FPGA and PB3 to do a manual FPGA reset.

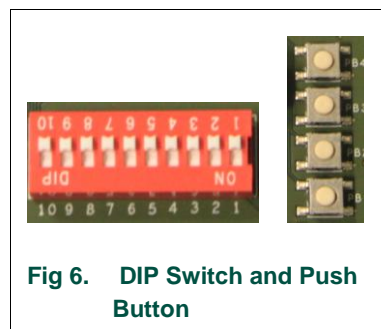

Fig 6. DIP Switch and Push Button

LED Information from the FPGA are available also,

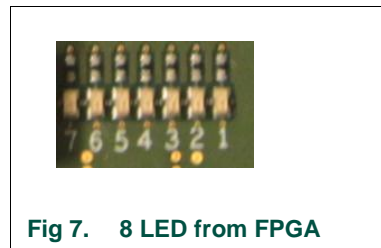

Fig 7. 8 LED from FPGA

LED 7 and 8 show , when toggling , that ADC is fed with clock and that CDR (clock and data recovery) is operating.

LED 5, shows SPI activity when FPGA is selected.

Once the FPGA has decoded the Serial stream, It is stocked into a size variable internal memory (from 4K to 64k) and could be uploaded via SPI-to-USB to the HSDC_SW_ADC_4.exe application and displayed as an FFT with all relevant information extracted.

Digital parallel pattern could be send in LVDS DDR ou LVCMOS to a Sametc output connector (on the bottom side of the board) if the user want to connect an external acquisition system.

Addition High speed mezzanine connector (HSMC) is connected to the FPGA Tx and Rx SerDes and could allow plugging an extension board.

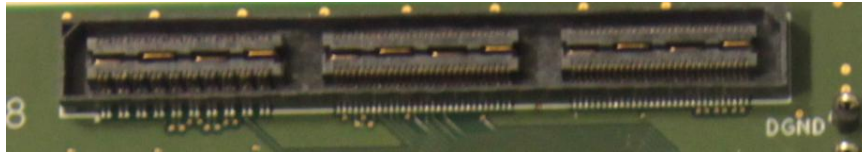

Fig 8. HSMC female connector for extension board

▪ USB interface

The USB interface acts like a programming interface.

The main chip is an FTDI FT2232D that interface the USB Physical layer to the SPI interface for the Two ADCs and the clock generator.

The Board comes with the HSDC_SW_ADC_4.exe application that controls all these components via USB.

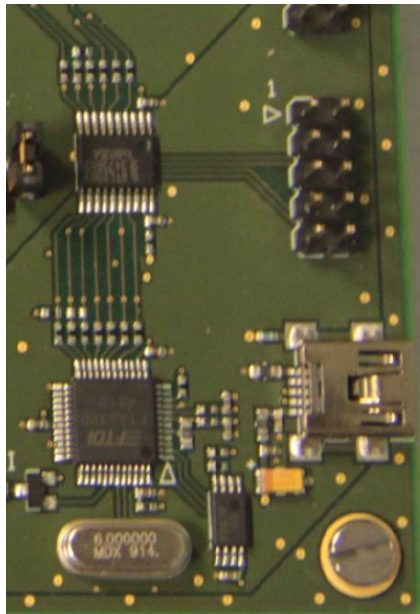
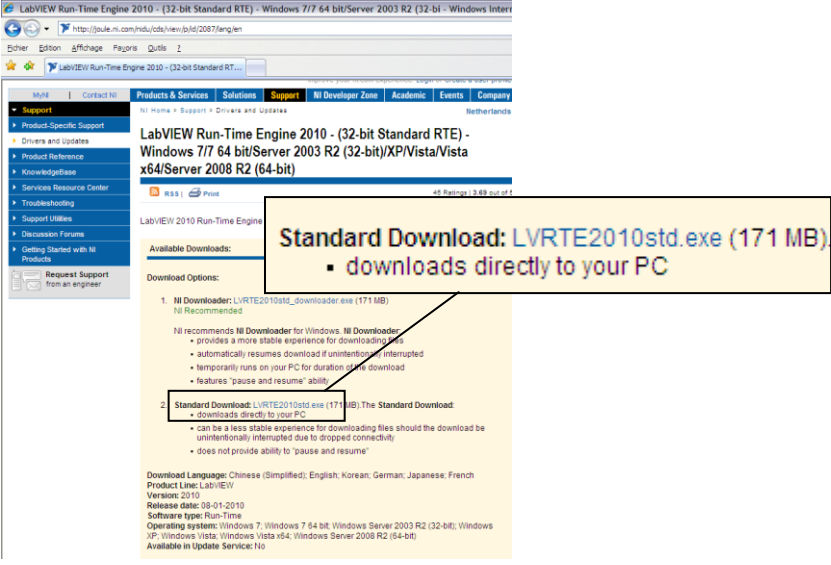
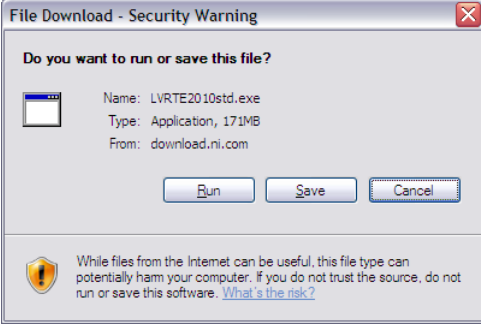





Fig 9. USB-to-SPI interface

Further instructions on how to install and operate the software are detailed in next section.



4. Software and drivers install

4.1 Labview Runtime 2010 install

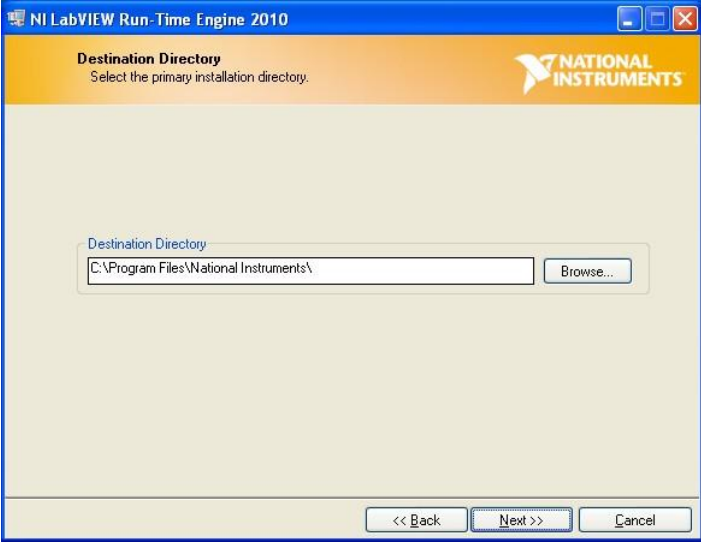
1	Go to National Instruments web page http://joule.ni.com/nidu/cds/view/p/id/2087/lang/en	
2	Download 'LVRTE2010std.exe'	
3	Save	
4	Run the application 'LVRTE2010std.exe'	
5	OK	
6	Unzip	

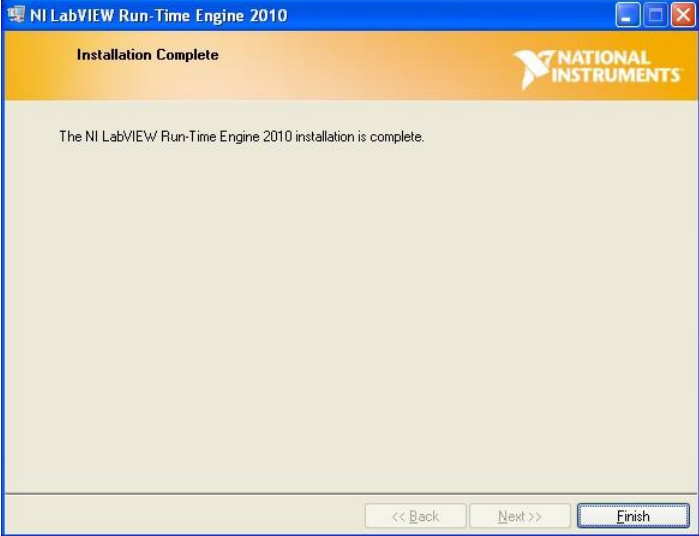

7	OK	 <p>WinZip Self-Extractor</p> <p>240 file(s) unzipped successfully</p> <p>OK</p>
8	Next	 <p>NI LabVIEW Run-Time Engine 2010</p> <p>ni.com/labview</p> <p>NATIONAL INSTRUMENTS LabVIEW™ 2010</p> <p>Exit all programs before running this Setup. Disabling virus scanning utilities may improve installation speed. This program is subject to the accompanying License Agreement(s).</p> <p>National Instruments Corporation is an authorized distributor of Microsoft Silverlight.</p> <p>© 2010 National Instruments. All rights reserved.</p> <p>NATIONAL INSTRUMENTS</p> <p><< Back Next >> Cancel</p>
9	Next	 <p>NI LabVIEW Run-Time Engine 2010</p> <p>Destination Directory Select the primary installation directory.</p> <p>NATIONAL INSTRUMENTS</p> <p>Destination Directory C:\Program Files\National Instruments\ Browse...</p> <p><< Back Next >> Cancel</p>

<p>10</p>	<p>Next</p>	
<p>11</p>	<p>Select 'I accept the License Agreement'</p> <p>Next</p>	
<p>12</p>	<p>Next</p>	

13	Finish	
14	Restart	

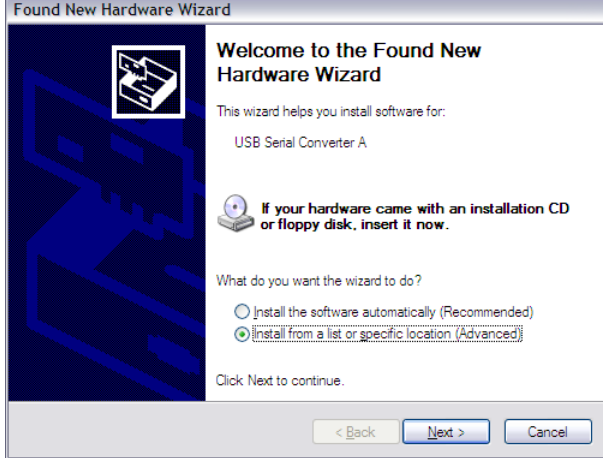
4.2 Demoboard - USB-SPI driver install

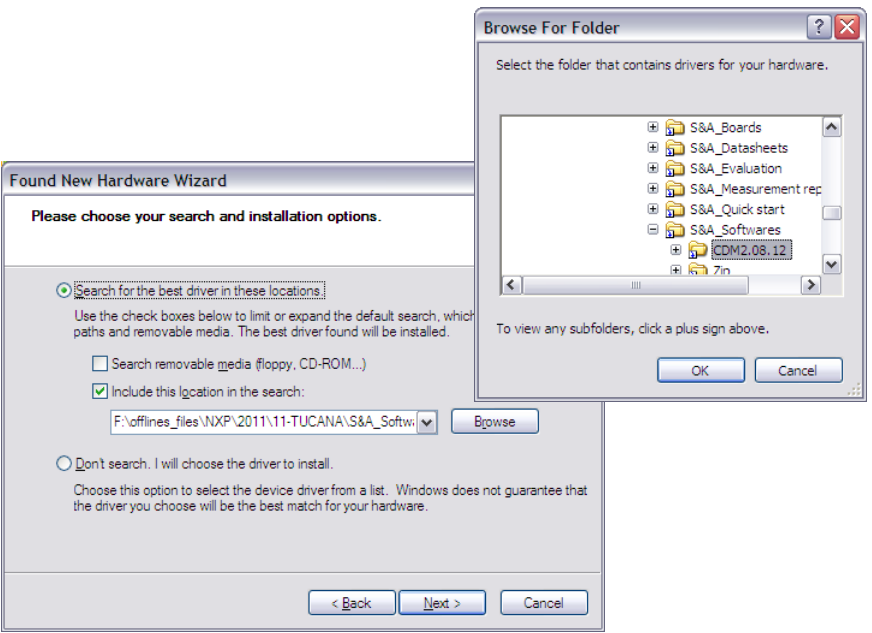
1	Plug the USB cable in the demoboard USB connector	
2	The wizard will help to install the USB Serial Converter A	
3	<p>Select 'Install from a list or specific location'</p> <p>Next</p>	

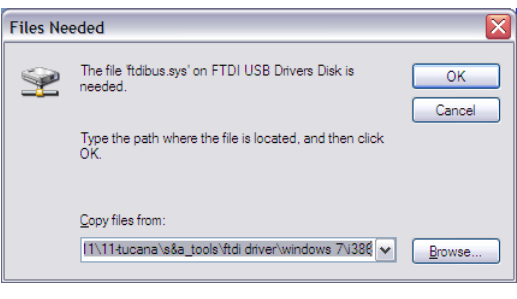
<p>4</p> <p>Select 'Search for the best driver in these locations'</p> <p>Select 'Include this location in the search'</p> <p>Browse</p> <p>Select the folder 'CDM2.08.12'</p> <p>Next</p>	 <p>The image shows two overlapping Windows dialog boxes. The background box is the 'Found New Hardware Wizard' with the title 'Please choose your search and installation options.' The 'Search for the best driver in these locations' radio button is selected. Below it, the 'Include this location in the search' checkbox is checked, and the path 'F:\offlines_files\NXP\2011\11-TUCANA\S&A_Softw...' is entered. The foreground box is the 'Browse For Folder' dialog, showing a tree view of folders with 'CDM2.08.12' selected.</p>
<p>5</p> <p>Continue Anyway (Windows XP only)</p>	 <p>The image shows a 'Hardware Installation' warning dialog box with a yellow warning icon. The text reads: 'The software you are installing for this hardware: USB Serial Converter A has not passed Windows Logo testing to verify its compatibility with Windows XP. Continuing your installation of this software may impair or destabilize the correct operation of your system either immediately or in the future. Microsoft strongly recommends that you stop this installation now and contact the hardware vendor for software that has passed Windows Logo testing.' Buttons for 'Continue Anyway' and 'STOP Installation' are at the bottom.</p>
<p>6</p> <p>Browse</p> <p>Select the file 'ftdibus.sys' in the folder 'CDM2.08.12\i386'</p> <p>OK</p>	 <p>The image shows a 'Files Needed' dialog box. It states: 'The file 'ftdibus.sys' on FTDI USB Drivers Disk is needed.' Below this, it says 'Type the path where the file is located, and then click OK.' The 'Copy files from:' field contains the path 'I:\11tucana\s&a_tools\ftdi driver\windows_7\i386' and a 'Browse...' button is next to it.</p>

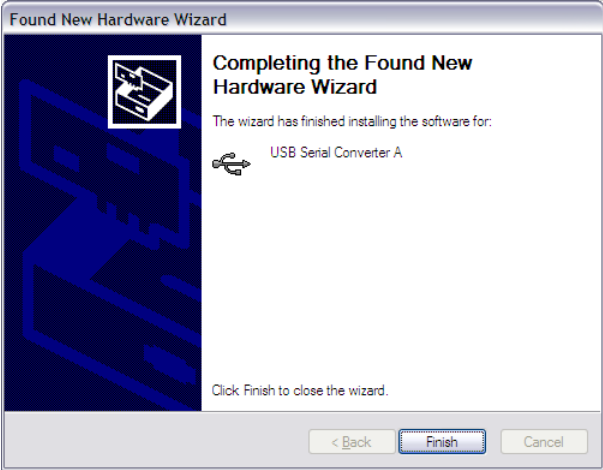
7	Finish	
8	The wizard will help to install the USB Serial Converter B (same as USB Serial Converter A)	
9	The wizard will help to install the USB serial port The file 'ftser2k.sys' is in the folder 'CDM2.08.12\i386'	

5. ADC acquisition tool

5.1 Software start-up

To install the software, please refer to appendix A ‘Software and drivers install’.

Run the application “HSDC_SW_ADC_4.exe”. This application will allow:

- the user to control features through the SPI;
- as well as performing any online data acquisition to evaluate the performances.

5.2 Start-up screen

The screenshot shows the 'IDT HSDC ADC acquisition software' interface. It features a top menu bar with options like 'SPI control - Functional Registers - ADC1443D', 'SPI control - Read / Write Registers', 'Clock control', 'Tools', 'Acquisition', 'GPIB & Test config', and 'Info'. The main window is divided into several sections:

- Left Panel:** Contains configuration fields for 'NXP device' (ADC1443D), 'Chip#', 'Resolution' (14), 'Fin and Fs are' (Coherent), 'Sampling rate Fs' (153,600,000), 'Input frequency Fin' (170,006,250,000), and 'Number of samples' (8192). A prominent orange 'INITIALIZATION' button is located at the bottom of this panel.
- Center Panel:** The 'Acquisition' section includes 'Fin coherent (MHz)' (0), 'Select window type' (No window), 'Enable FFT averaging' (10), and 'Store to file' options. Below this is a plot area for 'FFT Spectrum' showing magnitude vs. frequency.
- Right Panel:** Features 'Select bandwidth mode' (All bandwidth), 'Flow', 'FHigh', 'MDS', and a table of ADC parameters.

Numbered callouts provide the following instructions:

1. Select the wanted IDT product e.g : ADC1443D200
2. Select 'Coherent' for optimized FFT processing. Otherwise select 'Not coherent'
3. 'GREEN' when Acquisition is ready
4. 'GREEN' when USB is ready
5. Click 'INITIALIZATION'
6. Select the number of points for FFT
7. Enter the sampling frequency
8. Enter the input frequency. The coherent frequency will be automatically calculated

An additional callout at the top right states: 'To quit the interface, please click 'quit'' pointing to the 'QUIT' button in the top right corner.

Fig 10. Start-up screen

5.3 Read / Write Registers

1. 'READ ALL REGISTERS' will allow to get an overview of the main analog registers

2. If available, load the settings file

Register name	Address	ADC Register Value			
		A	B	C	D
	00	00	00	00	00
	00	00	00	00	00
	00	00	00	00	00
	00	00	00	00	00
	00	00	00	00	00
	00	00	00	00	00
	00	00	00	00	00
	00	00	00	00	00
	00	00	00	00	00
	00	00	00	00	00
	00	00	00	00	00
	00	00	00	00	00
	00	00	00	00	00
	00	00	00	00	00
	00	00	00	00	00

Fig 11. Read / Write Registers

5.4 Functional Registers

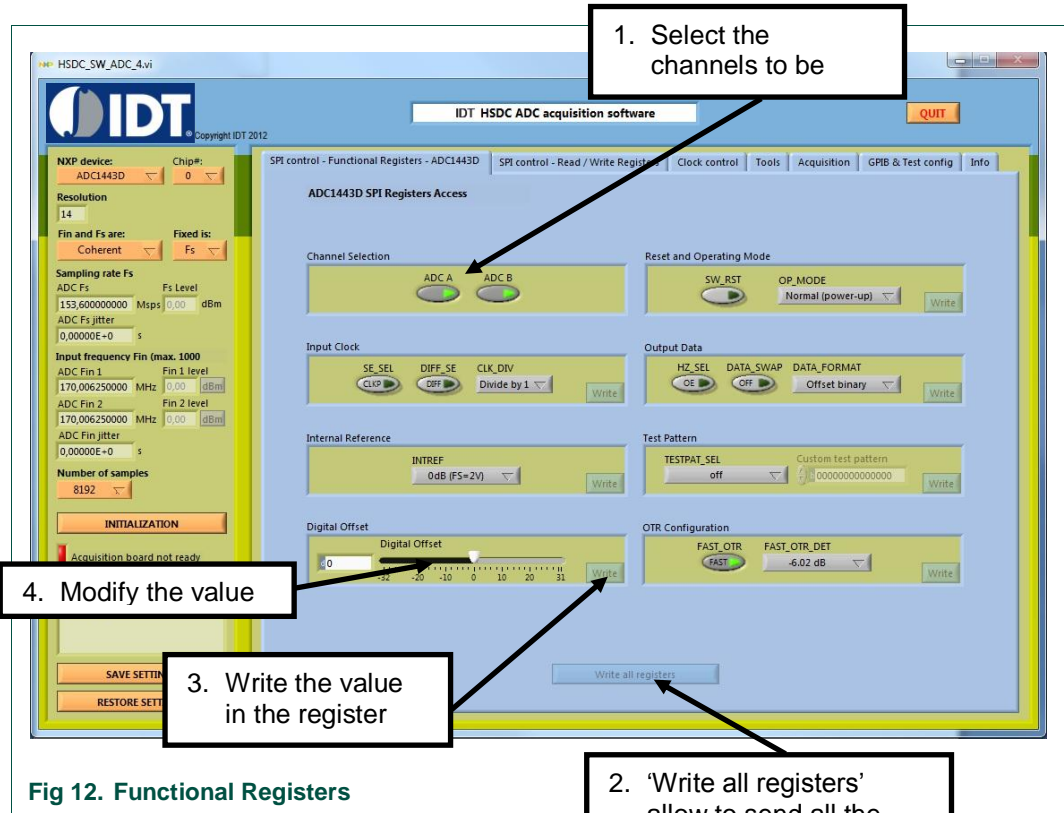

Fig 12. Functional Registers

2. 'Write all registers' allow to send all the values at the same time

5.5 Acquisition

1. If needed, the performances can be calculated over a reduced bandwidth

2. Click acquire to process data acquisition and FFT processing

3. Select 'Continuous acquisition' for real-time processing

4. Select the channel to display

5. If 'Not coherent', select a window for processing

6. Performances are available in the table

Item	ADC1	ADC2	Unit
ADC Digitized signal			
Frequency			MHz
Amplitude			dBFS
ADC AC parameters			
SNR			dBc
SINR			dBFS
ENOB			bits
SFDR			dBc
SFDR			dBFS
THD			dBc
NSD			dBFS/Hz
ADC Harmonics			
H2			dBc
H3			dBc
H4			dBc
H5			dBc
H6			dBc
ADC Code excursion			
Min			codes
Max			codes
Mean			codes

Fig 13. Acquisition



If you have a bad acquisition (especially when changing the frequencies), an FPGA hardware reset, pushing and releasing the PB3, is needed.