

RAA462113FYL

Surveillance Camera Module

Introduction

This document describes key features and operation method about surveillance camera module with RAA262113FYL CMOS image sensor (PDAF).

Target Device

RAA462113FYL

ISL9307

ISL8022

ISL85009

ISL8016

ISL80505

ISL9005A

ISL3170E

When applying the sample program covered in this document to another microcomputer, modify the program according to the specifications for the target microcomputer and conduct an extensive evaluation of the modified program.

Contents

1. Description	3
1.1 Overview	3
1.2 Specifications	3
1.3 Operation Conditions	3
1.4 Configuration	4
1.5 Block Diagram	4
1.6 Outside View	5
2. Operation Setup	7
2.1 Component List	7
2.2 Setup	7
2.3 Network setting	11
2.4 UART & Telnet setting	13
2.5 RTSP Video Play	14
2.5.1 Install VLC media player	14
2.5.2 RTSP streaming output	14
2.5.3 RTSP Video play on VLC	15
2.5.4 Open Media	15
2.6 HDMI Video Play	16
2.7 USB Video Play	17
2.8 WiFi Configuration	19
2.9 Lens Zoom/focus tuning	20
2.10 IR cut	20
2.11 AF trigger	21
2.12 Software update	22
2.13 PQ Tuning	22
2.14 PDAF correction	22

1. Description

1.1 Overview

The surveillance camera module includes a CMOS image sensor (CIS) board with phase-detection autofocus (PDAF), and a high-performance image signal processing (ISP) board along with auto focus zoom lens software.

This reference design enables 4K resolution, excellent color imaging and better recognition accuracy of objects, including small objects in low-light conditions. Its impressive high-speed autofocus operation can also be realized with low-priced lenses. Built around Renesas' high performance RAA462113FYL CMOS image sensor and Novatek's dual core SoC image signal processor, the surveillance camera reference design uses several other Renesas ICs that address its signal chain electrical functions. The CIS board includes the RAA462113FYL, DC/DC buck converters, LDOs, motor driver and lens. The ISP board features the SoC and associated signal chain components.

1.2 Specifications

Table 1.1 lists the specification of surveillance camera module.

Table 1.1 Specifications

Function	Description
Lens mount	Customized lens mount for YT50011DB, CS mount
Video output Interface	USB/ HDMI / Ether/ WiFi
Output resolution	4K
Frame rate	10fps ~ 30fps
Video output format	H.265 / H.264
Video & image capture	RAW
White balance	Auto (2500K to 7500K)
Exposure time	Auto (Max:1/30sec) / Manual(Max:1/5sec (5fps))
Gain control	Auto (Max:72dB including ISP digital gain) / Manual (Max:72dB including ISP digital gain)
HDR (High Dynamic Range)	Manual (Off / On), 4K@30fps (Max) (Under development)
2D Noise reduction filter	Manual (Off / On)
3D Noise reduction filter	Manual (Off / On)
IR cut filter control	Manual (Off / On)
AF function	Hybrid AF(PDAF + Contrast AF),
Zoom control	Optical zoom for YT50011DB (10.9mm ~ 29mm)

1.3 Operation Conditions

Table 1.2 lists operating conditions of surveillance camera module.

Table 1.2 Operation Conditions

Symbol	Item	Rated Value	Note
5.0V	5V power voltage by Type C	4.5V to 5.5V	Vss standard
	Typical consumed current	0.95A	The whole module current consumption powered by 5V
12V	12V power by AC/DC adaptor		
T _{opr}	Operational temperature	-20°C to 70°C	
T _{stg}	Storage temperature	-20°C to 110°C	

Note: Power input can be selected DC 12V or DC 5V.

1.4 Configuration

Figure 1.1 shows an example of system configuration for surveillance camera module.

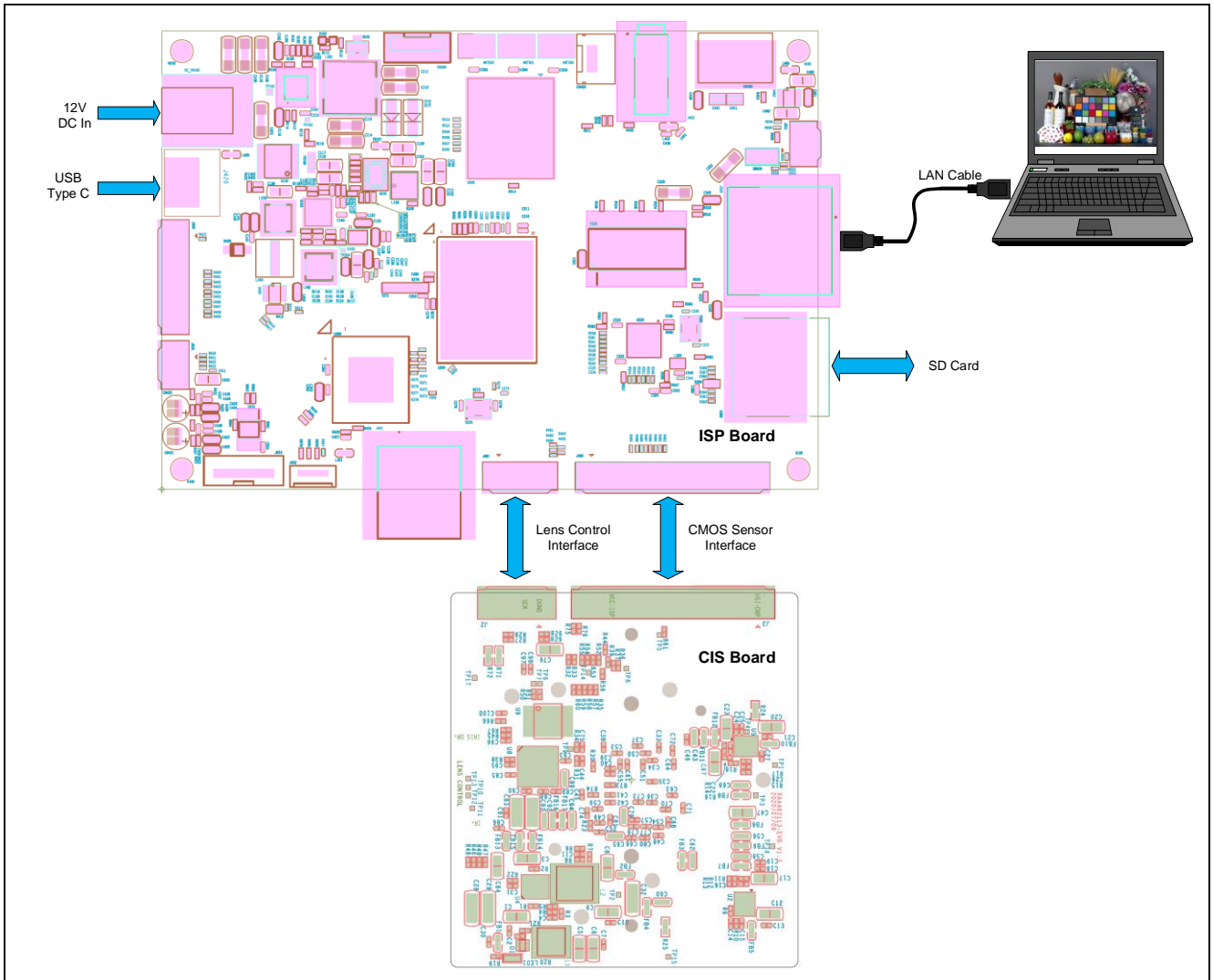

Figure 1.1 Surveillance Camera Module System Configuration

1.5 Block Diagram

Figure 1.2 surveillance camera module block diagram. The blue color blocks are Renesas's products.

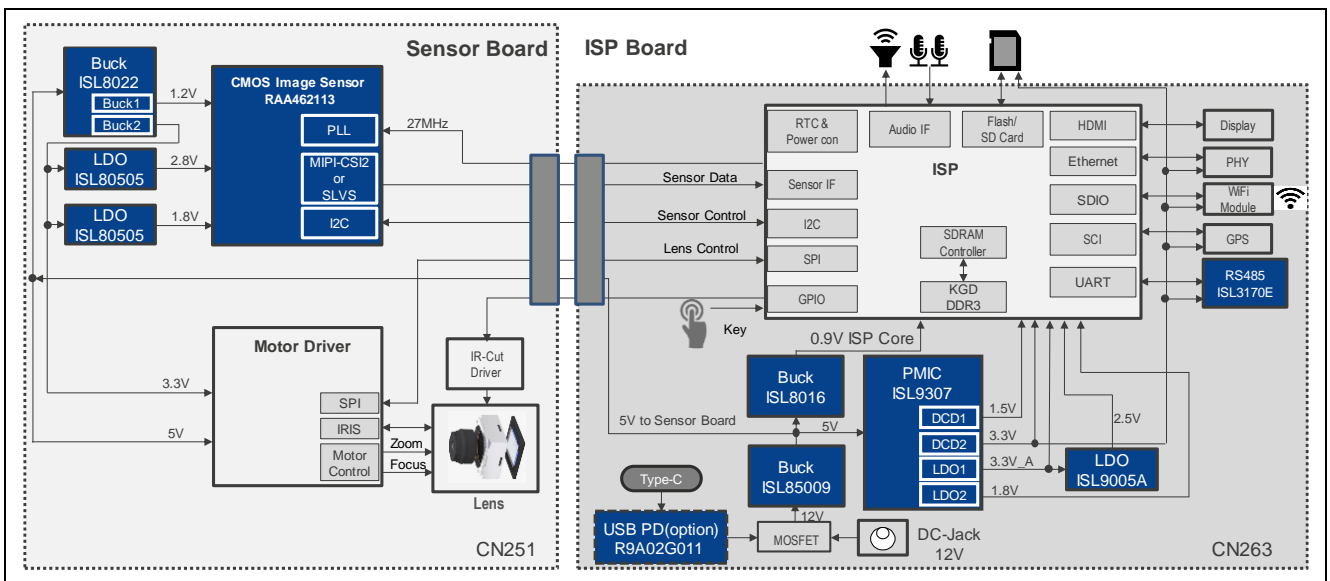

Figure 1.2 Surveillance Camera Module Block Diagram

1.6 Outside View

Figure 1.3 shows the top view of ISP board.

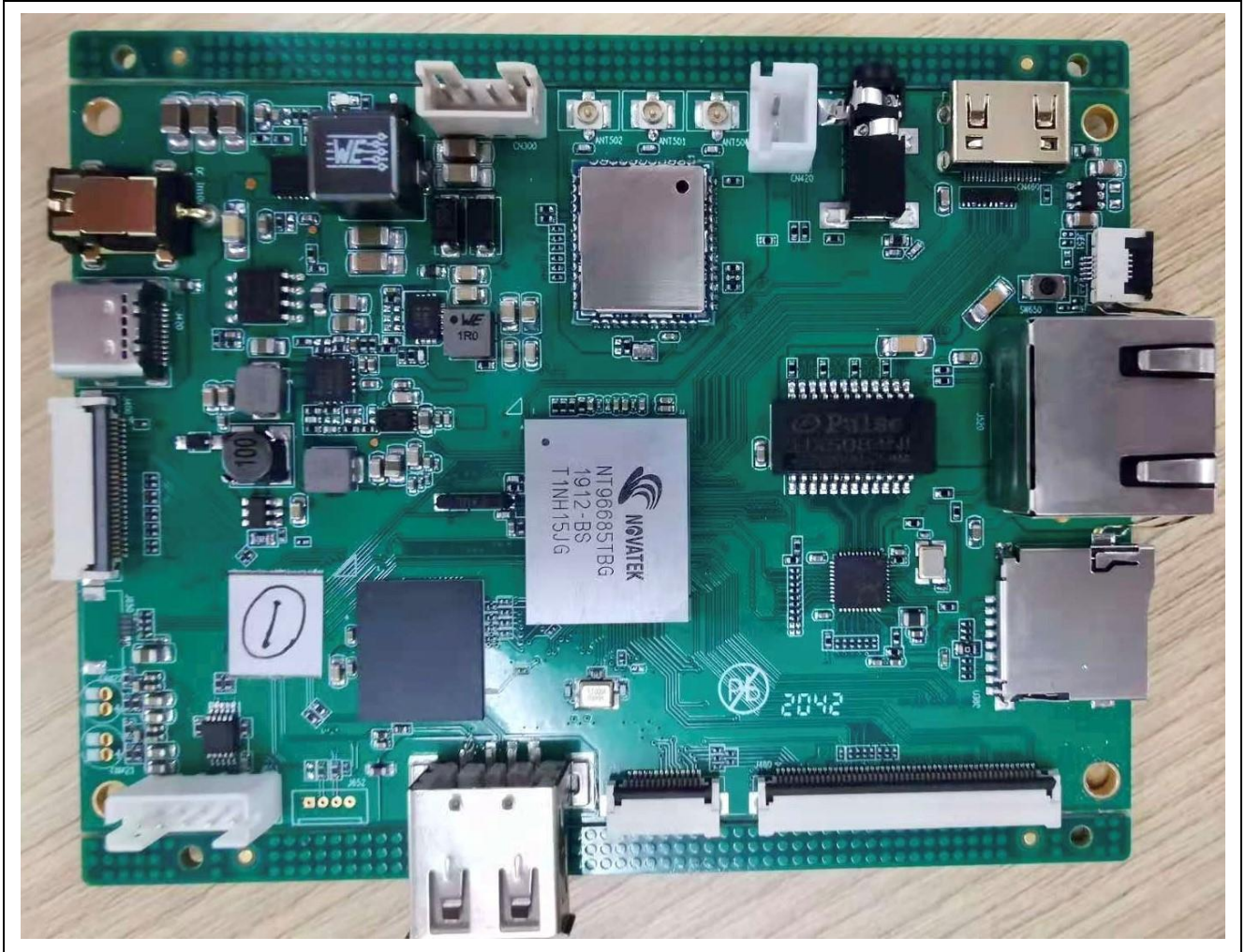

Figure 1.3 Top view of ISP Board

Figure 1.4 shows the top view of CIS board.

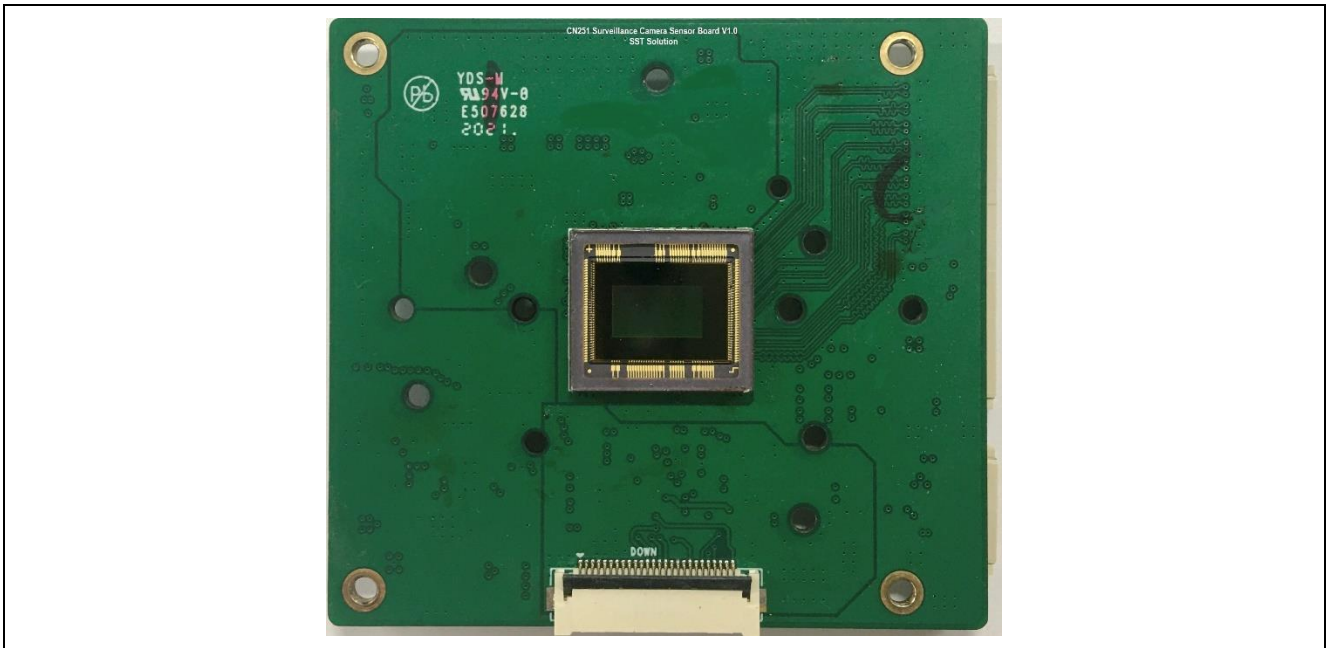

Figure 1.4 Top View of CIS Board

Figure 1.5 shows the bottom view of CIS board.

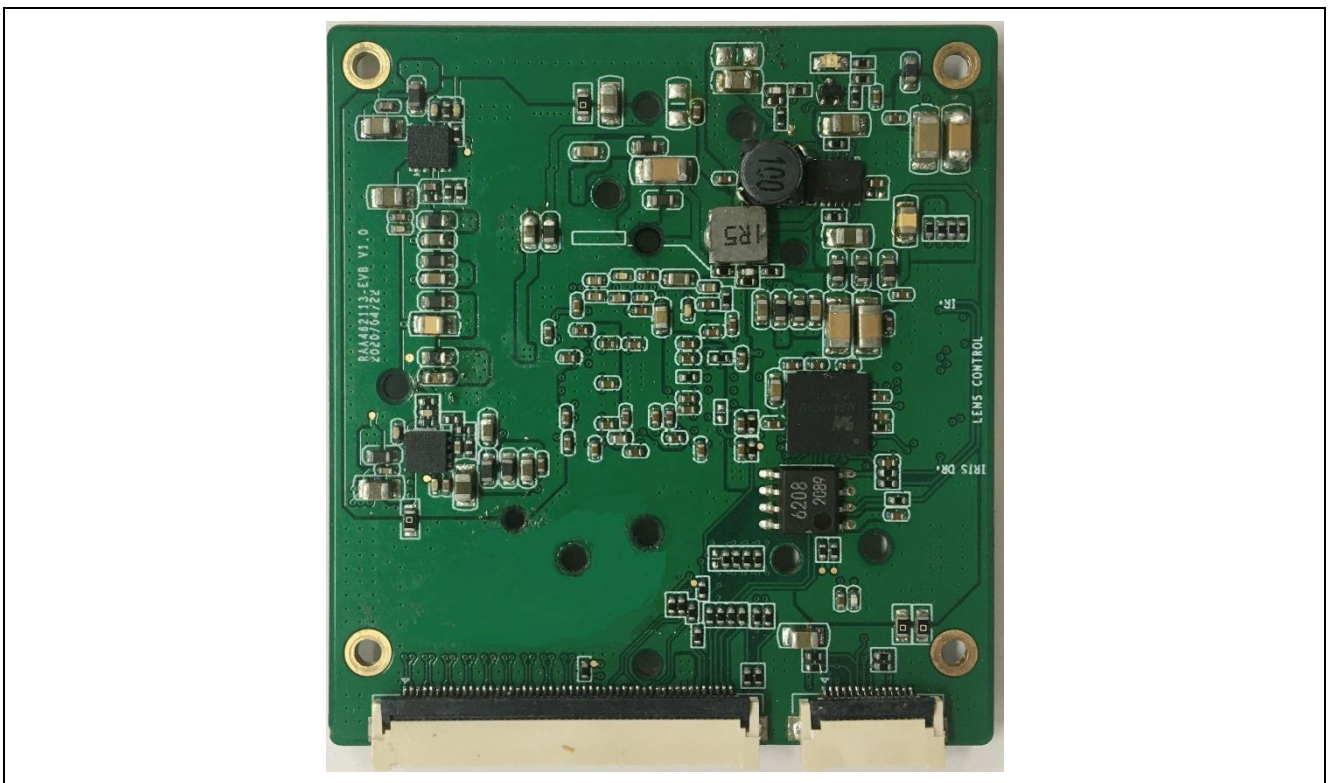

Figure 1.5 Bottom View of CIS Board

2. Operation Setup

2.1 Component List

1) Surveillance Camera



2) 12V DC Adaptor



3) LAN Cable



4) USB Cable



5) USB To UART Convertor

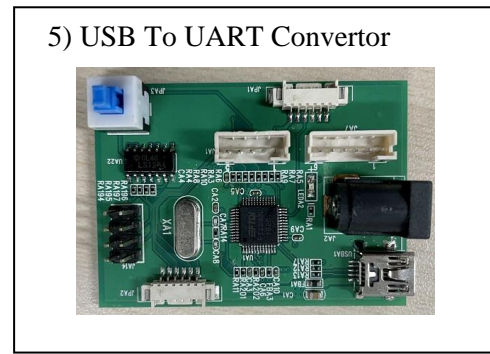

6) UART Cable

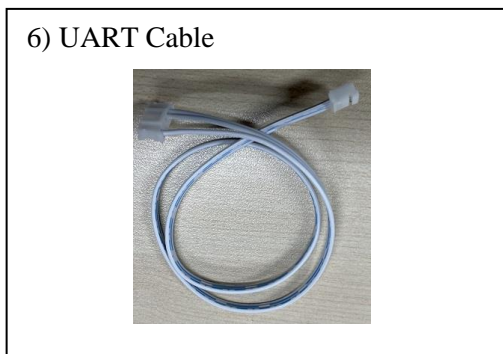

7) WiFi Antenna

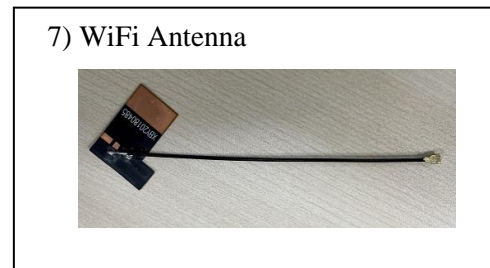

Note: If select other adapter, ensure the output current $> 1.5A$.

2.2 Setup

Figure 2.1 shows the connection LAN cable and USB type-C cable (only for power). Then, power on for the surveillance camera module. Red LED on the back of CIS board will be lighted. DC 12V can power for the surveillance camera module also. Figure 2.2 show the connect of DC 12V with ISP board.

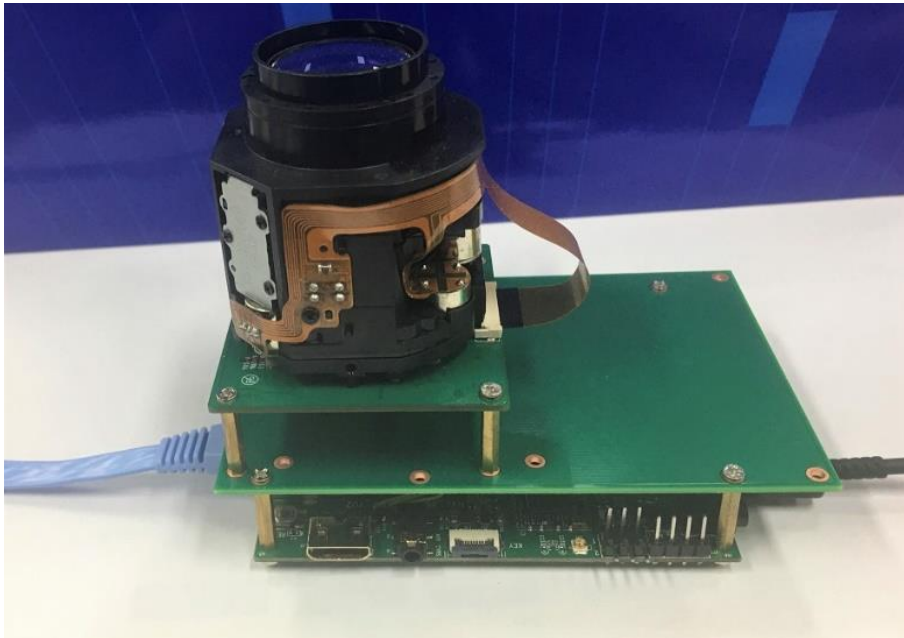

Figure 2.1 LAN and USB Type C Cable Connection



Figure 2.2 DC 12V Power

The following are installation steps if reinstalling the camera module.

- a) Install Lens on CIS board

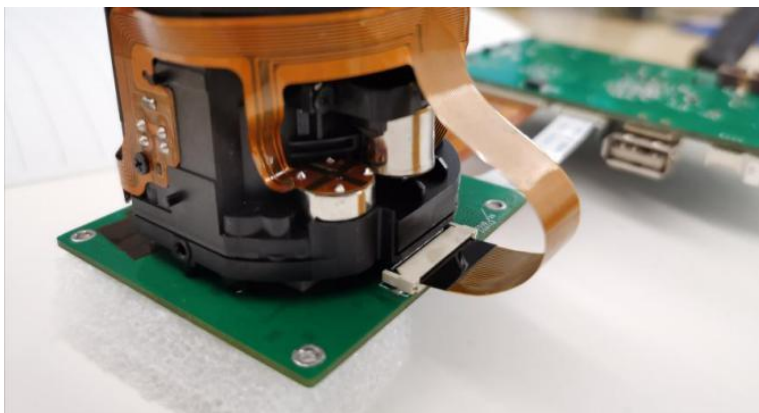

Figure 2.3 Install Lens on CIS Board

- b) Connect ISP board and CIS board by HSI cable & SPI Cable. HIS cable is yellow. SPI cable is white.

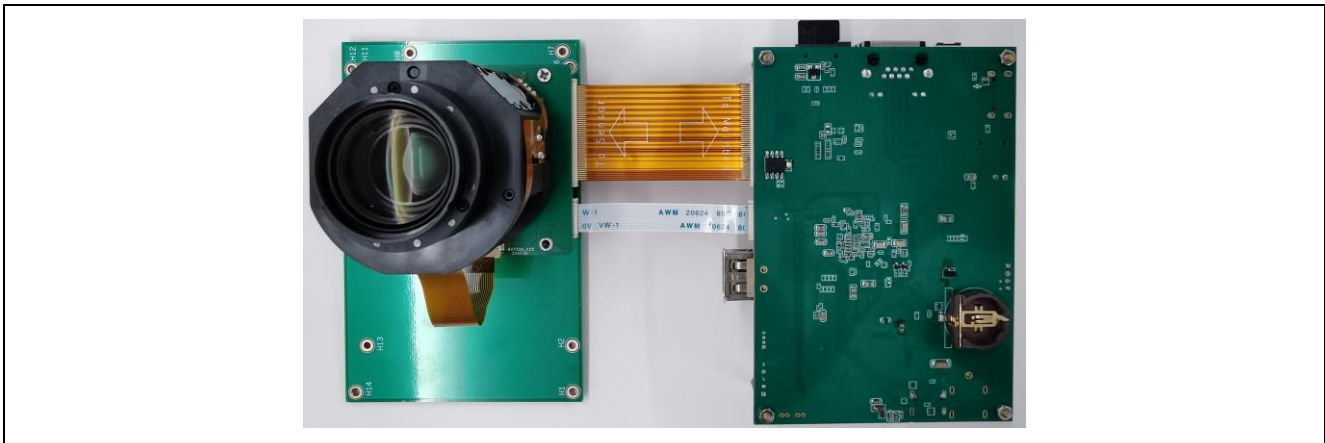

Figure 2.4 Assembly HSI and SPI Cable

- c) Mount ISP board, CIS board & Mounting board together as below.



Figure 2.5 Mount ISP, CIS and Mounting Board

- d) Connect DC 12V power to ISP board DC 12V socket. Or connect TYPE-C connector to type-c connector.
 e) Connect to PC by ethernet RJ45 connector with LAN cable.

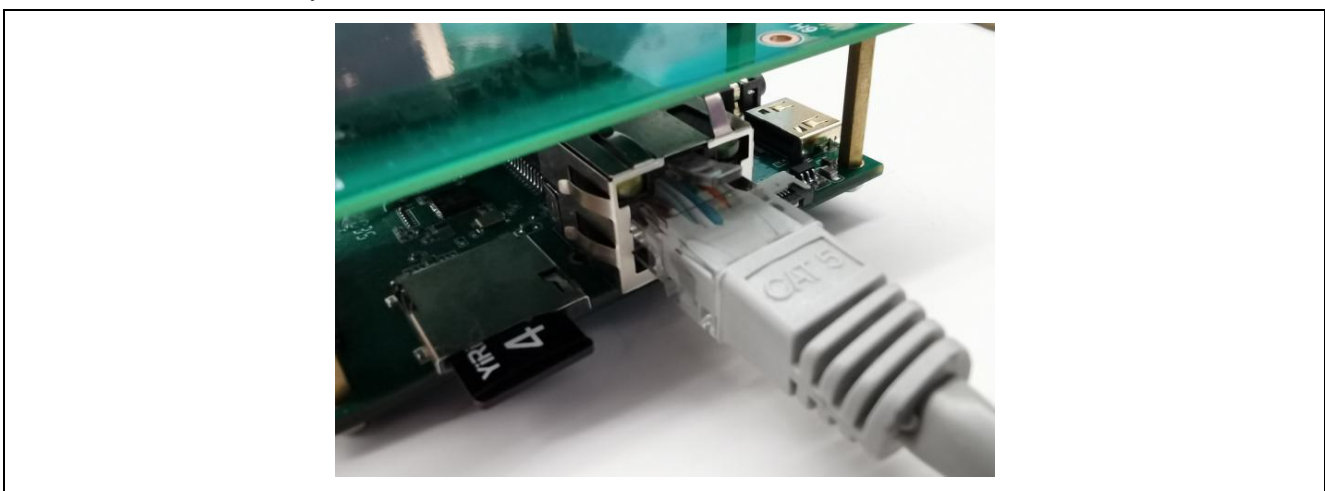

Figure 2.6 Connect LAN Cable

- f) Connect Debug UART connector to PC.

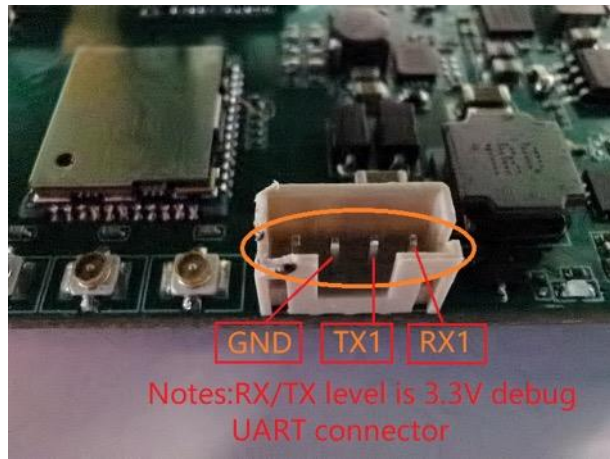

Figure 2.7 UART Debug Interface

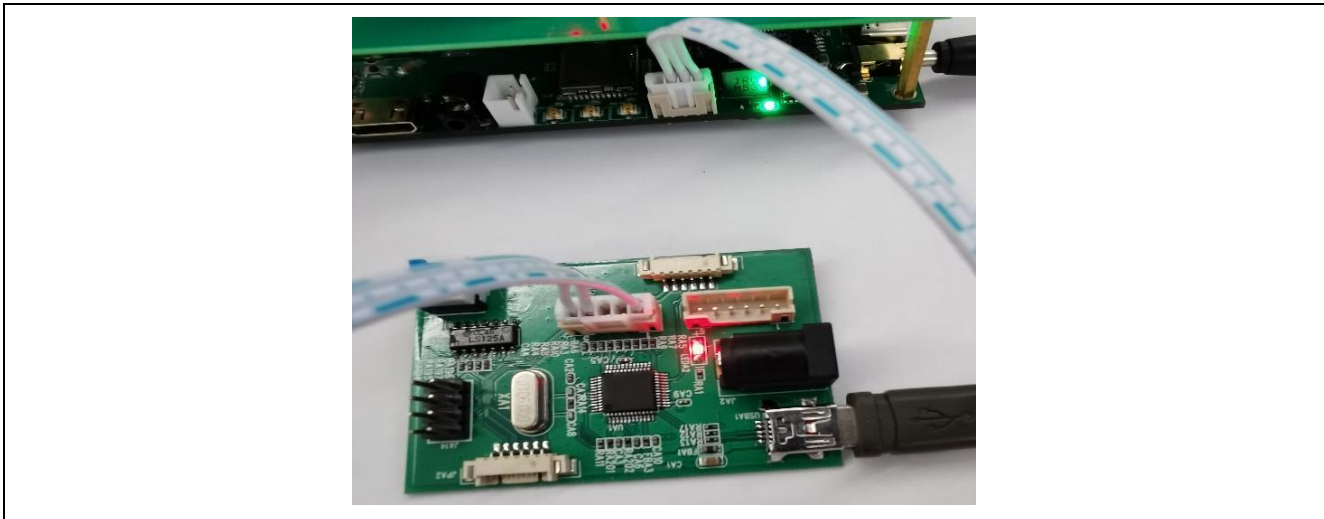
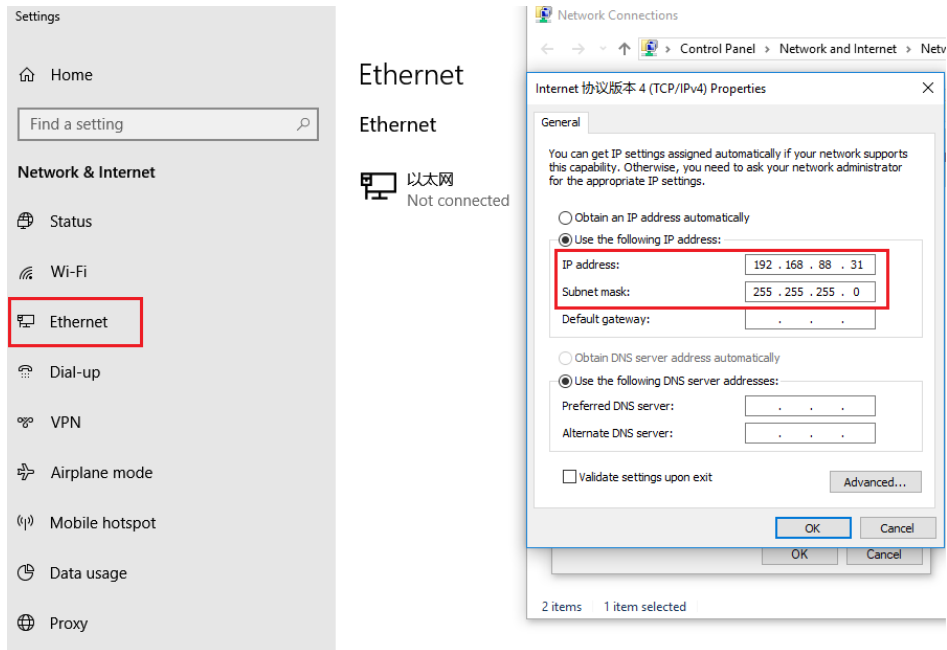

Figure 2.8 UART Debug Board Connection

2.3 Network setting

Configure the TCP/IPv4 setting of the PC for video display.

Input IP address and Subnet mask as follows



EX) "IP address" (192.168.88.31), "Subnet mask" (255.255.255.0)

Information: Setting TCP/IPv4

- 1) Select Windows button.
- 2) Select Setting button.

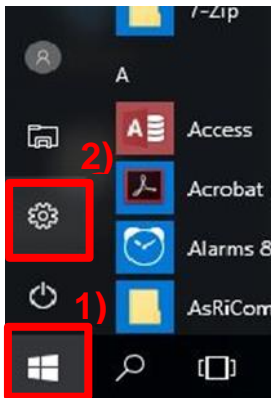

- 3) Select "Network and Internet".

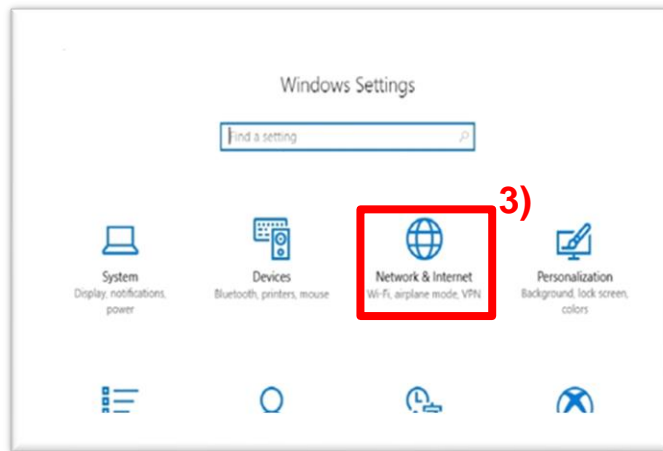

- 4) Select "Ethernet".
- 5) Select "Network and Sharing center".

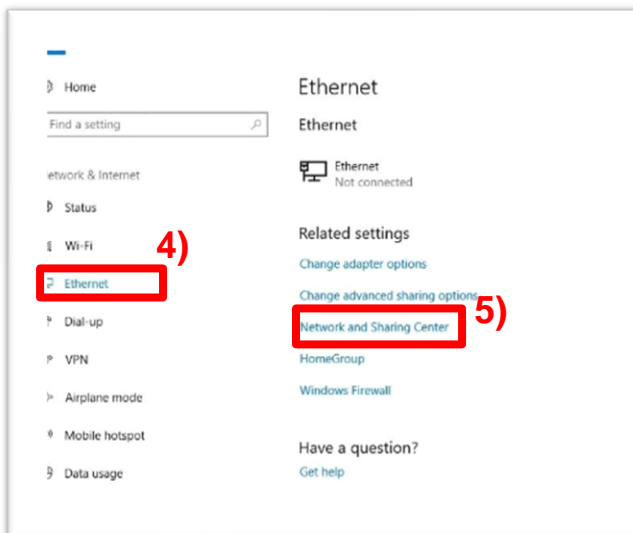

- 6) Select "Change adapter settings".

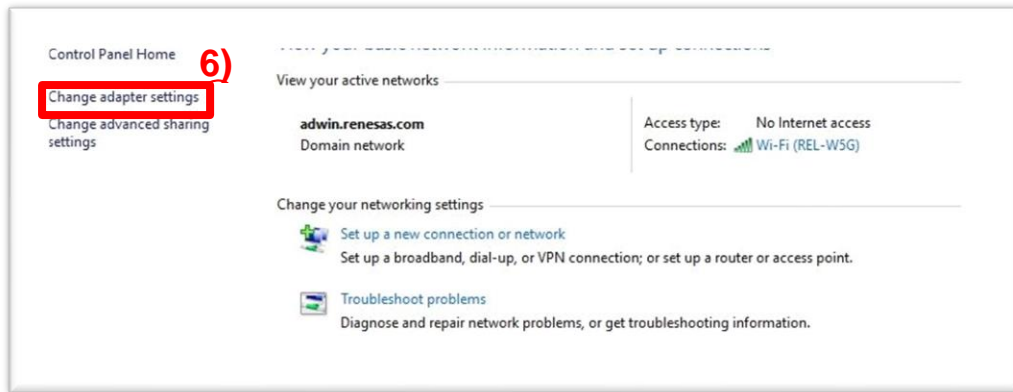

7) Select "Ethernet".

NOTE: Confirm the Ethernet status. If "Network cable unplugged", re-connect LAN cable.

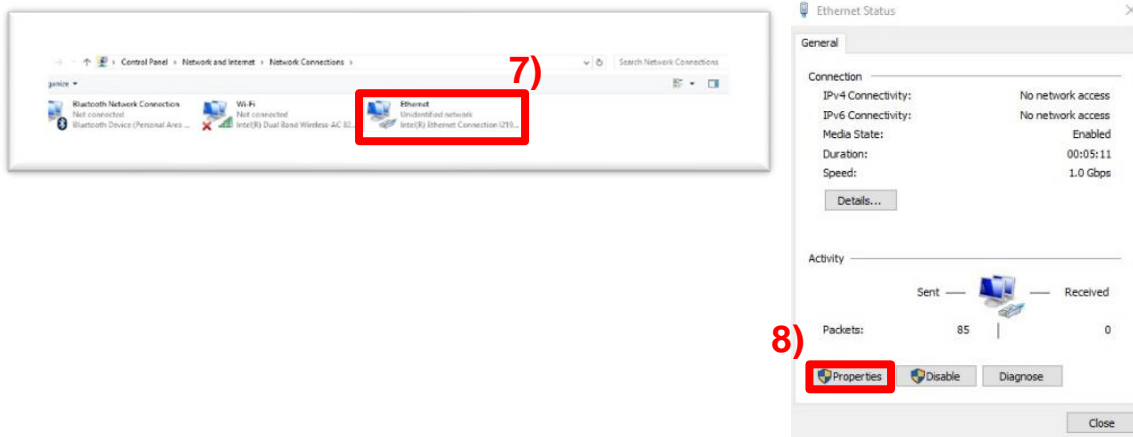

8) Select "Properties" button of "Ethernet Status".

9) Select "Internet Protocol version 4 (TCP/IPv4)" of "Ethernet Properties".

NOTE: Don't uncheck the box.

10) Select "Properties" button.

11) Select "Use the following IP address" of "Internet Protocol version 4 (TCP/IPv4) Properties". Set "IP address".

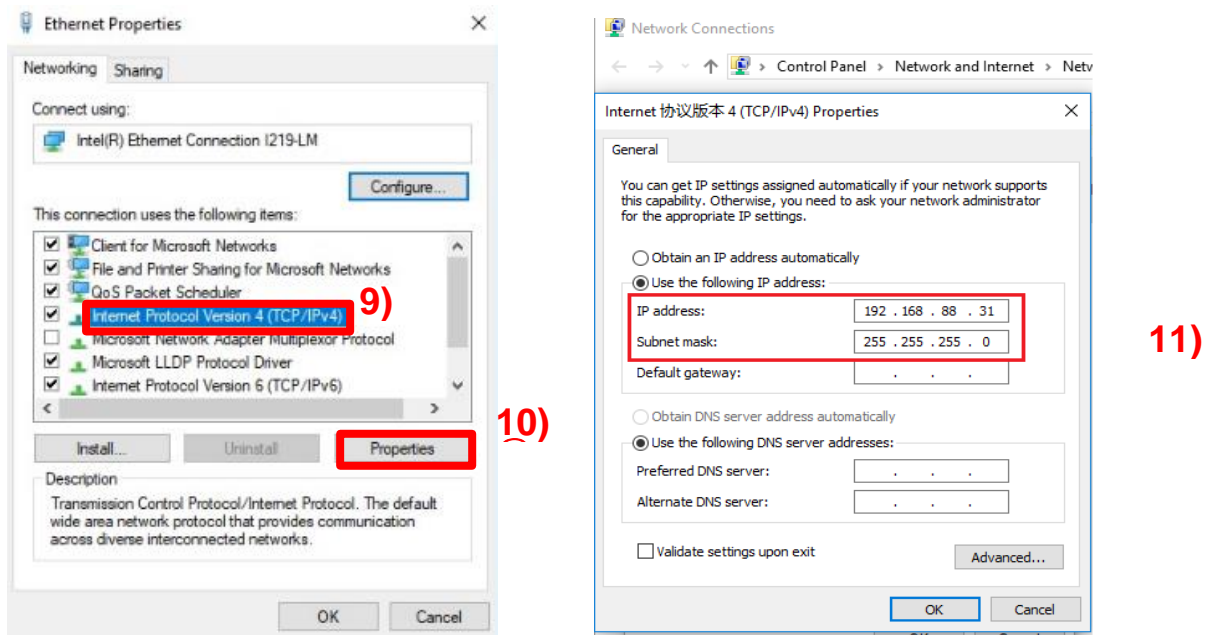

2.4 UART & Telnet setting

Please install the software that can control UART in advance.

e.g.) Tera Term for Windows (version:4.105)

USB/UART conversion cable is required to connect the PC.

Operating “Tera Term”.

Selecting the “serial” and USB port then clicking “OK”.

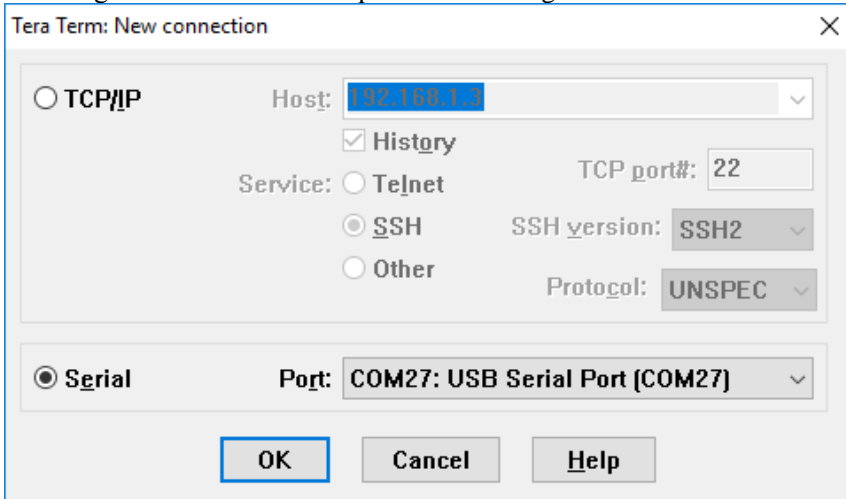

Selecting “serial port...” of menu.

Setting “speed” to “115200” then clicking “New setting”.

User can see following log when turning on the power (USB-C) of this camera module.

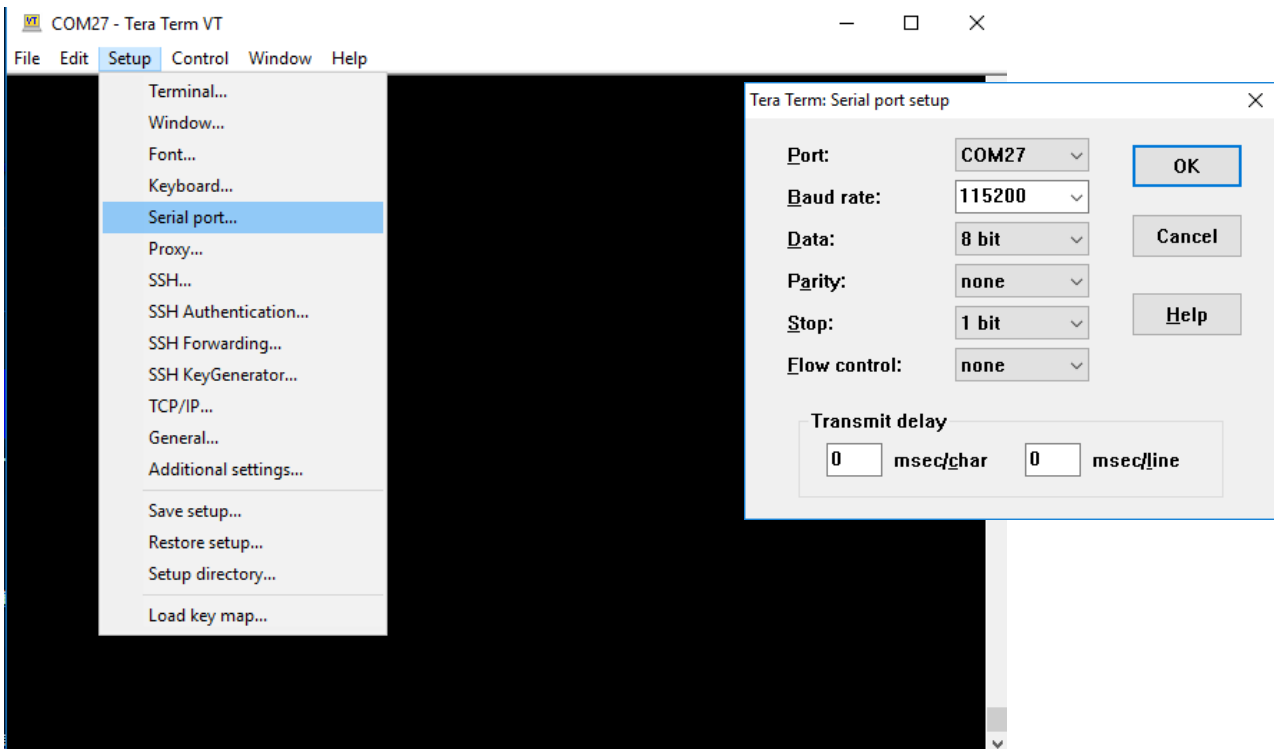

Configure UART & Telnet parameters in tool (Such as SecureCRT, Tera Term etc.):

UART serial setting: baud rate 115200bps, 8 data bit, 1 stop bit, none parity.

For telnet setting, host is “192.168.88.30”. Port is “23”.

When UART or Telnet connected ready, you can setup ISP streaming output.

2.5 RTSP Video Play by Ethernet

2.5.1 Install VLC media player

Download VLC from <https://www.videolan.org/>. Install VLC media player software.

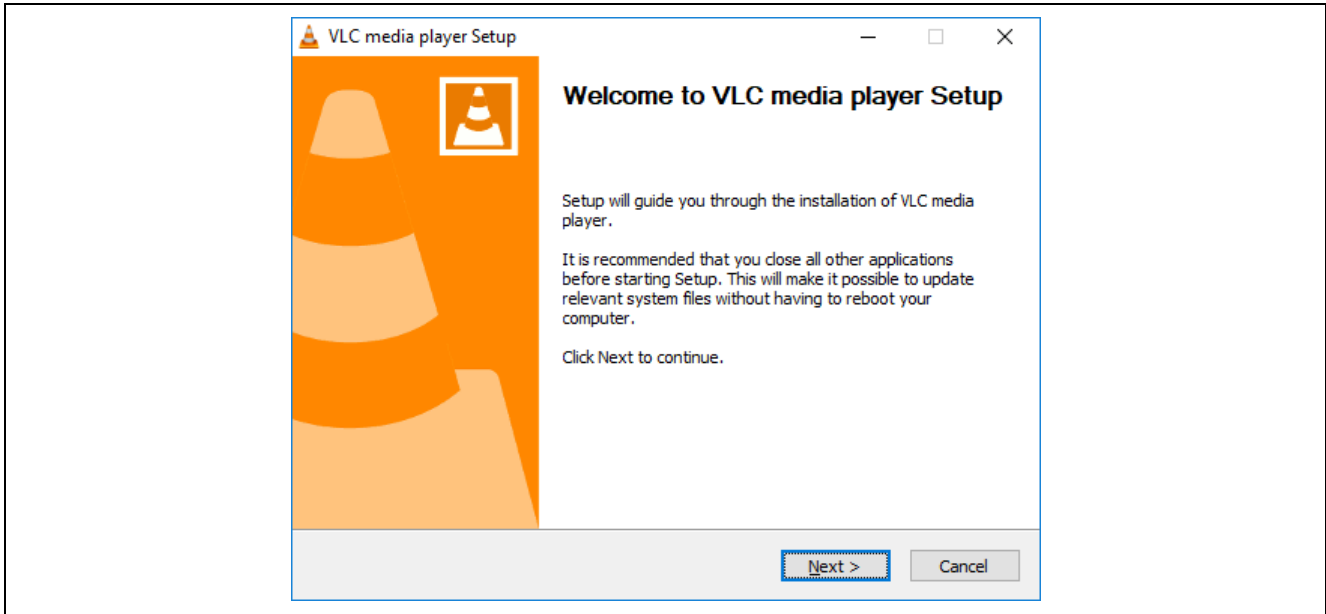

Figure 2.9 VLC Media Player Setup

2.5.2 RTSP streaming output

Turn on your ISP platform, after system initialization finished, system will auto run RTSP. Enter "q" to exit, then change the parameters. If your system is in command line, you can type below command to run RTSP:

```
hd_video_record_with_rtsp 0 0 1 1 0 0 8
```

Parameters notes:

```
root@NVTEVM:~$ hd_video_record_with_rtsp 0 0 1 1 0 0 8
```

Usage: <sensor_path> <shdr_mode> <af_mode> <pd_func> <hdmi_type> <enc_type> <enc_bitrate>

Help:

<sensor_path> : 0(path 1) (only 0 could be effective in this platform)

<shdr_mode> : 0(disable), 1(path 1 enable)

<af_mode> : 0(single), 1(continuous)

<pd_func> : 0(disable), 1(enable)

<hdmi_type> : 0(1920x1080I@60Hz), 1(3840x2160@30Hz), 2(1920x1080P@30Hz)

<enc_type> : 0(H265), 1(H264)

<enc_bitrate> : Mbps (must be 1, 2, 3, 4, 5, 6, 7, 8)

In UART debug window, enter "q" then input "enter". The current setting will be displayed to confirm the setting.

2.5.3 RTSP Video play on VLC

Open VLC media player and open network streaming as figure 2.10.

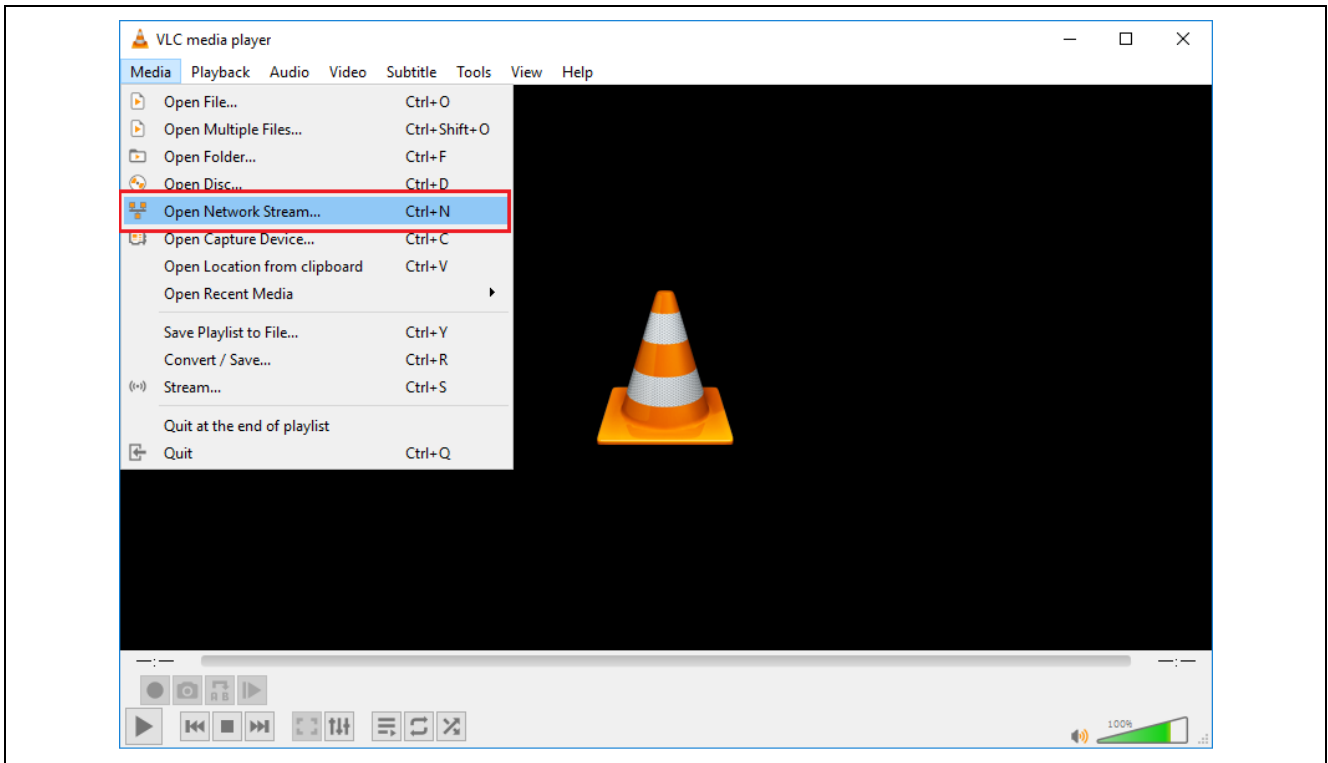

Figure 2.10 Open Network Streaming

2.5.4 Open Media

In Open Media dialog, select “Network” tab and input “*rtsp://192.168.88.30/live/ch00_0*” at URL space.

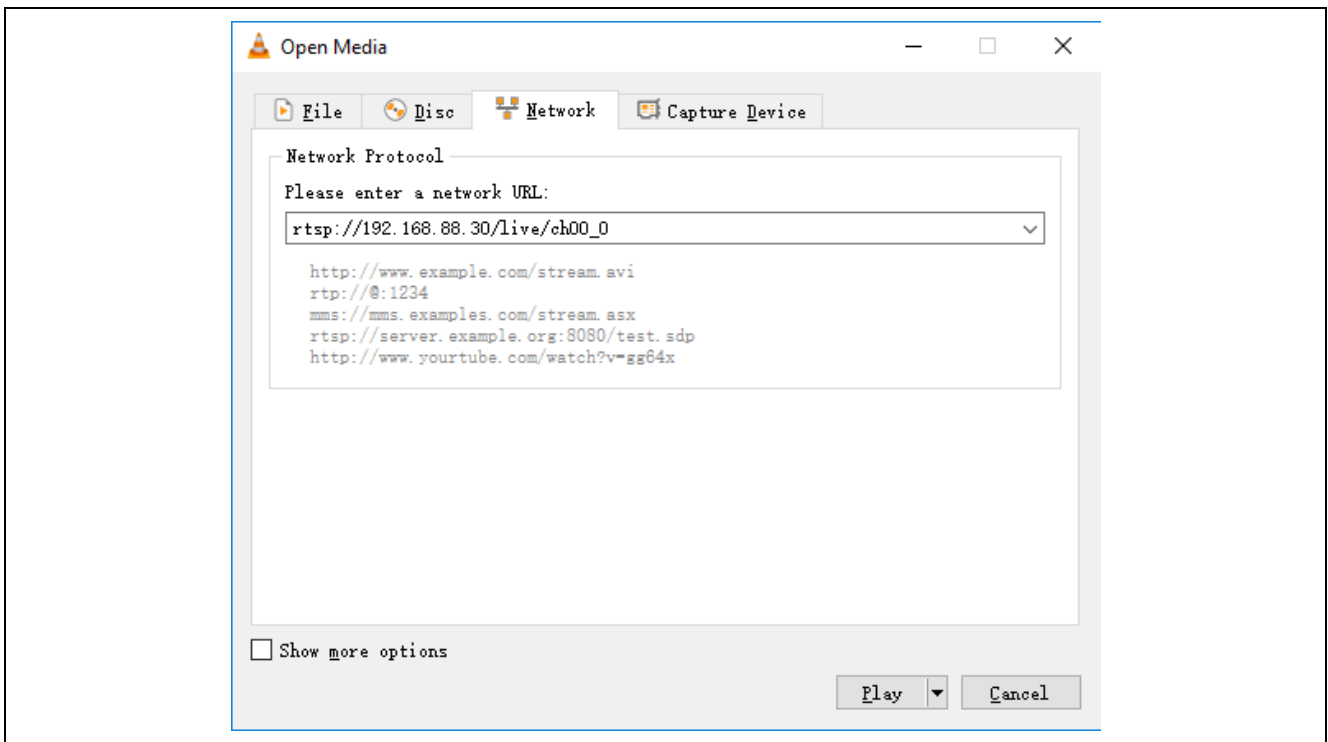

Figure 2.11 URL setting

Click “Play” button, video will show in PC.

Figure 2.12 shows video output in VLC media player.

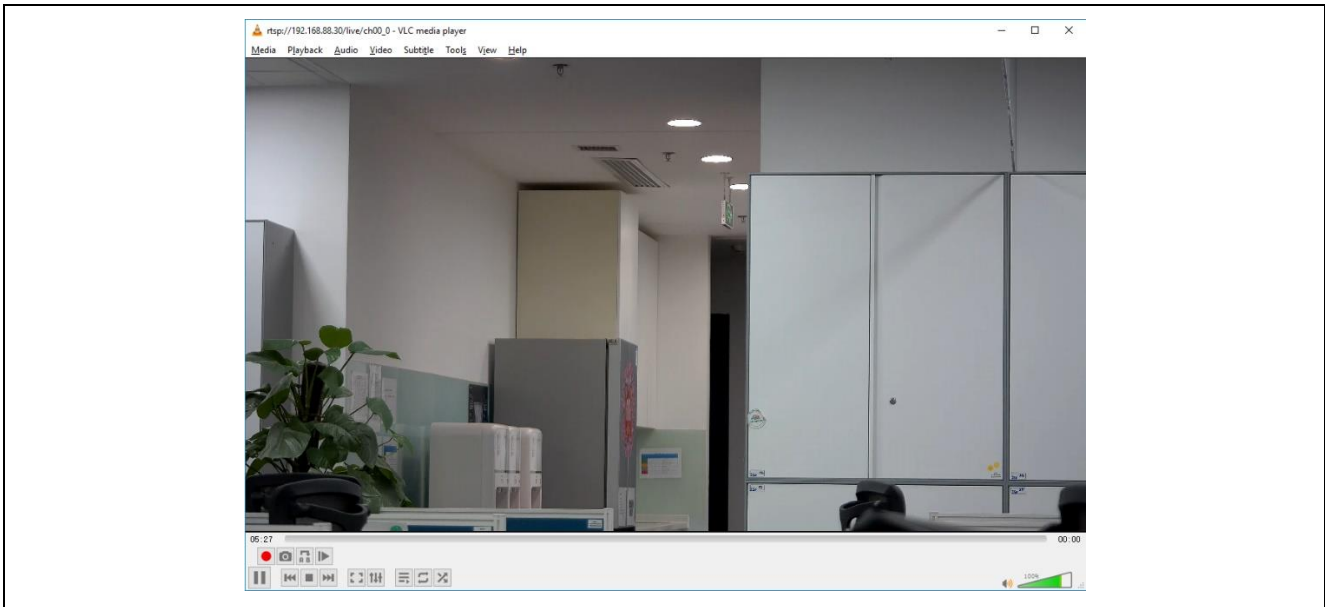

Figure 2.12 Video Output in VLC Media Player

2.6 HDMI Video Play

- 1) Connect ISP board with a display via HDMI cable, as Figure 2.13:

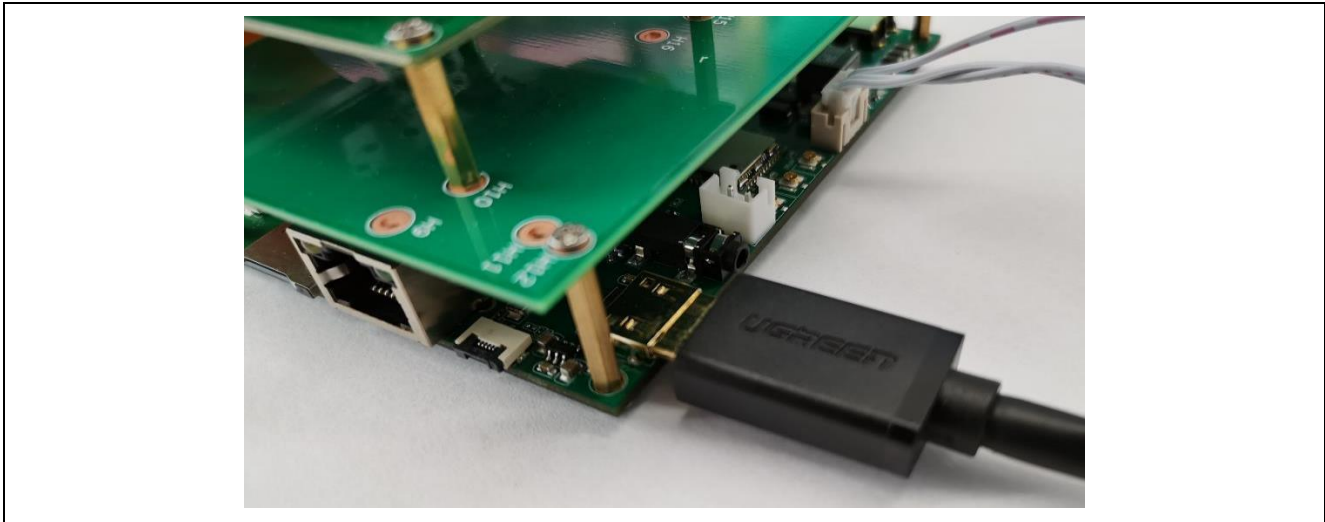

Figure 2.13 HDMI Connection

- 2) Video output on the monitor with HDMI interface.

Note: Default setting of HDMI display is 4K UHD monitor. Please change HDMI display type according to section “2.5.2 RTSP streaming output”

2.7 USB Video Play

- 1) Download potplayer on internet: <https://potplayer.en.softonic.com/>, <https://potplayer.org/> or another Web site. And install it on your PC.
- 2) Connect your ISP board (Type-C socket) with your PC USB port, as below Figure2.14:

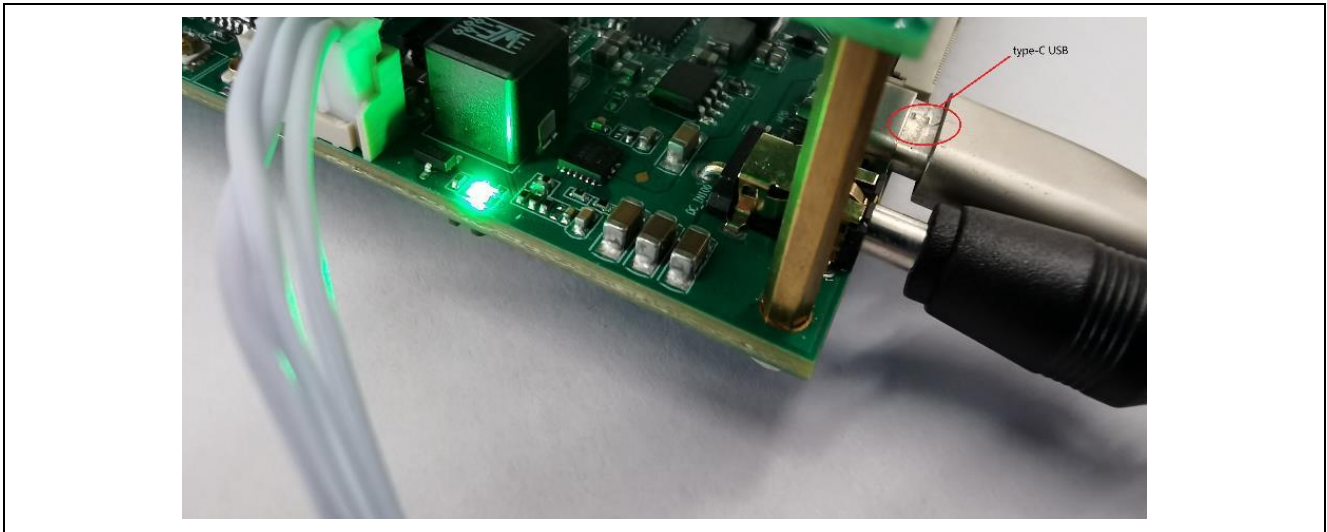

Figure 2.14 USB Connection

- 3) On your ISP system type below command to run liveview

`hd_video_record_with_substream`

when substream work rightly, system will output as below:

`enc_type=1`

`##video_out_param w:3840,h:2160 520c0420 0`

The output log may be inserted by other log information like Figure 2.15.

```
COM27 - Tera Term VT
File Edit Setup Control Window Help
root@NVTEVM:~$ hd_video_record_with_substream
H264: Version: vhd_common_init
0.2000.0
[ 71.636153] hd_common_init: already init?
[ 71.640742] hd_reset - begin
[ 71.644727] hd_reset - end
[ 71.690558] sen_pwr_ctrl_raq462113:enter flag 0
[ 71.695936] sen_pwr_ctrl_raq462113:clk=0
[ 71.701503] sen_pwr_ctrl_raq462113:gpio_request fail
[ 71.762286] sen_pwr_ctrl_raq462113:S_GPIO= 5
[ 71.766799] sen_pwr_ctrl_raq462113:gpio_request fail
[ 71.786270] sen_pwr_ctrl_raq462113:S_GPIO= 4
[ 71.797878] hdmitx_ddc_read_byte2:hdmitx_ddc_read_byte2 fail: i2c_transfer not OK
[ 71.805708] hdmitx_ddc_read_byte2:hdmitx_ddc_read_byte2 fail: i2c_transfer not OK
[ 71.813488] hdmitx_ddc_read_byte2:hdmitx_ddc_read_byte2 fail: i2c_transfer not OK
[ 71.821269] hdmitx_ddc_read_byte2:hdmitx_ddc_read_byte2 fail: i2c_transfer not OK
[ 71.829090] hdmitx_ddc_read_byte2:hdmitx_ddc_read_byte2 fail: i2c_transfer not OK
[ 71.836869] hdmitx_ddc_read_byte2:hdmitx_ddc_read_byte2 fail: i2c_transfer not OK
[ 71.844762] hdmitx_ddc_read:hdmitx_ddc_read fail: i2c_transfer not OK
[ 71.851615] hdmitx_ddc_read_byte:hdmitx_ddc_read_byte fail: i2c_transfer not OK
[ 71.859224] hdmitx_ddc_read_byte:hdmitx_ddc_read_byte fail: i2c_transfer not OK
[ 71.866856] hdmitx_ddc_read_byte:hdmitx_ddc_read_byte fail: i2c_transfer not OK
[ 71.874267] hdmitx_parse_edid:BAD EDID Header, Stop parsing
enc_type=1
##video_out_param w:3840,h:2160 520c0420 0
```

Figure 2.15 USB output log

if you want to stop, enter "q" to exit.

If you want exit substream, press "ctrl + c".

4) Open potplayer, enter “Open” menu -> “Device settings” as below Figure 2.16:

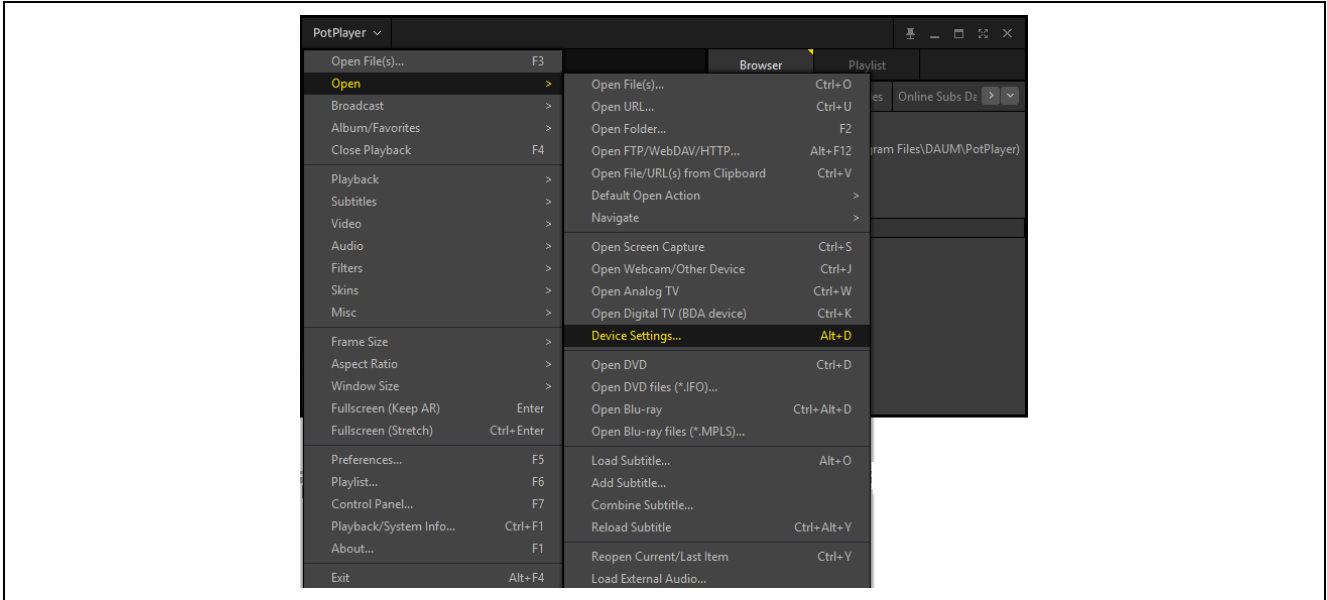

Figure 2.16 HDMI Connection

In “Webcam” page, select “UVC Camera” in Device list, in format list, select “H.264”, for example: “H.264 1920x1080 30”, then click “Open device”

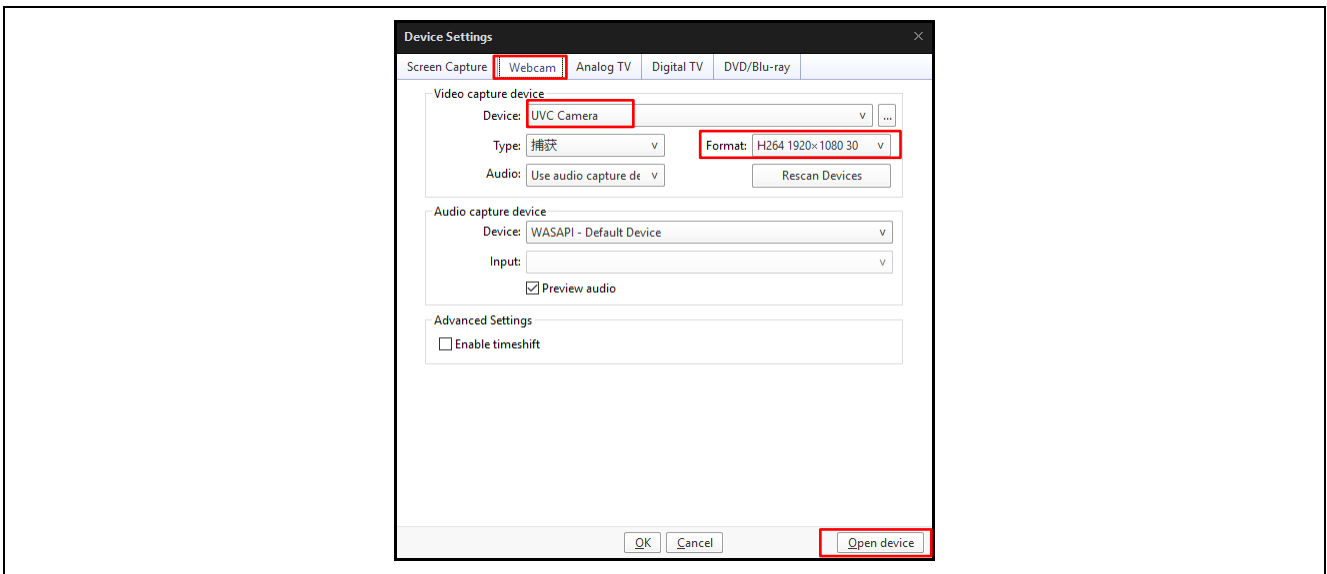

Figure 2.17 Webcam setting

5) Video output in “Potplayer” as Figure 2.18.

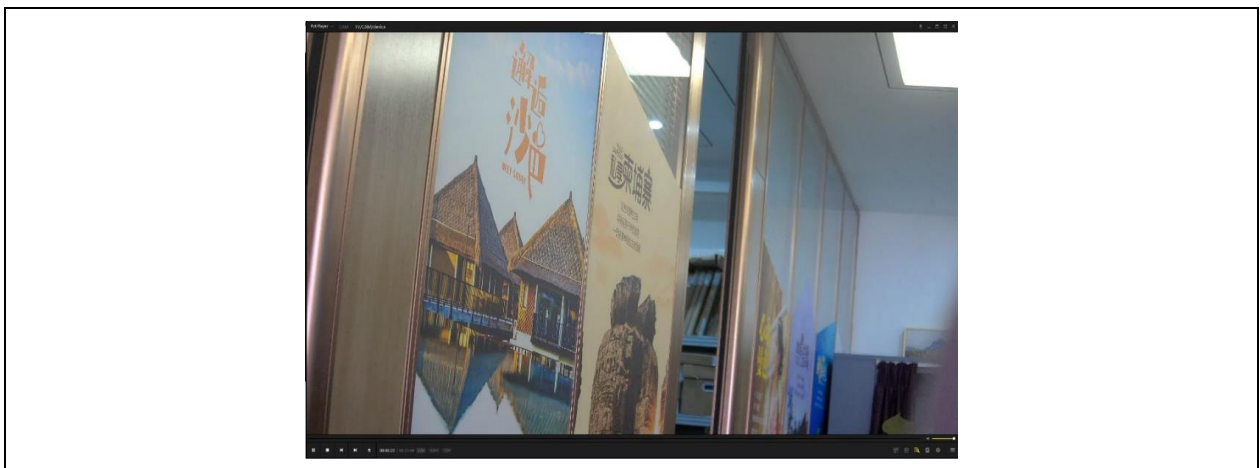

Figure 2.18 USB Video Player

2.8 WiFi Configuration

Connect WiFi antenna in ANT501 port like Figure 2.19.

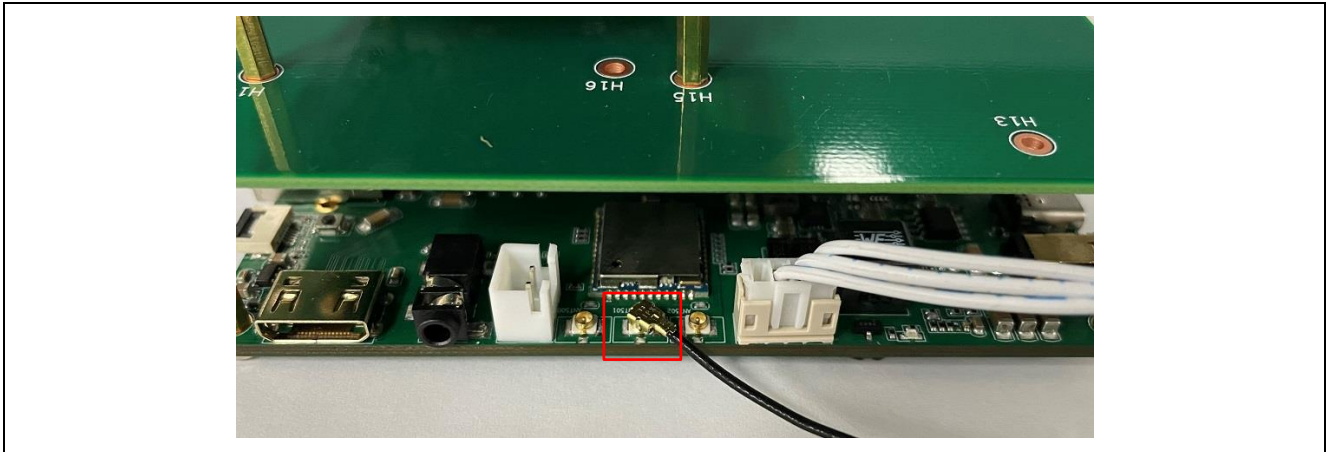

Figure 2.19 Open Network Streaming

Search WiFi signal “680ap-5G” like Figure 2.20. Connect with “680ap-5G”, no password. After connection Wifi successfully, output “rtsp://192.168.1.3/live/ch00_0” in VLC media player. You can output video in smart phone with VLC App shown in Figure 2.21.



Figure 2.20 Open Network Streaming

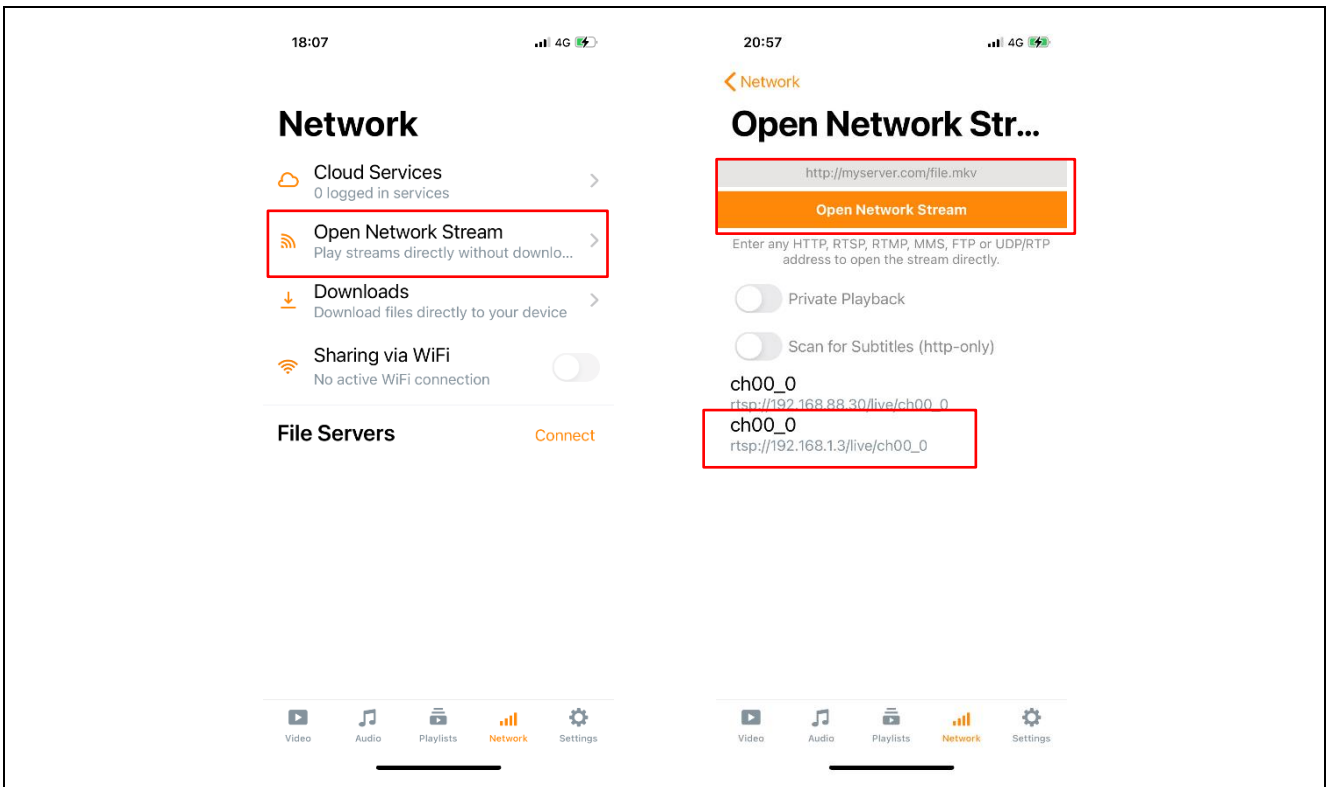

Figure 2.21 VLC Smart Phone App Setting

Please reduce Wifi communication speed by UART or telnet if the video output is not stable. Normally, 2Mbps is stable.

<4Mbps>: `hd_video_record_with_rtsp 0 0 1 1 0 0 4`

<2Mbps>: `hd_video_record_with_rtsp 0 0 1 1 0 0 2`

Note: Please kill the current thread “`hd_video_record_with_rtsp 0 0 1 1 0 0 8`” firstly if controlling camera module in telnet. For example, kill -9 PID.

2.9 Lens Zoom/focus tuning

Operating “Command Prompt”.

Telnet : 192.168.88.30(Ethernet), 192.168.1.3(WiFi)

Login : root

Use “vendor_isp_sample” to tune zoom/focus parameters.

Note: Please open another telnet window if you want to change play mode.

Firstly, run RTSP sample code and use VLC to play it, and then in UART mode or in Telnet mode, type “*vendor_isp_sample*”, then you can see a set of debug menu appears. We list some major items here for example:

- 1) 21. Get motor focus
- 2) 21. Get motor focus
- 3) 22. Get motor zoom
- 4) 60. Set motor focus search range

To optimize the focus effect, you can use it to fine tune AF search range. Please follow below steps:

- (1) Type 60, and firstly select table index (0~10)
- (2) Secondly set zoom pos node (0 ~ 770), In general the mapping relation between table index & zoom pos node is as

below: Table index zoom pos node

0	0
1	77
2	154
3	231
4	308
5	385
6	462
7	539
8	616
9	693
10	770

- (3) Thirdly set focus min => min focus value for current zoom node
 - (4) Finally set focus max => max focus value for current zoom node
 - (5) After setting focus min/max for all nodes, you can test auto-zoom functions is work or not on every zoom node (you can see below item 6). If you find auto zoom can't work correctly on one zoom node, just repeat this step till you get proper value. At the end, send these data to us to make new FW bin for you, and also you can directly modify the configure file at board: /etc/motor/mtr_an41908.cfg.
- 5) 64. Set motor focus => let the lens focus on the value you set.
 - 6) 65. Set motor zoom =>let the lens go to zoom node you set.
 - 7) 0. Quit

2.10 IR cut

IR cut command is “66”. Select IR cut open or close as shown in Figure 2.22.

```
Telnet 192.168.88.30
75. Set va crop_roi
76. Set va win_ratio
77. Set va indep_crop_roi
83. Set sensor expt
84. Set sensor gain
85. Set d gain
86. Set c gain
87. Set total gain
88. Set lv
89. Set ct
-----
- ONLY os02k10 -----
-----
100. Print information of motion detection
101. Disable motion detection
102. Set sensitivity of motion detection
103. Print temperature
0. Quit
-----
>> 66
Set open/close (0 or 1)>>
```

Figure 2.22 IR cut command

2.11 AF trigger

AF trigger can be operated in following process. Input command “64” to set focus pos that let the lens defocus.

```
Select Telnet 192.168.88.30
75. Set va crop_roi
76. Set va win_ratio
77. Set va indep_crop_roi
83. Set sensor expt
84. Set sensor gain
85. Set d gain
86. Set c gain
87. Set total gain
88. Set lv
89. Set ct
-----
- ONLY os02k10 -----
-----
100. Print information of motion detection
101. Disable motion detection
102. Set sensitivity of motion detection
103. Print temperature
0. Quit
-----
>> 64
Set focus pos (0 ~ 250)>>
```

Figure 2.23 Set focus position command

Input “0” to quit “*vendor_isp_sample*” process. Execute “*echo w re_trigger 0 1 > /proc/hdal/vendor/af/cmd*” to trigger auto focus process.

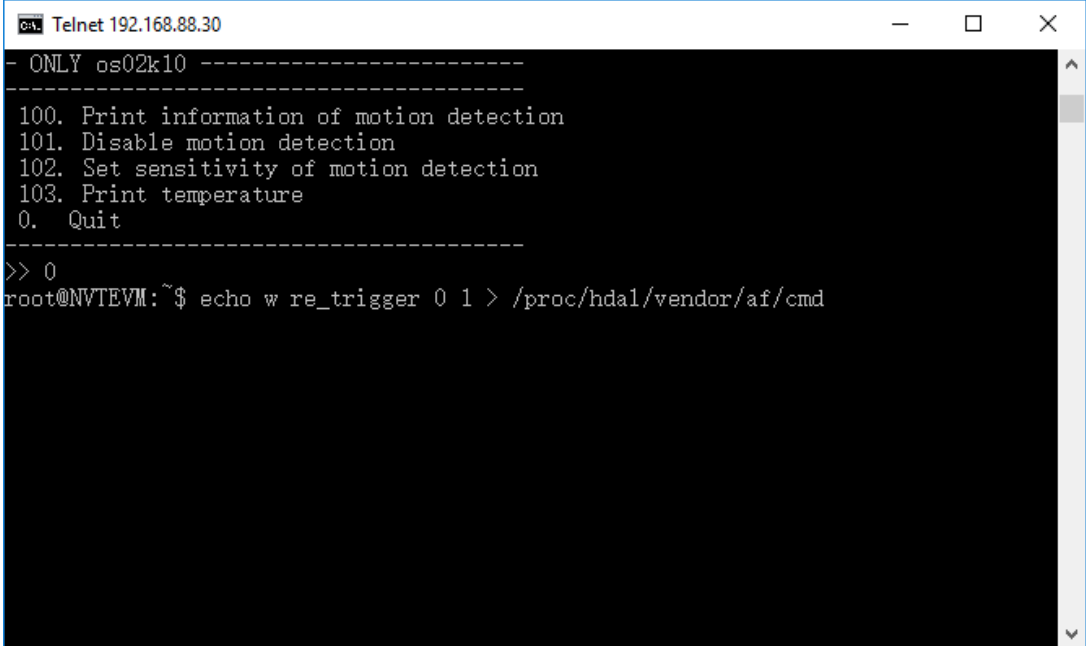

```
Telnet 192.168.88.30
- ONLY os02k10 -----
100. Print information of motion detection
101. Disable motion detection
102. Set sensitivity of motion detection
103. Print temperature
0. Quit
-----
>> 0
root@NVTEVM:~$ echo w re_trigger 0 1 > /proc/hdal/vendor/af/cmd
```

Figure 2.24 AF trigger command

2.12 Software update

Update ISP board's firmware as following steps.

- 1) Take out TF card from ISP board
- 2) Copy firmware file (FW96685A.bin) to TF card by PC
- 3) Tack TF card back into ISP board
- 4) Power on ISP system or reboot system, it will auto run updating process. After updating finished, system will reboot automatically.

2.13 PQ Tuning

For picture quality (PQ) tuning, please use ISP tool from Novatek. Please contact with Renesas or distributor sales window person firstly.

2.14 PDAF correction

For PDAF correction. Please contact with Renesas or distributor sales window person firstly.

Revision History

Rev.	Date	Description	
		Page	Summary
0.10	Oct. 22, 2020		First edition issued
0.20	Nov. 14,2020	3	Update specification
		5	Update the photo of ISP board
		7 to 16	Update operation set up
0.50	Dec. 4,2020	All	Update operation about WiFi, USB and HDMI
0.60	Feb. 19,2021	14	Update "2.5.2 RTSP streaming output"