

QCIOT-RRH62000POCZ

All-In-One Air Quality Pmod™

**Description**

The RRH62000 evaluation board demonstrates the functionality and performance of the RRH62000 all-in-one air quality sensor. The RRH62000 series is used for measuring critical air quality parameters. The design of the RRH62000 evaluation board is generic so that the customer can embed the sensor into their specific application.

The board provides a standard Pmod™ Type 6A (extended I<sup>2</sup>C) connection for the onboard sensor to plug into any required MCU evaluation kit with a matching connector. The RRH62000 evaluation board can be added to the end of a daisy-chained solution with multiple Type 6/6A devices on the same MCU Pmod connector.

The Renesas [e2 studio](#) software included with the Renesas IDE (integrated development environment) allows for code generation to connect the device and the MCU, significantly reducing development time. With its standard connector and software support, the RRH62000 evaluation board is ideal for the Renesas Quick-Connect IoT to rapidly create an IoT system.

**Board Contents**

- RRH62000 Evaluation Board

**Features**

- Simultaneous multi-sensor measurements of all relevant air quality parameters
- Sensor outputs feature:
  - Detection of particle sizes from 0.3µm to 10.0µm
  - Output mass concentration bins for PM1, PM2.5, and PM10
  - Temperature (T) and Relative Humidity (RH)
  - Measurement of Total Volatile Organic Compounds (TVOC) concentrations and indoor air quality (IAQ) index according to UBA[1]
  - Estimated carbon dioxide level (eCO<sub>2</sub>)
- Operating temperature range from -10°C to 60°C
- Operating humidity range up to 90%RH
- Standardized type 6A Pmod connector supports I<sup>2</sup>C/SMBUS extended interface
- Software support in e2 studio minimizes development time with one-click code generation

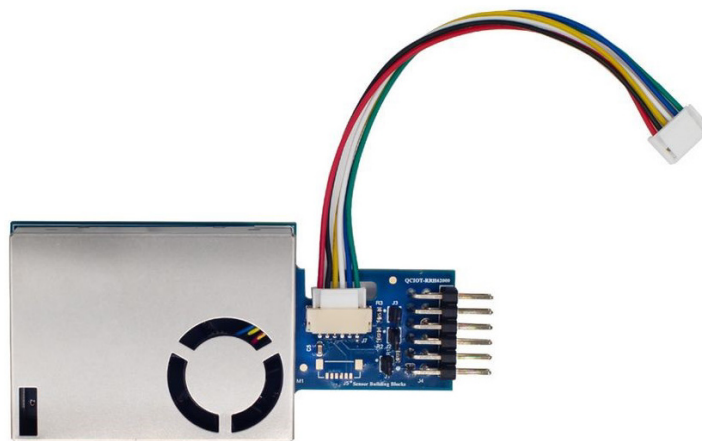

Figure 1. QCIOT-RRH62000POCZ All-In-One Air Quality Pmod

## Contents

<b>1. Functional Description</b>	<b>3</b>
1.1 Operational Characteristics	3
1.2 Setup and Configuration	4
1.2.1 Software Installation and Usage	4
1.2.2 Kit Hardware Connections	4
<b>2. Board Design</b>	<b>5</b>
2.1 Schematic Diagrams	6
2.2 Bill of Materials (BOM)	7
2.3 Board Layout	8
<b>3. Software Design</b>	<b>9</b>
3.1 Project Code Structure	9
3.2 Software Module Overview	11
3.2.1 Hal_entry	11
3.2.2 Algorithm Flowchart	12
3.3 Board Test	13
3.3.1 Setting Up the Boards and Cable	13
3.3.2 Programming the Development Board and Run Example Code in Debug Mode	13
<b>4. Ordering Information</b>	<b>18</b>
<b>5. Revision History</b>	<b>18</b>

## Figures

Figure 1. QCIOT-RRH62000POCZ All-In-One Air Quality Pmod	1
Figure 2. RRH62000 Functional Block Diagram	3
Figure 3. QCIOT-RRH62000 Pmod with EK-RA6M4 MCU Kit	5
Figure 4. QCIOT-RRH62000 Pmod (Top)	5
Figure 5. QCIOT-RRH62000 Pmod (Bottom)	6
Figure 6. QCIOT-RRH62000 Pmod Schematic Diagrams	6
Figure 7. Top Overlay	8
Figure 8. Top Layer	8
Figure 9. Int 1 (PWR)	8
Figure 10. Int 2 (GND)	8
Figure 11. Bottom Layer	8
Figure 12. Bottom Overlay	8
Figure 13. RRH62000 Project Structure	9
Figure 14. Stack Configuration – Hal/Common Interface Window	10
Figure 15. Code Dependency Flowchart	11
Figure 16. Algorithm Flowchart	12
Figure 17. Debug Configuration Selection	13
Figure 18. Debug Configurations – Start Debug Mode	14
Figure 19. Open Visual Expression	14
Figure 20. Visual Expression Window	15
Figure 21. Gauge Setup	15
Figure 22. Set Gauge Expression	16
Figure 23. Set Expression Name	16
Figure 24. Gauge Properties	16
Figure 25. Gauge Minimum and Maximum Temperature	17
Figure 26. Available Sensor Values	17

# 1. Functional Description

The QCIOT-RRH62000POCZ Pmod is intended as a quick-connect prototyping solution for an air quality monitoring system. This board enables the quick creation air quality monitoring systems. The QCIOT-RRH62000POCZ Pmod can measure particle sizes from 0.3µm to 10.0µm, mass concentration bins from PM1, PM2.5, and PM10, temperature (T), relative humidity (RH), Total Volatile Organic Compounds (TVOC), indoor air quality (IAQ) index according to UBA, and estimated carbon dioxide level (eCO<sub>2</sub>).

The building blocks of the QCIOT-RRH62000POCZ Pmod and their functionality are listed below:

- **ZMOD4410** – Gas sensor module providing indoor air quality (IAQ) designed for detecting total volatile organic compounds (TVOCs), estimating CO<sub>2</sub>, and monitoring indoor air quality in different smell-based use cases, including very humid and dusty applications.
- **HS4003** – Highly accurate, ultra-low power, fully calibrated relative humidity and temperature sensor. Fully calibrated and temperature compensated with an I<sup>2</sup>C digital output.

Figure 2 highlights the main parts of the system.

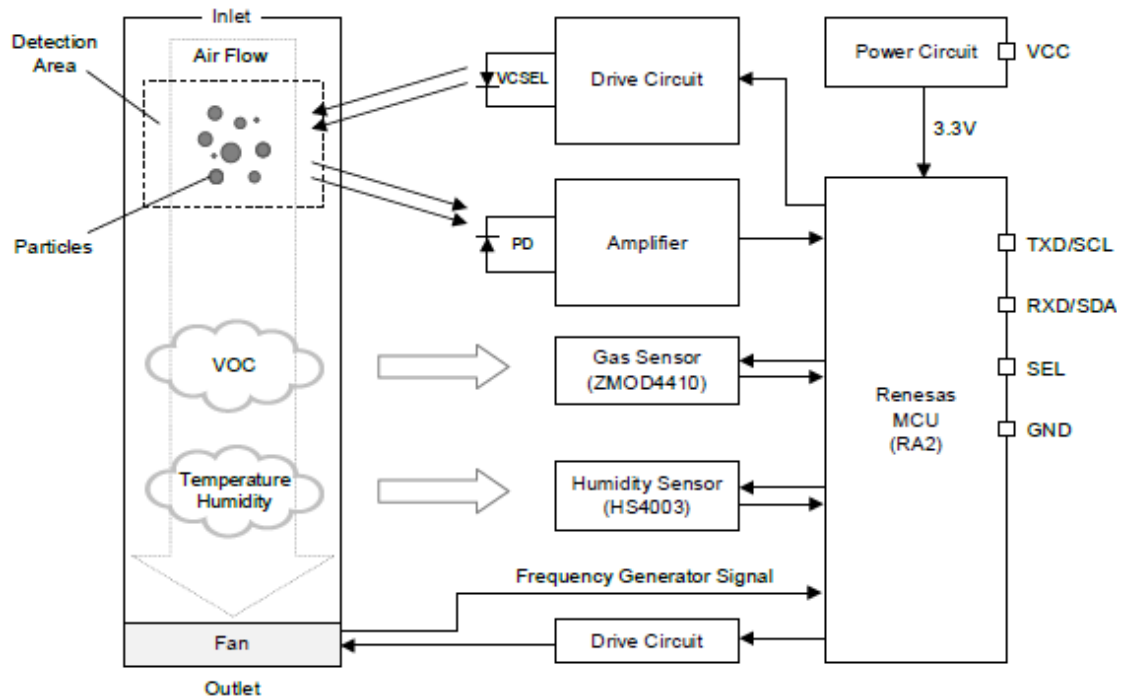

Figure 2. RRH62000 Functional Block Diagram

## 1.1 Operational Characteristics

Use the QCIOT-RRH62000POCZ Pmod as a starting point for air quality monitoring applications.

The board is designed to the following specifications:

- Temperature range: -40°C – 125°C
- Relative Humidity range: 0% – 100%
- TVOC: 160ppb – 10000ppb
- eCO<sub>2</sub>: 400ppm – 5000ppm

## 1.2 Setup and Configuration

The setup and configuration for the RRH62000 Pmod is comprised of the following required or recommended hardware:

- [EK-RA6M4](#) Evaluation Kit
- USB micro-B cable (provided with EK-RA6M4 board)
- PC running Windows 10/11 with at least one USB port
- [US082-INTERPEVZ](#) Interposer board (if needed)

The following is required or recommended software:

- [Renesas Flexible Software Package](#) (FSP) v5.4.0 platform installation:
  - [e2 Studio](#) 2023-01 or later
  - FSP 5.4.0 or later
  - GCC Arm Embedded 10.3.1 (10 2021.10)
- Sample code files are available on the [RRH62000](#) product page

### 1.2.1 Software Installation and Usage

Visit the Renesas website for the latest version of the e2 studio installer. The minimum FSP version supporting the QCIOT-RRH62000 Pmod is FSP 5.4.0.

### 1.2.2 Kit Hardware Connections

Follow these procedures to set up the kit and refer to [Figure 3](#).

1. Ensure that the MCU development kit has at least one Type 6A Pmod.
  - a. For the EK-RA6M4, two Pmods – PMOD1 and PMOD2, are available. The default for these Pmods is Type 2A. Use the US082-INTERPEVZ interposer board to allow compatibility with Type 6A.
  - b. If no interposer is available, then PMOD1 can be rerouted from Type 2A to 6A. For more information, see the [EK-RA6M4 User Manual](#).
2. Ensure that pin 12 of the Pmod is 3.3V, which is requested by the RRH62000 Pmod.
  - c. For the EK-RA6M4, pin 12 of PMOD1 and PMOD2 are 3.3V by default. No change needed.
  - d. For some evaluation boards, pin 12 is defaulted to 5.0V and may require rerouting. Check the user manual to verify that pin 12 is 3.3V
3. Mount the J2 and J3 jumpers on the RRH62000 Pmod board.
4. Plug the RRH62000 Pmod into PMOD1 of the EK-RA6M4.
5. Connect the EK-RAM64 board with the computer using the USB micro-B cable.

The kit is now ready for use.

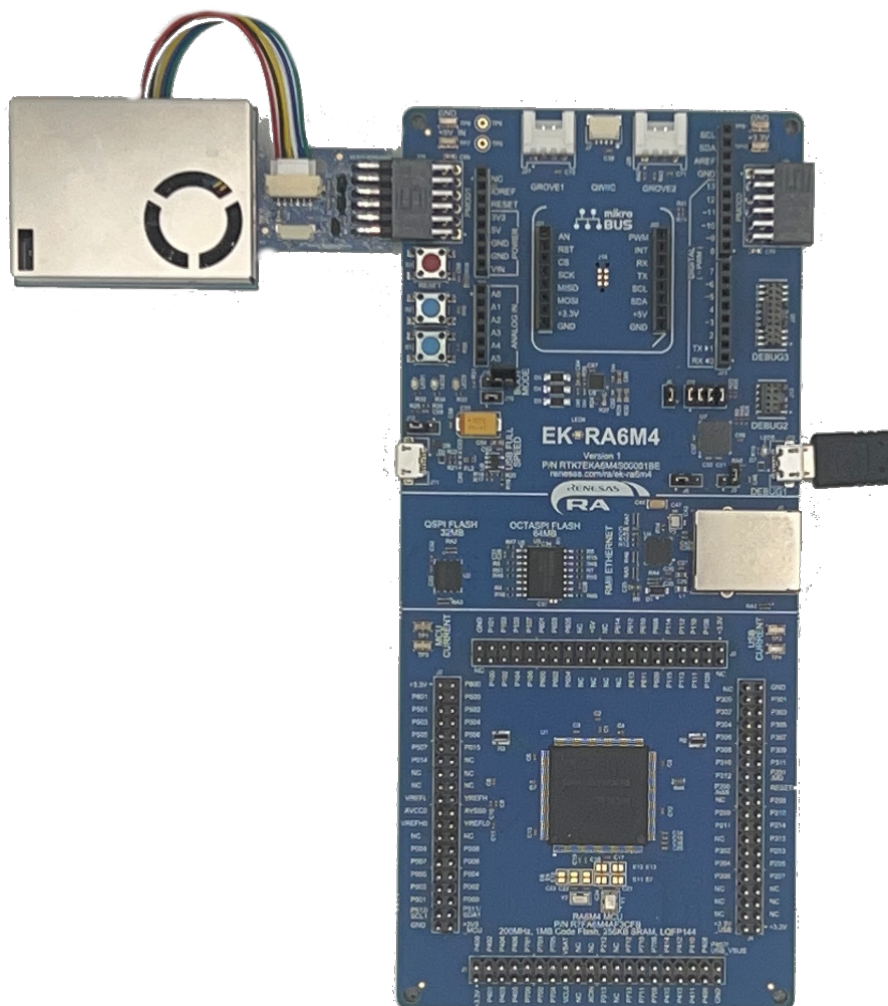

Figure 3. QCIOT-RRH62000 Pmod with EK-RA6M4 MCU Kit

## 2. Board Design

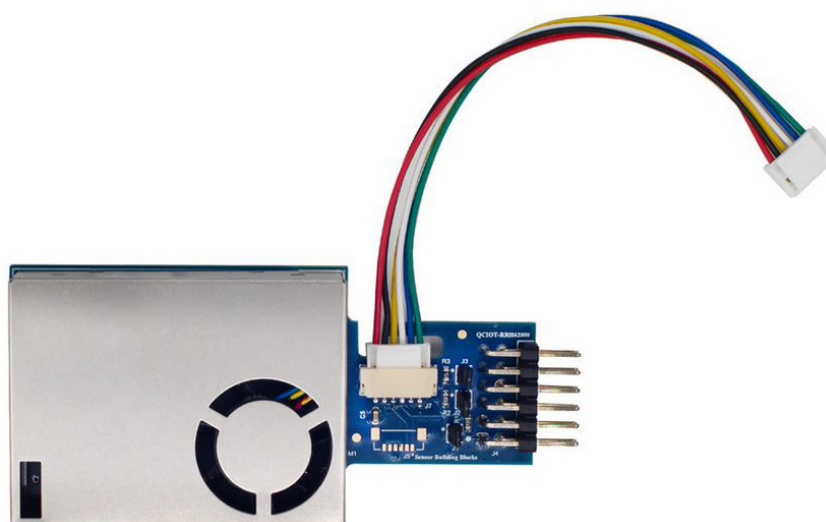

Figure 4. QCIOT-RRH62000 Pmod (Top)

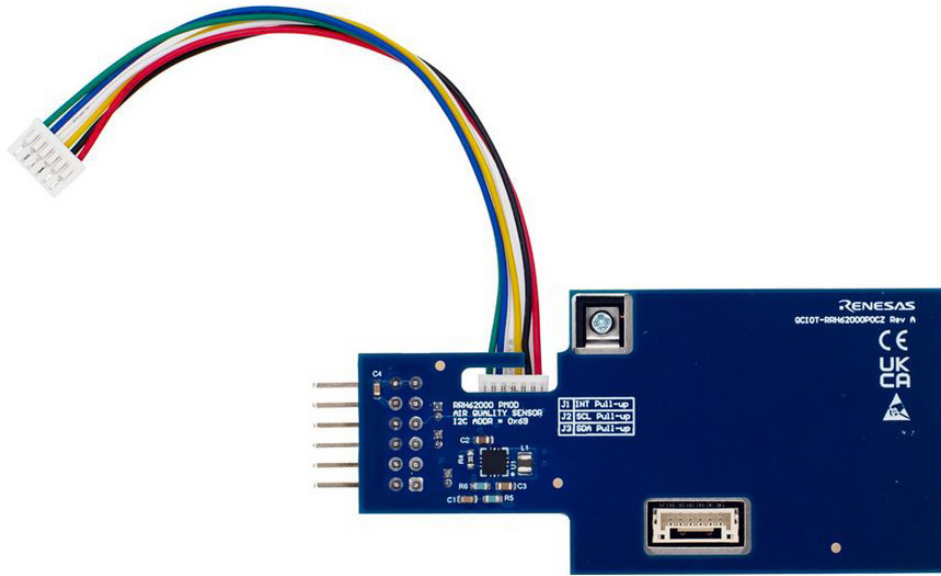

Figure 5. QC10T-RRH62000 Pmod (Bottom)

## 2.1 Schematic Diagrams

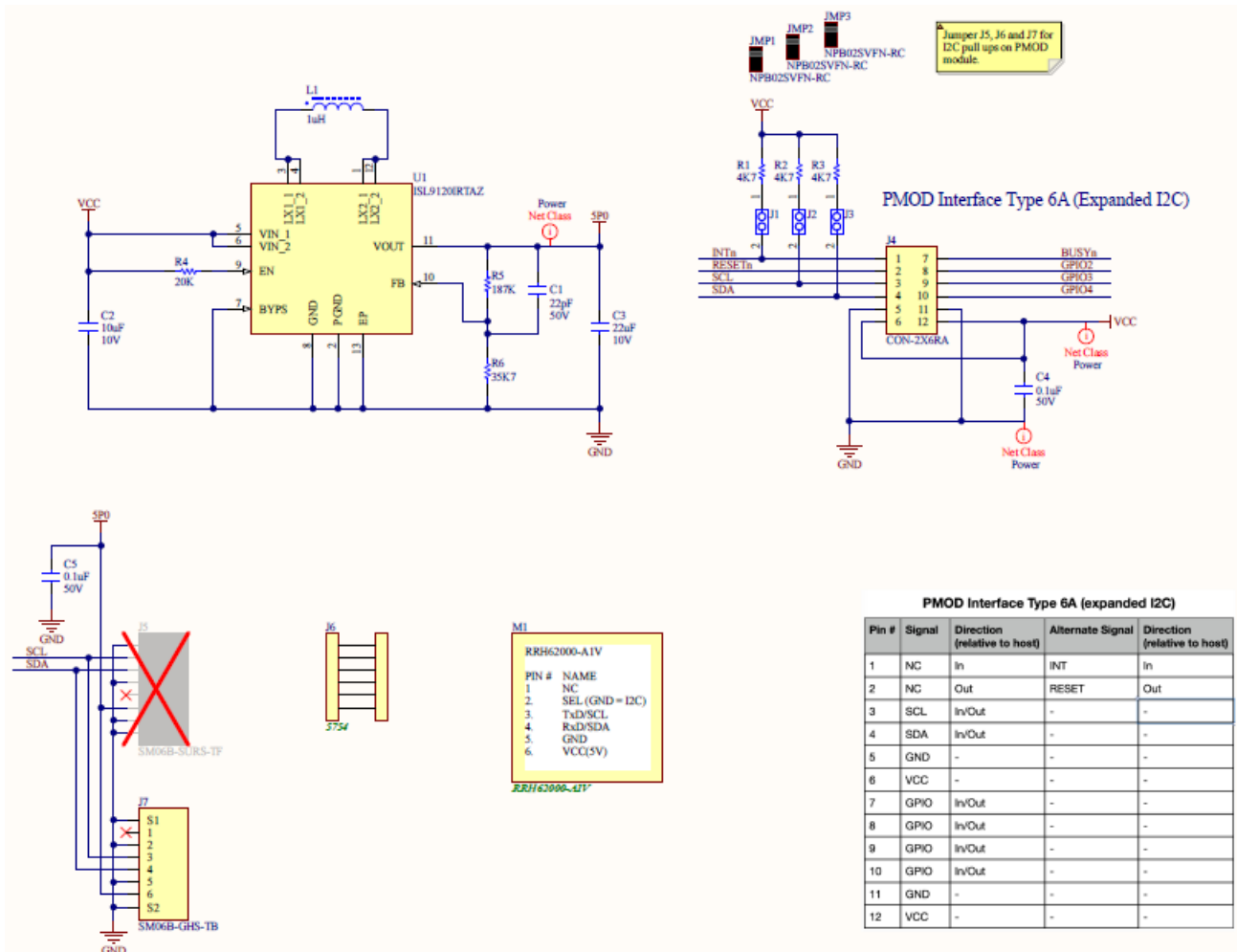

Figure 6. QC10T-RRH62000 Pmod Schematic Diagrams

## 2.2 Bill of Materials (BOM)

Qty	Reference Designator	Description	Manufacturer	Manufacturer Part Number
1	C1	Capacitor, 22pF, 50V, COG/NPO, SM	Yageo	CC0603JRNPO9BN220
1	C2	Capacitor, 10µF, 10V, SM	Murata	GRM188R61A106KE69D
1	C3	Capacitor, 22µF, 10V, SM	Murata	GRM188R61A226ME15D
2	C4, C5	Capacitor, 0.1µF, 50V, SM	Yageo	CC0603KRX7R9BB104
1	FOOT1	Foot, Rubber, Self-adhesive, Black, 6.4mm diameter, 2.1mm tall	Bumper Specialties	BS25BL07X30RP
3	J1, J2, J3	Jumper, 1×2, 0.05" Pitch	Sullins	GRPB021VWVN-RC
1	J4	Connector, 2×6, 0.1", PMOD, Header, Right Angle, Unshrouded	Harwin	M20-9950645
1	J6	Cable, 1×6W, 4", 1.25mm Pitch, 28ΩAWG, 1A, Sockets, GH Series	Adafruit	5754
1	J7	Connector, 1×6 Pin, 1.25mm, GH Series, Right Angle, SM	JST	SM06B-GHS-TB
3	JMP1, JMP2, JMP3	2 C, Closed Top, .050" CC; No Mounting, 105 C, Nylon 66; Phos Bronze, Gold Flash	Sullins	NPB02SVFN-RC
1	L1	Inductor, 1µH, 3.1A, 60mOhm, SM	TDK	TFM201610GHM-1R0MTAA
1	M1	Sensor, Air Quality Sensor, RoHS, SM	Renesas	RRH62000-A1V
3	R1, R2, R3	Resistor, 4.7kΩ, 1/8W, 1%, SM	KOA Speer	RK73H1JTDD4701F
1	R4	Resistor, 20kΩ, 1/8W, 1%, SM	KOA Speer	RK73H1JTDD2002F
1	R5	Resistor, 187kΩ, 1/8W, 1%, SM	KOA Speer	RK73H1JTDD1873F
1	R6	Resistor, 35.7kΩ, 1/8W, 1%, SM	KOA Speer	RK73H1JTDD3572F
1	U1	Regulator, Buck-Boost, SM	Renesas	ISL9120IRTAZ

## 2.3 Board Layout

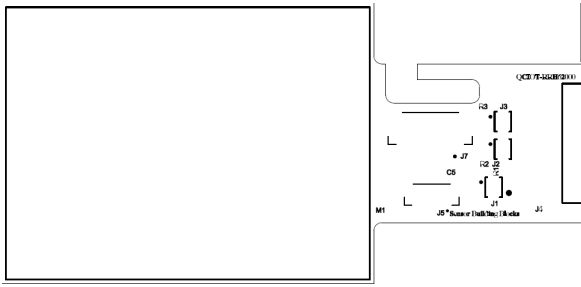

Figure 7. Top Overlay

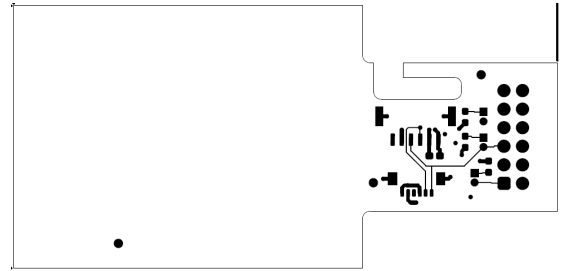

Figure 8. Top Layer

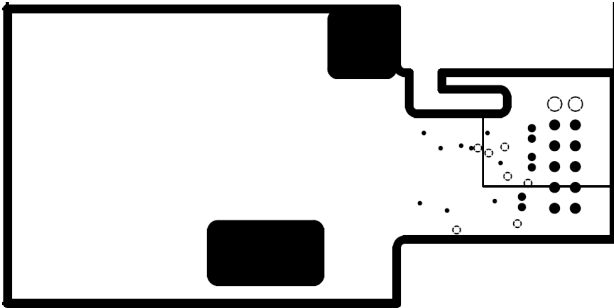

Figure 9. Int 1 (PWR)

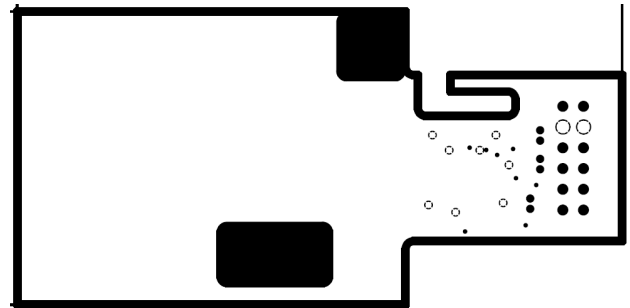

Figure 10. Int 2 (GND)

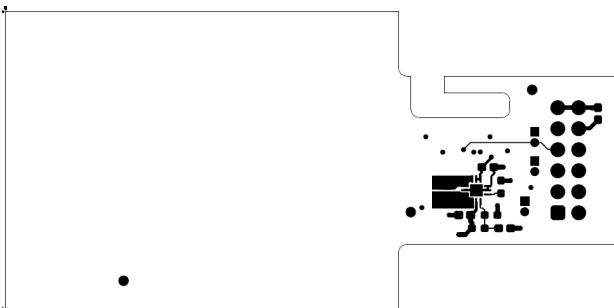

Figure 11. Bottom Layer

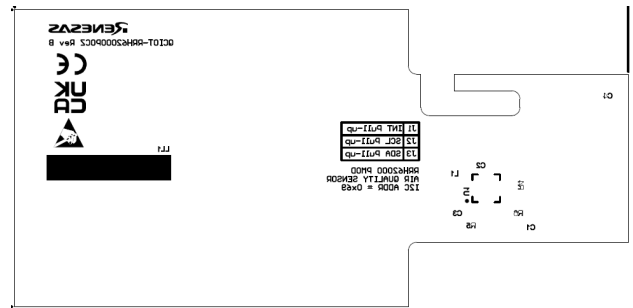

Figure 12. Bottom Overlay



### 3. Software Design

The following sections give an overview of the software implementation for the QCIOT-RRH62000 Pmod based on the Renesas RA Family's Flexible Software Package (FSP), and detail the project's code structure, the system's software modules, and the main system flow.

#### 3.1 Project Code Structure

The All-In-One Air Quality Demo Project is designed to be a highly modular solution that can be easily configured independently of other modules (if required) or ported to other end-applications.

The project is split into two main parts:

- **RRH62000 driver** – Device driver code for air quality sensor that includes the I<sup>2</sup>C communication driver.
- **Application code** – Main system code that enables the driver code and implements system flow

The driver module contains the C-source files and header files. The specific user configuration is included in the application code.

Figure 13 shows the structure of the project in e2 studio.

The screenshot shows the project structure in e2 studio. On the left, the 'ra' folder is expanded to show sub-folders: 'arm', 'board', 'fsp', 'inc', 'api', 'instances', and 'src'. The 'api' folder contains header files like 'bsp\_api.h', 'fsp\_common\_api.h', 'r\_i2c\_master\_api.h', 'r\_ioport\_api.h', 'r\_transfer\_api.h', 'rm\_comms\_api.h', and 'rm\_rrh62000\_api.h'. The 'instances' folder contains 'r\_ioport.h', 'r\_sci\_i2c.h', 'rm\_comms\_i2c.h', and 'rm\_rrh62000.h'. The 'src' folder contains 'ra\_gen', 'src', 'Debug', '.settings', 'build', 'ra\_cfg', and 'script'. On the right, the 'ra' folder is expanded to show sub-folders: 'arm', 'board', 'fsp', 'inc', 'src', 'ra\_gen', and 'src'. The 'fsp' folder contains 'inc' and 'src'. The 'src' folder contains 'bsp', 'r\_ioport', 'r\_sci\_i2c', 'rm\_comms\_i2c', and 'rm\_rrh62000'. The 'ra\_gen' folder contains 'bsp\_dock\_cfg.h', 'common\_data.c', 'common\_data.h', 'hal\_data.c', 'hal\_data.h', 'main.c', 'pin\_data.c', 'vector\_data.c', and 'vector\_data.h'. The 'src' folder contains 'hal\_entry.c', 'Debug', '.settings', 'build', 'ra\_cfg', and 'script'.

**Project Structure Definitions**

- ra** – Automatically generated files for FSP drivers, RRH62000 driver source code, and header file.
  - **rm\_rrh62000.h** – RRH62000 driver header file
  - **rm\_rrh62000.c** – RRH62000 driver source file
  - **rm\_rrh62000\_api.h** – RRH62000 API header file
  - **rm\_rrh62000\_ra\_driver.c** – Software delay function
- ra\_gen** – Generated files by FSP configuration.
- src** – Application code that uses rrh62000 driver.
  - **hal\_entry.c** – Start of code execution which calls system main.

Figure 13. RRH62000 Project Structure

Click **configuration.xml** in the project and select the *Stacks* tab. This opens the Stacks Configuration – Hal/Common interface window as shown in [Figure 14](#).

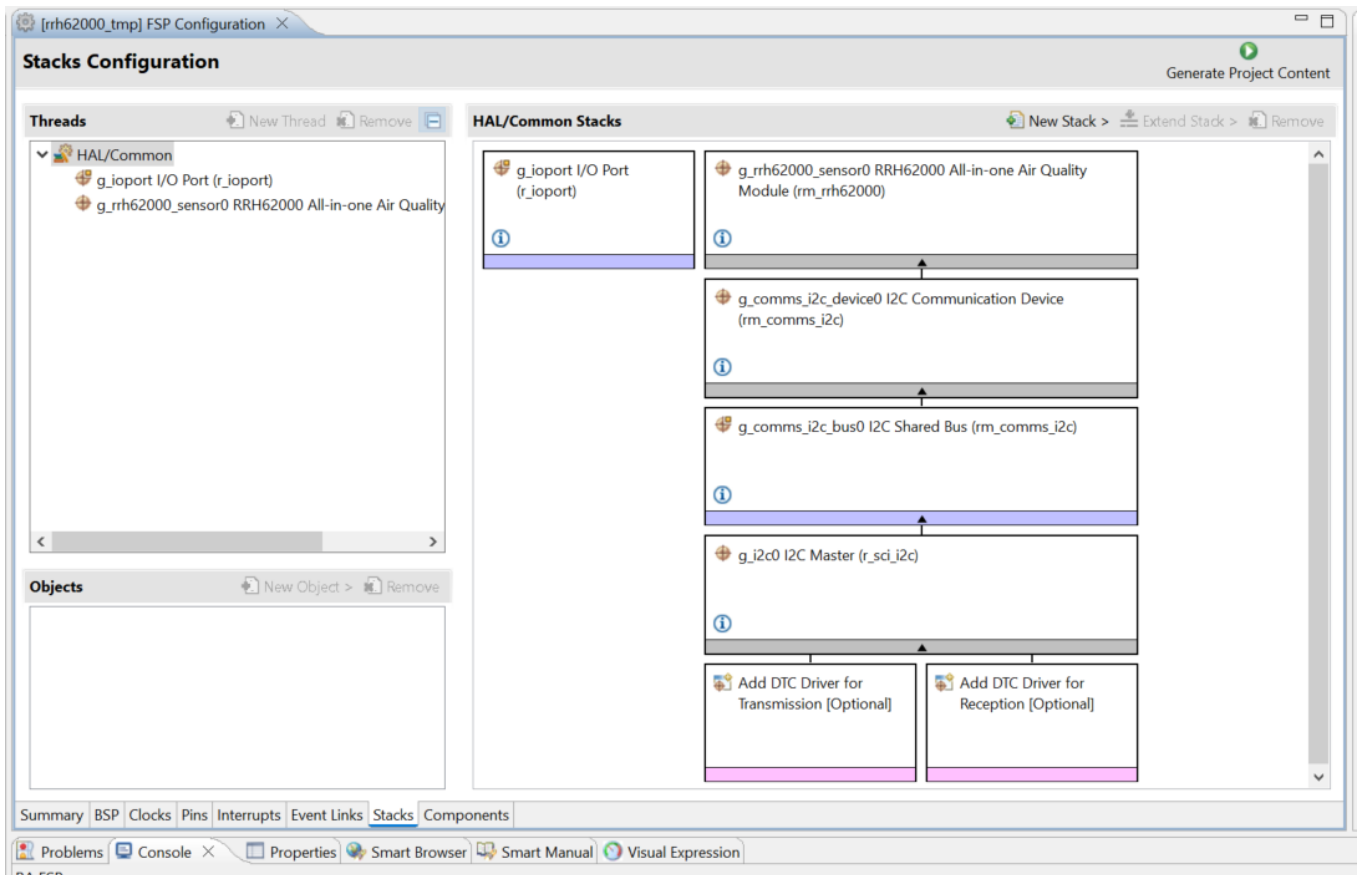

**Figure 14. Stack Configuration – Hal/Common Interface Window**

[Figure 15](#) shows the general code structure of its dependencies. Execution begins in the main function (**main.c**) initiating the application flow. The RRH62000 driver module is called in **hal\_entry**. All associated header files reference the lower-level Flexible Software Package (FSP) drivers.

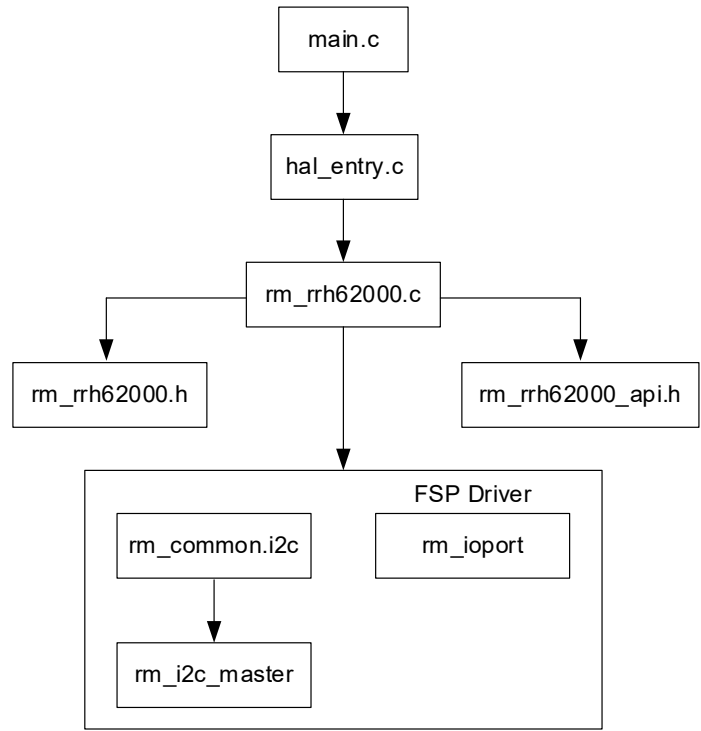

Figure 15. Code Dependency Flowchart

### 3.2 Software Module Overview

The RRH62000 demo project shows the basic use of FSP API calls to setup and read sensor data from the RRH62000.

#### 3.2.1 Hal\_entry

This module is responsible for initializing the FSP I<sup>2</sup>C driver and setting up the RRH62000 device with the user-configured settings.

After setup, the module provides the following features:

- Performs device setup commands
- Reads sensor values

### 3.2.2 Algorithm Flowchart

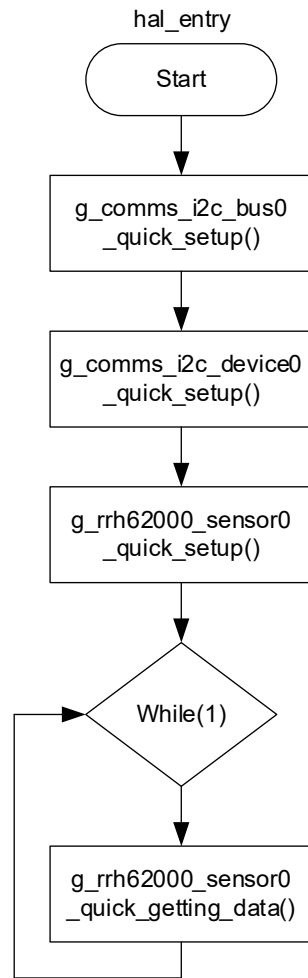

Figure 16. Algorithm Flowchart

The I<sup>2</sup>C bus is opened by **g\_comms\_i2c\_bus0\_quick\_setup()**. Then, the RRH62000 instance is opened by **g\_rrh62000\_sensor0\_quick\_getting\_data()**.

The main program loops continuously to get the air quality readings by **g\_rrh62000\_sensor0\_quick\_getting\_data()** function calls. The sensor readings can be seen in the Virtual Expression window.

The functions outlined in [Figure 16](#) are described as follows:

#### hal\_entry ()

- Call **g\_comms\_i2c\_bus0\_quick\_setup()**
  - Open I<sup>2</sup>C driver. This must be performed before calling device setup.
- Call **g\_comms\_i2c\_device0\_quick\_setup()**
  - Open I<sup>2</sup>C Communications device instance. This must be performed before calling any COMMS\_I2C\_API.
- Call **g\_rrh62000\_sensor0\_quick\_setup()**
  - Open RRH62000 instance. This must be performed before calling any RRH62000 API.
- Continuously call **g\_rrh62000\_sensor0\_quick\_getting\_data()**
  - Sends the read data command to the RRH62000
  - Waits for measurement to be finished
  - Converts raw sensor measurement data to calculated data

### 3.3 Board Test

#### 3.3.1 Setting Up the Boards and Cable

Verify that you have followed the procedure in [Kit Hardware Connections](#).

#### 3.3.2 Programming the Development Board and Run Example Code in Debug Mode

1. Open the sample project in e2 studio.
2. Go to the menu bar and select **Run > Debug Configurations** (see [Figure 17](#)). This opens the **Debug Configurations** window (see [Figure 18](#)).

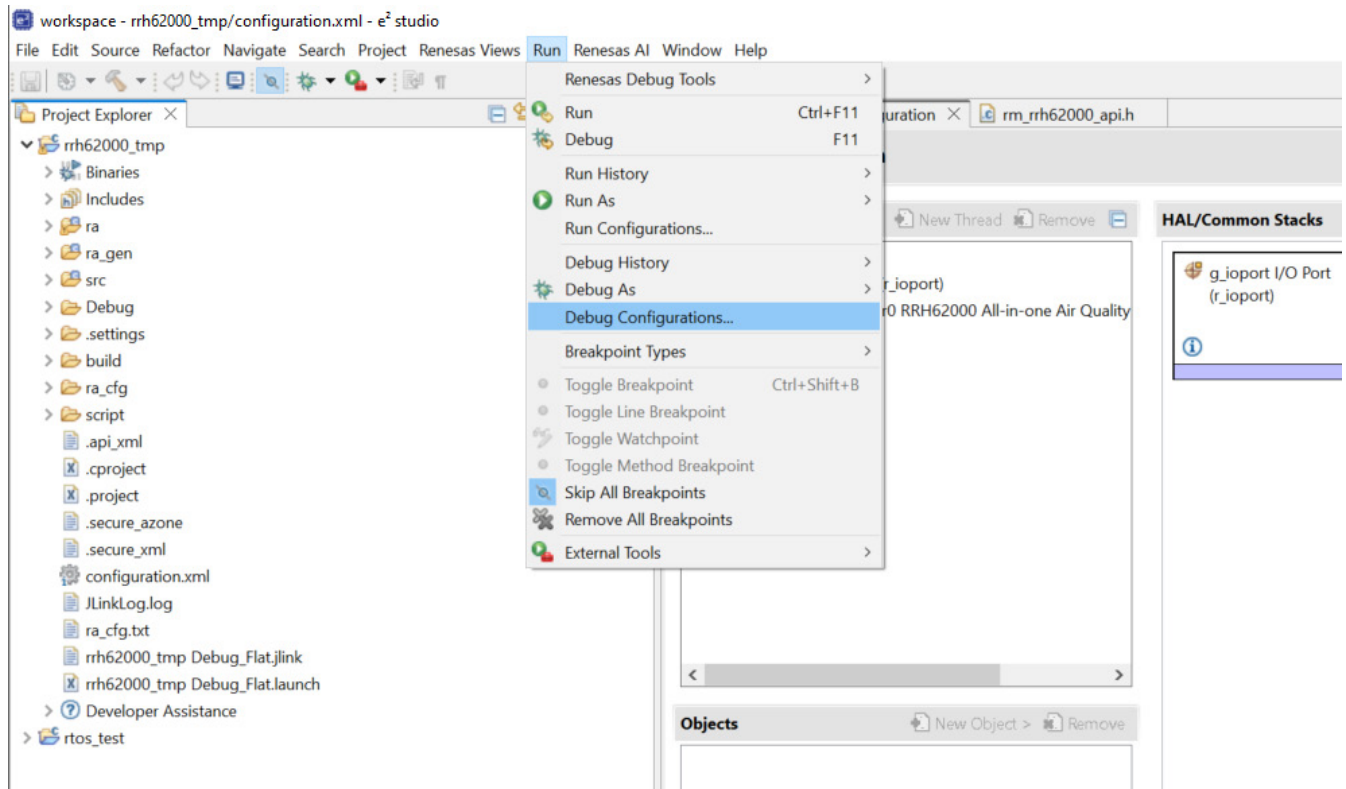

Figure 17. Debug Configuration Selection

- 3. Select **Renesas GDB Hardware Debugging > rrh62000\_tmp\_Debug**.
- 4. Click the *Debug* button. The code enters debug mode.

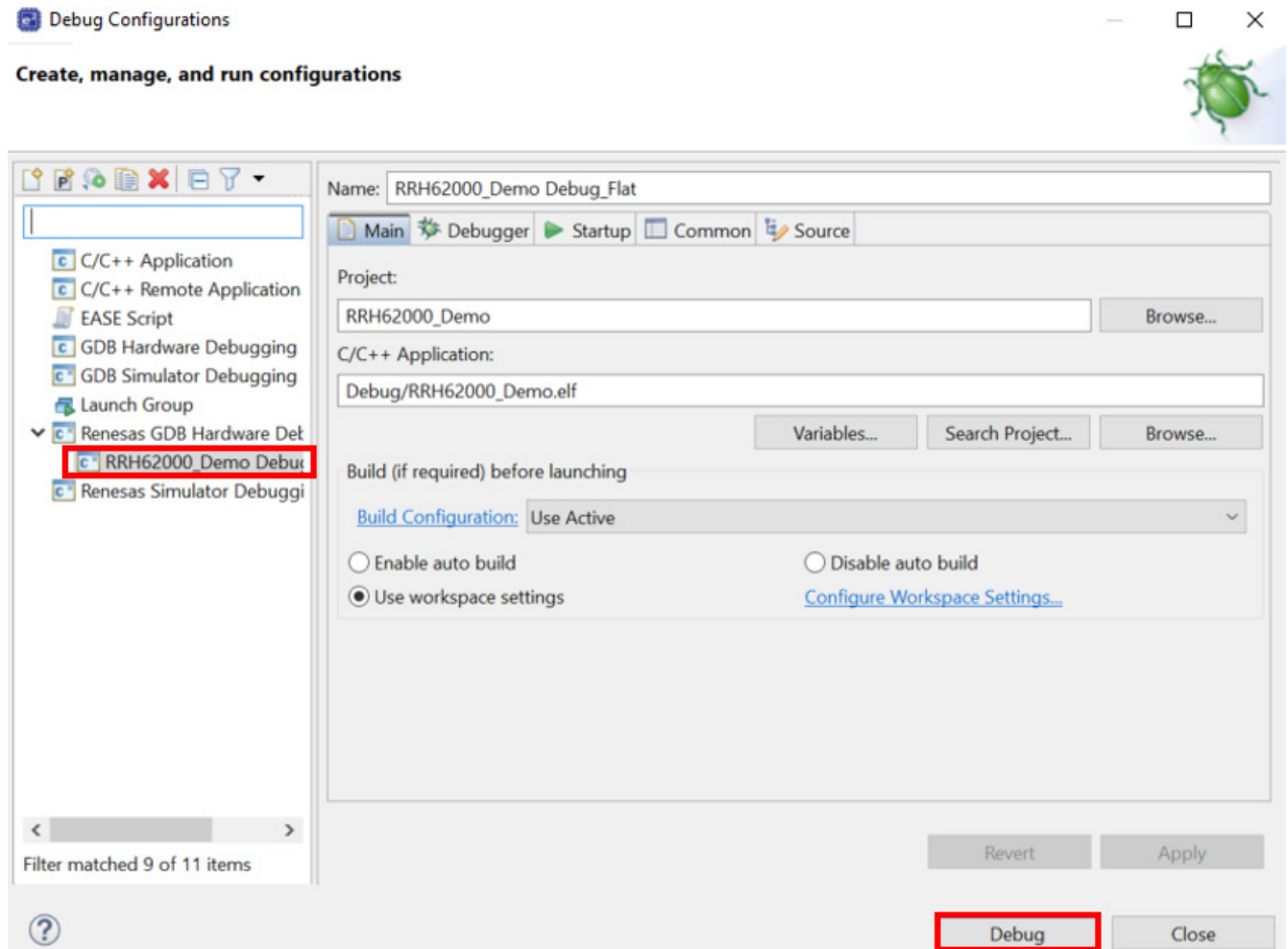

Figure 18. Debug Configurations – Start Debug Mode

- 5. From the Menu bar, select **Renesas Views > Debug > Visual Expression** (see Figure 19).

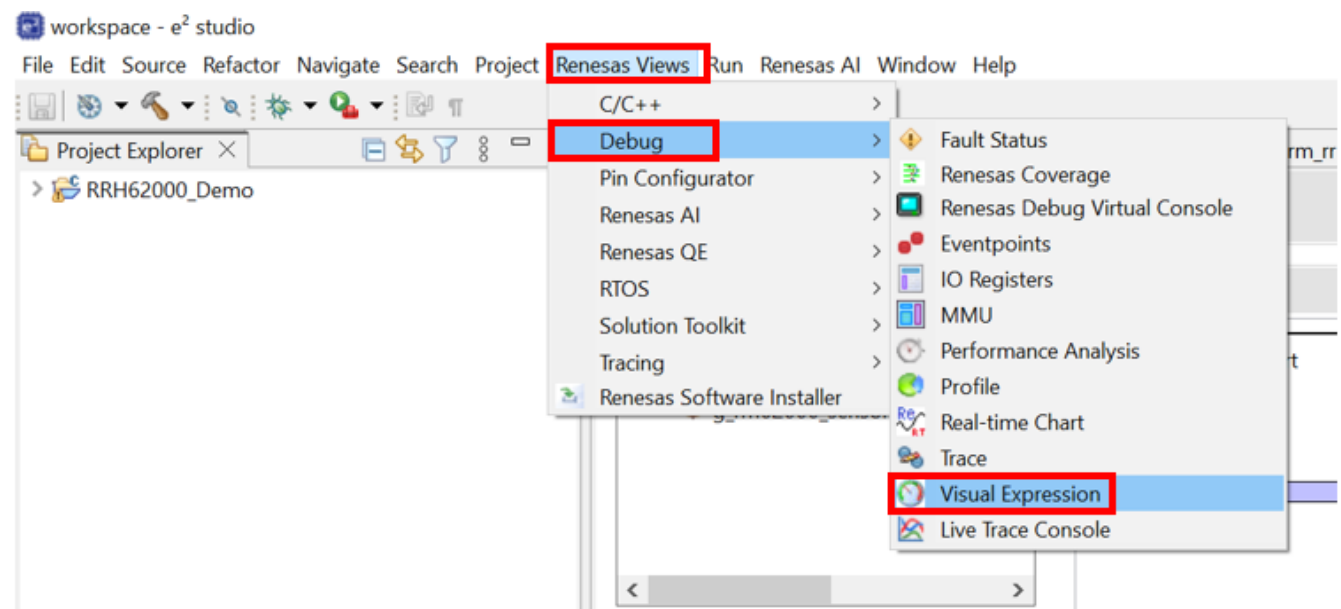

Figure 19. Open Visual Expression

In the bottom panel, the **Visual Expression** window appears (see Figure 20).

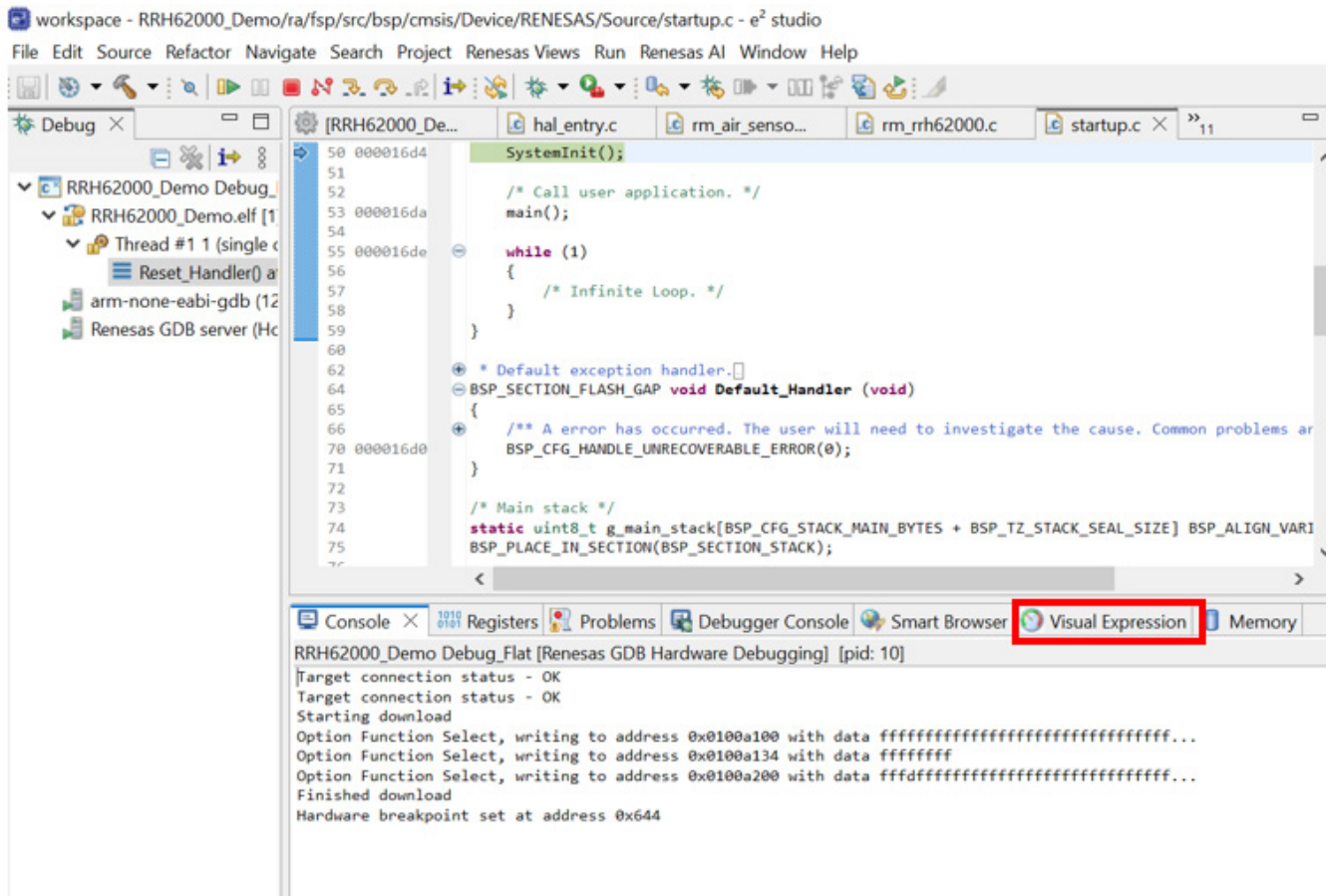

Figure 20. Visual Expression Window

6. Add gauges to see sensor data from the RRH62000 by dragging the **GAUGE** icon into the Visual Expression window (see Figure 21).

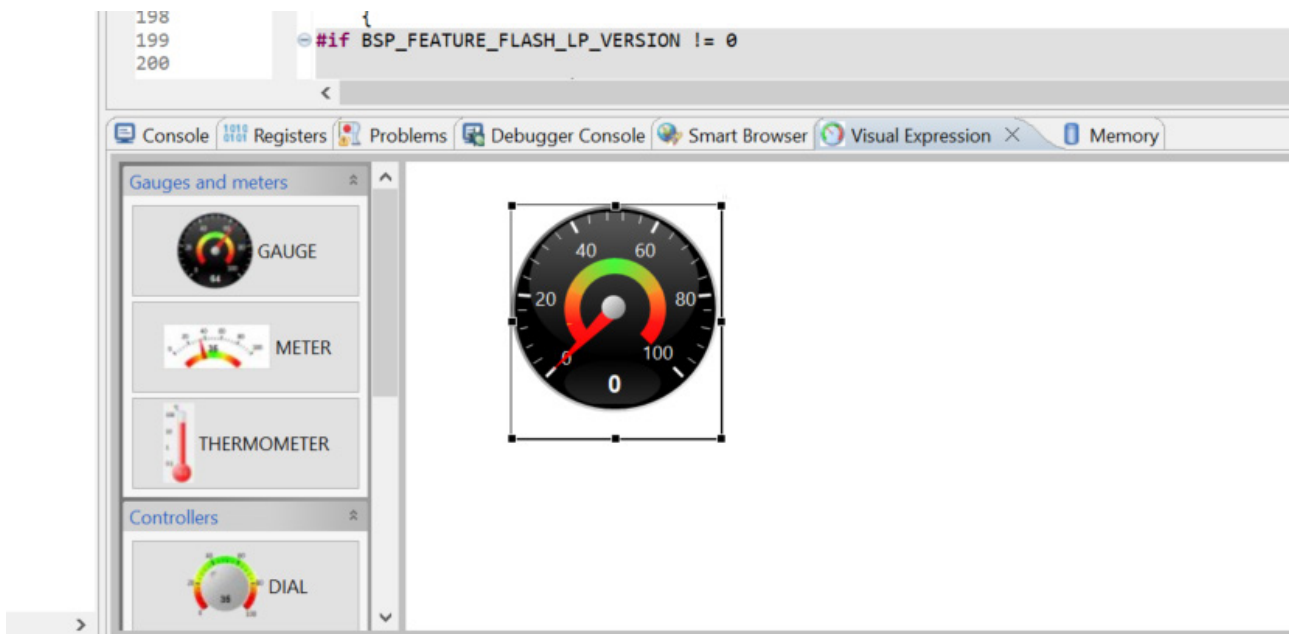

Figure 21. Gauge Setup

- 7. Right-click on the GAUGE and select **Set expression** (see Figure 22). This opens the **Set expression/Expression name** window (see Figure 23).

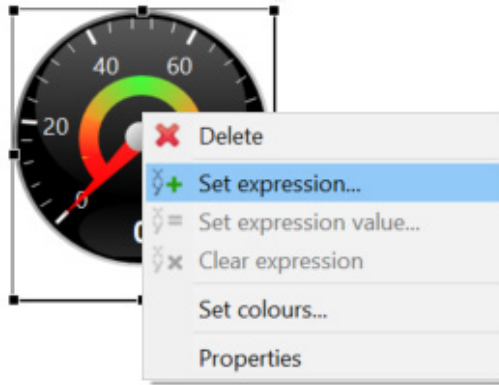

Figure 22. Set Gauge Expression

- 8. Enter **complete\_data->temperature** in the dialog box for the expression name. Click **OK**.

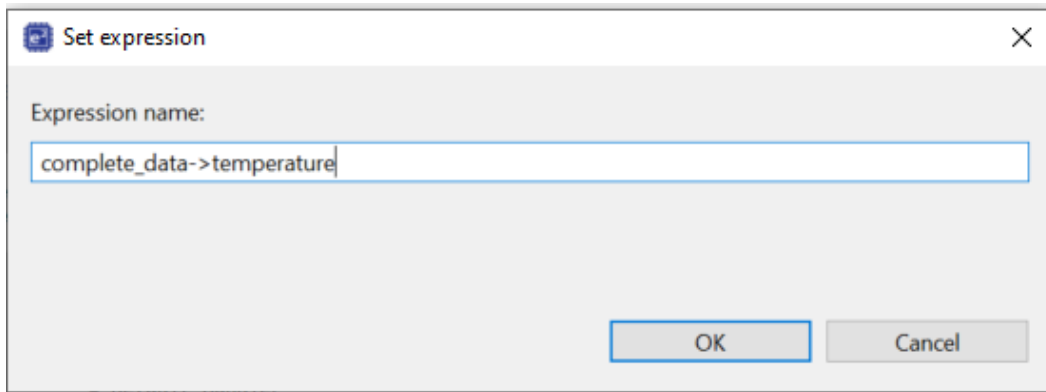

Figure 23. Set Expression Name

- 9. Right-click on the GAUGE and select **Properties** (see Figure 24).

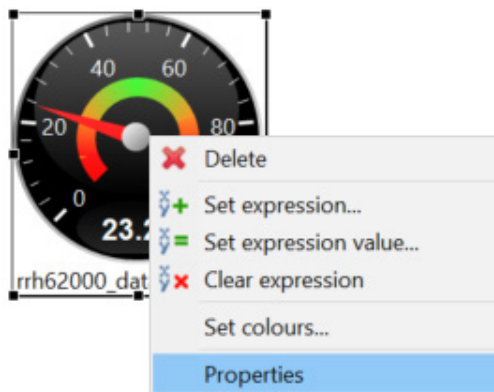

Figure 24. Gauge Properties



10. In the Properties window, enter **-40** for the temperature **Minimum range** and **125** for the temperature **Maximum range** (see [Figure 25](#)).

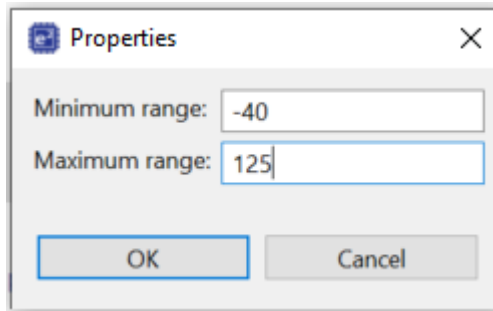

Figure 25. Gauge Minimum and Maximum Temperature

Add a **GAUGE** for each sensor value you wish to see. A list of available sensor values is shown in [Figure 26](#).

```
typedef struct st_rm_air_sensor_conc_data
{
    float_t nc_0p3;    ///< Number concer
    float_t nc_0p5;    ///< Number concer
    float_t nc_1;     ///< Number concer
    float_t nc_2p5;   ///< Number concer
    float_t nc_4;     ///< Number concer
    float_t pm1_1;    ///< Mass concentr
    float_t pm2p5_1;  ///< Mass concentr
    float_t pm10_1;   ///< Mass concentr
    float_t pm1_2;    ///< Mass concentr
    float_t pm2p5_2;  ///< Mass concentr
    float_t pm10_2;   ///< Mass concentr
    float_t temperature; ///< Temperature [
    float_t humidity;  ///< Humidity [%RH
    float_t tvoc;      ///< Total volatil
    float_t eco2;      ///< Estimated car
    float_t iaq;       ///< Indoor Air Qu
    float_t rel_iaq;   ///< Relative IAQ
} rm_air_sensor_conc_data_t;
```

Figure 26. Available Sensor Values

## 4. Ordering Information

Part Number	Description
QCIOT-RRH62000POCZ	All-In-One Air Quality Pmod Board

## 5. Revision History

Revision	Date	Description
1.00	Dec 3, 2024	Initial release.

## IMPORTANT NOTICE AND DISCLAIMER

RENESAS ELECTRONICS CORPORATION AND ITS SUBSIDIARIES (“RENESAS”) PROVIDES TECHNICAL SPECIFICATIONS AND RELIABILITY DATA (INCLUDING DATASHEETS), DESIGN RESOURCES (INCLUDING REFERENCE DESIGNS), APPLICATION OR OTHER DESIGN ADVICE, WEB TOOLS, SAFETY INFORMATION, AND OTHER RESOURCES “AS IS” AND WITH ALL FAULTS, AND DISCLAIMS ALL WARRANTIES, EXPRESS OR IMPLIED, INCLUDING, WITHOUT LIMITATION, ANY IMPLIED WARRANTIES OF MERCHANTABILITY, FITNESS FOR A PARTICULAR PURPOSE, OR NON-INFRINGEMENT OF THIRD-PARTY INTELLECTUAL PROPERTY RIGHTS.

These resources are intended for developers who are designing with Renesas products. You are solely responsible for (1) selecting the appropriate products for your application, (2) designing, validating, and testing your application, and (3) ensuring your application meets applicable standards, and any other safety, security, or other requirements. These resources are subject to change without notice. Renesas grants you permission to use these resources only to develop an application that uses Renesas products. Other reproduction or use of these resources is strictly prohibited. No license is granted to any other Renesas intellectual property or to any third-party intellectual property. Renesas disclaims responsibility for, and you will fully indemnify Renesas and its representatives against, any claims, damages, costs, losses, or liabilities arising from your use of these resources. Renesas' products are provided only subject to Renesas' Terms and Conditions of Sale or other applicable terms agreed to in writing. No use of any Renesas resources expands or otherwise alters any applicable warranties or warranty disclaimers for these products.

(Disclaimer Rev.1.01)

### Corporate Headquarters

TOYOSU FORESIA, 3-2-24 Toyosu,  
Koto-ku, Tokyo 135-0061, Japan  
[www.renesas.com](http://www.renesas.com)

### Trademarks

Renesas and the Renesas logo are trademarks of Renesas Electronics Corporation. All trademarks and registered trademarks are the property of their respective owners.

### Contact Information

For further information on a product, technology, the most up-to-date version of a document, or your nearest sales office, please visit [www.renesas.com/contact-us/](http://www.renesas.com/contact-us/).