

RTKA223012DR0010BU, RTKA223012DR0020BU

The [RAA223012](#) demonstration boards (RTKA223012DR0010BU and RTKA223012DR0020BU) are high voltage Buck converters that demonstrate low-cost high performance non-isolated AC/DC conversion from a universal input of $85V_{AC}$ to $265V_{AC}$, to a 5V output with the output current up to 150mA.

The board has built-in overcurrent, short-circuit, input brownout, and over-temperature protection, and is designed on a compact PCB with a low-cost half-wave input rectification. It is pre-compliant with conducted and radiated EMI requirements by EN55022/CISPR 22 and the 1.5kV surge test by IEC61000-4-5 standard.

RTKA223012DR0010BU comes with a RAA223012 in SO8 package. RTKA223012DR0020BU comes with a RAA223012 in SOT23-5 package.

Features

- Universal input range
- Compact PCB with low-cost external components
- EMI compliance for EN55022/CISPR22
- Surge test compliance to IEC61000-4-5 up to 1.5kV
- Standby power less than 10mW
- No audible noise

Specifications

This board is optimized for the following operating conditions:

Input voltage: $85V_{AC} \sim 265V_{AC}$

Output voltage: $5V_{DC}$

Output current: 150mA maximum

Output power: 0.75W

Efficiency: >62.5% at 100% load; 65% at 50% load

No-load power: <10mW at $230V_{AC}$

Load regulation: -3%, load range 10% to 100%

Operating temperature: $-45 \sim 85^{\circ}C$

Board dimension: 48mm x 29mm

Contents

1. Functional Description	3
1.1 Recommended Equipment	3
1.2 Setup and Configuration	3
2. Board Design	4
2.1 Layout Guidelines	5
2.2 Schematic Diagrams	6
2.3 Bill of Materials	8
2.3.1 RTKA223012DR0010BU	8
2.3.2 RTKA223012DR0020BU	9
2.4 Board Layout	10
3. Typical Performance Graphs	11
4. EMI Test Results	11
5. Ordering Information	12
6. Revision History	12

1. Functional Description

The RTKA223012DR0010BU and RTKA223012DR0020BU are high side float-switching buck regulators. Its input has D1 and D7 as a low-cost rectification (with optional full bridge rectifier foot-print). FR is a 1W fusible resistor providing input overcurrent protection and inrush current limiting. It also helps to absorb the input line surge energy together with DC buffer caps, C1 and C2.

C1, L1, and C2 consists of the input filter that provides the energy buffer after rectification and reduces conducted EMI noises to the input. L2, D2, and COUT are the buck converter components. RFB1, RFB2, CFB2, and CFB1 provide the output feedback signal to the IC. D4 and R2 provide V_{CC} biasing current after startup to increase the efficiency. They can be optional for low-cost low power applications. C_{VCC} is the IC supply capacitor.

1.1 Recommended Equipment

- AC Power supply capable of generating AC voltage from 85V_{AC} to 265V_{AC} at 60Hz/50Hz, with at least 100mA output current capability.
- Load resistor box with adjustable value of 33Ω and up, or an electronics load that can emulate a resistor load or current load up to 150mA.
- Multimeters to measure the output voltage and current.
- Power meter to measure the AC input power.

1.2 Setup and Configuration

- Program the AC power supply with a voltage between 85V_{AC} to 265V_{AC} at the corresponding frequency of 60Hz or 50Hz.
- While the AC power supply is off, connect the output cables of the AC power supply to the L and N terminal of the RTKA223012DR0010BU (or RTKA223012DR0020BU). An optional power meter can be added in between the AC power supply output and the input of the board.
- Connect the load to the output terminals VOUT and GND.
- Connect a voltage meter to VOUT+ and GND and connect a current meter between board outputs and the load.
- Turn on the AC power supply.

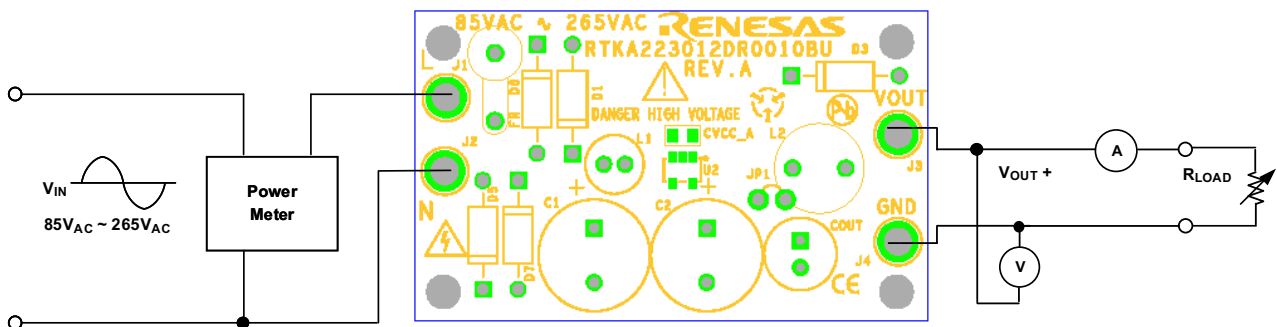

Figure 1. RTKA223012DR0010BU/RTKA223012DR0020BU Connection Diagram

2. Board Design

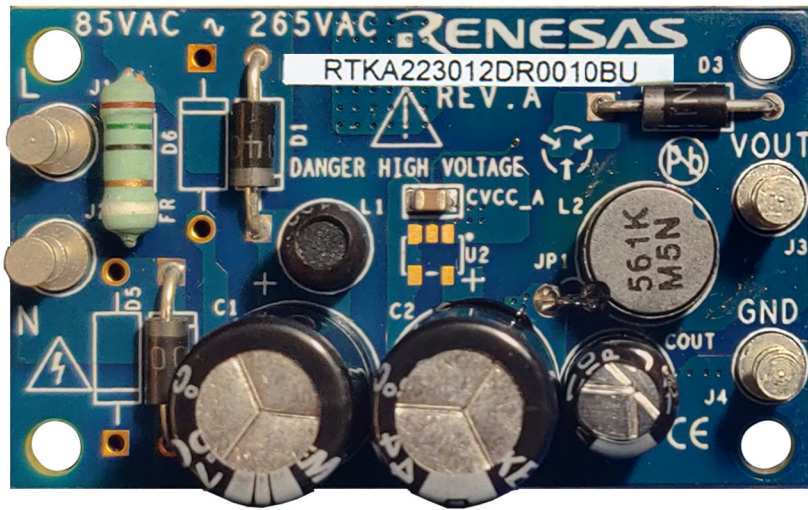

Figure 2. RTKA223012DR0010BU Evaluation Board (Top)

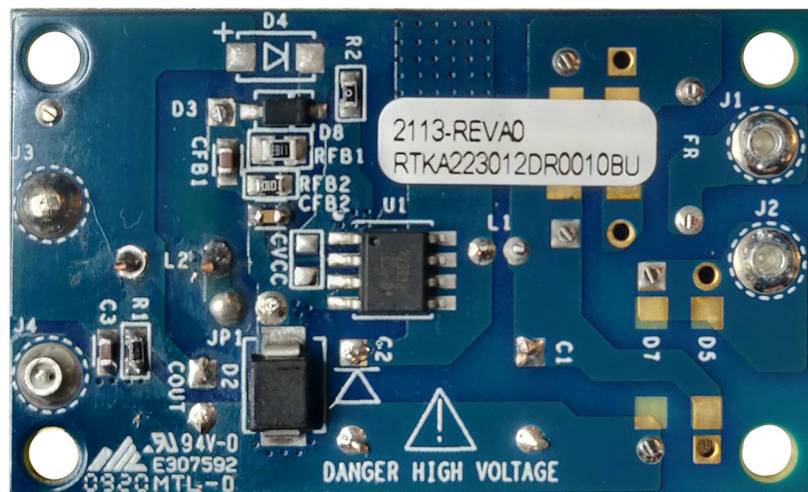

Figure 3. RTKA223012DR0010BU Evaluation Board (Bottom)

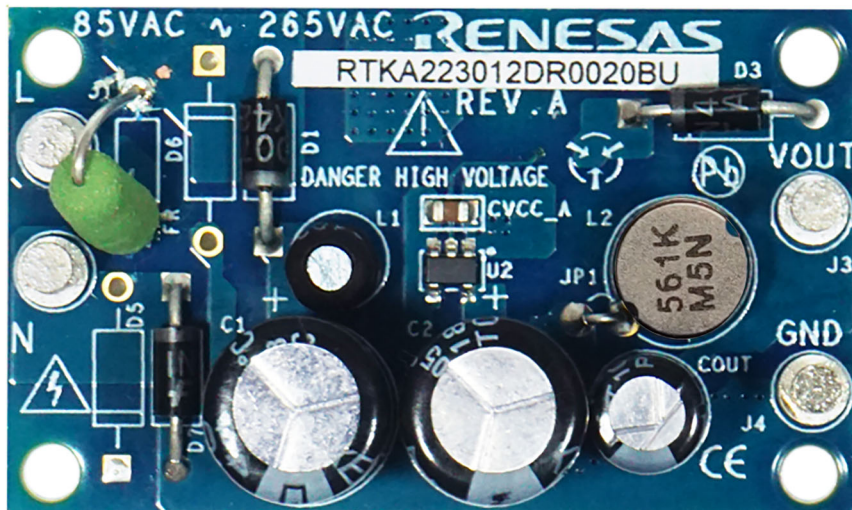

Figure 4. RTKA223012DR0020BU Evaluation Board (Top)

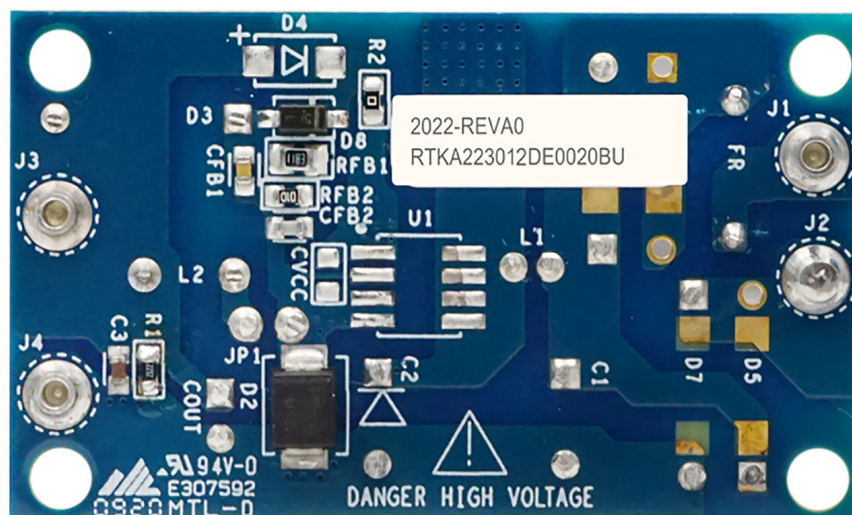

Figure 5. RTKA223012DR0020BU Evaluation Board (Bottom)

2.1 Layout Guidelines

For detailed PCB guidelines, see the RAA223012 datasheet.

2.2 Schematic Diagrams

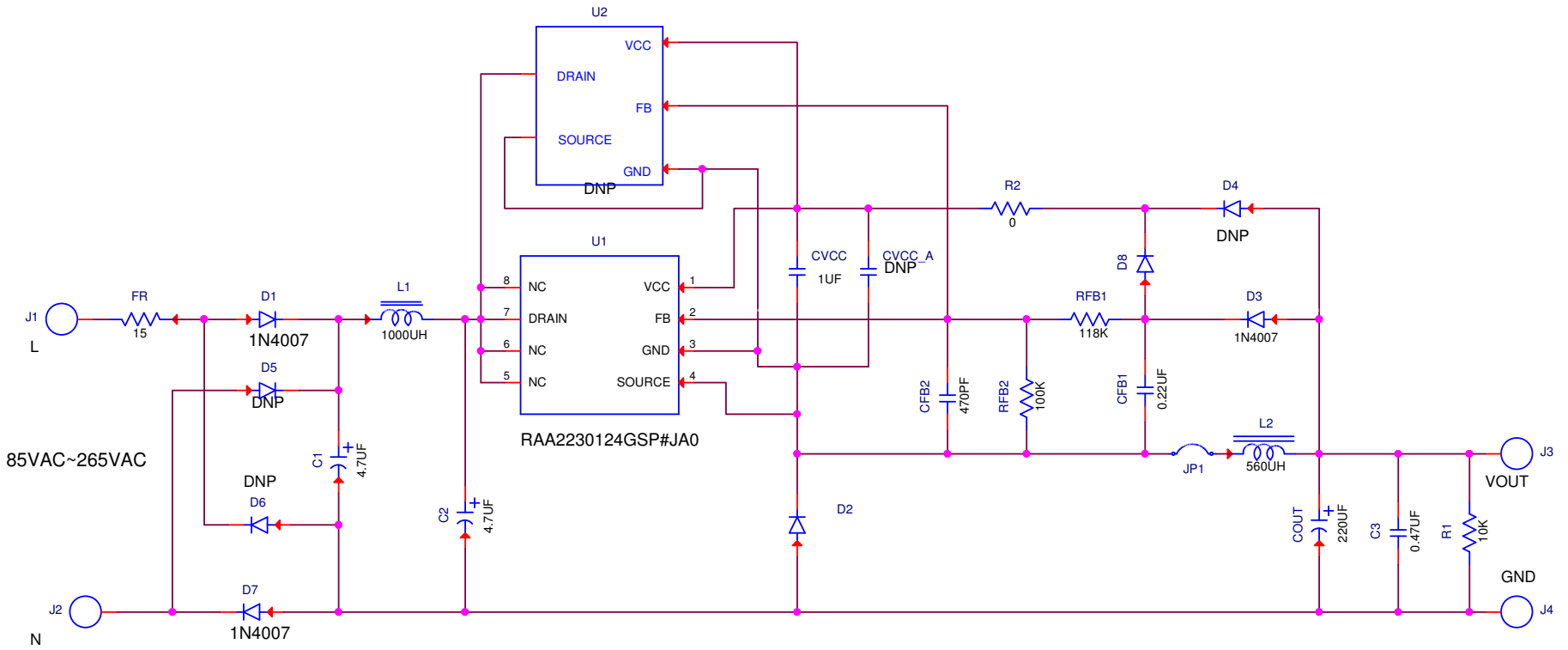

Figure 6. RTKA223012DR0010BU Schematic

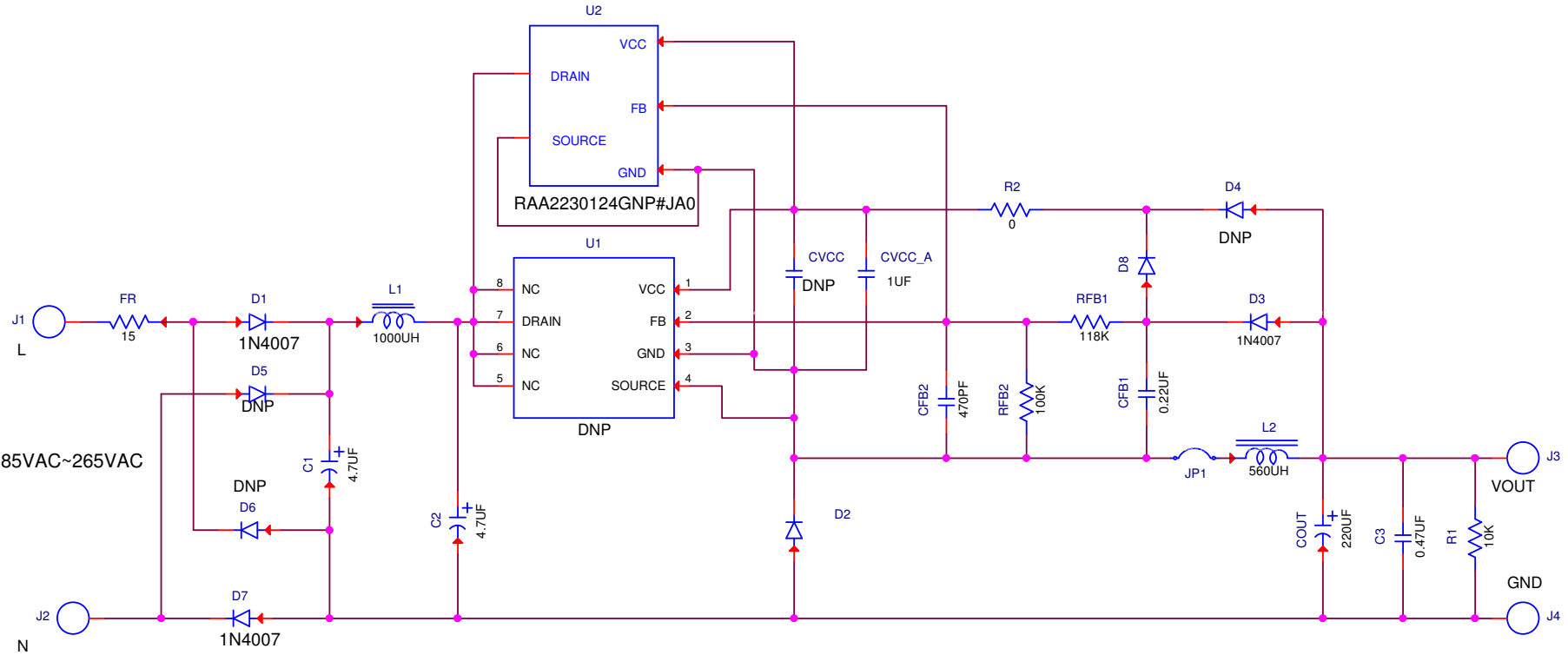

Figure 7. RTKA223012DR0020BU Schematic

2.3 Bill of Materials

2.3.1 RTKA223012DR0010BU

Qty	Designator	Description	Value	Manufacturer	Manufacturer Number
1	COUT	Aluminum Electrolytic 105C rated 5khrs	220 μ F, 20%, 16V,RADIAL	Rubycon	16YXJ220MT16.3X11
3	D1, D3, D7	Generic Diode	1A 1000V, AXIAL	Various	1N4007
0	D5-D6	Generic Diode	1A 1000V, AXIAL	Various	1N4007
1	C3	Multilayer Ceramic Cap	0.47 μ F, 10%, 16V, 0603	TDK	C1608X7R1C474K
1	FR	Fusible Metal Film Resistor	15, 1%, 1W, AXIAL	Yageo	FKN1WSJR-52-15R
0	D4	Fast Recovery Diode	1A, 600V, DO214	Fairchild	ES1J
2	C1, C2	Alum Cap 105C rated 5kHrs	4.7 μ F, 20%,400V,RADIAL	Kemet	ESG475M400AH2AA
1	CFB2	Multilayer Ceramic Cap	SMD, 0603, 470pF, 50V, 10%, ROHS	Various	Generic
1	CFB1	Multilayer Ceramic Cap	0.22 μ F, 20%, 25V, 0603	Various	Generic
0	CVCC_A	Multilayer Ceramic Cap	1 μ F, 10%, 25V, 0805	Various	Generic
1	CVCC	Multilayer Ceramic Cap	1 μ F, 10%, 25V, 0805	Various	Generic
1	R2	Thick Film Chip Resistor	0, 1%, 1/16W, 0603	Various	Generic
1	RFB2	Thick Film Chip Resistor	100k, 1%, 1/16W, 0603	Various	Generic
1	R1	Thick Film Chip Resistor	10k, 1%, 1/16W, 0603	Various	Generic
1	RFB1	Thick Film Chip Resistor	118k, 1%, 1/10W, 0805	Various	Generic
1	D8	Switching Diode	SOD123	ON-Semi	MMSD4148T1
1	D2	Ultrafast Power Rectifier	SMB	On Semiconductor	MURS160T3
1	U1	700V, Offline Regulator	SO8	Renesas	RAA2230124GSP#AA0
0	U2	700V, Offline Regulator	SOT23-5	Renesas	RAA2230124GP3#AA0
1	L2	Coil-PWR Inductor, TH, Radial	560 μ H, 10%, 0.16A, ROHS	Sumida	RCH855NP-561K
1	L1	Fixed Inductor	1mH, 10%, 0.1A, Radial	Bourns	RLB0608-102KL

2.3.2 RTKA223012DR0020BU

Qty	Designator	Description	Value	Manufacturer	Manufacturer Number
1	COUT	Aluminum Electrolytic 105C rated 5khrs	220 μ F, 20%, 16V,RADIAL	Rubycon	16YXJ220MT16.3X11
3	D1, D3, D7	Generic Diode	1A 1000V, AXIAL	Various	1N4007
0	D5-D6	Generic Diode	1A 1000V, AXIAL	Various	1N4007
1	C3	Multilayer Ceramic Cap	0.47 μ F, 10%, 16V, 0603	TDK	C1608X7R1C474K
1	FR	Fusible Metal Film Resistor	15, 1%, 1W, AXIAL	Yageo	FKN1WSJR-52-15R
0	D4	Fast Recovery Diode	1A, 600V, DO214	Fairchild	ES1J
2	C1, C2	Cap Alum 105C rated 5kHrs	4.7 μ F, 20%,400V,RADIAL	Kemet	ESG475M400AH2AA
1	CFB2	Multilayer Ceramic Cap	SMD, 0603, 470pF, 50V, 10%, ROHS	Various	Generic
1	CFB1	Multilayer Ceramic Cap	0.22 μ F, 20%, 25V, 0603	Various	Generic
1	CVCC_A	Multilayer Ceramic Cap	1 μ F, 10%, 25V, 0805	Various	Generic
0	CVCC	Multilayer Ceramic Cap	1 μ F, 10%, 25V, 0805	Various	Generic
1	R2	Thick Film Chip Resistor	0, 1%, 1/16W, 0603	Various	Generic
1	RFB2	Thick Film Chip Resistor	100k, 1%, 1/16W, 0603	Various	Generic
1	R1	Thick Film Chip Resistor	10k, 1%, 1/16W, 0603	Various	Generic
1	RFB1	Thick Film Chip Resistor	118k, 1%, 1/10W, 0805	Various	Generic
1	D8	Switching Diode	SOD123	ON-Semi	MMSD4148T1
1	D2	Ultrafast Power Rectifier	SMB	On Semiconductor	MURS160T3
0	U1	700V, Offline Regulator	SO8	Renesas	RAA2230124GSP#AA0
1	U2	700V, Offline Regulator	SOT23-5	Renesas	RAA2230124GP3#AA0
1	L2	Coil-PWR Inductor, TH, Radial	560 μ H, 10%, 0.16A, ROHS	Sumida	RCH855NP-561K
1	L1	Fixed Inductor	1mH, 10%, 0.1A, Radial	BOURNS	RLB0608-102KL

2.4 Board Layout

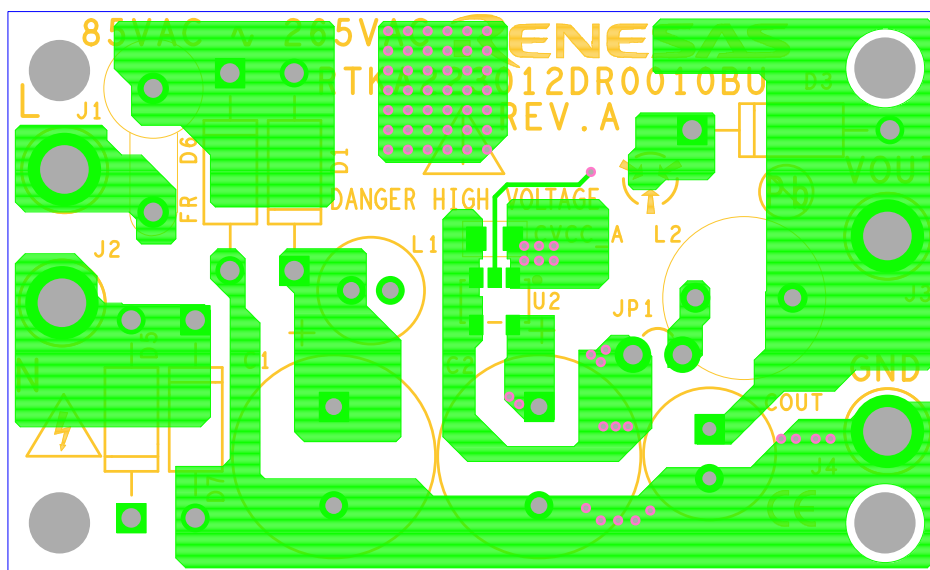

Figure 8. Top Layer

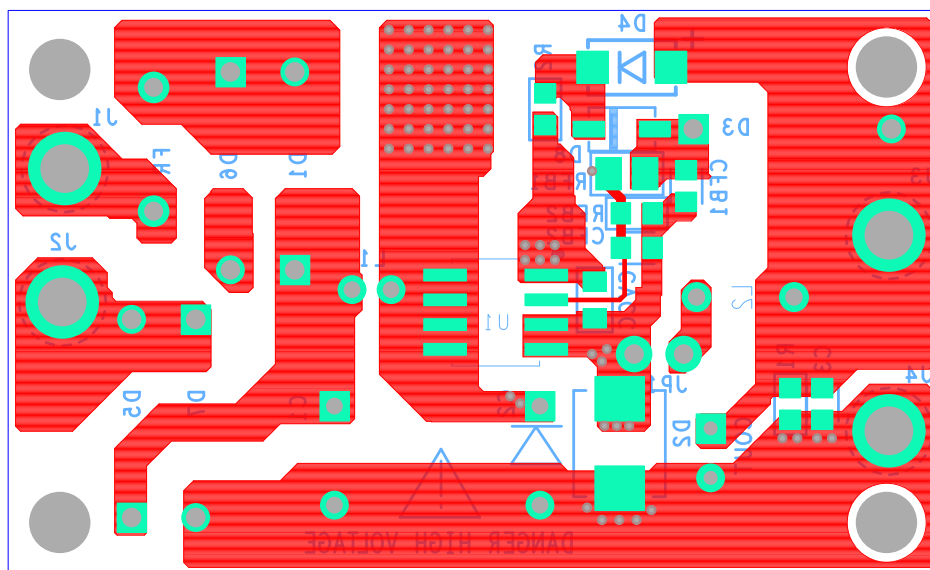

Figure 9. Bottom Layer

3. Typical Performance Graphs

$V_{IN} = 85V_{AC} \sim 265V_{AC}$, $V_{OUT} = 5V$, $I_{OUT} = 150mA$ (max), $T_A = +25^{\circ}C$

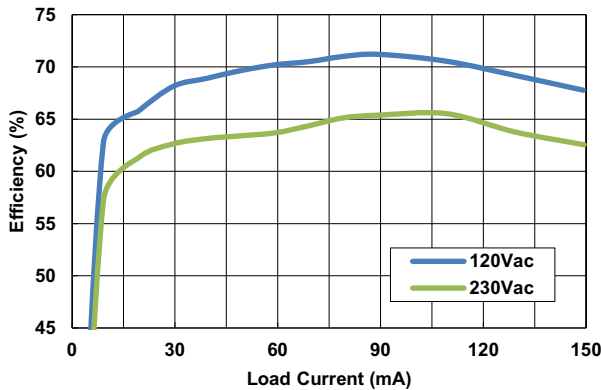

Figure 10. Efficiency Overload Current

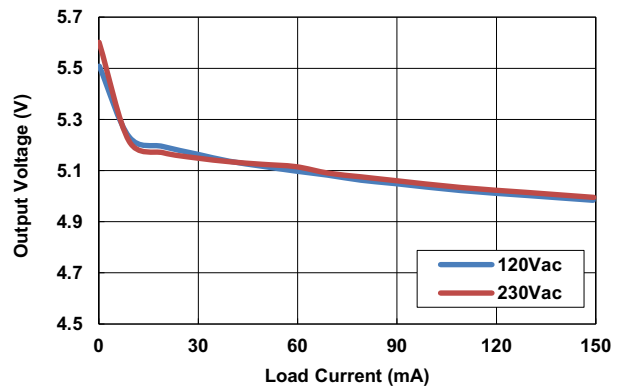

Figure 11. Load Regulation

Table 1. Typical No-load Power Consumption

Power Supply	Standby Power	Energy Star
120V _{AC} /60Hz	4.5mW	300mW
230V _{AC} /50Hz	8.5mW	300mW

4. EMI Test Results

RTKA223012DR0010BU/RTKA223012DR0020BU Buck regulator is compliant to the conducted and radiated EMI requirements of FCC Part 22 and CISPR22.

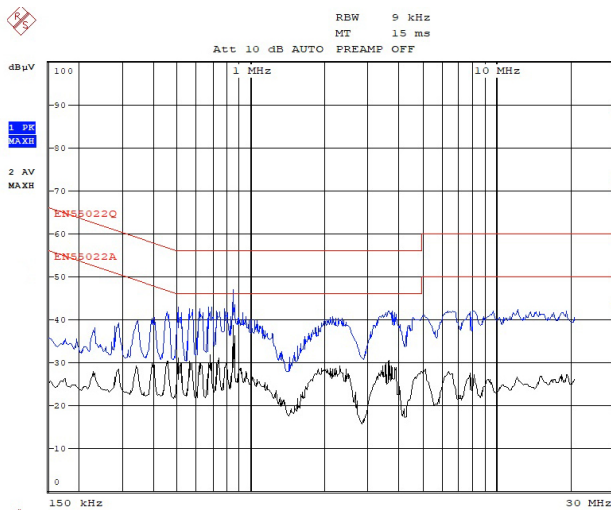

Figure 12. Line, 120V_{AC}

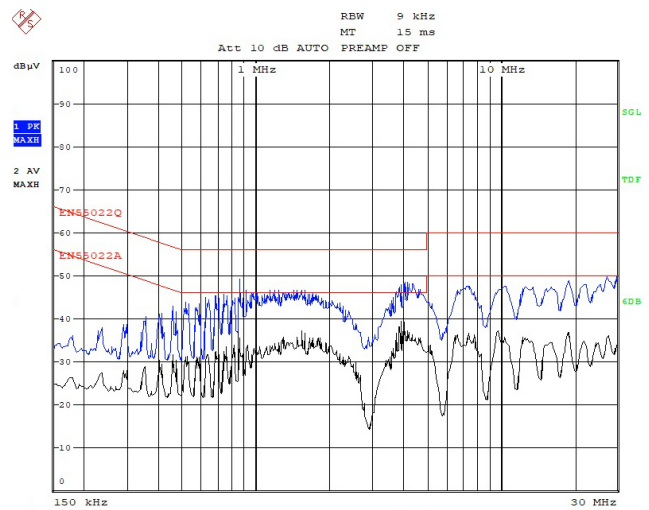

Figure 13. Line, 230V_{AC}

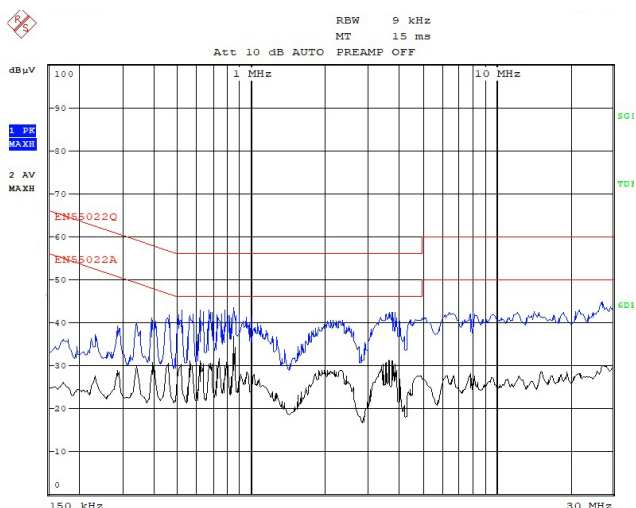

Figure 14. Neutral, 120V_{AC}

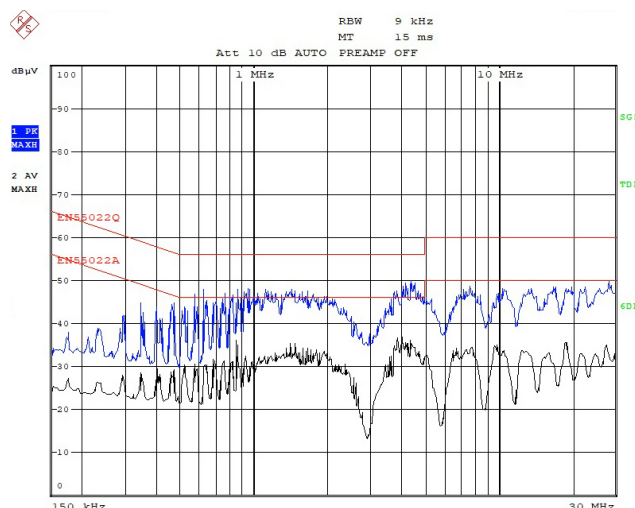

Figure 15. Neutral, 230V_{AC}

5. Ordering Information

Part Number	Description
RTKA223012DR0010BU	RAA223012 SOIC-8 Demonstration Board
RTKA223012DR0020BU	RAA223012 SOT23-5 Demonstration Board

6. Revision History

Revision	Date	Description
2.0	Jul 2, 2021	Updated BOMs, Schematics, and the photos of both boards.
1.0	Mar 10, 2021	Initial release

IMPORTANT NOTICE AND DISCLAIMER

RENESAS ELECTRONICS CORPORATION AND ITS SUBSIDIARIES (“RENESAS”) PROVIDES TECHNICAL SPECIFICATIONS AND RELIABILITY DATA (INCLUDING DATASHEETS), DESIGN RESOURCES (INCLUDING REFERENCE DESIGNS), APPLICATION OR OTHER DESIGN ADVICE, WEB TOOLS, SAFETY INFORMATION, AND OTHER RESOURCES “AS IS” AND WITH ALL FAULTS, AND DISCLAIMS ALL WARRANTIES, EXPRESS OR IMPLIED, INCLUDING, WITHOUT LIMITATION, ANY IMPLIED WARRANTIES OF MERCHANTABILITY, FITNESS FOR A PARTICULAR PURPOSE, OR NON-INFRINGEMENT OF THIRD PARTY INTELLECTUAL PROPERTY RIGHTS.

These resources are intended for developers skilled in the art designing with Renesas products. You are solely responsible for (1) selecting the appropriate products for your application, (2) designing, validating, and testing your application, and (3) ensuring your application meets applicable standards, and any other safety, security, or other requirements. These resources are subject to change without notice. Renesas grants you permission to use these resources only for development of an application that uses Renesas products. Other reproduction or use of these resources is strictly prohibited. No license is granted to any other Renesas intellectual property or to any third party intellectual property. Renesas disclaims responsibility for, and you will fully indemnify Renesas and its representatives against, any claims, damages, costs, losses, or liabilities arising out of your use of these resources. Renesas' products are provided only subject to Renesas' Terms and Conditions of Sale or other applicable terms agreed to in writing. No use of any Renesas resources expands or otherwise alters any applicable warranties or warranty disclaimers for these products.

(Rev.1.0 Mar 2020)

Corporate Headquarters

TOYOSU FORESIA, 3-2-24 Toyosu,
Koto-ku, Tokyo 135-0061, Japan
www.renesas.com

Contact Information

For further information on a product, technology, the most up-to-date version of a document, or your nearest sales office, please visit:
www.renesas.com/contact/

Trademarks

Renesas and the Renesas logo are trademarks of Renesas Electronics Corporation. All trademarks and registered trademarks are the property of their respective owners.