

ZMID4200

**Description**

The ZMID4200 Evaluation Kit enables evaluation of the Renesas ZMID4200 Inductive Position Sensor IC via Renesas' ZMID4200 Application Modules (available separately).

The main purpose of the ZMID4200 Evaluation Kit is communication between the user's computer and the ZMID4200. The user's computer sends commands and data via its USB port to the ZMID Communication Board (ZMID-COMBOARD).

The microcontroller on the ZMID-COMBOARD interprets these commands and relays them to the ZMID4200 located on the ZMID4200 Application Module using the one-wire interface (OWI) communication interface.

The microcontroller also forwards data bytes from the ZMID4200 back to the computer via the USB connection. These bytes can be sensor readings, ZMID4200 internal registers values, or ZMID4200 EEPROM contents.

The *ZMID4200 EVKIT Application Software* is a graphical user interface (GUI) that is provided online for the kit. It supports all ZMID4200 configurations and enables the user to understand the functionality of the ZMID4200 as well as perform measurements.

**Features**

- USB “plug and play” – no driver installation needed
- Small ZMID-COMBOARD: 4cm × 7.3cm
- One-wire communication interface (OWI) enables quick and easy configuration and calibration of the ZMID4200 using the user's computer
- PWM, analog, or SENT output (programmable)
- The modular design allows easy swapping in different ZMID4200 Application Modules (available separately) for evaluation using the same ZMID-COMBOARD and *ZMID4200 EVKIT Application Software*
- The kit software is available for download from the Renesas product page for the ZMID-COMBOARD: <http://www.renesas.com/ZMID4200stkit>
- Kit Contents
- ZMID-COMBOARD
- Micro-USB cable

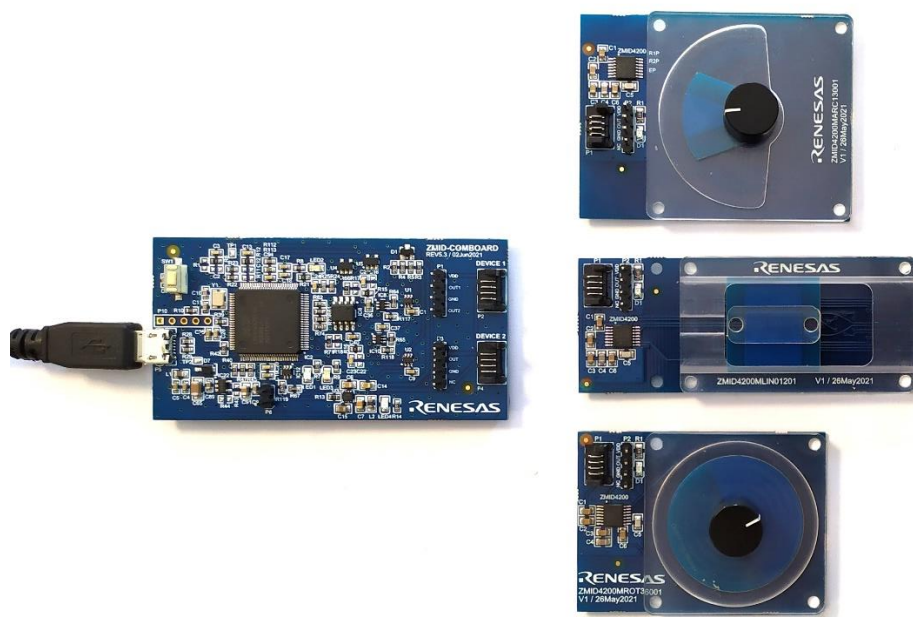

Figure 1. ZMID4200 Evaluation Kit and ZMID42200 Application Modules

## Important Notes

### Disclaimer

Integrated Device Technology, Inc. and its affiliated companies (herein referred to as “Renesas”) shall not be liable for any damages arising out of defects resulting from

- (i) delivered hardware or software
- (ii) non-observance of instructions contained in this manual and in any other documentation provided to user, or
- (iii) misuse, abuse, use under abnormal conditions, or alteration by anyone other than Renesas.

TO THE EXTENT PERMITTED BY LAW, Renesas HEREBY EXPRESSLY DISCLAIMS AND USER EXPRESSLY WAIVES ANY AND ALL WARRANTIES, WHETHER EXPRESS, IMPLIED, OR STATUTORY, INCLUDING, WITHOUT LIMITATION, IMPLIED WARRANTIES OF MERCHANTABILITY AND OF FITNESS FOR A PARTICULAR PURPOSE, STATUTORY WARRANTY OF NON-INFRINGEMENT, AND ANY OTHER WARRANTY THAT MAY ARISE BY REASON OF USAGE OF TRADE, CUSTOM, OR COURSE OF DEALING.

### Restrictions in Use

Renesas’ ZMID4200 Evaluation Kit, consisting of the ZMID-COMBOARD and micro-USB cable used in combination with the ZMID4200 Application Module and the *ZMID4200 AID EVKIT Application Software*, is designed for evaluation and configuration of the ZMID4200 product family only. Renesas’ ZMID4200 Evaluation Kit hardware and software must not be used for characterization measurements in terms of replacing calibrated laboratory environment and measurement devices.



**Important Safety Warning:** These procedures can result in high currents, which can cause severe injury or death and/or equipment damage. Only trained professional staff should connect external equipment and operate the software.



**Important Equipment Warning:** Ensure the correct connection of all cables. Supplying the board using the wrong polarity could result in damage to the board and/or the equipment.

## Contents

<b>1. Setup</b> .....	<b>5</b>
1.1 Required User Equipment .....	5
1.2 User Computer Requirements and Setup .....	5
1.2.1. Computer Requirements .....	5
1.2.2. Software Installation and Setup .....	5
1.3 Hardware Setup.....	5
1.4 Overview of the Hardware .....	6
1.4.1. Connecting the Kit.....	8
<b>2. ZMID4200 EVKIT Application Software User Guide</b> .....	<b>9</b>
2.1 Sections of the Display .....	9
2.2 Getting Started.....	10
2.2.1. Connecting to a Device .....	10
2.2.2. Reading Measurements .....	11
2.3 Changing the Configuration Settings.....	14
2.4 Calibration.....	16
2.4.1. “COIL OFFSET” Sub-tab.....	16
2.4.2. “OUTPUT RANGE” Sub-tab.....	18
2.4.3. “CALIBRATION AND LINEARIZATION” Tab.....	22
2.5 Working with the Memory .....	27
2.5.1. “MEMORY EDIT” Tab .....	27
2.5.2. Saving and Loading Memory Dump Files .....	28
2.5.3. Viewing Memory Dump Files without Connecting to a Device (Offline) .....	28
2.6 Manually Identifying a Device.....	29
2.6.1. Identifying an Unknown Device.....	29
<b>3. Firmware Update</b> .....	<b>31</b>
<b>4. ZMID-COMBOARD Schematics</b> .....	<b>32</b>
<b>5. ZMID-COMBOARD BOM</b> .....	<b>33</b>
<b>6. Sensors Boards</b> .....	<b>35</b>
<b>7. Glossary</b> .....	<b>35</b>
<b>8. Ordering Information</b> .....	<b>35</b>
<b>9. Revision History</b> .....	<b>35</b>

## Figures

Figure 1. ZMID4200 Evaluation Kit and ZMID42200 Application Modules .....	1
Figure 2. ZMID4200 Evaluation Kit Connections – ZMID4200 Arc Application Module Example .....	6
Figure 3. ZMID-COMBOARD – Overview .....	6
Figure 4. ZMID4200 Rotary 360° Application Module – Overview.....	7
Figure 5. ZMID4200 Arc 130° Application Module – Overview .....	8
Figure 6. ZMID4200 Linear Application Module – Overview .....	8
Figure 7. Sections of the GUI Display – Example ZMID4200 .....	9
Figure 8. Start-up Screen .....	10

Figure 9. Display When Connected to a Device.....	11
Figure 10. Display When Connected to 2 Devices – ZMID4200 Example.....	11
Figure 11. “OUTPUT” Tab – Analog Output Example.....	12
Figure 12. “INTERNAL VALUES” Tab – Analog Output Example.....	13
Figure 13. “SENT” Tab.....	14
Figure 14. "CONFIGURE" Tab – Selection of Memory Type to be Displayed.....	14
Figure 15. Buttons in the “I/O FUNCTIONS” Section.....	15
Figure 16. Options on the “SETTINGS” Menu.....	15
Figure 17. Example of Numerical Values That Can be Edited.....	15
Figure 18. Example of a Drop-Down Menu with Multiple Choice Values.....	15
Figure 19. Example of Read-Only Values.....	15
Figure 20. Example of a Modified Value that is Not Yet Saved to Memory.....	16
Figure 21. Example of Tooltip Information.....	16
Figure 22. “COIL OFFSET” Tab – ZMID4200 Example.....	16
Figure 23. Receiver Coil (ABS Value) Offset Example with Offset Compensation = $\alpha/2$ .....	17
Figure 24. Coil Offset Calibration Completed – ZMID4200 Example.....	17
Figure 25. “OUTPUT RANGE” Tab – ZMID4200 Example.....	18
Figure 26. Linear Output Mode Example with Slope = 2, Offset = 90°.....	19
Figure 27. Modulus Output Example with Slope = 2, Offset = 60°.....	19
Figure 28. Output without Clamping.....	20
Figure 29. Output Clamped from 20% to 80%.....	20
Figure 30. Specify the Original Slope.....	21
Figure 31. Request for Changing the Out_Mod Setting.....	21
Figure 32. Successful Calibration Message.....	22
Figure 33. Unsuccessful Calibration Message.....	22
Figure 34. "AUTO CAL" Sub-tab – ZMID4200 Example.....	22
Figure 35. Example Contents of an Input .csv file with Spatial Angle Data.....	23
Figure 36. Example Contents of a .csv Input File with Output Voltage Data.....	23
Figure 37. Example of AUTO CAL Error Messages.....	24
Figure 38. “MANUAL LINEARIZATION” Sub-tab – ZMID4200 Example.....	25
Figure 39. Calibration Diagram.....	26
Figure 40. “MEMORY EDIT” Tab Contents – ZMID4200 Example.....	27
Figure 41. Example of a Modified Value on the “MEMORY EDIT” Tab.....	27
Figure 42. Example of “MEMORY EDIT” Tab Tooltip Information.....	27
Figure 43. Menu Options for Saving and Loading Memory Dump Files.....	28
Figure 44. Viewing a Memory Dump File "Offline".....	28
Figure 45. GUI View if an Unknown Device is Selected.....	29
Figure 46. File Dialog to Select an Identification File.....	30

## 1. Setup

### 1.1 Required User Equipment

A Windows®-based computer is required for interfacing with the kit and configuring the ZMID4200.

### 1.2 User Computer Requirements and Setup

#### 1.2.1. Computer Requirements

The user must have administrative rights on the computer to download and install the *ZMID4200 EVKIT Application Software* for the kit.

The computer must meet the following requirements:

- Windows® Vista SP1 or later, 7 (including SP1), 8, 8.1, or 10.
  - **Note:** Touch screens are not supported.
  - **Note:** Windows® XP is no longer supported. Contact Renesas for assistance. See contact information on the last page.
- Supported architecture: x86 and x64.
- Available USB port.
- Internet access for downloading the *ZMID4200 EVKIT Application Software*.
- Microsoft® .NET Framework 4.0

#### 1.2.2. Software Installation and Setup

The *ZMID4200 EVKIT Application Software* is not included with the kit. To ensure use of the latest version of the software, it is available for download free of cost in zip file format from the Renesas web site on the web page given on page 1.

Follow these procedures to install the *ZMID4200 EVKIT Application Software*:

1. After downloading the zip file to the user's computer, extract the contents of the zip file.
2. Double-click on the extracted *setup.exe* file to activate the installation.
3. Follow the standard installation instructions displayed on the screen and change the installation path if required. If the default path settings have been used, the software automatically completes the installation and creates an access link on the user's computer under *Start > All Programs > Renesas > ZMID4200 EVKIT*. The installation dialog offers the option to create a desktop short-cut icon for the software.

### 1.3 Hardware Setup

This section describes the basic hardware setup of the ZMID4200 Evaluation Kit boards and provides a brief overview on the components. Refer to the user manual for the specific ZMID4200 Application Module for the setup required for the target holder, which is shown in Figure 1, and for further details for the module such as schematics and BOMs. The application module user manuals are available on the Renesas product web pages for the modules: See section 6 for the Renesas product web pages for the application modules to download the manuals.

## 1.4 Overview of the Hardware

Figure 2 shows the board connections for the ZMID4200 Evaluation Kit using the ZMID4200 Arc Application Module (ZMID4200MARC18001) as an example.

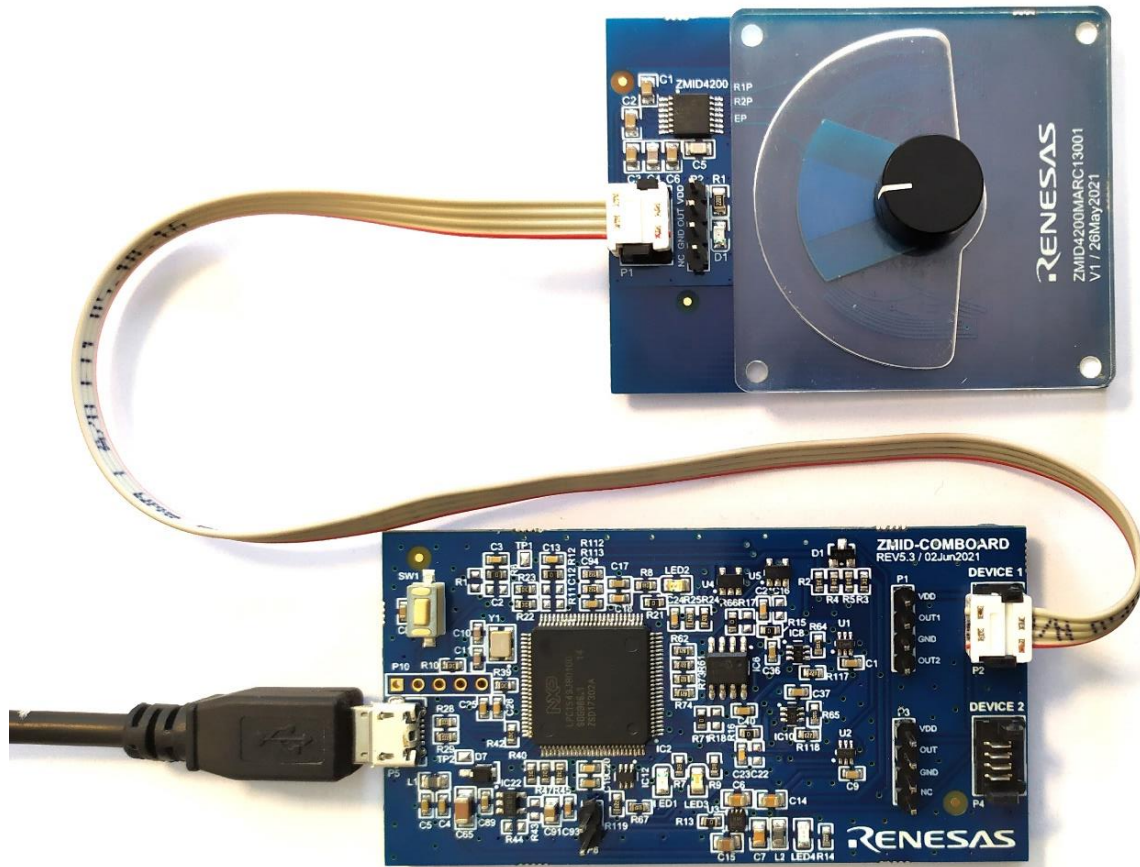

Figure 2. ZMID4200 Evaluation Kit Connections – ZMID4200 Arc Application Module Example

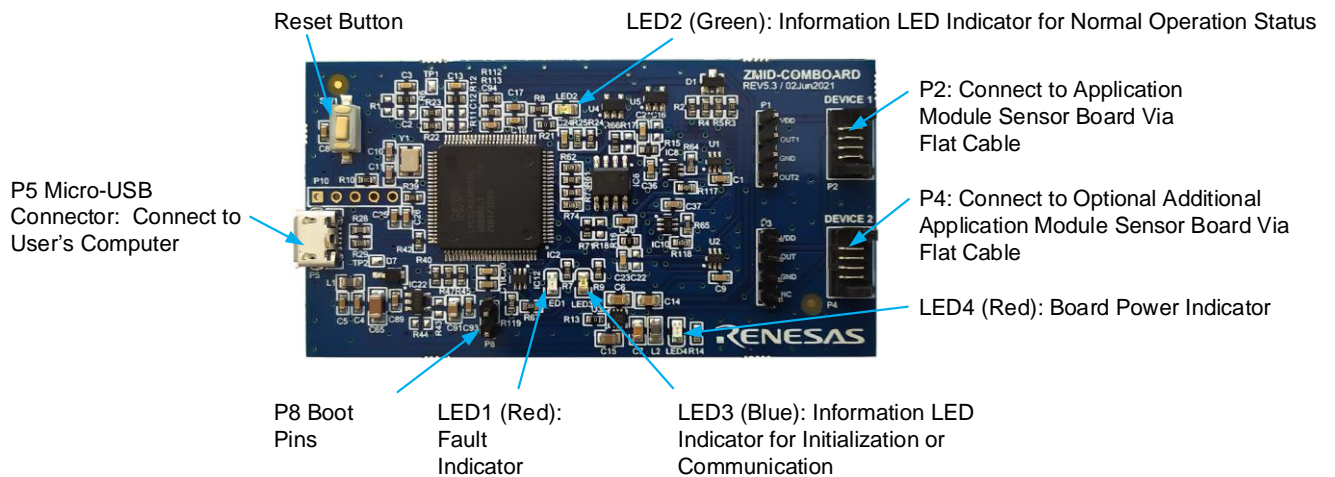

Figure 3. ZMID-COMBOARD – Overview

**Table 1. ZMID-COMMBOARD Key Components and Connector Descriptions**

Note: See Figure 3 for the components referenced in this table.

Label	Description
P2	Connector to the ZMID4200 Application Module Sensor Board. Note: The same signals are on the adjacent 4-pin header P1, which has silkscreen labels for the pin signals: NC (no connection), GND, OUT, and VDD.
P4	Alternative connection for the ZMID4200 Application Module Sensor Board instead of P2 or for an optional connection for a second Application Module Sensor Board. If connecting to two modules at the same time, the ZMID4200 ICs on the modules must have the same output option (e.g., 2 xAnalog outputs). Note that the same signals are available on the adjacent 4-pin header P3, which has labels for the pin signals: NC (no connection), GND, OUT, and VDD.
P5	USB connector to the host PC.
P8	Boot pins.
Reset	Reset board button.
LED1 (Red)	Fault indicator LED: ON indicates an error.
LED2 (Green)	Information LED: ON indicates normal operational status.
LED3 (Blue)	Information LED: ON indicates initialization/communication.
LED4 (Red)	Board power indicator.

Figure 4, Figure 5, and Figure 6 give an overview of the different ZMID4200 Application Module Sensor Boards before installation of the target holder for each type of board. The three boards have the same connectors and components given in Table 2 and identified in the figures.

**Table 2. ZMID4200 Application Module: Key Components and Connector Descriptions**

Label	Description
P1	4-pin Molex Picoflex header for cable to the ZMID-COMBOARD.
P2	PCB 4-pin header for de-bugging purposes. If the user's microcontroller is used instead of the ZMID-COMBOARD, P2 can be used to connect the microcontroller to the Application Module.
D1	Power Indicator LED for the VDD.

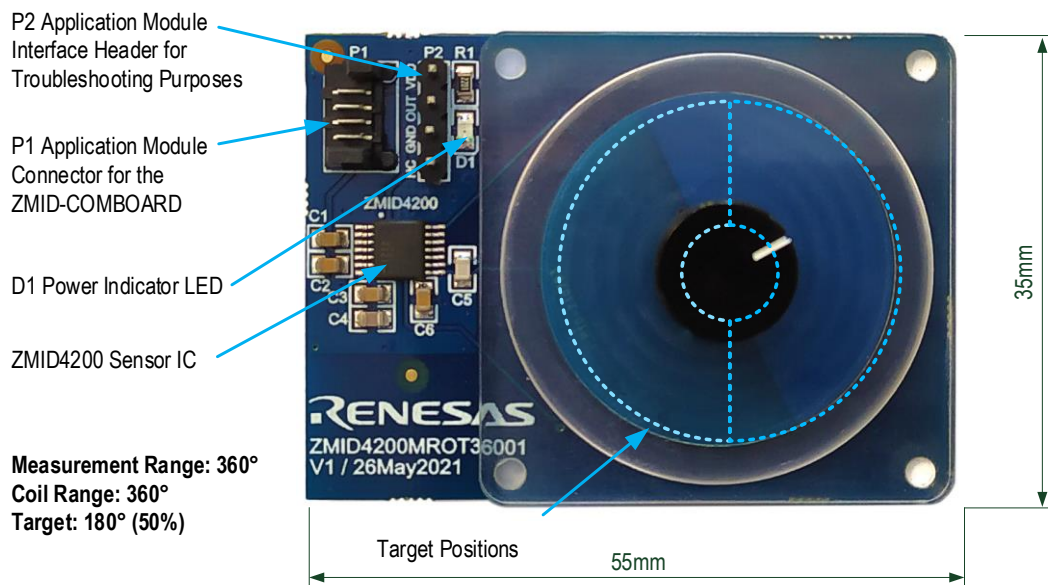

**Figure 4. ZMID4200 Rotary 360° Application Module – Overview**

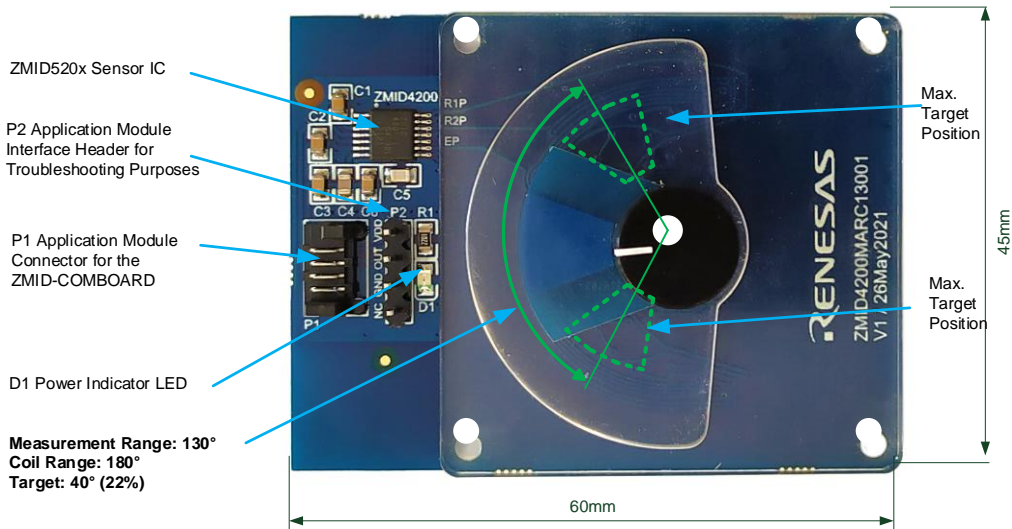

Figure 5. ZMID4200 Arc 130° Application Module – Overview

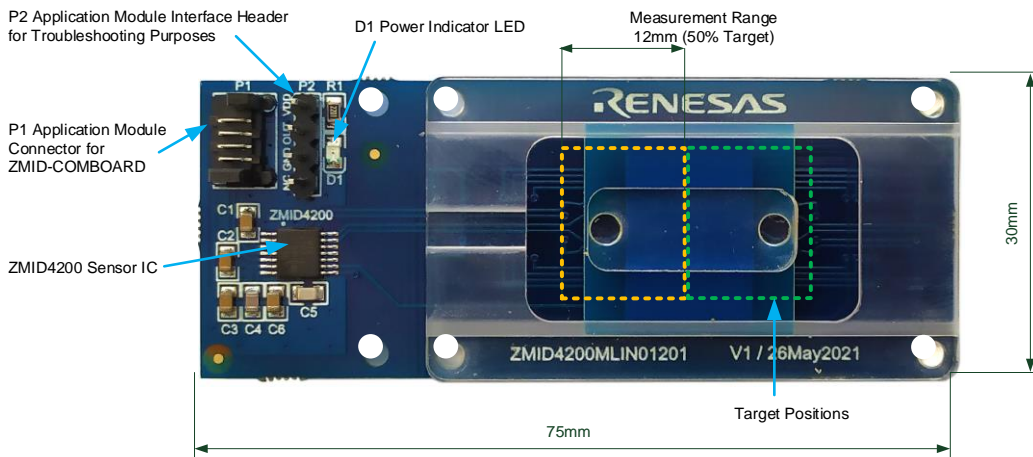

Figure 6. ZMID4200 Linear Application Module – Overview

### 1.4.1. Connecting the Kit



**Important Equipment Warning:** Ensure the correct connection of all cables. Supplying the board using the wrong polarity could result in damage to the board and/or the equipment.

1. Ensure that the ZMID-COMBOARD is not connected to the computer.
2. Assemble the ZMID4200 Application Module with the target holder as described in the user manual for the specific application module.
3. Connect the ZMID4200 Application Module via the flat cable to the ZMID-COMBOARD as shown in the example for the ZMID4200 Arc Application Module in Figure 2. See Figure 1 for the connections for the ZMID4200 Linear Application Module and ZMID4200 Rotary Application Module.
4. Connect the ZMID-COMBOARD to the computer using the micro-USB cable provided in the ZMID-COMBOARD. Power is provided from the computer via the USB connection. No external power source is required.
5. The indicator LED2 on the ZMID-COMBOARD will light (see Figure 3) if conditions are normal. This indicates that the board is ready to communicate with the *ZMID4200 EVKIT Application Software*. The D1 LED on the *ZMID4200 Application Module* (see Figure 4, Figure 5, or Figure 6) also lights when the board is powered on.



## 2. ZMID4200 EVKIT Application Software User Guide

### 2.1 Sections of the Display

The ZMID4200 EVKIT Application Software provides a graphic user interface (GUI) for communicating with the kit. The GUI is displayed when the application is started. Figure 7 identifies the various sections of the display.

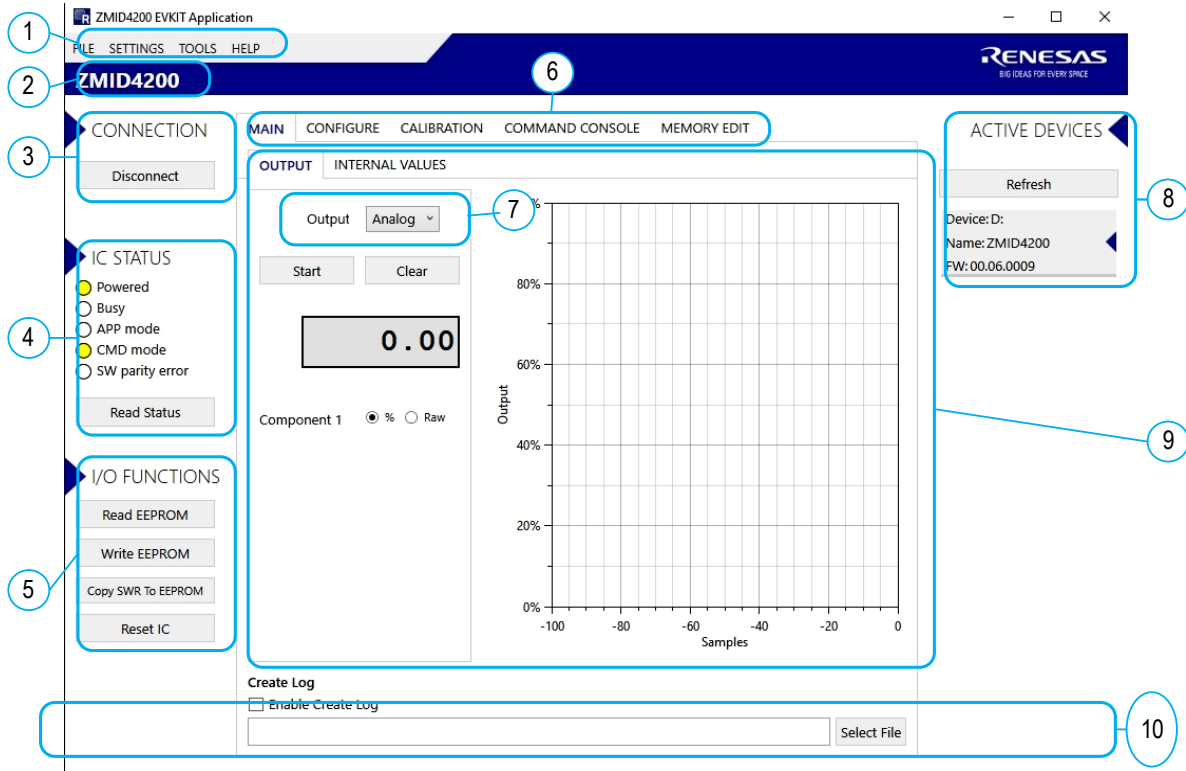

Figure 7. Sections of the GUI Display – Example ZMID4200

- |   |   |
|---|---|
| <p>1 Menu bar: Contains settings and tools.</p> <p>2 Information label: Displays the name of the connected device.</p> <p>3 “CONNECTION” section: Displays connection-related options.</p> <p>4 “IC STATUS” section: Displays status information from the connected device.</p> <p>5 “I/O FUNCTIONS” section: Displays options to perform READ and WRITE actions on the connected device.</p> | <p>6 Navigation tabs: Used to switch between the different main window tabs.</p> <p>7 The output of the sensor can be programmed, Analog , PWM or SENT</p> <p>8 “ACTIVE DEVICES” section: Displays a list of the currently connected communication boards.</p> <p>9 Main window area: Displays options and information about the connected device.</p> <p>10 Status bar: Displays status messages during operation.</p> |
|---|---|

## 2.2 Getting Started

The following steps describe how to establish a connection to the ZMID4200 Application Module and perform measurements. The combination of a ZMID-COMBOARD and its connected ZMID4200 Application Module is referred to as the “device” in the GUI.

### 2.2.1. Connecting to a Device

1. Ensure that the ZMID4200 Application Module is properly connected to the ZMID-COMBOARD. See section 1.4.1.
2. Connect the ZMID-COMBOARD to the user’s computer using the micro-USB cable provided in the kit.
3. Start the GUI application. See Figure 8 for the start-up screen.
4. The device will appear in the “Active Devices” section. If there are no other devices on the list, it will be automatically selected; otherwise select it by clicking on it.
5. If the device shows as unknown, manually identify the device first. For a description of how to manually identify a device, refer to section 2.6.
6. Click on the “Connect” button to initialize the connection.
7. After a successful connection, the GUI will display the contents of the main window area.
8. Two sensor boards can also be connected to the ZMID-COMBOARD at the same time; see Figure 10 for an example. Data are displayed according to the selection made through the drop-down menu on the top left side (Module 1 or Module 2). When connecting to two modules at the same time, both ZMID4200 ICs on the modules must have the same output option (e.g., 2 x Analog outputs).

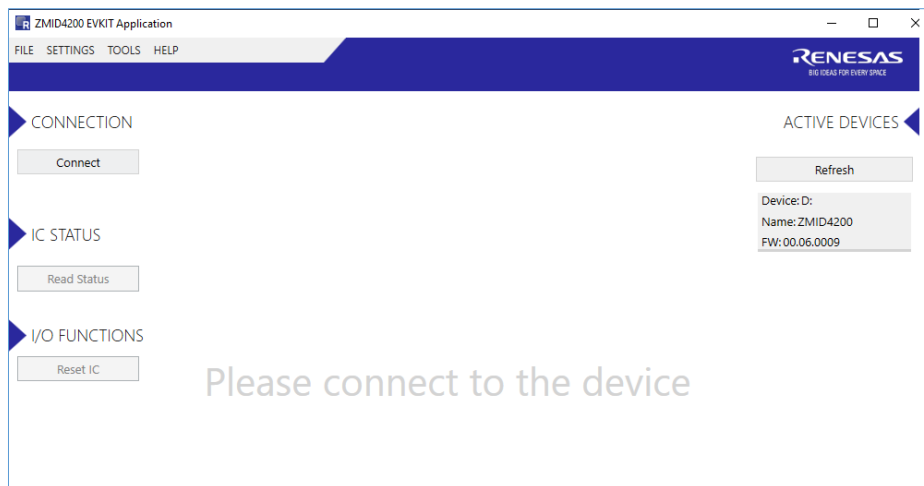

Figure 8. Start-up Screen

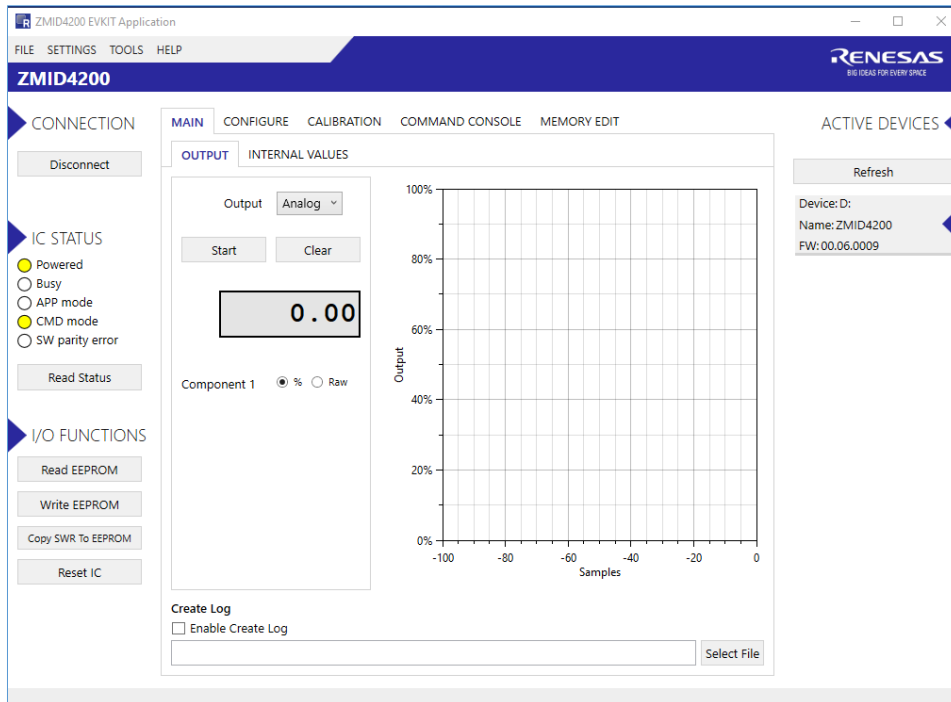

Figure 9. Display When Connected to a Device

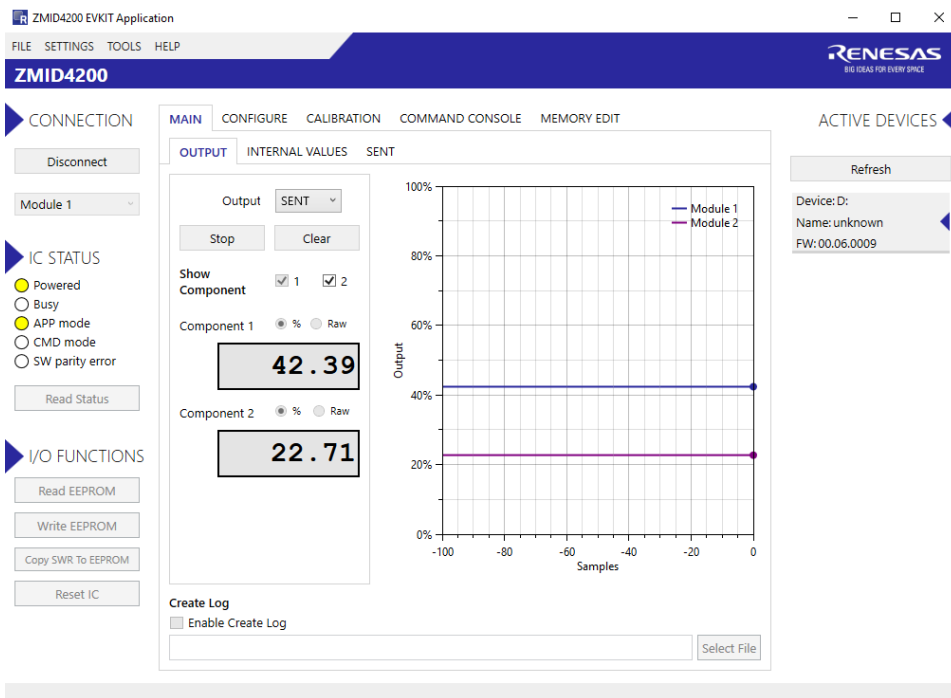

Figure 10. Display When Connected to 2 Devices – ZMID4200 Example

## 2.2.2. Reading Measurements

1. After connecting to a device, select the "MAIN" tab from the navigation menu. Two sub-tabs "OUTPUT" and "INTERNAL VALUES" are displayed. For the ZMID4200, the "SENT" sub-tab is also displayed and provides a SENT interface decoder. The "OUTPUT" tab displays the reading at the ZMID4200 output pin SOUT.
2. The readings can be displayed as scaled values in percent or as raw (decimal/hexadecimal) values. Use the "Component 1" radio buttons ("% or "Raw") to select the desired method for presenting the values. If there

are two devices, repeat the selection for the second device using the “Component 2” radio buttons. The “OUTPUT” tab readings in percent represent:

- Analog values– Percent of VDD
- PWM values– Duty cycle of the signal
- SENT values– Percent of the maximum position SENT value (4095)

The “OUTPUT” tab readings in raw data represent:

- Analog values –12-bit value from the ZMID COMBOARD’s ADC with VDD for reference voltage
  - PWM values –12-bit value from the duty cycle calculation
  - SENT values – 12-bit position value decoded from the SENT stream
3. Clicking the “Start” button will activate the measurements and change this button to the “Stop” button. The GUI disables some of its buttons and options while the measurement is active. Clicking the “Stop” button will deactivate the measurement and reactivate all options and buttons again.
  4. At the bottom of each measurement tab, the “Enable Create Log” check box can be checked to log the measured values into a \*.csv file. The filename and its location are specified with the “Select File” entry field.

The “OUTPUT” tab displays the physical values by using either the ADC or digital inputs of the ZMID-COMBOARD. Figure 11 shows an example of Analog Output. For the PWM or Analog interface, the values are captured using an analog-to-digital conversion by the microcontroller located on the ZMID-COMBOARD. Hence, the accuracy of the measured values is limited due to the setup. The ZMID Evaluation Kit is a configuration tool – it is not intended to act as a measurement device.



Figure 11. “OUTPUT” Tab – Analog Output Example

The “INTERNAL VALUES” tab displays measurements that are only accessible via OWI (see Figure 12). Therefore, all the readings are digital register contents and not limited in terms of hardware accuracy.



Figure 12. “INTERNAL VALUES” Tab – Analog Output Example

There are three controls that can be used to view and change settings on the device:

- **AGC Mode:** Gain and integration time control – used to enable or disable the Automatic Gain Control (AGC) and the Integration Time Control of the device. The following standard options are available in the drop-down menu:
  - Gain adaptation and integration time adaptation off
  - Gain adaptation and integration time adaptation on

Two additional options are available for the AGC Mode that are for advanced testing only. Note: Before using either of these options, contact Renesas support (see the last page for the contact information).

  - Gain adaptation off and integration time adaptation on
  - Gain adaptation on and integration time adaptation off
- **AGC Gain Stage.** Depending on the AGC Mode, this control has different behaviors:
  - When the AGC is active (“Gain and integration time adaptation” is on), the value in the “ACG Gain Stage” entry field specifies the maximum gain for gain regulation. During measurements, the box becomes read-only and displays the existing gain stage setting that the ZMID4200 is using.
  - When the AGC is disabled (“Gain and integration time adaptation” is off), the value in the input field specifies the selected gain stage.
- **Over Sampling Rate (OSR).** This parameter defines the number of averaging samples per receiving channel and reduces the noise level on the signal.

The “SENT” tab is only available when the ZMID4200 Application Module is set to SENT output and connected to the ZMID-COMBOARD. It displays the decoded SENT data information as shown in Figure 13.

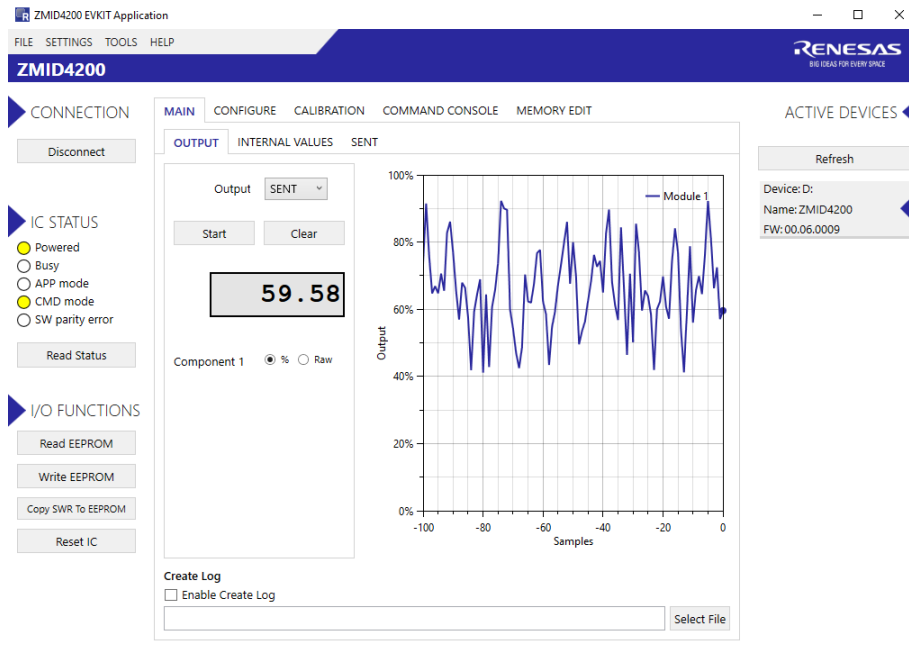

Figure 13. “SENT” Tab.

### 2.3 Changing the Configuration Settings

The “CONFIGURE” tab (see Figure 14) is designed to provide the user with an easy way of viewing and editing the IC configuration. Each value represents a register or a part of a register from the internal memory of the device. The displayed memory type can be either the ZMID4200 EEPROM or the SWR memory. SWR refers to shadow registers used as the working memory for the ZMID4200, which can be temporarily written via the GUI to the ZMID4200 for development purposes.

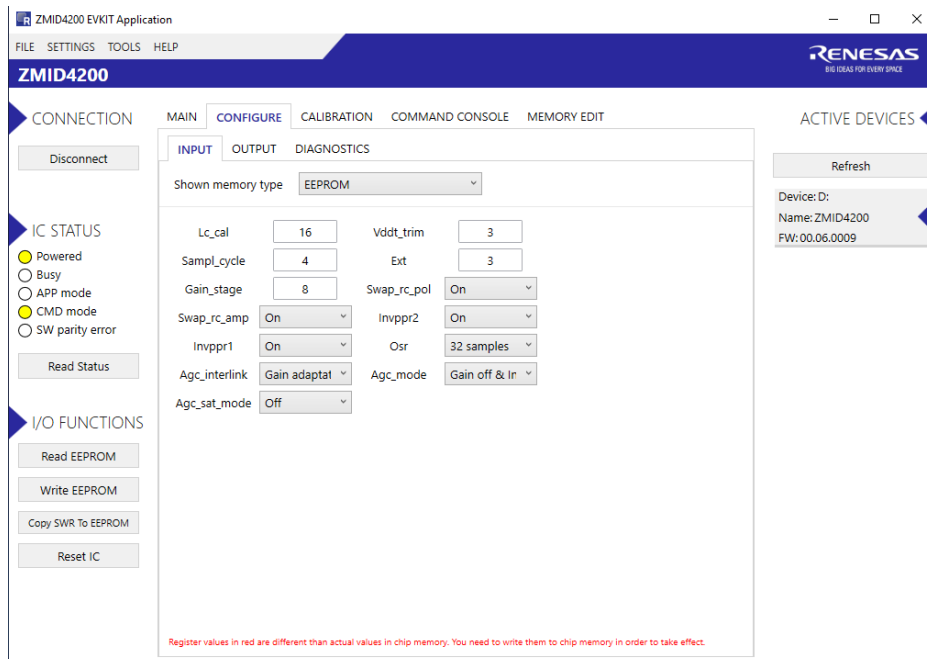

Figure 14. "CONFIGURE" Tab – Selection of Memory Type to be Displayed

If parameters in the EEPROM memory selection have been changed, the ZMID4200 must be reset after the writing process is finished for the changes to take effect. This is done automatically after pressing the “Write EEPROM” button in the “I/O FUNCTIONS” section (see Figure 15). This can be disabled via the “SETTINGS” menu > “Reset on Memory Write.” In the case of the SWR selection, by default, changes are immediately written

to the SWR memory of the ZMID4200. This option can be disabled via the “SETTINGS” menu > “Enable Automatic SWR Write” (see Figure 16). Clicking the “Write SWR to EEPROM” button in the “I/O FUNCTIONS” section copies all of the current SWR settings to the EEPROM memory of the device. This section also provides the “Reset IC” button for manually resetting the ZMID4200. The reset power cycles the device and puts it in Command Mode. After reset, the contents of the EEPROM of the device are copied to its working memory SWR.



Figure 15. Buttons in the “I/O FUNCTIONS” Section

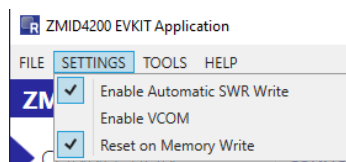

Figure 16. Options on the “SETTINGS” Menu

There are three different data types shown on the “CONFIGURE” tab:

1. Numerical values are displayed in a white field (see Figure 17). If they are hexadecimal, “0x” is automatically inserted at the beginning of the value.
2. Values with predefined multiple choices are displayed in a drop-down menu (see Figure 18).
3. Read-only values are displayed with a light blue background. They can only be selected and copied (see Figure 19).



Figure 17. Example of Numerical Values That Can be Edited

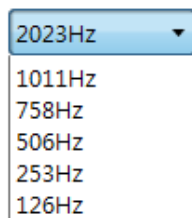

Figure 18. Example of a Drop-Down Menu with Multiple Choice Values

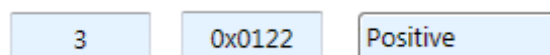

Figure 19. Example of Read-Only Values

Changing a value will change the font color to red (see Figure 20). This indicates that the change has not yet been applied to the actual memory (EEPROM or SWR) of the IC. To apply the change, click the corresponding “Write...” button in the “I/O FUNCTIONS” section. If the “Reset IC” or one of the “Read” buttons is pressed, the values will be set to represent the current settings of the device.



Figure 20. Example of a Modified Value that is Not Yet Saved to Memory

Context-sensitive pop-ups (see Figure 21), referred to as “tooltips,” provide additional information that appears briefly as the cursor hovers over an element on the screen. The tooltips for entry fields include a brief description of the setting and the address of the internal memory register.

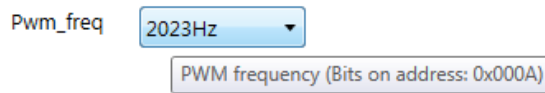

Figure 21. Example of Tooltip Information

## 2.4 Calibration

There are three sub-tabs under the “CALIBRATION” tab: COIL OFFSET, OUTPUT RANGE, and CALIBRATION AND LINEARIZATION.

### 2.4.1. “COIL OFFSET” Sub-tab

The “COIL OFFSET” sub-tab is located under the “CALIBRATION” tab (see Figure 22). It is used to compensate the offset of the signal acquired from coils R1 and R2 connected to the ZMID4200.



Figure 22. “COIL OFFSET” Tab – ZMID4200 Example

For each of the coils, the following are displayed:

1. R1 Offset – Offset applied to the signal from the R1 coil.
2. R2 Offset – Offset applied to the signal from the R2 coil.



The GUI automatically determines which of the coils is the sine and cosine signal based on the current configuration settings. The two signals are color coded in red and green. When the “Read” button is pressed, the current sine and cosine and their maximal and minimal values are displayed next to the graph.

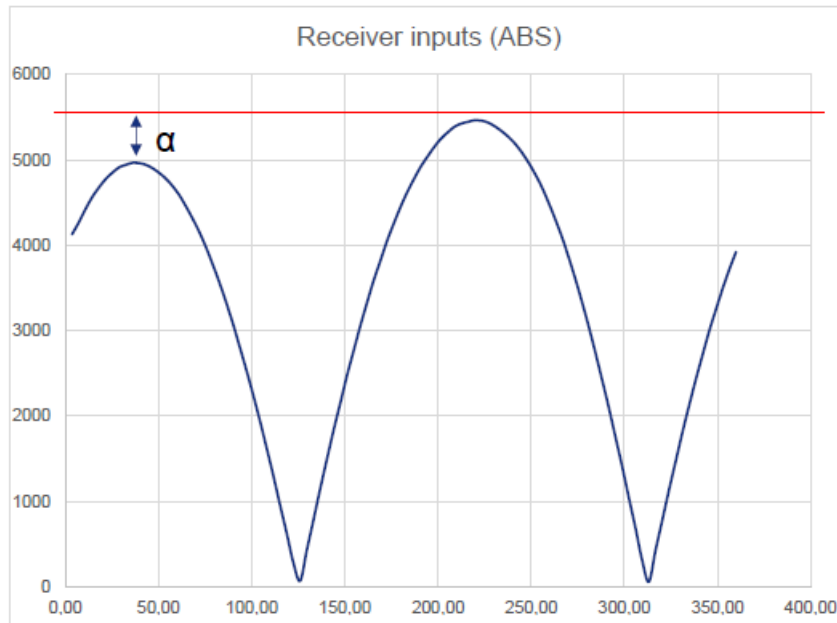

Figure 23. Receiver Coil (ABS Value) Offset Example with Offset Compensation =  $\alpha/2$

To start the automatic calibration for amplitude offset, click the “Start Offset Compensation” button. The GUI will guide the user through a sequence of instructions for performing the calibration procedure.

1. Remove the target from the coil, and press “Ok.”
2. Wait for a few seconds for the GUI to measure the offset. It will automatically continue to the next step.
3. Values for the Offset will be updated (see Figure 24).
4. Use the “Write EEPROM” button from the “I/O FUNCTIONS” section to save the new values to the EEPROM.

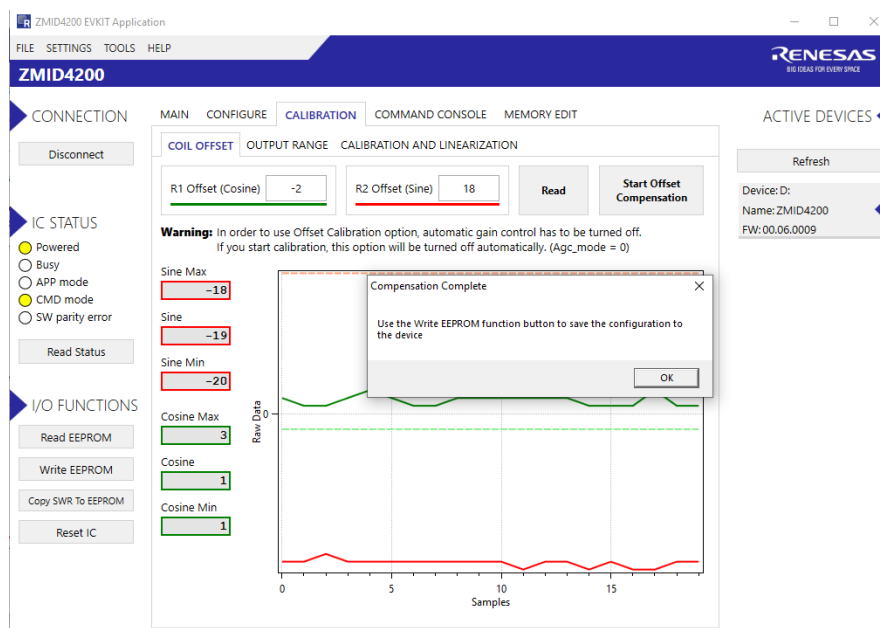

Figure 24. Coil Offset Calibration Completed – ZMID4200 Example

## 2.4.2. “OUTPUT RANGE” Sub-tab

The “OUTPUT RANGE” sub-tab (see Figure 25) is used to configure the output behavior of the ZMID4200. For a detailed description of output settings, refer to the *ZMID4200 Datasheet*.

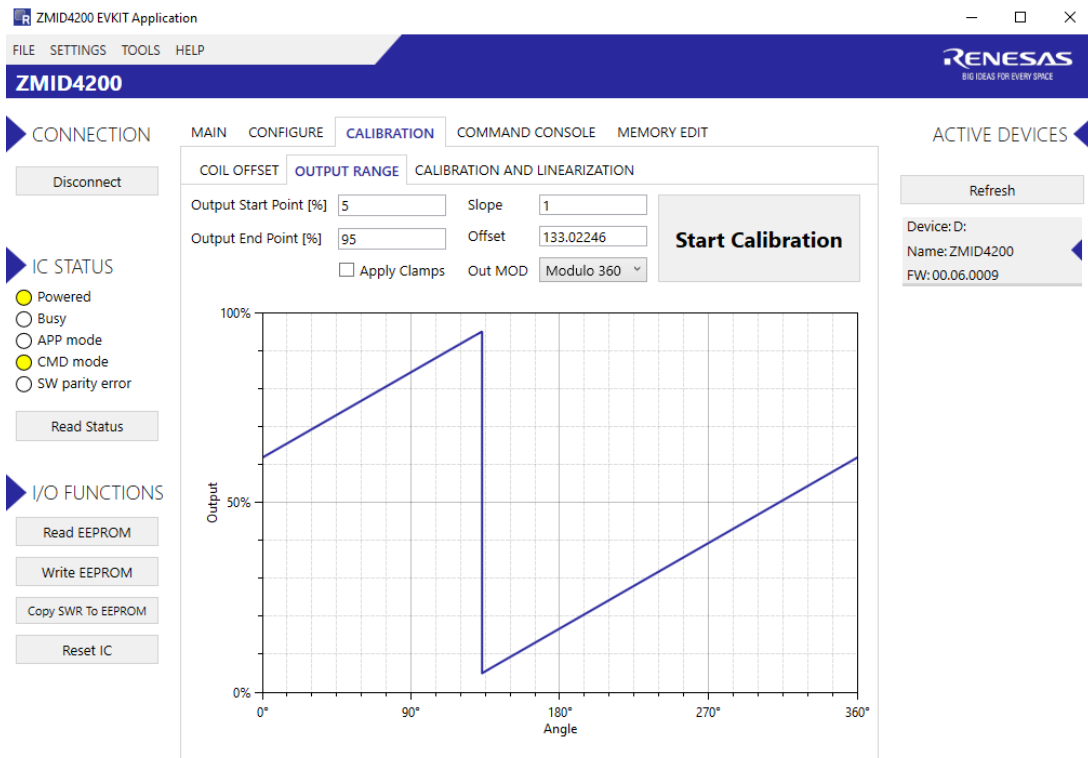

Figure 25. “OUTPUT RANGE” Tab – ZMID4200 Example

There are four values that can be edited on the “OUTPUT RANGE” sub-tab for subsequent use during the calibration procedure:

- The “Output Start Point [%]” field defines the desired output value when the target is at the mechanical start point.
- The “Output End Point [%]” field defines the desired output value when the target is at the mechanical end point.
- The “Apply Clamps” checkbox is available only for the Analog or PWM interfaces. If activated, the output is clamped between the specified start and end points if the target goes beyond these mechanical positions. Due to the low resolution of the clamps register, the available clamping values might not match the selected output start and end points exactly. See Figure 28 and Figure 29 for examples of the output without clamping and the output with clamping, respectively.
- Out MOD: Defines the output mode.
  - Linear: The Linear Output Mode is a non-repeating output mode in which the sensor output signal is clamped at the mechanical end points (see Figure 26).
  - Modulo 360: The Modulo Output (saw tooth output) Mode is a repeating output mode in which the sensor output signal is not clamped at the mechanical end points, but it is switched back to its origin (see Figure 27).

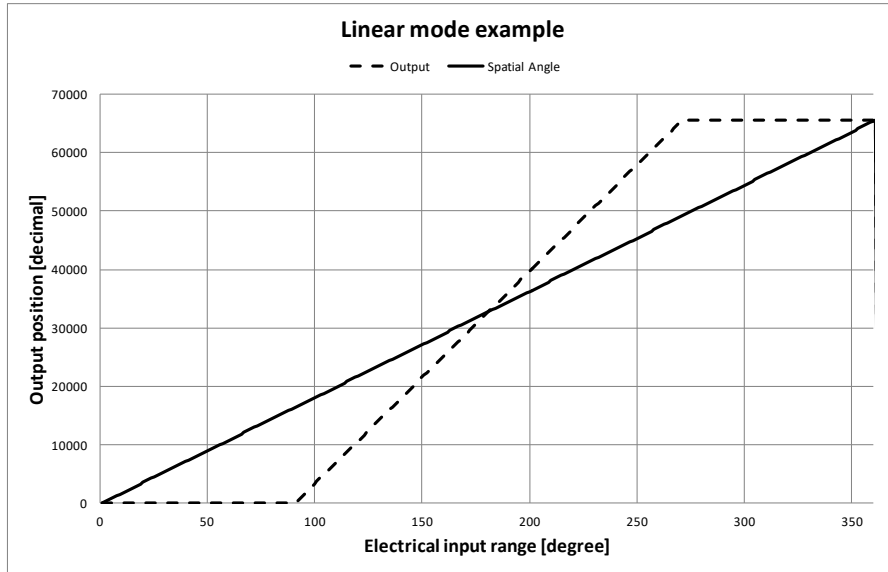

Figure 26. Linear Output Mode Example with Slope = 2, Offset = 90°

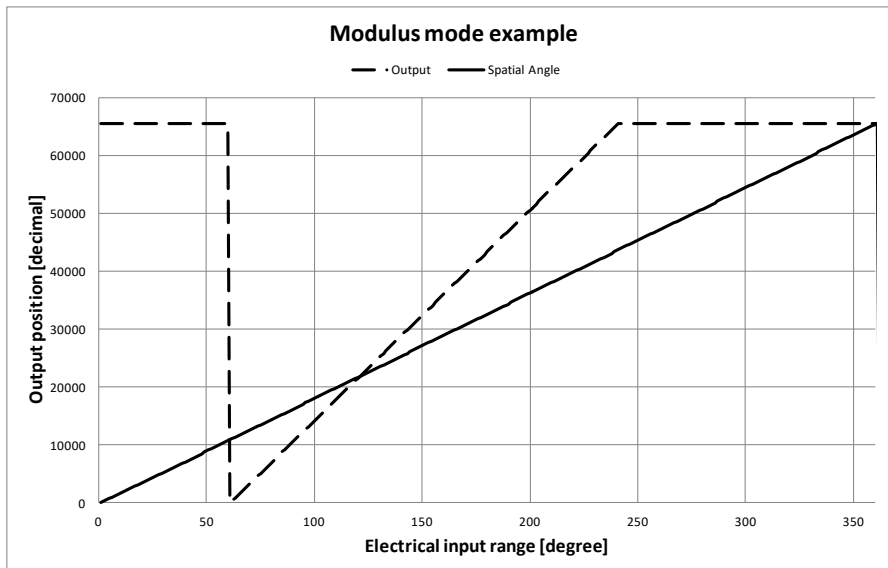

Figure 27. Modulus Output Example with Slope = 2, Offset = 60°

The results from the calibration procedure are displayed in two fields on the “OUTPUT RANGE” tab. They are direct representations of the *Offset* and *Slope* registers in the ZMID4200. The values can also be manually entered by the user.

- Slope: The slope of the transfer function of the output signal.
- Offset: The zero-offset of the output signal referenced to the mechanical position in degrees.

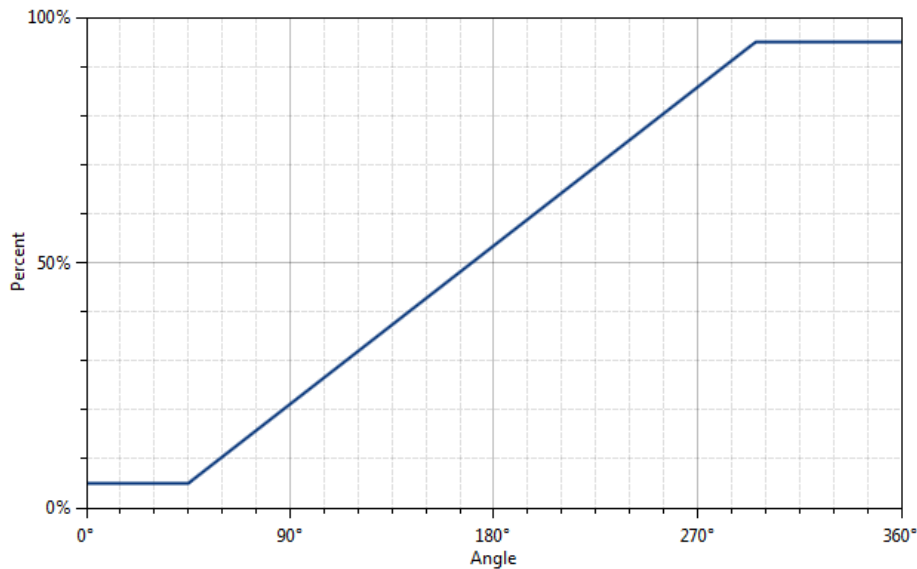

Figure 28. Output without Clamping

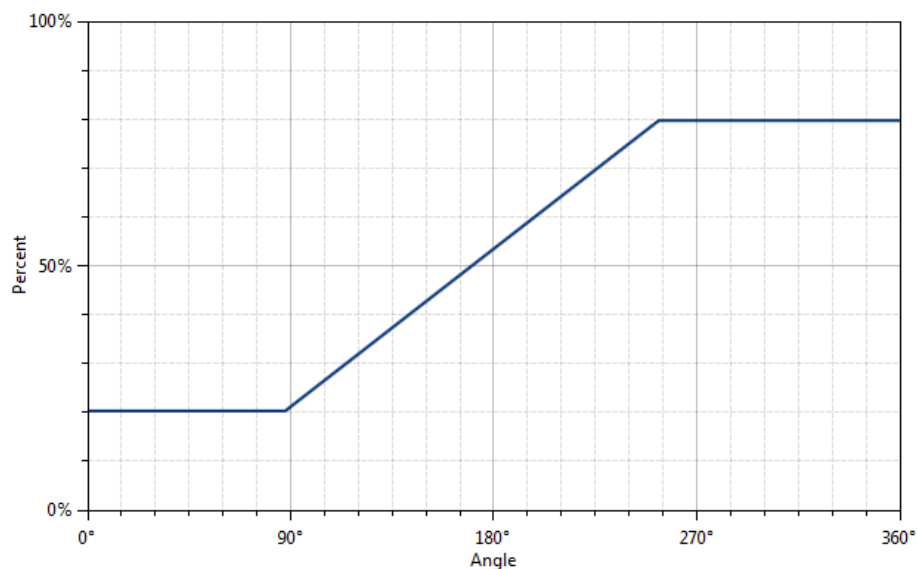

Figure 29. Output Clamped from 20% to 80%

Automatic Output Calibration Procedure:

To start the automatic calibration, click the “Start Calibration” button. The GUI will guide the user through a sequence of instructions for performing the calibration procedure.

1. Move the sensing target to the start position, and click “OK” in the dialog box. The graph will start displaying the internal reading of the position.
2. Move the sensing target to the end position, and click OK. The GUI will automatically attempt to determine if the slope polarity of the values is positive (values ascending) or negative (values descending). If this cannot be determined, the GUI will ask the user to specify the polarity of the slope. For the example provided in Figure 30, the slope is negative.

3. Based on the acquired data, the GUI will attempt to calculate the best values for the *Slope*, *Offset*, and *Clamps* registers. If the calibration is not possible with the currently selected “Out MOD” setting, the GUI will ask the user to change to the other setting (see Figure 31). The calculated values will be prepared to be written to the memory, and the user will be directed to use the “Write EEPROM” button in the “I/O FUNCTIONS” section to write the new coefficients to the memory of the device. See Figure 32.
4. If the calculated values are out of range or the calibration is not possible, a message will inform the user which value is affected. The most common cause of unsuccessful calibration is setting the start and end target positions too close to each other since this could require a slope value larger than the valid range of slope values. See Figure 33.
5. A detailed log from the calibration function is available from the “TOOLS” menu > “Open Log File” > “Calibration.”

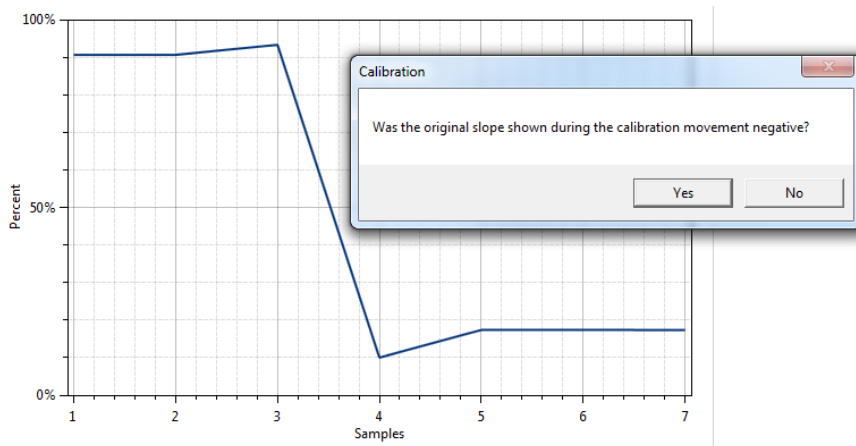

Figure 30. Specify the Original Slope

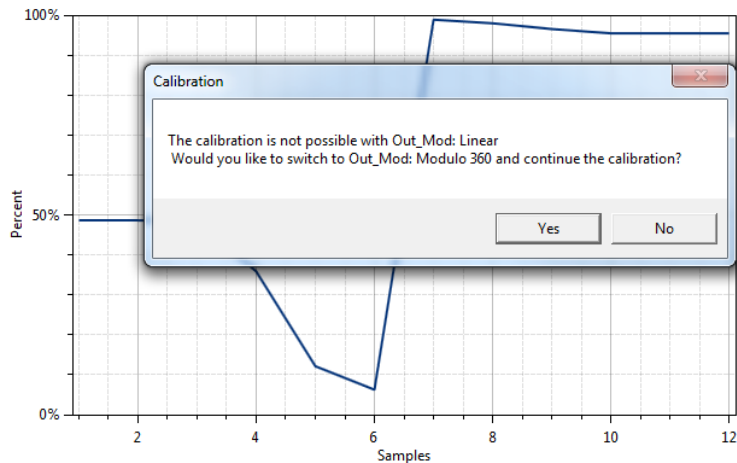

Figure 31. Request for Changing the Out\_Mod Setting

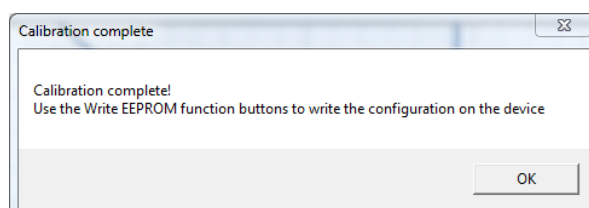

Figure 32. Successful Calibration Message

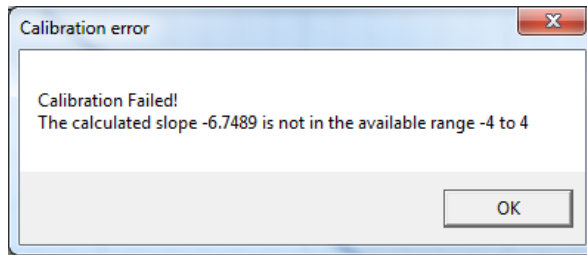

Figure 33. Unsuccessful Calibration Message

### 2.4.3. “CALIBRATION AND LINEARIZATION” Tab

The “CALIBRATION AND LINEARIZATION” tab contains two sub-tabs. The “AUTO CAL” sub-tab is used to perform the full output range calibration and linearization on a device by importing a .csv file with position measurements. The “MANUAL LINEARIZATION” sub-tab can be used to manually calculate the linearization register values for given target positions.

#### 2.4.3.1. “AUTO CAL” Sub-tab

The “AUTO CAL” sub-tab is located under the “CALIBRATION AND LINEARIZATION” tab (see Figure 34). It is used to do a full calibration of the ZMID4200 by processing a .csv file with measurement data.

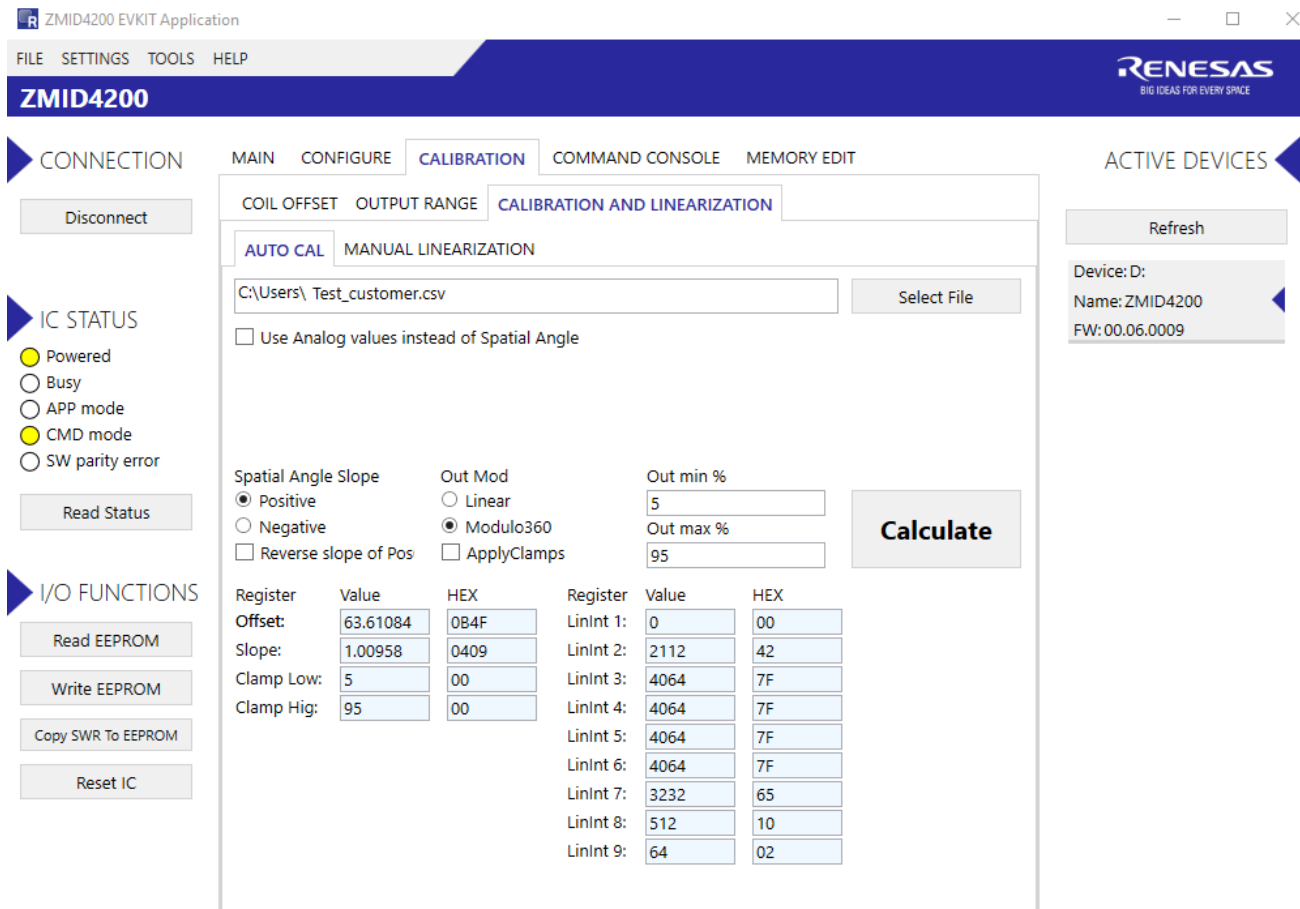

Figure 34. "AUTO CAL" Sub-tab – ZMID4200 Example

The "AUTO CAL" sub-tab has the following input parameters:

- The "Select File" button is used to specify the path to the .csv file with measurement data that will be used for the calibration. By default, the file should contain only raw *Spatial Angle* register readings taken at equal intervals during the whole movement range of the target. The header row in the .csv file is optional. The values are written as 16-bit unsigned integers [0 to 65535].

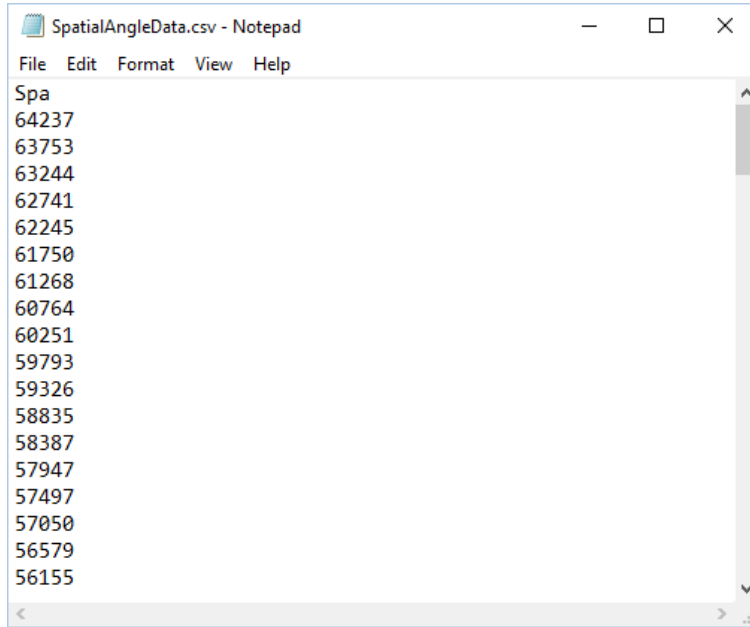

Figure 35. Example Contents of an Input .csv file with Spatial Angle Data

- If the "Use Analog values instead of Spatial Angle" checkbox is selected, the input .csv file must contain only voltage readings from the output of the ZMID4200 taken at equal intervals during the whole movement range of the target. The values are written as positive real numbers in volts.

**Note:** This option is only available for Analog output.

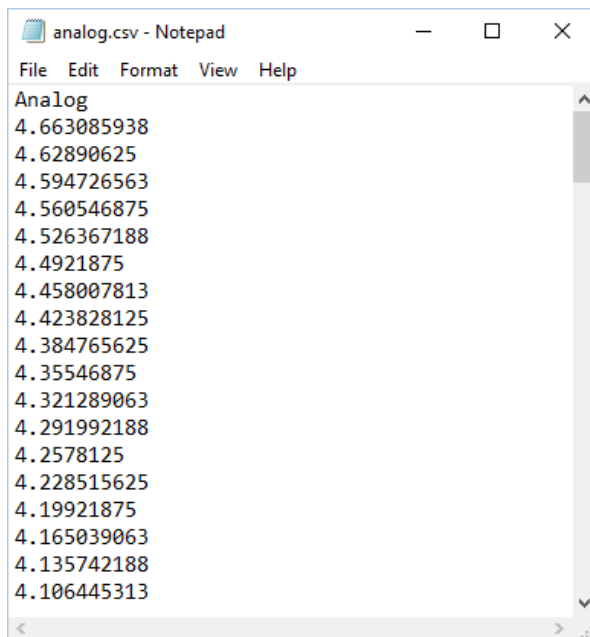

Figure 36. Example Contents of a .csv Input File with Output Voltage Data

- The “VDD [V]” text box is used to specify the measured supply voltage of the ZMID4200 when the .csv data was gathered.  
**Note:** This option is only available for the Analog output.
- The “Write Renesas Output Config” button writes a default configuration to the first 8 registers of the EEPROM to allow the analog measurements of the device to be converted to spatial angle values.  
**Note:** This option is only available for the Analog Output.
- The “Spatial Angle Slope” radio buttons specify the polarity of the slope of the .csv input values. A positive slope means that the .csv input values are increasing; a negative slope means the values are decreasing.
- The “Reverse slope of Pos0” checkbox specifies whether the polarity of the slope of the calibrated values should be the same as the polarity of the *Spatial Angle* slope values or inverted.
- The “Out Mod” radio buttons specify the type of the calibration: Linear or Modulo360.
- The “Apply clamps” checkbox specifies whether the clamp register will be used to set clamp levels on the output that correspond to the minimal and maximal output calibration points.  
**Note:** This option is only available for the Analog or PWM outputs.
- The “Out min” and “Out max” text boxes are the desired output values in percent at the two mechanical movement end points. The minimal value should be less than the maximal value.
- The “Calculate” button calls the *OneStepCalibration.dll* library with the specified input parameters to calculate the calibration coefficients. After a successful calibration, the output fields are populated with the calculated calibration data. The left column shows the values in “human readable” format, and the right column shows the corresponding register data that will be written to the memory of the ZMID4200.
  - Offset: The zero-offset of the output signal referenced to the mechanical position in degrees.
  - Slope: The slope of the transfer function of the output signal.
  - Clamp Low and Clamp High: Actual output clamping levels.
  - LinInt 1 to 9: The correction coefficients at the 9 linear interpolation correction points.

A successful calibration will prepare the new values to be written to the EEPROM memory of the ZMID4200. To write the values, click the “Write EEPROM” button in the “I/O FUNCTIONS” section.

An unsuccessful calibration will only provide an error message.

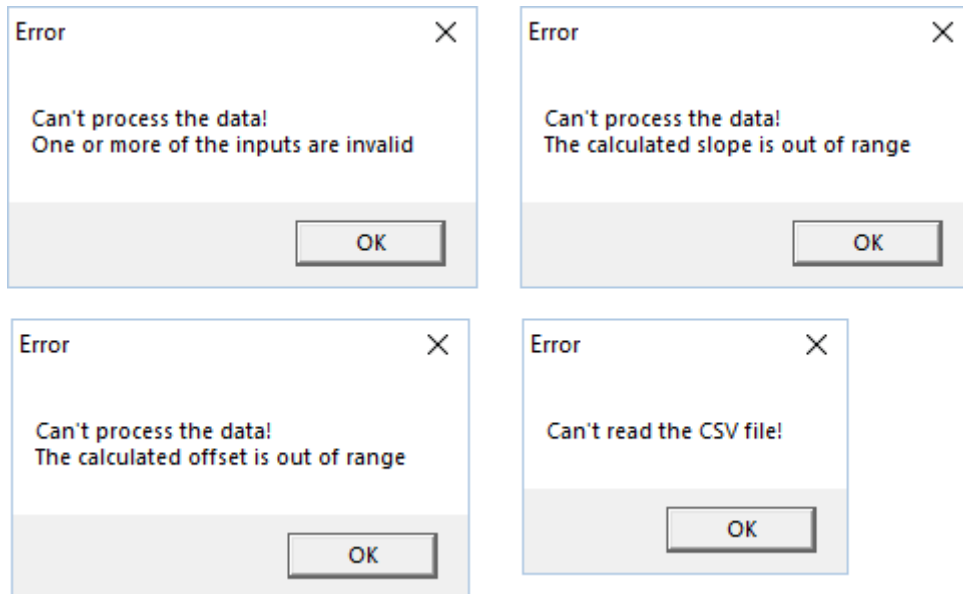

Figure 37. Example of AUTO CAL Error Messages

A detailed report of the calibration can be viewed in the *calibrationLogfile.txt* log file, which is accessible through the *Tools > Open Log File > Calibration* menu.



2.4.3.2. “MANUAL LINEARIZATION” Sub-tab

The table on the “MANUAL LINEARIZATION” tab shows the nine points for which a value can be specified for application to a correction curve over the position range (see Figure 38).

The table has the following rows:

- Correction Point: Constraint points for linearization 1 to 9; below each correction point, the electrical position is shown in the next row (0 to 360 degrees in pre-calibration or 0 to 100% after calibration).
- Ideal Value: The ideal value (read-only) according to the motion range provided.
- Measured Value [mm] or [deg]: Entry field for values measured at the correction points (“mm” is not applicable to the ZMID4200 Rotary 360° Application Module or the ZMID4200 Arc 130° Application Module). These values are entered by the user.
- Correction: These read-only values (integers in the range of -127 to 127) will be added (after a multiplication x 32) to the “Spatial Angle” data if linearization is performed before calibration; in the case of linearization post-calibration, these values will be applied (after a multiplication x 32) to the Position 0 data, resulting in the Position 1 data. See the description of the “Start Reading” button below for an explanation of the “Position 0” and “Position 1” data fields.

Three additional controls are available on this tab.

- Motion Range [mm] or [deg]: Entry field for the linear motion range in mm (not applicable to the ZMID4200 Rotary 360° Application Module and the ZMID4200 Arc 130° Application Module) or the arc/rotation motion range in degrees. This user-selected value is used to calculate the ideal values.
- Correction Mode: This drop-down menu allows selecting whether the linearization is applied before or after calibration.
- Angle Offset: This drop-down menu offers the option to shift the linearization points if required. Whether the offset is applied or not is determined by the non-linearity error distribution. (Refer to the *ZMID4200 Datasheet* for details).

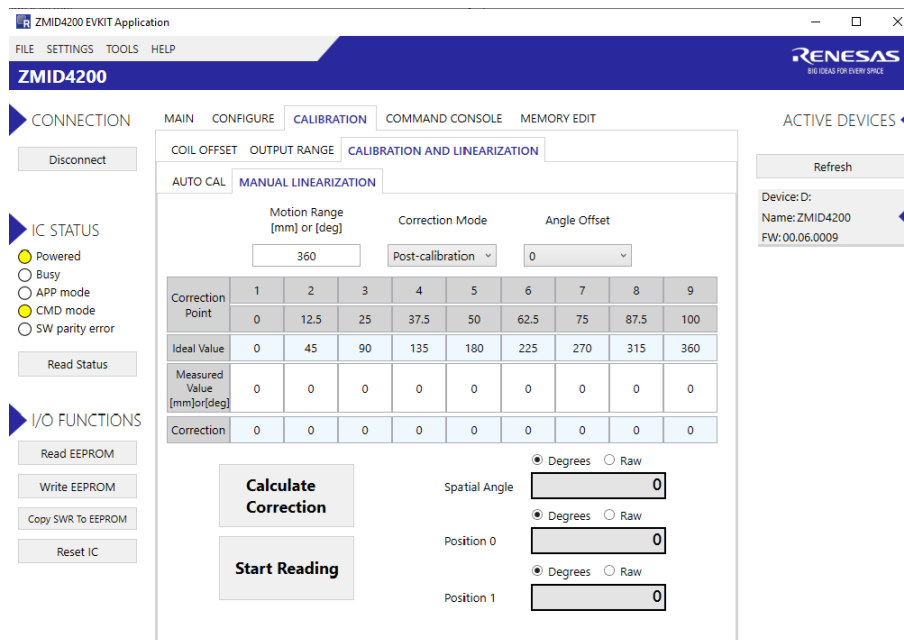
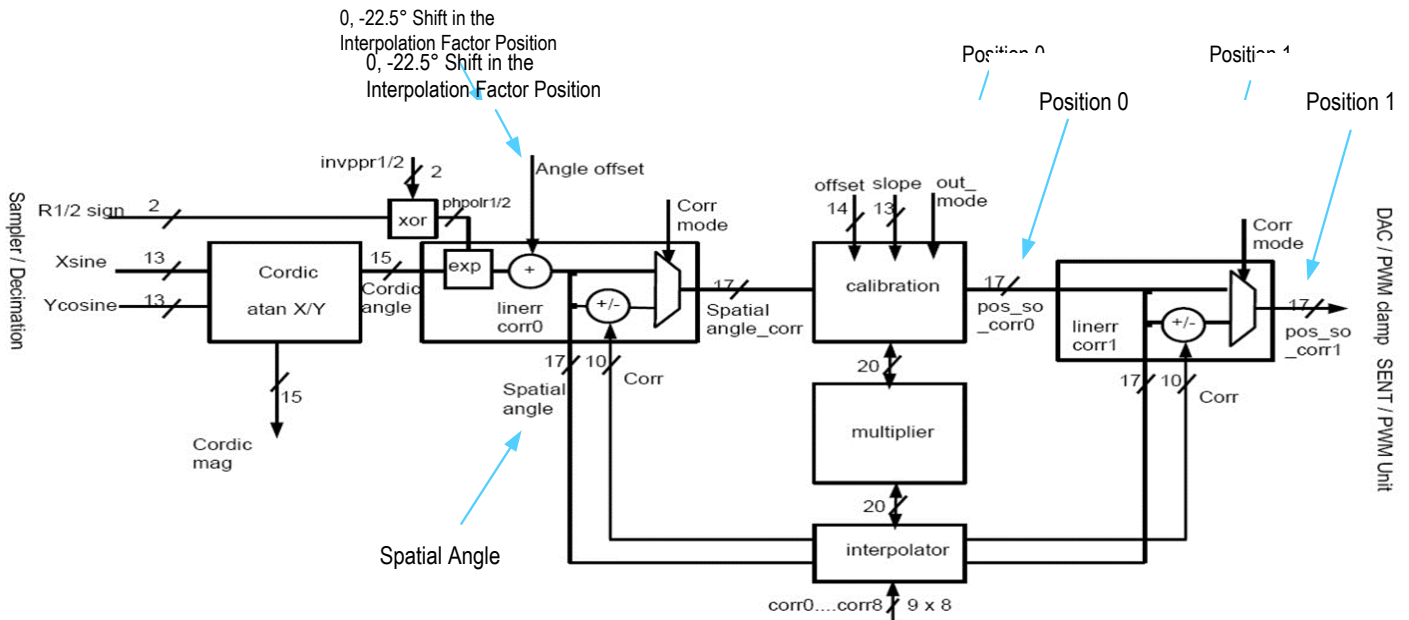

Figure 38. “MANUAL LINEARIZATION” Sub-tab – ZMID4200 Example

- The “Start Reading” button triggers a continuous reading of the three internal position registers of the ZMID4200 (see Figure 38 for the corresponding measurement points in the calibration process). This is implemented to help the user measure the linearization error at the specific points.

- The “Spatial Angle” reading represents the CORDIC output angle before applying the slope and offset calibration. The “Position 0” reading is the position value after applying the slope and offset calibration but before applying the linear interpolation. The “Position 1” reading is the final value after the linear interpolation is applied (see Figure 39)
- The “Calculate Correction” button re-calculates the new correction values for the EEPROM registers based on the “Measured Value” cells.

To save changes to the device, use the corresponding “Write...” button in the “I/O FUNCTIONS” section.



### 2.4.3.3. “MANUAL LINEARIZATION” Tab – Correction Values

Multiple strategies have been developed to obtain the set of correction values. For relevant information and procedures, contact Renesas support. (See the contact information on the last page.)

## 2.5 Working with the Memory

### 2.5.1. “MEMORY EDIT” Tab

Information for all the memory types of the device and their values can be found on the “MEMORY EDIT” tab (see Figure 40). The data is organized in tables, and the register values are in hexadecimal format.

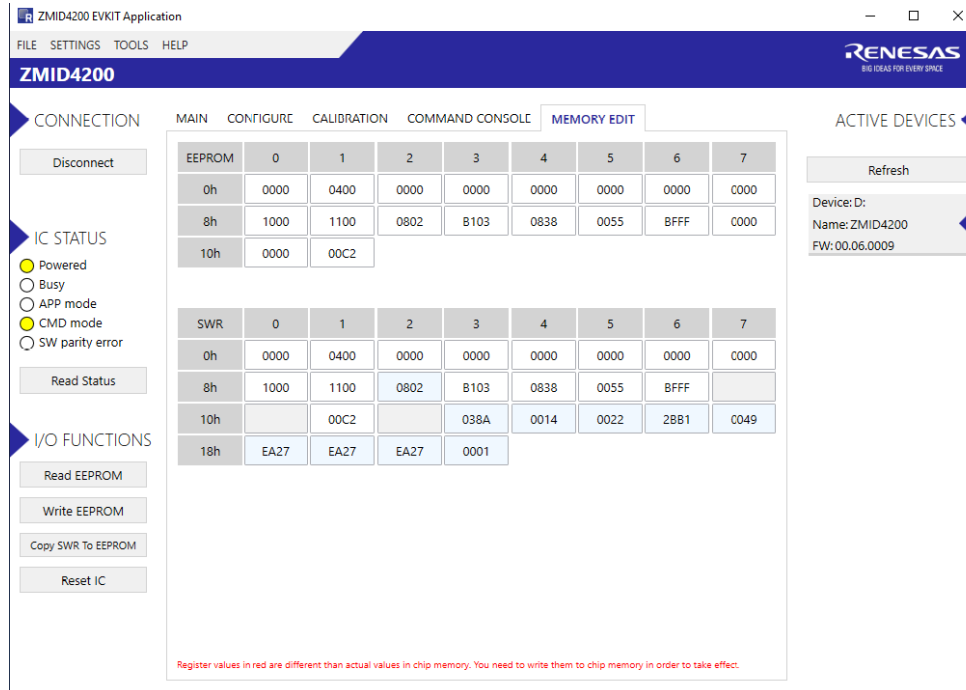

Figure 40. “MEMORY EDIT” Tab Contents – ZMID4200 Example

The read-only registers are marked with a light blue background. Modified register values will appear in red color until they are written to the device memory or re-read from it (see Figure 41).

000	0000	00
	0242	BF
FFE	0FFE	3F

Figure 41. Example of a Modified Value on the “MEMORY EDIT” Tab

Placing the cursor over a table cell displays a tooltip with additional information about the register (see Figure 42).

EEPROM	0	1	2	3	
0h	01EA	1683	0000	0000	00
8h		0000	4803		
10h	0000				

Calibration slope (Address: 0x0001)

Figure 42. Example of “MEMORY EDIT” Tab Tooltip Information

### 2.5.2. Saving and Loading Memory Dump Files

The current memory configuration can be saved to a file via the “FILE” menu > “Save Memory Dump.” This is useful for providing a backup of the verified memory configuration or for copying a configuration to another device (see Figure 43).

The “Load Memory Dump” option loads a selected memory dump file into the “MEMORY EDIT” tab. The “Write EEPROM” button in the “I/O FUNCTIONS” section must be used to write the configuration into the memory of the ZMID4200.

The GUI provides a set of default memory dump files that can be used to easily return a device to its original settings.

The default memory dump files can be found in the “MemoryDumps” folder located in the main installation directory of the GUI.

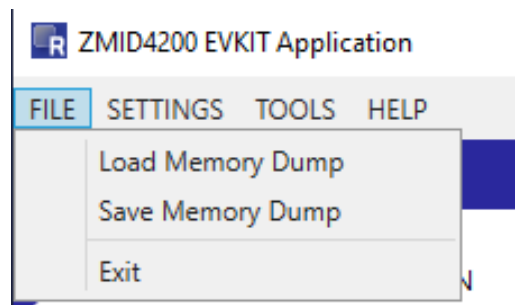

Figure 43. Menu Options for Saving and Loading Memory Dump Files

### 2.5.3. Viewing Memory Dump Files without Connecting to a Device (Offline)

It is possible to load a memory dump file when no device is connected. This allows the user to view and edit the contents of a memory dump file. The “Save Memory Dump” menu option is used to save the changes to the same file or a new file. Since there is no device connected, only the “CONFIGURE” and “MEMORY EDIT” tabs are available (see Figure 44). The values that are different from the default values for the ZMID4200 are displayed in red. Connecting to a device while viewing a memory dump file “offline” will cause the GUI to discard any unsaved changes to the memory dump file and switch to displaying the current settings from the connected device’s memory.

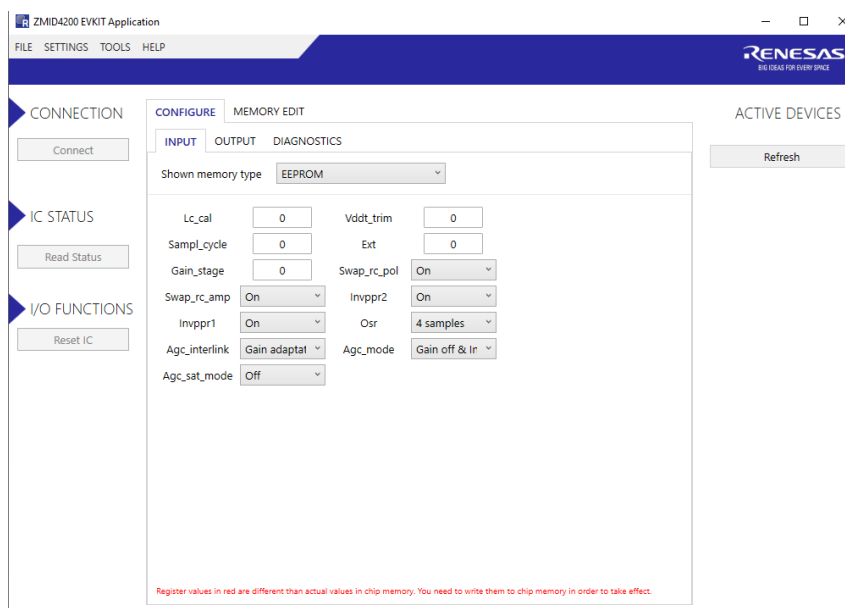

Figure 44. Viewing a Memory Dump File "Offline"

## 2.6 Manually Identifying a Device

When a new device is connected to the computer, the GUI automatically recognizes it. If it is unable to identify the device, the user must manually identify it. There is also a menu option to re-identify a device (see Figure 45).

### 2.6.1. Identifying an Unknown Device

If the GUI is unable to automatically identify the device, it will be displayed as an unknown device in the “ACTIVE DEVICES” section, and the “Connect” button will be replaced by an “Identify Device” button.

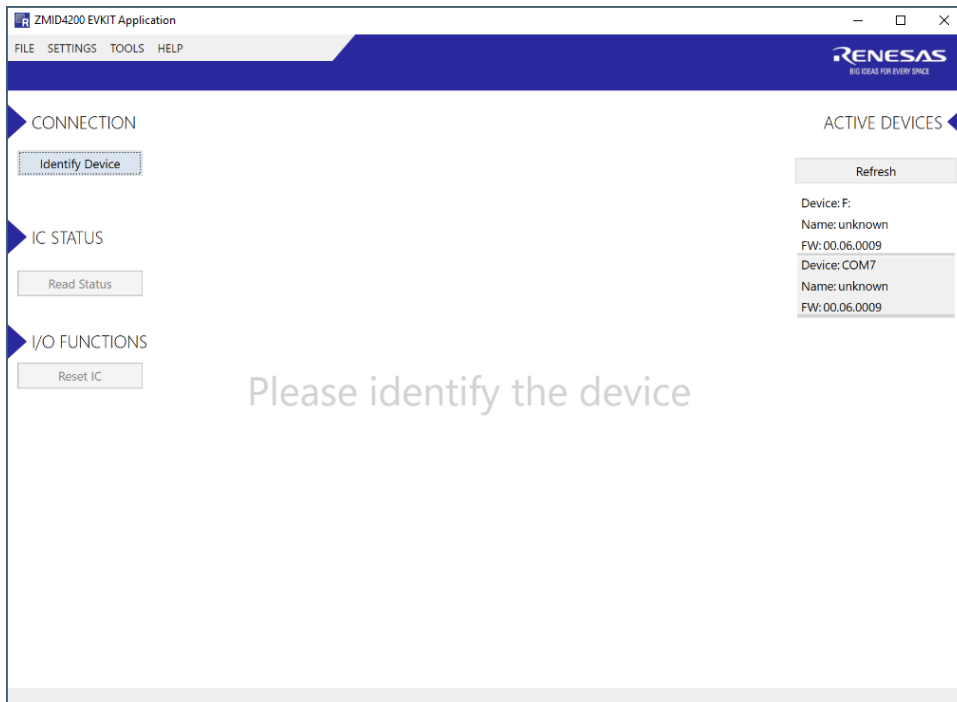
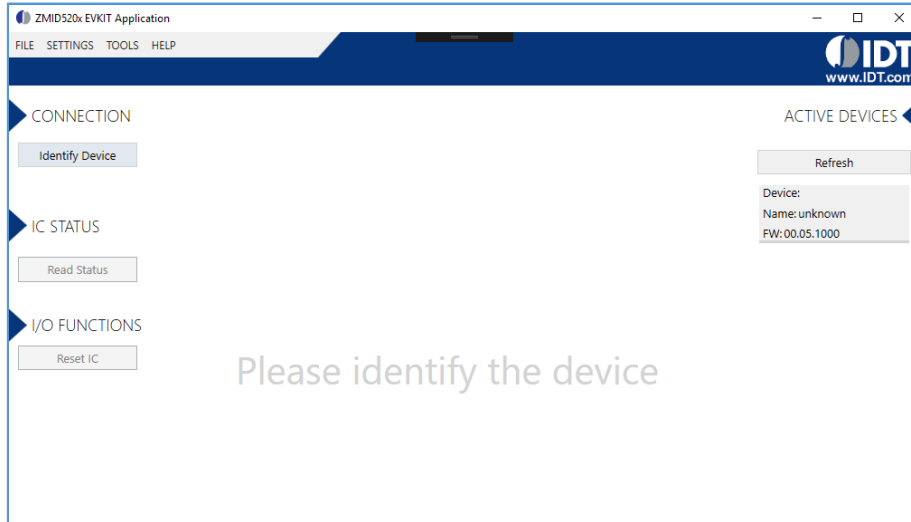
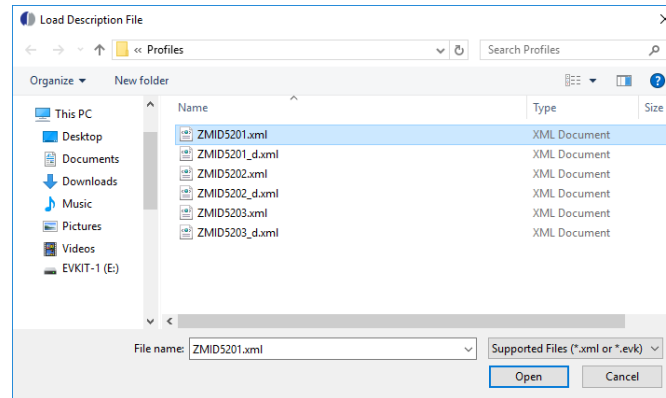

**Figure 45. GUI View if an Unknown Device is Selected**

Follow these steps to identify an unknown device:

1. Select the device by clicking on it in the “ACTIVE DEVICES” section.
2. Click on the “Identify Device” button in the “CONNECTION” section.

3. In the resulting common file dialog, select the proper identification file based on the type of ZMID4200 Application Module, and click “Open.” The identification files can be found in the root directory in the *Profiles* folder (see Figure 46). Filenames with the suffix “\_d” are used if two application modules are connected.
4. The GUI will identify the device and automatically connect to it.



**Figure 46. File Dialog to Select an Identification File**

### 3. Firmware Update

This section provides optional instructions for upgrading the firmware for the ZMID-COMBOARD if needed for special uses of the kit that might require additional features in the latest version of the firmware. Normally this is not needed since all versions of the firmware function properly with the GUI and hardware. To determine the existing version of the firmware on the board, see the “FW” version shown in the “ACTIVE DEVICES” section at the right of the display (see Figure 9).



**Important Equipment Warning:** Ensure the correct connection of all cables. Supplying the board using the wrong polarity could result in damage to the board and/or the equipment.

To perform a firmware update of the ZMID-COMBOARD, complete these steps:

1. Download the latest firmware file from the Renesas website.
2. Disconnect the ZMID-COMBOARD from the USB port of the computer.
3. Install a jumper to short the two “**BOOT**” pins on the ZMID-COMBOARD as shown in Figure 3.
4. Connect the ZMID-COMBOARD to the USB port of the computer.
5. The ZMID-COMBOARD will show up as a removable drive named “**CRP DISABLD.**” Open the drive to browse the files.



**Figure 43. Locating the Removable Device**

6. Delete the “**firmware.bin**” file from the device. Recommendation: Store a copy of the file on the user’s computer as a backup.
7. Copy the new firmware file to the device.
8. Disconnect the board from the USB port of the computer.
9. Remove the jumper from the “**BOOT**” pins.

To verify the firmware update, install a ZMID4200 Application Module and connect to the computer. The GUI will now display the new version of the firmware on the board information in the “ACTIVE DEVICES” section.

# 4. ZMID-COMBOARD Schematics

Signals Multiplexing Circuit

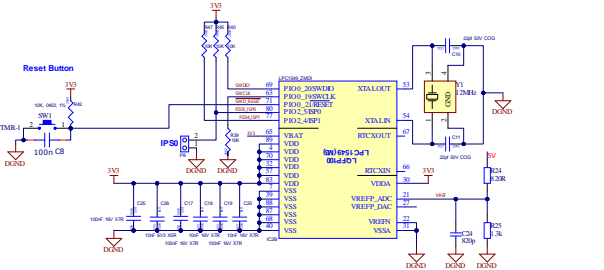
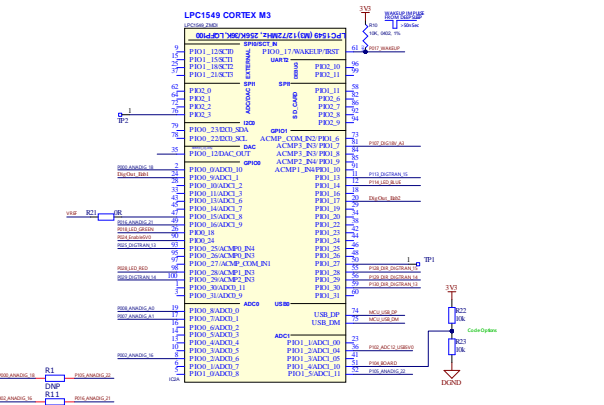
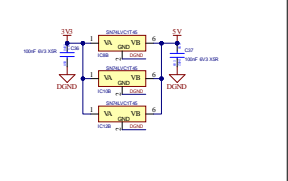
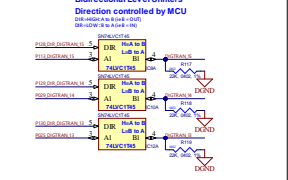
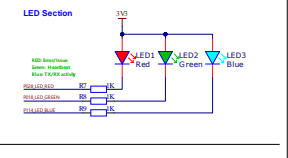
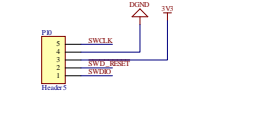
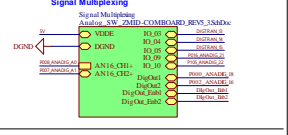
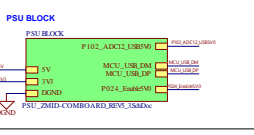
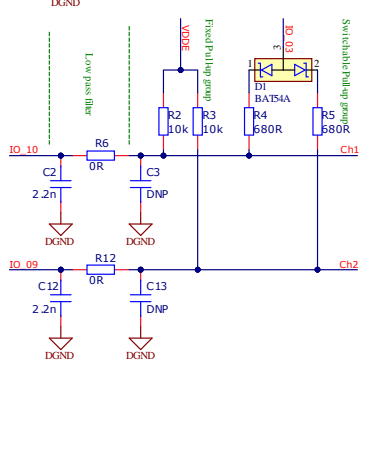
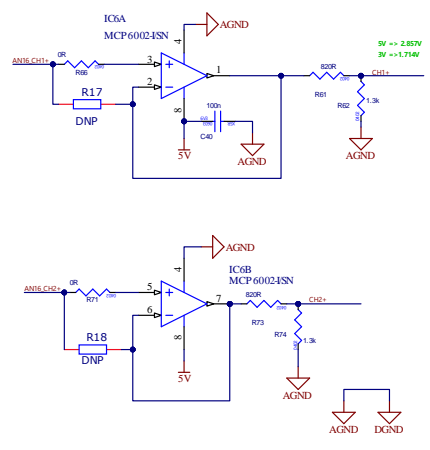
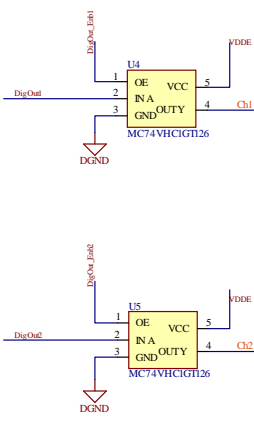
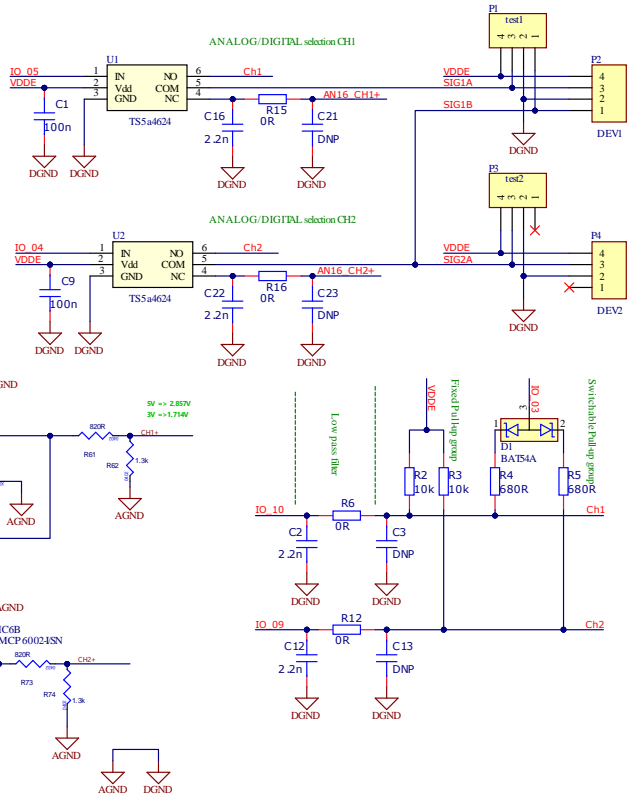
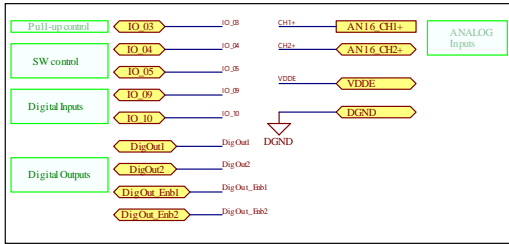



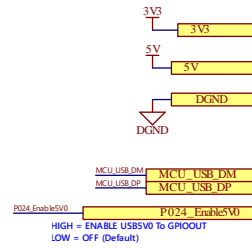
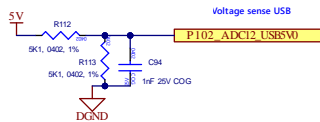
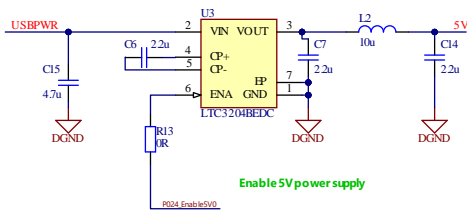
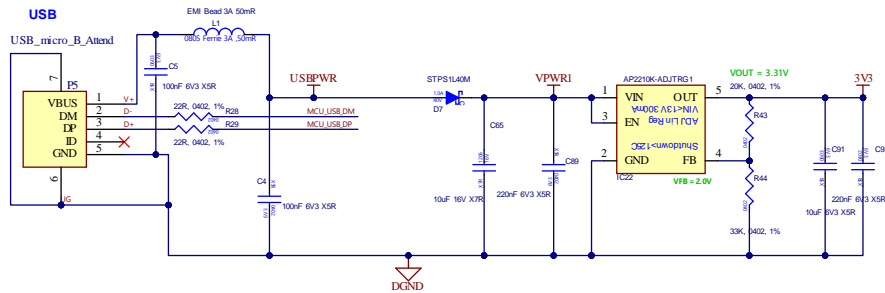

Changes in REV5.3:  
-Replaced charge pump TP560150DRR with LTC3204BDEDC

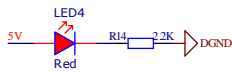

## 5. ZMID-COMBOARD BOM

Table 3. Bill of Materials for ZMID-COMBOARD Rev. 5.1

Note: DNP = Do not populate.

Item	Designator	Value	Description	Footprint	Qty.
1	C1, C4, C5, C8, C9, C17, C19, C40, C36, C37, C25	100nF	100nF 16V X7R +-10%	0603	11
2	C2, C3, C12, C13, C16, C21, C22, C23	2.2nF	2.2nF 50V X7R +-10%	0603	8
3	C6, C7, C14	2.2μF	2.2uF 16V X7R +-10%	0805	3
4	C10, C11	22pF	22pF 50V C0G +-5%	0603	2
5	C15	4.7μF	4.7uF 25V X5R +-10%	0805	1
6	C18, C20, C26	10nF	10nF 50V X7R +-10%	0603	3
7	C24	820pF	820pF 50V C0G +-5%	0603	1
8	C65	10μF	10uF 25V X7R +-10%	1206	1
9	C89, C93	220nF	220nF 16V X7R +-10%	0603	2
10	C91	10μF	10uF 16V X5R +-10%	0805	1
11	C94	1nF	1.0nF 50V C0G +-5%	0603	1
12	D1	BAT54A	Schottky 30V 2x200mA 5ns 10pF, konf A	SOT23	1

Item	Designator	Value	Description	Footprint	Qty.
13	D7	STPS1L40M	STMICROELECTRONICS - Schottky Rectifier, 40 V, 1 A, Single, DO-216AA, 2 Pins, 460 mV	DO216AA	1
14	IC2	LPC1549	NXP - ARM Microcontroller, LPC1500 ARM Cortex-M3 Microcontrollers, 32bit, 72 MHz, 256 KB, 36 KB, 100 Pins	LQFP-100	1
15	IC6	MCP6002-I/SN	2 OA,4.5mV,1pA,1.8-6V,100uA,1MHz	SOIC-8	1
16	IC8, IC10, IC12	SN74LVC1T45	Dual Supply Translating Transceiver 3-State	SC70	3
17	IC22	<a href="#">XC6204B332MR</a>	LDO Voltage Regulators 300mA CMOS LDO 2.5V to 13.2V	SOT23-5	1
18	L1	EMI Bead 3A 50mR	Ferrite bead 0805, typ. 30Ohm@100MHz, 15mOhm@3.0A	0805	1
19	L2	10µH	inductor 10uH 60mA 0.5ohm 30%	0805	1
20	LED1, LED4	Red LED	2.0x1.25mm 150mcd/20mA 625nm Red 120°	0805	2
21	LED2	Green LED	2.0x1.25mm, 3.2-15mcd@20mA, 568nm Green, W.Clear, 120°	0805	1
22	LED3	Blue LED	2.0x1.25mm, 36-100mcd@20mA, 470nm Blue, W.Clear, 120°	0805	1
23	P1, P3	Header 1X4	Header, contact height 6.0mm, 1x4, straight PCB TH, P2.54mm	HS1X4M	2
24	P2, P4	DEV1, DEV2	Wire-To-Board Connector, 1.27 mm, 4 Contacts, Header, Picoflex 90325 Series, Through Hole, 1 Rows	molex 4pin	2
25	P5	USB_micro_B_Attend	MICRO USB 2.0; B-Type Receptacle; Right Angle; Shell DIP/Tail SMD	USB_micro_B_SMD	1
26	P8	Header 1X2	Header, contact height 6.0mm, 1x2, straight PCB TH, P2.54mm	HS1X2M	1
27	R1, R11	100Ω	RES SMD 0603 1% 200ppm 100R 1/10W	0603	2
28	R2, R3, R10, R39, R40, R42, R45, R47, R22, R23	10kΩ	RES SMD 0603 1% 100ppm 10K 1/10W	0603	10
29	R4, R5	680Ω	RES SMD 0603 1% 100ppm 680R 1/10W	0603	2
30	R15, R16	510Ω	RES SMD 0603 1% 100ppm 510R 1/10W	0603	2
31	R7, R8, R9,	1kΩ	RES SMD 0603 1% 100ppm 1.0K 1/10W	0603	3
32	R14	2.2kΩ	RES SMD 0603 1% 100ppm 2.2K 1/10W	0603	1
33	R24,R61,R73	820Ω	RES SMD 0603 1% 100ppm 820R 1/10W	0603	3
34	R25,R62,R74	1.3kΩ	RES SMD 0603 1% 100ppm 1.3K 1/10W	0603	3
35	R17, R18	DNP		0603	2
36	R28, R29	22Ω	RES SMD 0603 1% 200ppm 22R 1/10W	0603	2
37	R43	DNP			1
38	R44	DNP			1
39	R112, R113	5.1kΩ	RES SMD 0603 1% 100ppm 5.1K 1/10W	0603	4
40	R64, R65, R67	51kΩ	RES SMD 0603 1% 100ppm 51K 1/10W	0603	3
41	R66, R71, R21, R13, R6, R12	0Ω	RES SMD 0603 JUMPER MAX 50mOhm	0603	6
42	R117, R118, R119	22kΩ	RES SMD 0603 1% 100ppm 22K 1/10W	0603	3
43	RESET	DTSM-31Y	Tact sw. 2p SPST Mom. 50mA/12V 3.5x6mm SMD	3.5x6mm SMD	1
44	U1, U2	TS5a4624	Analog Switch, SPDT, 1 Channels, 0.7 ohm, 1.65V to 5.5V, SC-70, 6 Pins	SC-70	2
45	U3	TPS60150DRVR	5 V, Step-Up Charge Pump Regulator	WSON-6	1
46	Y1	12MHz QKT-3225	crystal Fund 12.000 MHz 3.2x2.5mm SMD (DFN) 15ppm 8pF -20+70°C	SMD-3.2X2.5	1

## 6. Sensors Boards

Refer to the <http://www.renesas.com/ZMID4200stkit> Renesas product web page for ZMID4200 Application Module manuals for a complete description of the following sensors boards:

- ZMID4200 Linear Application Module
- ZMID4200 Rotary 360° Application Module
- ZMID4200 Arc 130° Application Module

## 7. Glossary

Term	Definition
ADC	Analog-to-Digital Converter
AGC	Automatic Gain Control
CSV	Comma Separated Values – a file format that can be imported in spreadsheets.
EEPROM	Electrically Erasable Programmable Read-Only Memory – the storage memory of the ZMID4200 IC
EVK	Evaluation Kit
GUI	Graphical User Interface – refers to the application used for communication with the kit
OWI	One-Wire Interface
PWM	Pulse Width Modulation
SENT	Single Edge Nibble Transmission
SWR	Shadow Register – used as working memory for the ZMID4200 IC.
USB	Universal Serial Bus

## 8. Ordering Information

Refer to the product pages for the specific ZMID4200 Application Module for the order codes for the module.

Part Number	Description
ZMID-COMBOARD	ZMID-COMBOARD, micro-USB cable

## 9. Revision History

Revision	Date	Description
1.0	Aug 9, 2021!	Initial release.

## Notice

1. Descriptions of circuits, software and other related information in this document are provided only to illustrate the operation of semiconductor products and application examples. You are fully responsible for the incorporation or any other use of the circuits, software, and information in the design of your product or system. Renesas Electronics disclaims any and all liability for any losses and damages incurred by you or third parties arising from the use of these circuits, software, or information.
2. Renesas Electronics hereby expressly disclaims any warranties against and liability for infringement or any other claims involving patents, copyrights, or other intellectual property rights of third parties, by or arising from the use of Renesas Electronics products or technical information described in this document, including but not limited to, the product data, drawings, charts, programs, algorithms, and application examples.
3. No license, express, implied or otherwise, is granted hereby under any patents, copyrights or other intellectual property rights of Renesas Electronics or others.
4. You shall be responsible for determining what licenses are required from any third parties, and obtaining such licenses for the lawful import, export, manufacture, sales, utilization, distribution or other disposal of any products incorporating Renesas Electronics products, if required.
5. You shall not alter, modify, copy, or reverse engineer any Renesas Electronics product, whether in whole or in part. Renesas Electronics disclaims any and all liability for any losses or damages incurred by you or third parties arising from such alteration, modification, copying or reverse engineering.
6. Renesas Electronics products are classified according to the following two quality grades: "Standard" and "High Quality". The intended applications for each Renesas Electronics product depends on the product's quality grade, as indicated below.

"Standard": Computers; office equipment; communications equipment; test and measurement equipment; audio and visual equipment; home electronic appliances; machine tools; personal electronic equipment; industrial robots; etc.

"High Quality": Transportation equipment (automobiles, trains, ships, etc.); traffic control (traffic lights); large-scale communication equipment; key financial terminal systems; safety control equipment; etc.

Unless expressly designated as a high reliability product or a product for harsh environments in a Renesas Electronics data sheet or other Renesas Electronics document, Renesas Electronics products are not intended or authorized for use in products or systems that may pose a direct threat to human life or bodily injury (artificial life support devices or systems; surgical implantations; etc.), or may cause serious property damage (space system; undersea repeaters; nuclear power control systems; aircraft control systems; key plant systems; military equipment; etc.). Renesas Electronics disclaims any and all liability for any damages or losses incurred by you or any third parties arising from the use of any Renesas Electronics product that is inconsistent with any Renesas Electronics data sheet, user's manual or other Renesas Electronics document.
7. No semiconductor product is absolutely secure. Notwithstanding any security measures or features that may be implemented in Renesas Electronics hardware or software products, Renesas Electronics shall have absolutely no liability arising out of any vulnerability or security breach, including but not limited to any unauthorized access to or use of a Renesas Electronics product or a system that uses a Renesas Electronics product. RENESAS ELECTRONICS DOES NOT WARRANT OR GUARANTEE THAT RENESAS ELECTRONICS PRODUCTS, OR ANY SYSTEMS CREATED USING RENESAS ELECTRONICS PRODUCTS WILL BE INVULNERABLE OR FREE FROM CORRUPTION, ATTACK, VIRUSES, INTERFERENCE, HACKING, DATA LOSS OR THEFT, OR OTHER SECURITY INTRUSION ("Vulnerability Issues"). RENESAS ELECTRONICS DISCLAIMS ANY AND ALL RESPONSIBILITY OR LIABILITY ARISING FROM OR RELATED TO ANY VULNERABILITY ISSUES. FURTHERMORE, TO THE EXTENT PERMITTED BY APPLICABLE LAW, RENESAS ELECTRONICS DISCLAIMS ANY AND ALL WARRANTIES, EXPRESS OR IMPLIED, WITH RESPECT TO THIS DOCUMENT AND ANY RELATED OR ACCOMPANYING SOFTWARE OR HARDWARE, INCLUDING BUT NOT LIMITED TO THE IMPLIED WARRANTIES OF MERCHANTABILITY, OR FITNESS FOR A PARTICULAR PURPOSE.
8. When using Renesas Electronics products, refer to the latest product information (data sheets, user's manuals, application notes, "General Notes for Handling and Using Semiconductor Devices" in the reliability handbook, etc.), and ensure that usage conditions are within the ranges specified by Renesas Electronics with respect to maximum ratings, operating power supply voltage range, heat dissipation characteristics, installation, etc. Renesas Electronics disclaims any and all liability for any malfunctions, failure or accident arising out of the use of Renesas Electronics products outside of such specified ranges.
9. Although Renesas Electronics endeavors to improve the quality and reliability of Renesas Electronics products, semiconductor products have specific characteristics, such as the occurrence of failure at a certain rate and malfunctions under certain use conditions. Unless designated as a high reliability product or a product for harsh environments in a Renesas Electronics data sheet or other Renesas Electronics document, Renesas Electronics products are not subject to radiation resistance design. You are responsible for implementing safety measures to guard against the possibility of bodily injury, injury or damage caused by fire, and/or danger to the public in the event of a failure or malfunction of Renesas Electronics products, such as safety design for hardware and software, including but not limited to redundancy, fire control and malfunction prevention, appropriate treatment for aging degradation or any other appropriate measures. Because the evaluation of microcomputer software alone is very difficult and impractical, you are responsible for evaluating the safety of the final products or systems manufactured by you.
10. Please contact a Renesas Electronics sales office for details as to environmental matters such as the environmental compatibility of each Renesas Electronics product. You are responsible for carefully and sufficiently investigating applicable laws and regulations that regulate the inclusion or use of controlled substances, including without limitation, the EU RoHS Directive, and using Renesas Electronics products in compliance with all these applicable laws and regulations. Renesas Electronics disclaims any and all liability for damages or losses occurring as a result of your noncompliance with applicable laws and regulations.
11. Renesas Electronics products and technologies shall not be used for or incorporated into any products or systems whose manufacture, use, or sale is prohibited under any applicable domestic or foreign laws or regulations. You shall comply with any applicable export control laws and regulations promulgated and administered by the governments of any countries asserting jurisdiction over the parties or transactions.
12. It is the responsibility of the buyer or distributor of Renesas Electronics products, or any other party who distributes, disposes of, or otherwise sells or transfers the product to a third party, to notify such third party in advance of the contents and conditions set forth in this document.
13. This document shall not be reprinted, reproduced or duplicated in any form, in whole or in part, without prior written consent of Renesas Electronics.
14. Please contact a Renesas Electronics sales office if you have any questions regarding the information contained in this document or Renesas Electronics products.

(Note1) "Renesas Electronics" as used in this document means Renesas Electronics Corporation and also includes its directly or indirectly controlled subsidiaries.

(Note2) "Renesas Electronics product(s)" means any product developed or manufactured by or for Renesas Electronics.

(Disclaimer Rev.5.0-1)

## Corporate Headquarters

TOYOSU FORESIA, 3-2-24 Toyosu,  
Koto-ku, Tokyo 135-0061, Japan  
[www.renesas.com](http://www.renesas.com)

## Trademarks

Renesas and the Renesas logo are trademarks of Renesas Electronics Corporation. All trademarks and registered trademarks are the property of their respective owners.

## Contact Information

For further information on a product, technology, the most up-to-date version of a document, or your nearest sales office, please visit:  
[www.renesas.com/contact/](http://www.renesas.com/contact/)